

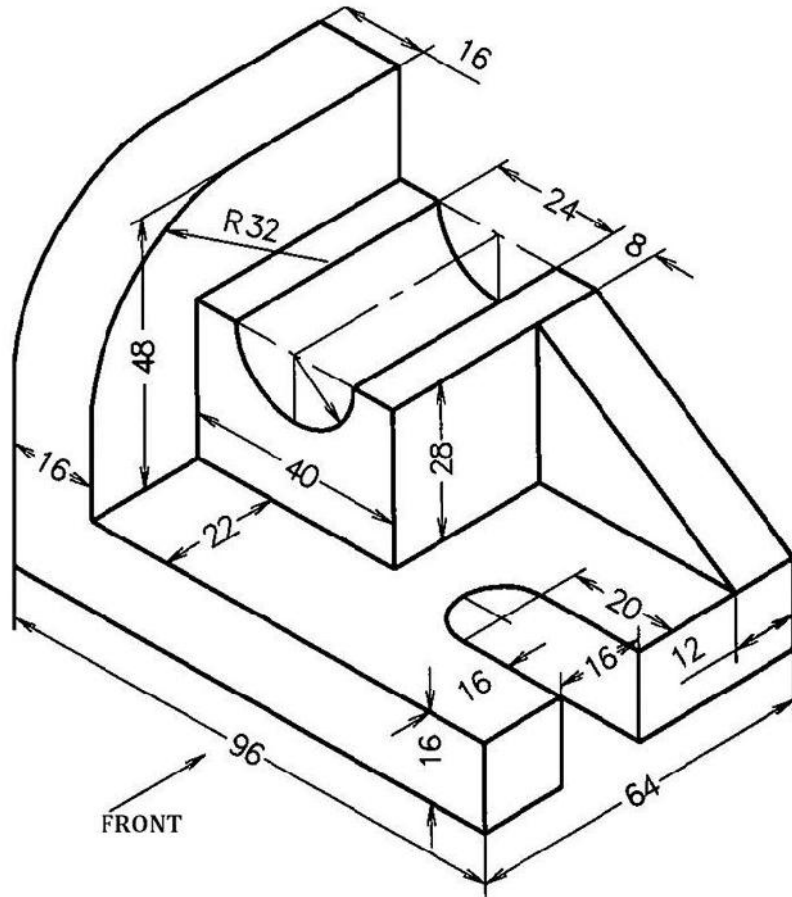

2

1



μ .

μ

:

- a)
- b)
- c)

sketch

(extrude)

2

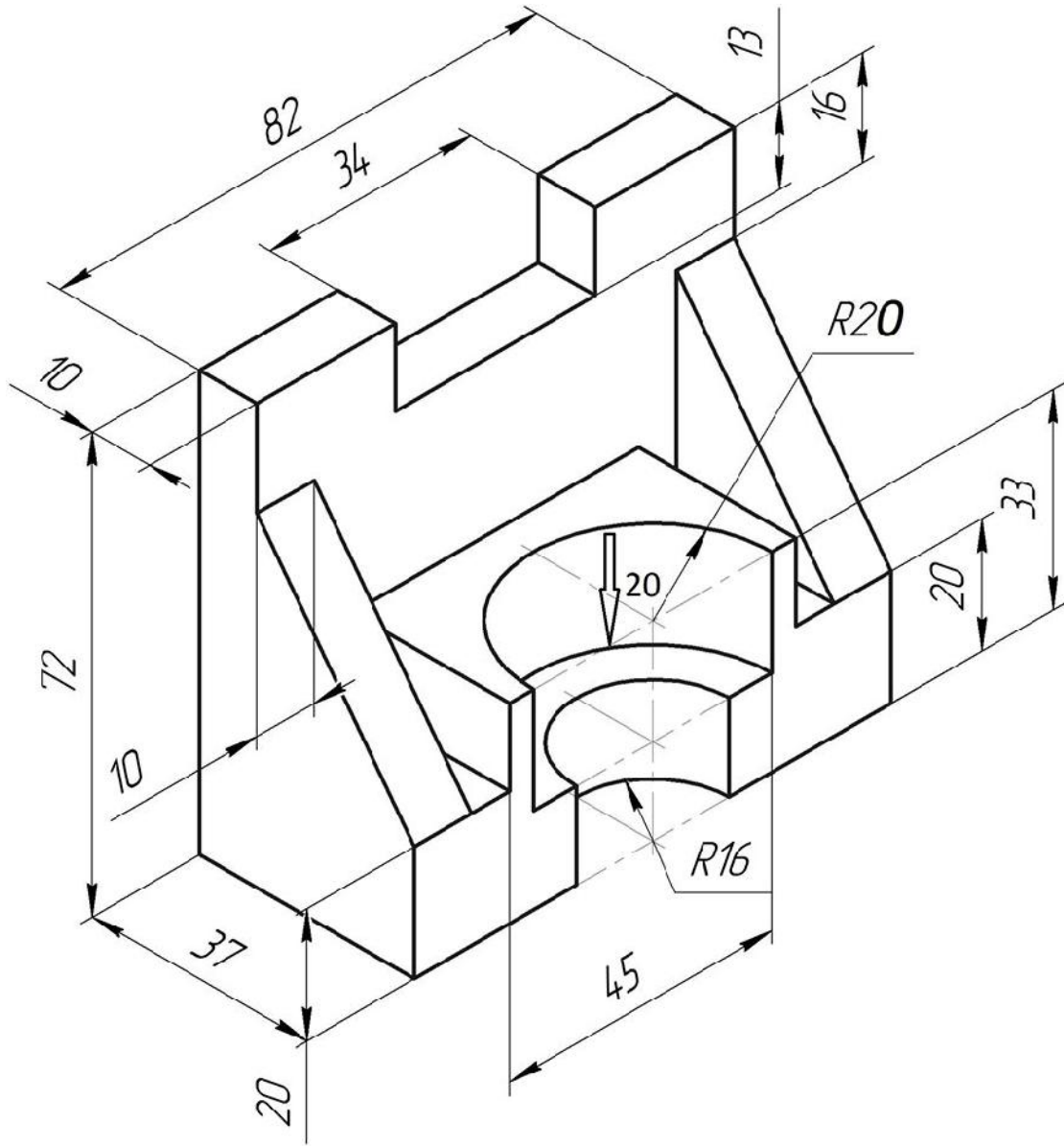

μ .

μ

:

- a)
- b)
- c)

sketch

(extrude)