

CLT Handbook

CROSS-LAMINATED TIMBER

U.S.  EDITION

© 2013 FPInnovations and Binational Softwood Lumber Council. All rights reserved.

The U.S. Edition of the CLT Handbook: cross-laminated timber can be electronically downloaded without charge from the website www.masstimber.com. Additional information can be obtained by visiting the websites of FPInnovations, USFPL, American Wood Council (AWC), APA and U.S. WoodWorks. Hard copies can be obtained through AWC (www.awc.org).

No part of this published Work may be reproduced, published, or transmitted for commercial purposes, in any form or by any means, electronic, mechanical, photocopying, recording or otherwise, whether or not in translated form, without the prior written permission of FPInnovations and Binational Softwood Lumber Council.

The information contained in this Work represents current research results and technical information made available from many sources, including researchers, manufacturers, and design professionals. The information has been reviewed by professionals in wood design including professors, design engineers and architects, and wood product manufacturers. While every reasonable effort has been made to insure the accuracy of the information presented, and special effort has been made to assure that the information reflects the state-of-the-art, none of the above-mentioned parties make any warranty, expressed or implied, or assume any legal liability or responsibility for the use, application of, and/or reference to opinions, findings, conclusions, or recommendations included in this published work, nor assume any responsibility for the accuracy or completeness of the information or its fitness for any particular purpose.

This published Work is designed to provide accurate, authoritative information but is not intended to provide professional advice. It is the responsibility of users to exercise professional knowledge and judgment in the use of the information.

FC Handbook

CROSS-LAMINATED TIMBER

U.S.  EDITION

Edited by
Erol Karacabeyli, P.Eng., FPInnovations
Brad Douglas, P.E., AWC

FPInnovations
Pointe-Claire, QC
Special Publication SP-529E

2013



Forest Products Laboratory



WoodWorks



Funding for this publication was provided by



Publication

FPInnovations
570 boul. St. Jean
Pointe-Claire (QC)
H9R 3J9
www.fpinnovations.ca

Distribution of hard copies

AWC
222 Catocin Circle SE
Suite 201
Leesburg, VA 20175
www.awc.org

Library and Archives Canada Cataloguing in Publication

CLT handbook : cross-laminated timber / edited by Erol Karacabeyli, Brad Douglas. -- U.S. ed.

(Special publication, ISSN 1925-0495 ; SP-529E)

Co-published by U.S. Department of Agriculture, Forest Service, Forest Products Laboratory, Binational Softwood Lumber Council (BSLC).

Includes bibliographical references.

Issued also in electronic format.

ISBN 978-0-86488-553-1

1. Laminated wood. 2. Laminated wood construction. 3. Engineered wood construction. 4. Laminated wood--Standards. 5. Laminated wood--Handbooks, manuals, etc. I. Karacabeyli, Erol, 1954- II. Douglas, Brad, 1960- III. Forest Products Laboratory (U.S.) IV. FPInnovations (Institute) V. Binational Softwood Lumber Council VI. Title: Cross-laminated timber. VII. Series: Special publication (FPInnovations (Institute)) ; SP-529E

TA666.C57 2013

624.1'84

C2012-908154-X

Library and Archives Canada Cataloguing in Publication

CLT handbook [electronic resource] : cross-laminated timber / edited by Erol Karacabeyli, Brad Douglas. -- U.S. ed.

(Special publication, ISSN 1925-0509 ; SP-529E)

Co-published by U.S. Department of Agriculture, Forest Service, Forest Products Laboratory, Binational Softwood Lumber Council (BSLC).

Includes bibliographical references.

Electronic monograph in PDF format.

Issued also in print format.

ISBN 978-0-86488-554-8

1. Laminated wood. 2. Laminated wood construction. 3. Engineered wood construction. 4. Laminated wood--Standards. 5. Laminated wood--Handbooks, manuals, etc. I. Karacabeyli, Erol, 1954- II. Douglas, Brad, 1960- III. Forest Products Laboratory (U.S.) IV. FPInnovations (Institute) V. Binational Softwood Lumber Council VI. Title: Cross-laminated timber. VII. Series: Special publication (FPInnovations (Institute)) ; SP-529E

TA666.C57 2013

624.1'84

C2012-908155-8

PREFACE

Expansion into mid-rise, high-rise and non-residential applications presents one of the most promising avenues for the North American wood industry to diversify its end use markets. This may be achieved by:

- Designing to new building heights with **Light Frame Wood Construction**
- Revival of **Heavy Timber Frame Construction**
- Adoption of **Cross-laminated Timber (CLT)**
- Facilitating **Hybrid Construction**

There are concerted efforts both in Canada and in the United States towards realizing that goal. In fact, the Canadian provinces of British Columbia and Quebec went even further and created specific initiatives to support the use of wood in those applications.

This Handbook is focused on one of these options – adoption of cross-laminated timber (CLT). CLT is an innovative wood product that was introduced in the early 1990s in Austria and Germany and has been gaining popularity in residential and non-residential applications in Europe. The Research and Standards Subcommittee of the industry’s CLT Steering Committee identified CLT as a great addition to the “**wood product toolbox**” and expects CLT to enhance the re-introduction of wood-based systems in applications such as 5- to 10-story buildings where heavy timber systems were used a century ago. Several manufacturers have started to produce CLT in North America, and their products have already been used in the construction of a number of buildings.

CLT, like other structural wood-based products, lends itself well to prefabrication, resulting in very rapid construction, and dismantling at the end of its service life. The added benefit of being made from a renewable resource makes all wood-based systems desirable from a sustainability point of view.

In Canada, in order to facilitate the adoption of CLT, FPInnovations published the Canadian edition of the CLT Handbook in 2011 under the Transformative Technologies Program of Natural Resources Canada. The broad acceptance of the Canadian CLT Handbook in Canada encouraged this project, to develop a U.S. Edition of the CLT Handbook. Funding for this project was received from the Binational Softwood Lumber Council, Forestry Innovation Investment in British Columbia, and three CLT manufacturers, and was spearheaded by a Working Group from FPInnovations, the American Wood Council (AWC), the U.S. Forest Products Laboratory, APA-The Engineered Wood Association and U.S. WoodWorks. The U.S. CLT Handbook was developed by a team of over 40 experts from all over the world.

Both CLT handbooks serve two objectives:

- Provide immediate support for the design and construction of CLT systems under the alternative or innovative solutions path in design standards and building codes;
- Provide technical information that can be used for implementation of CLT systems as acceptable solutions in building codes and design standards to achieve broader acceptance.

The implementation of CLT in North America marks a new opportunity for cross-border cooperation, as five organizations worked together with the design and construction community, industry, universities, and regulatory officials in the development of this Handbook. This multi-disciplinary, peer-reviewed CLT Handbook is designed to facilitate the adoption of an innovative wood product to enhance the selection of wood-based solutions in non-residential and multi-storey construction.

Credible design teams in different parts of the world are advocating for larger and taller wood structures, as high as 30 stories. When asked, they identified the technical information compiled in this Handbook as what was needed for those applications.

A Renaissance in wood construction is underway; stay connected.

ACKNOWLEDGEMENTS

The great challenge with this U.S. Edition of the CLT Handbook was to gather experts from the United States, Canada and Europe to bring together their expertise and knowledge into a state-of-the-art reference document. The realization of this Handbook was made possible with the contribution of many people and numerous national and international organizations.

Such a piece of work would not be possible without the support from financing partners and, as such, we would like to express our special thanks to Binational Softwood Lumber Council, Forestry Innovation Investment (FII), Nordic Engineered Wood, Structurlam, and CLT Canada for their financial contribution to this project.

First and most of all, we would like to express our gratitude to AWC, APA, USFPL, FPIInnovations, U.S. WoodWorks and their staff for providing the effort and expertise needed to prepare this work. We would also like to express our special thanks to all chapter authors, co-authors, and reviewers who shared their precious time and expertise in improving this manual.

Our very special thanks go to Loren Ross at AWC and Sylvain Gagnon at FPIInnovations for their work as project leaders and for their special efforts in gathering the expertise of everyone into a unique document. Special thanks also go to the Working Group, Dr. Borjen Yeh from APA, Dave Kretschmann from the U.S. Forest Products Laboratory, and Lisa Podesto from U.S. WoodWorks. Thanks also to Madeline Leroux for her work on the drawings, Odile Fleury for her help with bibliographic references, and Marie-Claude Thibault for her support in editing and coordination work.

Erol Karacabeyli, P.Eng. and Brad Douglas, P.E.

Co-editors

CLT Handbook, U.S. Edition

CONTENTS

CHAPTER 1

Introduction
to cross-laminated timber

CHAPTER 2

Cross-laminated
timber manufacturing

CHAPTER 3

Structural design of
cross-laminated timber elements

CHAPTER 4

Lateral design of
cross-laminated timber buildings

CHAPTER 5

Connections in
cross-laminated timber buildings

CHAPTER 6

Duration of load and creep factors
for cross-laminated timber panels

CHAPTER 7

Vibration performance of
cross-laminated timber floors

CHAPTER 8

Fire performance of
cross-laminated timber assemblies

CHAPTER 9

Sound insulation of
cross-laminated timber assemblies

CHAPTER 10

Building enclosure design for
cross-laminated timber construction

CHAPTER 11

Environmental performance
of cross-laminated timber

CHAPTER 12

Lifting and handling of
cross-laminated timber elements

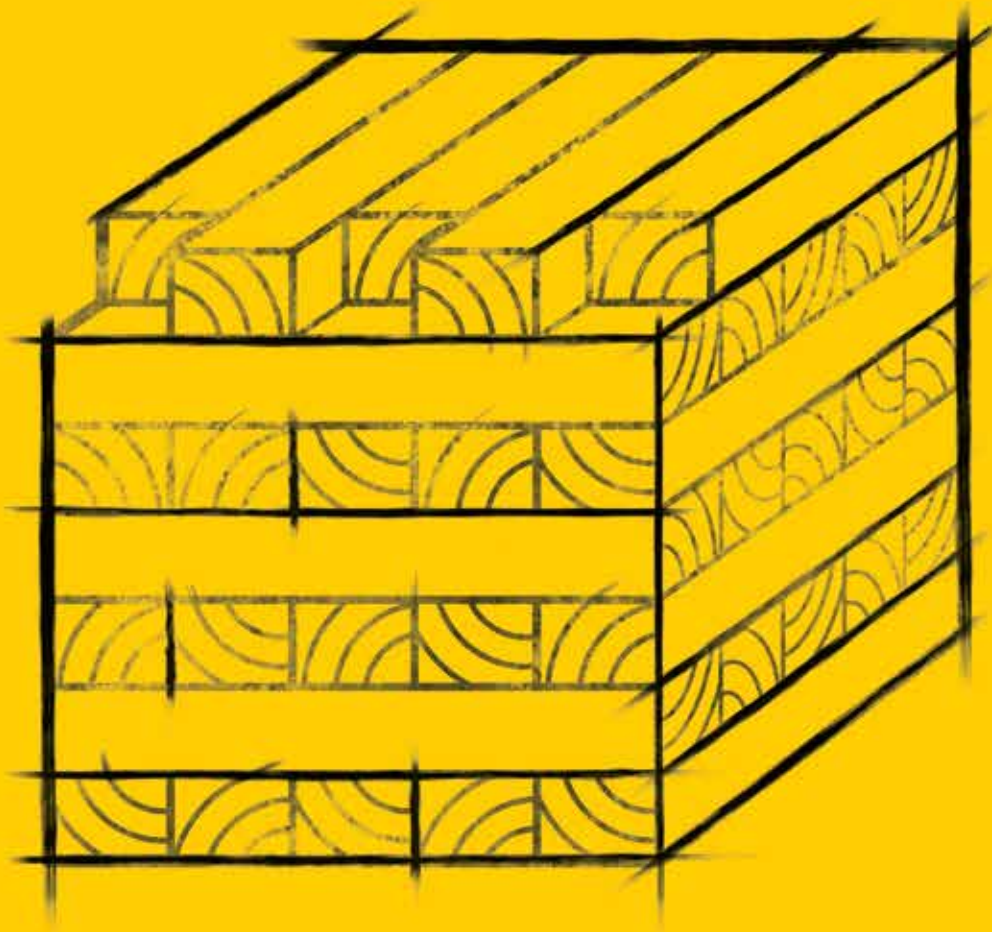

CLT

Introduction to cross-laminated timber

CHAPTER 1

Authors

Sylvain Gagnon, Eng., FPInnovations
E.M. (Ted) Bilek, Ph.D., USDA Forest Products Laboratory
Lisa Podesto, M.S., P.E., WoodWorks
Pablo Crespell, Ph.D., FPInnovations

ACKNOWLEDGEMENTS

The U.S. Edition of the CLT Handbook: *cross-laminated timber* combines the work and knowledge of American, Canadian and European specialists. The handbook is based on the original Canadian Edition of the CLT Handbook: *cross-laminated timber*, that was developed using a series of reports initially prepared by FPInnovations and collaborators to support the introduction of CLT in the North American market. A multi-disciplinary team revised, updated and implemented their know-how and technologies to adapt this document to U.S. standards.

The publication of this handbook was made possible with the special collaboration of the following partners:



The editing partners would also like to express their special thanks to Binational Softwood Lumber Council, Forestry Innovation Investment (FII), Nordic Engineered Wood, Structurlam, and CLT Canada for their financial contribution to studies in support of the introduction of cross-laminated timber products in the United States of America.



© 2013 FPInnovations and Binational Softwood Lumber Council. All rights reserved.

The U.S. Edition of the CLT Handbook: *cross-laminated timber* can be electronically downloaded without charge from the website www.masstimber.com. Additional information can be obtained by visiting the websites of FPInnovations, USFPL, American Wood Council (AWC), APA and U.S. WoodWorks. Hard copies can be obtained through AWC (www.awc.org).

No part of this published Work may be reproduced, published, or transmitted for commercial purposes, in any form or by any means, electronic, mechanical, photocopying, recording or otherwise, whether or not in translated form, without the prior written permission of FPInnovations and Binational Softwood Lumber Council.

The information contained in this Work represents current research results and technical information made available from many sources, including researchers, manufacturers, and design professionals. The information has been reviewed by professionals in wood design including professors, design engineers and architects, and wood product manufacturers. While every reasonable effort has been made to insure the accuracy of the information presented, and special effort has been made to assure that the information reflects the state-of-the-art, none of the above-mentioned parties make any warranty, expressed or implied, or assume any legal liability or responsibility for the use, application of, and/or reference to opinions, findings, conclusions, or recommendations included in this published work, nor assume any responsibility for the accuracy or completeness of the information or its fitness for any particular purpose.

This published Work is designed to provide accurate, authoritative information but is not intended to provide professional advice. It is the responsibility of users to exercise professional knowledge and judgment in the use of the information.

ABSTRACT

Cross-laminated timber (CLT), a new generation of engineered wood product developed initially in Europe, has been gaining increased popularity in residential and non-residential applications in several countries. Many impressive low- and mid-rise buildings built around the world using CLT showcase the many advantages this product has to offer to the construction sector.

In this Chapter, we put forward an introduction to CLT as a product and CLT construction in general, along with different examples of buildings and other types of structures made with CLT panels. CLT is now available in North America and several projects already built in Canada and the United States, using CLT, are presented in this Chapter. An assessment of market opportunity for CLT based on the latest construction statistics for the United States is also presented.

GENERAL NOTE: The information contained in this Handbook represents current research results and technical information made available from many sources, including researchers, manufacturers, and design professionals. The information has been reviewed by wood design professionals including professors, design engineers and architects, and wood product manufacturers. While every reasonable effort has been made to ensure the accuracy of the information presented, and special effort has been made to assure that the information reflects state of the art, neither of the participating parties assume any responsibility for the accuracy or completeness of the information or its fitness for any particular purpose. It is the responsibility of users to exercise professional knowledge and judgment in the use of the information.

TABLE OF CONTENTS

Acknowledgements	ii
Abstract	iii
List of Tables	vi
List of Figures	vi
1	Brief History 1
2	Development of CLT in North America 2
3	Definition of Cross-laminated Timber (CLT) 3
4	Key Advantages of Cross-laminating 6
5	Manufacturing Process 9
6	Structural Design and Serviceability Considerations of CLT 12
6.1	Proposed Analytical Design Methods 13
6.2	Lateral Design of CLT Buildings 13
6.3	Connections and Construction of CLT Structures 15
6.4	Duration of Load and Creep Behavior 16
6.5	Vibration Performance of Floors 16
6.6	Fire Performance of Cross-laminated Timber Assemblies 16
6.7	Sound Insulation of Cross-laminated Timber Buildings 17
6.8	Building Enclosure Design of Cross-laminated Timber Construction 18
7	Environmental Performance of CLT 19
8	CLT in Construction 20
8.1	Considerations for Transportation and Construction Site Limitations 20
8.2	Materials on the Construction Site 20
8.3	Lifting and Handling of CLT Elements 22
8.4	Construction Accessories and Materials 22

9	Assessment of Market Opportunity	23
9.1	Methodology	23
9.1.1	CLT Assembly Costs	23
9.1.2	Construction Statistics	23
9.1.3	Sample Selection	23
9.1.4	Shell Unit Costs and Competitiveness	24
9.1.5	CLT Assembly Costs	24
9.2	Results	25
9.2.1	Shell Cost Competitiveness	25
9.2.2	Assessment of Demand	25
10	Building Examples	28
10.1	Residential Buildings	28
10.2	Office and Commercial Buildings	38
10.3	Hybrid Structures	44

List of Tables

Table 1 Market opportunity (2015) 26

List of Figures

- Figure 1* CLT panel configuration 4
- Figure 2* Examples of CLT panel cross-sections 4
- Figure 3* Example of CLT panel cross-sections and direction of fibers of the top layers 5
- Figure 4* CLT vs. glulam panel 6
- Figure 5* (a) Floor assembly made of four 3-ply CLT panels acting in one direction and (b) Floor assembly made of one 3-ply CLT panel acting in both directions. Distance “a” may reach 10 ft. (3 m) 7-8
- Figure 6* CLT wall 10
- Figure 7* CLT floor or roof 11
- Figure 8* Seven-story CLT building tested at E-Defense Laboratory in Miki as a part of the SOFIE Project and CLT test assembly at FPInnovations 14
- Figure 9* CLT test assembly at FPInnovations 15
- Figure 10* Storage on construction site – individually wrapped bundles stacked on lumber skids 21
- Figure 11* Truck platforms left on construction site – will be recovered on the next trip 21
- Figure 12* Lifting and handling of CLT elements by cableway 22
- Figure 13* Unit shell cost by story class and frame material apartments 25
- Figure 14* Estimated demand 2015 (5% scenario, 000 ft.³) 27
- Figure 15* Single-family house in Rykkinn, Norway 28
- Figure 16* Single-family house in Klagenfurt, Austria 29
- Figure 17* Country house in Québec, Canada 30
- Figure 18* Garlick Residence, Oroville, WA, United States 31
- Figure 19* Multi-family building in Judenburg, Austria 32

- Figure 20* Multi-family building in Chibougamau, Quebec, Canada 33
- Figure 21* Multi-family building in Berlin, Germany 34
- Figure 22* Multi-family building in Växjö, Sweden 35
- Figure 23* 10-story apartment building in Australia 36-37
- Figure 24* Impulsezentrum, Graz, Austria 38
- Figure 25* Montana Long Hall 39
- Figure 26* Viken Skog BA, Hønefoss, Norway 40
- Figure 27* Juwi head office, Wörrstadt, Germany 41
- Figure 28* Werkstätte, Fügen, Austria 42
- Figure 29* Kommissionshalle, Katsch, Austria 43
- Figure 30* Parking garage in Innsbruck, Austria 44
- Figure 31* Residential building in South Carolina, United States 45

1

BRIEF HISTORY

Cross-laminated timber (CLT) is a relatively new building system of interest in the North American construction and is helping to define a new class of timber products known as massive or “mass” timber. It is a potentially cost-competitive, wood-based solution that complements the existing light frame and heavy timber options, and is a suitable candidate for some applications that currently use concrete, masonry and steel. CLT is an innovative wood product that was introduced in the early 1990s in Austria and Germany and has been gaining popularity in residential and non-residential applications in Europe.

In the mid-1990s, Austria undertook an industry-academia joint research effort that resulted in the development of modern CLT. After several slow years, construction in CLT increased significantly in the early 2000s, partially driven by the green building movement but also due to better efficiencies, product approvals, and improved marketing and distribution channels. Another important factor has been the perception that CLT, like masonry and concrete, is a heavy construction system. Such systems are typical in single-family buildings and multi-story residential construction in many European countries.

The use of CLT panels in buildings has increased over the last few years in Europe. Hundreds of impressive buildings and other structures built around the world using CLT show the many advantages this product can offer to the construction sector. The European experience shows that CLT construction can be competitive, particularly in mid-rise and high-rise buildings. Easy handling during construction and a high level of prefabrication facilitate rapid project completion. This is a key advantage, especially in mid-rise construction (e.g., 5 to 10 stories). Lighter panels mean that foundations do not need to be as large. They also mean that smaller cranes can be used to lift panels higher. Good thermal insulation, good sound insulation and good performance under fire are added benefits that come as a result of a massive wood structure.

In this Chapter, we put forward an introduction to CLT as a product and CLT construction in general, along with different examples of buildings and other types of structures made with CLT panels. CLT is now available in North America and several projects already built in Canada and the United States, using CLT, are presented in this Chapter.

2

DEVELOPMENT OF CLT IN NORTH AMERICA

The driving force behind the development of CLT in North America is the need to provide alternative wood-based products and systems to architects, engineers and contractors. While this product is well established in Europe, work on the implementation of CLT products and systems has just begun in the United States and Canada. Interest in the use of CLT in North America and other industrialized countries outside of Europe is increasing.

Significant progress has been achieved in Canada with the publication of the Canadian edition of the CLT Handbook (FPInnovations, 2011) currently used for facilitating design and construction of CLT under the “Alternative Solutions” path in the Canadian building codes. This peer-reviewed Handbook was welcomed by the Canadian design and construction community, and it is being used in the design of early CLT projects. The technical information in the Handbook will also be instrumental in realizing CLT’s inclusion in the Canadian Standard for Engineering Design in Wood (CSA O86) and in the National Building Code of Canada.

This U.S. edition of the CLT Handbook is intended to assist the U.S. design and construction industry and provide a similar path to CLT’s code and standard inclusion as is being pursued in Canada. This comprehensive document provides key technical information related to the manufacturing, design and performance of CLT in construction in the following areas:

- Cross-laminated timber manufacturing
- Structural design of cross-laminated timber elements
- Lateral design (including wind and seismic performance) of cross-laminated timber buildings
- Connections in cross-laminated timber buildings
- Duration of load and creep factors for cross-laminated timber panels
- Vibration performance of cross-laminated timber floors
- Fire performance of cross-laminated timber assemblies
- Sound insulation of cross-laminated timber assemblies
- Building enclosure design of cross-laminated timber construction
- Environmental performance of cross-laminated timber
- Lifting and handling (including transportation) of cross-laminated timber elements

A harmonized North American CLT product standard, *Standard for Performance-Rated Cross-Laminated Timber* (ANSI/APA PRG 320), has been developed by the ANSI/APA CLT Standard Committee and published in December 2011 (ANSI, 2011). This standard was developed based on the consensus standard development process of APA–The Engineered Wood Association as a standards developer accredited by the American National Standards Institute (ANSI). The ANSI/APA PRG 320 standard has been approved by the Structural Committee of the International Code Council (ICC) for the 2015 International Building Code (IBC).

3

DEFINITION OF CROSS-LAMINATED TIMBER (CLT)

CLT panels consist of several layers of lumber boards stacked crosswise (typically at 90 degrees) and glued together on their wide faces and, sometimes, on the narrow faces as well. Besides gluing, nails or wooden dowels can be used to attach the layers. Innovative CLT products such as Interlocking Cross-laminated Timber (ICLT) are in the process of development in the United States as well. However, non-glued CLT products and systems are out of the scope of this Handbook.

A cross-section of a CLT element has at least three glued layers of boards placed in orthogonally alternating orientation to the neighboring layers. In special configurations, consecutive layers may be placed in the same direction, giving a double layer (e.g., double longitudinal layers at the outer faces and/or additional double layers at the core of the panel) to obtain specific structural capacities. CLT products are usually fabricated with an odd number of layers; three to seven layers is common and even more in some cases.

Thickness of individual lumber pieces may vary from 5/8 inch to 2.0 inches (16 mm to 51 mm) and the width may vary from about 2.4 inches to 9.5 inches (60 mm to 240 mm). Boards are finger jointed using structural adhesive. Lumber is visually graded or machine stress rated and is kiln dried. Panel sizes vary by manufacturer; typical widths are 2 ft. (0.6 m), 4 ft. (1.2 m), 8 ft. (2.4 m) and 10 ft. (3 m) while length can be up to 60 ft. (18 m) and the thickness can be up to 20 inches (508 mm). Transportation regulations may impose limitations to CLT panel size.

Lumber in the outer layers of CLT panels used as walls are normally oriented up and down, parallel to gravity loads, to maximize the wall's vertical load capacity. Likewise, for floor and roof systems, the outer layers run parallel to the major span direction.

Figure 1 illustrates a CLT panel configuration, while Figure 2 shows examples of possible CLT panel cross-sections. Figure 3 illustrates a 5-layer CLT panel with its two cross-sections.

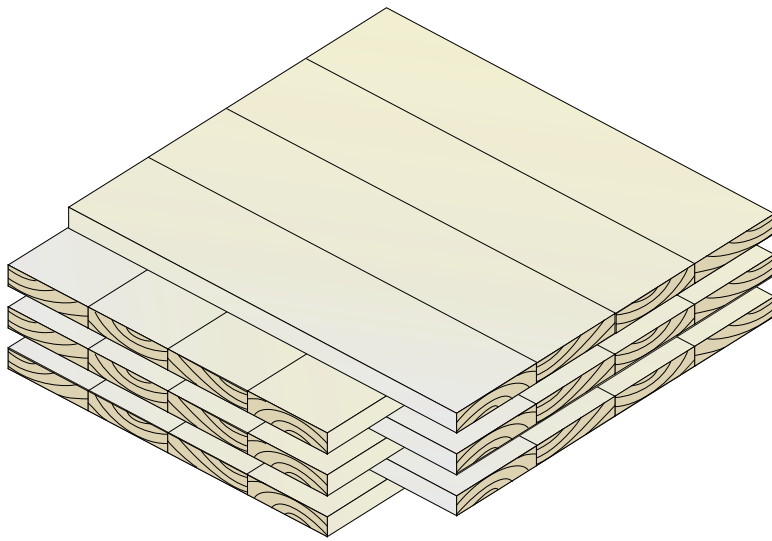

Transverse Planks

Longitudinal Planks

Figure 1
CLT panel configuration

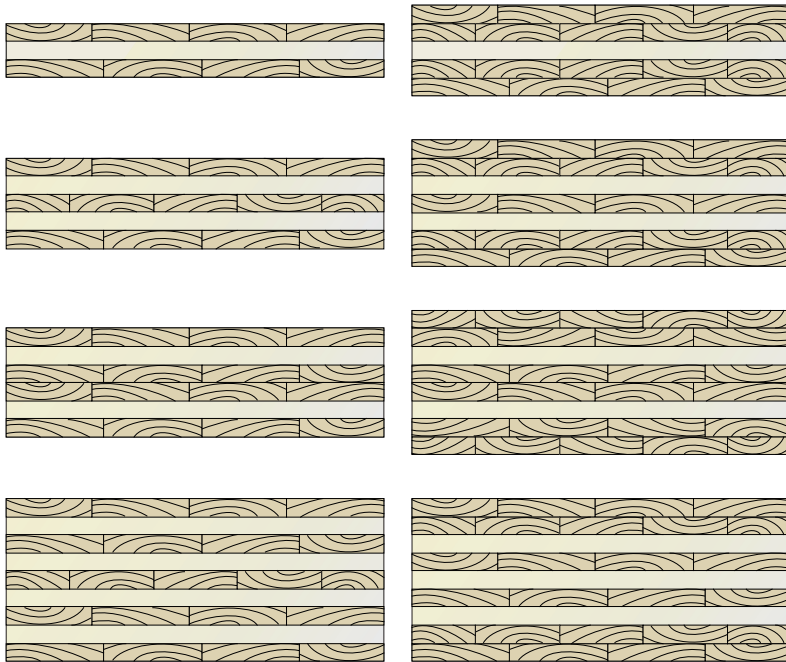

Figure 2
Examples of CLT panel cross-sections

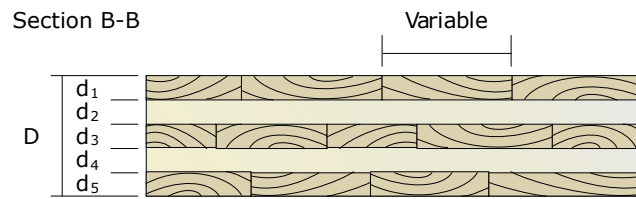
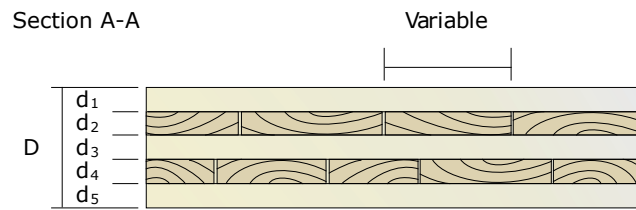
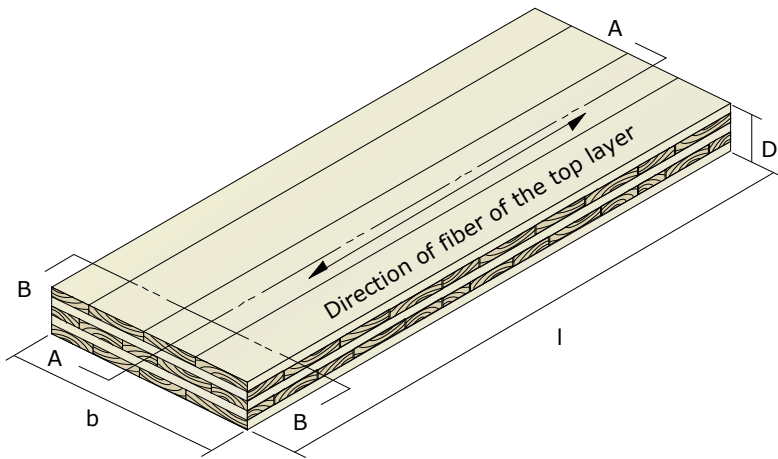

Figure 3
Example of CLT panel cross-sections and direction of fibers of the top layers

4

KEY ADVANTAGES OF CROSS-LAMINATING

Cross-laminated timber used for prefabricated wall and floor panels offers many advantages. The cross-laminating process provides improved dimensional stability to the product which allows for prefabrication of long, wide floor slabs, long single-story walls and tall plate heights conditions as in clerestory walls or multi-story balloon framed configurations. Additionally, cross-laminating provides relatively high in-plane and out-of-plane strength and stiffness properties, giving it two-way action capabilities similar to a reinforced concrete slab. The ‘reinforcement’ effect provided by the cross-lamination in CLT also considerably increases the splitting resistance of CLT for certain types of connection systems.

Figure 4 illustrates the primary difference between CLT and glulam products. Figure 5a shows a floor built with four individual CLT panels acting mostly in one direction, while Figure 5b illustrates the same floor, this time built with one CLT panel only, acting most likely in two directions (i.e., two-way action).

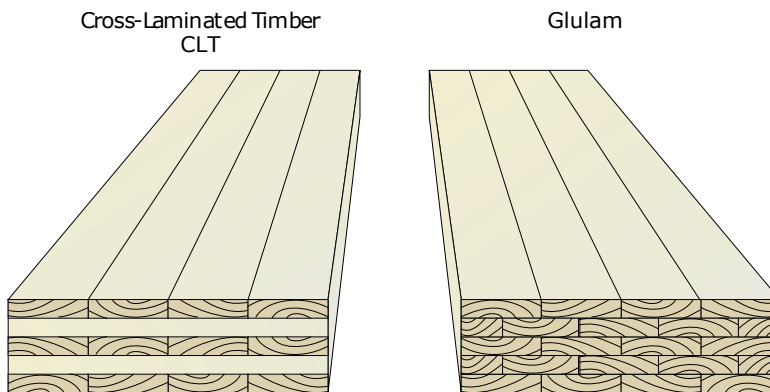
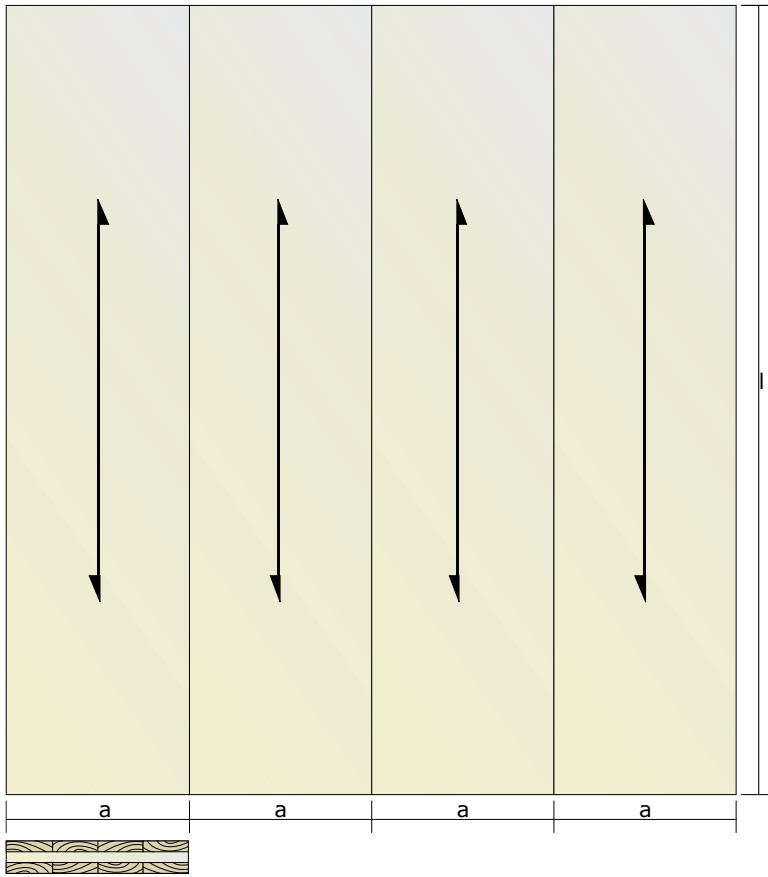
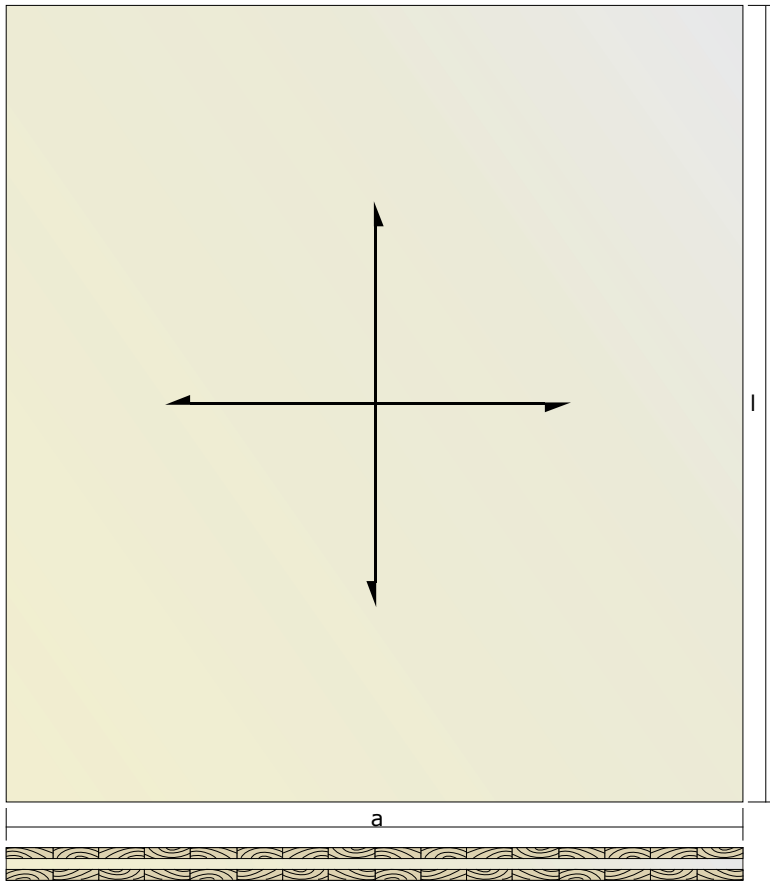

Figure 4
CLT vs. glulam panel



(a)



(b)

Figure 5

- (a) Floor assembly made of four 3-ply CLT panels acting in one direction and
 - (b) Floor assembly made of one 3-ply CLT panel acting in both directions.
- Distance “a” may reach 10 ft. (3 m)

5

MANUFACTURING PROCESS

A typical manufacturing process of CLT includes the following steps: lumber selection, lumber grouping and planing, adhesive application, panel lay-up and pressing, product cutting, surface machining, marking and packaging. The key to a successful CLT manufacturing process is consistency in the lumber quality and control of the parameters that impact the quality of the adhesive bond. Stringent in-plant quality control tests are required to ensure that the final CLT products will fit for the intended applications.

Typically, lumber must be kiln dried to a moisture content of $12\% \pm 3\%$. Proper moisture content prevents dimensional variations and surface cracking. Lumber can be procured dried or further drying may be needed at the factory. Trimming and finger jointing are used to obtain the desired lengths and quality of lumber. Finger jointed CLT panels are also available in Europe, but are out of the scope of the North American ANSI APA/PRG 320 CLT product standard at this time.

Panel dimensions vary by manufacturer. The assembly process can take from 15 to 60 minutes depending on equipment and adhesive. Adhesive is the second material input in CLT. Types of adhesives used in North America must meet the same requirements as those used in glued laminated timber manufacturing and include qualified polyurethane, melamine and phenolic-based adhesives. Both face and edge gluing can be used. Once adhesive is applied, the assembly is pressed using hydraulic (more common) or vacuum presses and compressed air depending on panel thickness and adhesive used. The assembled panels are usually planed and/or sanded for a smooth surface at the end of the process. Panels are cut to size and openings are made for windows, doors and service channels, connections and ducts using CNC (Computer Numerical Controlled) routers which allow for high precision. For quality control purposes, compliance with product requirements prescribed in the product standard are typically checked at the factory (e.g., bending strength, shear strength, delamination).

Chapter 2, entitled *Cross-laminated timber manufacturing*, provides general information about CLT manufacturing targeted mainly to engineers, designers, and specifiers. The information contained in this Chapter may also be useful to potential U.S. CLT manufacturers.

Figures 6 and 7 illustrate a typical CLT wall and floor assembly, respectively.

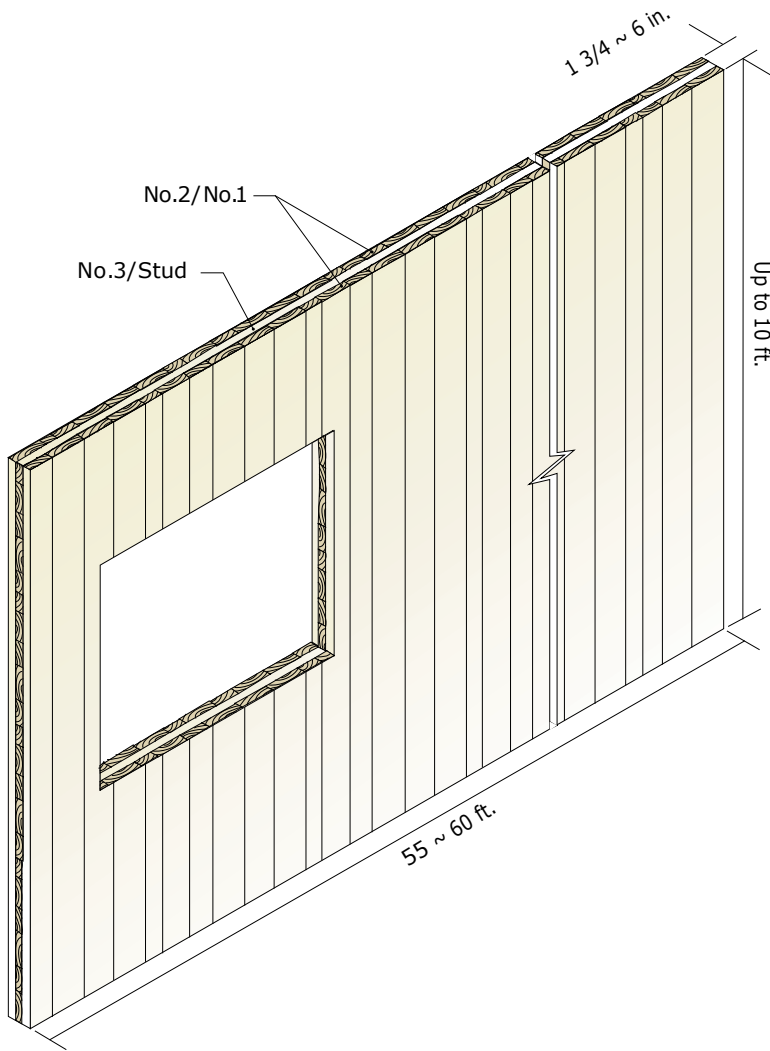

Figure 6
CLT wall

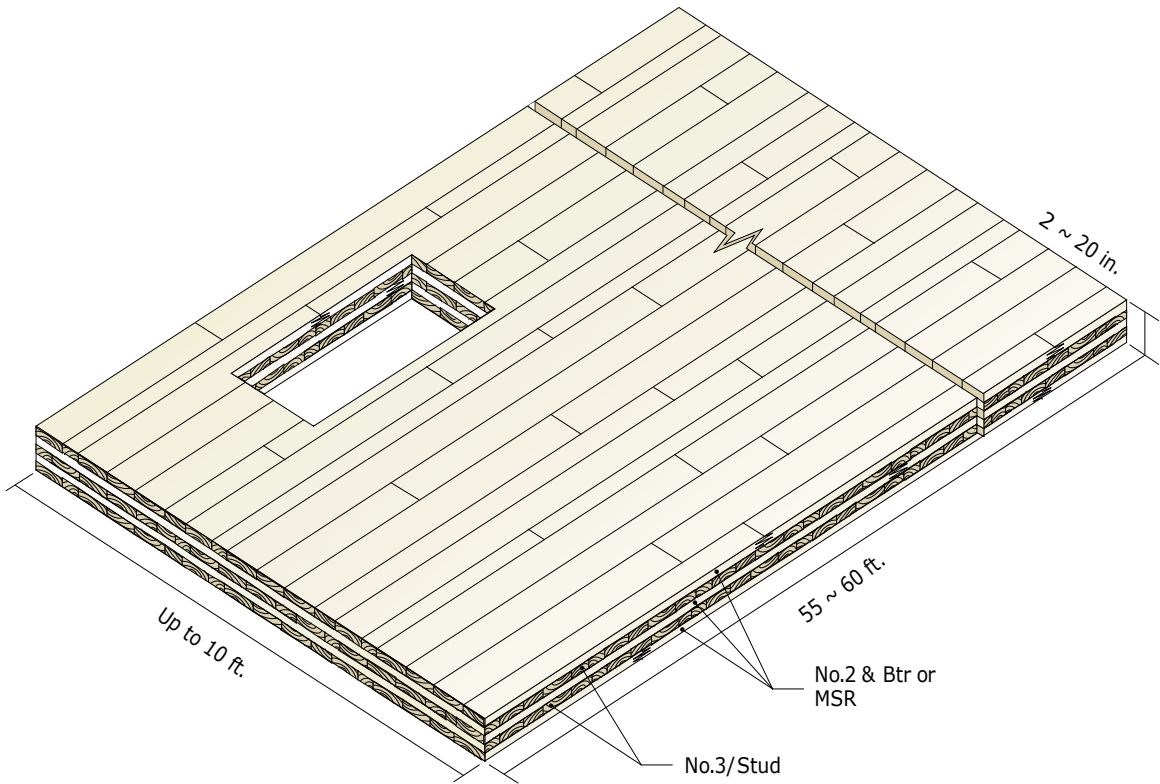

Figure 7
CLT floor or roof

6

STRUCTURAL DESIGN AND SERVICEABILITY CONSIDERATIONS OF CLT

CLT panels are typically used as load-carrying plate elements in structural systems such as walls, floors and roofs. For floor and roof CLT elements, key critical characteristics that must be taken into account are the following:

- In-plane and out-of-plane bending strength, shear strength, and stiffness
- Short-term and long-term behavior:
 - instantaneous deflection
 - long-term deflection (creep deformation)
 - long-term strength for permanent loading
- Vibration performance of floors
- Compression perpendicular to grain issues (bearing)
- Fire performance
- Sound insulation
- Durability.

For wall elements, the followings are key characteristics that must be taken into account at the design stage:

- Load-bearing capacity (critical criterion)
- In-plane and out-of-plane shear and bending strength
- Fire performance
- Sound insulation
- Durability.

The following sections provide a brief summary of the key design and performance attributes of CLT panels and assemblies.

6.1 Proposed Analytical Design Methods

Various different design methods have been adopted in Europe for the determination of basic mechanical properties of CLT. Some of these methods are based on testing while others are more analytical. For floor elements, a testing method of evaluation involves determination of flexural properties by testing full-size panels or sections of panels with a specific span-to-depth ratio. The problem with the testing based approach is that every time the lay-up, type of material, or any other manufacturing parameters change, more testing is needed to evaluate the bending and shear properties of such new product configurations.

Analytical approach, once verified with the test data, offers a more general and less costly alternative. An analytical approach generally predicts strength and stiffness properties of CLT panels based on the input material properties of the laminate boards that make up the CLT panel. Some of the proposed European methods are described in detail in the Canadian edition of the CLT Handbook (FPInnovations, 2011). One of them, the shear analogy method, is the method used by ANSI APA/PRG 320 for determining the bending and shear stiffness of various lay-ups (ANSI, 2012).

The proposed analytical procedures for determining basic mechanical properties of CLT panels for designers are given in Chapter 3 entitled *Structural design of cross-laminated timber elements*.

6.2 Lateral Design of CLT Buildings

Based on both a literature review of research work conducted around the world and the results of a series of quasi-static tests conducted at FPInnovations on regular and tall walls, CLT wall panels can be used as an effective lateral load resisting system (Ceccotti, 2008). Results from small- and large-scale shake table seismic tests on two CLT buildings in Japan by the Trees and Timber Research Institute of Italy (CNR-IVALSA) in 2009 demonstrated that CLT structures perform quite well when subjected to seismic force (Figure 8).

FPInnovations' shearwall and assembly tests to date have also shown that the CLT wall panels demonstrated adequate seismic performance when nails or slender screws are used with steel L-brackets to connect the walls to the floors below (this ensures a ductile failure in the connection instead of a brittle failure in the panel). The use of hold-downs installed with nails on each end of the walls tends to further improve their seismic performance. Use of diagonally placed long screws to connect CLT walls to the floor below is not recommended in high seismic zones due to lower ductility and brittle failure mechanisms. Use of half-lapped joints in longer walls can be an effective solution not only to reduce the wall stiffness and thus reduce the seismic input load, but also to improve wall ductility. Timber rivets in smaller groups with custom made brackets were found to be effective connectors for CLT wall panels due to their potentially high ductility. Further research in this field is needed to clarify the use of timber rivets in CLT and to verify performance of CLT walls under seismic loading with alternative types of connection systems (e.g., bearing types). A 2-story CLT assembly has also been tested at FPInnovations and the results confirmed the shake table tests conducted by CNR-IVALSA (Figure 9).

While most CLT buildings are platform framed, they are far less susceptible to develop soft story failure mechanisms than other platform framed structural systems. Since the nonlinear behavior (and the potential damage) is localized in the hold-down and L-bracket connection areas, the panels—that are also the vertical load carrying elements—are virtually left intact in place and uncompromised, even after failure of the connections. In addition, all CLT walls on a single level contribute to the lateral and gravity resistance, providing a degree of redundancy and a system sharing effect. Vertical and lateral load sharing can also take place between levels, creating a honeycomb effect.

Chapter 4 entitled *Lateral design of cross-laminated timber buildings* provides general information about lateral design of CLT structures. Recommendations related to seismic modification factors are also made.



Figure 8
Seven-story CLT building tested at E-Defense Laboratory in Miki as a part of the SOFIE Project
and CLT test assembly at FPInnovations



Figure 9
CLT test assembly at FPInnovations

6.3 Connections and Construction of CLT Structures

Connections in timber construction, including those built with CLT, play an important role in maintaining the integrity of the timber structure and in providing strength, stiffness, stability and ductility. Consequently, they require thorough attention of the designers.

Traditional and innovative connection systems have been used in CLT assemblies in Europe and North America. Common types of connections in CLT assemblies include: panel-to-panel (floors, walls and roofs), wall-to-foundation, wall-to-wall intersections and wall-to-floor/roof assemblies. Basic panel-to-panel connection can be established through single or double exterior splines made with engineered wood products, single or double interior splines, or half-lapped joints. Metal brackets, hold-downs and plates are used to transfer forces at the wall to floor/roof interfaces and in wall-to-wall intersections. Innovative types of connection systems can also be used which lead to enhanced performance or quicker assembly.

Researchers in Europe have developed design procedures for traditional connections in CLT. These include dowels, wood screws, and nails, which are commonly used in Europe for designing CLT assemblies. Empirically based equations were developed for the calculation of characteristic embedment properties of each type of fastener (i.e., dowels, screws, nails), depending on the location with respect to the plane of the panel (perpendicular to or on edge). Those equations were verified with testing and results seem to correspond well with calculated predictions (Uibel and Blass, 2006 and 2007). Yield mode equations were adopted for the design using CLT fastener embedment strength equations. Empirical equations have also been developed for the calculation of the withdrawal resistance of the various types of fasteners in CLT based on hundreds of tests. Based on limited exploratory validation tests conducted at FPInnovations using self-tapping screws on European CLT, the proposed embedment equations seem to provide reasonable predictions of both the lateral and withdrawal capacity based on the Canadian timber design provisions (Muñoz et al., 2010). More work is needed, however, to validate the proposed equations using North American made CLT and different types of fasteners.

Due to the reinforcing effect of cross-lamination in CLT, it is speculated that current minimum geometric requirements given in the *National design specification (NDS) for wood Construction* for dowels, screws and nails in solid timber or glulam could be applicable to CLT. However, designers need to be cautious about this as further

verification is needed, considering the specific features of individual panel types. Brittle failure modes, which have not yet been investigated, also need to be taken into account.

Chapter 5, entitled *Connections in cross-laminated timber assemblies*, is mainly focused on CLT assemblies. However, since all buildings are considered to be mixed construction to a certain extent, the scope covers hybrid construction, where traditional wood-based systems (e.g., light frame, glulam, etc.) or materials such as concrete or steel are mixed with CLT to resist vertical and lateral loads.

6.4 Duration of Load and Creep Behavior

Cross-laminated timber products are used as load-carrying slabs and wall elements in structural systems, thus load duration and creep behavior are critical characteristics that must be addressed in structural design. Given its lay-up configuration with orthogonal arrangement of layers bonded with structural adhesive, CLT is more prone to time-dependent deformations under load (creep) than other engineered wood products such as glued-laminated timber.

Time dependent behavior of structural wood products is addressed in design standards by load duration factors that adjust design properties. Since CLT has been recently introduced into the North American market, the current design standards and building codes do not specify load duration and creep adjustment factors for CLT. Until this can be rectified, options are proposed for those specifying CLT systems in Chapter 6, entitled *Duration of load and creep factors for cross-laminated timber panels*. These include not only load duration and service factors, but also an approach for accounting for creep in CLT structural elements.

Since cross-laminated timber is not yet covered by the NDS, the intent is to recommend a suitable approach that accounts for the duration of load and creep factors in the design of CLT.

6.5 Vibration Performance of Floors

Studies at FPInnovations found that bare CLT floor systems differ from traditional lightweight wood joisted floors with typical mass around 4 lb./ft.² (20 kg/m²) and fundamental natural frequency above 15 Hz, and heavy concrete slab floors with a mass above 40 lb./ft.² (200 kg/m²) and fundamental natural frequency below 9 Hz. Based on FPInnovations' test results, bare CLT floors were found to have mass varying from approximately 6 lb./ft.² (30 kg/m²) to 30 lb./ft.² (150 kg/m²), and a fundamental natural frequency above 9 Hz. Due to these special properties, the standard vibration controlled design methods for lightweight and heavy floors may not be applicable for CLT floors.

Some CLT manufacturers have recommended that deflection under a uniformly distribution load (UDL) be used to control floor vibration problems. Using this approach, the success in avoiding excessive vibrations in CLT floors relies mostly on the designer's judgment. Besides, static deflection criteria can only be used as an indirect control method because they ignore the influence of mass characteristics of the floors. Therefore, a new design methodology is needed to determine the vibration controlled spans for CLT floors.

A proposed design methodology for controlling vibrations of CLT floors under normal walking is given in Chapter 7 entitled *Vibration performance of cross-laminated timber floors*.

6.6 Fire Performance of Cross-laminated Timber Assemblies

Cross-laminated timber panels have great potential for providing cost-effective building solutions for residential, commercial and institutional buildings as well as large industrial facilities in accordance with the International Building Code (IBC).

The intent of the IBC is to establish the minimum requirements for public safety. The code is addressing such things as structural strength and stability, means of egress, life safety and protection of property from fire as well as providing safety for firefighters and emergency responders during emergency operations. As such, fire safety issues such as providing adequate structural integrity, limiting impact to people and property as well as limiting fire spread through a building and/or to adjacent properties during a fire are critical for every building design and structural system.

Structural integrity and fire spread capability of building assemblies can be assessed by conducting full-scale fire-resistance tests in accordance with ASTM E119 standard test methods. Fire resistance is defined as the ability of a material or their assemblies to prevent or retard the passage of excessive heat, hot gases or flames under conditions of fire. A fire-resistance rating is defined as the period of time a building element, component or assembly maintains the ability to confine a fire (separating function), and/or continues to perform a given structural function. More specifically, a standard fire-resistance test entails three failure/acceptance criteria:

1. Mechanical resistance: the assembly must support the applied load for the duration of the test;
2. Integrity: the assembly must prevent the passage of flame or gases hot enough to ignite a cotton pad;
3. Insulation: the assembly must prevent the temperature rise on the unexposed surface from being greater than 325°F (180°C) at any location, or an average of 250°F (140°C) measured at a number of locations, above the initial temperature.

The time at which the assembly can no longer satisfy any one of these three criteria defines its fire-resistance rating.

In order to facilitate future Code acceptance for the design of CLT panels for fire resistance, a research project has recently been completed at FPInnovations. The main objective of the project was to develop and validate a generic calculation procedure to calculate the fire-resistance ratings of CLT wall and floor assemblies. A series of full-scale fire-resistance experiments in accordance with ASTM E119 standard time-temperature curve were conducted to allow a comparison between the fire resistance measured during a standard fire-resistance test and that calculated using the proposed procedure.

Results of the full-scale fire tests show that CLT panels have the potential to provide excellent fire resistance often comparable to typical heavy construction assemblies of non-combustible construction. Due to the inherent nature of thick timber members to slowly char at a predictable rate, CLT panels can maintain significant structural capacity for an extended duration of time when exposed to fire.

In addition to the fire-resistance calculation method of CLT assemblies, Chapter 8, entitled *Fire performance of cross-laminated timber assemblies*, provides requirements related to fire safety in buildings, namely in regards to the types of construction prescribed in the IBC, fire-resistance requirements, connection detailing, interior finishes, through-penetrations and exterior walls.

6.7 Sound Insulation of Cross-laminated Timber Buildings

Adequate levels of noise/sound control in multi-family buildings are mandatory requirements of most building codes in the world. In many jurisdictions, these requirements are as strictly enforced as those for structural sufficiency and fire safety.

Chapter 9, entitled *Sound insulation of cross-laminated timber buildings*, first attempts to answer simple questions related to the definition of sound, its sources, quantification and methods of measurement, acceptable levels of sound, differences between sound and noise, etc. Of course, when verbalizing such questions, some obvious answers naturally emerge in the reader's mind.

This Chapter also introduces the International Building Code's (IBC) requirements for sound insulation. State of the art construction details for CLT walls and floor/ceiling assemblies generally meeting IBC requirements are provided based on the results of tests performed in various laboratories and fields. A step by step guide finally leads the reader to assemblies that will meet the occupants' satisfaction.

6.8 Building Enclosure Design of Cross-laminated Timber Construction

Building envelope design has important implications for the energy performance and durability of the structure as well as indoor air quality. The key performance requirements of the envelope, discussed in Chapter 10 entitled *Building enclosure design of cross-laminated timber construction*, are prevention of water intrusion and control of heat, air, and moisture flow.

The use of prefabricated CLT panels does not modify the basic heat, air, and moisture control design principles for an exterior wall or roof assembly. However, the design of CLT assemblies requires attention due to the unique characteristics of this product. CLT panels are made from massive, solid wood elements and therefore provide some level of thermal insulation and thermal mass. Although CLT panels may have an inherent level of air tightness as a panel product produced with high precision, an additional air barrier is recommended, and it is critical that panel joints and interfaces as well as penetrations such as windows and doors be properly air sealed. CLT panels have a relatively high capacity to store moisture, but relatively low vapor permeability. If exposed to excessive wetting during construction, the panels may absorb a large amount of moisture, which may result in slow drying.

This Chapter provides guidance on heat, air, and moisture control in wall and roof assemblies that utilize CLT panels in various North American climate zones. The overarching strategies are to place insulation in such a way that the panels are kept warm and dry, to prevent moisture from being trapped or accumulating within the panels, and to control airflow through the panels and at the joints and interfaces between them. In certain climates, preservative treatment of CLT is recommended to provide additional protection against potential hazards such as termites.

It is intended that these guidelines should assist practitioners in adapting CLT construction to North American conditions and ensuring a long life for their buildings. However, these guidelines are not intended to substitute for the input of a professional building scientist.

7

ENVIRONMENTAL PERFORMANCE OF CLT

The environmental footprint of CLT is frequently discussed as potentially beneficial when compared to functionally equivalent non-wood alternatives, particularly concrete systems.

In Chapter 11, entitled *Environmental performance of cross-laminated timber*, the role of CLT in sustainable design is addressed. The embodied environmental impacts of CLT in a mid-rise building are discussed, with preliminary results from a comprehensive life cycle assessment (LCA) study.

Chapter 11 discusses other aspects of CLT's environmental profile, including impact on the forest resource and impact on indoor air quality from CLT emissions. The ability of the North American forest to sustainably support a CLT industry is an important consideration and is assessed from several angles, including a companion discussion regarding efficient use of material. Market projections and forest growth-removal ratios are applied to reach a clear conclusion that CLT will not create a challenge to the sustainable forest practices currently in place in North America and safeguarded through legislation and/or third party certification programs.

Finally, to assess potential impact on indoor air quality, CLT products with different thicknesses and glue lines were tested for their volatile organic compounds (VOCs) including formaldehyde and acetaldehyde emissions. CLT was found to be in compliance with European labeling programs as well as the most stringent CARB limits for formaldehyde emissions. Testing was done on Canadian species, as there was no U.S. supplier of CLT at the time of this writing; because VOC emissions are affected by species, this work should be repeated for products made from different species.

8

CLT IN CONSTRUCTION

The prefabricated nature of CLT permits high precision and a construction process characterized by faster completion, increased safety, less demand for skilled workers on site, less disruption to the surrounding community and less waste. Openings for windows, doors, staircases and utilities are pre-cut using CNC (Computer Numerical Controlled) machines at the factory. Buildings are generally assembled on site but panels are prefabricated and transported to the site, where they are connected by means of mechanical fastening systems such as bolts, lag bolts, self-tapping screws, ringed annual shank nails, and so on.

CLT as a building system is quite adaptable, performing well in long spans in floors, walls and roofs, with the potential for a high degree of exterior and interior finishes preinstalled off-site. Its ability to be used as either a panelized or a modular system makes it ideally suited for additions to existing buildings. It can be used jointly with any other building material, such as light wood frame, heavy timber, steel or concrete, and accepts a range of finishes. CLT panels can also be built compositely with reinforced concrete to enable longer spans (i.e., longer than 30 feet or 10 m). Good thermal insulation, good sound insulation and an impressive performance under fire conditions are added benefits which result from the massiveness of the wood structure.

8.1 Considerations for Transportation and Construction Site Limitations

Before undertaking the design of a CLT building, a plan should be drawn up for transporting the prefabricated CLT elements and storing them on site. Transporting CLT panels can be costly and, depending on the size of the element, may require specialized transportation services. The construction site itself may have restrictions due to size or to local regulations. It is best to start by making sure that the route from the plant to the construction site will allow movement of the truck, including its load, without any obstacles. This is especially critical for oversize loads. Considerations for transportation of CLT elements are presented in Chapter 12 entitled *Lifting and handling of cross-laminated timber elements*.

8.2 Materials on the Construction Site

Wood-based building materials must be stored properly on the site if not used immediately. Good planning is essential to ensure that CLT assemblies have the necessary handling space and proper material flow during construction. Stacking of the panels on the construction site must match the planned installation sequence to avoid additional costs and to reduce the risk of accidents or breaking.

When CLT panels are stored on site, great care must be taken to protect them against the elements and vandalism. If panels must be placed temporarily on the ground prior to installation, they should be put down on skids of sufficient number to protect the panels from standing water. The panels must also be completely protected from the weather by appropriate wrapping or by other measures.

Figure 10 shows CLT panel packs in the process of being unloaded from a truck for storage on site. In this example, the packs are completely wrapped (six faces) and are placed on wood skids to protect them from standing water. Although this packaging practice may be adequate, it is crucial to also use high-quality tarpaulin and to ensure that the packs remain sealed. If there are openings, water could infiltrate and remain trapped.



Figure 10

Storage on construction site – individually wrapped bundles stacked on lumber skids

Figure 11 shows truck platforms left on construction site. They will be recovered on the next trip. This can reduce costs by allowing independent scheduling of transportation and unloading.



Figure 11

Truck platforms left on construction site – will be recovered on the next trip

8.3 Lifting and Handling of CLT Elements

The emerging CLT construction industry has developed a range of techniques for lifting and handling CLT panels. The complexity of the structure or its location often dictates the techniques and systems to be used. Naturally, erecting an 8-story building in a downtown area typically requires more preparation and skill than a single-family residence built in the country. But if that country house is to be perched high in the mountains, more efforts may be required (Figures 12).



Figure 12
Lifting and handling of CLT elements by cableway (courtesy of KLH)

There are several types of lifting equipment that can be used on construction sites. Each has its own characteristics for lifting and handling heavy loads such as CLT panels. Therefore, it is essential to choose the right lifting and handling system for each type of component. Several lifting and handling systems and techniques are presented in Chapter 12.

8.4 Construction Accessories and Materials

Numerous construction accessories and materials are required on a construction site. In addition to the items and tools normally required in conventional wood construction, suggestions are made in Chapter 12 for products, tools, and accessories that may be useful or essential on a construction project using CLT panels.

9

ASSESSMENT OF MARKET OPPORTUNITY

This assessment of market opportunity relies on the latest construction statistics for the United States only. These statistics (floor area by building type) were multiplied by use factors and hence volumes for CLT were estimated.

9.1 Methodology

A 3-tier approach was followed:

1. Estimation of manufacturing costs;
2. Assessment of cost competitiveness of the building shell; and
3. Use of different market penetration scenarios to estimate the market opportunity.

These points are explained below. All costs are presented in U.S. dollars.

9.1.1 CLT Assembly Costs

In-house simulation work established the average production cost of CLT at \$19.20 per cubic foot¹. Two panel thicknesses were used: 3-ply 4 ¼ in. (108 mm) for walls and 5-ply 7 in. (178 mm) for floors. The cost of the assembly per square foot was calculated as a function of thickness plus a 25% profit markup. Connectors and erection costs were also included (\$0.70 and \$1.24 per sq. ft., respectively). Similarly, the cost of engineering and CAD work by the manufacturer was added at \$1.00/sq. ft. This resulted in assembly costs of approximately \$12 and \$19 per square foot for walls and floors, respectively. These prices may increase if visual grade is desired or if lumber prices go up with respect to the baseline of this study

9.1.2 Construction Statistics

Market size was calculated using the McGraw-Hill 2011, with 1 to 10 stories as base. The year 2011 was selected as a proxy for mid-term demand (2015) based on available forecasts from the same source². The 10+ story segment was not included though it is feasible to expect some future penetration in this height class (currently 10+ story apartments represent 10% of the 1 to 10 stories apartment floor area).

9.1.3 Sample Selection

Fourteen common building types were selected for this study. The selection was based on their current share of the non-residential market. Altogether, 86 combinations of building type, story class, and frame material were analyzed to calculate their shell unit costs and compare them against the CLT solution. Shell costs include the structural components of a building; namely walls, floors, shafts, and roof.

¹ Delivered within a 300-mile radius. Total lumber costs, including remanufacturing and post dry, amount to \$400/MBF.

² 2011 values were multiplied by 1.79 to reflect expected demand levels for 2015.

9.1.4 Shell Unit Costs and Competitiveness

Shell unit costs (\$/sq. ft. of floor area) were obtained from simulations on conceptual buildings (average) performed using the square cost estimator feature of Costworks™, an appraisal tool from RSMeans. Normally, each situation included costing 4-6 material choices, sometimes including light wood frame. A side-by-side comparison of shell unit costs for CLT vs. the incumbent materials allowed the estimation of cost competitiveness (see Section 9.2.1 for more details).

9.1.5 CLT Assembly Costs

The square footage of each assembly (e.g., total sq. ft. of exterior walls) was calculated from Costworks™ using average parameters and dimensions by building type. These square footages were multiplied by CLT's unit assembly costs (e.g., \$/sq. ft. of wall area) to calculate the total cost by assembly and shell. The CLT assembly configuration varied according to building type. The default exterior wall assembly consisted of:

- 3-ply CLT
- Vinyl siding
- Furring (2"x4")
- Fire-rated (FR) gypsum
- 3 in. expanded polystyrene (EPS)
- Vapor retarder.

Industrial buildings considered metal siding (corrugated steel) and interior fire-rated (or Type X) gypsum. Floors consisted of 5-ply CLT plus plywood underlayment. It is acknowledged that some situations may call for thicker panels, for instance a 7-ply CTL panel.

Roof consisted of a gang-nailed wood truss assembly for all buildings except industrial. Industrial buildings considered metal deck with open web steel joists, beams, and hollow steel columns. All roof assemblies considered roof coverings (built-up) and insulation (2 in. EPS + 1 in. perlite).

Partitions considered 3-ply CLT plus 5/8 in. Type X gypsum board on both sides. Twenty percent of partitions were considered to be load-bearing and using CLT, the balance assuming metal studs. Non-CLT buildings considered drywall on metal studs.

Shafts assumed a 5-ply panel.

Parking garages considered 5-ply CLT for all assemblies. They also included glulam beams and columns (22 in. x 22 in.), including connectors and installation costs. Epoxy coating was included too.

Not included:

- Land
- Foundations (savings are expected due to lighter foundations)
- Time savings (time savings estimated at 20% vs. concrete).

9.2 Results

9.2.1 Shell Cost Competitiveness

Light wood frame is the most economical system in low-rise projects, with CLT becoming normally more competitive only at higher building heights or sizes (Figure 13). Most industrial buildings and—to some extent—parking garages showed similar or slightly higher shell costs for CLT and therefore may represent an attractive choice for CLT given their relatively regular footprint and repetitive layout. Besides mid-rise and industrial, retail (1-2 stories) and educational (2-3 stories) buildings are also good bets for CLT. It must be noted that shell costs normally account for about 20-30% of the total cost of a finished concrete/steel building and, therefore, is expected that some of these differences in shell costs will be less noticeable when considering total unit costs.

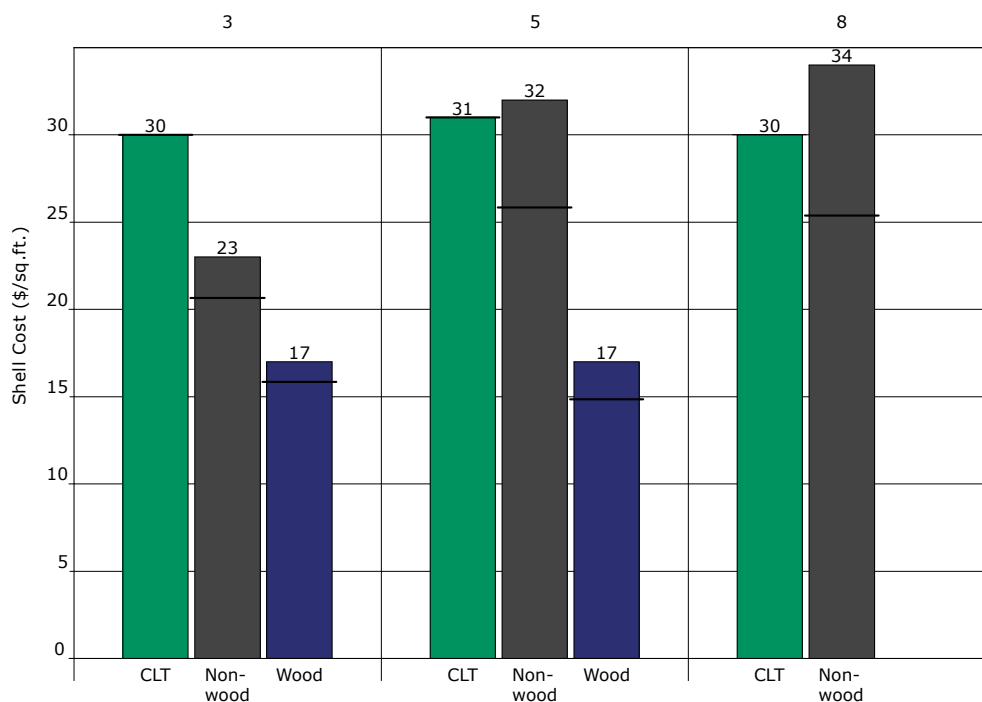

Figure 13
Unit shell cost by story class and frame material apartments

9.2.2 Assessment of Demand

Two market penetration scenarios were considered: 5% and 15%. Based on shell costs, a competitiveness factor was assigned to each situation. This 'c-factor' acted as a multiplier on the floor area per situation. Building code limitations were considered too. For instance, only low-rise health buildings are included in the assessment. For other building types, it is assumed that code will allow CLT in the future. For a more conservative demand estimate, the reader may choose considering only the 1-4 story segment (94%).

In summary, the U.S. market opportunity for CLT is estimated at 0.9 to 2.7 BBF (Table 1) approximately³. To provide a framework for these numbers, total consumption of softwood lumber in the United States in 2011 was estimated at 85.4 million m³. No reliable forecast for 2015 is available in order to estimate the equivalency or share of those 1.5-4.5 million m³ of potential opportunity. To put these numbers in perspective, the assessment

³ CLT buildings consume 0.1 to 1+ ft³ of CLT per sq. ft. of floor area, with an average around 0.6 ft³/sq. ft.

represents a potential increase of 2 to 7 percent in total U.S. softwood lumber demand over 2011 consumption. This demand is equivalent to somewhere between two and six billion dollars of CLT shell value⁴. Demand is concentrated on the East Coast, the Great Lakes States, Texas, and California (Figure 14).

Table 1
Market opportunity (2015)

Volumes BF ¹ (000s)										
		Total Volume			5% scenario			15% scenario		
		2015 (e)			2015 (e)			2015 (e)		
Project Header	Project Use	1-4	5-10	Total	1-4	5-10	Total	1-4	5-10	Total
Non-residential	Commercial	7,130,609	235,318	7,365,926	356,530	11,766	368,296	1,069,591	35,298	1,104,889
	Industrial	1,205,566	987	1,206,553	60,278	49	60,328	180,835	148	180,983
	Institutional	5,762,991	126,732	5,889,723	288,150	6,337	294,486	864,449	19,010	883,458
	Miscellaneous	821,803	248	822,051	41,090	12	41,103	123,270	37	123,308
	Total	14,920,968	363,285	15,284,253	746,048	18,164	764,213	2,238,145	54,493	2,292,638
Residential	Apartments	2,075,353	807,351	2,882,704	103,768	40,368	144,135	311,303	121,103	432,406
	Total	2,075,353	807,351	2,882,704	103,768	40,368	144,135	311,303	121,103	432,406
Grand total		16,996,321	1,170,636	18,166,957	849,816	58,532	908,348	2,549,448	175,595	2,725,044

¹BF=Board feet

Clearly, the 1-4 story segment represents the largest market opportunity given its share of the market. This is especially true for the non-residential market, notably commercial and institutional buildings making up 87% of the non-residential opportunity. Conversely, in the case of apartments, nearly 40% of the opportunity comes from the 5 to 10-story height class. However, recent trends towards cheaper for rent wood-framed apartment buildings might hinder the inroad of CLT into this segment.

This estimate does not include possible inroads into the high-end single-family market.

⁴ 25% GC overhead and profit included.

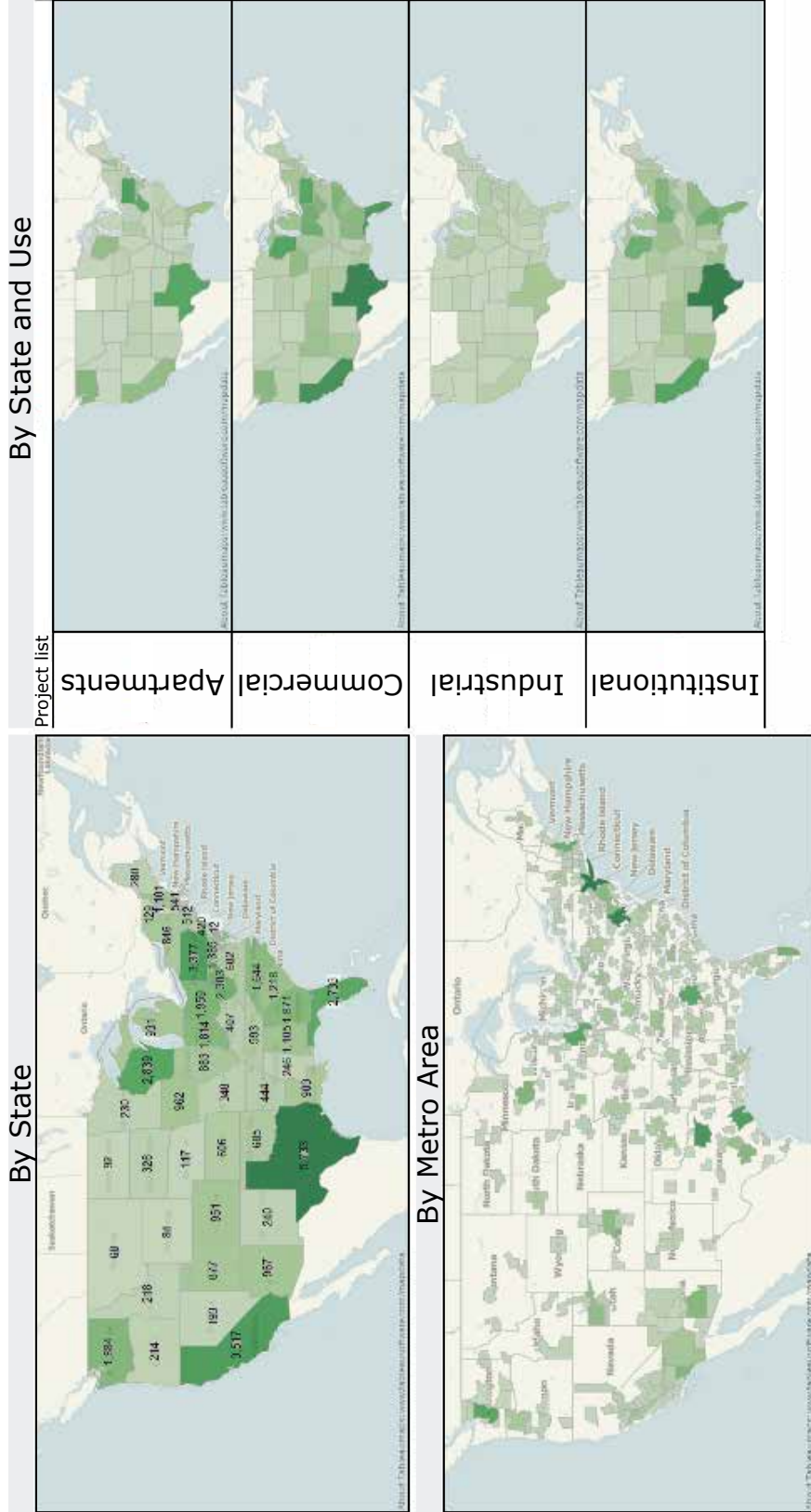

Figure 14
 Estimated demand 2015 (5% scenario, 000 ft.³)

10

BUILDING EXAMPLES

The purpose of this section is to introduce interesting examples of buildings built around the world using CLT elements.

10.1 Residential Buildings



Figure 15
Single-family house in Rykkinn, Norway



Figure 16
Single-family house in Klagenfurt, Austria (courtesy of KLH)



Figure 17
Country house in Québec, Canada



Figure 18
Garlick Residence, Oroville, WA, United States (courtesy of Structurlam Products Ltd.)



Figure 19
Multi-family building in Judenburg, Austria (courtesy of KLH)



Figure 20
Multi-family building in Chibougamau, Québec, Canada (courtesy of Nordic Engineered Wood)



Figure 21
Multi-family building in Berlin, Germany



Figure 22
Multi-family building in Växjö, Sweden





Figure 23
10-story apartment building in Australia
(courtesy of Lend Lease, www.forteliving.com.au)

10.2 Office and Commercial Buildings



Figure 24
Impulsezentrum, Graz, Austria (courtesy of KLH)



Figure 25
Montana Long Hall (photo courtesy of Darryl Byle in connection with ITS Smartwoods)



Figure 26
Viken Skog BA, Hønefoss, Norway (courtesy of Moelven)



Figure 27
Juwi head office, Wörrstadt, Germany (courtesy of Binderholz)



Figure 28
Werkstatt, Fügen, Austria (courtesy of Binderholz)



Figure 29
Kommissionshalle, Katsch, Austria (courtesy of KLH)

10.3 Hybrid Structures



Figure 30
Parking garage in Innsbruck, Austria (courtesy of KLH)



Figure 31
Residential building in South Carolina, United States (courtesy of Binderholz)



570, boul. St-Jean
Pointe-Claire, QC
Canada H9R 3J9
514 630-4100

www.fpinnovations.ca



Forest Products
Laboratory

1 Gifford Pinchot Drive
Madison, WI
USA 53726
608 231-9200

www.fpl.fs.fed.us



P.O. Box 45029
Ocean Park RPO
Surrey, BC
Canada V4A 9L1
604 536-7730

www.softwoodlumber.org



AMERICAN
WOOD
COUNCIL

222 Catocin Circle SE
Suite 201
Leesburg, VA
USA 20175
202 463-2766

www.awc.org



7011 S 19th Street
Tacoma, WA
USA 98466-5333
253 565-6600

www.apawood.org

WoodWorks



Wood
Products
Council

1111 19th Street NW
Suite 800
Washington, DC
USA 20036
866 966-3448

www.woodworks.org



Forestry Innovation Investment

1130 West Pender Street
Suite 1200
Vancouver, BC
Canada V6E 4A4
604 685-7507

www.bcfii.ca

www.fpinnovations.ca

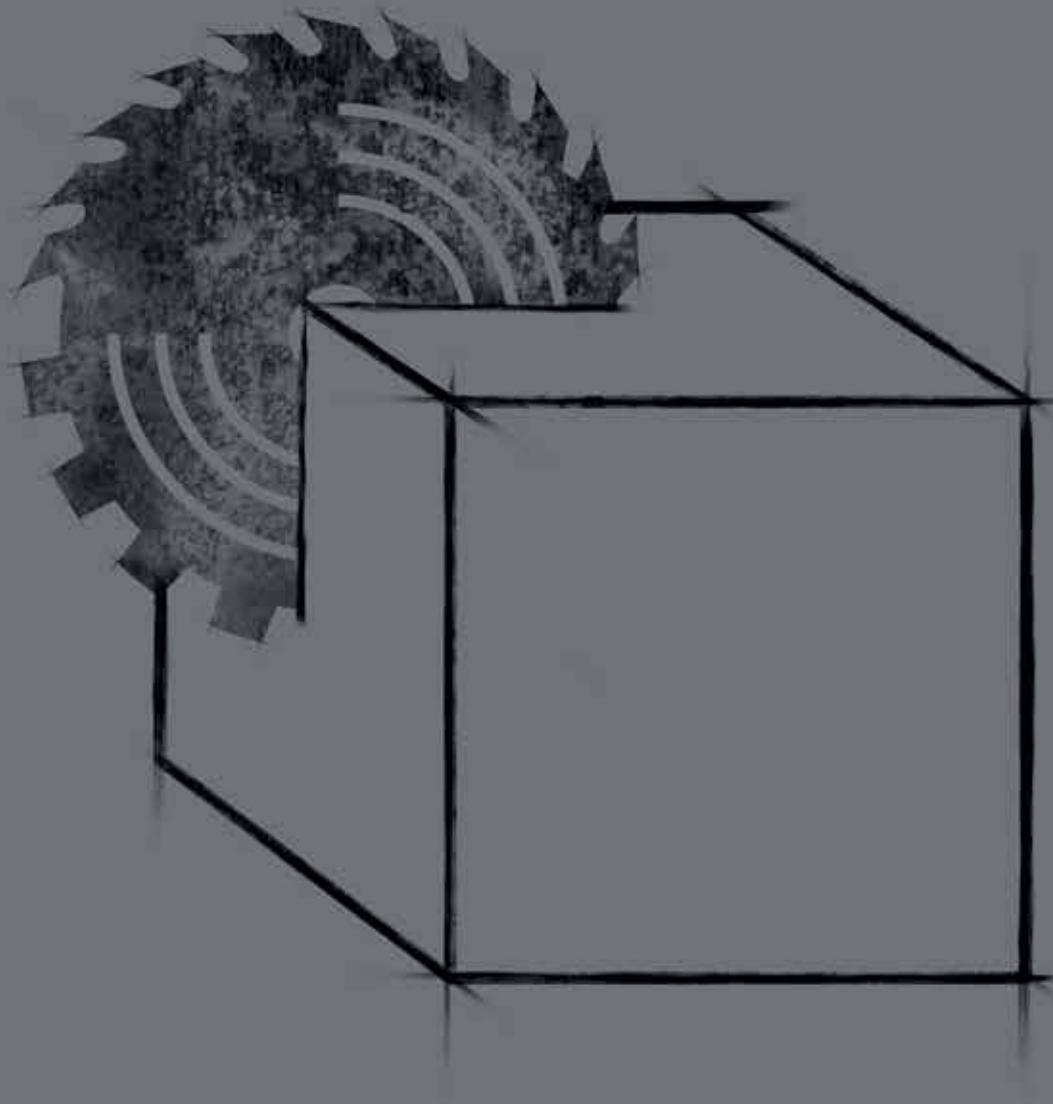

Manufacturing

Cross-laminated timber manufacturing

CHAPTER 2

Authors

Borjen Yeh, Ph.D., P.E., APA
Dave Kretschmann, P.E., USDA Forest Products Laboratory
Brad (Jianhe) Wang, Ph.D., FPIInnovations

Peer Reviewers

Conroy Lum, P.Eng., FPIInnovations
Julie Frappier, Eng., Nordic Engineered Wood
Andre Morf, Structurlam

ACKNOWLEDGEMENTS

The U.S. Edition of the CLT Handbook: *cross-laminated timber* combines the work and knowledge of American, Canadian and European specialists. The handbook is based on the original Canadian Edition of the CLT Handbook: *cross-laminated timber*, that was developed using a series of reports initially prepared by FPInnovations and collaborators to support the introduction of CLT in the North American market. A multi-disciplinary team revised, updated and implemented their know-how and technologies to adapt this document to U.S. standards.

The publication of this handbook was made possible with the special collaboration of the following partners:



The editing partners would also like to express their special thanks to Binational Softwood Lumber Council, Forestry Innovation Investment (FII), Nordic Engineered Wood, Structurlam, and CLT Canada for their financial contribution to studies in support of the introduction of cross-laminated timber products in the United States of America.



© 2013 FPInnovations and Binational Softwood Lumber Council. All rights reserved.

The U.S. Edition of the CLT Handbook: *cross-laminated timber* can be electronically downloaded without charge from the website www.masstimber.com. Additional information can be obtained by visiting the websites of FPInnovations, USFPL, American Wood Council (AWC), APA and U.S. WoodWorks. Hard copies can be obtained through AWC (www.awc.org).

No part of this published Work may be reproduced, published, or transmitted for commercial purposes, in any form or by any means, electronic, mechanical, photocopying, recording or otherwise, whether or not in translated form, without the prior written permission of FPInnovations and Binational Softwood Lumber Council.

The information contained in this Work represents current research results and technical information made available from many sources, including researchers, manufacturers, and design professionals. The information has been reviewed by professionals in wood design including professors, design engineers and architects, and wood product manufacturers. While every reasonable effort has been made to insure the accuracy of the information presented, and special effort has been made to assure that the information reflects the state-of-the-art, none of the above-mentioned parties make any warranty, expressed or implied, or assume any legal liability or responsibility for the use, application of, and/or reference to opinions, findings, conclusions, or recommendations included in this published work, nor assume any responsibility for the accuracy or completeness of the information or its fitness for any particular purpose.

This published Work is designed to provide accurate, authoritative information but is not intended to provide professional advice. It is the responsibility of users to exercise professional knowledge and judgment in the use of the information.

ABSTRACT

This Chapter provides general information about the manufacturing of CLT that may be of interest to the design community. The information contained in this Chapter may also provide guidance to CLT manufacturers in the development of their plant operating specification document.

Typical steps of the CLT manufacturing process are described, and key process variables affecting adhesive bond quality of CLT products are discussed. The manufacturing, qualification, and quality assurance requirements in accordance with the American National Standard for Performance-Rated Cross-Laminated Timber, ANSI/APA PRG 320, are discussed.

TABLE OF CONTENTS

Acknowledgements	ii
Abstract	iii
List of Tables	vi
List of Figures	vi
1 Introduction	1
2 Component Requirements	2
2.1 Laminations	2
2.2 Adhesives	3
2.3 Lamination Joints	4
3 CLT Requirements	5
3.1 Dimensions and Dimensional Tolerances	5
3.2 Stress Classes	5
3.3 Appearance Classification	8
4 CLT Manufacturing Process	9
4.1 Primary Lumber Selection	11
4.1.1 Lumber Moisture Content and Temperature	11
4.1.2 Lumber Characteristics Affecting Adhesive Bond Quality	12
4.2 Lumber Grouping	12
4.3 Lumber Planing	12
4.4 Lumber/Layers Cutting to Length	12
4.5 Adhesive Application	13
4.6 CLT Panel Lay-up	13
4.7 Assembly Pressing	13
4.8 CLT On-line Quality Control, Machining and Cutting	15
4.9 Product Marking, Packaging and Shipping	15

5	Qualification and Quality Assurance	16
5.1	Plant Pre-qualification	16
5.2	CLT Structural Performance Qualification	17
5.3	Process Change Qualification	18
5.4	Quality Assurance	18
5.5	Quality Assurance Tests	19
5.5.1	Delamination Tests	19
5.5.2	Visual Quality of CLT	19
6	Implementation of the Standard	20
7	Conclusions	21
8	References	22

List of Tables

- Table 1* Required characteristic strengths and moduli of elasticity for PRG 320 CLT laminations 6
- Table 2* Allowable design capacities for CLT (for use in the United States) 7
- Table 3* Response to process changes according to ANSI/APA PRG 320 18

List of Figures

- Figure 1* Cross-section of a 5-layer CLT panel 1
- Figure 2* The manufacturing process of CLT products 10
- Figure 3* Lumber shrinkage relief 14
- Figure 4* Block shear (“B”) and delamination (“D”) specimen locations 17

1 INTRODUCTION

Cross-laminated timber (CLT) is defined as a prefabricated solid engineered wood product made of at least three orthogonally bonded layers of solid-sawn lumber or structural composite lumber (SCL) that are laminated by gluing of longitudinal and transverse layers with structural adhesives to form a solid rectangular-shaped, straight, and plane timber intended for roof, floor, or wall applications (see Figure 1). While this engineered wood product has been used in Europe for over 15 years, the production of CLT and design of CLT structural systems have just begun in North America with some manufacturers currently being in production or in the process of product qualification.

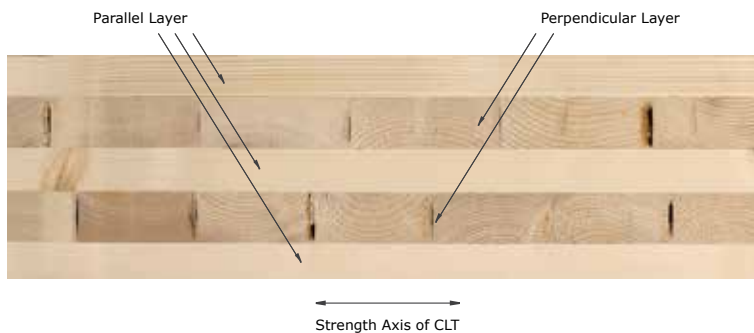

Figure 1
Cross-section of a 5-layer CLT panel

For the acceptance of new construction materials or systems such as CLT in North America, a consensus-based product standard is essential to the designers and regulatory bodies. In recognition of this need, APA – The Engineered Wood Association in the United States and FPInnovations in Canada initiated a joint standard development process in 2010. The intent was to develop a bi-national CLT standard for North America using the consensus standard development process of APA as a standards developer accredited by the American National Standards Institute (ANSI). After 22 months of intensive committee meetings and balloting, the first North American CLT standard was completed as the ANSI/APA PRG 320-2011 *Standard for Performance-Rated Cross-Laminated Timber* [1] in December 2011. This Chapter describes and documents the background information and some key issues that were considered during the development of the ANSI/APA PRG 320 CLT standard.

2

COMPONENT REQUIREMENTS

CLT is manufactured with laminations of dimension lumber or SCL, such as laminated veneer lumber (LVL), laminated strand lumber (LSL), or oriented strand lumber (OSL), which are bonded with structural adhesives through face joints, end joints and/or edge joints. Nail-laminated CLT or other CLT products manufactured without face bonds are outside the scope of the ANSI/APA PRG 320 standard.

Components (lumber/SCL laminations and adhesives) selected for CLT and the manufacturing processes (adhesive application, panel pressing, etc.) need to be carefully considered to ensure a reliable and consistent product. CLT products evaluated for code compliance by a recognized product certification agency or evaluation service as meeting ANSI/APA PRG 320 provide designers with an assurance for product quality and performance.

2.1 Laminations

ANSI/APA PRG 320 utilizes the European experience in engineering theories and manufacturing processes of CLT, and takes into consideration the characteristics of the North American lumber resource, manufacturing preference, and end-use expectations. For example, the standard permits the use of any softwood lumber species or species combinations recognized by the American Lumber Standards Committee (ALSC) under PS 20 [2] or the Canadian Lumber Standards Accreditation Board (CLSAB) under CSA O141 [3] with a minimum specific gravity (SG) of 0.35, as published in the National Design Specification for Wood Construction (NDS) [4] in the United States or the Engineering Design in Wood (CSA O86) [5] in Canada. One advantage of using standard-grade lumber is that such lumber will typically be marked as “HT” (heat treated), meaning that the resulting CLT product will also meet national and international phytosanitary requirements when the traceability (chain-of-custody) requirements of the lumber laminations can be properly demonstrated and certified.

The minimum SG of 0.35 is intended as the lower bound for the CLT connection design since it is the near minimum value of commercially available wood species in North America, Western Woods in the United States and Northern Species in Canada. To avoid differential mechanical and physical properties of lumber, the standard requires the same lumber species or species combinations be used within the same layer of the CLT, while permitting adjacent layers of CLT to be made of different species or species combinations. The standard also permits the use of SCL when qualified in accordance with ASTM D5456 [6]. In reality, however, it is still years away before SCL would be used in CLT production because of apparent challenges in the face bonding of SCL to SCL or SCL to lumber. Due to the thickness variation and surface oxidation or inactivation of SCL, surface planing or sanding may be required for SCL before gluing. Another consideration is its cost competitiveness with lumber. Nonetheless, the advantage of SCL that can be produced in a long and wide billet form is one important factor that the ANSI/APA PRG 320 Committee elected to include SCL in the standard. Other attractive factors also include free of natural defects such as wane, shake, and knots, more uniform stiffness and strength, and greater dimensional stability.

Lumber grades in the parallel layers of CLT are required to be at least 1200f-1.2E MSR or visually graded No. 2, and visually graded No. 3 for perpendicular layers. Remanufactured lumber is permitted as equivalent to solid-sawn lumber when qualified in accordance with ANSI/AITC A190.1 [7] in the United States or SPS 1, 2, 4, or 6 [8,9,10,11] in Canada. Proprietary lumber grades meeting or exceeding the mechanical properties of the lumber grades specified above are permitted provided that they are qualified in accordance with the requirements of an approved agency, which is defined in the standard as an independent inspection agency accredited under ISO/IEC 17020 [12] or an independent testing agency accredited under ISO/IEC 17025 [13] in the United States, or a certification agency accredited under ISO Guide 65 [14] in Canada. This allows for a great flexibility in the utilization of forest resources in North America.

The net lamination thickness for all CLT layers at the time of gluing is required to be at least 5/8 inch (16 mm), but not thicker than 2 inches (51 mm) to facilitate face bonding. In addition, the lamination thickness is not permitted to vary within the same CLT layer except when it is within the lamination thickness tolerances—at the time of face bonding, variations in thickness across the width of a lamination is limited to ± 0.008 inch (0.2 mm) or less, and the variation in thickness along the length of a lamination is limited to ± 0.012 inch (0.3 mm). These maximum tolerances may need to be adjusted during qualification as so to produce acceptable face bond performance.

The net lamination width is required to be at least 1.75 times the lamination thickness for the parallel layers in the major strength direction of the CLT. This means that if 2x lumber (1-3/8 inches or 35 mm in net thickness after surfacing prior to gluing) is used in the parallel layers, the minimum net lamination width must be at least 2.4 inches (61 mm), i.e., 2x3 lumber. On the other hand, the net lamination width is required to be at least 3.5 times the lamination thickness for the perpendicular layers if the laminations in the perpendicular (cross) layers are not edge-bonded, unless the interlaminar shear strength and creep of the CLT are evaluated by testing. This means that if 2x lumber is used in the perpendicular layers, the net lamination width must be at least 4.8 inches (122 mm), i.e., 2x6 lumber.

This minimum lamination width in the perpendicular layers could become a problem for CLT manufacturers who prefer to use 2x3 (net 1-1/2 inches x 2-1/2 inches or 38 mm x 63 mm) or 2x4 (net 1-1/2 inches x 3-1/2 inches or 38 mm x 89 mm) lumber. However, the Committee was concerned about the unbonded edge joints, which could leave gaps as potential stress risers. These, in turn, may reduce the effective interlaminar shear strength and stiffness, and may result in excessive creep. Therefore, in this case, the manufacturers will have to either edge-glue the laminations or demonstrate the conformance to the standard by conducting interlaminar shear tests and ASTM D6815 [15] creep tests. It should be noted that this is an interim measure due to the lack of data at this point in time to address the concerns. As a result, it is expected that this provision will be revisited as more information becomes available.

2.2 Adhesives

Another critical component for CLT is the adhesives. The standard requires that adhesives used for CLT manufacturing meet the requirements of AITC 405 [16] with the exception that the extreme gluebond durability tests in AITC 405 (either ASTM D3434 [17] or CSA O112.9 [18]), which are designed for adhesive qualification in exterior applications, are not required because CLT products manufactured according to ANSI/APA PRG 320 are limited to dry service conditions, such as in most covered structures where the mean equilibrium moisture content (EMC) of solid-sawn lumber is less than 16% (i.e., 65% relative humidity and 68°F or 20°C). CLT products qualified in accordance with the standard are intended to resist the effects of moisture on structural performance as it may occur due to construction delays or other conditions of similar severity.

In Canada, CLT adhesives must meet the requirements of CSA O112.10 [19] and ASTM D7247 heat durability [20], which is part of the requirements in AITC 405. In addition, in both Canada and the United States, CLT adhesives have to be evaluated for heat performance in accordance with PS1 [21]. The intent of

the heat performance evaluation is to determine if an adhesive will exhibit heat delamination characteristics, which may increase the char rate of the CLT when exposed to fire in certain applications. If heat delamination occurs, the CLT manufacturer is expected to consult with the adhesive manufacturer and the approved agency to develop appropriate strategies in product manufacturing and/or end-use recommendations for the CLT fire design [22].

Several types of structural adhesives have been successfully used in CLT production, as listed below:

- Phenolic types such as phenol-resorcinol formaldehyde (PRF);
- Emulsion polymer isocyanate (EPI); and
- One-component polyurethane (PUR).

PRF is a well-known adhesive for structural use which is commonly used for glulam manufacturing in North America. EPI adhesive is used for wood I-joist and lamination. PUR adhesive has been commonly used in Europe to produce CLT. It should be noted that not all formulations within an adhesive type will meet the requirements of the structural adhesive standard and there may be considerable variations in working properties within each adhesive type. Documentation showing that the adhesive has met the appropriate standards is required for CLT product certification. In addition, the working properties of the adhesive needed by the manufacturing process should be discussed with the adhesive supplier.

In addition to cost and working properties, each adhesive type possesses other attributes that may be important. For example, among the three adhesives indicated above, PRF is dark brown whereas EPI and PUR are light-coloured. PUR is manufactured without the addition of solvents or formaldehyde and is moisture reactive. EPI is also free from formaldehyde. Due to the chemical reaction, PUR normally produces slight foaming during hardening.

2.3 Lamination Joints

Adhesive-bonded edge joints between laminations in the same layer of CLT are not required in accordance with ANSI/APA PRG 320 unless CLT's structural and/or fire performance is qualified based on the use of adhesive-bonded edge joints. As previously mentioned, laminations with unbonded edge joints in the perpendicular layers are subject to the minimum width limitation of 3.5 times the lamination thickness, unless the interlaminar shear strength and creep of CLT are evaluated by testing. On the other hand, the end joints within the same lamination, as applicable (e.g., SCL layers may be provided in full width and full length), and the face joints between adjacent laminations must be qualified in accordance with the glulam standard, ANSI/AITC A190.1 in the United States and CSA O177 [23] in Canada, with the exception that the interlaminar shear strength criteria do not apply due to the lower interlaminar shear strength when adjacent laminations are perpendicular. However, these provisions will be reviewed when more plant data are gathered and analyzed in the immediate future.

3

CLT REQUIREMENTS

3.1 Dimensions and Dimensional Tolerances

The CLT thickness is limited to 20 inches (508 mm) or less in ANSI/APA PRG 320. This is considered an upper limit that the CLT may be handled in production and transportation. In addition, dimension tolerances permitted at the time of manufacturing are as follows:

- Thickness: $\pm 1/16$ inch (1.6 mm) or 2% of the CLT thickness, whichever is greater;
- Width: $\pm 1/8$ inch (3.2 mm) of the CLT width; and
- Length: $\pm 1/4$ inch (6.4 mm) of the CLT length.

Textured or other face or edge finishes are permitted to alter the tolerances. However, the designers need to compensate for any loss in cross-section and/or the specified strength due to such alterations.

The standard also specifies the CLT panel squareness, defined as the length of the two panel face diagonals measured between panel corners, to be within $1/8$ inch (3.2 mm) or less. In addition, the CLT panel straightness, defined as the deviation of edges from a straight line between adjacent panel corners, is required to not exceed $1/16$ inch (1.6 mm).

3.2 Stress Classes

As part of the standardization effort, seven CLT stress classes are stipulated in ANSI/APA PRG 320, while custom CLT products are also recognized, provided that the products are qualified by an approved agency in accordance with the qualification and mechanical test requirements specified in the standard. The stress classes are presented in the form of structural capacities, such as bending strength ($F_b S$), bending stiffness (EI), and shear rigidity (GA). This allows for the needed flexibility to CLT manufacturers in conformance with the product standard based on the available material resources and required design capacities.

The stress classes were developed based on the following prescriptive lumber species and grades available in North America:

- E1: 1950f-1.7E Spruce-Pine-Fir MSR lumber in all parallel layers and No. 3 Spruce-Pine-Fir lumber in all perpendicular layers
- E2: 1650f-1.5E Douglas fir-Larch MSR lumber in all parallel layers and No. 3 Douglas fir-Larch lumber in all perpendicular layers
- E3: 1200f-1.2E Eastern Softwoods, Northern Species, or Western Woods MSR lumber in all parallel layers and No. 3 Eastern Softwoods, Northern Species, or Western Woods lumber in all perpendicular layers

- E4: 1950f-1.7E Southern Pine MSR lumber in all parallel layers and No. 3 Southern Pine lumber in all perpendicular layers
- V1: No. 2 Douglas fir-Larch lumber in all parallel layers and No. 3 Douglas fir-Larch lumber in all perpendicular layers
- V2: No. 1/No. 2 Spruce-Pine-Fir lumber in all parallel layers and No. 3 Spruce-Pine-Fir lumber in all perpendicular layers
- V3: No. 2 Southern Pine lumber in all parallel layers and No. 3 Southern Pine lumber in all perpendicular layers

The required characteristic strengths and moduli of elasticity for CLT laminations are listed in Table 1. As seen from the list above, both mechanically graded lumber (for “E” classes) and visually graded lumber (for “V” classes) are included in this standard. Also included are three major species groups in North America, i.e. Douglas fir-Larch, Spruce-Pine-Fir, and Southern Pine. With the published lumber properties in the lay-up, the design capacities of the CLT were derived based on the “shear analogy” method developed in Europe [24] and the following assumptions:

- The modulus of elasticity of lumber in the perpendicular to grain direction, E_{90} , is 1/30 of the modulus of elasticity of lumber in the parallel to grain direction, E_0 ;
- The modulus of shear rigidity of lumber in the parallel to grain direction, G_0 , is 1/16 of the modulus of elasticity of lumber in the parallel to grain direction, E_0 ; and
- The modulus of shear rigidity of lumber in the perpendicular to grain direction, G_{90} , is 1/10 of the modulus of shear rigidity of lumber in the parallel to grain direction, G_0 .

Table 1

Required characteristic strengths and moduli of elasticity^(a) for PRG 320 CLT laminations

CLT Grade	Laminations in the Major Strength Direction of the CLT						Laminations in the Minor Strength Direction of the CLT					
	$f_{b,0}$ (psi)	E_0 (10 ⁶ psi)	$f_{t,0}$ (psi)	$f_{c,0}$ (psi)	$f_{v,0}$ (psi)	$f_{s,0}$ (psi)	$f_{b,90}$ (psi)	E_{90} (10 ⁶ psi)	$f_{t,90}$ (psi)	$f_{c,90}$ (psi)	$f_{v,90}$ (psi)	$f_{s,90}$ (psi)
E1	4,095	1.7	2,885	3,420	425	140	1,050	1.2	525	1,235	425	140
E2	3,465	1.5	2,140	3,230	565	190	1,100	1.4	680	1,470	565	190
E3	2,520	1.2	1,260	2,660	345	115	735	0.9	315	900	345	115
E4	4,095	1.7	2,885	3,420	550	180	1,205	1.4	680	1,565	550	180
V1	1,890	1.6	1,205	2,565	565	190	1,100	1.4	680	1,470	565	190
V2	1,835	1.4	945	2,185	425	140	1,050	1.2	525	1,235	425	140
V3	2,045	1.6	1,155	2,755	550	180	1,205	1.4	680	1,565	550	180

For SI: 1 psi = 6.895 kPa

^(a) The characteristic values may be obtained from the published allowable design values for lumber in the United States as follows:

$f_{b,0} = 2.1 \times$ published allowable bending stress (F_b), $f_{t,0} = 2.1 \times$ published allowable tensile stress (F_t),
 $f_{c,0} = 1.9 \times$ published allowable compressive stress parallel to grain (F_c), $f_{v,0} = 3.15 \times$ published allowable shear stress (F_v),
and $f_{s,0} = 1/3 \times$ calculated $f_{v,0}$.

The design capacities are provided in the format of Allowable Stress Design for the United States, as shown in Table 2. The allowable bending strengths can be readily converted to the characteristic bending strengths (fifth percentile with 75% confidence) by multiplying by an adjustment factor of 2.1. The allowable bending stiffness and shear rigidity are based on the mean values and no adjustments are required.

Table 2

Allowable design capacities^(a,b,c) for CLT (for use in the United States)

CLT Grade	CLT Thickness (in.)	Lamination Thickness in CLT Lay-up (in.)							Major Strength Direction			Minor Strength Direction		
		=	⊥	=	⊥	=	⊥	=	$F_b S_{eff,0}$ (lb.-ft./ft.)	$EI_{eff,0}$ (10 ⁶ lb.-in. ² /ft.)	$GA_{eff,0}$ (10 ⁶ lb./ft.)	$F_b S_{eff,90}$ (lb.-ft./ft.)	$EI_{eff,90}$ (10 ⁶ lb.-in. ² /ft.)	$GA_{eff,90}$ (10 ⁶ lb./ft.)
E1	4 1/8	1 3/8	1 3/8	1 3/8					4,525	115	0.46	160	3.1	0.61
	6 7/8	1 3/8	1 3/8	1 3/8	1 3/8	1 3/8			10,400	440	0.92	1,370	81	1.2
	9 5/8	1 3/8	1 3/8	1 3/8	1 3/8	1 3/8	1 3/8	1 3/8	18,375	1,089	1.4	3,125	309	1.8
E2	4 1/8	1 3/8	1 3/8	1 3/8					3,825	102	0.53	165	3.6	0.56
	6 7/8	1 3/8	1 3/8	1 3/8	1 3/8	1 3/8			8,825	389	1.1	1,430	95	1.1
	9 5/8	1 3/8	1 3/8	1 3/8	1 3/8	1 3/8	1 3/8	1 3/8	15,600	963	1.6	3,275	360	1.7
E3	4 1/8	1 3/8	1 3/8	1 3/8					2,800	81	0.35	110	2.3	0.44
	6 7/8	1 3/8	1 3/8	1 3/8	1 3/8	1 3/8			6,400	311	0.69	955	61	0.87
	9 5/8	1 3/8	1 3/8	1 3/8	1 3/8	1 3/8	1 3/8	1 3/8	11,325	769	1.0	2,180	232	1.3
E4	4 1/8	1 3/8	1 3/8	1 3/8					4,525	115	0.53	180	3.6	0.63
	6 7/8	1 3/8	1 3/8	1 3/8	1 3/8	1 3/8			10,425	441	1.1	1,570	95	1.3
	9 5/8	1 3/8	1 3/8	1 3/8	1 3/8	1 3/8	1 3/8	1 3/8	18,400	1,090	1.6	3,575	360	1.9
V1	4 1/8	1 3/8	1 3/8	1 3/8					2,090	108	0.53	165	3.6	0.59
	6 7/8	1 3/8	1 3/8	1 3/8	1 3/8	1 3/8			4,800	415	1.1	1,430	95	1.2
	9 5/8	1 3/8	1 3/8	1 3/8	1 3/8	1 3/8	1 3/8	1 3/8	8,500	1,027	1.6	3,275	360	1.8
V2	4 1/8	1 3/8	1 3/8	1 3/8					2,030	95	0.46	160	3.1	0.52
	6 7/8	1 3/8	1 3/8	1 3/8	1 3/8	1 3/8			4,675	363	0.91	1,370	81	1.0
	9 5/8	1 3/8	1 3/8	1 3/8	1 3/8	1 3/8	1 3/8	1 3/8	8,275	898	1.4	3,125	309	1.6
V3	4 1/8	1 3/8	1 3/8	1 3/8					2,270	108	0.53	180	3.6	0.59
	6 7/8	1 3/8	1 3/8	1 3/8	1 3/8	1 3/8			5,200	415	1.1	1,570	95	1.2
	9 5/8	1 3/8	1 3/8	1 3/8	1 3/8	1 3/8	1 3/8	1 3/8	9,200	1,027	1.6	3,575	360	1.8

For SI: 1 in. = 25.4 mm; 1 ft. = 304.8 mm; 1 lb. = 4.448 N

- (a) This table represents one of many possibilities that CLT could be manufactured by varying lamination grades, thicknesses, orientations, and layer arrangements in the lay-up.
- (b) Custom CLT grades that are not listed in this table are permitted in accordance with ANSI/APA PRG 320.
- (c) The allowable properties can be converted to the characteristic properties by multiplying the tabulated $F_b S$ by 2.1, and EI and GA by 1.0.

It should be noted that, based on the recent full-scale CLT tests for thicker CLT (depths of 7 layers or more), the standard includes a tentative strength reduction factor of 0.85 for the calculated bending strengths in the major strength direction. It remains unclear at this point if such a factor can be attributed to the volume effect. In general, a shorter span-to-depth ratio is often associated with interlaminar shear failure during flexure. Research is underway to investigate this phenomenon and it will be addressed in the future version of the standard.

Custom CLT classes are permitted in ANSI/APA PRG 320 when accepted by an approved agency in accordance with the qualification and mechanical test requirements specified in the standard. This may include double outer layers or unbalanced lay-ups when clearly identified for installation, as required by the manufacturer and the approved agency. However, the standard requires a unique CLT grade designation be assigned by the approved agency if the custom product represents a significant product volume of the manufacturer to avoid duplication with an existing CLT grade designation that has been assigned to other manufacturers.

3.3 Appearance Classification

There are no mandatory appearance classifications for CLT in ANSI/APA PRG 320. The Committee elected to leave the CLT appearance classifications to be agreed upon between the buyer and seller. However, non-mandatory classifications based largely on selected glulam appearance classifications in ANSI/AITC A190.1 are included in the appendix, which covers the Architectural and Industrial Appearance Classifications. A series of guidelines for the development of a protocol for classifying CLT panels into different appearance classifications based on gaps and checks have been drafted by FPInnovations from research findings [25]. Depending on the market demand, the appearance classifications may be standardized in the future as more CLT products are used in North America.

4 CLT MANUFACTURING PROCESS

CLT panels are manufactured in three or more layers of the same or different thicknesses of dimension lumber or boards in a 90° crisscross pattern. The orthogonal arrangement of layers in CLT adds dimensional stability and two-way action capability to the product. In certain cases, two adjacent layers can be aligned in the same direction to meet certain specifications. Fundamentally, it is possible to produce any CLT thickness by combining thicknesses up to maximum 2 inches (50 mm). As previously mentioned, the final CLT thickness is limited to 20 inches (508 mm) or less in ANSI/APA PRG 320 for practical reasons.

Figure 2 shows schematically the typical CLT manufacturing process, which involves the following nine basic steps:

- 1) Primary lumber selection,
- 2) Lumber grouping,
- 3) Lumber planing,
- 4) Lumber or layers cutting to length,
- 5) Adhesive application,
- 6) CLT panel lay-up,
- 7) Assembly pressing,
- 8) CLT on-line quality control, machining and cutting, and
- 9) Product marking, packaging and shipping.

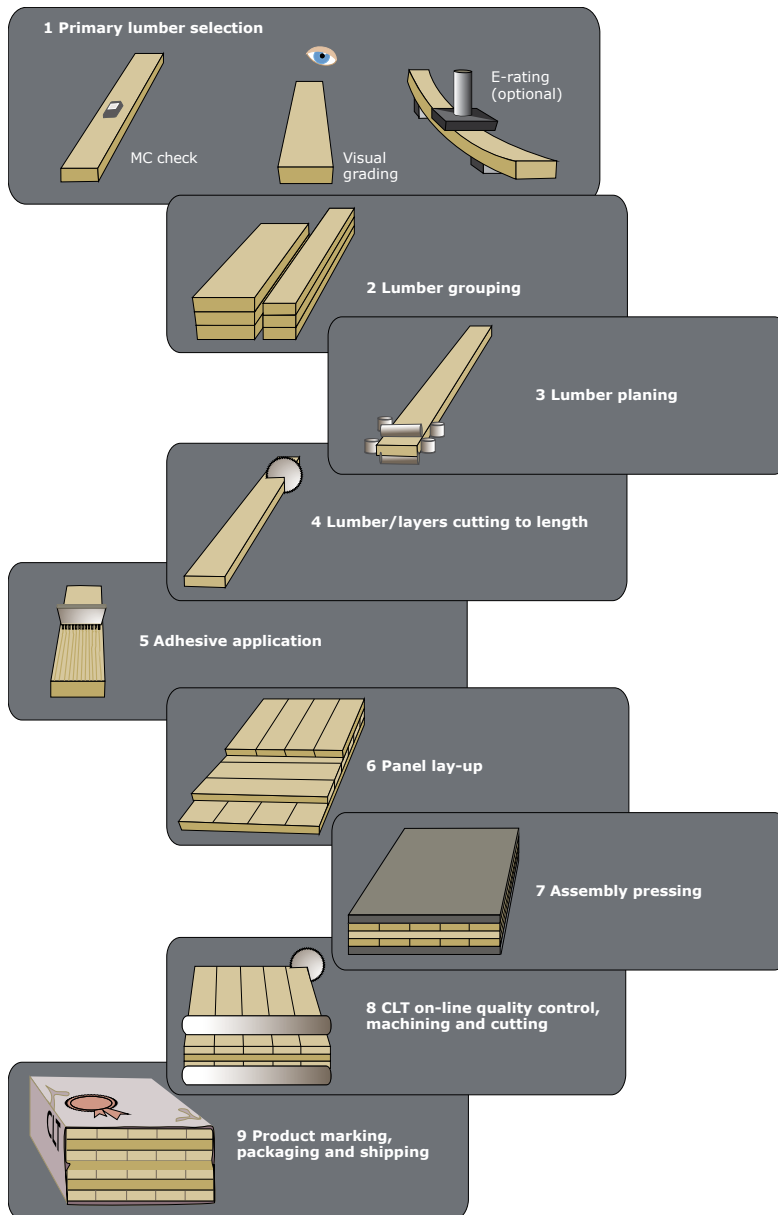

Figure 2
The manufacturing process of CLT products

Each step may include several sub-steps. Step 1 includes lumber moisture content (MC) check and quality control (QC) inspection. Lumber will normally arrive graded to the grades listed in Section 3.2 so the QC step generally involves further visual inspection with or without E-rating. For a CLT plant with an annual capacity below 1 million ft³ (30,000 m³), Step 3 is to plane (or surface) lumber on all four sides before cutting up to length for face-gluing. For a CLT plant with an annual capacity of 1 million ft³ (30,000 m³) or above, Step 3 could involve secondary lumber preparation [26], which has the following three options: lumber end-jointing only, lumber edge-gluing only, and both lumber end-jointing and edge-gluing.

The key to a successful CLT manufacturing process is consistency in the lumber quality and control of the parameters that affect the quality of the adhesive bond. Much of what is described in this section appears in the in-plant manufacturing standard approved by the inspection or certification agency.

4.1 Primary Lumber Selection

In Europe, some manufacturers produce two grades of CLT panels: construction grade and appearance grade. Lumber stock may be selected in accordance to the grade of the CLT panel; for appearance grade CLT, the outermost layer(s) may have specific visual characteristics for aesthetic purposes. Some European manufacturers produce a so-called composite CLT by surface bonding wood composites or engineered wood products, such as oriented strand board (OSB), plywood and LVL, to CLT. This composite CLT is outside the scope of this Chapter.

Most adhesives require that surfaces be planed prior to adhesive application and pressing to ensure a strong and durable bondline. This means that graded lumber, which is usually supplied surfaced on four sides (S4S), will need to be re-planed just prior to bonding. Depending on the amount of wood removed, this may alter the grade of the lumber so a grade verification step may need to be added. While there may be savings in using rough sawn lumber (only planed once, thus resulting in higher fiber recovery), the manufacturing process will more likely have to include a lumber grading step (visual grading with or without E-rating) after planing as the amount of wood removed will be more than when using S4S lumber.

4.1.1 Lumber Moisture Content and Temperature

Packages of kiln dried lumber are usually solid-stacked and dried to a MC of 19% or less at the time of surfacing. The standard MC specification for lumber may not be suitable for all CLT manufacturing processes. Some adhesives are more sensitive to MC than others. It is best to conduct trials with production runs on lumber with representative levels of MC, remembering that MC levels may vary from season to season. Lacking information on the interaction between the manufacturing process and lumber MC, it is recommended that lumber having a MC of $12 \pm 3\%$ be targeted for CLT manufacturing to ensure proper bond quality of the product. If SCL is used, the target MC should be $8 \pm 3\%$ at the time of CLT manufacturing. Another reason for limiting the MC variation is to minimize the development of internal stresses between pieces due to differential shrinkage, which is dependent on differential MC, growth ring orientation and species. It is recommended that the maximum difference in MC between adjacent pieces that are to be joined not exceed 5 percentage points.

The lumber packages should be wrapped and stored in a warehouse to prevent wetting. Storage facilities of sufficient capacity should be available to maintain the required MC and temperature of the lumber. To achieve the target MC, the package must be unpacked, stickered by row to allow air circulation and re-stacked for drying. A hand-held radio-frequency MC meter (capacitance type) or an electrical resistance moisture meter can be used to check the lumber MC. Capacitance-based MC meters with sets of metallic plates placed above and below the lumber to measure the electric capacitance as the lumber passes transversally at line speed can be used in production. Other on-line MC meters using emerging technologies, such as bench-type Near-Infrared (NIR) moisture spectroscopy or a microwave MC sensor may be installed to continuously monitor the MC of lumber pieces as they pass by. Note that the former can only measure the MC on the surface, while the latter allows a deeper penetration of microwave field into the product, leading to a more accurate MC measurement. More research and development is needed to adapt the latter to emerging technologies for on-line measurement of lumber.

Wood temperature will affect the bondline quality and the adhesive manufacturer's recommendations should be followed. The ambient temperature in the manufacturing facility may also have an effect on some process parameters, such as the open assembly time and adhesive curing time. Therefore, it is recommended that the ambient temperature be at least 60°F (15°C). The wood temperature and MC, as well as the ambient temperature in the manufacturing facility, may change throughout the year, which points to the need for a QC program that includes monitoring these parameters. As the effect of temperature and MC on the bondline and panel quality is better understood, revisions can be made to the in-plant manufacturing standard to better allocate monitoring resources.

4.1.2 Lumber Characteristics Affecting Adhesive Bond Quality

In addition to the lumber MC and temperature, there are other lumber characteristics that may affect the quality of the adhesive bond. These either impact on the pressure that is effectively applied to the bondline or simply reduce the available bonding surface. Lumber warp in the form of bow, crook, cup, and twist are examples of the former. Wane is a common example of the latter. Standard grades of framing lumber permit these characteristics to varying degrees. While these limits are acceptable for wood frame construction, some of these characteristics need to be restricted when manufacturing CLT in order to ensure formation of a good bondline.

It is important that the impact of these characteristics, if permitted, be taken into account in the product manufacturing and expected bondline performance. In ANSI/APA PRG 320, for example, this is addressed by grading to achieve an “effective bondline area” of a minimum of 80%. Consider wane, for example. Wane is the presence of bark or a lack of wood at the corner of a square-edged lumber piece. It will reduce the bonding area and concentrate the stresses in a CLT panel. However, wane cannot be ignored because it is a permitted characteristic in all lumber visual grades. The effect of wane can be accommodated by removing pieces with excessive amounts of wane and/or rearranging or reorienting pieces with wane.

4.2 Lumber Grouping

In production, preparation of lumber for the major and minor strength directions of the CLT may follow different steps. In grouping lumber for these two directions, the MC level and visual characteristics of lumber are primary considerations. For E-class CLT products, lumber E-rating is performed for all parallel layers whereas visual grading is performed for all perpendicular layers. For V-class CLT, lumber visual grading is performed for all parallel and perpendicular layers. In general, for the purpose of establishing panel capacities, all lumber in the major strength direction will be required to have the same engineering properties. Similarly, the lumber for the minor strength direction (cross plies) will have a single set of engineering properties. To ensure aesthetic quality, the exposed surfaces of the outermost layers may be of a better visual appearance. In some cases, it may be desirable to place higher quality lumber in designated areas in a panel where fasteners will be installed to maximize the effectiveness of fastening.

4.3 Lumber Planing

Lumber planing (or surfacing) helps activate or “refresh” the wood surface to reduce oxidation for improved gluing effectiveness. Removal of a very thin surface layer ensures better bonding [26]. Lumber planing must achieve the required precision to ensure optimal gluing. In most cases, planing on all four sides is required to ensure dimensional uniformity. However, in some cases, only face and back planing may suffice if the width tolerance is acceptable and lumber edges are not glued. In general, removing 0.1 inch (2.5 mm) from the thickness and 0.15 inch (3.8 mm) from the width is recommended [26]. Due to the inevitable variations in drying efficiency and wood characteristics, it is possible for recently kiln-dried lumber pieces to exhibit higher-than-average MC after planing. If this problem is encountered, steps should be taken to remove and recondition those pieces. The suitability of those pieces for bonding after reconditioning may need to be assessed.

4.4 Lumber/Layers Cutting to Length

A cutting station rips the lumber (or layers if edge-gluing is used) lengthwise for stacking. Transverse layers may be generated from the longitudinal layers by breaking cross-cutting into shorter sections based on the dimensions of the press, if the same grade and size of wood is used for both parallel and perpendicular layers.

4.5 Adhesive Application

In a typical glue application system used in a through-feed process, which is generally seen for PUR and PRF adhesives, the extruder heads move and apply parallel lines/threads of the adhesive in an air tight system with direct supply from an adhesive container. The layers may be lightly wetted with water mist to help the curing reaction when PUR adhesives are used. The production feed speed is generally around 60 – 200 feet/min (18 - 60 m/min).

If the CLT layers are formed in advance, the glue applicator will consist of a series of side-by-side nozzles installed on a beam, and will travel longitudinally over the layers. The typical speed takes about 12 seconds for 50 feet (15 m) long layers [26]. Adhesive application should occur shortly after planing to overcome such issues as surface oxidation, ageing and dimensional instability of the wood, and improve wettability and bonding effectiveness.

The actual adhesive spread rate (or glue spread level) should be checked against that specified by the adhesive manufacturers. The desired rate is affected by the quality of the wood and the application system. The amount of adhesive applied must ensure uniform wetting of the wood surface. Proper spread rate is evidenced by very slight but even squeeze-out along the entire bondline. The adhesive applicator and spread rate are generally adhesive dependent.

The bonding surfaces of surfaced lumber must be clean and free from adhesive-repellent substances such as oils, greases or release agents, which would have a detrimental effect on bond quality. Disruptions in the manufacturing process may be caused by issues related to adhesive application, such as exceeding the maximum allowed assembly time, which may result in adhesive pre-cure. Procedures should be in place to promptly resolve the cause of such disruptions. Such procedures should be included in the in-plant manufacturing standard.

Edge gluing of wood pieces that make up the CLT layers is not a common practice among manufacturers due to the added manufacturing cost. In order for edge-gluing to be effective, edge planing must be done in advance. As a trade-off between cost and improved product performance, edge-gluing of selected layers as needed could be adopted.

4.6 CLT Panel Lay-up

In general, CLT panel lay-up is similar to plywood with adjacent layers aligned perpendicular to each other, the only difference being that each layer of the CLT panel consists of multiple lumber pieces. A minimum “effective bonding area” of 80% is specified in ANSI/AP PRG 320. While there are a number of wood characteristics that may affect the available bond area, the producer is ultimately responsible to find the most effective way of meeting the requirements. In the case of wane, this may be accomplished by orienting wood pieces such that the bark and pith faces of adjacent pieces face up. Doing this also has the advantage of reducing the tendency for the panel to warp.

The assembly time is defined as the time interval between the spreading of the adhesive on the layers and the application of target pressure to the assembly. The manufacturing process and any restart after a temporary disruption should be designed to ensure that the assembly time does not exceed the maximum target set out in the adhesive specification. In some cases, these may need to be more restrictive than the adhesive manufacturer specifications if ambient conditions are not ideal.

4.7 Assembly Pressing

Pressing is a critical step of the CLT manufacture accounting for proper bond development and CLT quality. Two main types of press are used for CLT manufacturing: vacuum press (flexible membrane) and hydraulic press (rigid platen). A vacuum press generates a theoretical maximum clamping pressure of 14.5 psi (0.1 MPa). Such a low

pressure may not be sufficient to suppress the potential warping of layers and overcome their surface irregularities in order to create intimate contact for bonding. To address this deficiency, lumber shrinkage reliefs can be introduced by longitudinally sawing through partial thickness of the lumber to release the stress and in turn reduce the chances of developing cracks when CLT panels lose moisture, as shown in Figure 3. However, the relief kerfs cannot be too wide or too deep because they may reduce the bonding area and affect the panel capacity. It should be noted that the use of lumber shrinkage relief may affect the CLT performance and should be tested as part of the product qualification.



Figure 3
Lumber shrinkage relief

A rigid hydraulic press can generate much higher vertical clamping pressure and side clamping pressure than a vacuum press. To minimize the potential gaps between the lumber pieces in the main layers, application of side clamping pressure in the range of 40 to 80 psi (276 to 550 kPa) is recommended concomitantly with vertical pressing.

A side clamping pressure is sometimes needed to ensure that gaps between laminations in the major strength direction are not too wide. CLT product specifications may have a maximum permitted gap between adjacent laminations in the outer and inner layers. To effectively apply side clamping pressure to the assembly, the length of the cross plies must be less than the total width of the main laminations.

If the CLT layers are formed via edge-gluing in advance, a vertical press without side clamping pressure would suffice. Some vertical presses allow for multiple panels to be pressed simultaneously at high clamping pressures up to 870 psi (6 MPa) [26]. A lateral unloading device is generally used to un-stack multiple CLT panels loaded in a single opening press. The assembly should be pressed within the specified assembly time. Both assembly time (time between when the adhesive is applied and when the target pressure is applied) and pressing time (time under the target pressure) are dependent on the ambient temperature and air humidity. If the assembly time is shorter than the minimum recommended by the adhesive manufacturer, the pressing time may need to be increased to compensate. During pressing, it is recommended that the ambient temperature be higher than 60°F (15°C) because some adhesives may take longer to cure at low temperatures.

Structural cold-set adhesives such as PRF, EPI, and PUR are commonly adopted to avoid having to heat the panels during pressing, or the laminations prior to lay-up. The pressing time required is generally from 10 minutes to several hours depending on the type of adhesive. In general, commercial PRF takes the longest pressing time,

followed by PUR and EPI. To shorten the pressing time, radio frequency (RF) technologies could be applied for CLT manufacturing. It was preliminarily tested that with RF pressing of an EPI bonded 3-ply CLT assembly, the pressing time can be shortened to only about 15 minutes without sacrificing panel bond strength. Also, the adhesive spread rate may be cut by more than 30% off target specification amount. During RF pressing, arcing and burning, as generally seen when pressing with high-alkaline phenol formaldehyde (PF) adhesives, can be avoided. Meanwhile, the moisture in the lumber could redistribute to help partially release internal stress for achieving high panel dimensional stability. However, there is a cost issue associated with an investment and installation of an RF press.

4.8 CLT On-line Quality Control, Machining and Cutting

An industrial sanding machine designed for wood composite products such as plywood may be used to sand one CLT panel at a time to the target thickness with a tolerance of +0.004 inch (0.1 mm). Tighter tolerances may be specified by building project. After sanding, CLT panels are then conveyed to a machining station where a multi-axis numerically-controlled machine cuts out openings for windows and doors, splices and other required parts, as well as proceeds the required machining for connections. Cutting is performed under strictly controlled conditions for maximum accuracy. Minor repairs are carried out manually at this stage of the manufacturing process.

4.9 Product Marking, Packaging and Shipping

Product marking ensures that the correct product is specified, delivered and installed. It is also an important part of product conformity assessment by providing the information to allow designers, contractors and the authority having jurisdiction to check the authenticity of the product. CLT products represented as conforming to the ANSI/APA PRG 320 standard are required to bear the stamp of an approved agency which either inspects the manufacturer or has tested a random sampling of the finished products in the shipment being certified for conformance with the standard.

CLT products represented as conforming to ANSI/APA PRG 320 standard are required to be identified with marks containing the following information:

- (a) CLT grade qualified in accordance with this standard;
- (b) CLT thickness or identification;
- (c) Mill name or identification number;
- (d) Approved agency name or logo;
- (e) Symbol of “ANSI/APA PRG 320” signifying conformance to this standard;
- (f) Any manufacturer’s designations which shall be separated from the grade-marks or trademarks of the approved agency by not less than 6 inches (152 mm); and
- (g) “Top” stamp on the top face of custom CLT panels used for roof or floor if manufactured with an unbalanced lay-up.

Non-custom and other required marks must be placed on standard products at intervals of 8 feet (2.4 m) or less in order that each piece cut from a longer piece will have at least one of each of the required marks. For products manufactured to meet specific job specifications (custom products), the marking may contain information less than that specified for standard CLT products. However, custom products must bear at least one mark containing a required identification. When long CLT products shipped to a job site are to be cut later into several members for use in the structure, the frequency of marking must be applied at intervals of 8 feet (2.4 m) or less.

Additional markings on the panels may show the main direction loading of the panels in the structure and, possibly, the zones designed to receive connectors. Because CLT panels are intended for use under dry service conditions, the panels should be protected from weather during transportation, storage and construction on the job site.

5

QUALIFICATION AND QUALITY ASSURANCE

The ANSI/APA PRG 320 standard also stipulates the requirements for plant pre-qualification, structural performance qualification, and quality assurance.

5.1 Plant Pre-qualification

The plant pre-qualification is intended to ensure the CLT plant is qualified for the manufacturing factors, such as the assembly time, lumber MC, adhesive spread rate, clamping pressure, pressing time and wood surface temperature, prior to the normal production. The plant pre-qualification can be conducted with full-thickness CLT panels of 24 inches (610 mm) or more in the major strength direction and 18 inches (457 mm) or more in the minor strength direction. Two replicated CLT panels are required to be manufactured for pre-qualification for each combination of factors considered. The two replicated CLT panels must not be extracted from a single full-size CLT panel.

The plant pre-qualification includes the evaluation of gluebond (block shear) and durability. Figure 4 shows the locations where the block shear and delamination specimens should be taken for the pre-qualification to ensure the dispersion of the specimens within a sampled CLT qualification panel. Results obtained from the pre-qualification are required to be documented and serve as the basis for manufacturing factors specified in the in-plant manufacturing standard.

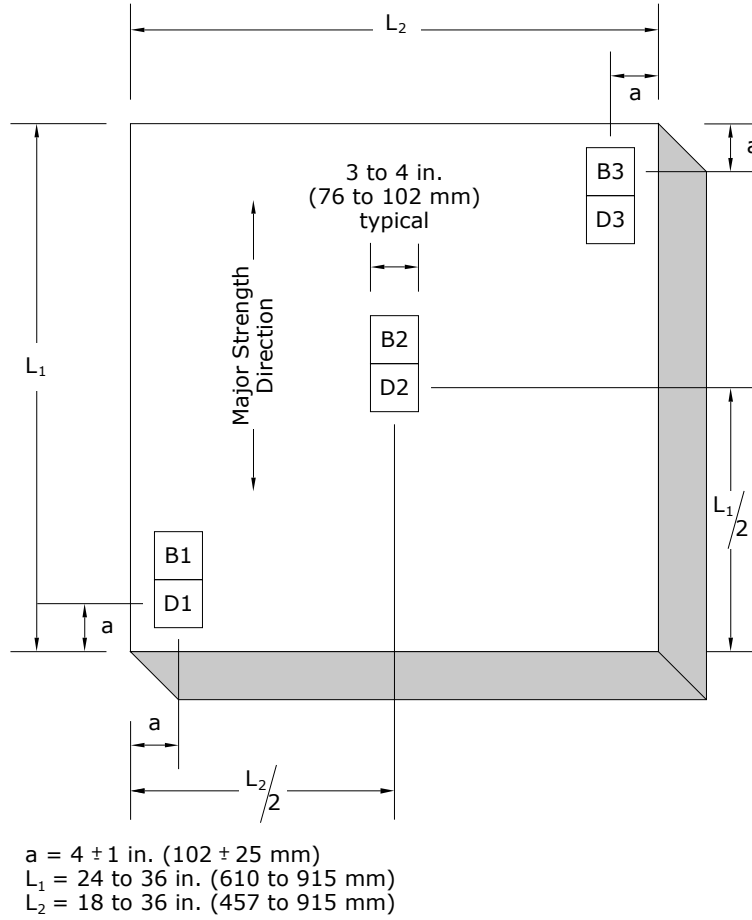

Figure 4
Block shear (“B”) and delamination (“D”) specimen locations

5.2 CLT Structural Performance Qualification

To confirm the major CLT design properties, structural performance tests are required in accordance with ANSI/APA PRG 320. These tests include bending strength, bending stiffness, and interlaminar shear in both major and minor strength directions. The sample size for bending stiffness must be sufficient for estimating the population mean within 5% precision with 75% confidence, or 10 specimens, whichever is greater. The sample size for bending strength and interlaminar shear must be sufficient for estimating the characteristic value with 75% confidence in accordance with ASTM D2915 [27].

The bending tests are required to be conducted flatwise (loads are applied perpendicular to the face layer of CLT) in accordance with the third-point load method of ASTM D198 [28] or ASTM D4761 [29] using the specimen width of not less than 12 inches (305 mm) and the on-center span of approximately 30 times the specimen depth. The Committee considered that a minimum specimen width of 12 inches (305 mm) is necessary to distinguish CLT from typical beam elements. However, it has been reported that, for some CLT lay-ups, the use of the span-to-depth ratio of 30 for bending tests in the minor strength direction may result in excessive deflection before the specimen reaches the peak load. Therefore, it is expected that this provision will be revisited in the near future. The weight of the CLT panel is permitted to be included in the determination of the CLT bending strength.

The interlaminar shear tests are required to be conducted flatwise in accordance with the center-point load method of ASTM D198 or ASTM D4761 using the specimen width of not less than 12 inches (305 mm) and the on-center span of 5 to 6 times the specimen depth. The bearing length must be sufficient to avoid bearing failure, but not greater than the specimen depth. All specimens must be cut to length without overhangs, which are known to increase the interlaminar shear strength in shear tests.

5.3 Process Change Qualification

When process changes occur in production, qualification tests are required, depending on the extent of the changes and their impacts to the CLT performance. ANSI/APA PRG 320 lists some key changes and the required responses, as summarized in Table 3 below:

Table 3
Response to process changes according to ANSI/APA PRG 320

Process Change	Response
Press equipment Adhesive formulation class Addition or substitution of species from a different species group Changes to the visual grading rules that reduce the effective bond area or the effectiveness of the applied pressure (e.g., warp permitted)	Plant pre-qualification and structural re-evaluation
Other changes to the manufacturing process or component quality not listed above Adhesive composition (e.g., fillers and extenders)	Plant pre-qualification
Increase in panel width or length of more than 20%	Structural re-evaluation

5.4 Quality Assurance

Quality assurance is required by ANSI/APA PRG 320 to ensure the CLT product quality through detecting changes in properties that may adversely affect the CLT performance. In this regard, an on-going evaluation of the manufacturing process, including end, face, and edge (if used) joints in laminations, effective bonding area, lamination grade limitations, and the finished production inspection, is required to be conducted by the CLT manufacturer to confirm that the product quality remains in satisfactory compliance to the product specification requirements. The production must be held pending results of the quality assurance testing on representative samples. In addition, the product quality assurance must be audited by an independent inspection or certification agency on a regular basis in accordance with the building code requirements.

As there are a number of process-related issues that would affect the integrity of the bond line, there should be a process in place to qualify a plant to ensure that it has the means to assess and control the quality of the input components and the final product. Industrial mass production of CLT panels requires an in-plant quality control (QC) program.

5.5 Quality Assurance Tests

5.5.1 Delamination Tests

The ANSI/APA PRG 320 standard uses delamination testing as a means to assess quality and moisture durability of the bond line. In the delamination test, a square (or core) specimen obtained from a pre-qualification or production panel is saturated with water and then dried to evaluate the adhesive bond line's ability to resist the wood shrinkage and swelling stresses. The delamination test also assesses somewhat the ability of the adhesive to withstand moisture degradation. In the delamination test, separation in the wood adjacent to the bond line, as opposed to separation in the adhesive, is not considered delamination. The limits on the amount of delamination are based on the glulam standards. However, this provision will be reviewed when more plant data are gathered and analyzed in the immediate future. When all these requirements are met, the manufacturing process is deemed to be producing CLT with bond lines of acceptable quality.

Preliminary tests carried out at FPInnovations suggest that wood failure results from block shear specimens tested under vacuum-pressure-dry conditions could be used to assess the bond quality. For additional information on this topic, refer to the report on block shear testing of CLT [30].

5.5.2 Visual Quality of CLT

Wood shrinkage is not equal in all directions due to the anisotropic nature of wood. As a result, drying checks may develop in CLT panels during storage and use if the MC of the wood at the time of manufacture is significantly different from the equilibrium MC at the ambient conditions. The shrinkage can develop tensile stresses which could exceed the local wood strength perpendicular to the grain causing checks or cracks. Although the checks may partially or fully close if exposed to higher humidity environment, they will reappear when the panel is re-dried.

Checks affect the aesthetic value of the surface, and could thus lower the product's market acceptance. In addition to limiting the MC of the lumber at the time of manufacturing, surface checking can potentially be minimized by using quarter-sawn lumber and by laying up the outer layers in such a way that their growth rings are concave from the bond line. A disadvantage of this arrangement is that it will not help minimize panel warping. As for gaps forming between lumber pieces, this can be minimized or prevented by edge-gluing, but this will likely increase the development of checks.

An exploratory study has been carried out to develop a procedure for quantifying the severity of or potential for checking [25]. The intention is for such tests to provide an indication of the appearance of these CLT products after long-term exposure in service to dry conditions, or the effectiveness of steps taken to minimize checking.

Gaps at the unglued edges of adjacent laminations and checks normally will not have a significant impact on strength properties. However, some of the panel's physical properties, such as thermal conductivity, moisture diffusion and fire performance may be affected. These properties may have an impact on energy performance and durability of the building assembly.

6

IMPLEMENTATION OF THE STANDARD

In North America, a limited number of CLT production lines have been recently commercialized. Several structures have also been constructed using CLT panels manufactured in North America. However, due to the lack of CLT standards in North America, these structures were generally designed and constructed under an engineer seal, and approved by the regulatory body on a case-by-case basis. With the publication of the ANSI/APA PRG 320 standard, it is expected that the acceptance of CLT products will be accelerated, especially as the standard has been approved by the Structural Committee of the International Code Council (ICC) for the 2015 International Building Code (IBC) in the United States to recognize CLT products, when manufactured in accordance with ANSI/APA PRG 320, as an acceptable construction material in compliance with the code. The CSA O86 Committee in Canada is also evaluating the adoption of CLT into the Canadian code.

It should be noted that ANSI/APA PRG 320 is not a CLT design standard and does not address design-specific issues, such as creep, duration of load, volume effect, moisture effect, lateral load resistance, connections, fire, energy, sound, and floor vibration. Design guides for many of those topics are provided in other chapters of this CLT Handbook. In the end, however, the general agreement from the engineered wood products industry is to codify those provisions in a new chapter of the NDS in the United States and CSA O86 in Canada. However, this step is likely to take several years to accomplish due to the need for a significant amount of supporting data in North America.

Fortunately, several research projects have been underway through collaborative efforts by the wood industry, government, and construction, engineering, and research communities under the multi-disciplinary NSERC Strategic Research Network for Engineered Wood-based **Building Systems** (NEWBuildS) in Canada (more information about the activities of NEWBuildS can be found at <http://www.newbuildscanada.ca/>). Built on the knowledge and experience from Europe, it is anticipated that the research results from North America would expedite the completion of the design standards in both the NDS and CSA O86.

In the meantime, ISO Technical Committee (TC) 165 on Timber Structures has also initiated a project to develop an ISO standard for CLT under the leadership of Mr. Kretschmann, of the Forest Products Laboratory of the U.S. Department of Agriculture. This ISO standard is intended to harmonize the CLT standards from North America and Europe as an international standard, which will encourage the use of CLT in building construction globally.

From a product certification perspective, APA as well as other accredited certification agencies in North America can trademark CLT products in accordance with ANSI/APA PRG 320 to provide the designers with construction materials that are consistent in quality and recognized by the building codes. As a result, the designers can focus on the architectural and structural designs without the concern of material supplies and quality. This is a very significant step toward the wide acceptance of the relatively new construction products, such as CLT, in North America.

7 CONCLUSIONS

With the publication of the consensus-based CLT standard, ANSI/APA PRG 320, in North America, the engineered wood products industry has taken a very significant step toward the commercialization of the CLT products and systems. A continuing improvement of the standard can be expected for the next few years as more experience is gathered through the production and commercialization processes. This standard, when adopted into national building codes, will recognize the CLT products as construction materials in compliance with the codes and gain wide acceptance by the design and construction industries.

While, in the short-term, CLT products are expected to be designed by engineers or architects experienced in timber engineering, efforts are underway to develop CLT design handbooks and ultimately design standards that will standardize the design requirements, just like other existing engineered wood products in North America. It is believed that the truly collaborative efforts that have been demonstrated by the wood industry, government, and construction, engineering, and research communities throughout the development of ANSI/APA PRG 320 in the last two years will make this a reality at the shortest time possible.

8

REFERENCES

- [1] APA – The Engineered Wood Association. *Standard for Performance-Rated Cross-Laminated Timber*, ANSI/APA PRG 320. Tacoma, Washington, U.S.A. 2011.
- [2] National Institute of Standards and Technology. *American Softwood Lumber Standard*. Voluntary Product Standard PS 20. Washington D.C., U.S.A. 2010.
- [3] Canadian Standards Association. *Softwood Lumber*. CSA O141. Toronto, Ontario, Canada. 2005.
- [4] American Wood Council. *National Design Specification for Wood Construction*. ANSI/AWC NDS. Leesburg, Virginia, U.S.A. 2012.
- [5] Canadian Standards Association. *Engineering Design in Wood*. CSA O86. Toronto, Ontario, Canada. 2009.
- [6] ASTM International. *Standard Specification for Evaluation of Structural Composite Lumber Products*. ASTM D5456. West Conshohocken, Pennsylvania, U.S.A. 2011.
- [7] American Institute of Timber Construction. *Structural Glued Laminated Timber*. ANSI/AITC A190.1. Centennial, Colorado, U.S.A. 2007.
- [8] National Lumber Grades Authority. *Special Products Standard for Fingerjoined Structural Lumber*. SPS 1. New Westminster, British Columbia, Canada. 2011.
- [9] National Lumber Grades Authority. *Special Products Standard for Machine Graded Lumber*. SPS 2. New Westminster, British Columbia, Canada. 2010.
- [10] National Lumber Grades Authority. *Special Products Standard for Fingerjoined Machine Graded Lumber*. SPS 4. New Westminster, British Columbia, Canada. 2011.
- [11] National Lumber Grades Authority. *Special Products Standard for Structural Face-Glued Lumber*. SPS 6. New Westminster, British Columbia, Canada. 2010.
- [12] ISO. *General Criteria for the Operation of Various Types of Bodies Performing Inspection*. ISO/IEC 17020. Geneva, Switzerland. 1998.
- [13] ISO. *General Requirements for the Competence of Testing and Calibration Laboratories*. ISO/IEC 17025. Geneva, Switzerland. 2005.
- [14] ISO. *General Requirements for Bodies Operating Product Certification Systems*. ISO Guide 65. Geneva, Switzerland. 1996.

- [15] ASTM International. *Standard Specification for Evaluation of Duration of Load and Creep Effects of Wood and Wood-Based Products*. ASTM D6815. West Conshohocken, Pennsylvania, U.S.A. 2009.
- [16] American Institute of Timber Construction. *Standard for Adhesives for Use in Structural Glued Laminated Timber*. AITC 405. Centennial, Colorado, U.S.A. 2008.
- [17] ASTM International. *Standard Test Method for Multiple-Cycle Accelerated Aging Test (Automatic Boil Test) for Exterior Wet Use Wood Adhesives*. ASTM D3434. West Conshohocken, Pennsylvania, U.S.A. 2006.
- [18] Canadian Standards Association. *Evaluation of Adhesives for Structural Wood Products (Exterior Exposure)*. CSA O112.9. Toronto, Ontario, Canada. 2010.
- [19] Canadian Standards Association. *Evaluation of Adhesives for Structural Wood Products (Limited Moisture Exposure)*. CSA O112.10. Toronto, Ontario, Canada. 2008.
- [20] ASTM International. *Standard Test Method for Evaluating the Shear Strength of Adhesive Bonds in Laminated Wood Products at Elevated Temperatures*. ASTM D7247. West Conshohocken, Pennsylvania, U.S.A. 2007.
- [21] National Institute of Standards and Technology. *Structural Plywood*. Voluntary Product Standard PS 1. Washington D.C., U.S.A. 2009.
- [22] Frangi, A., M. Fontana, E. Hugi, and R. Jobstl. *Experimental Analysis of Cross-Laminated Timber Panels in Fire*. *Fire Safety Journal* 44: 1078–108. 2009.
- [23] Canadian Standards Association. *Qualification Code for the Manufacturers of Structural Glued-Laminated Timber*. CSA O177. Toronto, Ontario, Canada. 2006.
- [24] Gagnon, S. and M. Popovski. *Structural Design of Cross-Laminated Timber Elements*. In: Chapter 3, *CLT Handbook*. FPInnovations. Québec, Quebec, Canada. 2011.
- [25] Casilla, R.C., C. Lum, C. Pirvu, and B.J. Wang. *Checking in CLT Panels: An Exploratory Study*. Publication W-2877. FPInnovations. Vancouver, B.C., Canada. 2011.
- [26] Julien, F. *Manufacturing Cross-Laminated Timber (CLT): Technological and Economic Analysis*. Report to Quebec Wood Export Bureau. 201001259-3257AAM. FPInnovations. Québec, Quebec, Canada. 2010.
- [27] ASTM International. *Standard Practice for Sampling and Data-Analysis for Structural Wood and Wood-Based Products*. ASTM D2915. West Conshohocken, Pennsylvania, U.S.A. 2010.
- [28] ASTM International. *Test Methods of Static Tests of Lumber in Structural Sizes*. ASTM D198. West Conshohocken, Pennsylvania, U.S.A. 2009.
- [29] ASTM International. *Standard Test Methods for Mechanical Properties of Lumber and Wood-Based Structural Material*. ASTM D4761. West Conshohocken, Pennsylvania, U.S.A. 2005.
- [30] Casilla, R., C. Pirvu, B. J. Wang, and C. Lum. *Block Shear Testing of CLT Panels - An Exploratory Study*. FPInnovations. Vancouver, B.C., Canada. 2011.
- [31] Gagnon, S. and C. Pirvu, eds. 2011. *CLT Handbook : Cross-laminated timber*. Canadian ed. Special Publication SP-528E. Québec, QC: FPInnovations. 1 v.

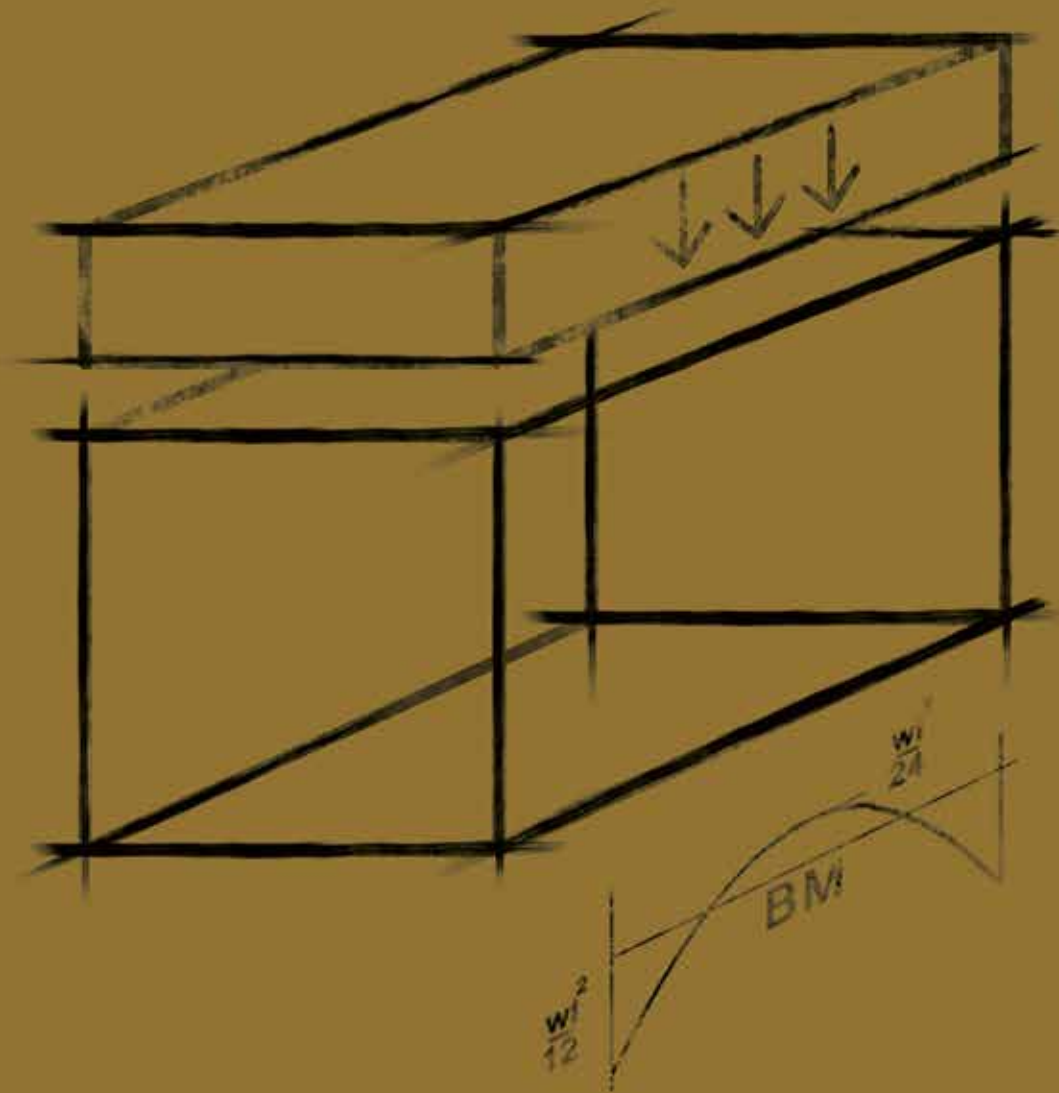

Structural

Structural design of
cross-laminated timber elements

CHAPTER 3

Authors

Loren A. Ross, M.Sc., EIT, American Wood Council
Sylvain Gagnon, Eng., FPInnovations
Edward Keith, M.S., P.E., APA

Peer Reviewers

D. Scott Nyseth, P.E., Stonewood Design
Tom Williamson, P.E., T. Williamson Timber Engineering LLC

ACKNOWLEDGEMENTS

The U.S. Edition of the CLT Handbook: *cross-laminated timber* combines the work and knowledge of American, Canadian and European specialists. The handbook is based on the original Canadian Edition of the CLT Handbook: *cross-laminated timber*, that was developed using a series of reports initially prepared by FPInnovations and collaborators to support the introduction of CLT in the North American market. A multi-disciplinary team revised, updated and implemented their know-how and technologies to adapt this document to U.S. standards.

The publication of this handbook was made possible with the special collaboration of the following partners:



The editing partners would also like to express their special thanks to Binational Softwood Lumber Council, Forestry Innovation Investment (FII), Nordic Engineered Wood, Structurlam, and CLT Canada for their financial contribution to studies in support of the introduction of cross-laminated timber products in the United States of America.



© 2013 FPInnovations and Binational Softwood Lumber Council. All rights reserved.

The U.S. Edition of the CLT Handbook: *cross-laminated timber* can be electronically downloaded without charge from the website www.masstimber.com. Additional information can be obtained by visiting the websites of FPInnovations, USFPL, American Wood Council (AWC), APA and U.S. WoodWorks. Hard copies can be obtained through AWC (www.awc.org).

No part of this published Work may be reproduced, published, or transmitted for commercial purposes, in any form or by any means, electronic, mechanical, photocopying, recording or otherwise, whether or not in translated form, without the prior written permission of FPInnovations and Binational Softwood Lumber Council.

The information contained in this Work represents current research results and technical information made available from many sources, including researchers, manufacturers, and design professionals. The information has been reviewed by professionals in wood design including professors, design engineers and architects, and wood product manufacturers. While every reasonable effort has been made to insure the accuracy of the information presented, and special effort has been made to assure that the information reflects the state-of-the-art, none of the above-mentioned parties make any warranty, expressed or implied, or assume any legal liability or responsibility for the use, application of, and/or reference to opinions, findings, conclusions, or recommendations included in this published work, nor assume any responsibility for the accuracy or completeness of the information or its fitness for any particular purpose.

This published Work is designed to provide accurate, authoritative information but is not intended to provide professional advice. It is the responsibility of users to exercise professional knowledge and judgment in the use of the information.

ABSTRACT

Building using cross-laminated timber (CLT) began in Europe about two decades ago and has used a variety of methods for structural analysis. Experimental testing methods were the most accurate, yet they lacked versatility because changes in lay-up, material, or even manufacturing methods could cause a need for new testing. Consequently, three analytical approaches have been created and are commonly used in Europe as none have been universally accepted to date.

The mechanically jointed beams theory, or Gamma Method, appears in Annex B of Eurocode 5 (EN, 2004). According to this theory, the “Effective Stiffness” concept is introduced and a “Connection Efficiency Factor” (γ_c) is used to account for the shear deformation of the perpendicular layer(s), with $\gamma=1$ representing completely glued member, and $\gamma=0$ no connection at all. This approach provides a closed (exact) solution for the differential equation only for simply supported beams/panels with a sinusoidal load distribution. However, the differences between the exact solution and those for a uniformly distributed load or point loads are minimal and are acceptable for engineering practice (Ceccotti, 2003).

Blass and Fellmoser (2004) have applied the “Composite Theory” (also named K-method) to predict flexural properties of CLT. However, their work did not account for shear deformation in individual layers.

Recently, the “Shear Analogy” method (Kreuzinger, 1999) has been used in Europe and is more applicable for solid panels with cross layers. This methodology takes into account the shear deformation of the longitudinal and the cross layers and is not limited by the number of layers within a panel. This method more accurately predicts the stiffness properties of the CLT panels.

In the United States and Canada, the product standard (*Standard for Performance-Rated Cross-Laminated Timber* - ANSI/APA PRG 320) has adopted the Shear Analogy method to derive composite bending and shear stiffness properties.

The 2012 edition of the National Design Specification (NDS) for Wood Construction does not have specific provisions for CLT; however, the next edition is scheduled to include a chapter on CLT and many of the current provisions will apply. This Chapter of the CLT Handbook is based upon the current provisions of the NDS and the expectations of the future provisions of the NDS.

TABLE OF CONTENTS

Acknowledgements	ii
Abstract	iii
List of Tables	vi
List of Figures	vi
1 Typical Adjustment Factors	1
1.1 Introduction	1
1.2 Load Duration Factor, C_D	2
1.3 Wet Service Factor, C_M	2
1.4 Temperature Factor, C_t	2
2 Design Procedures for CLT Elements	3
2.1 Bending Members	3
2.1.1 Bending Members: Flexure (Out-of-plane)	3
2.1.2 Bending Members: Shear (Out-of-plane)	4
2.1.3 Bending Members: Deflection (Out-of-plane)	4
2.2 Compression Members	5
2.2.1 Solid Columns and Walls	5
2.2.2 Column Stability Factor, C_p	6
2.2.3 Minimum Apparent Bending Stiffness, $EI_{app-min}$	6
2.3 Tension Members	6
2.4 Bending and Axially Loaded Members	7
2.5 Bearing of Members	7
2.5.1 Perpendicular to the Grain	7
2.5.2 Parallel to the Grain	7

3	Modeling CLT Elements	8
3.1	Introduction on Modeling Used in CLT Floor, Roof and Wall Systems and Their Limitations	8
3.2	Mechanical Properties of CLT Elements Used in Floor and Wall Systems	9
3.2.1	Lamination Properties, Lumber Grade, and Moisture Content	9
3.2.2	Rolling Shear Modulus and Shear Deformation	9
3.2.2.1	Rolling Shear Modulus	9
3.2.2.2	Shear Deformation	10
3.3	Shear Analogy Method for CLT Elements	10
3.3.1	General Assumptions and Procedure	10
4	Design Examples	15
4.1	Bending Members	16
4.1.1	Finding EI_{eff}	16
4.1.2	Finding GA_{eff}	16
4.1.3	Finding $F_b S_{\text{eff},0}$ Using the Simplified Method	17
4.1.4	Finding $F_s (I_b/Q)_{\text{eff}}$ Using the Simplified Method	17
4.1.5	Finding EI_{app} for a Uniform Load for a Length of 20 ft., Supported by Pinned Ends	17
4.2	Compression Members	18
4.2.1	Finding $EI_{\text{app-min}}$	18
4.2.2	Finding C_p	18
4.2.3	Checking Column Capacity	18
5	References	19

List of Tables

- Table 1* Applicable adjustment factors **1**
- Table 2* K_s values for various loading conditions **5**
- Table 3* Parallel axis theorem calculations for EI_{eff} **16**
- Table 4* Intermediate calculations for GA_{eff} **16**
- Table 5* Intermediate calculations for $(Ib/Q)_{\text{eff}}$ **17**

List of Figures

- Figure 1* Rolling shear deformation of a 5-layer CLT panel **10**
- Figure 2* Beam modeling using the shear analogy method **11**
- Figure 3* Bending and shear stresses in beam A using the shear analogy method **12**
- Figure 4* Normal and shear stresses in beam B using the shear analogy method **13**
- Figure 5* Final stress distribution obtained from the superposition of the results from beams A and B **13**
- Figure 6* Cross-section of a 5-layer CLT panel **15**

1 TYPICAL ADJUSTMENT FACTORS

1.1 Introduction

Like other wood products, CLT reference design values are adjusted for specific conditions. Several factors used for different design values are listed below. Table 1 shows all the applicable adjustment factors for CLT.

Table 1
Applicable adjustment factors

	ASD only	ASD and LRFD					LRFD only		
		Load Duration Factor	Wet Service Factor	Temperature Factor	Beam Stability Factor	Column Stability Factor	Format Conversion Factor	Resistance Factor	Time Effect Factor
							K_F	ϕ	
$F'_b S_{eff} = F_b S_{eff}$ X	C_D	C_M	C_t	C_L	-	2.54	0.85	λ	
$F'_t A_{parallel} = F_t A_{parallel}$ X	C_D	C_M	C_t	-	-	2.70	0.80	λ	
$F'_v (Ib/Q)_{eff} = F_v (Ib/Q)_{eff}$ X	C_D	C_M	C_t	-	-	2.88	0.75	λ	
$F'_c A_{parallel} = F_c A_{parallel}$ X	C_D	C_M	C_t	-	C_P	2.40	0.90	λ	
$F'_{c\perp} A = F_{c\perp} A$ X	-	C_M	C_t	-	-	1.67	0.90	-	
$EI'_{app} = EI_{app}$ X	-	C_M	C_t	-	-	-	-	-	
$EI'_{app-min} = EI_{app-min}$ X	-	C_M	C_t	-	-	1.76	0.85	-	

1.2 Load Duration Factor, C_D

The load duration factor is applicable only for ASD design methodology. This factor accounts for wood's greater strength over short durations. The load durations are assumed to be the same for CLT products as they are for other wood products and can be found in Table 2.3.2 of the NDS.

1.3 Wet Service Factor, C_M

The wet service factor adjusts the strength properties of the wood in the absence of the assumed dry condition. Dry service conditions are defined for structural glued laminated timber as moisture content less than 16% in service, such as in most covered structures. At the time of manufacturing, PRG 320 requires that the moisture content of the laminations be no more than 15% and further states that the panels are only intended for use in dry service conditions. Contact the manufacturer if a wet service condition is expected.

1.4 Temperature Factor, C_t

The temperature factor adjusts the strength properties of the wood if it will see sustained elevated temperatures above 100°F. This adjustment should be considered for applications when frequent and sustained temperatures above 100°F will occur. Roof systems and other assemblies subject to diurnal temperature fluctuations from solar radiation are not applications that normally require adjustment for temperature (NDS Commentary). Section 2.3.3 of the NDS gives the adjustment factors, which depend on the material property being adjusted and whether it is a wet or dry service condition. It is assumed that these considerations are applicable to CLT as well.

2

DESIGN PROCEDURES FOR CLT ELEMENTS

2.1 Bending Members

The shear analogy method and the simplified method can be used for design of bending members resisting load perpendicular to the plane of the CLT. The shear analogy method has been adopted in the product standard PRG 320 for evaluating bending and shear stiffness. The simplified method for bending strength has also been adopted in the product standard PRG 320.

For members resisting loads in its plane, such as headers or lintels, a different model is needed. Currently, testing is being performed to develop a model to account for the composite action of the CLT.

2.1.1 Bending Members: Flexure (Out-of-plane)

For out-of-plane loads, the beam stability factor should be 1.0. The volume factor is not applicable to CLT.

The simplified method has been adopted in the product standard PRG 320 and calculates the capacity by using an extreme fiber capacity approach. The effective section modulus is found by dividing the effective bending stiffness, found with Equation [24] of this Chapter, by the modulus of elasticity of the outer layer and half the thickness of the panel. In equation form, it is as follows:

$$S_{eff} = \frac{2EI_{eff}}{E_1 h} \quad [1]$$

where:

EI_{eff} = Effective bending stiffness

E_1 = Modulus of elasticity of outermost layer

h = Entire thickness of panel

The effective section modulus is then multiplied by allowable bending stress of the outermost layer and “the calculated moment capacities in the major strength direction are further multiplied by a factor of 0.85 for conservatism” (PRG 320-2011). Manufacturers will have already done this calculation to give the moment capacity of the member. For design, the induced bending moment must be less than the moment capacity. In equation form, it would appear as follows:

$$M_b \leq F'_b S_{eff} \quad [2]$$

where:

M_b = Applied bending moment due to loads

$F_b 'S_{eff}$ = Design bending strength of the panel provided by the manufacturer, calculated, or listed in the product standard PRG 320 and then multiplied by the applicable adjustment factors.

An example of the calculation of the bending moment capacity using the simplified method is given in Section 4.

2.1.2 Bending Members: Shear (Out-of-plane)

Similar to the flexural strength, a simplified method using the extreme fiber capacity is also available and has been proposed for the PRG 320 product standard. Using the simplified method, an effective $(Ib/Q)_{eff}$ can be calculated as follows:

$$(Ib/Q)_{eff} = \frac{EI_{eff}}{\sum_{i=1}^{n/2} E_i h_i z_i} \quad [3]$$

where:

EI_{eff} = Effective bending stiffness

E_i = Modulus of elasticity of an individual layer

h_i = Thickness of an individual layer, except the middle layer, which is half its thickness

z_i = Distance from the centroid of the layer to the neutral axis, except for the middle layer, where it is to the centroid of the top half of that layer.

Manufacturers will likely have already done this calculation to give the shear capacity of the member. In equation form, design would appear as follows:

$$V_{planar} \leq F'_v (Ib/Q)_{eff} \quad [4]$$

where:

V_{planar} = induced shear due to loads

$F'_v (Ib/Q)_{eff}$ = shear strength of the panel provided by the manufacture or calculated per the simplified method multiplied by the applicable adjustment factors.

2.1.3 Bending Members: Deflection (Out-of-plane)

One method to account for the shear deformation is to reduce the effective bending stiffness value, EI_{eff} , to an apparent EI. The derivation of this is done in the discussion of the shear analogy method presented in Section 3. Equation [5] is the final equation that explains how an apparent bending stiffness, EI_{app} , can be calculated by reducing the effective bending stiffness, EI_{eff} . In Equation [5], K_s is a constant based upon the influence of the shear deformation and is solved for various loading conditions in Table 2.

$$EI_{app} = \frac{EI_{eff}}{1 + \frac{K_s EI_{eff}}{GA_{eff} L^2}} \quad [5]$$

Table 2

K_s values for various loading conditions

Loading	End Fixity	K_s
Uniformly distributed	Pinned	11.5
	Fixed	57.6
Concentrated at midspan	Pinned	14.4
	Fixed	57.6
Concentrated at quarter points	Pinned	10.5
Constant moment	Pinned	11.8
Uniformly distributed	Cantilevered	4.8
Concentrated at free-end	Cantilevered	3.6

2.2 Compression Members

2.2.1 Solid Columns and Walls

The column stability factor deserves additional discussion due to its complexity and reliance on other design values. For column and wall design, the load must be less than the adjusted compression strength multiplied by the area of the laminations where the grain is running parallel to the load, or in equation form as follows:

$$P_{parallel} \leq F'_c A_{parallel} \quad [6]$$

where:

$P_{parallel}$ = Load applied parallel to the direction of the fibers

F'_c = Adjusted compression strength

$A_{parallel}$ = Area of layers with fibers running parallel to the direction of the load

2.2.2 Column Stability Factor, C_p

The column stability factor accounts for tendency of a column to buckle. Since CLT is a plate element, buckling only needs to be checked in the out-of-plane direction. Derived from the NDS, the formula for the column stability factor for CLT it is as follows:

$$C_p = \frac{1 + (P_{cE} / P_c^*)}{2c} - \sqrt{\left[\frac{1 + (P_{cE} / P_c^*)}{2c} \right]^2 - \frac{P_{cE} / P_c^*}{c}} \quad [7]$$

where:

P_c = Composite compression design capacity (F_c^*A) where F_c^* is multiplied by all applicable adjustment factors except C_p

c = 0.9 for CLT

P_{cE} = $\frac{\pi^2 EI'_{app-min}}{l_e^2}$ (see Section 2.2.3).

2.2.3 Minimum Apparent Bending Stiffness, $EI_{app-min}$

The apparent bending stiffness, EI_{app} , should be determined using Equation [5]. The following equation can be used to adjust the average EI_{app} to a minimum value, $EI_{app-min}$, for use in column buckling design:

$$EI_{app-min} = 0.5184 EI_{app} \quad [8]$$

2.3 Tension Members

As wood should not be relied upon to resist tension perpendicular to the grain, only the grain parallel to the load should be included as the effective area. The total load has to be less than the adjusted tension strength multiplied by the area of the laminations where the grain is parallel to the load. In equation form,

$$T_{parallel} \leq F'_t A_{parallel} \quad [9]$$

where:

$T_{parallel}$ = Load applied parallel to the direction of the fibers

F'_t = Adjusted tensile strength

$A_{parallel}$ = Area of layers with fibers running parallel to the direction of the load.

2.4 Bending and Axially Loaded Members

For members undergoing both axial compression and flat-wise bending, an equation from chapter 15 of the NDS has been modified from stress inputs to loads for CLT.

$$\left(\frac{P}{F'_c A_{parallel}}\right)^2 + \frac{M + P\Delta\left(1 + 0.234\frac{P}{P_{cE}}\right)}{F'_b S_{eff}\left(1 - \frac{P}{P_{cE}}\right)} \leq 1.0 \quad [10]$$

where:

P = Induced axial load

M = Induced bending moment

Δ = Eccentricity of axial load, measured perpendicular to the plane of the panel

P_{cE} = Critical buckling load (see Section 2.2.2).

2.5 Bearing of Members

2.5.1 Perpendicular to the Grain

The bearing area factor for CLT is 1.0, so is not included in Table 1. The design equation is as follows:

$$P \leq F'_{c\perp} A \quad [11]$$

where:

P = Load applied

$F'_{c\perp}$ = Adjusted compression perpendicular to grain design value.

2.5.2 Parallel to the Grain

For bearing parallel to the grain or with a combination of parallel and perpendicular to grain, such as the bottom of a wall, parallel to the grain will dominate over perpendicular. The design equation is the following:

$$P_{parallel} \leq F_c^* A_{parallel} \quad [12]$$

where:

$P_{parallel}$ = Load applied parallel to the direction of the fibers

F_c^* = Reference compression parallel to grain design value multiplied by all applicable adjustment factors except the column stability factor, C_p

$A_{parallel}$ = Area of layers with fibers running parallel to the direction of the load.

3

MODELING CLT ELEMENTS

3.1 Introduction on Modeling Used in CLT Floor, Roof and Wall Systems and Their Limitations

Different methods have been adopted for the determination of basic mechanical properties of CLT in Europe. Some of these methods are experimental in nature while others are analytical. For floor elements, experimental evaluation involves determination of flexural properties by testing full-size panels or sections of panels with a specific span-to-depth ratio. The problem with the experimental approach is that every time the lay-up, type of material, or any of the manufacturing parameters change, more testing is needed to evaluate the bending properties of such new products. Obviously, the analytical approach, once verified with the test data, offers a more general and less costly alternative. An analytical approach generally predicts strength and stiffness properties of CLT based on the material properties of the laminations that make up the CLT panel.

A common analytical approach that has been adopted for CLT in Europe is based on the “Mechanically Jointed Beams Theory” (also named Gamma Method) that is available in Annex B of Eurocode 5 (EN, 2004). According to this theory, the “Effective Stiffness” concept is introduced and a “Connection Efficiency Factor” (γ_i) is used to account for the shear deformation of the perpendicular layer, with $\gamma=1$ representing completely glued member, and $\gamma=0$ no connection at all. This approach provides a closed- (exact) solution for the differential equation only for simply supported beams/panels with a sinusoidal load distribution. However, the differences between the exact solution and those for uniformly distributed load or point loads are minimal and are acceptable for engineering practice (Ceccotti, 2003).

Blass and Fellmoser (2004) have applied the “Composite Theory” (also named K-method) to predict some design properties of CLT. However, this method does not account for shear deformation in individual layers but is reasonably accurate for high span-to-depth ratios.

Explanations and examples of both of the above methods can be found in the Canadian edition of the CLT Handbook.

Recently, the “Shear Analogy” method (Kreuzinger, 1999) has been developed and is applicable for solid panels with cross layers where the load is perpendicular to the panel. The methodology takes into account the shear deformation of the cross layer and is not limited to a restricted number of layers within a panel. This method seems to be the most accurate and adequate for CLT panels and has been adopted by the product standard (*Standard for Performance-Rated Cross-Laminated Timber* - ANSI/APA PRG 320). It is expected that future editions of the NDS will include CLT and be based upon this method.

Important Note: The proposed design procedures given in this Chapter only apply for cross-laminated timber products manufactured with a gluing process (i.e., face-glued). Therefore, nailed or doweled CLT products are out of the scope of this Chapter.

3.2 Mechanical Properties of CLT Elements Used in Floor and Wall Systems

3.2.1 Lamination Properties, Lumber Grade, and Moisture Content

Usually, thickness of the individual laminations currently produced varies from 5/8 in. (16 mm) to 2 in. (51 mm), with 1 1/2 in. (38 mm) being typical, and the width varies from 3 1/2 in. (89 mm) to 9 1/4 in. (235 mm). Laminations are finger jointed using structural adhesive to achieve long lengths. Laminations are visually or machine stress-rated and must be kiln dried to achieve average moisture content of $12 \pm 3\%$. If structural composite lumber (SCL) is used, its moisture content will be $8 \pm 3\%$.

Basic mechanical properties of the laminations used in CLT elements may vary from one producer to another. However, the ANSI/APA product standard, PRG 320-2011, uses a system where the letter and number designation of the non-custom CLT grade indicates the lamination grading system and minimum properties. An “E” signifies that the parallel laminations are MSR lumber while a “V” signifies visually graded laminations. The number indicates the species and grade. See Chapter 2 entitled *Cross-laminated timber manufacturing* and PRG 320 for more information.

3.2.2 Rolling Shear Modulus and Shear Deformation

3.2.2.1 Rolling Shear Modulus

Rolling shear strength and stiffness in CLT has been identified as a key issue that can control the design and performance of CLT floor and wall systems. Similar to plywood, the laminations oriented crosswise affect the load bearing behavior because of the material's and product's anisotropy (Mestek et al., 2008). Work performed at the University of British Columbia (Bejtka and Lam, 2008) on CLT panels built with Canadian lodgepole pine laminations has confirmed this finding. The magnitude of the effective bending stiffness of the panel and consequently the stress distribution in the layers depend largely on the rolling shear modulus of the cross-wise layers (Fellmoser and Blass, 2004).

The rolling shear modulus will depend on many factors such as species, cross-layer density, lamination thickness, moisture content, sawing pattern configurations (annual rings orientation), size and geometry of the lamination's cross-section, etc. Dynamic and numerical methods have been developed recently in Europe to measure the rolling shear modulus (Steiger et al., 2008).

Likewise, the rolling shear strength will depend on many factors, including lamination size within the CLT layers. Manufacturers select lamination widths for the cross-layers so that the rolling shear should not control the design. The product standard, PRG 320, requires that the laminations of the cross-layer, if not edge bonded, have a net width of 3.5 times the lamination thickness unless testing is done to evaluate the rolling shear strength.

In the product standard, the rolling shear modulus G_R is assumed to be 1/10 of the shear modulus parallel to the grain of the laminations, G_0 (i.e., $G_R \approx G_0/10$). Based on experience and a review of literature, the shear modulus G of wood products is generally assumed to be established between 1/12 and 1/20 of the true modulus of elasticity, i.e., $E_{\text{true}}/G_0 \approx 12$ to 20. For example, for softwood lumber, this ratio may be assumed to be 16, as done in PRG 320. Using this ratio for laminations made of visually graded No. 1/No. 2 SPF sawn lumber with an MOE of 1,400 ksi results in G_0 being about 87.5 ksi and a rolling shear modulus of 8.8 ksi. In this case, the given magnitude of the rolling shear modulus in the literature seems to be on the conservative side. Thus, assuming a rolling shear modulus of 7.5 ksi in all cases, for example SPF, D Fir-L, SP and Hem-Fir lumber, and machine stress-rated (MSR) and visually graded laminations, is conservative. Figure 1 illustrates the rolling shear deformation behavior of a 5-layer CLT cross-section.

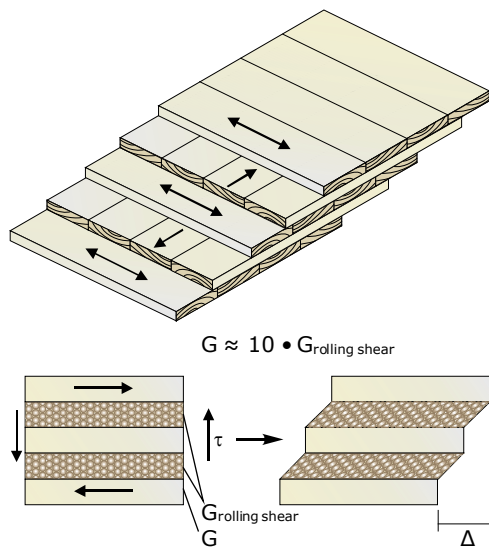

Figure 1
Rolling shear deformation of a 5-layer CLT panel

3.2.2.2 Shear Deformation

Shear deformation for CLT can be larger than for other wood products because of the reduced rolling shear modulus G_R of the cross-lamination layers. The amount of deformation will depend upon the loading, span-to-depth ratio, and end fixity of the panels. For a uniformly-loaded, simply-supported slab with a span-to-depth ratio of 30, the contribution of shear deformation to the total deformation of the panel was about 11% while it was 22% for a slab with a span-to-depth ratio of 20.

3.3 Shear Analogy Method for CLT Elements

During the last decade, various types of analytical models for the evaluation of basic mechanical properties of CLT slab elements have been developed and proposed. This section provides more detailed information about the method adopted by the PRG 320 product standard and the future NDS.

It is important to note that, since CLT panels are a relatively flexible and light building material for slabs resisting out-of-plane loading, the design (e.g., minimum thickness and maximum span) is often more driven by serviceability criteria (e.g., vibration, deflection and creep) than by strength criteria (e.g., bending and shear strength).

3.3.1 General Assumptions and Procedure

The shear analogy method is, according to the literature (Blass and Fellmoser, 2004), the most precise design method for CLT. Tests performed at FPInnovations have confirmed this finding. It is used, with the help of a plane frame analysis program, to consider the different moduli of elasticity and shear moduli of single layers for nearly any system configuration (e.g., number of layers, span-to-depth ratio). The effect of shear deformations is not neglected. In the shear analogy method, the characteristics of a multi-layer cross-section or surface (such as multi-layer CLT panels) are separated into two virtual beams A and B. Beam A is given the sum of the inherent flexural and shear stiffnesses of the individual plies along their own centers, while beam B is given the “Steiner” points, or increased moment of inertia because of the distance from the neutral axis, of the flexural and shear stiffness of the panel. These two beams are coupled with infinitely rigid web members, so that an equal deflection between beams A and B is obtained. By overlaying the bending and shear stiffness (stresses) of both beams, the end result for the entire cross-section can be obtained (Figure 2).

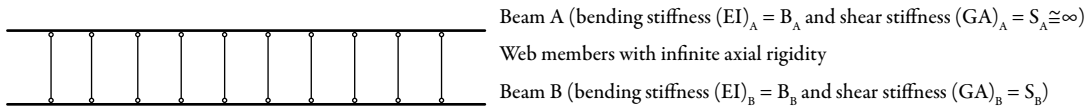

Figure 2
Beam modeling using the shear analogy method

Beam A is assigned a bending stiffness equal to the sum of the inherent bending stiffness of all the individual layers or individual cross-sections as shown in Equation [13].

$$B_A = \sum_{i=1}^n E_i \cdot I_i = \sum_{i=1}^n E_i \cdot b_i \cdot \frac{h_i^3}{12} \quad [13]$$

where:

$$B_A = (EI)_A$$

b_i = Width of each individual layer, usually taken as 1 ft. for CLT panels

h_i = Thickness of each individual layer

The bending stiffness of beam B is calculated using the parallel axis theorem (given as the sum of the Steiner points of all individual layers):

$$B_B = \sum_{i=1}^n E_i \cdot A_i \cdot z_i^2 \quad [14]$$

where B_B is $(EI)_B$ and z_i is the distance between the center point of each layer and the neutral axis.

Additionally, beam B contains the shear stiffness. The shear stiffness of beam B, S_B , is $(GA)_B$ and can be calculated as:

$$\frac{1}{S_B} = \frac{1}{a^2} \cdot \left[\frac{h_1}{2 \cdot G_1 \cdot b_1} + \sum_{i=2}^{n-1} \frac{h_i}{G_i \cdot b_i} + \frac{h_n}{2 \cdot G_n \cdot b_n} \right] \quad [15]$$

In the above equations, the values for E_0 (E parallel to the grain) shall be used for the longitudinal laminations while E_{90} (E perpendicular to the grain) = $E_0/30$ is used for cross laminations. Also, in the same equations, the shear modulus for the longitudinal laminations should be assumed to be G , while that for the cross laminations shall be, for the rolling shear, G_R ($G_R \approx G/10$).

The continuity of deflections between beams A and B ($\Delta_A = \Delta_B$) must be valid at every point. Using a spreadsheet, the virtual section sizes of beams A and B and the values for M_A , M_B , V_A and V_B are produced. Bending moments $M_{A,i}$ and shear forces $V_{A,i}$ of each individual layer of beam A can be obtained using the Equations [16] and [17], respectively.

$$M_{A,i} = \frac{E_i \cdot I_i}{B_A} \cdot M_A \quad [16]$$

$$V_{A,i} = \frac{E_i \cdot I_i}{B_A} \cdot V_A \quad [17]$$

where M_A and V_A are the bending and shear forces on beam A, and B_A is derived from Equation [13].

Bending stresses $\sigma_{A,i}$ and shear stresses $\tau_{A,i}$ of each individual layer of beam A can be obtained using the Equations [18] and [19], respectively.

$$\sigma_{A,i} = \pm \frac{M_{A,i}}{I_i} \cdot \frac{h_i}{2} \quad [18]$$

$$\tau_{A,i} = \frac{E_i \cdot I_i}{B_A} \cdot 1.5 \cdot \frac{V_A}{b \cdot h_i} \quad [19]$$

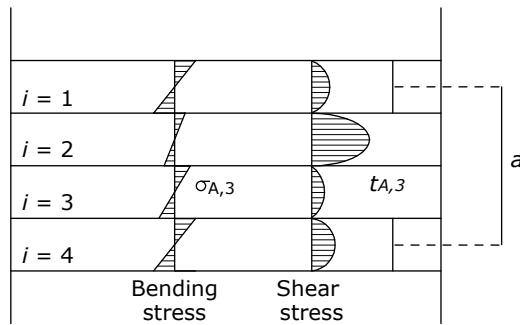

Figure 3

Bending and shear stresses in beam A using the shear analogy method (source: Kreuzinger)

Axial forces $N_{B,i}$, normal stresses $\sigma_{B,i}$ of each individual layer of beam B, and shear stresses at the interface of the two layers of beam B, $\tau_{B,i,i+1}$, can be obtained using the Equations [20], [21] and [22], respectively.

$$N_{B,i} = \frac{E_i \cdot A_i \cdot z_i}{B_B} \cdot M_B \quad [20]$$

$$\sigma_{B,i} = \frac{N_{B,i}}{b_i \cdot h_i} = \frac{E_i \cdot z_i}{B_B} \cdot M_B \quad [21]$$

$$t_{B,i,i+1} = \frac{V_B}{B_B} \cdot \sum_{j=i+1}^n E_j \cdot A_j \cdot z_j \quad [22]$$

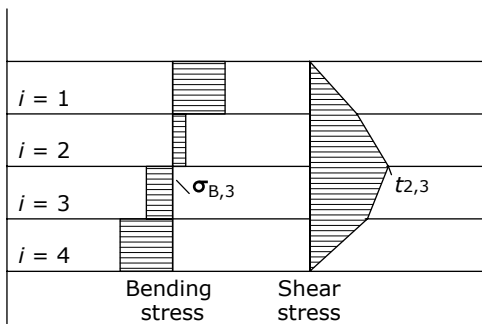

Figure 4

Normal and shear stresses in beam B using the shear analogy method (source: Kreuzinger)

The final stress distribution obtained from the superposition of the results from beams A and B is shown in Figure 5. It should be noted that the shear distribution in Figure 5 includes the influence of the connector devices that will not be existent for a CLT panel.

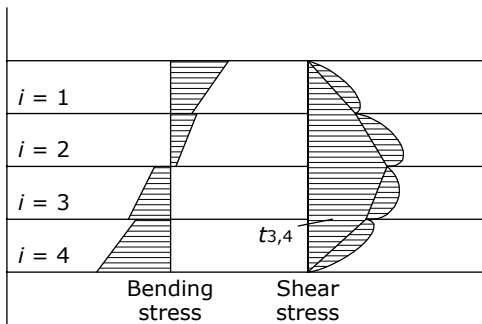

Figure 5

Final stress distribution obtained from the superposition of the results from beams A and B (source: Kreuzinger)

Using the shear analogy method, the maximum deflection Δ_{\max} in the middle of the CLT slab under a uniformly distributed load w can be calculated as a sum of the contribution due to bending and shear:

$$\Delta_{\max} = \frac{5}{384} \cdot \frac{wL^4}{EI_{\text{eff}}} + \frac{1}{8} \cdot \frac{wL^2 k}{GA_{\text{eff}}} \quad [23]$$

where:

EI_{eff} = Effective bending stiffness of composite section

GA_{eff} = Effective shear stiffness of composite section

The effective bending stiffness can be obtained using Equation [24]:

$$EI_{\text{eff}} = \sum_{i=1}^n E_i \cdot b_i \cdot \frac{h_i^3}{12} + \sum_{i=1}^n E_i \cdot A_i \cdot z_i^2 \quad [24]$$

The effective shear stiffness can be obtained using Equation [25]:

$$GA_{eff} = \frac{a^2}{\left[\left(\frac{h_1}{2 \cdot G_1 \cdot b} \right) + \left(\sum_{i=2}^{n-1} \frac{h_i}{G_i \cdot b_i} \right) + \left(\frac{h_n}{2 \cdot G_n \cdot b} \right) \right]} \quad [25]$$

An example of the calculation of the effective true bending stiffness EI_{eff} and effective shear stiffness GA_{eff} using the shear analogy method is given in Section 4.

Since shear deflection can be significant in CLT, its contribution needs to be included. One such method would be to adjust the effective bending stiffness to an apparent bending stiffness. From the 2010 Wood Handbook, the general deflection of a beam, including shear deflection, is the following:

$$\Delta = \frac{k_b wl^3}{EI_{eff}} + \frac{k_s wl}{GA'} \quad [26]$$

where k_b and k_s are constants that depend upon the loading and fixity of the beam and A' is a modified beam area that is $(5/6)bh$ for rectangular cross sections. An EI_{app} can be found if a generic bending deflection equation, $(K_s wl^3)/EI_{app}$, is equated to Equation [26] as shown in the following equation:

$$\frac{k_b wl^3}{EI_{eff}} + \frac{6k_s wl}{5GA_{eff}} = \frac{K_s wl^3}{EI_{app}} \quad [27]$$

The apparent bending stiffness can be found from reducing the effective bending stiffness per the following:

$$EI_{app} = \frac{EI_{eff}}{1 + \frac{K_s EI_{eff}}{GA_{eff} L^2}} \quad [28]$$

where $K_s = (6/5)(k_s/k_b)$ and is solved for several cases in Table 1 of Section 2.1.3.

4

DESIGN EXAMPLES

The main purpose of the following examples is to illustrate the proposed design methods for calculating the basic design properties of cross-laminated timber panels used in North American buildings. Engineers shall be informed that not all the necessary checks are included in each example as some steps may already be calculated by the manufacture or product standard. All examples are based upon the following E1, 5-layer CLT panel (see PRG 320):



Figure 6
Cross-section of a 5-layer CLT panel

For a 5-layer, E1 panel:

h_i = Thickness of an individual layer = 1 3/8 in.

b = Design width = 12 in.

Major strength axis (parallel to grain)

$F_{b,0}$ = Bending strength = 1950 psi

E_0 = Modulus of elasticity = 1.7×10^6 psi

$F_{t,0}$ = Tensile strength = 1375 psi

$F_{c,0}$ = Compression strength = 1800 psi

$F_{v,0}$ = Shear strength = 135 psi

$F_{s,0}$ = Rolling shear strength = 45 psi

Minor strength axis (perpendicular to grain)

$F_{b,90}$ = Bending strength = 500 psi

E_0 = Modulus of elasticity = 1.2×10^6 psi

$F_{v,0}$ = Shear strength = 135 psi

$F_{s,0}$ = Rolling shear strength = 45 psi

4.1 Bending Members

4.1.1 Finding EI_{eff}

Based on Equation [24], a table is used to help in calculating the effective stiffness, EI_{eff} . The width of each layer, b , is assumed to be 12 inches and every layer thickness, h , is assumed to be 1.375 inches for this panel. For layers 2 and 4, which are oriented in the minor strength axis, the E is divided by 30 per PRG 320 to adjust for bending perpendicular to the strong axis.

$$EI_{eff} = \sum_{i=1}^n E_i \cdot b_i \cdot \frac{h_i^3}{12} + \sum_{i=1}^n E_i \cdot A_i \cdot z_i^2 \quad [24]$$

Table 3

Parallel axis theorem calculations for EI_{eff}

Layer	E (x 10 ⁶ psi)	z (in.)	Ebh ³ /12 (lb.-in. ²)	EAz ² (lb.-in. ²)	Sum of Layer
1	1.7	2.75	4.4	212.1	216.5
2	1.2/30=0.04	1.375	0.1	1.2	1.4
3	1.7	0.0	4.4	0.0	4.4
4	0.04	1.375	0.1	1.2	1.4
5	1.7	2.75	4.4	212.1	216.5
				Total	440

4.1.2 Finding GA_{eff}

Equation [25] is used to solve for GA_{eff} . For the shear modulus, PRG 320 assumes that $G = E/16$ and that for the minor strength axis, G should be divided by 10 for rolling shear. A table is used for ease of calculations.

Table 4

Intermediate calculations for GA_{eff}

Layer	G (x 10 ⁶ psi)	h/G/b (x 10 ⁶ psi)
1	1.7/16= 0.10625	1.078
2	1.2/(16 x 10)=0.0075	15.278
3	0.01625	1.078
4	0.0075	15.278
5	0.01625	1.078

$$GA_{eff} = \frac{a^2}{\left[\left(\frac{h_1}{2 \cdot G_1 \cdot b} \right) + \left(\sum_{i=2}^{n-1} \frac{h_i}{G_i \cdot b_i} \right) + \left(\frac{h_n}{2 \cdot G_n \cdot b} \right) \right]} \quad [25]$$

$$GA_{eff} = \frac{5.5^2}{\left[\left(\frac{1.078}{2} \right) + (15.278 + 1.078 + 15.278) + \left(\frac{1.078}{2} \right) \right]} \quad [29]$$

$$GA_{eff} = 0.92 \quad [30]$$

4.1.3 Finding $F_b S_{eff,0}$ Using the Simplified Method

Equation [1] is used to calculate $F_b S_{eff,0}$. The product standard, PRG 320, uses a further reduction “for conservatism” by multiplying by 0.85.

$$S_{eff} = \frac{2EI_{eff}}{E_1 h} = \frac{2 \times 440}{1.7 \times 6.875} = 75.29 \text{ in.}^3 \quad [31]$$

$$F_b S_{eff} = \frac{0.85 \times 1950 \times 75.29}{12} = 10,400 \text{ lb.} - \text{ft.} \quad [32]$$

4.1.4 Finding $F_s (Ib/Q)_{eff}$ Using the Simplified Method

Equation [3] is used to calculate $F_s (Ib/Q)_{eff}$. A table is used to help in making the calculation.

Table 5

Intermediate calculations for $(Ib/Q)_{eff}$

Layer	E ($\times 10^6$ psi)	z (in.)	Ehz
1	1.7	2.750	6.428
2	1.2/30=0.04	1.375	0.076
3	1.7	0.688	1.607
		Sum	8.111

$$(Ib/Q)_{eff} = \frac{EI_{eff}}{\sum_{i=1}^{n/2} E_i h_i z_i} = \frac{440}{8.111} = 54.25 \text{ in.}^2 \quad [33]$$

$$F_s (Ib/Q)_{eff} = 54.25 \times 45 = 2,441 \text{ lb.} \quad [34]$$

4.1.5 Finding EI_{app} for a Uniform Load for a Length of 20 ft., Supported by Pinned Ends

The effective bending stiffness, EI_{eff} is adjusted to an apparent stiffness, EI_{app} , to account for shear deflection. From Table 2, $K_s = 11.5$ in the case of a uniform load with pinned ends is used in Equation [5].

$$EI_{app} = \frac{EI_{eff}}{1 + \frac{K_s EI_{eff}}{GA_{eff} L^2}} = \frac{440}{1 + \frac{11.5 \times 440}{0.92 \times (20 \times 12)^2}} = 402 \text{ lb.} - \text{in.}^2 \quad [35]$$

4.2 Compression Members

For a 10 ft. tall wall resisting 75 kips per ft. of floor live load in the major strength direction, determine if the CLT above is adequate using ASD. Wet service and temperature factors are 1.0.

4.2.1 Finding $EI_{app-min}$

EI_{app} for a constant moment, pinned end condition is determined. From Table 2, $K_s = 11.8$ for this condition.

$$EI_{app} = \frac{EI_{eff}}{1 + \frac{K_s EI_{eff}}{GA_{eff} L^2}} = \frac{440}{1 + \frac{11.8 \times 440}{0.92 \times (20 \times 12)^2}} = 400 \text{ lb.} - \text{in.}^2 \quad [36]$$

This value is then adjusted from an average value to a minimum design value with Equation [8].

$$EI_{app-min} = 0.5184 EI_{app} = 0.5184 \times 400 = 207 \text{ lb.} - \text{in.}^2 \quad [37]$$

4.2.2 Finding C_p

P_{cE} is calculated as:

$$P_{cE} = \frac{\pi^2 EI'_{app-min}}{l_c^2} = \frac{\pi^2 \times 207 \times 10^6}{(10 \times 12)^2} = 142,000 \text{ lb.} \quad [38]$$

P_c^* is then calculated using the sum of all cross-sectional areas for layers running parallel to the load, or $F_c A_{parallel}$.

$$F_c A_{parallel} = (1800)(1.375)(12)(3) = 89,100 \text{ lb.} \quad [39]$$

Since the wet service, temperature, and load duration factors are 1.0, $P_c^* = F_c A_{parallel}$. Finally, Equation [7] is used to find C_p . Remember that $c=0.9$ for CLT.

$$C_p = \frac{1 + (P_{cE} / P_c^*)}{2c} - \sqrt{\left[\frac{1 + (P_{cE} / P_c^*)}{2c} \right]^2 - \frac{P_{cE} / P_c^*}{c}} \quad [40]$$

$$C_p = \frac{1 + (142,000 / 89,100)}{2(0.9)} - \sqrt{\left[\frac{1 + (142,000 / 89,100)}{2(0.9)} \right]^2 - \frac{(142,000 / 89,100)}{0.9}} = 0.89 \quad [41]$$

4.2.3 Checking Column Capacity

Finally, the compression capacity, $F_c' A_{parallel}$, is calculated using Equation [6]. Since the wet service, temperature, and load duration factors are 1.0, the only adjustment factor that has an effect is C_p , which is 0.89.

$$F_c' A_{parallel} = F_c^* A_{parallel} = F_c C_p A_{parallel} = (1800)(1.375)(12)(3)(0.89) = 79,300 \text{ lb.} \geq 75,000 \text{ lb.} \quad \text{Okay}$$

5

REFERENCES

- American Wood Council (AWC). 2012. *National design specification (NDS) for wood construction*. ANSI/AWC NDS-2012. Leesburg, VA: AWC.
- APA – The Engineered Wood Association. 2011. *Standard for performance-rated cross-laminated timber*. ANSI/APA PRG 320. Tacoma, WA: APA.
- Bejtka, I., and F. Lam. 2008. Cross laminated timber as innovative building material. In *Proceedings of the CSCE Annual Conference, Québec, QC*. Montréal, QC: Canadian Society for Civil Engineering (CSCE). CD-ROM.
- Blass H.J., and P. Fellmoser. 2004. Design of solid wood panels with cross layers. In *Proceedings of the 8th World Conference on Timber Engineering, June 14-17, 2004, Lahti, Finland*, 2:543-548.
- Ceccotti A. 2003. Composite structures. In *Timber Engineering*, ed. S. Thelandersson and H.J. Larsen, chapter 21. West Sussex, England: John Wiley and Sons.
- European Committee for Standardization (CEN). 2004. *Eurocode 5: Design of timber structures. Part 1-1: General – Common rules and rules for buildings*. EN 1995-1-1. Brussels: CEN. 124 p.
- Fellmoser, P., and H.J. Blass. 2004. Influence of rolling shear modulus on strength and stiffness of structural bonded timber elements. In *Proceedings of CIB-W18 Meeting, Edinburgh, United Kingdom*, paper 37-6-5.
- Gagnon, S., and C. Pirvu, eds. 2011. *CLT handbook: Cross-laminated timber*. Canadian ed. Special Publication SP-528E. Québec, QC: FPInnovations. 1 v.
- Kreuzinger H. 1995. Mechanically jointed beams and columns. In *Timber Engineering – STEP 1*, ed. H.J. Blass et al., B11/1-8. Almere, The Netherlands: Centrum Hout.
- _____. 1999. Platten, Scheiben und Schalen – ein Berechnungsmodell für gängige Statikprogramme. *Bauen mit Holz* 1:34-39.
- Mestek, P., H. Kreuzinger, and S. Winter. 2008. Design of cross laminated timber (CLT). Paper presented at the *10th World Conference on Timber Engineering, June 2-5, 2008, Miyazaki, Japan*.
- Steiger, R., A. Gülzow, and D. Gsell. 2008. Non-destructive evaluation of elastic material properties of cross laminated timber (CLT). In *Proceedings of the COST E53 Conference, October 29-30, 2008, Delft, The Netherlands*, p. 171-182.

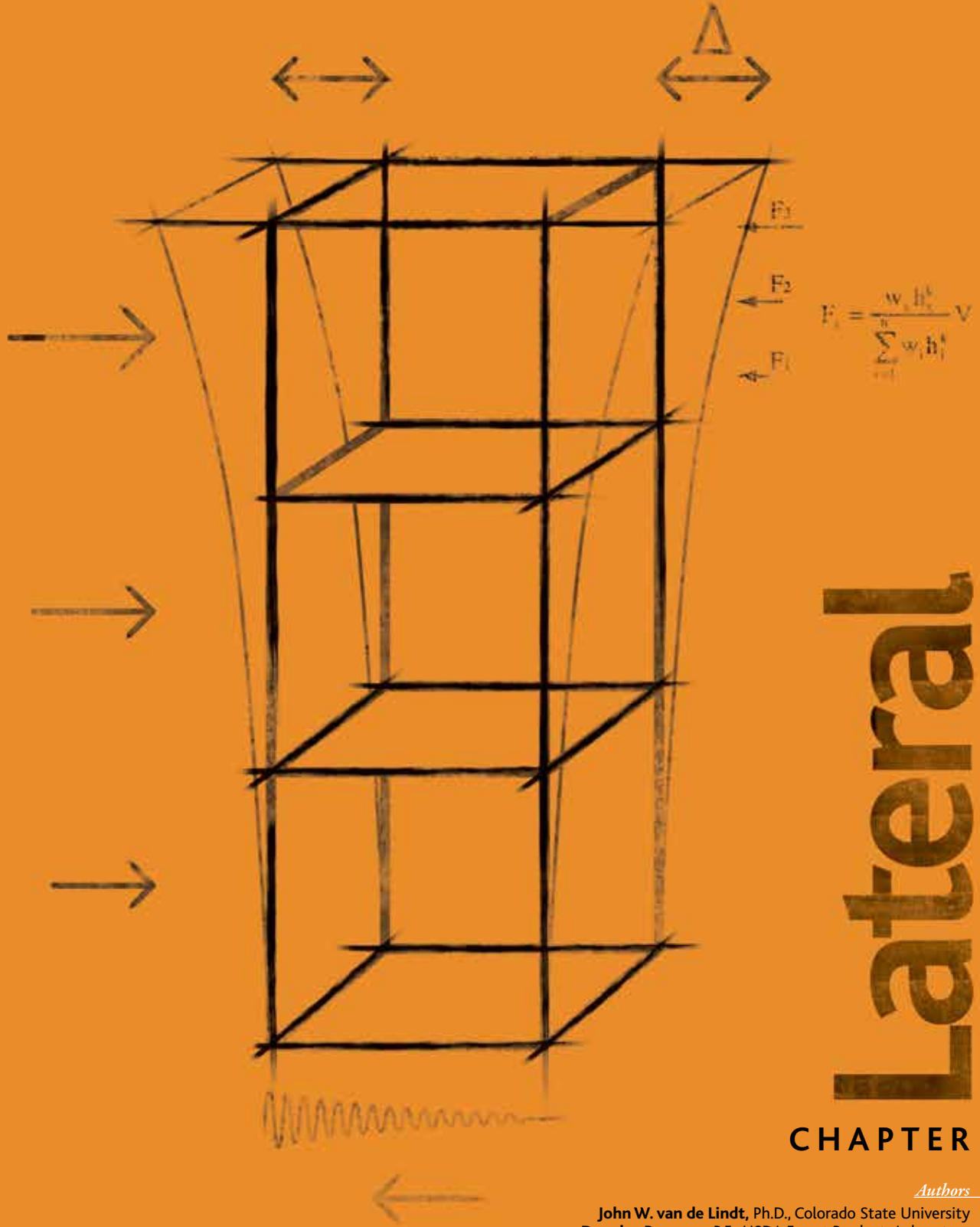

Lateral

Lateral design of
cross-laminated timber buildings

CHAPTER 4

Authors

- John W. van de Lindt, Ph.D., Colorado State University
- Douglas Rammer, P.E., USDA Forest Products Laboratory
- Marjan Popovski, Ph.D., P.Eng., FPInnovations
- Phil Line, P.E., American Wood Council
- Shiling Pei, Ph.D., P.E., South Dakota State University
- Steven E. Pryor, P.E., S.E., Simpson Strong-Tie

Peer Reviewers

- Ronald O. Hamburger, S.E. (CA, IL, UT, WA), P.E. (LA, MN), SECB, Simpson Gumpertz & Heger
- J. Daniel Dolan, Ph.D., P.E., Washington State University
- Erol Karacabeyli, M.A.Sc., P.Eng., FPInnovations
- Bradford Douglas, P.E., American Wood Council
- Thomas D. Skaggs, Ph.D., P.E., APA
- Dr. Ario Ceccotti, Director, IVALS-CNR, Italy

ACKNOWLEDGEMENTS

The U.S. Edition of the CLT Handbook: *cross-laminated timber* combines the work and knowledge of American, Canadian and European specialists. The handbook is based on the original Canadian Edition of the CLT Handbook: *cross-laminated timber*, that was developed using a series of reports initially prepared by FPInnovations and collaborators to support the introduction of CLT in the North American market. A multi-disciplinary team revised, updated and implemented their know-how and technologies to adapt this document to U.S. standards.

The publication of this handbook was made possible with the special collaboration of the following partners:



The editing partners would also like to express their special thanks to Binational Softwood Lumber Council, Forestry Innovation Investment (FII), Nordic Engineered Wood, Structurlam, and CLT Canada for their financial contribution to studies in support of the introduction of cross-laminated timber products in the United States of America.



© 2013 FPInnovations and Binational Softwood Lumber Council. All rights reserved.

The U.S. Edition of the CLT Handbook: *cross-laminated timber* can be electronically downloaded without charge from the website www.masstimber.com. Additional information can be obtained by visiting the websites of FPInnovations, USFPL, American Wood Council (AWC), APA and U.S. WoodWorks. Hard copies can be obtained through AWC (www.awc.org).

No part of this published Work may be reproduced, published, or transmitted for commercial purposes, in any form or by any means, electronic, mechanical, photocopying, recording or otherwise, whether or not in translated form, without the prior written permission of FPInnovations and Binational Softwood Lumber Council.

The information contained in this Work represents current research results and technical information made available from many sources, including researchers, manufacturers, and design professionals. The information has been reviewed by professionals in wood design including professors, design engineers and architects, and wood product manufacturers. While every reasonable effort has been made to insure the accuracy of the information presented, and special effort has been made to assure that the information reflects the state-of-the-art, none of the above-mentioned parties make any warranty, expressed or implied, or assume any legal liability or responsibility for the use, application of, and/or reference to opinions, findings, conclusions, or recommendations included in this published work, nor assume any responsibility for the accuracy or completeness of the information or its fitness for any particular purpose.

This published Work is designed to provide accurate, authoritative information but is not intended to provide professional advice. It is the responsibility of users to exercise professional knowledge and judgment in the use of the information.

ABSTRACT

Cross-laminated timber (CLT) is an innovative wood product that was developed approximately two decades ago in Europe and has since been gaining in popularity. Based on the experience of European researchers and designers, it is believed that CLT can provide the U.S. market the opportunity to build mid- and high-rise wood buildings. This Chapter presents a summary of past research and state-of-the-art understanding of the seismic behavior of CLT. As a new structural system to the United States, the design of CLT for seismic applications is expected to be made through alternative method provisions of the building codes. Efforts to develop seismic design coefficients for use in the equivalent lateral force procedures in the United States are underway. Nonlinear numerical modeling of CLT is presented and used to provide an indication of the effect of designing with different R-factors. Using nominal CLT wall capacity values derived from isolated wall tests, the illustrative example showed that an R-factor of approximately 2 can result in a low probability of collapse (less than 10 percent) at MCE intensity.

TABLE OF CONTENTS

Acknowledgements	ii
Abstract	iii
List of Tables	vi
List of Figures	vi
1	Introduction 1
2	Shear Walls and Diaphragms 3
3	Seismic Design 5
3.1	FEMA P695 Quantification of Building Seismic Performance Factors 5
3.2	FEMA P795 Quantification of Building Seismic Performance Factors: Component Equivalency Methodology 6
3.3	Performance-based Seismic Design 6
4	Literature Review on Lateral Resistance for CLT Design 7
4.1	The SOFIE Project 7
4.2	University of Ljubljana, Slovenia 7
4.3	Karlsruhe Institute of Technology 7
4.4	FPInnovations Study 8
5	Numerical Modeling of CLT 9
5.1	Kinematic Model for CLT Walls 9
5.2	Wall Model Calibration Using Test Data 11
5.3	Typical CLT Wall Configurations 13
5.4	Example CLT Allowable Capacity Table 15
5.5	Model for System Level Performance Simulation 17
6	Summary and Conclusions 19
7	References 20
Appendix A: Literature Review 22	
A1	European and Japanese Experience 22
A1.1	Experimental Studies 22

A2	Canadian Experience	24
A2.1	Experimental Study	24
A2.2	CLT Wall Tests by FPInnovations	25
A2.3	Test Setup	29
A2.4	Test Observations	30
Appendix B: Design Example		45
B1	Performance of a Multi-story CLT Building Designed Using Force-based Design	45

List of Tables

- Table 1* Calibrated connector parameters 13
- Table 2* Example CLT wall design resistance (kips) 15-16
- Table 3* Test matrix for 7.5 feet (2.3 m) long and 7.5 feet (2.3 m) high walls 27
- Table 4* Test matrix for 11.3 feet (3.45 m) long and 7.5 feet (2.3 m) high walls 28
- Table 5* Test matrix for two story assemblies and tall walls 28
- Table 6* Average wall properties obtained from tests 31
- Table 7* Building properties used in the illustrative design examples 45
- Table 8* Number of various length wall segments for each story at each direction 46
- Table 9* Wall design configurations and total length selected to satisfy shear demands 47

List of Figures

- Figure 1* Typical CLT panel, typical CLT construction and a rendering of the 9-story CLT building in England 2
- Figure 2* Typical story of a CLT structure with various connections between the panels 4
- Figure 3* Rocking behavior of a two-panel CLT wall during testing 9
- Figure 4* Kinematic model of a single CLT wall panel 11
- Figure 5* Hysteretic model for CLT connections 12
- Figure 6* Calibrated wall models compared with tests 12
- Figure 7* Typical CLT wall configurations 14
- Figure 8* Simplified system level model for nonlinear time history analysis of CLT buildings 17
- Figure 9* Three-story CLT house tested at NIED Laboratory in Tsukuba, Japan 23
- Figure 10* Seven-story CLT house tested at E-Defense Laboratory in Miki, Japan 24
- Figure 11* Brackets for CLT walls used in the tests 25
- Figure 12* Fasteners used in the test program 26
- Figure 13* Test setup used for CLT walls 30
- Figure 14* Hysteretic behavior for Wall 00 with no vertical load 32

- Figure 15** Hysteretic behavior for Wall 03 with 1370 lb./ft. (20 kN/m) vertical load **33**
- Figure 16** Results from monotonic (dashed line) and cyclic (solid line) tests on CLT walls with Configuration I **33**
- Figure 17** Hysteretic behavior for Wall 04 with annular ring nails **34**
- Figure 18** Failure modes of the bracket connections at late stages of testing for: a) Wall 02 with spiral nails; and b) Wall 04 with annular ring nails **34**
- Figure 19** Hysteretic behavior for Wall 05 using 18 SFS1 screws with D=0.16 in. (4.0 mm) and L=2.7 in. (70 mm) **35**
- Figure 20** Hysteretic behavior for Wall 06 using 10 SFS2 screws with D=0.20 in. (5.0 mm) and L=3.5 in. (90 mm) **36**
- Figure 21** Hysteretic behavior for Wall 08A using brackets and hold-downs **36**
- Figure 22** Behavior of one corner of Wall 08A during testing **37**
- Figure 23** Hysteretic behavior for Wall 10A using timber rivets **38**
- Figure 24** Behavior of Wall 12 using two panels during testing **38**
- Figure 25** Hysteretic behavior for Wall 11 with 0.15 in. (3.8 mm) x 3.5 in. (89 mm) WT-T screws used in the half-lapped joints **39**
- Figure 26** Hysteretic behavior for the two-panel Wall 12 with 0.2 in. (5.0 mm) x 3.5 in. (90 mm) SFS2 screws used in the half-lapped joints under CUREE cycling protocol **40**
- Figure 27** Hysteretic behavior for Wall 14 consisting of one 11.3 ft. (3.45 m) long panel **41**
- Figure 28** Hysteretic behavior for the three-panel Wall 16 where panels were connected with regular 0.2 in. (5.0 mm) x 3.5 in. (90 mm) SFS2 screws **41**
- Figure 29** Hysteretic behavior for the two-panel Wall 12A tested under ISO cycling protocol **42**
- Figure 30** Hysteretic behavior for Wall 22 with WT-T screws **43**
- Figure 31** Bracket failure modes for a) Wall 25 with 40 L=2.56 in. (65 mm) rivets, and b) Wall 27 with 20 L=3.5 in. (90 mm) rivets **44**
- Figure 32** Wall segments (lengths in ft.) allowed for example building floor plans (a) stories 1-5 and (b) story 6 **46**
- Figure 33** Performance of as-designed CLT building under DE level **48**
- Figure 34** Performance of as-designed CLT building under MCE level **48**

1

INTRODUCTION

In Europe, a structural system called cross-laminated timber (CLT) was introduced about 20 years ago as an efficient and environmentally friendly choice for panelized construction in residential and non-residential buildings. Several buildings around the world, primarily in Europe, have been completed, including a nine-story CLT building in London, England (see Figure 1). The current approach used to construct multi-story CLT buildings relies on mechanical connectors (metal brackets and fasteners) to connect the wall and floor panels.

Requirements for the design of CLT for lateral load resistance due to wind and seismic loads are in the early stages of U.S. standardization for eventual recognition by the U.S. model building codes. Design for wind employs use of linear-elastic analysis of wind load effects and values of design resistance for members and connections derived by standard methods. For seismic design, methods for establishing both loads and resistance are more complex and require consideration of nonlinear behavior of the structural system. Lateral design of CLT for both wind and seismic are addressed herein; however, additional information is provided to address seismic loading and response commensurate with the increased complexity of evaluation of seismic performance of the structural system.



Figure 1
Typical CLT panel, typical CLT construction and a rendering of the 9-story CLT building in England

2

SHEAR WALLS AND DIAPHRAGMS

Resistance to lateral loads from wind and earthquakes in CLT structures is made through wall and floor panels designed as shear walls and diaphragms. Unlike typical wood-frame shear wall and diaphragm systems, which have design unit shear strength prescribed based on a specific construction (AWC, 2008), the design shear strength of CLT shear walls and diaphragms is determined directly based on principles of engineering mechanics using provisions of the National Design Specification (NDS) for Wood Construction (AWC, 2012) for connection design (see Chapter 5 entitled *Connections in cross-laminated timber buildings*) and CLT panel design (see Chapter 3 entitled *Structural design of cross-laminated timber elements*). The unit shear strength of the CLT shear wall and CLT diaphragm will vary by factors such as fastener size, spacing, and location as well as the shear strength of the CLT panel itself. Deflection estimates based on principles of engineering mechanics or derived from testing should account for all sources of deflection including panel bending, panel and/or connector shear, and fastener deformation.

Capacity design principles are recommended for design of CLT for seismic resistance to ensure predictable yielding in CLT wall panels and interconnection of CLT elements through fastener yielding, wood crushing, or a combination thereof prior to onset of undesirable brittle wood failure modes. This approach recognizes that wall panel-to-panel and panel-to-floor connections provide the primary source of yielding, while the wood wall panels themselves remain essentially elastic. Special seismic detailing of the CLT seismic force resisting system includes the following:

- a) Fastener Requirements. Fasteners loaded in shear are designed such that the expected fastener yield mode is Mode III or Mode IV as defined in the NDS.
- b) CLT Member Design at Connections. The nominal connection capacity determined in accordance with Item c) is used as the minimum design demand for any wood member limit states.
- c) Nominal Connection Capacity. The nominal connection capacity in shear is determined in accordance with the following:

For dowel type fasteners -- $n \times Z(K_F)(1)(C_M)(C_t)(C_{eg})$ where n is the number of fasteners; Z is the reference lateral design value for a single fastener; and K_F , 1 , C_M , C_t , and C_{eg} are adjustment factors specified in the NDS for format conversion, time effect, wet service, temperature and end grain, respectively.

- d) Fastener Withdrawal. Where a connector relies directly on fastener withdrawal for load resistance, testing shall demonstrate that the fasteners can develop substantial yielding in the connector prior to full fastener withdrawal.

Using the recommended capacity design approach, typical connections at Locations 1 through 4 (see Figure 2) should employ fasteners designed to yield per Mode III or Mode IV. The typical CLT connection locations include:

- 1 - Vertical joints between perpendicular walls
- 2 - Horizontal half-lapped joints between floor panels
- 3 - Connections between floor panels to the walls below
- 4 - Vertical half-lapped joints between wall panels

In addition, the design strength of wood strength limit states at the connection locations should not be less than required to develop the nominal connection capacity (i.e., minimum design demand determined in accordance with Item c). Wood strength limit states include row and group tear out, shear, and tension in accordance with the NDS. Employing the recommended design approach will promote connection designs with larger spacing between fasteners, larger end distances, and use of relatively slender dowel type fasteners in order to ensure fastener yielding prior to onset of brittle wood failure modes.

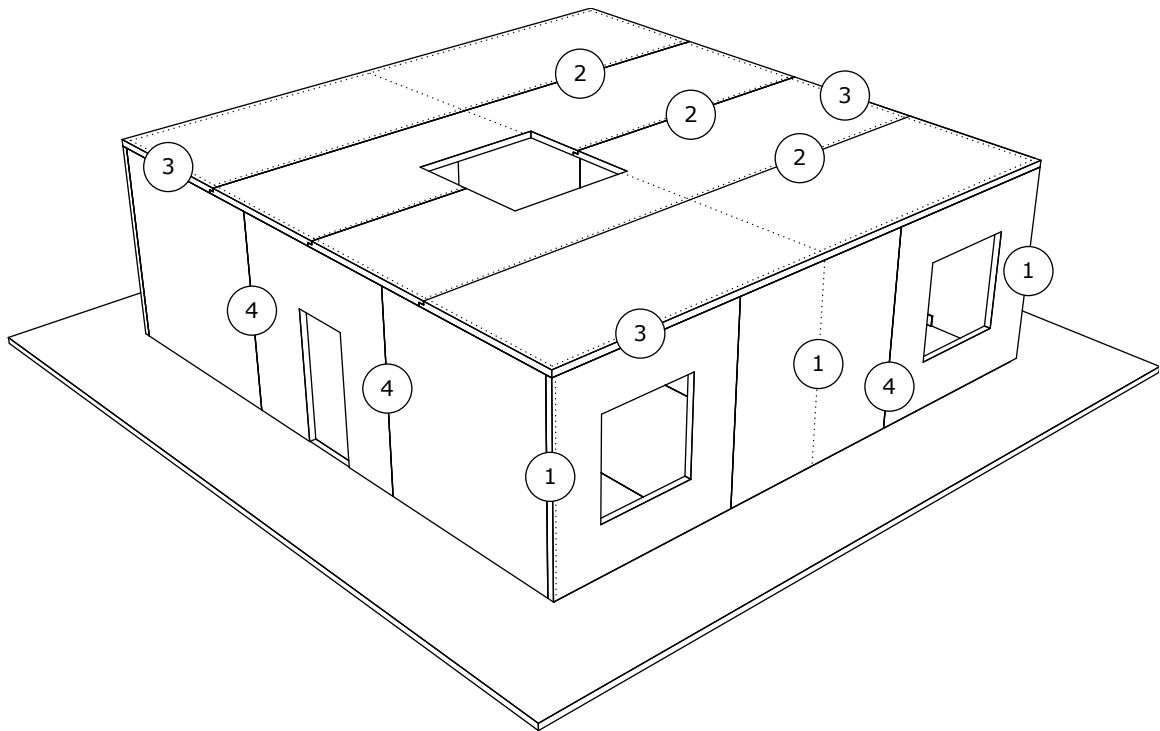

Figure 2

Typical story of a CLT structure with various connections between the panels (drawing courtesy of A. Ceccotti)

While capacity design concepts can be extended to design for wind and will provide for improved performance of the structure in extreme load conditions in the event that overload of the system occurs, it is not required given that the basic design approach for wind is to design for linear elastic response of the structural system.

3

SEISMIC DESIGN

The equivalent lateral force (ELF) procedure is one of the most commonly used analytical procedures for seismic design of buildings in the United States. The procedure relies on system-specific seismic design coefficients, R , C_d , and Ω_o for determination of seismic loads and compliance with associated design requirements. While CLT seismic performance has been evaluated at the wall panel level using reversed-cyclic testing, at the system level using multi-story shake table testing, and numerically via structural modeling, there are no recognized seismic design coefficients for CLT in U.S. design standards or model building codes.

Efforts towards determination of these seismic design coefficients have only recently begun in the United States and a comprehensive evaluation of CLT using FEMA P695 Quantification of Building Seismic Performance Factors for determination of seismic design coefficients has not yet occurred. Until such time that the FEMA P695 evaluation is complete and codes and standards specifically address design of CLT through appropriate seismic design criteria, recognition of CLT use for seismic resistance will be through building code compliance pathways for alternative materials, design and methods of construction.

Expected compliance pathways for recognition of specific CLT designs for seismic resistance include the use of the performance-based design procedures described in ASCE 7-10 Minimum Design Loads for Buildings and Other Structures (ASCE, 2010), or demonstration of equivalence to an existing system in ASCE 7. Guidance for such evaluations can be derived directly from ASCE 7-10, FEMA P695, and FEMA P795 Quantification of Building Seismic Performance Factors: Component Equivalency Methodology. Regardless of the approach taken, information on CLT seismic performance from testing and results from modeling are necessary to guide decisions on the appropriate design of CLT for seismic resistance. The information contained in this Chapter is working toward that goal but does not yet provide a full suite of information to enable a designer to do a performance-based seismic design.

3.1 FEMA P695 Quantification of Building Seismic Performance Factors (FEMA, 2009)

For CLT systems employing CLT wall and floor components as the seismic force resisting system, the primary method for determining seismic design coefficients for eventual recognition in ASCE 7 and the model building codes is expected to be through an evaluation in accordance with the FEMA P695 (2009) methodology. The methodology is designed to establish seismic design coefficients for structural systems to meet the minimum seismic performance objective – less than 10% probability of total or partial collapse given occurrence of Maximum Considered Earthquake (MCE) shaking for Risk Category I and II buildings (ASCE, 2010). The methodology is rigorous and requires evaluation of numerous configurations of a given system to encompass a range of behaviors for that system. The key elements of the methodology include requirements for ground motions, analysis methods, test data, design, and peer review at each step in the process. While a significant portion of the methodology addresses evaluation of numerous configurations, the key elements of

the methodology can also be applied for building specific evaluation of collapse risk to satisfy the minimum seismic performance objective. While still rigorous, the evaluation of a single building on a project-specific basis is considerably less effort than required for determination of broadly applicable seismic design coefficients. For additional information on P695, readers are referred to the full report (FEMA, 2009).

3.2 FEMA P795 Quantification of Building Seismic Performance Factors: Component Equivalency Methodology (FEMA, 2011)

For CLT components such as a CLT wall panel, determination of seismic design coefficients may be made through the application of the FEMA P795 methodology. Procedures of the FEMA P795 methodology do not evaluate compliance with the 10% probability of collapse performance objective of a building's complete seismic force resisting system directly as done in FEMA P695. Instead, a direct comparison of seismic performance of the "proposed" component to a "reference" component of a recognized seismic force resisting system is made to determine whether the proposed component provides equivalent seismic performance. Proposed components found to be equivalent are then judged to be suitable substitutes for components of the reference seismic force resisting system and can therefore utilize seismic design coefficients (SDCs) applicable to the reference seismic force resisting system. Reference components and reference seismic-force-resisting systems are defined by provisions of ASCE 7, the building code, and reference design standards. Key parameters in the evaluation include ultimate deformation, strength, initial stiffness, and ductility. Like the FEMA P695 methodology, peer review is a requirement of the methodology.

The extent to which proposed CLT wall panels can be substituted for a reference component without changing the character of the seismic force resisting system is a consideration under the FEMA P795 methodology. While precise rules do not address the extent of the substitution permissible under the methodology, use of FEMA P795 for recognition of CLT wall panels is expected to be limited. The exclusive use of CLT wall panels in combination with CLT floor panels as part of a CLT building system is considered to be outside of the scope of evaluation per the FEMA P795 methodology. For additional information on P795, readers are referred to the full report (FEMA, 2010).

3.3 Performance-based Seismic Design (ASCE, 2010)

Performance-based seismic design procedures of ASCE 7 may be applied to designs employing CLT for seismic resistance. Under requirements of ASCE 7, the reliability of the proposed component must not be less than that expected for a similar component designed in accordance with the strength procedures of ASCE 7. Requirements for analysis, testing, documentation, and peer review are also included in the procedures. Commentary to these procedures identifies the minimum performance objective for Risk Category I and II structures as 10% probability of total or partial collapse given occurrence of MCE shaking.

4

LITERATURE REVIEW ON LATERAL RESISTANCE FOR CLT DESIGN

Lateral load-response testing of CLT has focused primarily on seismic loading, often reversed cyclic tests or shake table testing of components and, in a few cases, on full structures. Most results can be applied to wind, but again it is stressed that current design for wind load seeks to keep the structural response in the linear-elastic range. More specifically, seismic CLT testing has included both testing of individual wall panels and multi-story shake table testing of both a low-rise and a mid-rise CLT building. A significant amount of component testing and analysis has been conducted in order to better understand CLT behavior when subjected to cyclic loading. Information from these studies will provide a basis for design recommendations for appropriate use of CLT as well as provide supporting information for future implementation of the FEMA P695 methodology. Significant CLT studies are summarized in Appendix A as follows:

4.1 The SOFIE Project

This study included tests on connections, CLT wall panels, and multi-story shake table testing of a 3-story and a 7-story CLT building. In that specific project, it was experimentally demonstrated that the behavior (strength, stiffness) of the panels was heavily dependent on the location and behavior of the connectors.

4.2 University of Ljubljana, Slovenia

This study investigated various boundary conditions in order to develop load versus displacement relationships ranging from cantilever to pure shear wall behavior. The effect of vertical loads and anchorage on the CLT wall behavior was also systematically investigated. The SAP2000 commercial software was used to develop models of 36 different types of walls. Shake table testing to identify overall dynamic properties of CLT sub-assemblies was also part of the project.

4.3 Karlsruhe Institute of Technology

This study included CLT wall panel tests and performance comparison to “traditional” timber-frame construction.

4.4 FPInnovations Study

This CLT wall panel testing program consisted of a total of 32 monotonic and cyclic tests of CLT wall panels in 12 different configurations employing different wall-to-floor, wall-to-wall, and two-story connection details. Appendix A provides a full description of the FPInnovations study that was reproduced, in part, from the Canadian edition of CLT Handbook (2010). Several key observations from the above studies, and particularly the FPInnovations study, are provided below.

General observations of CLT behavior determined from cyclic testing of wall panels and multi-story shake table testing can be summarized as follows:

- a) Connection of the wall panel to the supporting element provides the primary source of yielding, while the wall panels themselves remain essentially elastic. In other words, the wall panel itself behaves almost as a rigid body when racking. Connection yielding (whether from individual fasteners, shear connectors or overturning restraint) provides the primary source of deformation; however, wood failure at connections may occur where fasteners are too closely spaced.
- b) Cyclic in-plane shear behavior of wall panels is not degraded by the presence of axial load. Walls tested with axial load had increased initial stiffness and peak shear capacity. Although not routinely observed in testing to date, toe crushing of the walls should be considered in design.
- c) Significant ductility was observed where boundary conditions allowed rigid body rotation of wall panels. This ductility is achieved through the connectors between the wall panel and floor/ceiling diaphragm.
- d) Failure mechanisms observed in multi-story shake table tests were concentrated in the wall panel connections.

In Appendix A of this Chapter, a greater level of detail is provided for testing undertaken as part of the FPInnovations study. Many of those tests utilized the CUREE cyclic load protocol, which facilitates comparison to other wood systems tested using the CUREE protocol (Krawinkler, 2000). Additionally, the experimental plan focused on the key issue of the connection of the wall panel to supporting elements and influence on cyclic performance. Detailed descriptions of the connectors, fasteners, observations from testing including photographs, and load deformation response for CLT wall panels are provided in Appendix A.

5

NUMERICAL MODELING OF CLT

This section provides a relatively simple but reliable modeling technique for determining the numerical response of CLT building systems. Although complex nonlinear finite element models may also be established for CLT systems (as discussed in the literature review), the method presented herein seeks a balance between model complexity, accuracy, and ease of integration in both research and design practice. The modeling techniques presented in this section were used in performing the example which is included as Appendix B of this Chapter.

5.1 Kinematic Model for CLT Walls

Existing wall test observations indicated that, under lateral loading, the shear deformation of the CLT wall panel itself is insignificant compared to the deformation of panel connections. In other words, lateral displacement of a CLT wall is mainly caused by panels rotating as a rigid body about the corners, as shown in Figure 3. Such rotation of CLT panels installed in between the floor and ceiling panels will be confined by the floor and ceiling diaphragm panels to some degree when compared to isolated wall tests. The rotational behavior has been observed in complete CLT structure lateral loading tests at FPInnovations.



Figure 3
Rocking behavior of a two-panel CLT wall during testing (FPInnovations)

A simplified model was developed and is explained in this Chapter; it can be used to estimate the hysteresis of the wall systems comprised of CLT panels. Designers should be aware that the effect of some of the model assumptions can be significant and are subject to future refinement. The assumptions used to develop this model include:

- CLT wall panels behave as in-plane rigid bodies.
- Under lateral loading, CLT wall panels will rotate individually around the bottom corners to develop lateral displacement at the top of the wall.
- There is no relative lateral slip between the wall and floor (or ceiling) panels.
- The gravity force acts vertically through the center of the CLT wall panels.
- Panel connectors (hold-downs, brackets, etc.) will be deformed during the rocking motion of the wall and develop the hysteresis for the wall panel system.

These kinematic assumptions are shown in Figure 4. Based on free body equilibrium, the lateral resistance of a CLT wall is represented as a scaled summation of the load-slip resistance of all the connectors engaged in the rocking movement of the wall. The scale factor for each connector is a function of their location and the geometry of the panel.

The resistance F at lateral displacement D may be calculated as:

$$F(D) = \sum_{i=1}^n \frac{l_i}{H} f_i(d_i) + \frac{L}{2H} G \quad \text{and} \quad d_i = \frac{l_i}{H} D \quad [1]$$

where L is the panel length; H is the panel height; D is the lateral displacement at top of the wall panel; l_i is the distance of the i^{th} connector to the center of panel rotation; d_i is the deformation of the i^{th} connector under rocking motion; $F(D)$ is the nonlinear wall resistance force as function of D ; $f_i(d_i)$ is the nonlinear force function of the i^{th} connector as function of its deformation d_i .

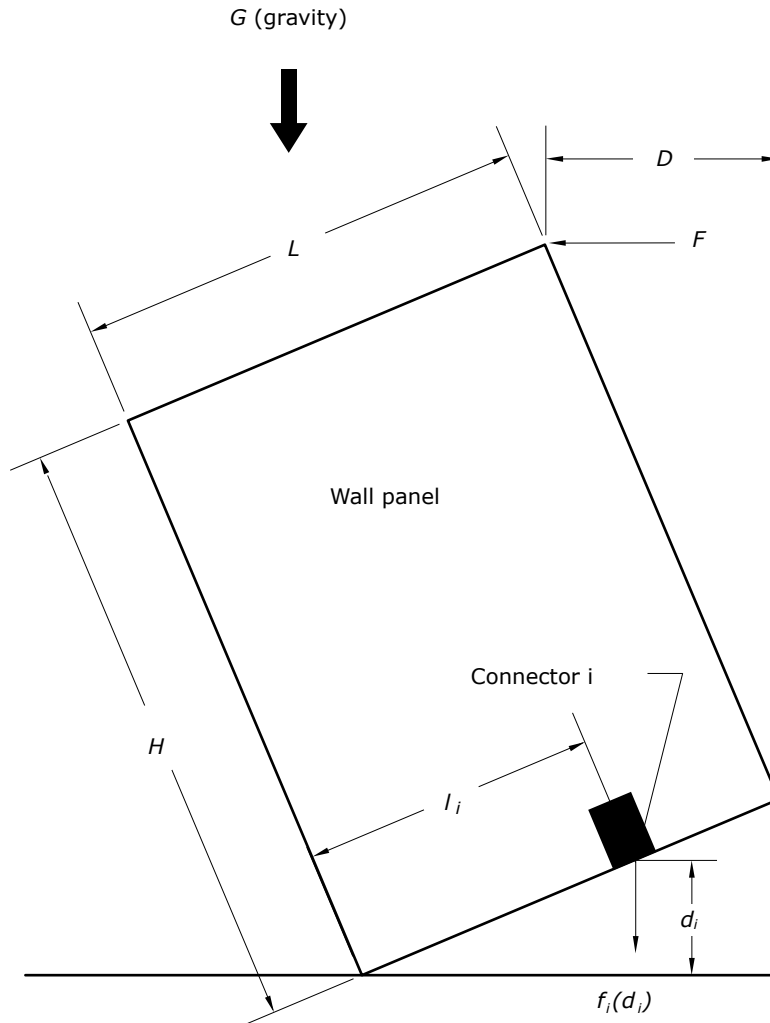

Figure 4
Kinematic model of a single CLT wall panel

The simplified kinematic assumptions in the model result in several limitations, including:

- (1) The model is only valid up to a certain story drift level due to small angle approximation; and
- (2) The length of the wall panel needs to be short enough that the assumed rotation in the model is valid (panels with large length to height ratios will not be able to rotate as assumed in the model).

The lateral response predicted by the model using the calibrated connector hysteretic parameters was felt to be accurate compared to the FPInnovations experimental results.

5.2 Wall Model Calibration Using Test Data

While the kinematic model provided a simplified means to calculate CLT wall lateral resistance, the load-slip resistance of inter-panel connectors between the wall and floor/ceiling is needed to generate wall responses. Such load-slip resistance curves can be obtained through connection tests or other means deemed acceptable for modeling purposes. In the development of this Chapter, the panel hardware connectors were back-calibrated from the FPInnovations CLT wall tests (Popovski, 2010).

The connector hysteresis was assumed to follow the CUREE 10-parameter hysteretic model, which has been widely adopted for wood frame shear wall and wood connection modeling. The behavior of the model and each control parameter are shown in Figure 5.

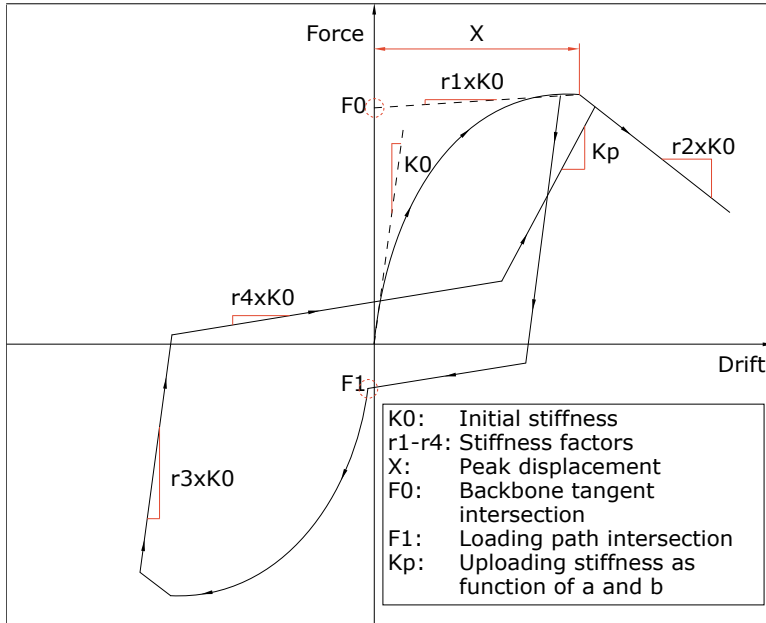

Figure 5
Hysteretic model for CLT connections

The reverse calibration procedure to find the connection parameters was conducted as follows:

- (1) Numerically model the CLT experimental data for each wall with trial connection parameters.
- (2) Subject the numerical wall models to the same displacement protocols used in the experimental tests.
- (3) Compare the model backbone (monotonic) or hysteresis (cyclic) with experimental measurements.
- (4) Adjust the connection parameters to improve model accuracy.
- (5) Repeat Steps 2-4 until the model closely matched the observed experimental response.

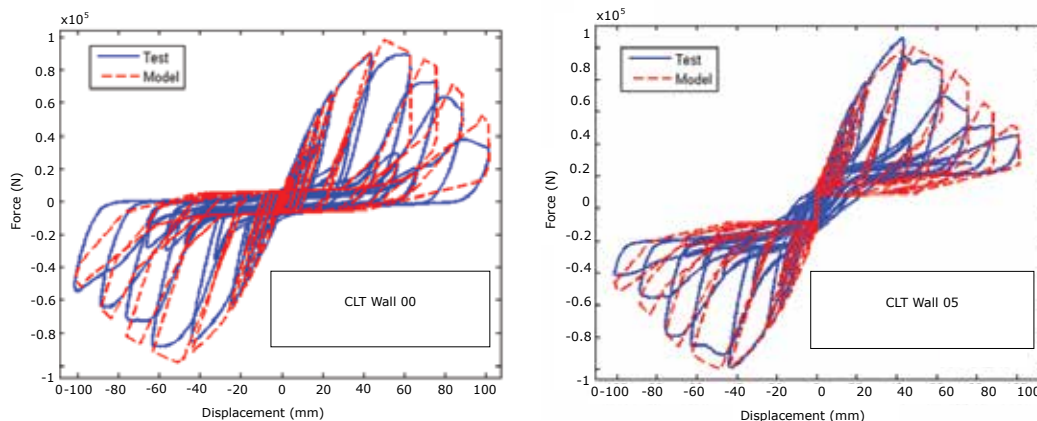

Figure 6
Calibrated wall models compared with tests (Popovski et al., 2010)

Figure 6 shows examples of the calibrated model responses compared to test responses. The accuracy of the model was felt to be sufficient for design and analysis purposes. A group of connector parameters were obtained through this process and are listed in Table 1. These connector parameters can then be used to develop lateral responses for a given CLT wall design based on the kinematic assumptions stated earlier. However, it should be noted that all wall data available was for one aspect ratio as discussed in detail in Appendix A, thus the assumption of rotation in the kinematic model described herein must be kept in mind. Experimental dynamic responses of at least 3.5% have been observed to behave as described in this handbook.

Table 1
Calibrated connector parameters

Connector Type	Hysteretic Parameters (lb., in.)									
	K0 (lb./in.)	r1	r2	r3	r4	F0 (lb.)	F1 (lb.)	X (in.)	a	b
HTT 16	25000	0.002	-0.30	1	0.05	9000	400	2.00	0.75	1.10
16D-SN	800	0.005	-0.20	1	0.01	800	40	2.50	0.50	1.10
SFS1	800	0.005	-0.40	1	0.01	750	20	1.80	0.50	1.10
SFS2	1600	0.005	-0.40	1	0.01	1200	40	2.00	0.50	1.10
16D-SN with half-lapped joint	900	0.001	-0.30	1	0.03	600	20	1.60	0.50	1.10
SFS1 with half-lapped joint	900	0.001	-0.60	1	0.03	562.5	10	1.15	0.50	1.10
SFS2 with half-lapped joint	1800	0.001	-0.60	1	0.03	900	20	1.28	0.50	1.10

Connectors calibrated were based on FPInnovations’ test results and include:

- (1) HTT 16: Simpson Strong-Tie HTT 16 hold-downs installed at corners of CLT walls
- (2) 16D-SN: 16d spiral nails with D=0.153 in. (3.9 mm) and L=3.5 in. (89 mm)
- (3) SFS1: SFS Intec screws D=0.16 in. (4.0 mm) and L=2.75 in. (70 mm)
- (4) SFS2: SFS Intec screws D=0.20 in. (5.0 mm) and L=3.54 in. (90 mm)

When a CLT wall is made up of multiple panels, the panels’ vertical interface is typically connected with a half-lapped detail. The impact of this step-joint detail on wall lateral resistance was phenomenologically captured in this calibration process using the equivalent connector parameters when multi-panel wall test data (also shown in Table 1 as “connector with half-lapped joint”) was used.

5.3 Typical CLT Wall Configurations

As shown in Figure 7, several typical CLT wall configurations were considered as an example. Each bracket shown in Figure 6 is installed with either six 16D spiral nails or four screws, which is the maximum number of connectors per bracket used in FPInnovations’ shear wall tests.

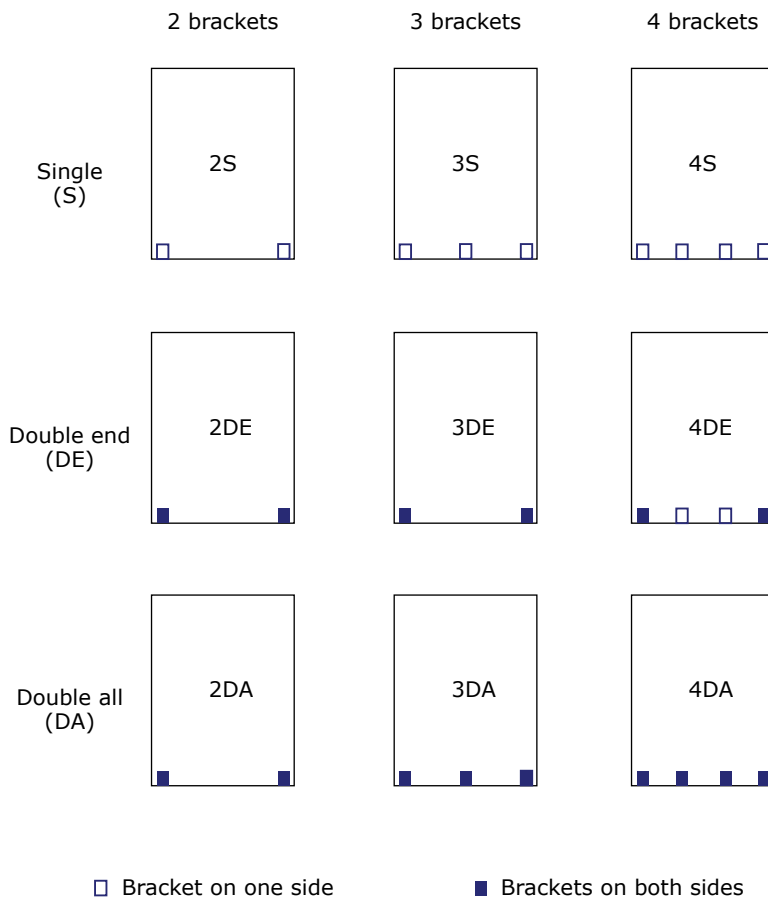

Figure 7

Typical CLT wall configurations (Note: a maximum of either six 16D spiral nails or four screws were used per bracket)

The height of all panels in the typical wall configuration is 8 feet. The length of a single panel can vary from 3 to 6 feet. For wall length equal to or greater than 8 feet, multiple 4-foot long panels are combined together such that the panels can rotate as discussed earlier. In Figure 7, the notation “S” stands for Single sided brackets for each location, “DE” stands for Double sided brackets at the End of the panel, and “DA” stands for Double All, meaning all brackets in the panels are double sided. It should be noted that, in the case of the wall panel with only 2 brackets, configurations DE and DA are identical.

For each wall configuration, the necessary lateral wall resistance parameters (or curves) depending on the requirements of the design application can be developed, including:

- (1) Ultimate lateral strength of the wall for developing allowable load level for equivalent static force design (see example of allowable strength table developed later in this section and Appendix B for design example).
- (2) Backbone curve of the wall for nonlinear push over analysis or displacement-based design (see Appendix B for a design example using Direct Displacement Design).
- (3) Hysteretic response of the wall for more advanced nonlinear time history modeling and simulation (see Appendix B for an example using CLT wall hysteresis model in nonlinear time history analysis).

5.4 Example CLT Allowable Capacity Table

The ultimate strength can be determined using the numerical model for each CLT wall configuration. Since, at this point, the design values for CLT walls are not defined in the United States, it was decided to proceed with the wall design resistances equal to the ultimate load divided by a factor of 2.5 for illustrative purposes; that is utilizing only 40% of the wall ultimate strength in the design example. From a drift perspective, this force demand occurs at 0.6% story drift compared to approximately 3.5% to 4% ultimate story drift for a 4-foot long panel of 8 ft. in height. In developing the model, it was assumed that there will always be hold-downs present at the ends of the wall (if a wall has multiple panels, only the two ends of wall will have hold-downs, not the ends of each panel). The resulting design resistance values (ASD and LRFD) for standard CLT wall configurations using three types of connectors are shown in Table 2.

Table 2

Example CLT wall design resistance¹ (kips)

Fastener Type: 16D-SN		Wall Length (ft.)							
		Single-panel Wall				Multi-panel Wall			
No. of Brackets ²	Bracket Installation	3	4	5	6	2x4	3x4	4x4	5x4
2	S	2.6	3.5	4.4	5.3	4.5	5.8	7.1	8.4
	DE	3.9	5.2	6.5	7.8	7.1	9.7	12.4	15.0
	DA	3.9	5.2	6.5	7.8	7.1	9.7	12.4	15.0
3	S	3.1	4.1	5.1	6.2	5.5	7.3	9.1	10.9
	DE	5.7	7.6	9.5	11.5	9.9	13.1	16.2	19.4
	DA	4.8	6.4	8.0	9.6	9.1	12.8	16.4	20.1
4	S	3.6	4.8	6.0	7.2	6.5	8.9	11.2	13.6
	DE	6.2	8.3	10.3	12.5	11.0	14.7	18.3	22.0
	DA	5.8	7.7	9.6	11.6	11.2	15.9	20.7	25.4

SFS1		Wall Length (ft.)							
		Single-panel Wall				Multi-panel Wall			
No. of Brackets ²	Bracket Installation	3	4	5	6	2x4	3x4	4x4	5x4
2	S	2.1	2.9	3.6	4.3	3.3	4.1	4.8	5.6
	DE	2.9	3.9	4.9	5.9	4.8	6.4	7.9	9.4
	DA	2.9	3.9	4.9	5.9	4.8	6.4	7.9	9.4
3	S	2.4	3.2	4.0	4.9	3.8	4.9	5.9	6.9
	DE	4.6	6.1	7.6	9.2	7.1	8.9	10.7	12.5
	DA	3.5	4.6	5.8	7.0	5.9	8.0	10.1	12.1
4	S	2.7	3.6	4.5	5.5	4.4	5.8	7.1	8.4
	DE	4.8	6.5	8.1	9.8	7.7	9.8	11.9	14.0
	DA	4.1	5.4	6.8	8.2	7.1	9.8	12.4	15.1

Fastener Type: SFS2		Wall Length (ft.)							
		Single-panel Wall				Multi-panel Wall			
No. of Brackets ²	Bracket Installation	3	4	5	6	2x4	3x4	4x4	5x4
2	S	2.7	3.6	4.6	5.5	4.5	5.8	7.2	8.5
	DE	4.1	5.4	6.8	8.2	7.2	9.8	12.5	15.2
	DA	4.1	5.4	6.8	8.2	7.2	9.8	12.5	15.2
3	S	3.3	4.3	5.4	6.6	5.5	7.4	9.2	11.1
	DE	6.0	8.0	10.0	12.0	10.0	13.2	16.4	19.6
	DA	5.1	6.9	8.6	10.3	9.2	13.0	16.7	20.4
4	S	3.8	5.1	6.4	7.7	6.6	9.0	11.4	13.8
	DE	6.5	8.7	10.9	13.2	11.1	14.8	18.6	22.3
	DA	6.2	8.3	10.4	12.6	11.4	16.2	21.1	25.9

¹ Tabulated design resistance is for ASD. For LRFD, multiply tabulated resistance by 1.6, which represents a soft calibration similar to AF&PA/ASCE 16 (1995).

² Brackets used were Simpson Strong-Tie ABR105; 4.125 in. x 4.125 in. x 3.5625 in.

5.5 Model for System Level Performance Simulation

Shake table tests on complete CLT building systems have been limited to responses with moderate levels of story drift (e.g., 3.5%), therefore the Chapter discussion here is focused on maintaining story drifts at or below this level. Currently, system level behavior of CLT buildings under severely damaged or near the collapse stage has not been observed experimentally. The model proposed here for application to CLT systems was first introduced by Pei and van de Lindt (2009) to simulate shear-bending coupled response of stacked light-frame wood shear wall systems, and was incorporated in the software program SAPWood V2.0 for seismic analysis of mid-rise, light-frame wood buildings. The kinematic assumptions of the model are illustrated in Figure 8. A more detailed description of the model and use of the SAPWood program can be found in Pei and van de Lindt (2009) and in NEEShub (www.nees.org) where the software and users manual are available for free download.

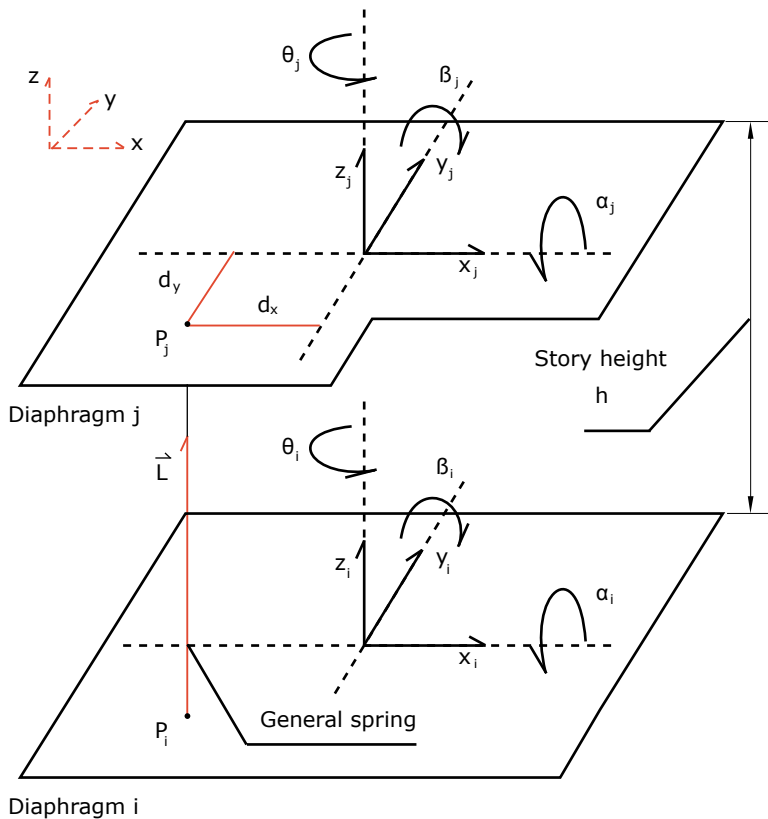

Figure 8
Simplified system level model for nonlinear time history analysis of CLT buildings

Based on model assumptions, the dynamic response of a multi-story CLT building can be represented by multiple rigid diaphragm plates connected by general nonlinear springs. The shear resistance of CLT walls is represented by nonlinear hysteretic springs, while the components that resist uplift and overturning are modeled as vertical tie-down springs. The main assumptions for this model include:

- (1) Dynamic response of CLT floor/roof diaphragms can be approximated as responses of rigid plates having 6 degrees of freedom.
- (2) Lateral (shear) resistance of CLT walls can be represented in the model as hysteretic springs.
- (3) Overturning restraint is provided and can be represented in the model as linear springs.
- (4) Effect of finish materials on lateral resistance is not examined in this study.

Appendix B of this Chapter presents an example analysis that was conducted for a 6-story CLT building using SAPWood and subjected to a suite of earthquake ground motions to investigate its response. The building design was based on the ASCE7-10 equivalent lateral force procedure using assumed values of the response modification factor and wall resistance values in accordance with Table 2. The analysis in Appendix B does not include the effect of finishing materials or non-structural walls. CLT appears to be capable of being used for mid-rise building construction in seismic regions of the United States. To do so, the designer would need to justify the parameters used in design through the alternative means of the building code.

6

SUMMARY AND CONCLUSIONS

In this Chapter, the state-of-the-art knowledge on cross-laminated timber in the United States was presented. Information available to the authors on testing and modeling around the world was summarized in appendices and an example using a six-story building floor plan, originally designed using light-frame wood, was re-designed using CLT, based on the assumption of several different R-factors. At this early stage of CLT development in the United States, a comprehensive assumption of seismic design coefficients including R cannot be made, but the following conclusion can be stated based on the single example in Appendix B. An R-factor of approximately 2 appears to provide less than a 10% probability of exceeding 3.5% story drift for the single six-story illustrative example presented herein. CLT is believed to be a viable option for mid- and high-rise buildings (e.g., 15 stories) based on past testing, observations, and numerical modeling. A P695 study is in progress to develop seismic design coefficients and facilitate use of the equivalent lateral force method for seismic design of CLT in the United States.

7

REFERENCES

American Society of Civil Engineers (ASCE). 2010. *Minimum design loads for buildings and other structures*. ASCE 7-10. Reston, VA: ASCE.

American Wood Council (AWC). 2008. *Special design provisions for wind and seismic*. ANSI/AF&PA SDPWS 2008. Leesburg, VA: AWC.

American Wood Council (AWC). 2012. *National design specification (NDS) for wood construction*. NDS 2012. Leesburg, VA: AWC.

ASTM International. 2009. Method B in *Standard test methods for cyclic (reversed) load test for shear resistance of vertical elements of the lateral force resisting systems for buildings*. ASTM E2126-09. West Conshohocken, PA: ASTM.

Ceccotti A. 2008. New technologies for construction of medium-rise buildings in seismic regions: The XLAM case. *Structural Engineering International (SEI)* 18(2):156-165.

Ceccotti A., M. Follesa, M.P. Lauriola, and C. Sandhaas. 2006. SOFIE Project: Test results on the lateral resistance of cross-laminated wooden panels. Paper presented at the First European Conference on Earthquake Engineering and Seismicity, Geneva, Switzerland.

Ceccotti, A., C. Sandhaas, and M. Yasumura. (2010). Seismic performance of X-lam buildings: The Italian Sofie Project. In *Proceedings of the 9th US national and 10th Canadian Conference on Earthquake Engineering: Reaching Beyond Borders, Toronto, Canada, July 25-29*.

CNR-Ivalsa. 2012. *The SOFIE Project*. <http://www.ivalsa.cnr.it/en/current-projects/edilizia-e-architettura/progetto-sofie.html>.

Dujic B., S. Aicher, and R. Zarnic. 2005. Investigation on in-plane loaded wooden elements: Influence of loading and boundary conditions. *Otto-Graf-Journal* 16:259-272.

Dujic B., S. Aicher, and R. Zarnic. 2006. Testing of wooden wall panels applying realistic boundary conditions. Paper presented at the 9th World Conference on Timber Engineering, Portland, Oregon.

Dujic B., V. Hristovski, M. Stojmanovska, and R. Zarnic. 2006. Experimental investigation of massive wooden wall panel systems subjected to seismic excitation. Paper presented at the First European Conference on Earthquake Engineering and Seismicity, Geneva, Switzerland.

Dujic B., S. Klobcar, and R. Zarnic. 2006. Influence of openings on shear capacity of massive cross-laminated wooden walls. In *COST E29: International Workshop on Earthquake Engineering on Timber Structures, November 9-10, 2006, Coimbra, Portugal*, 105-118.

Dujic B., S. Klobcar, and R. Zarnic. 2007. Influence of openings on shear capacity of wooden walls. In *Proceedings of the 40th CIB-W18 Meeting, Bled, Slovenia*, paper 40-15-6.

- Dujic B., S. Klobcar, and R. Zarnic. 2008. Shear capacity of cross-laminated wooden walls. Paper presented at the 10th World Conference on Timber Engineering, Myazaki, Japan.
- Dujic B., J. Pucelj, and R. Zarnic. 2004. Testing of racking behavior of massive wooden wall panels. In *Proceedings of the 37th CIB-W18 Meeting, Edinburgh, Scotland*, paper 37-15-2.
- Dujic B., and R. Zarnic. 2006. Study of lateral resistance of massive X-lam wooden wall system subjected to horizontal loads. In *COST E29: International Workshop on Earthquake Engineering on Timber Structures, November 9-10, 2006, Coimbra, Portugal*, 97-104.
- Federal Emergency Management Agency (FEMA). 2009. *Quantification of building seismic performance factors*. FEMA P695. Washington, DC: FEMA. 421 p.
- Federal Emergency Management Agency (FEMA). 2010. Quantification of building system performance and response parameters: Component equivalency methodology. Draft report FEMA P795. Washington, DC: FEMA.
- Gagnon, S. and C. Pirvu, eds. 2011. *CLT Handbook: Cross-laminated timber*. Canadian ed. Special Publication SP-528E. Québec, QC: FPInnovations. 1 v.
- ICC Evaluation Service (ICC-ES). 2009. *Acceptance criteria for prefabricated wood shear panels*. AC 130. Whittier, CA: ICC-ES. 8 p.
- Krawinkler, H., F. Parisi, L. Ibarra, A. Ayoub, and R. Medina. 2000. *Development of a testing protocol for woodframe structures*. CUREE Publication No. W-02. Richmond, CA: CUREE.
- Pang, W., D.V. Rosowsky, S. Pei, and J.W. van de Lindt. 2010. Simplified direct displacement design of six-story woodframe building and pretest seismic performance assessment. *ASCE Journal of Structural Engineering* 136(7):813-825.
- Pei, S., and J.W. van de Lindt. 2009. *User's manual for SAPWOOD, for Windows, version 2.0*. Available at www.nees.org.
- Pei, S., J.W. van de Lindt, S.E. Pryor, H. Shimizu, and H. Isoda. 2010. *Seismic testing of a full-scale mid-rise building: The NEESWood Capstone test*. NEESWood Report NW-04. Fort Collins, CO: Colorado State University.
- Popovski, M., E. Karacabeyli, and A. Ceccotti. 2011. Seismic performance of cross-laminated timber buildings. Chapter 4 in *CLT handbook: Cross-laminated timber*. Canadian ed. Special Publication SP-528E. Québec, QC: FPInnovations.
- Popovski, M., J. Schneider, M. Schweinsteiger. 2010. Lateral load resistance of cross-laminated wood panels. Paper presented at 11th World Conference on Timber Engineering 2010, Trentino, Italy.
- Pozza, L., R. Scotta, and R. Vitaliani. 2009. A non linear numerical model for the assessment of the seismic behaviour and ductility factor of X-lam timber structures. In *Proceeding of the International Symposium on Timber Structures, June 25-27, 2009, Istanbul, Turkey*, 151-162.
- Schädle, P., and H.J. Bläß. 2010. Earthquake behaviour of modern timber construction systems. Paper presented at the 11th World Conference on Timber Engineering, Riva del Garda, Italy.
- van de Lindt, J.W., S. Pei, S.E. Pryor, H. Shimizu, and H. Isoda. 2010. Experimental seismic response of a full-scale six-story light-frame wood building. *ASCE Journal of Structural Engineering* 136(10):1262-1272.

APPENDIX A

LITERATURE REVIEW

A1 European and Japanese Experience

Appendix A summarizes notable research efforts led by European researchers on seismic performance of CLT building systems.

A1.1 Experimental Studies

There were several notable experimental studies on CLT systems seismic performance carried out by European researchers over the last decade, including CLT wall tests and shake table tests of complete buildings.

The most comprehensive study to determine the seismic behavior of 2-D CLT wall panels was conducted at the University of Ljubljana, Slovenia. During the project that was partially supported by KLH Massivholz GmbH from Austria, numerous quasi-static monotonic and cyclic tests were carried out on walls with lengths of 8 ft. (2.44 m) and 10.5 ft. (3.2 m) and heights of 8 ft. (2.44 m) and 9 ft. (2.72 m) (Dujic et al., 2004). Walls were subjected to combined constant vertical load and either monotonic or cyclic horizontal loads. Wall panels were tested with various boundary conditions which enabled the development of load vs. wall deformation relations from cantilever to pure shear wall behavior. Influence of boundary conditions, magnitude of vertical load and types of anchoring systems were investigated (Dujic et al., 2005, 2006). Differences in mechanical properties between monotonic and cyclic responses were also studied (Dujic and Zarnic, 2006), as was the influence of openings on the shear wall properties (Dujic et al., 2006, 2007). Two configurations of walls with equal dimensions, one with no openings and one with a door and a window, were tested under the same boundary conditions. Analytical models of CLT wall panels were developed in the computer program SAP2000, and were verified against the test results. The verified analytical models were used for a parametric study that included 36 mathematical models having different patterns of openings (Dujic et al., 2008). Results of the parametric study were used to develop mathematical formulas describing the relationship between the shear strength and stiffness of CLT wall panels with and without openings. CLT wall tests were also carried out by Karlsruhe Institute of Technology in order to compare the performance of such modern system vs. the “traditional” timber frame construction (Schädle et al., 2010).

As part of the University of Ljubljana CLT project, shake table tests were conducted on two one-story box CLT models at the Dynamic Testing Laboratory of the Institute of Earthquake Engineering and Engineering Seismology (IZIIS) in Skopje, Macedonia. The intent was to make a correlation between the results from the quasi-static tests and the results from the shake table tests. Based on these tests, the main characteristics of the dynamic response of the tested models were determined.

A more comprehensive study to quantify the seismic behavior of low- and mid-rise CLT constructions was part of the SOFIE project, in Italy. This project was undertaken by the Trees and Timber Institute of the National Research Council of Italy (CNR-IVALSA) in collaboration with National Institute for Earth Science and Disaster Prevention in Japan (NIED), Shizuoka University, and the Building Research Institute (BRI) in Japan,

and partially supported by the Autonomous Province of Trento (Italy). The testing program included tests on connections, in-plane cyclic tests on CLT wall panels with different layouts of connections and openings (Ceccotti et al., 2006), pseudo-dynamic tests on a one-story 3-D specimen in three different layouts (Lauriola and Sandhaas, 2006), shake table tests on a three-story, 23 ft. x 23 ft. (7 m x 7 m) in plan and 33 ft. (10 m) high building under different earthquakes (Ceccotti and Follesa, 2006), and finally a series of full-scale shake table tests on a seven-story CLT building conducted at E-Defense facility in Miki, Japan (The SOFIE Project, 2012). For additional details on the SOFIE Project, see Ceccotti et al., 2010.

Results from quasi-static tests on CLT wall panels showed that the connection layout and design has a strong influence on the overall behavior of the wall (Ceccotti et al., 2006). Hysteresis loops were, on average, found to have an equivalent viscous damping of 12%. Similarly to the cyclic tests, the pseudo-dynamic tests showed that the construction system is very stiff but still ductile (Lauriola and Sandhaas, 2006). It was found that the initial stiffness of the 3-D specimen with asymmetric configuration (openings of 13 ft. (4.0 m) on one side and 7.4 ft. (2.25 m) on the other) was similar to that of the symmetric configuration (openings of 7.4 ft. (2.25 m) on both sides), suggesting that the larger opening on one side did not affect the building stiffness very much. It thus confirmed that the behavior of the wall is due to the connections and not to the CLT panels for lower levels of lateral force. This again may bring to light the need for the panels to be able to rotate as discussed earlier.



Figure 9
Three-story CLT house tested at NIED Laboratory in Tsukuba, Japan

Shake table tests on the 3-story house conducted in the laboratories of the NIED in Tsukuba, Japan (Figure 9) showed that the CLT construction survived 15 destructive earthquakes without any severe damage (Ceccotti and Follesa, 2006). The collapse state definition for the tests was defined to be failure of one or more hold-down anchors, which was reached only during the last test that used the Nocera Umbra earthquake record with peak ground acceleration (PGA) of 1.2 g. An analytical model of the 3-story house was developed using the DRAIN 3-DX computer program. The model was compared to the behavior of the 3-story house during the shake table tests, and showed good correlation with the test results.

The next series of shaking table tests from the SOFIE project was conducted in October 2007 at the Hyogo Earthquake Engineering Research Center in Miki, Japan. The building had a floor plan of 44 ft. x 25 ft. (13.5 m x 7.5 m), and was seven stories high with a total height of 77 ft. (23.5 m) (Figure 10). The building was designed by the CNR-IVALSA team according to the European Code for Construction in Seismic Regions with an action reduction factor of 3 (Ceccotti, 2008; Pozza et al., 2009) and the action increasing factor of 1.5 relevant to strategic buildings. The building walls were made of CLT panels with a thickness of 5.5 in. (142 mm)

on the first two floors, 5 in. (125 mm) on floors three and four, and 3.3 in. (85 mm) on the last three floors, where less loads were expected. The walls were connected to each other using self-drilling (tapping) screws. Each wall consisted of several 8.1 ft. (2.5 m) long panels connected together with screws. The floors were also made with CLT panels with a thickness of 5.5 in. (142 mm), and were connected to the walls with steel brackets and screws. High capacity through-floor panel-to-panel tie-downs were used extensively to provide overturning resistance. The testing consisted of several consecutive applications in all three orthogonal directions of two earthquake ground motions, including the record from the Great Hanshin-Awaji Earthquake from 1995, also known as the Kobe Earthquake ($M=7.2$) with 100% intensity (0.6 g acceleration in shorter X-direction, 0.82 g in longitudinal Y-direction, and 0.34 g in vertical Z-direction). The maximum story drift was 1.5 in. (38 mm) (1.3% story drift) in the Y-direction and 1.14 in. (29 mm) (1% story drift) in the X-direction, with the total deflection at the top of the building being 6.9 in. (175 mm) and 11.3 in. (287 mm), respectively, with the building fully recentering following the series of earthquakes, i.e. returning to zero.



Figure 10
Seven-story CLT house tested at E-Defense Laboratory in Miki, Japan

A2 Canadian Experience

A2.1 Experimental Study

Following the introduction of CLT to Canada, several experimental research projects were carried out by FPInnovations to study the seismic performance of CLT wall and building systems. This section presents results from a CLT wall test program performed in Canada. System level tests were also carried out recently but the results were not available at the time this Handbook was published.

A2.2 CLT Wall Tests by FPInnovations

In the testing program at FPInnovations in Vancouver, a total of 32 monotonic and cyclic tests were performed. All walls were 3-ply CLT panels with a thickness of 3.7 in. (94 mm). They were made of European spruce and manufactured at KLH Massivholz GmbH in Austria. Since the CLT panels had to be shipped in a container, the panel dimensions were limited to 7.5 ft. (2.3 m), which was the height and width of the container. CLT walls with 12 different configurations were tested. Details about the testing matrix and the different Wall Configurations I to XII are given in Tables 3, 4 and 5. In Table 3, walls with aspect ratio of 1:1 are shown, while in Table 4 walls with aspect ratio of 1:1.5 are shown. In Table 5, two-story assemblies of 7.5 ft. x 7.5 ft. (2.3 m x 2.3 m) walls are presented along with tall CLT walls that had a height of 16.1 ft. (4.9 m) and a length of 7.5 ft. (2.3 m) (aspect ratio of 2.1:1). All wall specimens were assembled using hardware and dowel connectors shown in Figures 11 and 12. Four different types of brackets (A, B, C, and D) were used to connect the walls to the steel foundation beam or to the CLT floor panel below (Figure 11). Bracket A, Simpson Strong-Tie AE116, 3.5 in. x 1.9 in. x 4.6 in. (90 mm x 48 mm x 116 mm) (W x D x H), and Bracket B, Simpson Strong-Tie ABR105, 3.5 in. x 4.1 in. x 4.1 in. (90 mm x 105 mm x 105 mm), are off-the-shelf products that are commonly used in CLT applications in Europe. Brackets C and D were custom made out of 0.25 in. (6.4 mm) thick steel plates to accommodate the use of timber rivets.

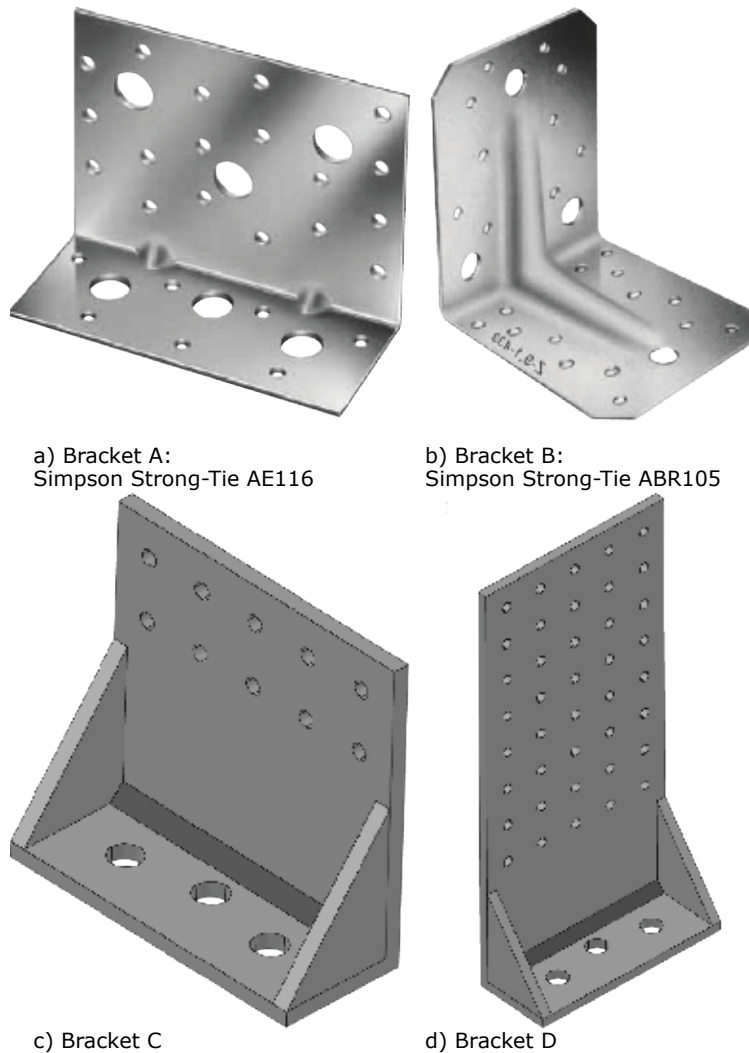

Figure 11
Brackets for CLT walls used in the tests

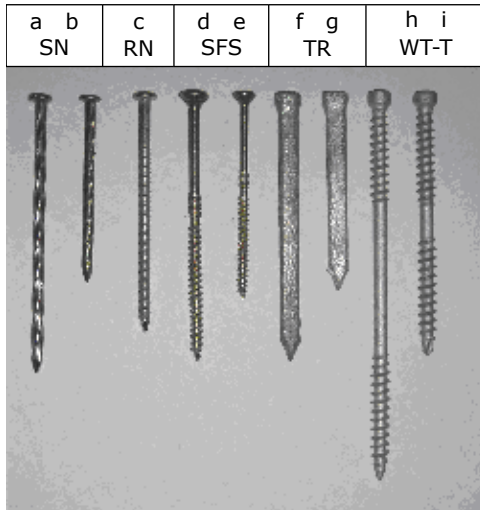

Figure 12
Fasteners used in the test program

- (a) 16d spiral nail $D=0.153$ in. (3.9 mm) and $L=3.5$ in. (89 mm)
- (b) 10d spiral nail $D=0.13$ in. (3.3 mm) and $L=2.48$ in. (63 mm)
- (c) Annular ring nail $D=0.134$ in. (3.4 mm) and $L=3$ in. (76 mm)
- (d) SFS2 screw $D=0.20$ in. (5.0 mm) and $L=3.5$ in. (90 mm)
- (e) SFS1 screw $D=0.16$ in. (4.0 mm) and $L=2.7$ in. (70 mm)
- (f) Timber rivet $L=3.5$ in. (90 mm)
- (g) Timber rivet $L=2.56$ in. (65 mm)
- (h) WT-T screw 0.256 in. x 5.12 in. (6.5 x 130 mm)
- (i) WT-T screw $D=0.15$ in. (3.8 mm) and $L=3.5$ in. (89 mm)

Walls in Configuration I had four brackets spaced at 28 in. (710 mm) o.c. Walls 00 through 03 used Type A brackets, which were connected to the wall using eighteen 16d spiral nails (SN) with $D=0.153$ in. (3.9 mm) and $L=3.5$ in. (89 mm) (Figure 12a). Wall 04 used Type A brackets and twelve annular ring nails (RN) with $D=0.134$ in. (3.4 mm) and $L=3$ in. (76 mm) (Figure 12c). Wall 05 used Type A bracket and eighteen SFS1 screws with $D=0.16$ in. (4.0 mm) and $L=2.7$ in. (70 mm) (Figure 12e), while Wall 06 used ten SFS2 screws with $D=0.20$ in. (5.0 mm) and $L=3.5$ in. (90 mm) (Figure 12d). Walls 09 and 10A used Type C brackets with two rows of five $L=2.56$ in. (65 mm) timber rivets (Figure 12g). In addition to three Type A brackets spaced at 21.3 in. (550 mm) o.c. nailed with eighteen spiral nails ($D=0.153$ in.; $L=3.5$ in.), Walls 07, 08 and 08A of Configuration II had Simpson Strong Tie HTT-16 hold-downs at both ends. The hold-downs were nailed using eighteen 16d spiral nails for Walls 07 and 08, while Wall 08A used eighteen spiral nails with $D=0.13$ in. (3.3 mm) and $L=2.48$ in. (63 mm) (Figure 12b).

Walls from Configuration III (11, 12 and 12A) consisted of two panels that were connected to the foundation in the same way as walls from Configuration I. The two panels that formed the wall were connected together using a continuous 2.56 in. (65 mm) long half-lapped joint with no gap, and one vertical row of screws. Twelve SFS WT-T type screws with $D=0.15$ in. (3.8 mm) and $L=3.5$ in. (89 mm), spaced at 7.9 in. (200 mm), were used in Wall 11 (Figure 12i) to connect panels together, while panels in Walls 12 and 12A were connected to each other using SFS2 screws (Figure 12d). These walls were designed to investigate the effect of gaps in the walls on the overall wall performance under lateral loads.

Only one CLT panel (Wall 20) was tested from Configuration IV. In addition to four Type A brackets on the front side, this wall had three additional brackets on the back side, spaced right in the middle between the front brackets, for a total of seven brackets. This configuration was representative of an inside wall where both sides of the wall are available for connecting.

Table 3

Test matrix for 7.5 feet (2.3 m) long and 7.5 feet (2.3 m) high walls

Wall Configuration	Test Designation	Brackets and Fasteners	Vertical Load [kip/ft.]	Test Protocol ¹
 I	00	Bracket A SN 16d, n=18	0	CUREE
	01		0.68	Monotonic
	02		0.68	CUREE
	03		1.37	CUREE
	04	Bracket A, RN, n=12	1.37	CUREE
	05	Bracket A, SFS1, n=18	1.37	CUREE
	06	Bracket A, SFS2, n=10	1.37	CUREE
	09	Bracket C, Rivets L=2.5 in., n=10	1.37	Monotonic
	10A	Bracket C, Rivets L=2.5 in., n=10	1.37	CUREE
	 II	07	Bracket A, SN 16d, n=18	1.37
08		Bracket A, SN 16d, n=18	1.37	CUREE
08A		Bracket A, SN 16d, n=18 10d, n=18 on Hold-downs	1.37	CUREE
 III	11	Bracket A, SN 16d, n=18 Between panels WT-T, n=12	1.37	CUREE
	12	Bracket A, SN 16d, n=18 Between panels SFS2, n=12	1.37	CUREE
	12A	Bracket A, SN 16d, n=18 Between panels SFS2, n=12	1.37	ISO
 IV	20	Bracket A SN 16d, n=18 3 brackets on the back side	1.37	CUREE
 V	21	Bracket A SN 16d, n=6	1.37	CUREE
 VI	22	WT-T, n=18	1.37	CUREE
	22B	WT-T, n=34	1.37	CUREE
 VII	23	Bracket A SN 16d, n=6 3 brackets on the back side	1.37	CUREE

Table 4

Test matrix for 11.3 feet (3.45 m) long and 7.5 feet (2.3 m) high walls

Wall Configuration	Test Designation	Brackets and Fasteners	Vertical Load [kip/ft.]	Test Protocol ¹
 VIII	13	Bracket B (9 brackets) SN 16d, n=10	1.37	Monotonic
	14	Bracket B (9 brackets) SN 16d, n=10	1.37	ISO
 IX	15	Bracket B (9 brackets) SN 16d, n=10 SFS2, n=8	1.37	Monotonic
	16	Bracket B (9 brackets) SN 16d, n=10 SFS2, n=8	1.37	ISO
 X	19	Bracket B SN 16d, n=10	1.37	ISO

Table 5

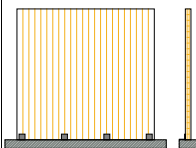
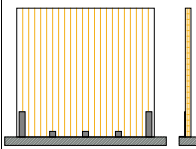
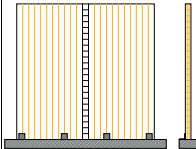
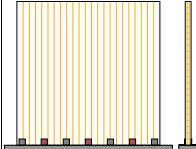
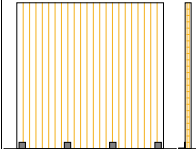
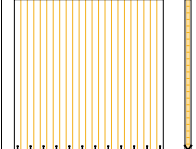
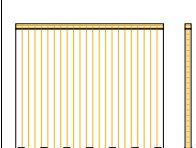
Test matrix for two story assemblies and tall walls

Wall Configuration	Test Designation	Brackets and Fasteners	Vertical Load [kip/ft.]	Test Protocol ¹
 XI	28	Bracket A, SN 16d, n=6 Slab-to-wall screws at 7.9 in	1.37	Monotonic
	29B	Bracket A, SN 16d, n=6 on both floors	1.37	ISO
	29C	Bracket A, SN 16d, n=8 at the bottom n=6 on the top storey	1.37	ISO
 XII	24	Bracket D, Rivets L=2.56 in., n=40	1.37	Monotonic
	25	Bracket D, Rivets L=2.56 in., n=40	1.37	ISO
	26	Bracket D, Rivets L=3.54 in., n=40	1.37	ISO
	27	Bracket D, Rivets L=3.54 in., n=20	1.37	ISO

¹It is noted that test protocol does make a difference in the experimentally measured hysteresis. For more information on these protocols, the interested reader is referred to Krawinkler et al. (2000) and ASTM International (2009).

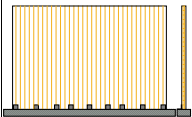
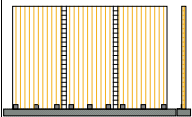
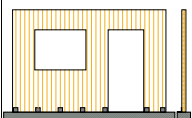
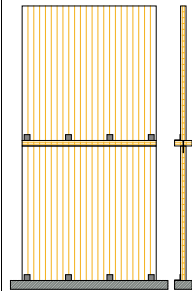
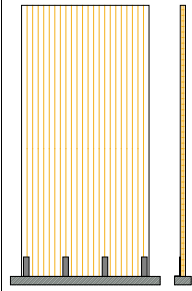
To investigate the effect of the foundation stiffness in a real case scenario, walls in Configurations V, VI and VII were placed over a 3.7 in. (94 mm) thick CLT slab with a width of 15.75 in. (400 mm). Wall 21 used four Type A brackets spaced at 28 in. (710 mm) o.c., while Wall 23 used a total of seven brackets (four in front and three on the back) in the same arrangement as in Wall 20. Each of the brackets had six 16d spiral nails. The brackets were connected to the CLT floor slab using three screws with $D=0.39$ in. (10 mm) and $L=3.15$ in. (80 mm). Wall 22 used nine pairs of WT-T 0.256 in. x 5.12 in. (6.5 x 130 mm) screws (Figure 12h) placed at an angle of 45 degrees to the slab and spaced at 11 in. (280 mm). Wall 22B used seventeen pairs of the same screws with five pairs being closely grouped near each end of the wall (spaced at 1.57 in. (40 mm)) to simulate a hold-down effect. The rest of the screws were spaced at 12.6 in. (320 mm).

Walls from Configurations VIII, IX, and X were 11.3 ft. (3.45 m) long and 7.5 ft. (2.3 m) high. Walls 13 and 14 (Configuration VIII) were single panel walls that had a total of nine Type B brackets, each with ten 16d spiral nails. Brackets had different spacing, varying from 12.6 in. (320 mm) to 18.1 in. (460 mm). Walls 15 and 16 (Configuration IX) were three-panel walls, with the same number and position of the brackets as the walls of Configuration VIII. The panels were connected to each other using half-lapped joints and fasteners. Walls 15 and 16 used eight SFS2 screws of 0.197 in. x 3.54 in. (5x90 mm) spaced at 11.8 in. (300 mm). Wall 19 of Configuration X was the only wall with openings in the entire research program. The door was 6.2 ft. (1.9 m) high and 2.6 ft. (0.8 m) wide, with the door post being 19.7 in. (500 mm) wide, while the window was 3.8 ft. (1.15 m) wide and 2.6 ft. (0.8 m) high. The wall was connected using seven Type B brackets, each using ten 16d spiral nails.

Configuration XI included three two-story wall assemblies consisting of a lower and upper story wall (7.5 ft. x 7.5 ft. (2.3 m x 2.3 m)) with a 3.7 in. (94 mm) CLT slab in between. Both walls were connected at the bottom using Type A brackets, spaced at 28 in. (710 mm) o.c. Walls 28 and 29B used six 16d spiral nails, while wall 29C used eight such nails. The floor panel was connected to the bottom wall using SFS screws with $D=0.315$ in. (8 mm) and $L=7.9$ in. (200 mm), spaced at 7.9 in. (200 mm). Finally, Configuration XII consisted of four single panel tall walls (7.5 ft. x 16 ft. (2.3 m x 4.9 m)) that were connected to the steel foundation beam using four Type D brackets spaced at 28 in. (710 mm). Walls 24 and 25 had forty rivets in each bracket ($L=2.56$ in. (65 mm)), Wall 26 had the same number of 3.5 in. (90 mm) long rivets (Figure 12f), while Wall 27 had twenty $L=3.5$ in. (90 mm) rivets.

A2.3 Test Setup

A solid model of the test setup with a specimen ready for testing is shown in Figure 13. Steel “I” beams with stiffeners provided a foundation to which the specimens were bolted down. Another stiff steel beam that was bolted to the top of CLT walls was used as a spreader bar for the lateral load. The exact influence of the spreader bar is not known for multi panel wall configurations, but it is noted that a gap was provided between the spreader bar and top of the panels. Lateral guides with rollers were also used to ensure a steady and consistent unidirectional movement of the walls. Vertical load was applied using a 3 kip (13.3 kN) hydraulic actuator located in the middle of each side of the wall when testing 7.5 ft. (2.3 m) long walls (Figure 14), or using two such actuators located at third points on each side of the wall for 11.3 ft. (3.45 m) long walls. It is recognized that this would behave slightly different than gravity load, but allows for the restoring force to be determined in order to accurately fit hysteretic models for analyses. Only Wall 00 was tested without any vertical load on it. Walls 01 and 02 were tested with a 685 lb./ft. (10 kN/m) vertical load, which approximately corresponds to a wall located at the bottom of a two-story structure. All other walls were tested using a 1370 lb./ft. (20 kN/m) vertical load, which corresponds to a wall being at the bottom of a four-story structure.

The walls were subjected to either monotonic or cyclic lateral loading using a 24.7 kips (110 kN) hydraulic actuator (Figure 13). Walls 01, 07, 09, 13 and 15 were tested under monotonic (ramp) loads with a displacement rate of 0.008 in./s (0.2 mm/s), while Walls 24 and 28 were tested with a rate of 0.016 in./s (0.4 mm/s). All other walls, as shown in Tables 3, 4 and 5, were tested either using CUREE (Method C) or ISO 16670 cyclic testing protocols (Method B), as specified in ASTM E 2126 (ASTM International, 2009), with a rate of 0.196 in./s (5 mm/s). Instrumentation included lateral displacement at the top and bottom of the wall, uplift at both ends, as well as deformation of the wall along the wall diagonals.

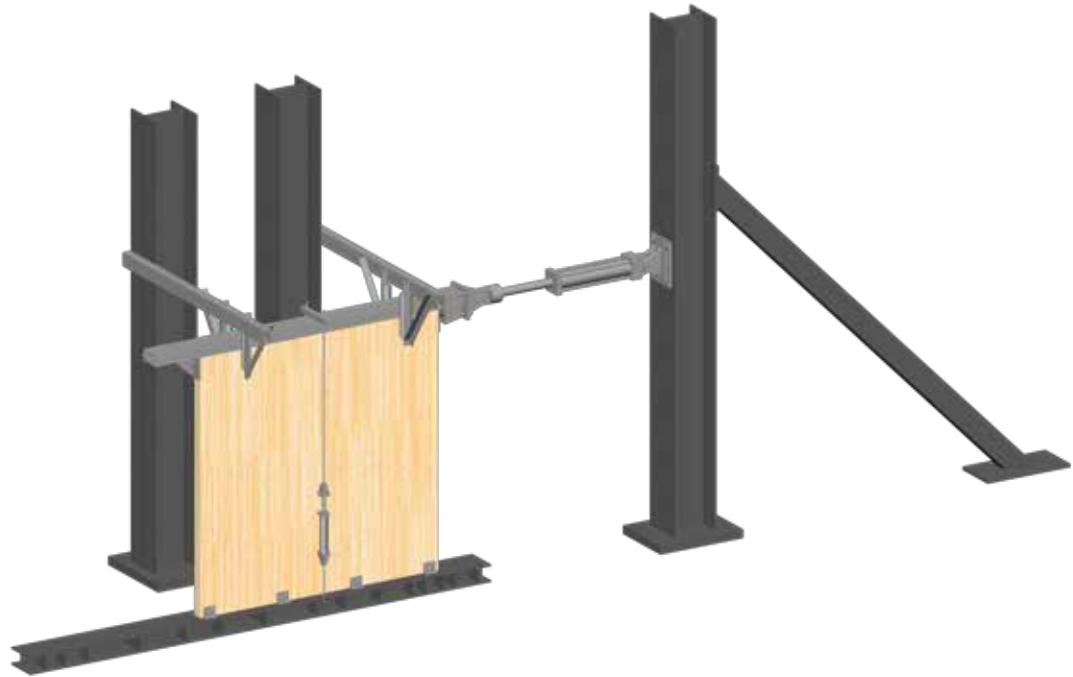

Figure 13
Test setup used for CLT walls

A2.4 Test Observations

As expected, the CLT wall panels behaved almost as rigid bodies during the testing. Although slight shear deformations in the panels were measured, most of the panel deflections occurred as a result of the deformation in the joints connecting the walls to the foundation. In case of multi-panel walls, deformations in the half-lapped joints also had significant contribution to the overall wall deflection. Selected average properties of the CLT walls, based on the envelope curves of both sides of the hysteretic loops obtained from the tests, are given in Table 6. Analysis of the test data was conducted using the procedure specified in ASTM Standard E 2126 (ASTM International, 2009). After determining the envelope curves for the cyclic tests, the Equivalent Energy Elastic Plastic (EEEP) curves were defined and main properties based on these curves were determined. In Table 6, K_y is the initial stiffness, Δ_y the yield displacement, F_{max} the maximum load, Δ_{Fmax} the displacement at maximum load, and Δ_u the ultimate displacement. It should be noted that most findings presented here are based on a single wall test for any different wall arrangement.

Wall 00 with no vertical load had a maximum lateral resistance of 20 kips (88.9 kN) (see Figure 14), while Wall 02 with a 685 lb./ft. (10 kN/m) vertical load had a lateral resistance of 20.3 kips (90.3 kN) (see Figure 16). When the vertical load was increased to 1370 lb./ft. (20 kN/m) (Wall 03), the lateral resistance increased to 22 kips (98.1 kN), an increase of 10% (Figure 15). It seems that the axial load had to be at least 1370 lb./ft. (20 kN/m) or higher to have any significant influence on the lateral load resistance. The amount of vertical load, however, had a higher influence on the wall stiffness. The stiffness of Wall 03 was 28% higher than that of Wall 00. In addition, higher values of vertical load had influence on the shape of the hysteresis loop near the origin. It should be noted that on a system (building) level, the vertical load has relatively significant influence on the seismic performance of CLT buildings, especially at higher deformation levels, when CLT panels basically turn into rocking structural elements.

Table 6

Average wall properties obtained from tests

Wall	K_y [kip/in./ft.]	Δ_y [in.]	F_{max} [kip]	Δ_{Fmax} [in.]	Δ_u [in.]	Δ_u [% drift]	Ductility [Δ_u / Δ_y]	Energy Dissipation [kip-ft.] ^{II}
00	7.3	0.81	20.0	1.77	2.62	2.9	3.5	21.6
01*	8.9	0.72	24.4	1.88	2.16	2.4	3.0	-
02	7.7	0.72	20.3	1.64	2.81	3.1	3.9	24.9
03	9.3	0.67	22.1	1.74	2.50	2.8	3.9	26.5
04	9.6	0.67	23.0	1.54	2.35	2.6	3.6	20.6
05	9.2	0.69	23.1	1.39	2.11	2.3	3.1	23.6
06	8.7	0.69	22.5	1.66	1.97	2.2	2.9	22.3
09*	22.1	0.26	21.0	1.15	1.88	2.1	7.3	-
10A	20.5	0.31	23.0	1.30	1.93	2.1	6.3	25.5
07*	8.9	0.84	27.2	2.07	3.46	3.8	4.1	-
08**	15.5	0.46	26.6	2.09	2.49	2.8	5.4	29.3
08A	16.8	0.45	24.1	1.64	2.27	2.5	5.8	26.6
11	6.3	0.76	17.9	2.13	2.37	2.6	3.2	18.7
12	7.3	0.78	20.8	2.08	2.83	3.1	3.7	25.3
12A	7.4	0.76	20.4	1.61	2.23	2.5	3.0	32.5
20	12.5	0.79	34.2	1.61	2.78	3.1	3.6	42.6
21	9.4	0.34	12.2	1.71	3.34	3.7	9.8	14.7
22	15.6	0.19	9.3	0.48	1.24	1.4	7.5	6.0
22B	15.3	0.20	11.4	0.46	0.98	1.1	5.0	8.7
23	8.7	0.53	16.2	1.83	3.14	3.5	6.1	19.0
13*	31.1	0.40	45.2	1.57	2.77	3.1	6.9	-
14	33.5	0.37	42.9	1.41	2.67	2.9	7.4	67.8
15*	15.4	0.64	35.1	3.42	3.52	3.9	5.5	-
16	11.1	0.72	29.3	3.06	4.22	4.7	5.9	49.2
19 [†]	15.6	0.56	31.7	1.32	2.54	2.8	4.5	45.7
28*	1.6	1.09	6.5	3.52	6.93	3.8	6.3	-
29B [‡]	1.9	0.95	6.6	2.91	4.62	2.5	4.9	4.8
29C	2.1	0.92	7.1	2.93	5.60	3.0	6.1	6.0
24*	3.4	1.86	22.8	2.71	2.78	1.5	1.5	-
25	3.8	1.20	16.9	1.75	3.10	1.7	2.8	31.0
26	4.0	1.43	20.9	2.35	2.95	1.6	2.0	26.2
27	3.5	1.70	20.8	3.94	4.48	2.4	2.7	36.1

* Value from a single monotonic test; ** Hold-down fatigue failure observed; [†] One of the values in the loop for F_u was at 90% of F_{max} ; ^{‡‡} Energy dissipated until the end of the test.

The maximum loads obtained from the monotonic tests were greater than the corresponding values obtained from the cyclic tests for each of the two cyclic protocols, while the ultimate deformations and loads at these deformation levels were slightly underestimated. A designer may wish to consider the monotonic behavior if designing a building in a near fault location. An example of the aforementioned wall behavior is given in Figure 16. It was also observed that, during the static tests, more deformation demand was induced on the brackets themselves than on the fasteners used to connect them. It is therefore suggested that cyclic tests be used for determining the properties of CLT wall panels under seismic loads.

Wall 04, with twelve annular ring nails per bracket, exhibited slightly higher resistance than Wall 03 with eighteen 16d spiral nails per bracket. This was mainly due to the higher withdrawal resistance of the annular ring nails. The ductility of Wall 04, however, was slightly lower than that of Wall 03 (Figure 17). The failure mode observed at the brackets of Wall 04 was also slightly different than that of Wall 03. While spiral nails in the brackets exhibited mostly bearing failure combined with nail deformation and withdrawal, annular ring nails in withdrawal had a tendency to pull out small chunks of wood along the way, as shown in Figure 18.

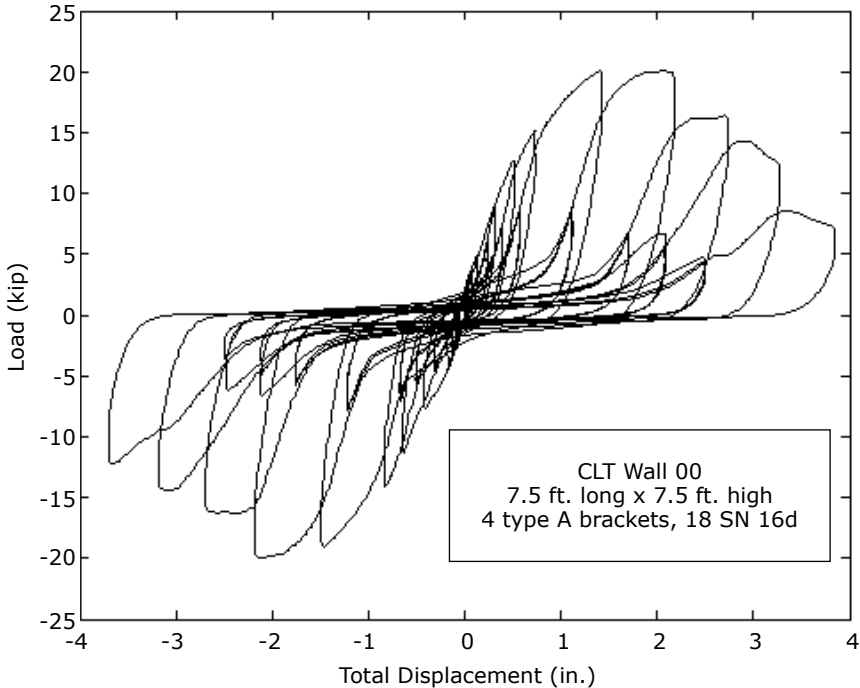

Figure 14
Hysteretic behavior for Wall 00 with no vertical load

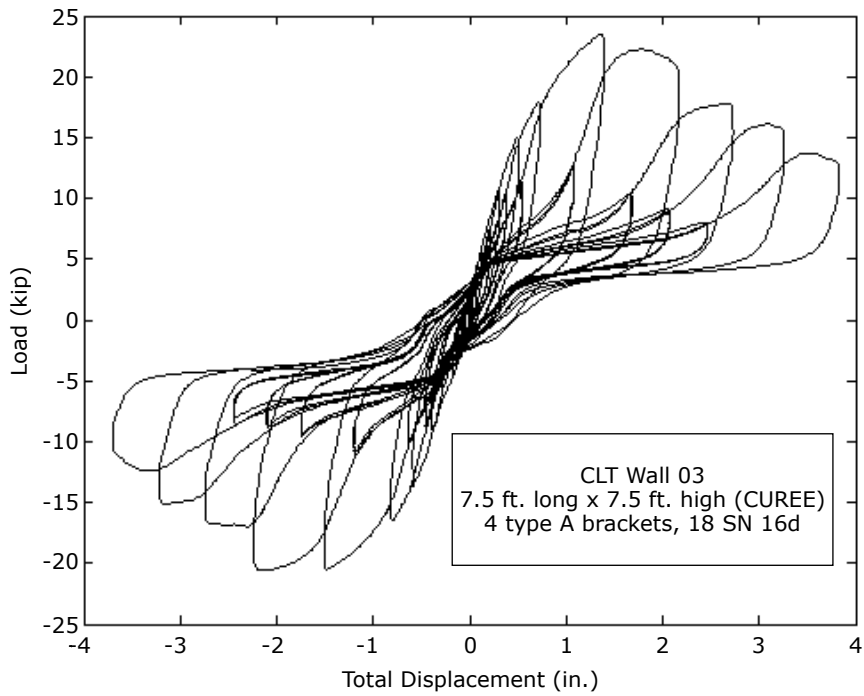

Figure 15
Hysteretic behavior for Wall 03 with 1370 lb./ft. (20 kN/m) vertical load

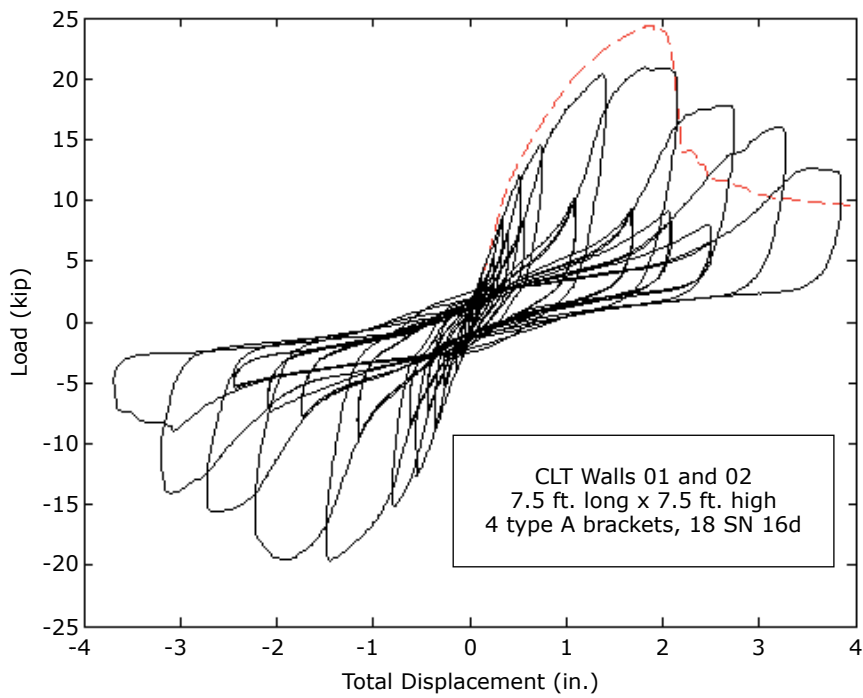

Figure 16
Results from monotonic (dashed line) and cyclic (solid line) tests on CLT walls with Configuration I

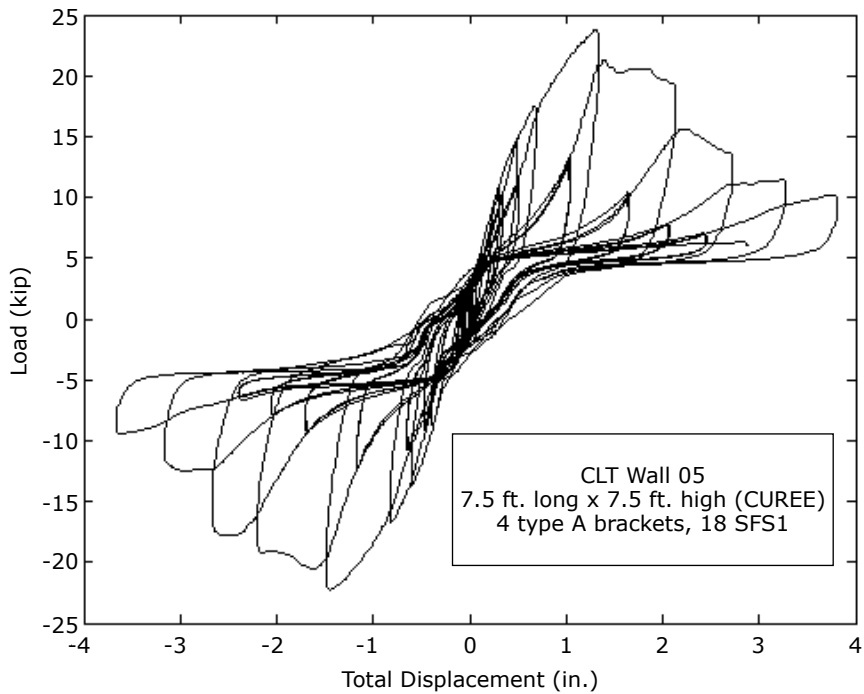

Figure 19

Hysteretic behavior for Wall 05 using 18 SFS1 screws with $D=0.16$ in. (4.0 mm) and $L=2.7$ in. (70 mm)

The CLT wall panel with hold-downs (Wall 08A) showed one of the highest stiffness for a wall with a length of 7.5 ft. (2.3 m), its stiffness being 81% higher than Wall 03 with 18 spiral nails per bracket. This CLT wall also showed relatively high ductility capacity (Figure 21). The behavior of one corner of Wall 08A during testing is shown in Figure 22.

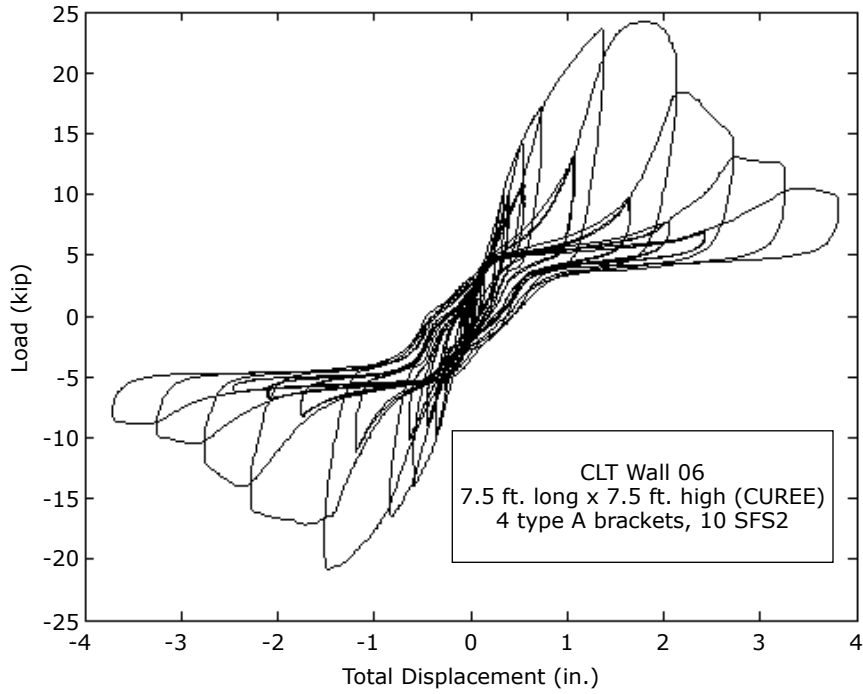

Figure 20
 Hysteretic behavior for Wall 06 using 10 SFS2 screws with $D=0.20$ in. (5.0 mm) and $L=3.5$ in. (90 mm)

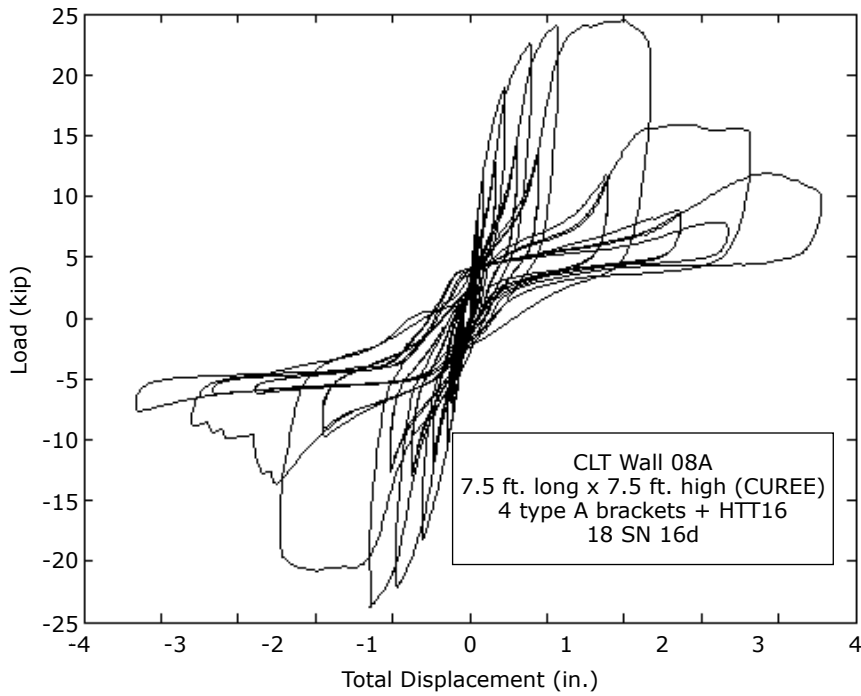

Figure 21
 Hysteretic behavior for Wall 08A using brackets and hold-downs



Figure 22
Behavior of one corner of Wall 08A during testing

Although timber rivets were developed to be used with glulam, they have recently been used in many other engineered wood products that have strands or veneers aligned in one direction. During this research program, an attempt was made to use rivets for the first time in CLT, beside the fact that when driven with their flat side along the grains in the outer layers, the rivets will be oriented across the grain in the middle layer. CLT Wall 10A with ten rivets per bracket exhibited a higher stiffness than any other walls tested in Configuration I and had the second highest capacity for walls having a length of 7.5 ft. (2.3 m), with its stiffness being 220% higher than that of Wall 03 with 18 spiral nails per bracket. Rivets were also able to carry more load per single fastener than any other fastener used in the program. In addition, the wall was able to attain relatively high ductility level. The hysteresis loop for Wall 10A with timber rivets is shown in Figure 23.

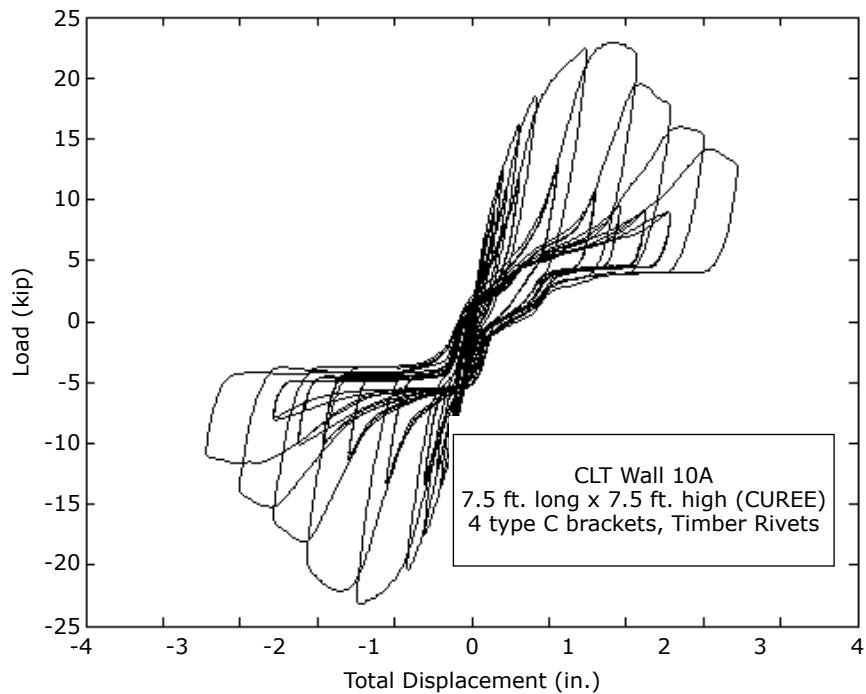

Figure 23
Hysteretic behavior for Wall 10A using timber rivets

By introducing a half-lapped joint in the wall, thus creating a wall made of two separate panels, the behavior of the wall was not only influenced by the types of fasteners in the bottom brackets, but also by the types of fasteners used in the half-lapped joint. These walls (Walls 11 and 12) showed stiffness reduced by 32% and 22%, respectively, and a slightly reduced strength, with respect to the reference Wall 03. Both walls shifted the occurrence of the yield load F_y and ultimate load F_u to higher deflection levels, while only Wall 12 was able to show an increase in its ultimate deflection.



Figure 24
Behavior of Wall 12 using two panels during testing

Wall 11 with WT-T screws in the half-lapped joint showed ultimate load reduced by 19%, while Wall 12 with regular 0.20 in. (5.0 mm) x 3.5 in. (90 mm) screws showed a reduction of only 5%. In addition, Wall 11 showed higher reduction of ductility compared to the reference Wall 03, while the ductility for Wall 12 was only slightly lower than that of the reference wall. Based on the results, in the case of multi-panel walls with half-lapped joints, the use of regular screws is recommended in high seismic zones. A photo of Wall 12 during the testing is shown in Figure 24, while the behavior of Walls 11 and 12 are shown in Figures 25 and 26, respectively.

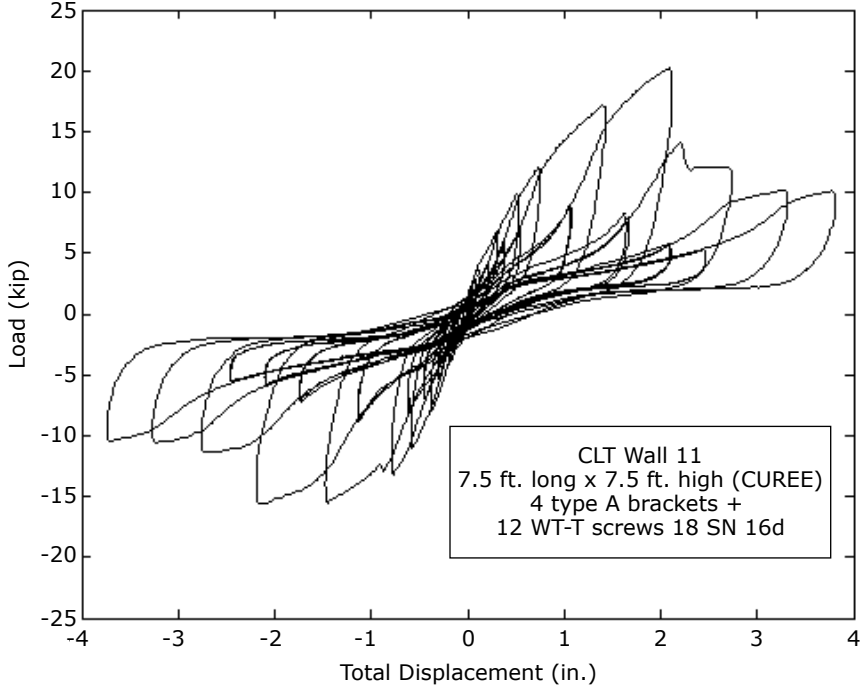

Figure 25
Hysteretic behavior for Wall 11 with 0.15 in. (3.8 mm) x 3.5 in. (89 mm) WT-T screws used in the half-lapped joints

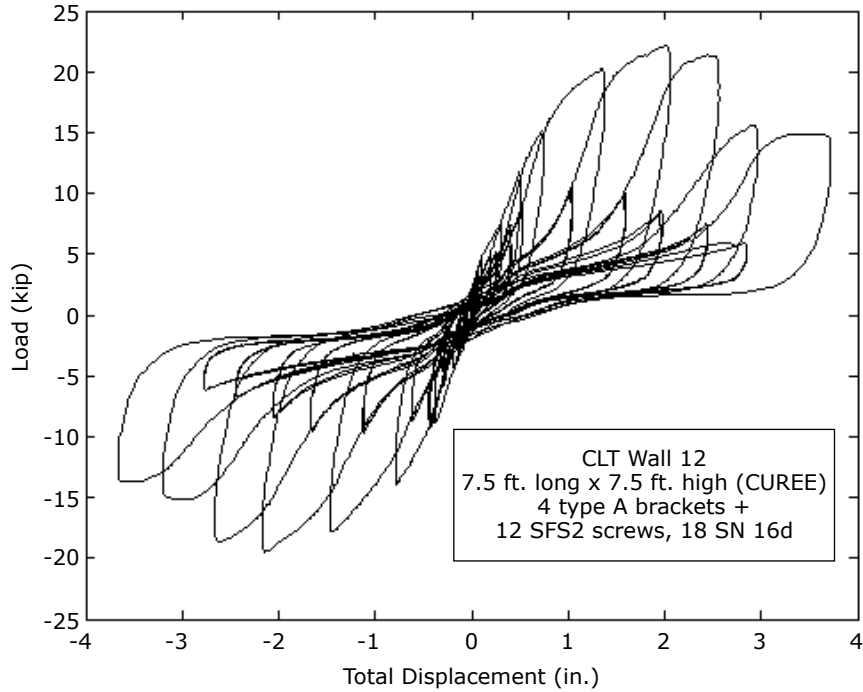

Figure 26

Hysteretic behavior for the two-panel Wall 12 with 0.2 in. (5.0 mm) x 3.5 in. (90 mm) SFS2 screws used in the half-lapped joints under CUREE cycling protocol

The presence of the half-lapped joints and the type of fasteners used to connect them was found to have more significance on the overall wall behavior as the length of the wall increases. For example, results from Walls 14 and 16, which had lengths of 11.3 ft. (3.45 m), show a significant change in stiffness and strength for Wall 16 with half-lapped joints (Figure 28) compared to Wall 14, which had no half-lapped joints (Figure 27). The half-lapped joints enabled Wall 16 to carry a significant portion of the maximum load at higher deformation levels, but at a considerable (25%) reduction in maximum strength.

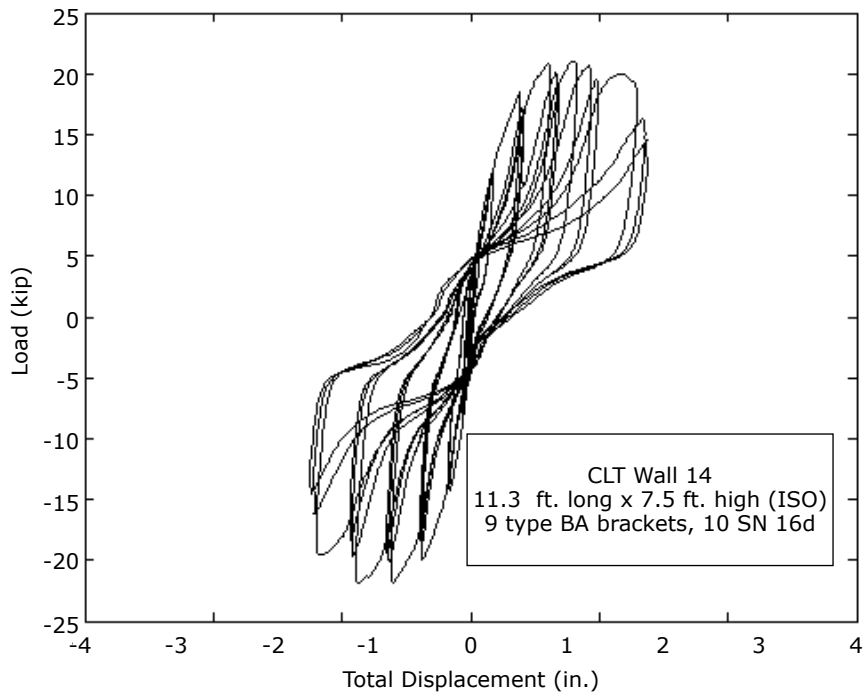

Figure 27
Hysteretic behavior for Wall 14 consisting of one 11.3 ft. (3.45 m) long panel

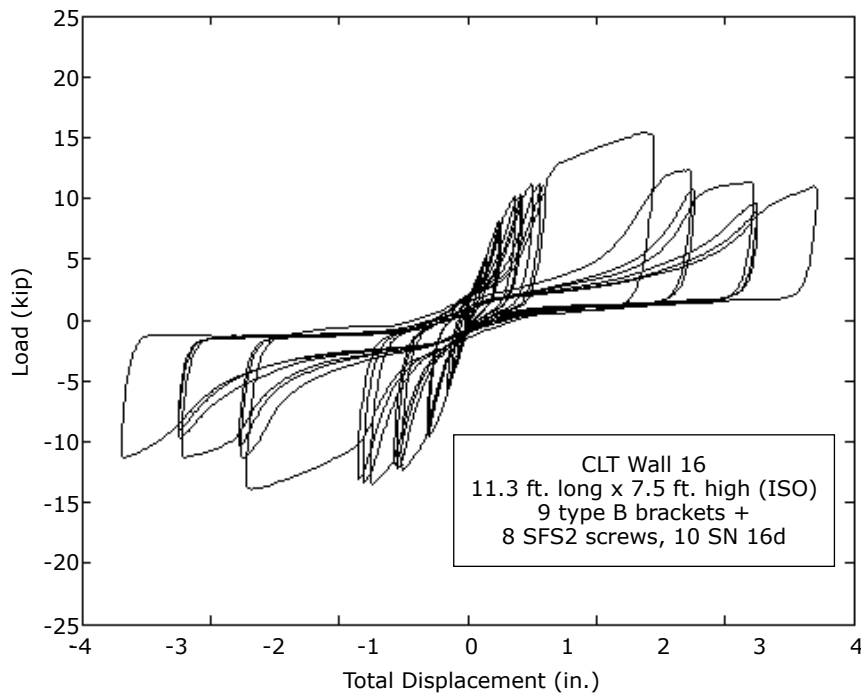

Figure 28
Hysteretic behavior for the three-panel Wall 16 where panels were connected with regular 0.2 in. (5.0 mm) x 3.5 in. (90 mm) SFS2 screws

It is a well-known fact that the protocol used for cyclic testing of wood-based connections or structural assemblies has an influence on the test results. By comparing results for Walls 12 and 12A (Figures 26 and 29), it can be seen that the choice of the protocol had very little influence on the stiffness of the wall, the yield deflection (both determined using the EEEP method), and the maximum load (Table 6). However, there was significant difference in the deflection at which the maximum load was reached (1.6 in. (41 mm) with ISO vs. 2.1 in. (53 mm) with CUREE), and in the ultimate deflection, which was 2.8 in. (72 mm) using the CUREE protocol vs. 2.2 in. (57 mm) using the ISO protocol.

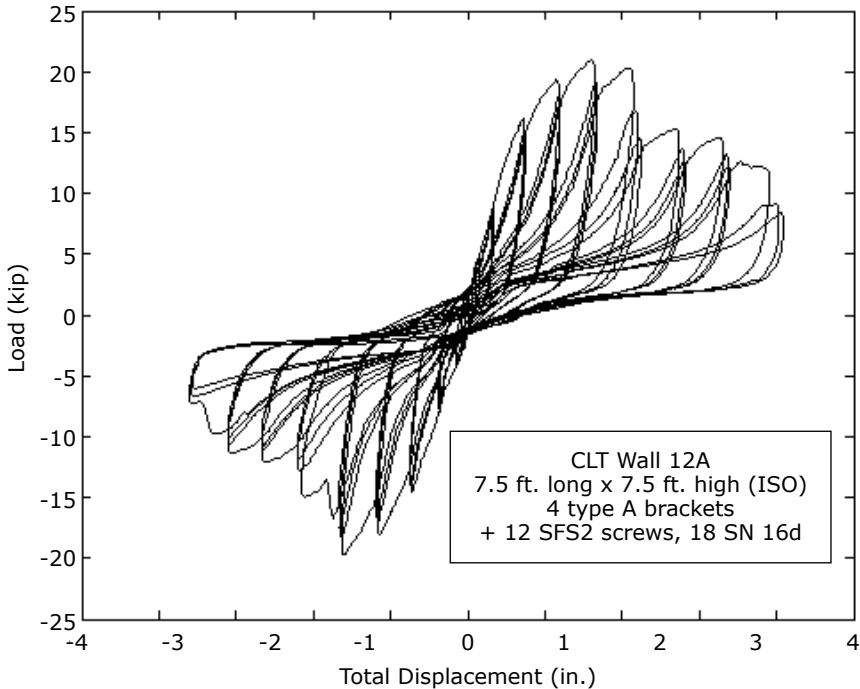

Figure 29
Hysteretic behavior for the two-panel Wall 12A tested under ISO cycling protocol

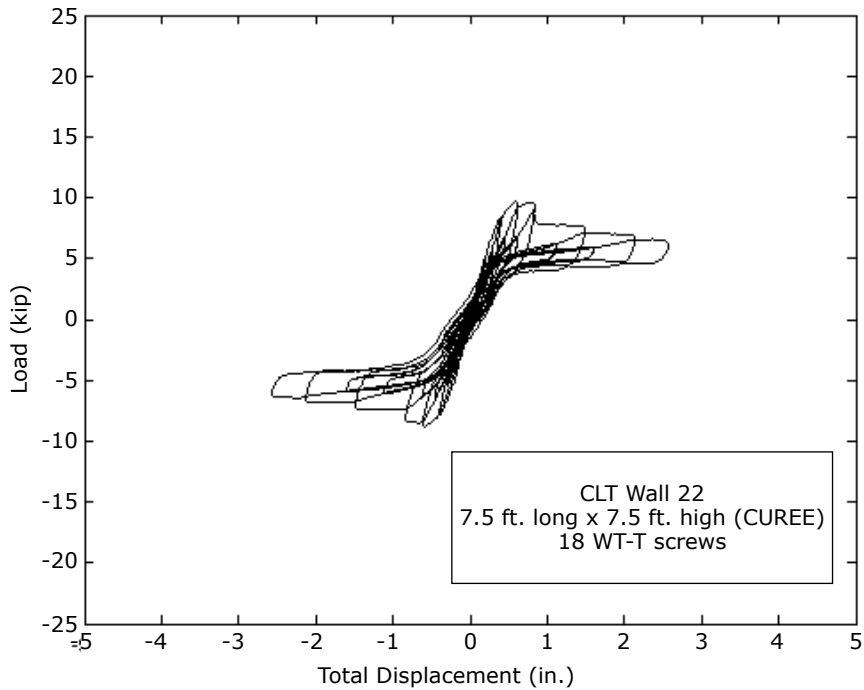

Figure 30

Hysteretic behavior for Wall 22 with WT-T screws

Walls 22 (Figure 30) and 22B that were connected to the base CLT panel with WT-T type screws placed at 45° showed lower resistance than any single story wall in the program. Grouping the screws at the ends of the panels (Wall 22B) created a hold-down effect and helped increasing the wall capacity by about 30% compared to that of Wall 22. Based on the test results, the use of screws at an angle as a primary connector for wall-to-floor connections is not recommended for structures in seismic regions due to reduced capability for energy dissipation (Figure 30) and the sudden pull-out failure of screws in tension.

The behavior of the tall walls specimens with riveted connections was highly influenced by the number of rivets used in each bracket. Although the number and spacing of the rivets in the brackets for Walls 24, 25 and 26 were chosen to satisfy the rivet yielding failure mode according to the existing Canadian code specifications for sawn lumber and glulam, they did not yield but experienced fastener pull-out combined with a wood shear plug failure mode (Figure 31a). This failure mode is not ductile and should be avoided in practice. By increasing the spacing between the rivets in Wall 27, the failure mode was changed to the desired rivet yielding mode (Figure 31b).



a)

b)

Figure 31

Bracket failure modes for a) Wall 25 with 40 L=2.56 in. (65 mm) rivets, and b) Wall 27 with 20 L=3.5 in. (90 mm) rivets

Finally, several two-story wall tests have been conducted by Popovski et al. (2010) and interested readers are referred to that paper for further information on test setup, protocol, and results.

APPENDIX B

DESIGN EXAMPLE

B1 Performance of a Multi-story CLT Building Designed Using Force-based Design

Utilizing the results of the numerical model and shear wall tests (FPInnovations) introduced earlier in this Chapter, a multi-story CLT building assumed to be located at a generic California site was designed using the Equivalent Lateral Force Procedure (ELFP) outlined in ASCE 7-10. The performance of the as-designed structure was then assessed numerically under a suite of earthquake ground motions scaled to both the design basis earthquake (DBE) and maximum considered earthquake (MCE) intensity.

The floor plan of the NEESWood Capstone building (Pei et al., 2009; van de Lindt et al., 2010) was used to illustrate the design process and quantitatively present the performance of a mid-rise (6-story) CLT building. In the Equivalent Lateral Force Procedure outlined in ASCE 7-10, a response modification factor (R) must be selected based on the lateral force resisting system being utilized in the design. However, as explained earlier in this Chapter, seismic response modification factors are not yet available for CLT systems in the United States. Therefore, the design was repeated for four different R-factors over a range, namely R=2, 3, 4, and 6. The basic building properties used in the ELFP are listed in Table 7.

Table 7
Building properties used in the illustrative design examples

Story	1	2	3	4	5	6
Concentrated Story Weight (kips)	95.7	95.7	95.7	95.7	88.7	62.6
Cumulative Weight (kips)	534.2	438.5	342.8	247.1	151.4	62.6
Height from Ground (ft.)	9	18	27	36	45	54

The design spectral values used for this example are $S_{DS}=1.0$ g and $S_{D1}=0.6$ g (corresponding to MCE level $S_s=1.5$ g and $S1=0.9$ g). The base shear coefficients based on the ELFP were calculated to be 0.50, 0.33, 0.25, and 0.17 for R=2, 3, 4, and 6, respectively. The design of the CLT building was conducted by selecting a CLT wall configuration for each story based on the LRFD wall resistance per Table 2 in Section 5. The wall selection in this design example is constrained by the architectural floor plan (shown in Figure 32) in that only a limited amount of wall segments can be placed in each story. The list of available wall segments and their lengths for each story is summarized in Table 8. Note that the X-direction is the long direction of the floor plan; the Y-direction is the short direction. This notation will be used throughout this illustrative example.

Table 8

Number of various length wall segments for each story at each direction

Segment Length (ft.)	3	4	5	6	8	12	16	20
Story 1-5: X	4	5	2	0	0	2	2	2
Story 1-5: Y	4	2	6	2	2	2	0	1
Story 6: X	4	5	2	0	0	0	2	1
Story 6: Y	4	2	2	2	0	2	0	0

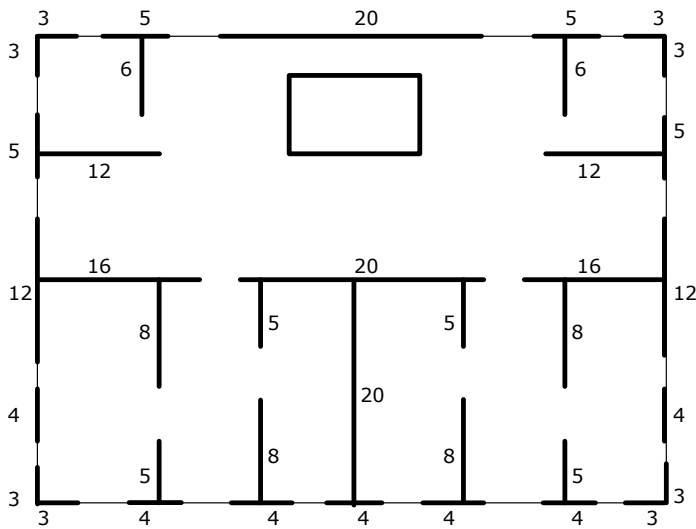

(a)

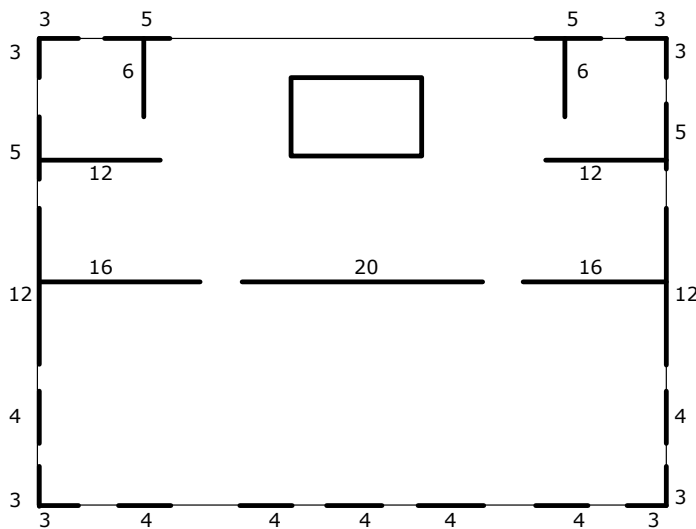

(b)

Figure 32

Wall segments (lengths in ft.) allowed for example building floor plans (a) stories 1-5 and (b) story 6.

The resulting designs are presented in Table 9. Because the 2S configuration is the weakest configuration available, some of the available wall segments were not designated as structural walls if the story shear demand was exceeded using 2S configuration on part of the available wall segments. The nonlinear time history analysis conducted later in this example considered only the structural wall segments, i.e. the lateral resistance contribution from other panels was neglected.

Table 9

Wall design configurations and total length selected to satisfy shear demands

Story	R=2			R=3			R=4			R=6		
	Config.	X ¹	Y ¹	Config.	X ¹	Y ¹	Config.	X ¹	Y ¹	Config.	X ¹	Y ¹
1	4DE	138	122	2DE	118	102	2S	138	122	2S	98	78
2	4DE	138	122	2DE	118	102	2S	138	122	2S	98	78
3	3DE	138	122	2DE	98	78	2S	138	122	2S	90	78
4	2DE	138	122	2S	138	122	2S	98	78	2S	58	50
5	2S	138	122	2S	118	102	2S	66	62	2S	34	40
6	2S	94	66	2S	42	30	2S	42	30	2S	26	20

¹Total wall length (in feet) selected to satisfy shear demands

The performance of the 6-story building was assessed using nonlinear time history analysis with a suite of ground motions. The ground motion suite included 22 bi-axial far-field ground motions developed during the ATC-63 research project (ATC, 2008; FEMA, 2009). These ground motions were scaled so that their averaged response spectrum approximately matches the design response spectra at DE and MCE levels. The bi-axial ground motions were also rotated by 90 degrees and thus, at each hazard level, each design was analyzed using each of the 22 record pairs for a total of 44 analyses.

The maximum story drift experienced by the building was obtained from each nonlinear time history simulation, resulting in 44 maximum story drift values for each building at each hazard level. These maximum drift values were rank-ordered and plotted as empirical cumulative distribution functions (CDF) as shown in Figures 33 and 34. Story drift levels of 3.5% during CLT wall tests have been observed, during which the structure remains stable. The analysis presented herein utilizes 3.5% as a story drift limit for purposes of the nonlinear time history analyses in this Appendix. It is noted that this drift limit is still considered preliminary because full CLT systems have not yet been tested to failure to verify the suitability of this story drift limit.

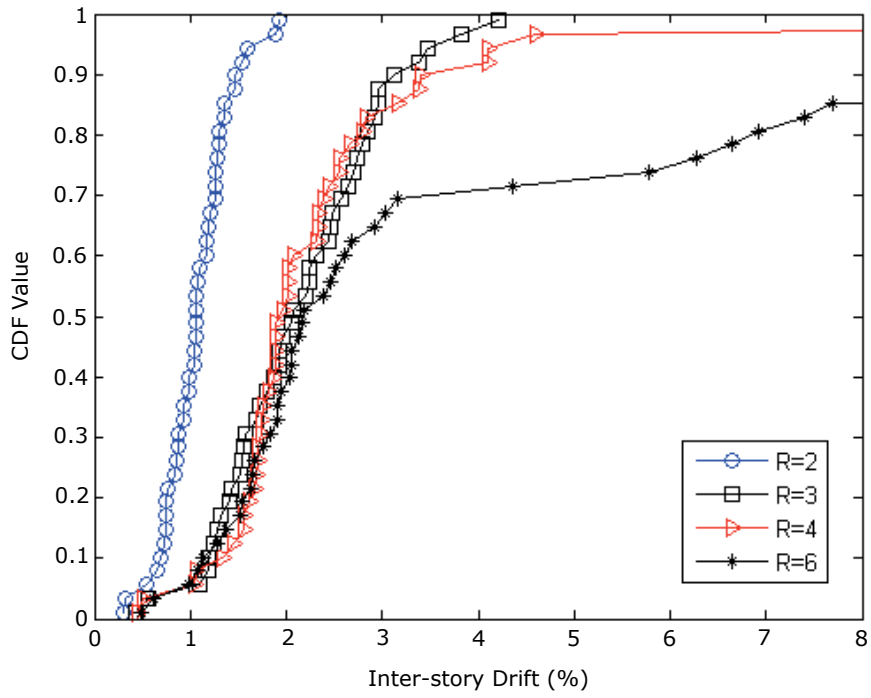

Figure 33
Performance of as-designed CLT building under DE level

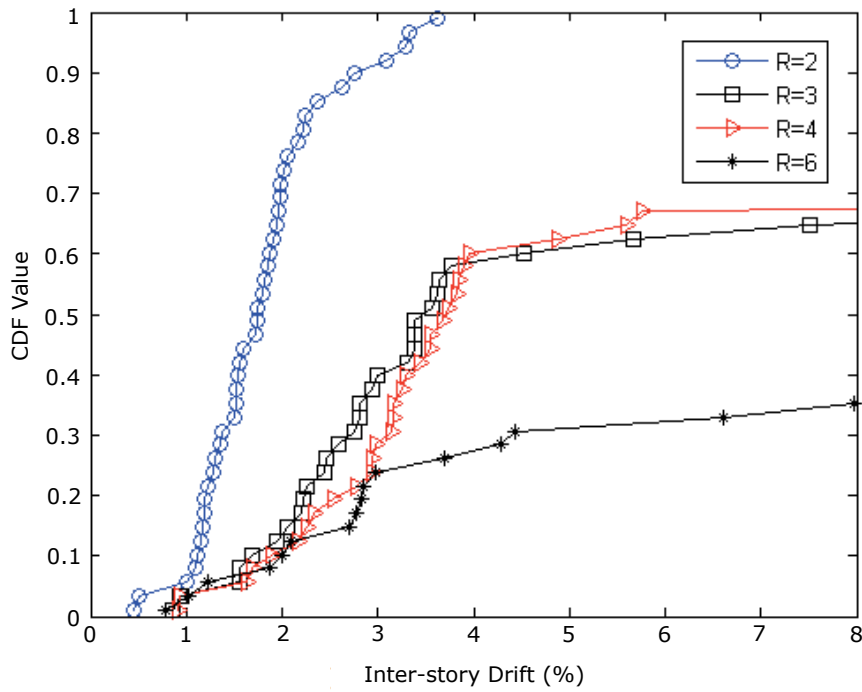
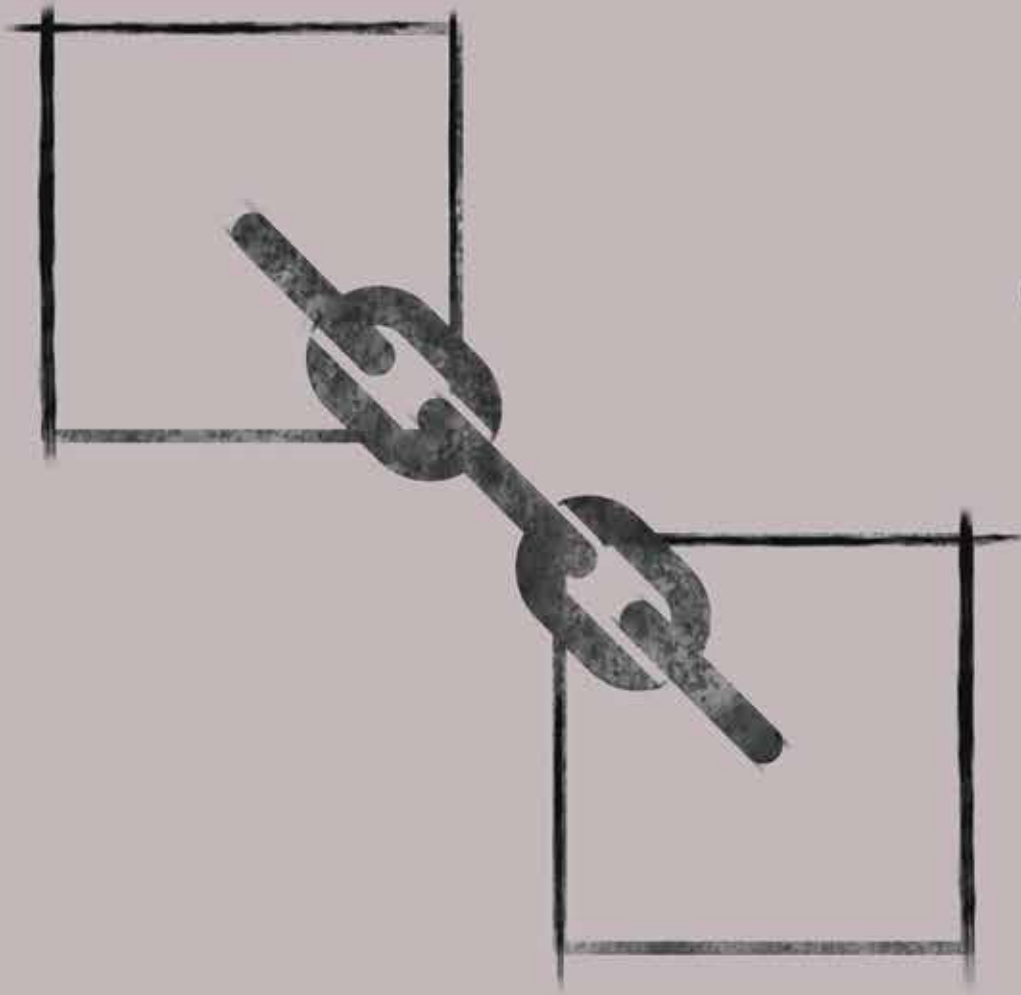

Figure 34
Performance of as-designed CLT building under MCE level

It can be seen that, when subjected to the suite of DBE level ground motions, there was greater than a 90% non-exceedance for R less than 4. At R=6, the probability of not exceeding 3.5% story drift reduces to about 70%. At the MCE intensity, a maximum story drift of 3.5% corresponds to approximately less than a 10% exceedance probability using R equal to 2.

While discussing Figures 33 and 34, there are a few important assumptions that should be kept in mind. The numerical model used in this analysis ignored the contribution from all non-structural walls and did not account for boundary conditions resulting from other transverse wall sections. In typical CLT construction, the panels that are not selected in the design as structural will also be connected minimally to the floor diaphragm, thus contributing to building lateral resistance. Additionally, collapse is judged to occur at 3.5% story drift but the collapse mechanism is not specifically modeled. Determination of simulated collapse mechanisms and story drift levels associated with collapse are subject to future refinement of CLT modeling and evaluation.



Connections

Connections in
cross-laminated timber buildings

CHAPTER 5

Authors

Mohammad Mohammad, Ph.D., P.Eng., FPIInnovations
Bradford Douglas, P.E., American Wood Council
Douglas Rammer, P.E., USDA Forest Products Laboratory
Steven E. Pryor, P.E., S.E., Simpson Strong-Tie

Peer Reviewers

Dr.-Ing. Hans Joachim Blaß, Karlsruher Institut für Technologie, Germany
Christian Dagenais, Eng., M.Sc., FPIInnovations
Phil Line, P.E., American Wood Council
Robert H. White, Ph.D., USDA Forest Products Laboratory
Thomas D. Skaggs, Ph.D., P.E., APA

ACKNOWLEDGEMENTS

The U.S. Edition of the CLT Handbook: *cross-laminated timber* combines the work and knowledge of American, Canadian and European specialists. The handbook is based on the original Canadian Edition of the CLT Handbook: *cross-laminated timber*, that was developed using a series of reports initially prepared by FPInnovations and collaborators to support the introduction of CLT in the North American market. A multi-disciplinary team revised, updated and implemented their know-how and technologies to adapt this document to U.S. standards.

The publication of this handbook was made possible with the special collaboration of the following partners:



The editing partners would also like to express their special thanks to Binational Softwood Lumber Council, Forestry Innovation Investment (FII), Nordic Engineered Wood, Structurlam, and CLT Canada for their financial contribution to studies in support of the introduction of cross-laminated timber products in the United States of America.



© 2013 FPInnovations and Binational Softwood Lumber Council. All rights reserved.

The U.S. Edition of the CLT Handbook: *cross-laminated timber* can be electronically downloaded without charge from the website www.masstimber.com. Additional information can be obtained by visiting the websites of FPInnovations, USFPL, American Wood Council (AWC), APA and U.S. WoodWorks. Hard copies can be obtained through AWC (www.awc.org).

No part of this published Work may be reproduced, published, or transmitted for commercial purposes, in any form or by any means, electronic, mechanical, photocopying, recording or otherwise, whether or not in translated form, without the prior written permission of FPInnovations and Binational Softwood Lumber Council.

The information contained in this Work represents current research results and technical information made available from many sources, including researchers, manufacturers, and design professionals. The information has been reviewed by professionals in wood design including professors, design engineers and architects, and wood product manufacturers. While every reasonable effort has been made to insure the accuracy of the information presented, and special effort has been made to assure that the information reflects the state-of-the-art, none of the above-mentioned parties make any warranty, expressed or implied, or assume any legal liability or responsibility for the use, application of, and/or reference to opinions, findings, conclusions, or recommendations included in this published work, nor assume any responsibility for the accuracy or completeness of the information or its fitness for any particular purpose.

This published Work is designed to provide accurate, authoritative information but is not intended to provide professional advice. It is the responsibility of users to exercise professional knowledge and judgment in the use of the information.

ABSTRACT

The light weight of cross-laminated timber (CLT) products combined with the high level of prefabrication involved, in addition to the need to provide wood-based alternative products and systems to steel and concrete, have significantly contributed to the development of CLT products and systems, especially in mid-rise buildings (5 to 9 stories). While this product is well-established in Europe, work on the implementation of CLT products and systems has just begun in the United States and Canada. The structural efficiency of the floor system acting as a diaphragm and that of walls in resisting lateral loads depends on the efficiency of the fastening systems and connection details used to interconnect individual panels and assemblies together. A combination of metal brackets/plates and self-tapping screws or long self-tapping screws are typically recommended by the CLT manufacturers and are commonly used for connecting panels to panels in floors and floor-to-wall assemblies. However, there are other types of traditional and innovative fasteners and fastening systems that can be used efficiently in CLT assemblies.

This Chapter focuses on a few fastening systems that reflect present-day practices, some being conventional, while others are proprietary. Given the recent introduction of CLT into the construction market, it is expected that new connection types will be developed over time. Issues associated with connection design specific to CLT assemblies are presented. The European design approach is also presented and the applicability of the *National Design Specification (NDS) for Wood Construction* design provisions for traditional fasteners in CLT such as bolts, dowels, nails, and wood screws are reviewed and design guidelines are provided. Several design examples are also given at the end to demonstrate how connections in CLT can be established using current NDS design provisions.

The information given in this Chapter is aimed at U.S. designers, a group which expressed a strong interest in specifying CLT products for non-residential and multi-story applications. However, further studies are needed to assist designers in the development of U.S. engineering design specifications and procedures consistent with the U.S. material design standards and the International Building Code. The technical information will also be further used to facilitate code acceptance of CLT products in North America.

TABLE OF CONTENTS

Acknowledgements	ii
Abstract	iii
List of Tables	vi
List of Figures	vi
1	Cross-laminated Timber in Construction 1
2	Common Structural Systems in CLT 2
3	Introduction to Connections in CLT Assemblies - Overview 3
3.1	General 3
3.2	Connection Systems Commonly used in CLT Assemblies 3
3.2.1	Wood and Self-tapping Screws 4
3.2.2	Nails 5
3.2.3	Bolts and Dowels 5
3.2.4	Bearing Types of Fasteners 5
3.2.5	Innovative Type of Fasteners 5
4	Connections in CLT Assemblies - Details 6
4.1	Panel-to-panel (Detail A) 7
4.1.1	Internal Splines 7
4.1.2	Single Surface Spline 8
4.1.3	Double Surface Splines 9
4.1.4	Half-lapped Joint 9
4.1.5	Tube Connection System 10
4.2	Wall to Wall (Detail B) 10
4.2.1	Self-tapping Screws 10
4.2.2	Wooden Profiles 12
4.2.3	Metal Brackets 13
4.2.4	Concealed Metal Plates 14

4.3	Wall to Floor (Detail C)	15
4.3.1	Platform Construction	15
4.3.1.1	Self-tapping Screws	15
4.3.1.2	Metal Brackets	15
4.3.1.3	Concealed Metal Plates	17
4.3.2	Balloon Construction	17
4.4	Roof to Wall (Detail D)	19
4.5	Wall to Foundations (Detail E)	21
4.5.1	Visible/Exposed Plates	21
4.5.2	Concealed Hardware	23
4.5.3	Wooden Profiles	24
5	Connections in Mixed Hybrid CLT Construction - Details	25
5.1	Mixed CLT with Other Wood-based Materials and Systems	25
5.1.1	Platform Construction	25
5.1.2	Balloon Construction	27
6	Designing Connections in Cross-laminated Timber	28
6.1	Why Connections in CLT are Different than those in Solid Timber or Glulam	28
6.2	Design Approach for Lateral Connections in CLT	29
6.2.1	Fasteners Driven Perpendicular to the Plane of the Panel	30
6.2.2	Dowel-type Fasteners Driven in the Narrow Side of the CLT Panel	30
6.3	Design Approach for Withdrawal Connections in CLT	31
6.4	Placement of Fasteners in Joints	32
6.5	Detailing of Connections in CLT	33
7	Design Examples	35
7.1	Example 1: Bolted Lateral Connection in CLT Face Lamination	35
7.1.1	Metal Plate Connection to CLT	35
7.2	Example 2: Lag Screw Lateral Connection in CLT Face Lamination	37
7.2.1	Design of Half-lapped Joint for Shear Parallel to the Face Grain of the Panels	37
7.3	Example 3: Lag Screw Withdrawal Connection from CLT Face Lamination	39
7.4	Example 4: Design of Corner Joint (i.e. Wall Intersection) for Out-of-Plane Loads	40
7.4.1	Lag Screw Lateral Connection in CLT Edge	40
7.4.2	Lag Screw Withdrawal Connection in CLT Edge	41
7.5	Example 5: Design of Nailed Metal Plate Connection to CLT	42
8	Conclusion	44
9	References	45

List of Tables

<i>Table 1</i>	Minimum fastener spacing and distances in the narrow side of cross-laminated timber (adapted from Draft CEN CLT standard, 2010)	33
----------------	---	----

List of Figures

<i>Figure 1</i>	Typical CLT building with various components and connections	1
<i>Figure 2</i>	Different types of CLT construction systems: (a) platform construction; (b) mixed CLT walls and light frame roof	2
<i>Figure 3</i>	Self-tapping screws used in CLT connections	4
<i>Figure 4</i>	Pneumatically driven nails used in combination with perforated metal plates	5
<i>Figure 5</i>	Typical two-story CLT building showing various connections between floor and wall panels	6
<i>Figure 6</i>	Single internal spline	7
<i>Figure 7</i>	Double internal splines	8
<i>Figure 8</i>	Single surface spline	8
<i>Figure 9</i>	Double surface spline	9
<i>Figure 10</i>	Details of half-lapped joints	9
<i>Figure 11</i>	Details of the tube connection system	10
<i>Figure 12</i>	Self-tapping screws from the exterior	11
<i>Figure 13</i>	Installation of self-tapping screws from the exterior	11
<i>Figure 14</i>	Self-tapping screws driven at an angle (toe-screwing)	12
<i>Figure 15</i>	Concealed wooden profile	12
<i>Figure 16</i>	Edge protecting wooden profile	13
<i>Figure 17</i>	Interior metal bracket	13
<i>Figure 18</i>	Concealed metal plate	14
<i>Figure 19</i>	Self-drilling dowel through steel and wood	14
<i>Figure 20</i>	Self-tapping screws	15
<i>Figure 21</i>	Metal brackets	16

- Figure 22* Metal bracket and self-tapping screws 16
- Figure 23* Concealed metal plates 17
- Figure 24* SCL components for bearing support (adapted from TRADA, 2009) 18
- Figure 25* Metal bracket used to provide bearing support (adapted from TRADA, 2009) 18
- Figure 26* Possible roof-to-wall joints configurations 19
- Figure 27* Self-tapping screws 19-20
- Figure 28* Metal brackets 20
- Figure 29* Exterior metal plate 21
- Figure 30* Example of a connection detail with a gap between CLT wall and concrete foundation 22
- Figure 31* Metal brackets 22
- Figure 32* Metal brackets installed on site 23
- Figure 33* Concealed metal plates 23
- Figure 34* Concealed (a) and exposed (b) wooden profiles 24
- Figure 35* CLT wall – I-joist (adapted from TRADA, 2009) 26
- Figure 36* CLT wall – Engineered floor (adapted from TRADA, 2009) 27
- Figure 37* CLT wall – I-joist (adapted from TRADA, 2009) 27
- Figure 38* CLT panel section with gaps and grooves sawn in the timber to relieve shrinkage stresses 28
- Figure 39* Ductile failure modes typically experienced during testing of self-tapping screws in CLT half-lapped connections 29
- Figure 40* End and edge distances and spacings for dowel-type fasteners driven on edge (adapted from Draft CEN CLT standard, 2010) 32
- Figure 41* Acoustic membrane inserted between walls and floors and underneath the metal bracket connector to provide air tightness (in exterior walls) and improve sound insulation 33
- Figure 42* Tight fit between individual panels is ensured using special installation devices 34
- Figure 43* Bolted lateral connection in CLT face lamination 36
- Figure 44* Lateral resistance of half-lapped joint using lag screws 37
- Figure 45* Withdrawal resistance of lag screws from CLT face lamination 39
- Figure 46* Corner joint: lag screw lateral resistance in CLT edge 40

Figure 47 Corner joint: lag screw withdrawal resistance in CLT edge 42

Figure 48 Nailed metal plate connection to CLT (lateral and withdrawal) 43

1 CROSS-LAMINATED TIMBER IN CONSTRUCTION

Use of cross-laminated timber (CLT) panels in building construction has increased over the last few years. Several buildings have already been erected around the world, including North America, using CLT panels, which is a good testimony to the many advantages that this product offers to the construction industry. The light weight and the high quality of prefabrication of CLT result in quick erection times, especially in mid-rise construction (5 to 9 stories). While this product is well-established in Europe, work on the implementation of CLT products and systems has just begun in the United States and Canada.

The structural efficiency of the floor system acting as a diaphragm and that of walls in resisting lateral loads depends on the efficiency of the fastening systems and connection details used to connect individual panels and assemblies. This Chapter focuses on the design of connections for CLT construction based on current practices.



Figure 1
Typical CLT building with various components and connections

2 COMMON STRUCTURAL SYSTEMS IN CLT

There are several ways to design and construct CLT buildings. They all differ in the way the load-carrying panels/elements are arranged, the way the panels are connected together and by the type of wood and non-wood based materials used (such as the use of hybrid systems of construction). The most common forms of construction systems in CLT are:

Platform construction, where the floor panels rest directly on top of wall panels, therefore forming a platform for subsequent floors (Figure 2a). This is a typical North American light frame form of construction, except that CLT panels are used instead of stud wall systems with top and bottom plates. This is probably the most commonly used type of structural system in Europe for CLT assemblies, especially for multi-story buildings. This includes buildings constructed exclusively with CLT or mixing CLT with other types of wood-based products (e.g., CLT and glulam) or CLT with non-wood-based systems. There are several advantages to this system:

- it simplifies the erection of upper stories;
- simple connection systems can be used; and
- the load path is usually well-defined.

Balloon construction, a type of structural system where the walls continue for a few stories with intermediate floor assemblies attached to those walls. Due to the limitations in the length of the CLT panels and other design and construction issues, this system is often used in low-rise, commercial or industrial buildings. Connections are usually more complex in this form of construction. Balloon construction is generally less common compared to platform construction. As with platform construction, mixed CLT and other types of wood-based and non-wood-based products could also be used in the balloon type of systems.



(a)



(b)

Figure 2

Different types of CLT construction systems: (a) platform construction; (b) mixed CLT walls and light frame roof

3

INTRODUCTION TO CONNECTIONS IN CLT ASSEMBLIES - OVERVIEW

3.1 General

Connections in heavy timber construction, including those built with CLT, play an essential role in providing strength, stiffness, stability and ductility to the structure; consequently, they require careful attention by designers. Post-disaster surveys following strong earthquakes and hurricanes have shown that, among other reasons, structural failures often occur due to inadequately designed or improperly installed connections. The interruption of continuity in the timber structure caused by the presence of connections may result in a decrease in the overall strength and stiffness of the structure (i.e., if not properly designed or constructed) which in turn implies an increase in the cross-section of the assembled timber elements.

When structural members are attached with fasteners or some other types of metal hardware, such joints are referred to as “mechanical connections”. Typically, large fastener spacing as well as end and edge distances are required in most mechanical connections to avoid splitting and shear failures that are brittle in nature. The efficient design and fabrication of connections often determines the level of success of timber buildings when competing with other types of structural applications such as steel or concrete. This is particularly important for multi-story heavy timber structures and hybrid buildings, where CLT is used alone or could be used in combination with steel or concrete components.

The use of CLT panels enables a high degree of prefabrication at the plant. This is facilitated by the use of computer numerically controlled (CNC) machining technology to profile the panel for installation, at the plant, of conventional and sophisticated connection systems with a high degree of accuracy and efficiency. The dimensional stability of CLT products due to the use of kiln-dried (KD) source material is better for connection ‘stability’ prior to installation and ensures good accuracy at installation.

In this section, a very brief overview of connection types is provided. More detailed information is provided in Section 4 of this Chapter.

3.2 Connection Systems Commonly used in CLT Assemblies

Currently, there is a wide variety of fasteners and many different types of joint details that can be used to establish roof/wall, wall/floor, and inter-story connections in CLT assemblies or to connect CLT panels to other wood-based, concrete or steel elements in hybrid construction. While long self-tapping screws are typically recommended by CLT manufacturers and are commonly used for connecting panels to panels in floors and

floor-to-wall assemblies, traditional dowel-type fasteners such as wood screws, nails, lag screws, bolts and dowels can also be effectively used in connecting panel elements together. Other types of traditional fasteners, including bearing type fasteners such as split rings and shear plates, and tooth plates, may have some potential; however, their use is expected to be limited to applications where high loads are involved. Some interesting innovative connection systems are finding their way to the CLT construction market. These include glued-in rods, the KNAPP® system and other systems that adopt similar concepts. Such systems have good potential for use in CLT applications, especially those that employ a high degree of prefabrication using CNC machining technology. Fortunately, major CLT panel and glulam manufacturing facilities are equipped with CNC technology which could facilitate the rapid adoption of such connection systems. The choice of the type of connection to use depends largely on the type of assemblies to be connected (i.e., panel-to-panel, floor to wall, etc.), panel configurations, and the type of structural system used in the building.

The following sections provide some basic information on the most commonly used types of mechanical fasteners in CLT assemblies. Detailed applications of these fasteners are presented in Section 4 of this Chapter.

3.2.1 Wood and Self-tapping Screws

Wood and self-tapping screws are extensively used in Europe for the assembly of CLT panels (Figure 3). The ease of installation and the high lateral and withdrawal capacity of such screws make them quite popular among designers and builders as they can take combined axial and lateral loads. Wood screws and self-tapping screws come in a variety of sizes and specific features. Self-tapping screws are available in diameters up to 0.55 inch (14 mm) and lengths up to 59 inches (1500 mm), while common lengths are up to 39.4 inches (1000 mm). They do not require pre-drilling in most cases, unlike traditional wood or lag screws which require predrilled holes, the size of which depends on the density of the wood-based materials they are driven into and the diameter of the screws. The design capacity of screws in CLT must account for potential gaps in unglued cross plies and other artificially sawn grooves common in CLT fabrication.



Figure 3
Self-tapping screws used in CLT connections

3.2.2 Nails

Nails are not as commonly used in the assembly of CLT panels as wood screws. Nails with specific surface features such as grooves or helically threaded nails are mostly used with perforated metal plates and brackets and installed on the surface/plane of the panel (Figure 4). Most timber design standards do not allow the design of nailed connections in the end grain of wood-based products for withdrawal forces. Therefore, surface types of fasteners such as nails should not be driven in the edge of CLT panels (i.e., in end grain) to resist withdrawal forces. For lateral resistance, however, an end grain factor is usually applied to account for the reduction in the lateral resistance of nails driven in the end grain in most timber design standards, including NDS (AF&PA, 2005).



Figure 4

Pneumatically driven nails used in combination with perforated metal plates

3.2.3 Bolts and Dowels

Bolts and dowels are very common in heavy timber construction. They can also be used in the assembly of CLT panels, especially for lateral loading. If installed in the narrow face (on edge), care must be taken during the design, especially in CLT panels with unglued edges between the individual plank in a layer. This could eventually compromise the lateral resistance since there is a potential that such fasteners are driven in the gaps.

3.2.4 Bearing Types of Fasteners

While bearing-type fasteners such as split rings and shear plates are commonly used in connections of glulam, heavy sawn timber and structural composite lumber (SCL) such as parallel strand lumber (PSL), they are not widely used for the assembly of CLT panels. Bearing-type connections can be used in certain locations depending on the position of the fasteners with respect to the CLT layers and the type of service load.

3.2.5 Innovative Type of Fasteners

A new generation of fasteners, such as self-tapping screws and glued-in rods, are becoming increasingly popular in the assembly of mainstream heavy timber construction. This is driven by recent developments in CNC machining technology, wood materials and the desire for a high level of prefabrication to reduce assembly time and cost. With respect to CLT, glued-in rods in particular can be used for connections subjected to high longitudinal and transverse loads and to reduce the splitting potential (Augustin, 2008). More research work is needed in that area to evaluate the performance of such proprietary connection systems in CLT, especially for the American construction market.

4

CONNECTIONS IN CLT ASSEMBLIES - DETAILS

This section is focused on providing detailed information and schematics on traditional and innovative types of connection systems typically used in establishing connections between CLT panels, and those between walls and foundations and walls and floors. Figure 5 shows the various locations of such connections in a multi-story CLT building. While most of the commonly used types of fasteners and those with some potential for use in CLT assemblies are described hereafter, the list is not comprehensive. Other types of innovative proprietary fasteners, not mentioned under this section, could also be used, if found suitable.

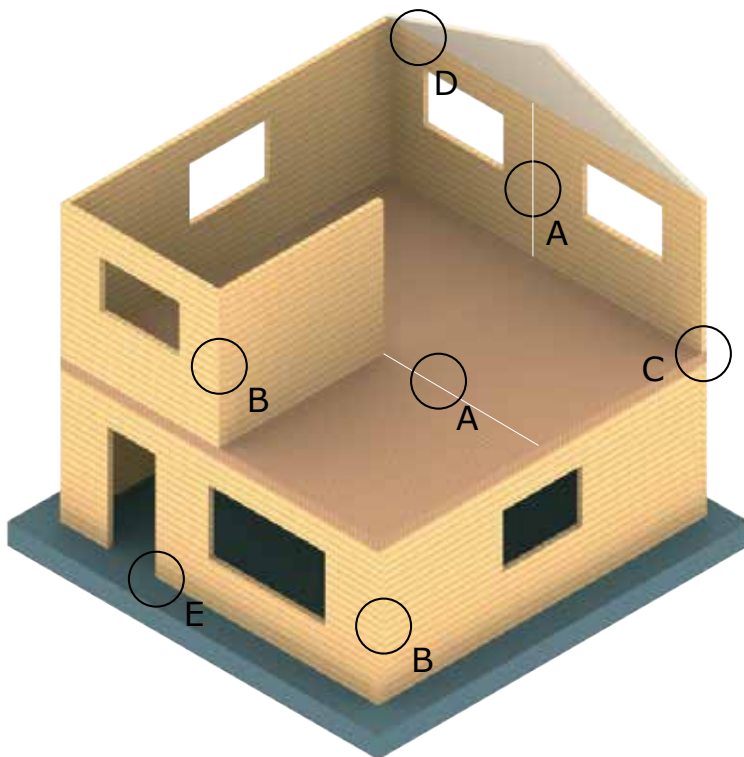

Figure 5
Typical two-story CLT building showing various connections between floor and wall panels

4.1 Panel-to-panel (Detail A)

This is the fundamental form of connection that is typically used to form wall and floor assemblies. It is used to connect panels along their longitudinal edges. Due to production and transport limitations related to the size of the panel that can be delivered to building sites, panel-to-panel connections are established mostly on site. Connection details must be easy to assemble and should facilitate quick fabrication. The panel-to-panel connection facilitates the transfer of in- and out-of-plane forces through the wall or floor assembly. For example, when panel-to-panel connections are used in wall assembly, the connection must be designed to resist in-plane shear and out-of-plane bending. When the connection is used in floor assemblies acting as diaphragms, however, the connection must be capable of transferring in-plane diaphragm forces in principle, and maintain the integrity of the diaphragms and the overall, lateral load resisting system. Several possible panel-to-panel connection details are described below.

4.1.1 Internal Splines

Single or double wooden splines/strips made of lumber, SCL such as laminated veneer lumber (LVL), thin CLT or plywood could be used to form this connection. Profiling of the panel at the plant is necessary prior to delivery on site. Connection between the spline(s) and the two panel edges could be established using self-tapping screws, wood screws or nails. One advantage of this detail is that it provides a double shear connection. However, it requires more accurate profiling and could be challenging in terms of fitting the different parts together on site. There are also other advantages regarding resistance to normal or out-of-plane loading. Structural adhesive could also be applied to the different parts in addition to the mechanical fasteners to provide more rigidity to the connection, if needed. Schematic of a single internal spline is shown in Figure 6 below. An example of a double internal splines commonly adopted by some CLT manufactures in Europe is shown in Figure 7.

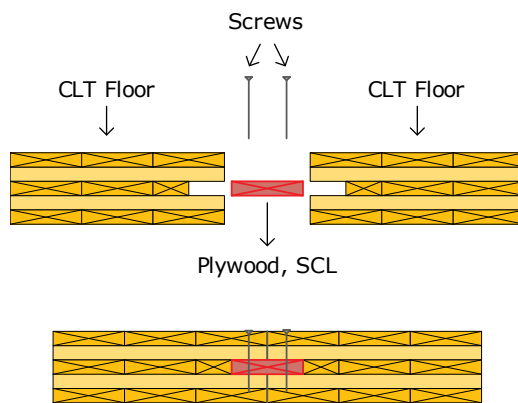

Figure 6
Single internal spline



Figure 7
Double internal splines (Courtesy of Kevin Meechan and U.S. WoodWorks)

4.1.2 Single Surface Spline

This is a rather simple connection detail that can be established quickly on site. Panel edges are profiled to take a strip/spline of lumber or SCL such as LVL, PSL or laminated strand lumber (LSL) (Figure 8). Traditional fasteners such as nails, wood screws and lag screws can be used for making the connection on site. Proprietary types of fasteners such as self-tapping screws are commonly used in Europe. Due to the single shear connection involved, this connection detail is typically inferior to the internal spline previously described. Structural adhesive could also be used in this type of connection detail.

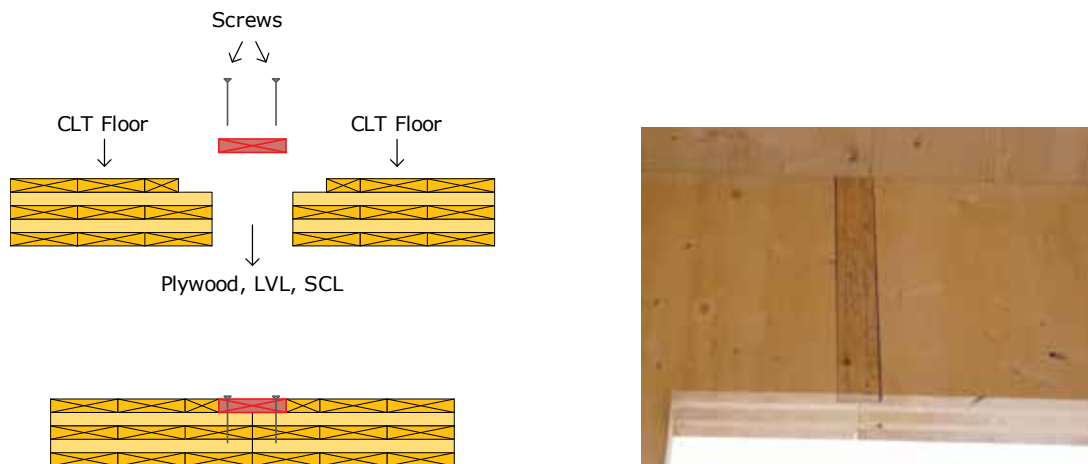

Figure 8
Single surface spline

4.1.3 Double Surface Splines

This connection detail is similar to that of the single surface spline previously described, except that a double spline is used here to increase the connection strength and stiffness (Figure 9). Since two sets of screws are used, which results in doubling the number of shear planes resisting the load, a better resistance can be achieved using this detail. However, this connection requires more machining and more time could be needed for erection since there is a need to attach the two splines from both sides of the panels during the insertion of fasteners, doubling the time needed for driving fasteners. According to Augustin (2008), if SCL is used as the splines, then the joint could be designed to resist moment for out-of-plane loading. Structural adhesives could be used to enhance the strength and stiffness.

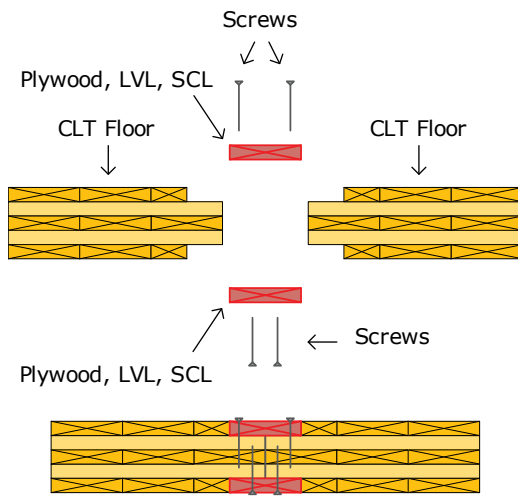

Figure 9
Double surface spline

4.1.4 Half-lapped Joint

This connection detail involves milling a half-lapped joint at the plant and is commonly used for panel-to-panel connections in wall and floor assemblies (Figure 10). Long self-tapping screws are usually used to connect the panel edges. The joint can carry normal and transverse loads but is not considered to be a moment resisting connection (Augustin, 2008). While this is a very simple connection detail that facilitates quick assembly of CLT elements, there is a risk of splitting of the cross section due to concentration of tension perpendicular to grain stresses in the notched area. This is particularly pronounced for cases where uneven loading on the floor elements occur (Augustin, 2008).

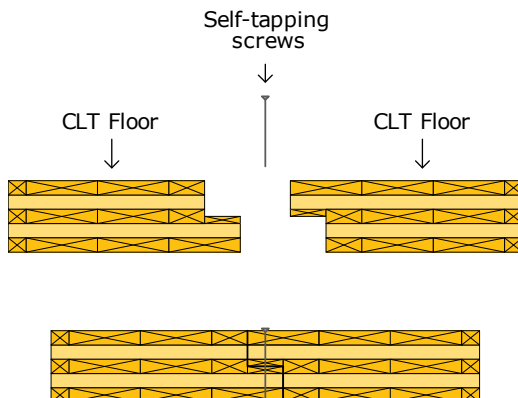

Figure 10
Details of half-lapped joints

4.1.5 Tube Connection System

This is an innovative type of connection system that has been developed and studied in Austria by G. Traetta (2007). This system incorporates a profiled steel tube with holes (Figure 11). Panel elements arrive on site with glued-in or screwed rods driven in the plane of the two panels to be connected and with holes machined in the panels at certain locations along the edges where the metal tubes could be placed. The tube connector is inserted at those locations along the panel elements and the system is tightened on site using metal nuts.

Tests were carried out at the Building Research Center in Graz, Austria to evaluate the capacity of this innovative system (Traetta, 2007). Usually no edge profiling along the panel is needed if this connection system is used as it relies principally on the pullout resistance of the screwed or glued-in rods.

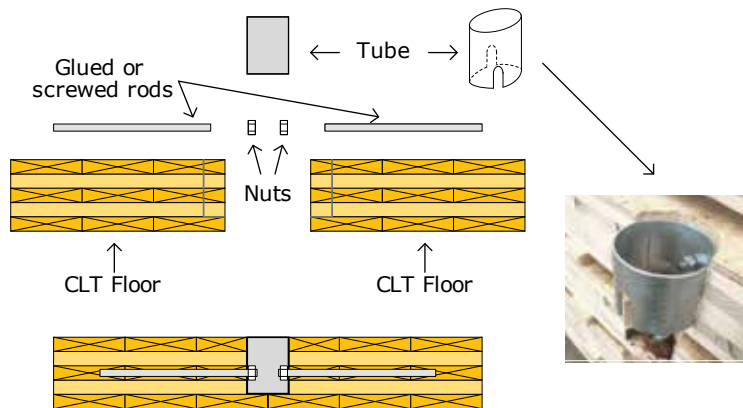

Figure 11
Details of the tube connection system

4.2 Wall to Wall (Detail B)

This section covers connection details for connecting walls to walls positioned at right angles (wall junction in the transverse direction). Such connection details include interior partitions to exterior walls or simple exterior corner walls. Walls connected in the same plane of the panels were covered previously under panel-to-panel connections (Detail A). Most of the connection details described hereafter are commonly used in the assembly of CLT walls. However, a few of these involve the use of innovative types of connection systems or details with some potential for use in such applications. The same connection systems adopted for connecting exterior walls in the transverse direction could be used for establishing connection between internal walls.

4.2.1 Self-tapping Screws

Several systems have been adopted to establish connection between walls at right angles (wall junction). The simplest form of connection relies mainly on self-tapping screws to connect the walls together (Figure 12). There are some concerns however related to this direct form of connection due to the fact that the screws are driven in the narrow side of panels, in particular if screws are installed in the end grain of the cross layers. While this may not be critical for small loads, it may not be suitable for walls subjected to high wind and seismic loads. Self-tapping screws could also be driven at an angle to avoid direct installation of screws in the narrow side of the panel (on edge) which would optimize the performance of the connection (i.e., toe screwing) (Figures 13 and 14).

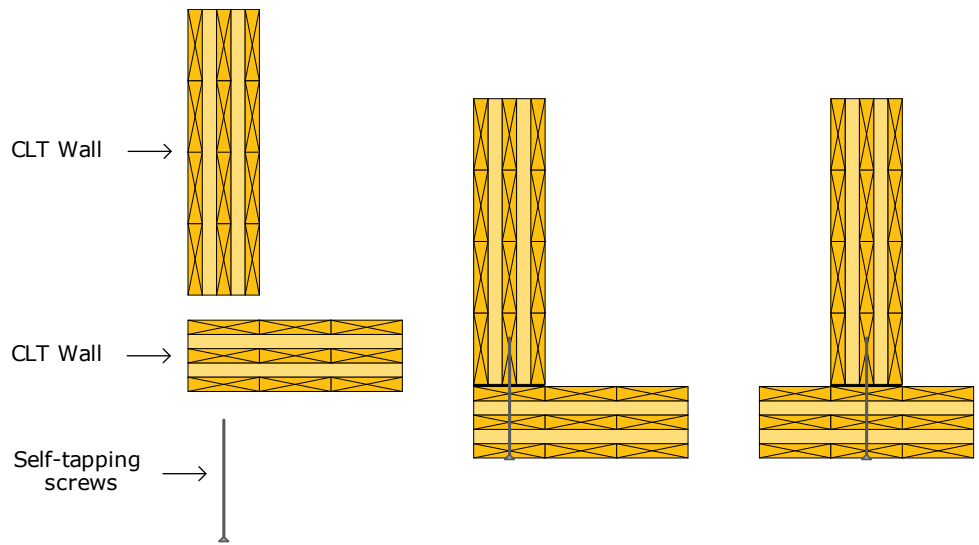

Figure 12
Self-tapping screws from the exterior



Figure 13
Installation of self-tapping screws from the exterior (courtesy of U.S. WoodWorks)

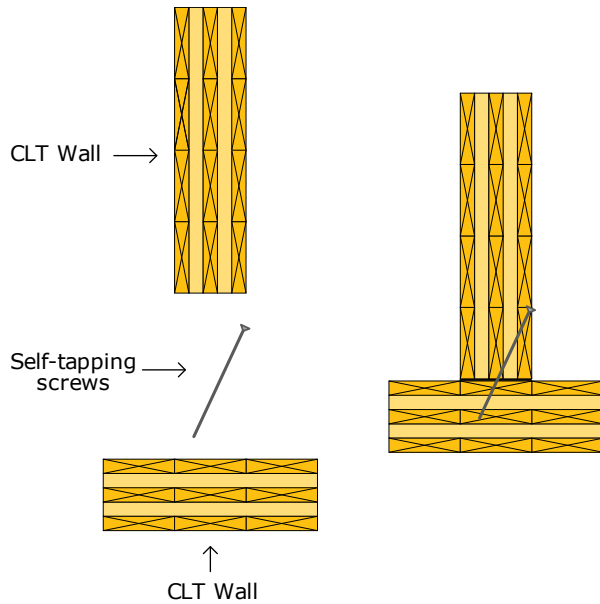

Figure 14
Self-tapping screws driven at an angle (toe-screwing)

4.2.2 Wooden Profiles

Concealed wooden profiles (keys) could also be used in a similar way, with self-tapping screws or traditional wood screws. The advantage of this system over the direct use of self-tapping screws is the possibility of enhancing the connection resistance by driving more wood screws to connect the profiled panel to the central wood profile/key which is in turn screwed to the transverse wall (Figure 15).

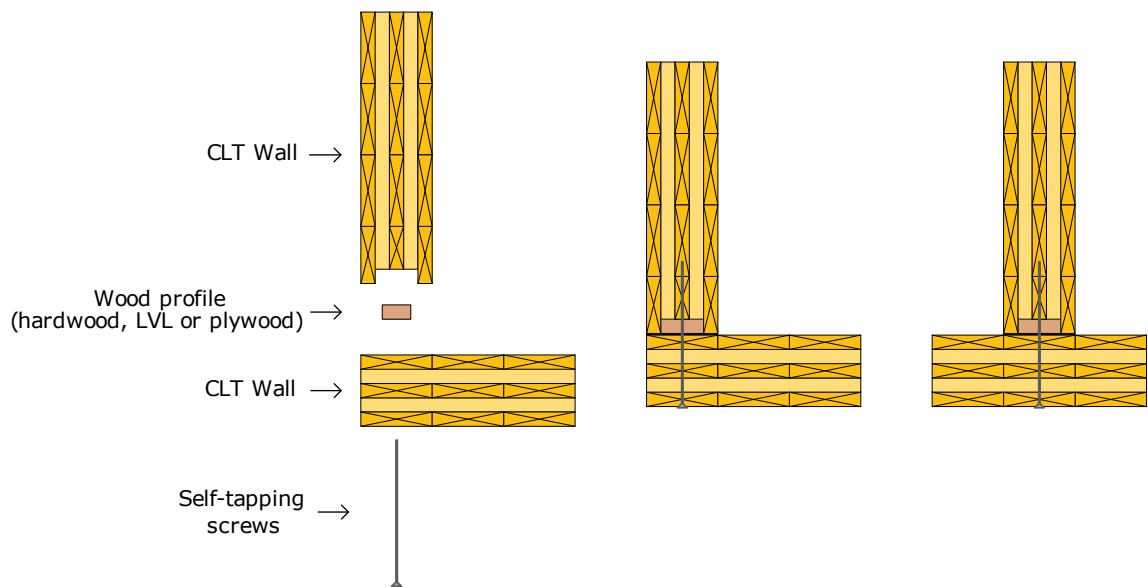

Figure 15
Concealed wooden profile

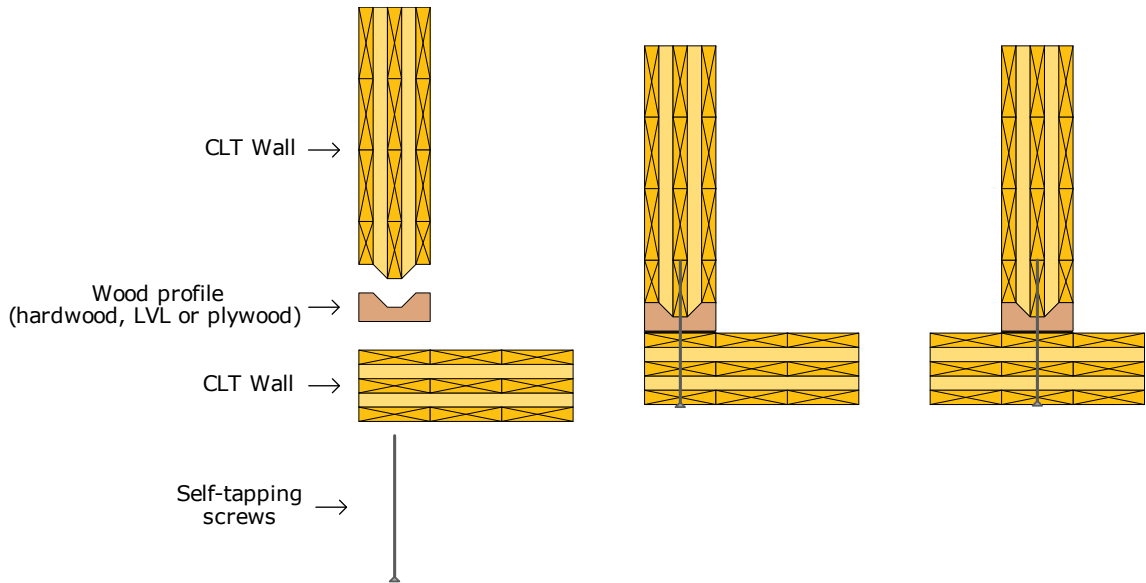

Figure 16
Edge protecting wooden profile

Other types of wooden profiles such as the one shown in Figure 16 could also be used to provide some form of reinforcement to the panel connected edges. Those are mainly made of high density hardwood or SCL. They are glued and screwed to the panel edge as mentioned earlier.

4.2.3 Metal Brackets

Another simple form of connecting walls in the transverse direction is the use of metal brackets with screws or nails (Figure 17). This connection system is one of the simplest and most efficient types of connection in terms of strength resulting from fastening in the direction perpendicular to the plane of the panels or recessed. Adding protective membrane (i.e., gypsum board) for improved fire resistance is required, however.

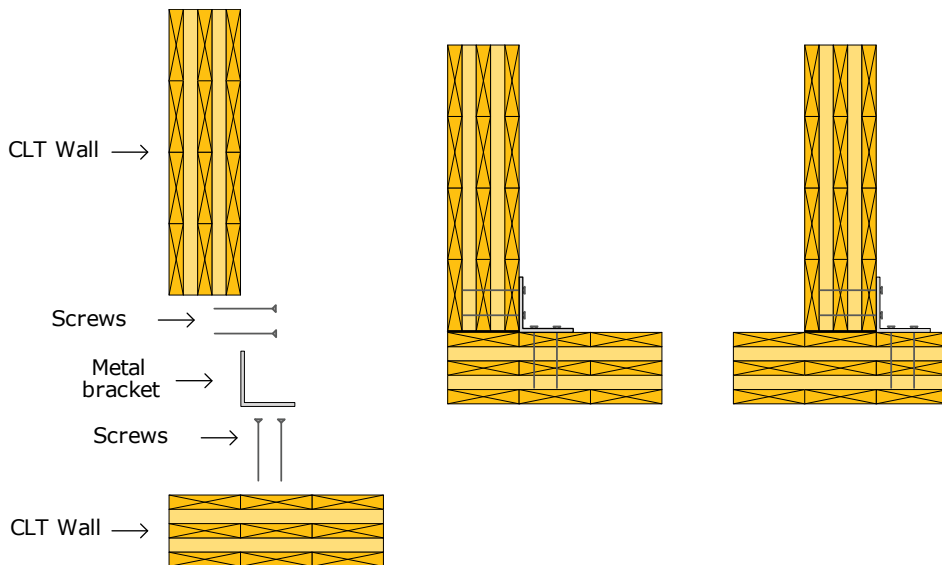

Figure 17
Interior metal bracket

4.2.4 **Concealed Metal Plates**

Concealed metal plates can also be used to establish wall-to-wall connection in the transverse direction. Metal plate thickness could range from 0.24 inch (6 mm) up to 0.47 inch (12 mm). As previously discussed, while this system has considerable advantages over exposed plates and brackets, especially when it comes to fire resistance, the system requires precise profiling at the plant using CNC machining technology (Figure 18). Proprietary self-drilling dowels that can penetrate through wood and steel (Figure 19) could also be used but design information on performance must be obtained from the manufacturer.

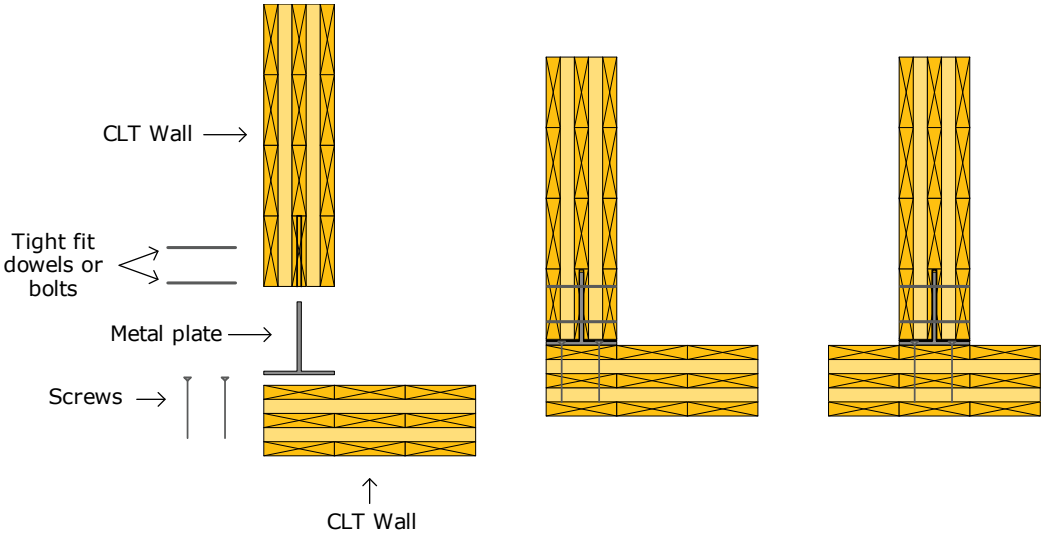

Figure 18
Concealed metal plate



Figure 19
Self-drilling dowel through steel and wood (Courtesy of SFS Intec)

4.3 Wall to Floor (Detail C)

Several possibilities exist when it comes to connecting walls to the floors above or connecting walls on the upper stories to floors, depending on the form of structural systems (i.e., platform vs. balloon), availability of fasteners and the degree of prefabrication. When platform construction is used, cumulative effects of bearing deformations should be addressed in the connection design.

4.3.1 Platform Construction

4.3.1.1 Self-tapping Screws

For connecting a floor or a roof to walls below, the simplest method is to use long self-tapping screws driven from the CLT floor directly into the narrow side of the wall edge, as shown in Figure 20. Self-tapping screws could also be driven at an angle to maximize the fastening capacity in the panel edge. The same principle could be applied for connecting walls above to floors below, where self-tapping screws are driven at an angle in the wall near the junction with the floor. Depending on the angle and the length of the screws, the self-tapping screws could reach the bottom walls, further reinforcing the connection between the upper and lower walls and the floor.

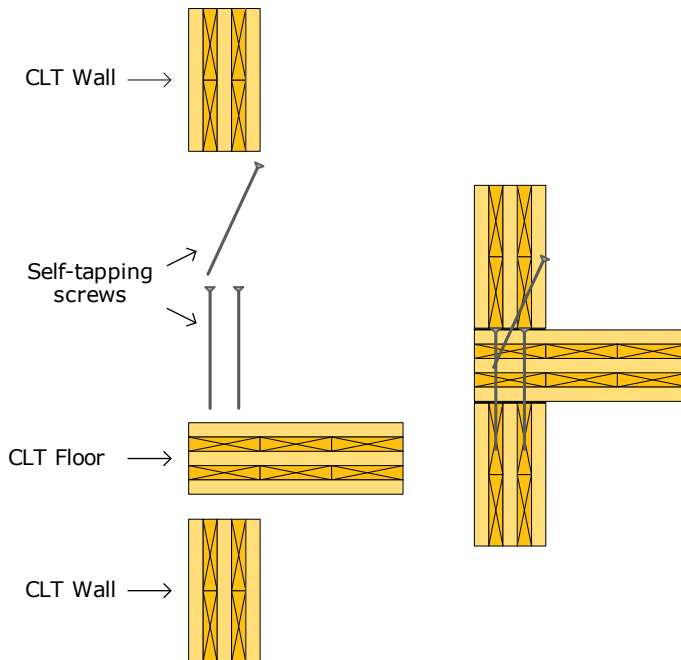

Figure 20
Self-tapping screws

4.3.1.2 Metal Brackets

Metal brackets are commonly used to connect floors to walls above and below to transfer, when required, lateral loads from one lateral load resisting system to another (e.g., from diaphragm to shear walls). They are also used for connecting roofs to walls. Nails or wood screws could be used to attach the metal brackets to the CLT panels (Figures 21 and 22).

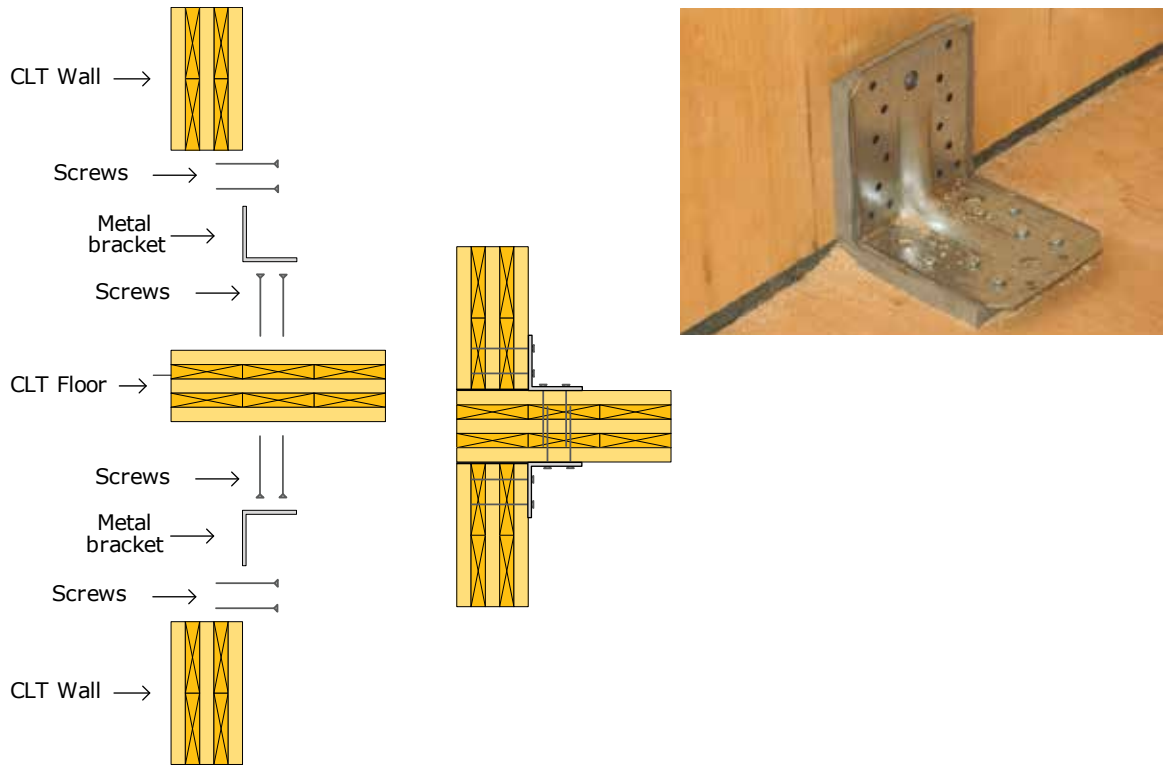

Figure 21
Metal brackets

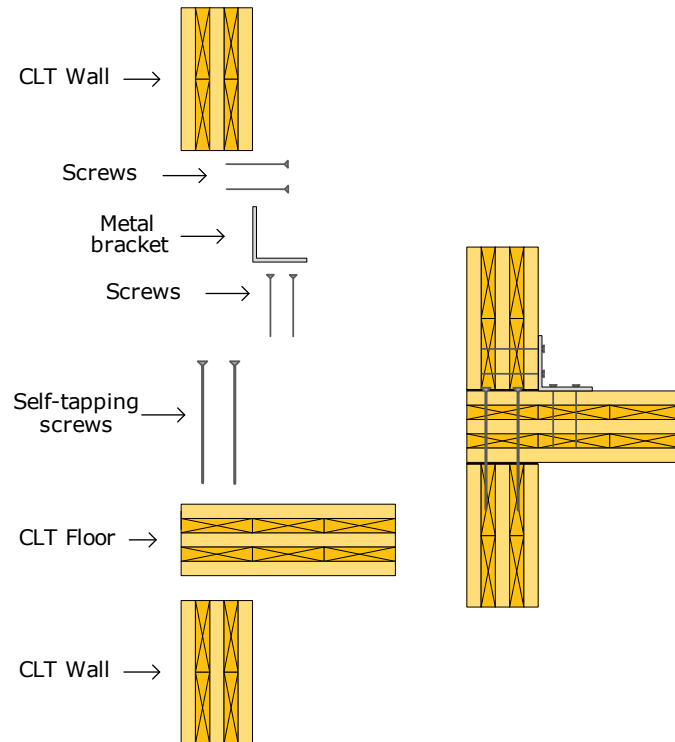

Figure 22
Metal bracket and self-tapping screws

4.3.1.3 Concealed Metal Plates

Concealed metal plates could also be used to establish wall-to-floor connections (Figure 23). As discussed above, while this system has considerable advantages over exposed plates and brackets, especially when it comes to fire resistance, the system requires precise profiling at the plant using CNC machining technology.

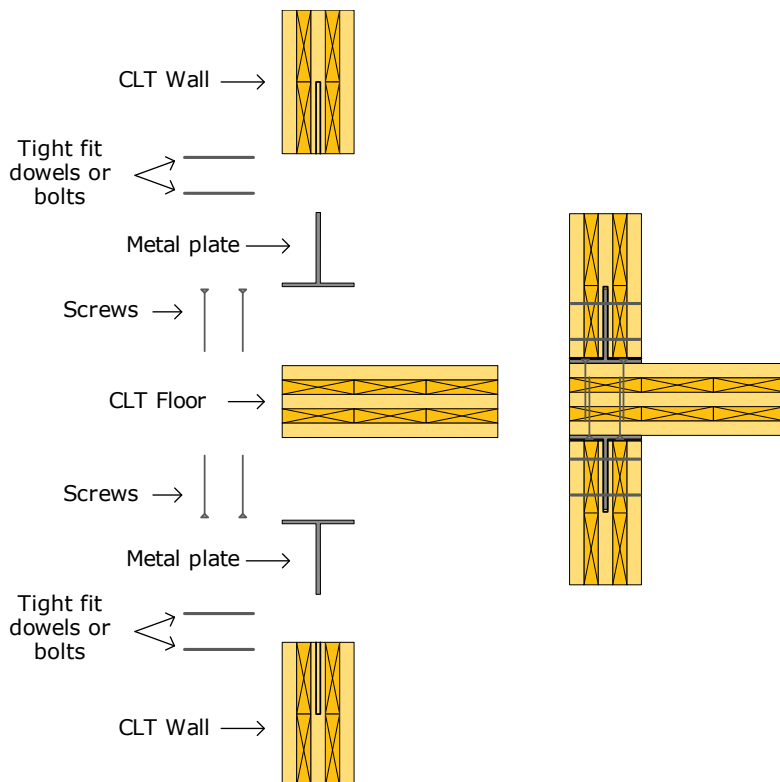

Figure 23
Concealed metal plates

4.3.2 Balloon Construction

The dominant type of structural form in CLT construction in Europe is the platform type of system due to its simplicity in design and erection. However, in non-residential construction, including farm and industrial buildings, it is common to use tall walls with a mezzanine which is an intermediate floor between the main floors of a building. A mezzanine floor is often located between the ground floor and the first floor; however, it is not unusual to have a mezzanine in the upper floors of a building.

To connect a typical CLT floor to a continuous CLT tall wall for such applications, several attachment options exist. The simplest attachment detail includes the use of a wooden ledger to provide a continuous bearing support to the CLT floor panels (Figure 24). The ledger is usually made of SCL such as LVL, LSL or PSL. CLT ledger could also be used. Another type of attachment is established with the use of metal brackets similar to the one shown in Figure 25 (a and b). Attachment of SCL ledger or metal brackets to the CLT wall and floor panels is established through the use of screws, lag screws or nails. However, out-of-plane bending due to wind suction could be an issue with this type of detail and designers need to take that into account.

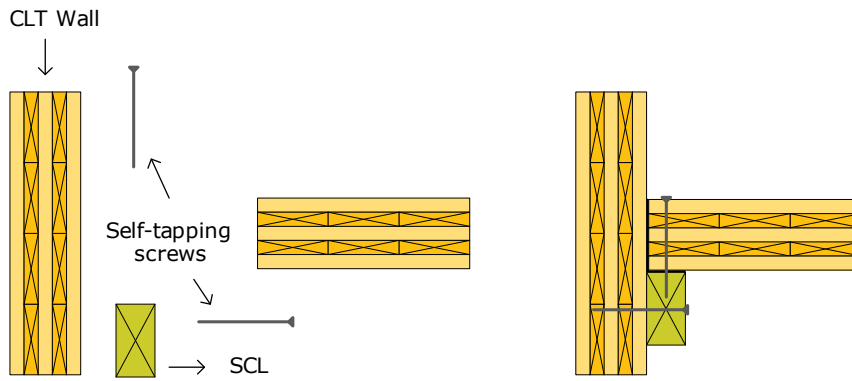
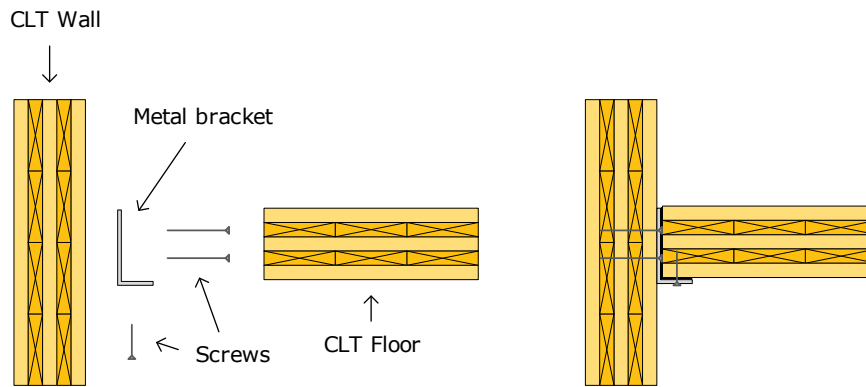
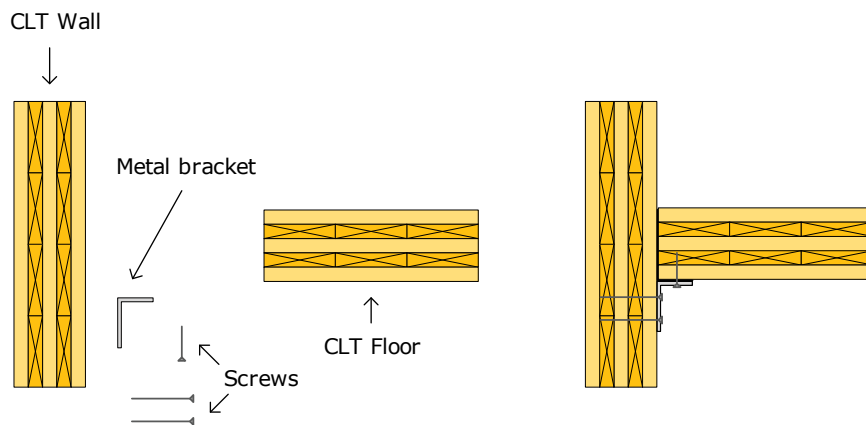

Figure 24
SCL components for bearing support (adapted from TRADA 2009)



(a)



(b)

Figure 25
Metal bracket used to provide bearing support (adapted from TRADA, 2009)

4.4 Roof to Wall (Detail D)

For sloping or flat roof to wall connections, a connection similar to those used for attaching floors to walls is used (Figure 26). Screws and metal brackets are the most commonly used fastening systems in this application (Figures 27 and 28).

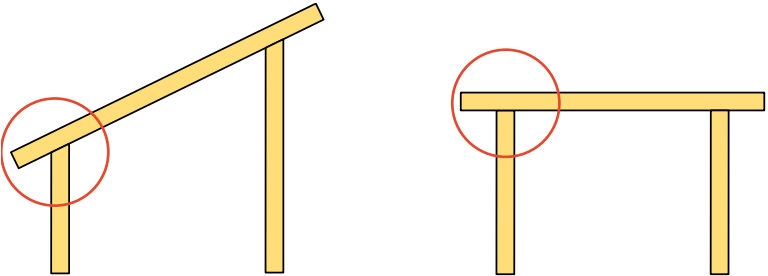
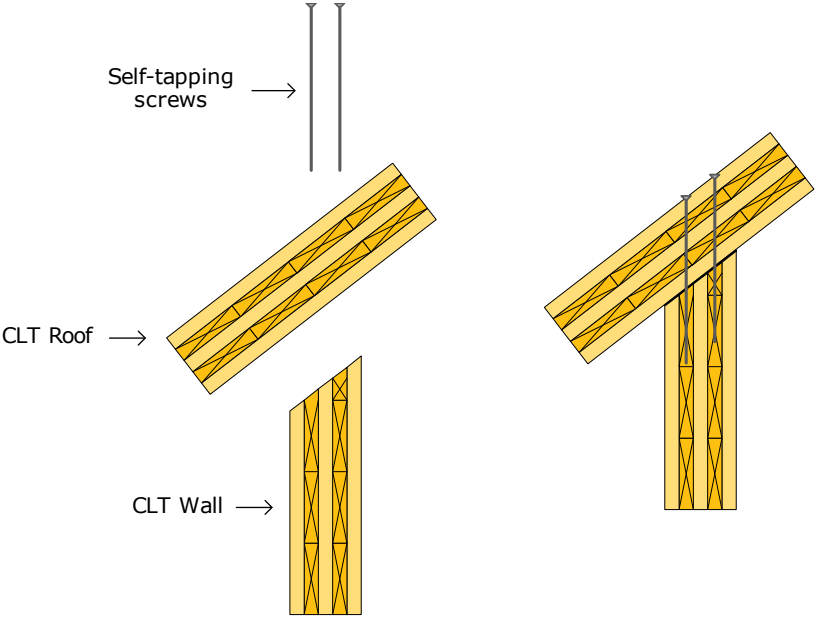
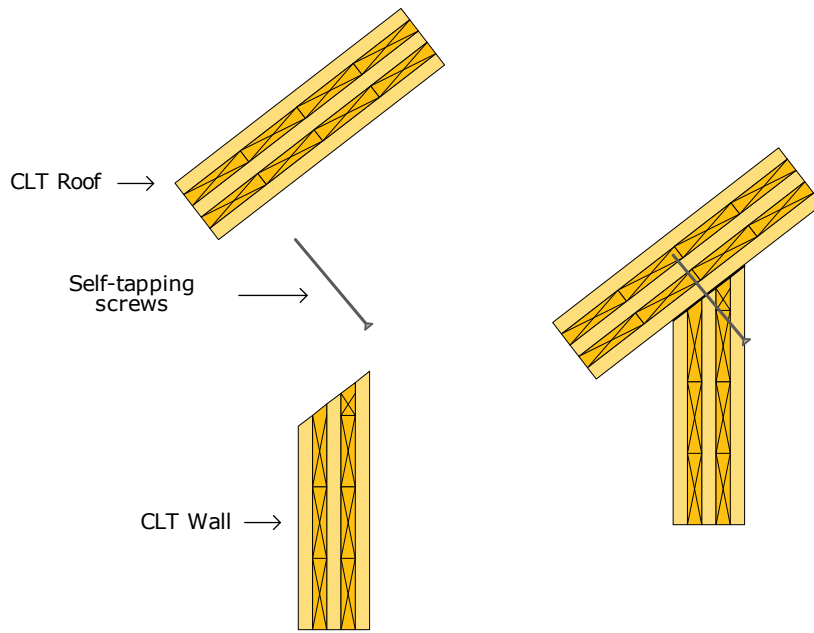

Figure 26
Possible roof-to-wall joints configurations



(a)



(b)

Figure 27
Self-tapping screws

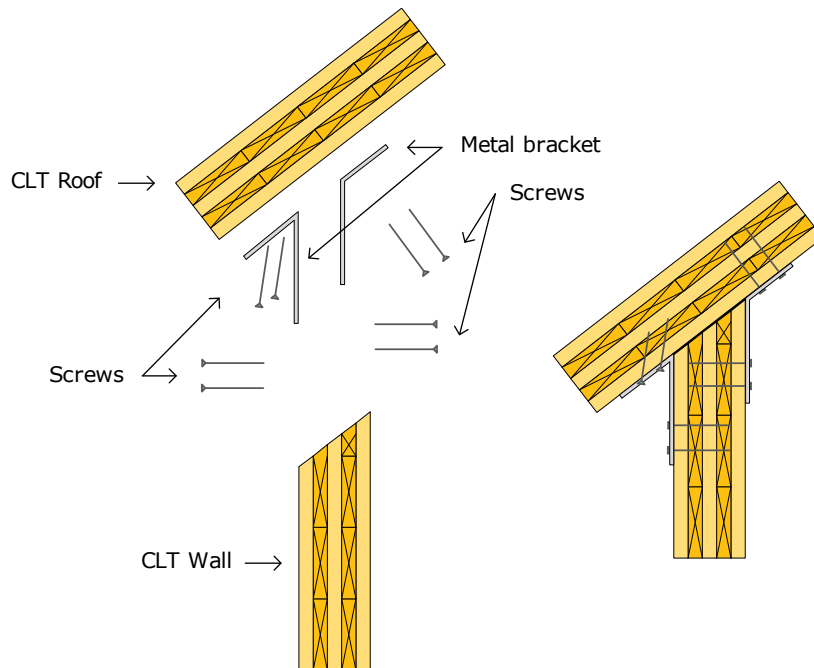

Figure 28
Metal brackets

4.5 Wall to Foundations (Detail E)

4.5.1 Visible/Exposed Plates

In connecting CLT wall panels to concrete foundations (common for the first story in a CLT building with concrete footing or with a multi-story CLT building with the first story made of concrete) or to steel beams, several fastening systems are available to establish such a connection. Exterior metal plates and brackets are commonly used in such applications as there is a variety of such metal hardware readily available on the market. Exposed steel plates similar to those shown in Figure 29 are probably the most commonly used in Europe due to their simplicity in terms of installation. When connections are established from outside, a typical metal plate is used (Figures 29 and 30). However, when access is provided from inside the building and where a concrete slab exists, metal brackets such as those shown in Figures 31 and 32 should be used. Lag screws or powder-actuated fasteners can be used to connect the metal plate to the concrete footing/slab, while lag screws or self-tapping screws are used to connect the plate to the CLT panel. It should be noted, however, that exposed metal plates and fasteners need to be protected against corrosive exterior environments. Galvanized or stainless steel should be used in such cases.

Direct contact between the concrete foundation and CLT panel should be avoided in all cases. To protect wood and improve the durability of CLT panels, a preservative-treated wood or SCL sill plate (or bottom plate) such as that shown in Figure 29 is installed between the concrete foundation and the CLT panels. This also simplifies the assembly. Contact can also be established through the use of special profiled steel brackets installed at the interface between the CLT panel and the concrete (Figure 30). Moreover, connection details should be designed to prevent potential moisture penetration between the metal plates and the CLT wall as water may get trapped and cause potential decay of the wood.

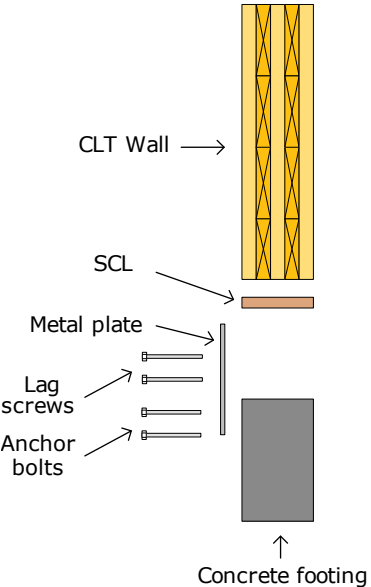

Figure 29
Exterior metal plate



Figure 30
 Example of a connection detail with a gap between CLT wall and concrete foundation

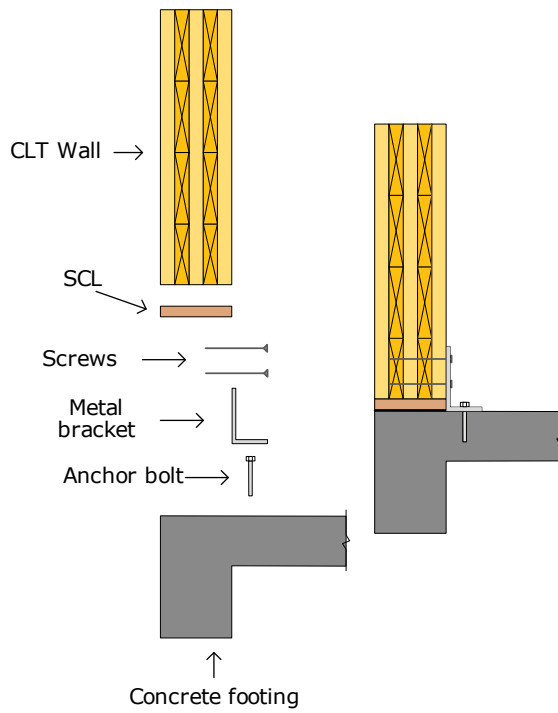

Figure 31
 Metal brackets



Figure 32
Metal brackets installed on site

4.5.2 Concealed Hardware

To achieve better fire resistance and improve aesthetics, designers sometimes prefer concealed connection systems. Hidden metal plates similar to those shown in Figure 33 below can be used. However, some machining (sometimes precise CNC machining) is required to produce the grooves in the CLT panel to conceal the metal plates. Tight dowels or bolts could be used to attach the plates to the CLT panel. Some innovative types of fasteners that can be drilled through metal and wood or other types of screws that can penetrate through both materials can also be used for this purpose.

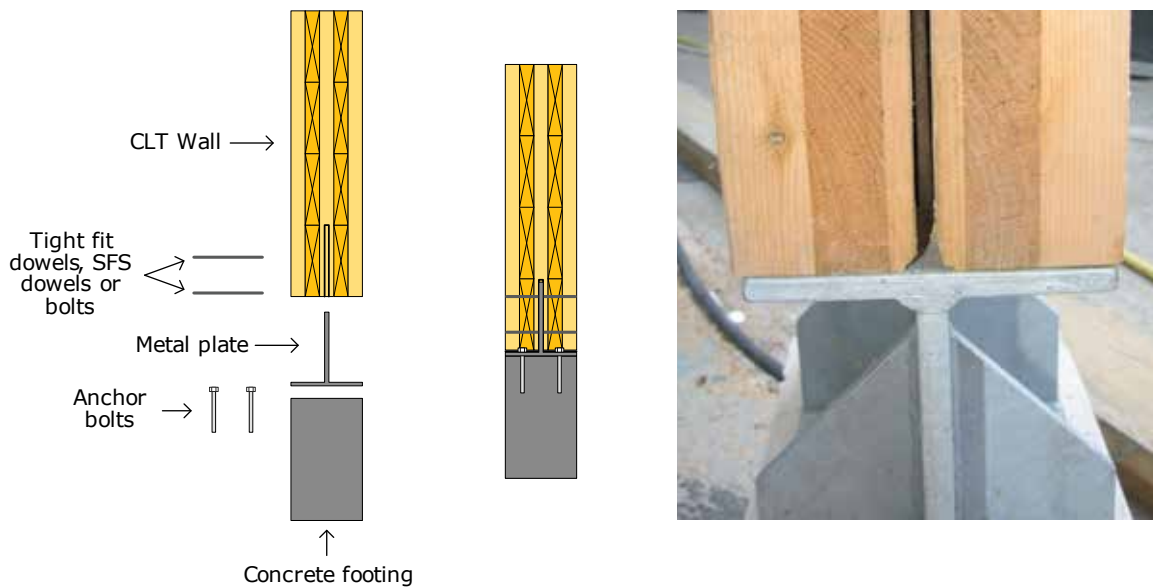

Figure 33
Concealed metal plates

4.5.3 Wooden Profiles

Wooden profiles are commonly used in connecting structural insulated panels (SIP) and other types of prefabricated wood-framed walls. It is important that such wooden profiles are fabricated from high density and stable materials. Engineered wood products or high density hardwood can generally be used for this purpose. The major advantage of this system is the ease of assembly. The wooden profiles are typically attached to CLT panels with wood screws or self-tapping screws. Structural adhesives are also used, sometimes in combination with mechanical fasteners since the wooden profile is installed in the plant. They are often used in combination with metal plates or brackets to improve the lateral load resistance as can be seen in Figure 34 below. CNC machining is needed at the CLT plant to produce the profiles in the panels. The use of wooden profiles is not limited only to wall-to-foundation applications. They can also be used for wall-to-wall or floor-to-wall connections. The wooden profiles could take several forms as can be seen in Figure 34, to provide additional protection and reinforcement to the bottom edge of the panel.

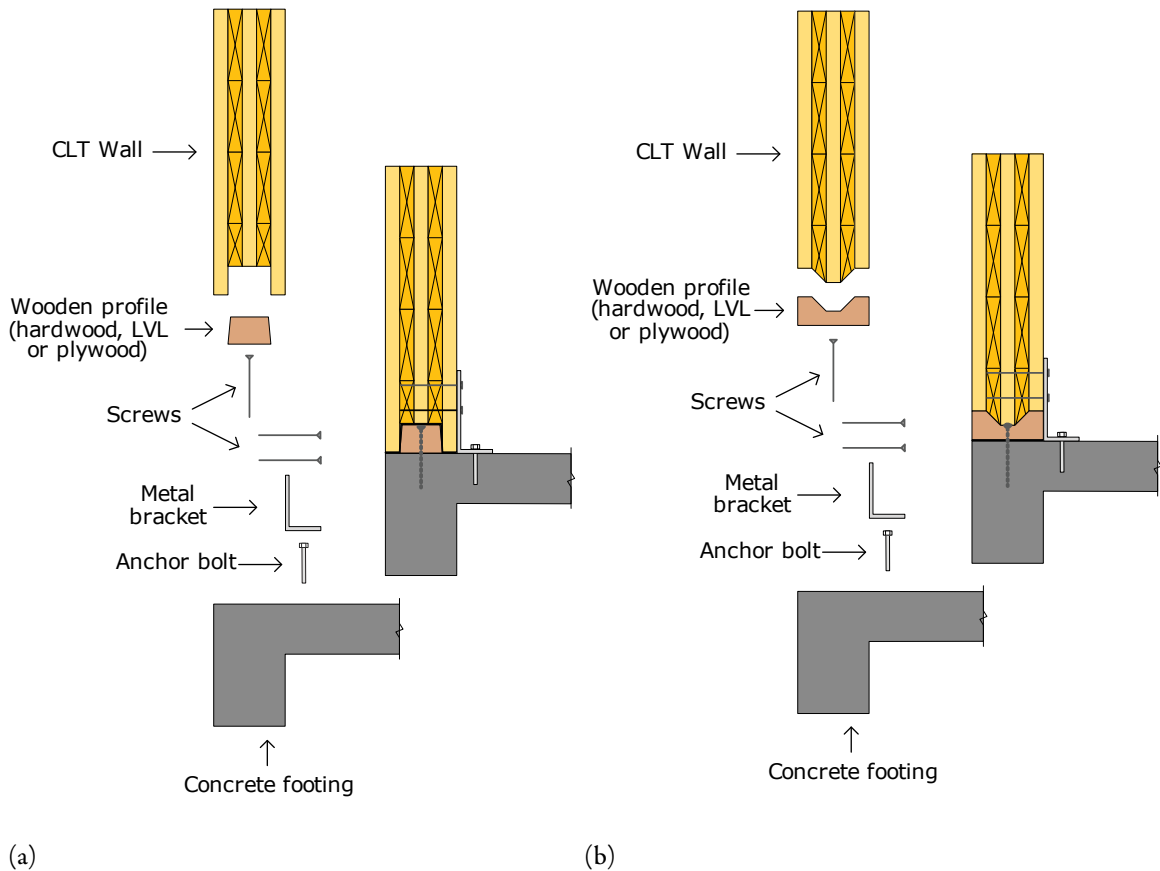

Figure 34
Concealed (a) and exposed (b) wooden profiles

5

CONNECTIONS IN MIXED HYBRID CLT CONSTRUCTION – DETAILS

Mixed systems using CLT with other types of wood-based materials such as glued-laminated timber (glulam) are common. Mixed systems are becoming increasingly popular in Europe as a way to optimize the overall design by capitalizing on the positive attributes of the various products. Mixing CLT with other types of construction materials such as concrete and masonry or mixing different types of structural forms is also common.

5.1 Mixed CLT with Other Wood-based Materials and Systems

In CLT assemblies, mixing different wood-based materials and different structural systems is done in such a way to optimize the design and to meet certain performance requirements. Therefore, it is not unusual to combine CLT wall assemblies with floor joist systems using glulam, wood I-joists, metal plated wood trusses or other types of engineered wood elements as the main floor support system, with either wood-based decking such as wood boards or wood structural panels. The following provides a brief summary of potential structural forms where CLT and other types of wood-based materials could be combined. Connection systems between those different materials are described.

5.1.1 Platform Construction

For platform-type construction, the main structural supporting elements of the floor system rest on top of the walls below. In mixed construction where walls are made of CLT panels, typical joisted floor system is placed on top of those walls as can be seen in Figures 35 and 36.

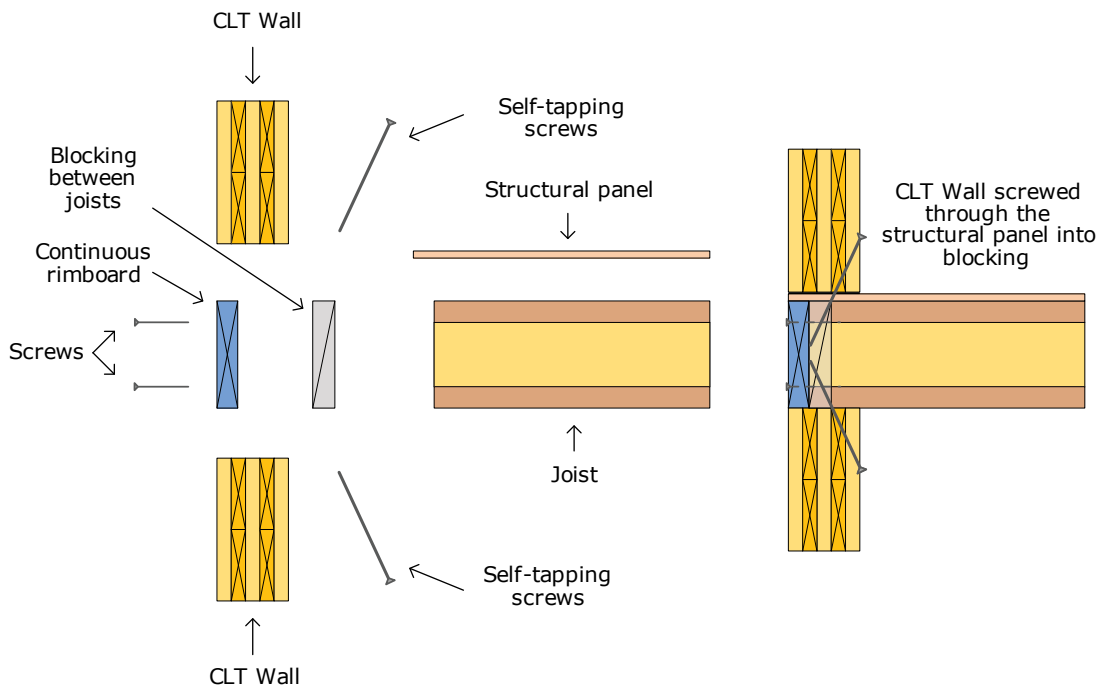

Figure 35
CLT wall – I-joist (adapted from TRADA, 2009)

A combination of rimboard and blocking elements made of SCL such as PSL, LVL or LSL between joists is generally used to ensure transfer of vertical and lateral loads from stories above to the CLT wall below. Differential shrinkage is not an issue here as the next story CLT walls are resting completely on the rimboard and blocking elements. In the case of a top chord bearing of wood floor trusses, it is necessary to provide wood-based blocking to prevent localized crushing of truss top chords and to have a uniform stress distribution along the wall perimeter (Figure 36). The wood blocking should be made with the same material as the truss top chord for dimensional stability.

Connection between walls above and below can be established using self-tapping screws driven at an angle or through one of the alternative methods of fastening previously described.

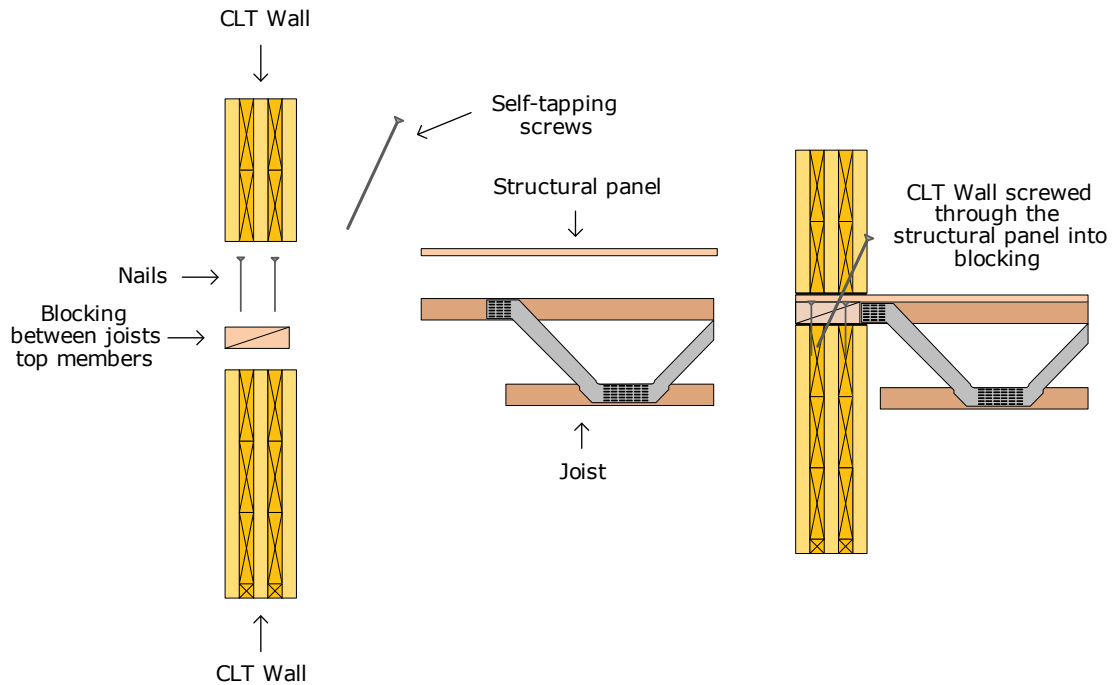

Figure 36
CLT wall – Engineered floor (adapted from TRADA, 2009)

5.1.2 Balloon Construction

Mixed CLT construction could also be used in buildings with a balloon structural form. In this type of construction, the joisted floor system which incorporates a variety of joist products such as sawn lumber, wood I-joists, and SCL can be attached to the CLT walls using traditional metal face mount hangers commonly used in light frame and heavy timber construction (Figures 37). The wall panels are continuous at the connection between the floor system and the wall and it provides support to the floor system.

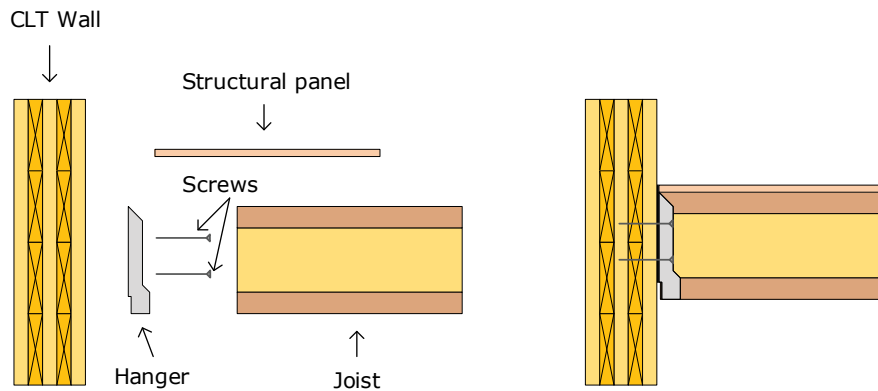

Figure 37
CLT wall – I-joist (adapted from TRADA, 2009)

6

DESIGNING CONNECTIONS IN CROSS-LAMINATED TIMBER

6.1 Why Connections in CLT are Different than those in Solid Timber or Glulam

CLT consists of layers of solid-sawn lumber or SCL where adjacent layers are cross-oriented and bonded with structural adhesive to form a solid wood element. The cross lamination and the built-up nature of the panel, in addition to certain unique panel features such as edge gluing (if any) and the potential presence of grooves sawn into the boards to relieve drying stresses, complicate the determination of the fastening capacity in CLT compared to traditional sawn solid lumber or SCL (Figure 38). Gaps between the longitudinal board as big as $\frac{1}{4}$ in. (6 mm) are not uncommon in some CLT products (Uibel and Blass, 2006). As a result, the remainder of this section will only be referring to CLT's manufacture without stress-relieving grooves and joints will be assumed to be tight-fitting.



Figure 38

CLT panel section with gaps and grooves sawn in the timber to relieve shrinkage stresses

It is well established that the loading direction relative to the grain direction of wood affects the connection capacity when relatively large diameter fasteners (with diameters equal to or greater than $\frac{1}{4}$ inch or 6 mm) such as bolts, lag screws and large diameter screws are used. However, connection capacities are relatively insensitive to grain direction when small diameter fasteners of less than $\frac{1}{4}$ inch (6 mm) are used. To account for the effects of load direction to grain orientation, timber design standards such as NDS specify different dowel-bearing equations for connections in timber loaded either in the direction parallel or perpendicular to grain for dowel-type fasteners with diameters of $\frac{1}{4}$ inch (6 mm) or more.

While yielding modes calculated using yield limit equations based on the European Yield Model (EYM) are the dominant limit for slender fasteners in CLT (Figure 39), there is a potential for developing wood strength limit states in CLT such as row shear, group tear-out, tension or splitting. According to tests conducted by Uibel and Blass (2006) in Europe with dowels and screws loaded perpendicular to the plane of the panel, the connections exhibited considerable ductility. Even when plug shear or splitting occurred in the outer layers, the load remained at the same level or showed a localized marginal drop. This could be attributed to the reinforcement effect provided by cross lamination in CLT; however, this finding is limited to the tested configurations. Fasteners loaded parallel to grain are more susceptible to these wood strength failure modes. Fasteners driven in end grain are very susceptible to splitting due to tension stresses perpendicular to the grain in small thickness panels when fasteners are loaded in shear. Therefore, there is a need to establish the conditions where wood strength failure modes may occur with large diameter fasteners and groups of fasteners used with CLT. General provisions are contained in NDS, Section 10.1.3 and Appendix E, to limit these types of wood strength failures.

Proprietary fasteners are often used based on information from the NDS in combination with connection testing and engineering analysis to establish prescriptive requirements and connection design values. When using proprietary fasteners, the user should contact the manufacturer for specific recommendations.

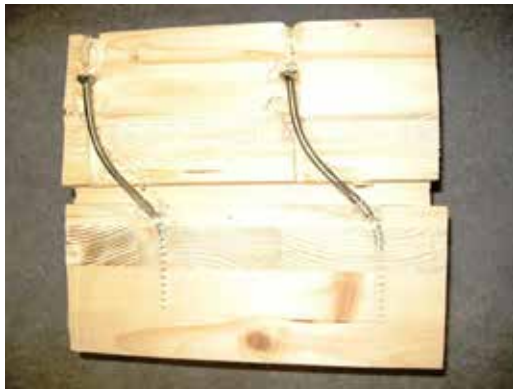

Figure 39

Ductile failure modes typically experienced during testing of self-tapping screws in CLT half-lapped connections

6.2 Design Approach for Lateral Connections in CLT

Extensive research has been conducted in Europe to evaluate the fastening capacity of different types of fasteners in CLT. Comprehensive research on the fastening capacity of CLT connections was conducted by Uibel and Blass (2006, 2007). The shear capacity of traditional fasteners in CLT was studied with the intent of developing a calculation methodology to establish the load carrying capacity of connections with dowel-type fasteners in the direction perpendicular to the CLT panel and on their narrow side (i.e., edge joints). Dowel-bearing tests were conducted using different types of CLT products and dowel-type fasteners. Empirical models expressed as a function of the fastener diameter, wood density and loading angle relative to the grain direction of the surface lamina were developed based on test results to establish the dowel-bearing strength under lateral loading. The results of these tests suggest that the dowel-bearing equations used in the NDS for dowel-type equations are applicable with minor adjustments.

6.2.1 Fasteners Driven Perpendicular to the Plane of the Panel

For dowel-type fasteners where the dowel diameter is equal to or larger than ¼ inch (6 mm), the dowel-bearing strengths, F_e , to use with the provisions of NDS 11.3 to calculate reference lateral design values for the two primary loading directions are:

Parallel to grain for the CLT ply at the shear plane:

$$F_{e\parallel} = 11200 G \quad [1]$$

Perpendicular to grain for the CLT ply at the shear plane:

$$F_{e\perp} = 6100 G^{1.45} D^{-0.5} \quad [2]$$

Where:

$F_{e\parallel}$ = dowel-bearing strength parallel to grain (psi) for fastener where $D \geq \frac{1}{4}$ inch

$F_{e\perp}$ = dowel-bearing strength perpendicular to grain (psi) for fastener where $D \geq \frac{1}{4}$ inch

G = minimum specific gravity of species used in CLT lay-ups

D = diameter (inches) of fastener penetration

Crossing layers will have different dowel-bearing strengths than the CLT ply at the shear plane. In most connections, the impact of this difference will be minimal; however, for connections using larger diameter fasteners or shorter dowel-bearing lengths, l_s or l_m , that is the “effective” length of the bearing length due to these layers should be reduced. For connections where the primary loading direction is parallel to grain for the CLT ply at the shear plane, the dowel bearing length should be reduced by multiplying the bearing length in the crossing plies (perpendicular to grain) by the ratio of $F_{e\perp} / F_{e\parallel}$. For connections where the primary loading direction is perpendicular to grain for the CLT ply at the shear plane, the dowel-bearing length can conservatively remain unadjusted or be adjusted by increasing the bearing length in the crossing plies (parallel to grain) by the ratio of $F_{e\parallel} / F_{e\perp}$. For connections loaded at an angle to grain, the procedures in NDS, Appendix J, for developing design values based on parallel and perpendicular to grain design values should be used with these adjusted “effective” lengths.

For dowel-type fasteners where the dowel diameter is less than ¼ inch (6 mm), the dowel-bearing strength, F_e , to use with the provisions of NDS 11.3 to calculate reference lateral design values loading at any angle to the grain is:

$$F_e = 16600 G^{1.84} \quad [3]$$

Where:

F_e = dowel-bearing strength (psi) for fastener where $D < \frac{1}{4}$ inch.

6.2.2 Dowel-type Fasteners Driven in the Narrow Side of the CLT Panel

For dowel-type fasteners installed in the narrow edge of CLT panels, the effects of inter-ply edge distance and end grain effects can be dramatic. For the purpose of developing design values for fasteners installed in this orientation, the dowel-bearing strength for fasteners with dowel diameters equal to or larger than ¼ inch (6 mm) should be limited to 0.55 times $F_{e\perp}$ from Equation (2), regardless of the actual grain orientation of the penetrated member. For fasteners with dowel diameters of less than ¼ inch (6 mm), the use of 0.67 times F_e from Equation (3) is adequate.

CLT connections using split rings and shear plates should be designed using principles and limitations of NDS Chapter 12. However, end distance, edge distance, and spacing limits are based on the use of split rings and shear plates installed in solid-sawn or glued-laminated lumber. For CLT, additional wood strength requirements should be checked to prevent unanticipated wood failures such as net section area tension, row tear-out and group tear-out addressed in NDS Appendix E.

CLT connections using timber rivets are beyond the application limits in the NDS and are not recommended at this time. Specific wood strength provisions must be developed for this application.

When using proprietary fasteners, the designer should contact the manufacturer for specific recommendations.

6.3 Design Approach for Withdrawal Connections in CLT

Withdrawal strength of large diameter self-tapping screws installed perpendicular to the plane of CLT panels or in CLT panel edges was also investigated by Uibel and Blass (2007). The withdrawal resistance was derived from tests using self-tapping screws with diameters ranging from ¼ inch (6 mm) to ½ inch (12 mm). The location of the screws was selected in such a way to have them installed at the joint between two boards within a lamina, or between one lamina and another (in the glue line). Comparative analysis studies using those proposed equations versus those given in the NDS suggest that the withdrawal equations provided in the NDS 11.2 for lag screws, wood screws, nails and spikes are also applicable to CLT installed perpendicular to the plane of the CLT and are as follows:

Lag screws:

$$W = 1800 G^{3/2} D^{3/4} \quad [4]$$

Wood screws:

$$W = 2850 G^2 D \quad [5]$$

Smooth-shank nails and spikes:

$$W = 1380 G^{5/2} D \quad [6]$$

Post-frame ring shank nails:

$$W = 1800 G^2 D \quad [7]$$

Where:

W = reference withdrawal design value (lb.) per inch of thread penetration as permitted in NDS

G = minimum specific gravity of species used in CLT lay-ups

D = diameter (inches) of fastener penetration

For the purpose of developing design values for fasteners installed in the narrow edge of CLT panels, the withdrawal equations and provisions in the NDS for fasteners installed in end grain should be followed. As a result, lag screw withdrawal values should be multiplied by the end grain factor (C_{eg}) of 0.75, as per NDS 11.5.2.1. Wood screws, nails, and spikes should not be loaded in withdrawal from end grain. When using proprietary fasteners, the designer should contact the manufacturer for specific recommendations.

6.4 Placement of Fasteners in Joints

Minimum requirements are given in the NDS for loaded end and edge distances, fastener spacing in a row and spacing between rows of fasteners for a variety of traditional fasteners with diameters equal to or greater than $\frac{1}{4}$ inch (6 mm) such as bolts, lag screws, and dowels. Recommendations for smaller fasteners such as nails, spikes, and wood screws are not explicitly provided in the NDS, which only details a requirement to avoid splitting. However, some guidance is provided in the NDS Commentary for these types of fasteners. These requirements can be applied conservatively to fasteners driven or placed in the direction perpendicular to the plane of the CLT panel since the cross laminations tend to reinforce the section. Fasteners placed in the narrow side (on edge) of the panel need special detailing requirements.

Realizing the importance of investigating the required end distances and spacing for fasteners driven or placed on edge, European researchers have developed minimum requirements for placement of self-tapping screws and dowels in CLT panels. This was done to avoid premature splitting and ensure the full bearing capacity of the dowels in the CLT is achieved. This is critical for CLT panels when they are connected at right angles (e.g., floor-to-wall or wall-to-wall corner connections) and where fasteners are driven in the narrow side (on edge) of a panel. In such situations, the fastener may tend to force plies apart across the panel thickness due to excessive tension perpendicular to grain stresses. This could initiate premature splitting in the vicinity of the fastener, thereby weakening the connection.

Recommendations on the end and edge distances and spacing for dowel-type fasteners driven on edge (adapted from Draft CEN CLT standard, 2010) are given in Table 1. Definition of end and edge distances and spacing are shown in Figure 40.

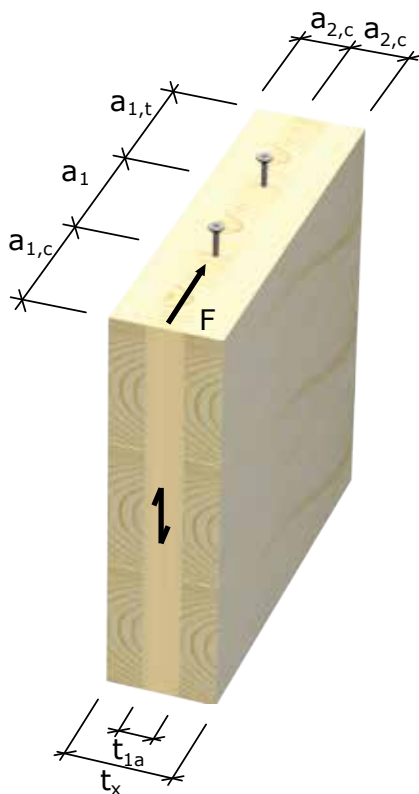

Figure 40

End and edge distances and spacing for dowel-type fasteners driven on edge (adapted from Draft CEN CLT standard, 2010)

Table 1

Minimum fastener spacing and distances in the narrow side of cross-laminated timber
(adapted from Draft CEN CLT standard, 2010)

Fastener	$a_{1,t}$	$a_{1,c}$	a_1 (in plane)	$a_{2,c}$	a_2 (perpendicular to the plane)
Dowels	5 d	3 d	4 d	3 d	3 d
Bolts	5 d	4 d	4 d	3 d	4 d

6.5 Detailing of Connections in CLT

In detailing and optimizing connections in CLT, it is important to consider not only the strength and stiffness performance of the connection system, but other performance attributes such as fire, sound insulation, air tightness, durability and vibration. Typically, sealant and other types of membranes are used to provide air tightness and improve sound insulation at the interfaces between the floor and wall plates (Figure 41).



Figure 41

Acoustic membrane inserted between walls and floors and underneath the metal bracket connector to provide air tightness (in exterior walls) and improve sound insulation

It is also critical to ensure tight fit between individual panels at the construction site. Special devices similar to what is shown in Figure 42 (i.e., beam grip with ratchet and hooks) have been developed by the various CLT manufacturers to facilitate the on-site assembly of floor and wall panels – see Sections 4.3 to 4.5 of Chapter 12, *Lifting and handling of cross-laminated elements*, for more details. This is a key component for providing:

- Structural integrity (adequate connections between panels for sharing loads);
- Improved fire resistance (tightness between panels to provide passage of flames);
- Sound insulation (for reducing flanking) and,
- Air tightness.

Shrinkage and swelling in CLT panels due to seasonal changes in the ambient environmental conditions need to be taken into account when designing connections. This is particularly important when other sealant products and membranes are incorporated as that might compromise the effectiveness of such products. Differential movement between CLT and other wood-based products or materials (in case of mixed materials and systems) need to be taken into account at the design and detailing stages due to potential shrinkage-induced stress that could undermine the connection capacity in CLT. More information and guidelines related to detailing will be provided in future versions of this document as additional studies need to be performed.



Figure 42

Tight fit between individual panels is ensured using special installation devices (courtesy of U.S. WoodWorks)

7

DESIGN EXAMPLES

7.1 Example 1: Bolted Lateral Connection in CLT Face Lamination

7.1.1 Metal Plate Connection to CLT

Materials

3-ply grade E2 CLT (three times 1.5" plies = 4.5", see Figure), specific gravity (G) = 0.50

¼" steel plate, ASTM A36 steel, $F_c = 87,000$ psi

1" bolt with washers on each end, $F_{yb} = 45,000$ psi

Design

Design for short-term loading ($C_D=1.6$)

$C_M=1.0$, $C_t=1.0$, $C_g=1.0$, $C_\Delta=1.0$

From NDS Table 11.3.3:

$$F_{e\parallel} = 5600 \text{ psi}$$

$$F_{e\perp} = 2250 \text{ psi}$$

In this example, loading at the shear plane will be parallel to grain in the CLT.
The bearing length of the fastener must be reduced.

Bearing length in wood:

$$l_m = t_{1\parallel} + t_{2\perp} + t_{3\parallel} = 3(1.5) = 4.5'' \quad (\text{NDS 11.3.5})$$

Adjusted bearing length for lateral calculations:

$$l_{m-adj} = t_1 + t_2 (F_{e\perp} / F_{e\parallel}) + t_3 = 1.5 + (1.5)(2250/5600) + 1.5 = 3.6''$$

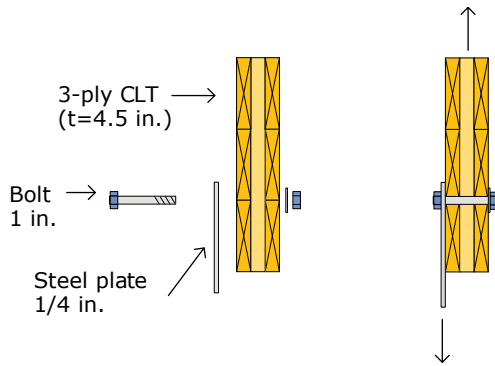

Figure 43

Bolted lateral connection in CLT face lamination

Calculation of ASD adjusted design value using NDS Yield Limit Equations (i.e., with k_1 , k_2 , k_3 , R_d and R_e values calculated based on traditional practice following the NDS):

$$\text{Mode } I_m: Z = \frac{Dl_m F_{em}}{R_d} = \frac{(1.0)(3.6)(5600)}{4} = 5040 \text{ lb.}$$

$$\text{Mode } I_s: Z = \frac{Dl_s F_{es}}{R_d} = \frac{(1.0)(0.25)(87,000)}{4} = 5438 \text{ lb.}$$

$$\text{Mode II: } Z = \frac{k_1 D l_s F_{es}}{R_d} = \frac{(0.3858)(1.0)(0.25)(87,000)}{3.6} = 2331 \text{ lb.}$$

$$\text{Mode III}_m: Z = \frac{k_2 D l_m F_{em}}{(1+2R_e)R_d} = \frac{(0.6106)(1.0)(3.6)(5600)}{(1+2(0.064))(3.2)} = 3410 \text{ lb.}$$

$$\text{Mode III}_s: Z = \frac{k_3 D l_s F_{em}}{(2+R_e)R_d} = \frac{(0.8682)(1.0)(0.25)(87,000)}{(2+0.064)(3.2)} = 2859 \text{ lb.}$$

$$\text{Mode IV: } Z = \frac{D^2}{R_d} \sqrt{\frac{2F_{em}F_{yb}}{3(1+R_e)}} = \frac{(1.0)^2}{3.2} \sqrt{\frac{(2)(5600)(45,000)}{(3)(1+0.064)}} = 3926 \text{ lb.}$$

Mode II controls and $Z_{\parallel} = 2331 \text{ lb.}$

$$Z_{\parallel}' = Z_{\parallel} C_D = 2331 (1.6) = 3730 \text{ lb.}$$

Alternatively, a slightly more conservative value can be interpolated from the NDS Table 11B (assuming $G=0.50$, $D=1''$, and $t_m=3.6''$):

$$Z_{\parallel} = 2309 \text{ lb.}$$

$$Z_{\parallel}' = 2309 (1.6) = 3695 \text{ lb.}$$

7.2 Example 2: Lag Screw Lateral Connection in CLT Face Lamination

7.2.1 Design of Half-lapped Joint for Shear Parallel to the Face Grain of the Panels

Materials

3-ply grade E1 CLT (three times 1.375" plies = 4.125", see Figure), specific gravity (G) = 0.42

3/8" lag screws, root diameter (D_r) = 0.265", lag screw length (L) = 4"

Tip length (E) = 0.22", F_{yb} = 45,000 psi

Design

Design for short-term loading ($C_D=1.6$)

$C_M=1.0$, $C_t=1.0$, $C_g=1.0$, $C_\Delta=1.0$

From NDS Table 11.3.3:

$F_{e\parallel} = 4700 \text{ psi}$

$F_{e\perp} = 2850 \text{ psi}$

$F_{es} = F_{em} = F_{e\perp} = 2850 \text{ psi}$

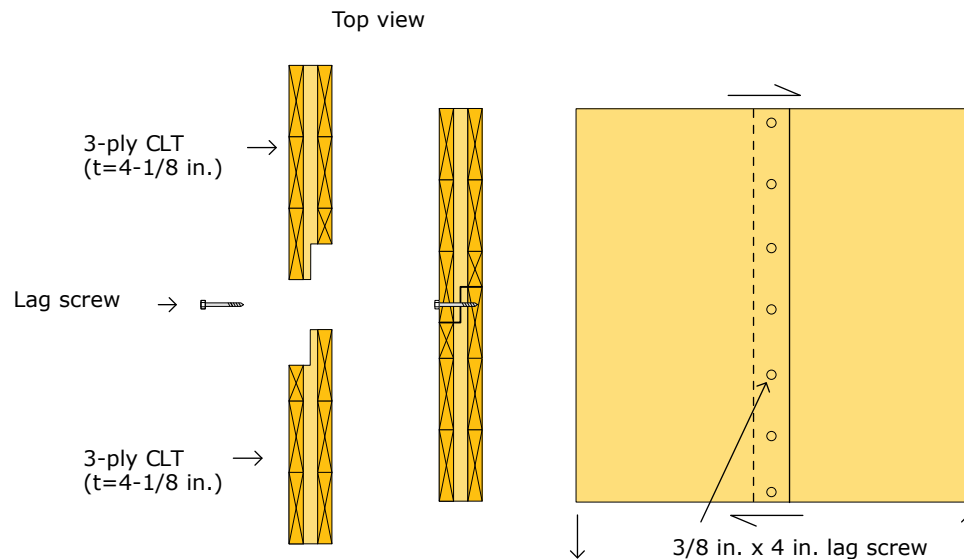

Figure 44

Lateral resistance of half-lapped joint using lag screws

In this example, the grain orientation at the joint is perpendicular to the face grain of the CLT; therefore, loading of the lag screw at the shear plane will be perpendicular to grain. While the bearing length of the fastener can be adjusted, it is not required. For purposes of the example, both solutions will be provided.

Bearing length in the lap joint:

$$l_s = t_{l\parallel} + t_{2\perp}/2 = 1.375 + (1.375/2) = 2.06'' \quad (\text{NDS 11.3.5})$$

$$p = L - l_s = 4 - 2.06 = 1.94''$$

$$l_m = p - E/2 = 1.94 - (0.22/2) = 1.83'' \quad (\text{NDS 11.3.5})$$

Check p_{\min} :

$$p_{\min} = p - E > 4D \quad (\text{NDS 11.1.4.6})$$

$$p_{\min} = 1.94 - 0.22 > 4 * 0.265$$

$$p_{\min} = 1.72'' > 1.06''$$

Adjusted bearing length for lateral calculations:

$$l_{s\text{-adj}} = t_{l\parallel} (F_{e\parallel} / F_{e\perp}) + t_{2\perp}/2 = 1.375 (4700/2850) + (1.375/2) = 2.96''$$

$$l_{m\text{-adj}} = t_{2\perp}/2 + (p - t_{2\perp}/2)(F_{e\parallel} / F_{e\perp}) - E/2 = (1.375/2) + (1.94 - 1.375/2)(4700/2850) - 0.22/2 = 2.64''$$

Calculation of ASD adjusted design value using NDS Yield Limit Equations:

$$\text{Mode } I_m: \quad Z = \frac{D l_m F_{em}}{R_d} = \frac{(0.265)(2.64)(2850)}{5} = 399 \text{ lb.}$$

$$\text{Mode } I_s: \quad Z = \frac{D l_s F_{es}}{R_d} = \frac{(0.265)(2.96)(2850)}{5} = 447 \text{ lb.}$$

$$\text{Mode } II: \quad Z = \frac{k_1 D l_s F_{es}}{R_d} = \frac{(0.3942)(0.265)(2.96)(2850)}{4.5} = 196 \text{ lb.}$$

$$\text{Mode } III_m: \quad Z = \frac{k_2 D l_m F_{em}}{(1+2R_e)R_d} = \frac{(1.077)(0.265)(2.64)(2850)}{(1+2)(4)} = 179 \text{ lb.}$$

$$\text{Mode } III_s: \quad Z = \frac{k_3 D l_s F_{em}}{(2+R_e)R_d} = \frac{(1.062)(0.265)(2.96)(2850)}{(2+1)(4)} = 198 \text{ lb.}$$

$$\text{Mode } IV: \quad Z = \frac{D^2}{R_d} \sqrt{\frac{2F_{em}F_{yb}}{3(1+R_e)}} = \frac{(0.265)^2}{4} \sqrt{\frac{(2)(2850)(45,000)}{(3)(1+1)}} = 115 \text{ lb.}$$

$$Z_{\perp} = 115 \text{ lb.}$$

$$Z'_{\perp} = Z_{\perp} C_D = 115 (1.6) = 184 \text{ lb.}$$

Using the unadjusted bearing lengths, Mode IV still controls and $Z_{\perp} = 115 \text{ lb.}; Z'_{\perp} = 184 \text{ lb.}$

Alternatively, slightly more conservative values can also be taken from the NDS Table 11J assuming $G=0.42$ and a side member thickness greater than 2-1/2" and adjusted bearing length of at least 8D:

$$Z_{\perp} = 110 \text{ lb.}$$

$$Z'_{\perp} = 110 (1.6) = 176 \text{ lb.}$$

7.3 Example 3: Lag Screw Withdrawal Connection from CLT Face Lamination

Materials

5-ply grade V2 CLT (five times 1.375" plies = 6.875", see Figure), specific gravity (G) = 0.42
 1/4" steel plate, ASTM A36 steel, $F_c = 87,000$ psi
 1/2" lag screws, root diameter (D_r) = 0.371", lag screw length (L) = 7", thread length (T) = 4"
 Tip length (E) = 5/16", $F_{yb} = 45,000$ psi

Design

Design for short-term loading ($C_D=1.6$)
 $C_M=1.0$, $C_t=1.0$, $C_g=1.0$, $C_\Delta=1.0$

Length of fastener penetration:

$$t_s = 0.25''$$

$$p = L - t_s - E = 7 - 0.25 - 0.31 = 6.44''$$

$$p_t = T - E = 4 - 0.31 = 3.69'' < 6.44''$$

ASD adjusted withdrawal design value:

$$W = 291 \text{ lb./inch/lag screw} \quad (\text{NDS Table 11.2A})$$

$$W' = W C_D = (291)(1.6) = 466 \text{ lb./inch/lag screw} \quad (\text{NDS 11.2.1.3})$$

$$W' p_t = (466)(3.69) = 1720 \text{ lb./lag screw} \quad (\text{NDS 11.2.1.2})$$

Depending on the stiffness of the angle bracket and the position of the lag screw with regard to the bend angle, the withdrawal force loading the lag screw could be much larger than the vertical load on the angle bracket. Therefore, the strength of the metal bracket needs to be checked.

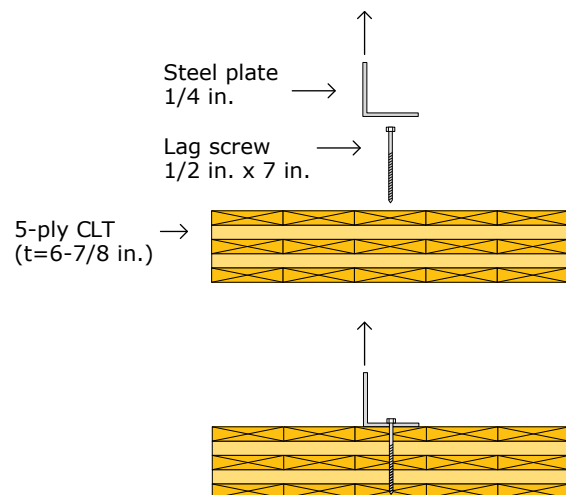

Figure 45
 Withdrawal resistance of lag screws from CLT face lamination

7.4 Example 4: Design of Corner Joint (i.e. Wall Intersection) for Out-of-Plane Loads

Materials

5-ply grade E3 CLT (five times 1.375" plies = 6.875", see Figure), specific gravity (G) = 0.36
 1/2" lag screws, root diameter (D_r) = 0.371", lag screw length (L) = 12", thread length (T) = 6"
 Tip length (E) = 5/16", F_{yb} = 45,000 psi
 Design for short-term loading (C_D = 1.6)
 C_M = 1.0, C_t = 1.0, C_g = 1.0, C_Δ = 1.0

7.4.1 Lag Screw Lateral Connection in CLT Edge

From NDS Table 11.3.3:

$$F_{e\parallel} = 4050 \text{ psi}$$

$$F_{e\perp} = 1950 \text{ psi}$$

$$F_{es} = F_{e\perp} = 1950 \text{ psi}$$

$$F_{em} = 0.55 F_{e\perp} = 1073 \text{ psi}$$

Lag screw
(1/2 in. x 12 in.)

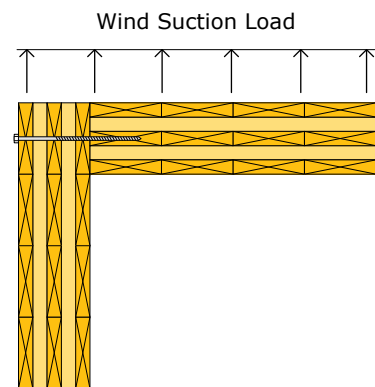
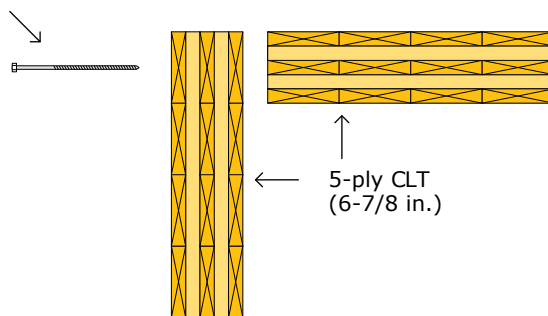

Figure 46

Corner joint: lag screw lateral resistance in CLT edge

In this example, the grain orientation at the joint is perpendicular to the face-grain of the CLT; therefore, loading of the lag screw at the shear plane will be perpendicular to grain. While the bearing length of the fastener can be adjusted, it is not required, so it will not be adjusted in this example. Bearing length in the lap joint:

$$l_s = 5t = 5(1.375) = 6.88'' \quad (\text{NDS 11.3.5})$$

$$p = L - l_s = 12 - 6.88 = 5.12''$$

$$l_m = p - E/2 = 5.12 - 0.31/2 = 4.96'' \quad (\text{NDS 11.3.5})$$

Check p_{\min} :

$$\begin{aligned} p_{\min} &= p - E && > 4D && \text{(NDS 11.1.4.6)} \\ p_{\min} &= 5.12 - 0.31 && > 4*0.371 \\ p_{\min} &= 4.81'' && > 1.48'' \end{aligned}$$

Calculation of ASD adjusted design value using NDS Yield Limit Equations:

$$\text{Mode } I_m: Z = \frac{D L_m F_{em}}{R_d} = 395 \text{ lb.}$$

$$\text{Mode } I_s: Z = \frac{D L_s F_{es}}{R_d} = 995 \text{ lb.}$$

$$\text{Mode II: } Z = \frac{k_1 D L_s F_{es}}{R_d} = 332 \text{ lb.}$$

$$\text{Mode III}_m: Z = \frac{k_2 D L_m F_{em}}{(1+2R_e)R_d} = 200 \text{ lb.}$$

$$\text{Mode III}_s: Z = \frac{k_3 D L_s F_{em}}{(2+R_e)R_d} = 380 \text{ lb.}$$

$$\text{Mode IV: } Z = \frac{D^2}{R_d} \sqrt{\frac{2F_{em}F_{yb}}{3(1+R_e)}} = 157 \text{ lb.}$$

Mode IV controls with $Z_{\perp} = 157 \text{ lb.}$

$$Z_{\perp}' = Z_{\perp} C_D = 157 (1.6) = 251 \text{ lb.}$$

It should be noted that the loaded edge is prone to splitting. A splitting check of the panel with the screws inserted in the edge may be required. Alternatively, reinforcing the panel with fully threaded self-tapping screws is advisable.

7.4.2 Lag Screw Withdrawal Connection in CLT Edge

Length of fastener penetration:

$$t_s = 6.88''$$

$$p = L - t_s - E = 12 - 6.88 - 0.31 = 4.81''$$

$$p_t = T - E = 6 - 0.31 = 5.69'' > 4.81''$$

ASD adjusted withdrawal design value:

$$W = 231 \text{ lb./inch/lag screw} \quad \text{(NDS Table 11.2A)}$$

$$W' = W C_{eg} C_D = (231)(0.75)(1.6) = 277 \text{ lb./inch/lag screw} \quad \text{(NDS 11.2.1.3)}$$

$$W' p_t = (277)(4.81) = 1333 \text{ lb./lag screw} \quad \text{(NDS 11.2.1.2)}$$

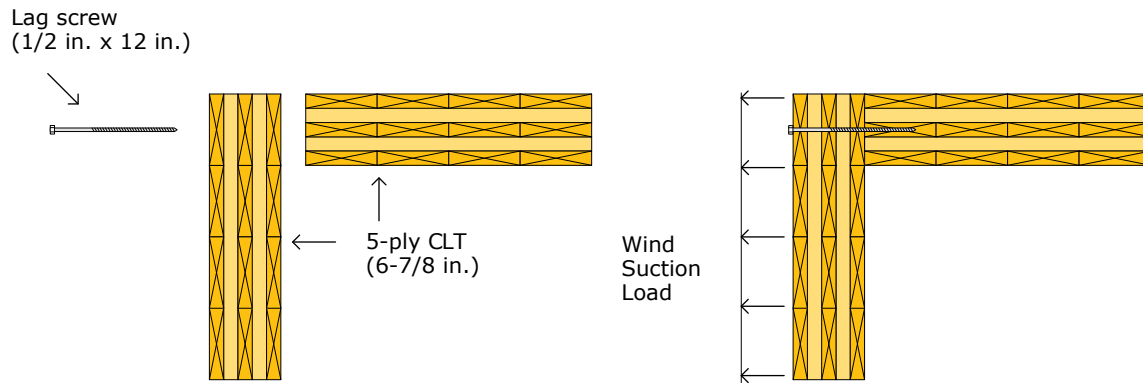

Figure 47
Corner joint: lag screw withdrawal resistance in CLT edge

7.5 Example 5: Design of Nailed Metal Plate Connection to CLT

Materials

5-ply grade V1 CLT (five times 1.375" = 6.875", see Figure), specific gravity (G) = 0.50

16 gauge (0.060" thick) steel plate, ASTM A653, grade 33 steel, $F_c = 61,850$ psi

10 8d common nails (0.131" x 2.5"), $F_{yb} = 100,000$ psi

Design for short-term loading ($C_D = 1.6$)

$C_M = 1.0$, $C_t = 1.0$, $C_g = 1.0$, $C_\Delta = 1.0$

Nailed lateral connection

Bearing lengths:

$$l_s = 0.060'' \quad (\text{NDS 11.3.5})$$

$$p = L - l_s = 2.5 - 0.060 = 2.44''$$

$$l_m = p - E/2 = 2.44 - 2(0.131)/2 = 2.31'' \quad (\text{NDS 11.3.5})$$

Check p_{\min} :

$$p_{\min}/D = 2.44/0.131 = 18.6 > 6D = 0.79'' \quad (\text{NDS 11.1.5.5})$$

ASD adjusted lateral design value:

$$Z = 97 \text{ lb./nail} \quad (\text{NDS Table 11P})$$

$$Z' = Z C_D = 97 (1.6) = 155 \text{ lb./nail}$$

$$\text{Total } Z' = 155 * 10 = 1550 \text{ lb.}$$

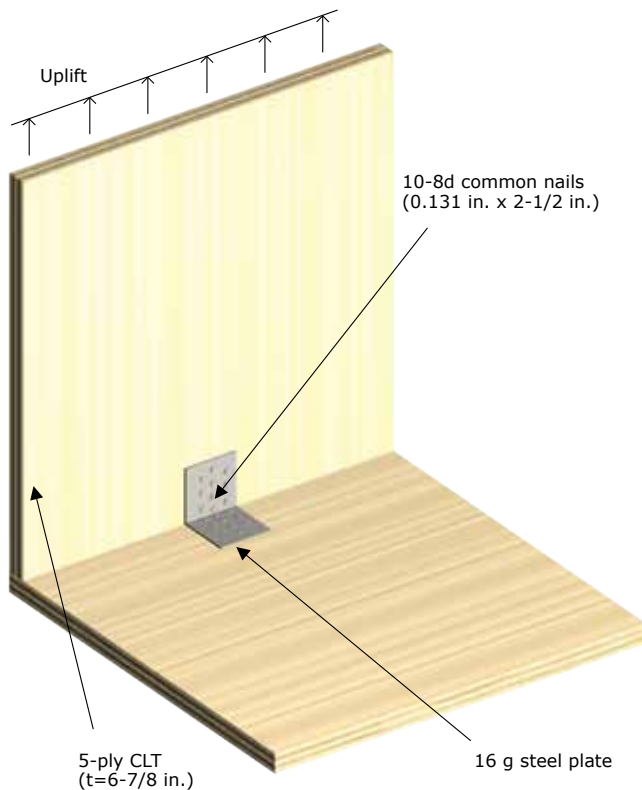

Figure 48
Nailed metal plate connection to CLT (lateral and withdrawal)

Note: The nails close to the bend line will be predominantly loaded, while the nails further away will be hardly loaded in withdrawal. This means that the connection capacity in withdrawal could be significantly less than the total withdrawal capacity of 10 nails.

While the total lateral capacity of this connection has been calculated to 1550 lb., in many cases, the size of the steel plate and spacing of the nails can lead to group failure modes of the wood member (brittle failure mode) or steel side plate which are not specifically addressed in the NDS. Provisions in Appendix E of NDS can be used to evaluate some of these modes, but testing of the connection should be undertaken to ensure that the connection capacity is not limited by wood failure.

Nailed withdrawal connection

Length of fastener penetration:

$$t_s = 0.060''$$

$$p_t = L - t_s = 2.5 - 0.060 = 2.44''$$

ASD adjusted withdrawal design value:

$$W = 32 \text{ lb./inch/nail}$$

(NDS Table 11.2C)

$$W' = W C_D = (32)(1.6) = 51 \text{ lb./inch/nail}$$

$$W' p_t = (51)(2.44) = 125 \text{ lb./nail}$$

(NDS 11.2.4)

$$\text{Total } W' p_t = 10(125) \text{ lb./nail} = 1250 \text{ lb.}$$

8

CONCLUSION

Connections in timber construction, including those built with CLT, play an important role in maintaining the integrity of the timber structure and in providing strength, stiffness, stability and ductility. Consequently, they require detailed attention by designers.

Traditional and innovative connection systems have been used in CLT assemblies in Europe. Several types of traditional and innovative connection systems for connecting CLT panels to panels, walls to walls and walls to floors are described in detail in this Chapter. They are mostly based on the European experience.

Researchers in Europe have developed design procedures for traditional connections in CLT, including dowels, wood screws and nails which are commonly used in Europe for designing CLT assemblies. The proposed design procedure deals only with ductile failure modes to determine the lateral load resistance of such connections. Expressions were developed for the calculation of characteristic dowel-bearing properties of each type of fastener, depending on its location with respect to the plane of the panel (perpendicular to or on edge). The expressions were verified and results seem to correspond well with predictions. European Yield Model equations for ductile failure modes as given in Eurocode 5 were adopted for design using CLT fastener dowel-bearing equations.

Due to the reinforcing effect of cross lamination in CLT, it is speculated that current minimum geometric requirements given in the NDS for dowels, screws and nails in solid timber or glulam are applicable to CLT. However, designers need to be cautious about this as further verification is required, considering the specific features of each panel. Brittle failure modes need also to be taken into account and have not yet been investigated. Further work is needed to verify possible brittle failure modes associated with each type of fasteners in CLT connections as well as their behavior for seismic design.

9

REFERENCES

- American Forest & Paper Association (AF&PA). 2012. *National design specification (NDS) for wood construction commentary*. Washington, DC: AF&PA.
- Augustin, M., ed. 2008. *Timber structures*. Handbook 1 of *Educational materials for designing and testing of timber structures*: TEMTIS. Leonardo da Vinci Pilot Project No. CZ/06/B/F/PP/168007. Ostrava, Czech Republic: VSB-Technical University of Ostrava.
- European Committee for Standardization (CEN). 2004. *Eurocode 5: Design of timber structures. Part 1-1: General – Common rules and rules for buildings*. EN 1995-1-1. Brussels: CEN.
- _____. 2011. *Timber structures – Cross laminated timber – Requirements*. Draft European Standard. Brussels: CEN/TC 124.
- Gagnon, S. and C. Pirvu, eds. 2011. *CLT Handbook : Cross-laminated timber*. Canadian ed. Special Publication SP-528E. Québec, QC: FPIInnovations. 1 v.
- Mohammad, M., and W. Munoz. 2011. Connections in cross-laminated timber buildings. In *CLT handbook*, ed. S. Gagnon and C. Pirvu. Chapter 5. Québec, QC: FPIInnovations.
- TRADA. 2009. *Cross laminated timber: Structural principles*. High Wycombe, UK: TRADA.
- Traetta, G. 2007. Connection Techniques for CLT elements. Paper presented at the Temtis Austrian Country Seminar: Cross-Laminated Timber, Graz, Austria.
- Uibel, T., and H.J. Blass. 2006. Load carrying capacity of joints with dowel type fasteners in solid wood panels. Paper presented at the 39th meeting of the Working Commission W18 – Timber Structures, International Council for Research and Innovation in Building and Construction, Florence, Italy, August 2006.
- _____. 2007. Edge joints with dowel type fasteners in cross laminated timber. Paper presented at the 40th meeting of the Working Commission W18 – Timber Structures, International Council for Research and Innovation in Building and Construction, Bled, Slovenia, August 2007.

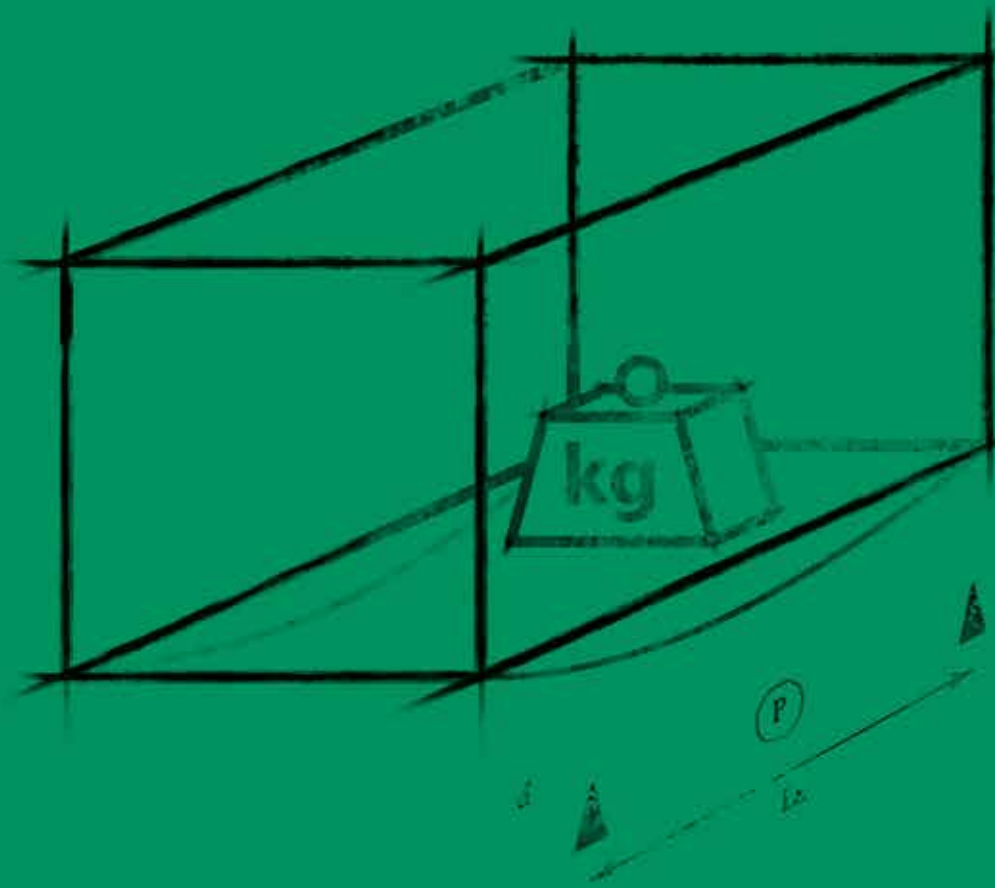

DOOL and creep

Duration of load and creep factors
for cross-laminated timber panels

CHAPTER 6

Authors

Ciprian Pirvu, Ph.D., P.Eng., FPIInnovations
Bradford Douglas, P.E., American Wood Council
Borjen Yeh, Ph.D., P.E., APA

Peer Reviewers

Bruce Craig, M.Sc., Consultant
Erol Karacabeyli, M.A.Sc., P.Eng., FPIInnovations

ACKNOWLEDGEMENTS

The U.S. Edition of the CLT Handbook: *cross-laminated timber* combines the work and knowledge of American, Canadian and European specialists. The handbook is based on the original Canadian Edition of the CLT Handbook: *cross-laminated timber*, that was developed using a series of reports initially prepared by FPInnovations and collaborators to support the introduction of CLT in the North American market. A multi-disciplinary team revised, updated and implemented their know-how and technologies to adapt this document to U.S. standards.

The publication of this handbook was made possible with the special collaboration of the following partners:



The editing partners would also like to express their special thanks to Binational Softwood Lumber Council, Forestry Innovation Investment (FII), Nordic Engineered Wood, Structurlam, and CLT Canada for their financial contribution to studies in support of the introduction of cross-laminated timber products in the United States of America.



© 2013 FPInnovations and Binational Softwood Lumber Council. All rights reserved.

The U.S. Edition of the CLT Handbook: *cross-laminated timber* can be electronically downloaded without charge from the website www.masstimber.com. Additional information can be obtained by visiting the websites of FPInnovations, USFPL, American Wood Council (AWC), APA and U.S. WoodWorks. Hard copies can be obtained through AWC (www.awc.org).

No part of this published Work may be reproduced, published, or transmitted for commercial purposes, in any form or by any means, electronic, mechanical, photocopying, recording or otherwise, whether or not in translated form, without the prior written permission of FPInnovations and Binational Softwood Lumber Council.

The information contained in this Work represents current research results and technical information made available from many sources, including researchers, manufacturers, and design professionals. The information has been reviewed by professionals in wood design including professors, design engineers and architects, and wood product manufacturers. While every reasonable effort has been made to insure the accuracy of the information presented, and special effort has been made to assure that the information reflects the state-of-the-art, none of the above-mentioned parties make any warranty, expressed or implied, or assume any legal liability or responsibility for the use, application of, and/or reference to opinions, findings, conclusions, or recommendations included in this published work, nor assume any responsibility for the accuracy or completeness of the information or its fitness for any particular purpose.

This published Work is designed to provide accurate, authoritative information but is not intended to provide professional advice. It is the responsibility of users to exercise professional knowledge and judgment in the use of the information.

ABSTRACT

Cross-laminated timber (CLT) products are used as load-carrying slab and wall elements in structural systems, thus load duration and creep behavior are critical characteristics that must be addressed in structural design. Given its lay-up construction with orthogonal arrangement of layers bonded with structural adhesive, CLT is more prone to time-dependent deformations under load (creep) than other engineered wood products such as structural glued-laminated timber.

Time dependent behavior of structural wood products is addressed in design standards by load duration factors that adjust design properties. Since CLT has been recently introduced into the North American market, the current design standards and building codes do not specify load duration and creep adjustment factors for CLT. Until this can be rectified, an approach is proposed in this Chapter for adopters of CLT systems in the United States. This includes not only load duration and service factors, but also an approach to accounting for creep in CLT structural elements.

TABLE OF CONTENTS

Acknowledgements	ii
Abstract	iii
List of Tables	v
1 Introduction	1
2 Duration of Load and Creep Effects in the United States Codes and Standards	2
2.1 Load Duration Factors in ANSI/AWC NDS-2012	2
2.2 Total Deflection under Long-term Loading in ANSI/AWC NDS-2012	4
2.3 Temperature Factors in ANSI/AWC NDS-2012	4
2.4 Service Condition Factors in ANSI/AWC NDS-2012	5
3 Recommended Approach for Duration of Load and Creep Effects of CLT in the United States	7
4 Modification Factors for Connections used in CLT Buildings	9
5 Product-specific Parameters that May Affect Duration of Load and Creep Effects of CLT	10
5.1 Adhesives	10
5.2 Edge-gluing and Width-to-thickness Ratio	10
5.3 Stress Release Grooves	11
5.4 Nail or Wooden Dowel Fastened CLT Products	11
6 References	12
Appendix A	14
A1 Duration of Load and Creep Effects in European Codes and Standards	14
A1.1 Strength Modification Factors in EN 1995-1-1	16
A1.2 Deformation Modification Factors in EN 1995-1-1	17
A2 European Approach for Duration of Load and Creep Effects of CLT	17

List of Tables

- Table 1** Load duration factors for ASD, C_D (Table 2.3.2, ANSI/AWC NDS-2012) **3**
- Table 2** Time effect factors for LRFD, λ (Table N.3, ANSI/AWC NDS-2012) **3**
- Table 3** Temperature factors, C_t (from Table 2.3.3 in ANSI/AWC NDS-2012) **5**
- Table 4** Service adjustment factors for structural glued-laminated timber (from Table 5.3.1 and Table 5A/5B/5C/5D in ANSI/AWC NDS-2012) **6**
- Table 5** Load duration classes (Table 2.1, EN 1995-1-1) **14**
- Table 6** Service classes (Clause 2.3.1.3, EN 1995-1-1) **15**
- Table 7** Strength modification factor, k_{mod} (Table 3.1, EN 1995-1-1) **16**
- Table 8** Deformation modification factor, k_{def} (Table 3.2, EN 1995-1-1) **17**
- Table 9** Deformation modification factor, k_{def} adjusted to CLT (based on recommendations of Jöbstl and Schickhofer - 2007) **18**
- Table 10** Recommended values of ψ factors for buildings (from Table A.1.1 in EN 1990) **19**

1

INTRODUCTION

This Chapter aims at describing how the duration of load¹ and creep² effects of wood are taken into account in design of wood structures, when the design is carried out in accordance with the current design standards for wood construction in the United States. Since cross-laminated timber (CLT) is not covered by the National Design Specification for Wood Construction (NDS), the intent of this Chapter is to recommend an approach that accounts for the duration of load and creep effects in the design of CLT.

¹ Load duration is defined as the period of continuous application of a given load or a series of periods of intermittent applications of the same load type (IBC® Commentary, 2009).

² Creep is defined as a slow deformation of a material in time under constant loading.

2

DURATION OF LOAD AND CREEP EFFECTS IN THE UNITED STATES CODES AND STANDARDS

Current duration of load factors for wood were determined many years ago based on the work that led to the development of the Madison Curve³. Some tests conducted in the development of this curve lasted as long as ten years; so repeating this work to develop a similar curve for CLT is not practical.

Furthermore, the most recent product standard developed for the evaluation of duration of load and creep effects (ASTM D6815, 2009) is a pass/fail procedure meant to verify that the current creep/duration of load adjustments are appropriate for new products and was developed for the evaluation of engineered wood products. The background information on the development of ASTM D6815 is described in its commentary and in the literature (Karacabeyli, 2001). This standard, at the moment, does not provide a method for calculation of duration of load or creep factors, and therefore it would not be practical to carry out ASTM D6815 tests on full-size CLT specimens as it cannot lead to duration of load and creep factors specific to CLT. The National Design Specification for Wood Construction, ANSI/AWC NDS-2012 (AWC, 2012) takes into account duration of load (that accounts for the dependency of wood on duration of applied load); however, it does not include the effect of moisture on the duration of applied load. It should be noted that CLT products manufactured in accordance with ANSI/APA PRG 320 standard (ANSI, 2011), as discussed in Chapter 2 *Cross-laminated timber manufacturing*, are limited to the use in dry service conditions (i.e., moisture content of less than 16%).

2.1 Load Duration Factors in ANSI/AWC NDS-2012

A load duration factor, C_D , is specified in Clause 2.3.2 of ANSI/AWC NDS-2012 for Allowable Stress Design (ASD) for six load categories: permanent, ten years, two months, seven days, ten minutes, and impact loading. The reference design values are given for normal load duration which assumes full design load for a cumulative period of ten years. The load duration factors for ASD are given in Table 1.

³The Madison Curve shows the predicted relationship between bending strength and duration of load of wood. It is based on load duration tests of small clear specimens (Wood, 1951).

Table 1Load duration factors for ASD, C_D (Table 2.3.2, ANSI/AWC NDS-2012)

Load Duration	C_D^1	Typical Design Loads
Permanent	0.9	Dead load
Ten years	1.0	Occupancy live load
Two months	1.15	Snow load
Seven days	1.25	Construction load
Ten minutes	1.6	Wind/earthquake load
Impact ²	2.0	Impact load

Notes: ¹ Load duration factors do not apply to reference modulus of elasticity, E , reference modulus of elasticity for beam and column stability, E_{min} , and reference compression perpendicular to grain design values, F_{cL} , which are based on a deformation limit.

² Load duration factors greater than 1.6 do not apply to structural members pressure-treated with water-borne preservatives, or fire retardant chemicals. The impact load duration factor does not apply to connections.

In the case of Load and Resistance Factor Design (LRFD), design properties are adjusted by the time effect factor, λ , given in Clause 2.3.7 of ANSI/AWC NDS-2012 and shown in Table 2.

Table 2Time effect factors for LRFD, λ (Table N.3, ANSI/AWC NDS-2012)

Load Combination ²	Time Effect Factors, λ
1.4D	0.6
1.2D+1.6L+0.5(L _r or S or R)	0.7 when L is from storage
	0.8 when L is from occupancy
	1.25 when L is from impact ¹
1.2D+1.6(L _r or S or R)+(L or 0.8W)	0.8
1.2D+1.0W+L+0.5(L _r or S or R)	1.0
1.2D+1.0E+L+0.2S	1.0
0.9D+1.0W	1.0
0.9D+1.0E	1.0

Notes:

¹ Time effect factors, λ , greater than 1.0 shall not apply to connections or to structural members pressure-treated with water-borne preservatives (see Reference 30 in ANSI/AWC NDS-2012) or fire retardant chemicals.

² Load combinations and load factors consistent with ASCE/SEI 7-10 (ASCE, 2010) are listed for ease of reference. Nominal loads shall be in accordance with N.1.2 of ANSI/AWC NDS-2012. D = dead load; L = live load; L_r = roof live load; S = snow load; R = rain load; W = wind load; and E = earthquake load.

Design properties adjusted for duration of load are determined by multiplication of ASD reference design values by the load duration factors given in Table 1 and LRFD reference design values by time effect factors given in Table 2. The load duration factors, as indicated above, are used to adjust design values of solid sawn lumber, engineered wood products, and connections.

2.2 Total Deflection under Long-term Loading in ANSI/AWC NDS-2012

Clause 3.5.2 of ANSI/AWC NDS-2012 provides an equation for calculating the total deflection under long-term loading when the design is governed by deflection and this must be limited:

$$\Delta_T = K_{cr} \Delta_{LT} + \Delta_{ST} \quad [1]$$

where,

- K_{cr} = time dependent deformation (creep) factor
 - = 1.5 for seasoned lumber, structural glued-laminated timber, prefabricated wood I-joists, or structural composite lumber used in dry service conditions.
 - = 2.0 for structural glued-laminated timber used in wet service conditions (i.e., where moisture content in service is 16% or higher)
 - = 2.0 for wood structural panels used in dry service conditions (i.e., where moisture content in service is less than 16%)
 - = 2.0 for unseasoned lumber or for seasoned lumber used in wet service conditions (i.e., where moisture content in service exceeds 19% for an extended period of time)
- Δ_{LT} = immediate deflection due to the long-term component of the design load
- Δ_{ST} = deflection due to the short-term or normal component of the design load

2.3 Temperature Factors in ANSI/AWC NDS-2012

ANSI/AWC NDS-2012 provides temperature factors, C_p , for structural members expected to be exposed to sustained elevated temperatures up to 150°F (65.5°C) in service⁴. Reference design values for specific loading conditions and in-service moisture conditions are multiplied by the appropriate temperature factors, which are shown in Table 3.

⁴ The temperature effect is reversible up to 150°F (65.5°C), i.e., wood regains its strength after it is cooled to its normal temperature; prolonged exposure to temperatures beyond 150°F (65.5°C) can cause irreversible damage to the wood structure and permanent loss of strength. The magnitude of the temperature effect is dependent on the moisture content of the wood, which varies according to the in-service moisture conditions.

Table 3

Temperature factors, C_t (from Table 2.3.3 in ANSI/AWC NDS-2012)

Reference Design Value ¹	In-service Moisture Conditions ²	Temperature Factors, C_t		
		$T \leq 100^\circ\text{F}$ ($T \leq 37.7^\circ\text{C}$)	$100^\circ\text{F} < T \leq 125^\circ\text{F}$ ($37.7^\circ\text{C} < T \leq 51.6^\circ\text{C}$)	$125^\circ\text{F} < T \leq 150^\circ\text{F}$ ($51.6^\circ\text{C} < T \leq 65.5^\circ\text{C}$)
F_t, E, E_{\min}	Wet or Dry	1.0	0.9	0.9
$F_b, F_v, F_c,$ and $F_{c\perp}$	Dry	1.0	0.8	0.7
	Wet	1.0	0.7	0.5

Notes:

¹ F_b = reference bending design value, psi; F_t = reference tension design value parallel to grain, psi; F_v = reference shear design value parallel to grain (horizontal shear), psi; $F_{c\perp}$ = reference compression design value perpendicular to grain, psi; F_c = reference compression design value parallel to grain, psi; E = reference modulus of elasticity, psi; E_{\min} = reference modulus of elasticity for beam stability and column stability calculations, psi.

² Wet and dry service conditions for structural glued-laminated timber and wood structural panels are described in section 2.4.

2.4 Service Condition Factors in ANSI/AWC NDS-2012

ANSI/AWC NDS-2012 defines service conditions for various wood products. In the case of structural glued-laminated timber and plywood, dry service conditions apply when the average equilibrium moisture content in service is less than 16%, as in most protected structures. To deal with service conditions other than dry (i.e., when average equilibrium moisture content in service is 16% or greater), ANSI/AWC NDS-2012 provides wet service factors, C_M . Reference design values for specific loading conditions are multiplied by the appropriate wet service factors. Service adjustment factors for structural glued-laminated timber are shown in Table 4.

Table 4

Service adjustment factors for structural glued-laminated timber (from Table 5.3.1 and Table 5A/5B/5C/5D in ANSI/AWC NDS-2012)

Service Adjustment Factors (for ASD and LRFD), psi			Structural Glued-laminated Timber	
			Dry Service Factor	Wet Service Factor, C_M
Bending ¹	F_b	x	1.00	0.8
Tension ²	F_t	x	1.00	0.8
Shear ³	F_v	x	1.00	0.875
Compression perpendicular to grain ⁴	$F_{c\perp}$	x	1.00	0.53
Compression parallel to grain ⁵	F_c	x	1.00	0.73
Radial tension perpendicular to grain ⁶	F_{rt}	x	1.00	0.875
Modulus of elasticity ⁷	E	x	1.00	0.833
Modulus of elasticity (beam/column stability) ⁸	E_{min}	x	1.00	0.833

Notes:

¹ F_b = reference bending design value, psi; ² F_t = reference tension design value parallel to grain, psi; ³ F_v = reference shear design value parallel to grain (horizontal shear), psi; ⁴ $F_{c\perp}$ = reference compression design value perpendicular to grain, psi; ⁵ F_c = reference compression design value parallel to grain, psi; ⁶ F_{rt} = reference radial tension design value perpendicular to grain, psi; ⁷ E = reference modulus of elasticity, psi; ⁸ E_{min} = reference modulus of elasticity for beam stability and column stability calculations, psi.

For wood structural panels used in service conditions other than dry (i.e., when average equilibrium moisture content in service is 16% or greater), wet service factors from an approved source, such as *Panel Design Specification* published by APA – The Engineered Wood Association, are used.

3

RECOMMENDED APPROACH FOR DURATION OF LOAD AND CREEP EFFECTS OF CLT IN THE UNITED STATES

CLT is not among the wood products covered in the ANSI/AWC NDS-2012, and consequently there are no load duration and service condition factors specified for this product. Until CLT is included in the NDS, this section provides proposed load duration and service factors as well as an approach to account for creep in CLT structural elements.

- 1) **Load Duration Factor:** It is recommended to use the load duration factor, C_D , for ASD as specified in Table 1 (from Table 2.3.2 of ANSI/AWC NDS-2012), or the time effect factor, λ , for LRFD as specified in Table 2 (from Table N.3 of ANSI/AWC NDS-2012).
- 2) **Temperature Factor:** It is recommended to use the temperature factor, C_t , given for structural glued-laminated timber in dry service conditions at temperatures up to 150°F (65.5°C) in Table 3 (from Table 2.3.3 in ANSI/AWC NDS-2012).
- 3) **Service Condition Factor:** For dry service conditions (i.e., moisture content of less than 16%), use the service condition factor of 1.0 (similar to the service adjustment factors for structural glued-laminated timber given in Table 4). Consult with the CLT manufacturer for other than dry service conditions.
- 4) **Creep Factor:** The current factor specified in ANSI/AWC NDS-2012 does not account for creep that may occur in CLT. Therefore, the time dependent deformation (creep) factor $K_{cr} = 2.0$ is recommended for dry service conditions. A creep factor $K_{cr} = 2.5$ is suggested for wet service conditions, although it is strongly recommended to consult with the CLT manufacturer before using any CLT product in conditions other than dry service.

The load duration factors specified in ANSI/AWC NDS-2012 may not conservatively account for shear perpendicular to the grain (rolling shear) effects; however, the design of CLT used as floor and roof elements is usually governed by deflection. The proposed time dependent deformation (creep) factor is based on 30%-40% higher creep values for CLT compared to structural glued-laminated timber for one year of sustained loading, as reported by Jöbstl and Schickhofer (2007). The factors for duration of load and creep in the European codes, and the approach taken for the duration of load and creep effects of CLT are described in the Appendix.

The designer is advised to check the elastic deflection and permanent deformation for CLT slab elements as to not exceed the total load deflection limit in the code (Table 1604.3 of the IBC (ICC, 2012)).

Verification of shear and bending out-of-plane strengths is explained in detail in Chapter 3, *Structural design of cross-laminated timber elements*.

The designer is advised to check the maximum floor vibrations for CLT slab elements. A design method for controlling vibrations in CLT floors is provided in Chapter 7, *Vibration performance of cross-laminated timber floors*.

4

MODIFICATION FACTORS FOR CONNECTIONS USED IN CLT BUILDINGS

Load duration and time-dependent slip behavior of connections also affect the performance of a CLT system. Clause 10.3.2 in ANSI/AWC NDS-2012 specifies for ASD the same load duration factors, C_D , for mechanical connections as shown in Table 1 with the exception of impact load duration, while clause 10.3.9 specifies the time effect factors in Table 2 for LRFD. Temperature factors, C_t , and wet service condition factors, C_M , for various fastener types are tabulated in Tables 10.3.4 and 10.3.3, respectively, in the ANSI/AWC NDS-2012 standard. Additional information on connections with CLT is given in Chapter 5, *Connections in cross-laminated timber buildings*.

5

PRODUCT-SPECIFIC PARAMETERS THAT MAY AFFECT DURATION OF LOAD AND CREEP EFFECTS OF CLT

5.1 Adhesives

A structural adhesive is not expected to creep in service. The U.S. standards for evaluation of adhesives for structural application have built-in tests for assessing creep under various loads and service conditions. The ANSI/APA PRG 320 standard specifies that adhesives for CLT manufacturing have to pass the minimum requirements of AITC 405, Standard for Adhesives for Use in Structural Glued Laminated Timber (AITC 405, 2008). The AITC 405 standard specifies the test methods of ASTM D 2559, Standard Specification for Adhesives for Bonded Structural Wood Products for Use Under Exterior Exposure Conditions (ASTM, 2012) and CSA O112.9, Evaluation of adhesives for structural wood products (exterior exposure) (CSA, 2004), for evaluation of creep resistance of adhesive bonds. Adhesives passing the minimum requirements of the required standards would show insignificant creep in the bond line relative to the creep that occurs in CLT products due to the orientation of cross laminations.

5.2 Edge-gluing and Width-to-thickness Ratio

CLT products without edge-glued laminations may have lower load-carrying capacities than those with edge-glued laminations due to lower rolling shear modulus. However, no research results have been published to show any correlation between rolling shear modulus of edge-glued and non-edge-glued laminations and its effect on load carrying capacity of the CLT element.

Parameters affecting rolling shear properties include: lamination width, direction of annual rings in boards, earlywood to latewood ratios, adhesive type, panel pressure during manufacturing, and type of loading. A true value of rolling shear modulus is difficult to obtain due to very low shear deflections measured during the tests, which makes the calculation of rolling shear modulus very sensitive to experimental error. In Europe, a rolling shear modulus of 7252 psi (50 MPa) is often used for CLT design; this value was obtained for spruce with an oven-dry density of 29 lb./ft.³ (460 kg/m³) (Aicher and Dill-Langer, 2000; Aicher *et al.*, 2001). Typically, rolling shear modulus for spruce ranges from 5802 psi (40 MPa) to 11603 psi (80 MPa) (Fellmoser and Blass, 2004).

Preliminary observation suggests a decrease in rolling shear modulus with decreasing width-to-thickness ratio of boards in the cross layer. A minimum width-to-thickness ratio of 4 is suggested for lumber to ensure good contact during pressing and adequate rolling shear strength (Schickhofer *et al.*, 2009; Schickhofer, 2010). The draft European standard for CLT recommends further verification through testing when the minimum width-to-thickness ratio of lumber is less than 4 (CEN, 2012). For these reasons, ANSI/APA PRG 320 requires that rolling shear strength and modulus be verified by testing when using cross laminations with a width-to-thickness ratio of less than 3.5. Research is ongoing to develop appropriate testing methods for assessing rolling shear strength of CLT, and to quantify the width-to-thickness effect.

5.3 Stress Release Grooves

CLT containing stress release grooves is beyond the scope of this CLT Handbook and the manufacturing and design provisions given in Chapter 2, *Cross-laminated timber manufacturing*, and Chapter 3, *Structural design of cross-laminated timber elements*, respectively, do not cover such products. Some manufacturers in Europe mill release grooves into lumber in cross laminations to minimize the effect of cupping. The depth of grooves may take up to 90% of the lumber thickness and may have a maximum width of 0.16 in. (4 mm) (CEN, 2012). CLT products manufactured with release grooves are likely to have lower load-carrying capacities than those without release grooves due to the lower rolling shear modulus of cross laminations caused by the release grooves. Failure of CLT loaded in bending is typically initiated in the cross layers by rotation of the cross layers and “rolling” of the earlywood zones in lumber (Augustin, 2008). The cross section is significantly reduced at the grooves and prone to failure under high loads generating narrower strips of lumber that are further likely to “roll” under load, leading to high deformations and, ultimately, failure. Since the release grooves are considered unbonded edges, it is recommended that rolling shear strength and modulus be verified by testing when using CLT containing stress release grooves.

5.4 Nail or Wooden Dowel Fastened CLT Products

Mechanically fastened CLT (i.e., not adhesively bonded) is beyond the scope of this CLT Handbook and the manufacturing and design provisions given in Chapter 2, *Cross-laminated timber manufacturing*, and Chapter 3, *Structural design of cross-laminated timber elements*, respectively, do not cover such products. In Europe, some manufacturers are using aluminum nails or wooden dowels to vertically connect wood layers in CLT. Some of these CLT products are not glued-laminated, and may deflect and creep significantly more than adhesively-bonded CLT. Researchers at the University of British Columbia have found up to four times larger deflections for nailed CLT specimens compared to glued CLT specimens for the same specimen thickness (Chen and Lam, 2008). The deflection range was due to different nailing schedules of the CLT layers. Some of these products may be more suitable for wall applications but the load duration and creep factors recommended in this document are not applicable to mechanically fastened CLT products.

6

REFERENCES

Aicher, S., and G. Dill-Langer. 2000. Basic considerations to rolling shear modulus in wooden boards. *Otto-Graf-Journal* 11:157-165.

Aicher, S., G. Dill-Langer, and L. Hofflin. 2001. Effect of polar anisotropy of wood loaded perpendicular to grain. *Journal of Materials in Civil Engineering* 13 (1):2-9.

American National Standards Institute (ANSI). 2008. *Standard for adhesives for use in structural glued laminated timber*. ANSI/AITC 405-2008. Centennial, CO: American Institute of Timber Construction (AITC).

_____. 2011. *Standard for performance-rated cross-laminated timber*. ANSI/APA PRG 320. Tacoma, WA: APA – The Engineered Wood Association.

American Society of Civil Engineers (ASCE). 2010. *Minimum design loads for buildings and other structures*. ASCE/SEI 7-10. Reston, VA: ASCE.

American Wood Council (AWC). 2012. *National design specification (NDS) for wood construction*. ANSI/AWC NDS-2012, Washington, DC: AWC.

ASTM International. 2009. *Standard specification for evaluation of duration of load and creep effects of wood and wood-based products*. ASTM D6815-09. West Conshohocken, PA: ASTM. 11 p.

_____. 2012. *Standard specification for adhesives for bonded structural wood products for use under exterior exposure conditions*. ASTM D2559-12a. West Conshohocken, PA: ASTM. 15 p.

Augustin, M., ed. 2008. Wood based panels (in particular cross laminated timber (CLT)). In *Timber structures*. Handbook 1 of *Educational materials for designing and testing of timber structures: TEMTIS*. Leonardo da Vinci Pilot Project No. CZ/06/B/F/PP/168007, p. 63-99.

Beuth Verlag GmbH. 2008. *Design of timber structures – Common rules and rules for buildings*. DIN 1052:2008-12. Berlin, Germany: Beuth Verlag GmbH.

Canadian Standards Association (CSA). 2004. *Evaluation of adhesives for structural wood products (exterior exposure)*. CSA O112.9-04. Mississauga ON: CSA.

Chen, J.Y., and F. Lam. 2008. Development of thick laminated MPB wood plates, prepared for Forestry Innovation Investment. Report MDP 08 – 0066B. Vancouver, BC: University of British Columbia. 18 p.

- European Committee for Standardization (CEN). 2002a. *Eurocode: Basis of structural design*. EN 1990. Brussels: CEN.
- _____. 2002b. *Eurocode 1: Actions on structures – Part 1-1: General actions – Densities, self-weight, imposed loads for buildings*. EN 1991-1-1. Brussels: CEN.
- _____. 2002c. *Eurocode 1: Actions on structures – Part 1-3: General actions – Snow loads*. EN 1991-1-3. Brussels: CEN.
- _____. 2002d. *Eurocode 1: Actions on structures – Part 1-4: General actions – Wind loads*. EN 1991-1-4. Brussels: CEN.
- _____. 2002e. *Eurocode 1: Actions on structures – Part 1-5: General actions – Thermal actions*. EN 1991-1-5. Brussels: CEN.
- _____. 2004. *Eurocode 5: Design of timber structures. Part 1-1: General – Common rules and rules for buildings*. EN 1995-1-1. Brussels: CEN.
- _____. 2012. Timber structures – Cross laminated timber – Requirements. DRAFT European Standard prEN 16351. Brussels: CEN/TC 124_W3.
- Fellmoser, P., and H.J. Blaß. 2004. Influence of rolling shear modulus on strength and stiffness of structural bonded elements. In *CIB-W18 Meeting 37, Edinburgh, United Kingdom*, paper 37-6-5.
- Gagnon, S. and C. Pirvu, eds. 2011. *CLT Handbook: Cross-laminated timber*. Canadian ed. Special Publication SP-528E. Québec, QC: FPInnovations. 1 v.
- International Code Council (ICC). 2012. *IBC® code and commentary*. 2 vols. Country Club Hills, IL: ICC.
- Jöbstl, R.A., and G. Schickhofer. 2007. Comparative examination of creep of GLT – and CLT – slabs in bending. In *CIB-W18 Meeting 40, Bled, Slovenia*, paper 40-12-3.
- Karacabeyli, E. 2001. Wood: Creep and creep rupture. *Encyclopedia of Materials: Science and Technology* 2001:9616-9620.
- Schickhofer, G. 2010. Cross-laminated timber (CLT) in Europe: From conception to implementation. Presentation made at the CLT Seminar, University of British Columbia, March 2010.
- Schickhofer, G., T. Bogensperger, T. Moosbrugger, R.A. Jöbstl, M. Augustin, A. Thiel, G. Traetta, et al. 2009. *BSPhandbuch: Holz-Massivbauweise in Brettspertholz*. Graz, Austria: Technische Universität Graz, Institute für Holzbau und Holztechnologie. 353 p.
- Swiss Association for Standardization (SVN). 2003. *Timber structures: Swiss building code*. SIA 265. Zurich, Switzerland: SVN.
- Wood, L. 1951. *Relation of strength of wood to duration of load*. Report R1916. Madison, WI: U.S. Department of Agriculture. Forest Service. Forest Products Laboratory.

APPENDIX A

The approach taken in this Chapter to account for the duration of load and creep effects of CLT makes use of the research carried out in Europe and the approach adopted to account for similar effects in the European codes and standards, which are described below.

A1 Duration of Load and Creep Effects in European Codes and Standards

The current European approach takes into account the duration of load and creep effects by introducing load duration classes associated with accumulated duration of load. The load duration and creep factors take into account duration of load classes and service classes, and they are product specific. The main factors affecting creep of wood-based products include the magnitude, type and duration of load, moisture content and temperature. Interactions occur among all factors, but only the combined effects of load duration and moisture content are taken into account in the design rules specified in EN 1995-1-1: Eurocode 5 – Design of Timber Structures (CEN, 2004), which provides load duration classes and modification factors for service classes that are used in the design of structures. Load duration classes are shown in Table 5, while service classes are shown in Table 6.

Table 5

Load duration classes (Table 2.1, EN 1995-1-1)

Load Duration Class	Accumulated Duration of Load
Permanent	> 10 years
Long term [†]	6 months - 10 years
Medium term	1 week - 6 months
Short term	< 1 week
Instantaneous	N/A

Note: [†]Long term load duration in ANSI/AWC NDS-2012 is 10 years, medium term is 2 months, short term is 7 days, and instantaneous is impact load duration. Ten-minute load duration is specified in ANSI/AWC NDS-2012 for wind/earthquake loads.

Table 6

Service classes (Clause 2.3.1.3, EN 1995-1-1)

Service Class	Climatic Condition
Service class 1	Moisture content (MC) of material at 68°F (20°C) and > 65% relative humidity (RH) for a few weeks per year (softwood timber MC < 12%; panels MC < 8%)
Service class 2	Moisture content (MC) of material at 68°F (20°C) and > 85% relative humidity (RH) for a few weeks per year (softwood timber MC < 20%; panels MC < 15%)
Service class 3	Condition leading to higher MC than service class 2 (timber MC > 20%; panels MC > 15%)

Note: ANSI/AWC NDS-2012 defines dry service conditions for lumber as climatic conditions at which MC in use is maximum 19% regardless of the MC at the time of manufacture. Similarly, dry service conditions for wood structural panels are climatic conditions at which MC in use is less than 16%. Wet service conditions correspond to all conditions other than dry.

A1.1 Strength Modification Factors in EN 1995-1-1

Product-specific strength modification factors, k_{mod} , for service classes and load duration classes are given in Table 7. Note that design strength and capacity values are based on tests to failure in 5 ± 2 minutes, and they are similar for structural glued-laminated timber and plywood.

Table 7

Strength modification factor, k_{mod} (Table 3.1, EN 1995-1-1)

Material/Load Duration Class	Service Class 1	Service Class 2	Service Class 3
Structural Glued-laminated Timber			
Permanent	0.60	0.60	0.50
Long term	0.70	0.70	0.55
Medium term	0.80	0.80	0.65
Short term	0.90	0.90	0.70
Instantaneous	1.10	1.10	0.90
Plywood ¹			
Permanent	0.60	0.60	0.50
Long term	0.70	0.70	0.55
Medium term	0.80	0.80	0.65
Short term	0.90	0.90	0.70
Instantaneous	1.10	1.10	0.90

Notes:

¹ Plywood classified in accordance to Part 1, Part 2 and Part 3 of EN 636 may be used under Service Class 1; plywood classified in accordance to Part 2 and Part 3 of EN 636 may be used under Service Class 2; and plywood classified in accordance to Part 3 of EN 636 may be used under Service Class 3. Additional information about the three plywood categories is given in Table 8.

A1.2 Deformation Modification Factors in EN 1995-1-1

Deformation or creep factor, k_{def} takes into account creep deformation for the relevant service classes, and is shown in Table 8.

Table 8

Deformation modification factor, k_{def} (Table 3.2, EN 1995-1-1)

Material (Standard)	Service Class 1	Service Class 2	Service Class 3
Solid timber ¹ (EN 14081-1)	0.60	0.80	2.00
Structural glued-laminated timber (EN 14080)	0.60	0.80	2.00
Plywood (EN 636) ²			
Part 1	0.80	-	-
Part 2	0.80	1.00	-
Part 3	0.80	1.00	2.50

Notes:

¹ k_{def} is to be increased by 1.00 for timber near saturation point which is likely to dry out under load;

² The 1997 edition of EN 636 classified plywood in the following three categories:

Part 1: Plywood manufactured for use in DRY conditions = interior applications with no risk of wetting, defined in hazard class 1, with a moisture content (MC) corresponding to environmental conditions of 68°F (20°C) and 65% RH (12% MC or less).

Part 2: Plywood manufactured for use in HUMID conditions = protected exterior applications as defined in hazard class 2, with a MC corresponding to environmental conditions of 68°F (20°C) and 90% RH (20% MC or less).

Part 3: Plywood manufactured for use in EXTERIOR conditions = unprotected external applications, as defined in hazard class 3, where the MC will frequently be above 20%.

The latest version of EN 636 (2003) integrates the three separate parts for plywood for use in dry conditions (EN 636-1:1997), humid conditions (EN 636-2:1997), and exterior conditions (EN 636-3:1997), and supersedes the 1997 editions.

A2 European Approach for Duration of Load and Creep Effects of CLT

Material properties including duration of load and creep factors for CLT are not specified in Eurocode 5 because of the proprietary nature of these products in Europe. However, CLT is covered in some national building codes such as DIN 1052, *Design of Timber Structures in Germany* (Beuth Verlag GmbH, 2008) and SIA 265, *Timber Structures Section of the Swiss Building Code* (SVN, 2003). Engineers in Europe use allowable design values indicated in product catalogues which are made available by the CLT manufacturers to design CLT structures, and obtain special approvals from local building officials.

Research conducted at Graz University of Technology in Austria concluded that long-term behavior of CLT products is more likely comparable with that of other cross-laminated wood-based products (such as plywood) as opposed to products laminated unidirectionally (such as structural glued-laminated timber) (Jöbstl and Schickhofer, 2007). The authors reported 30%-40% larger creep values for CLT compared to structural glued-laminated timber after one year loading in bending, which is attributed to crosswise layers in CLT. One year constant load duration can be assumed sufficient to account for the cumulative damage effects due to occupancy and snow loads. Using the deformation factor obtained for 5-layer CLT, the authors derived the deformation factors for CLT products ranging from 3 to 19 layers, and recommended using the deformation factor for plywood for CLT with more than 9 layers, and increase the deformation factor for plywood by 10% for CLT with 7 layers or less. A 10% increase in k_{def} factors for plywood (Table 8) is reflected in the calculation of k_{def} factors for CLT (Table 9) to account for the differences between CLT and structural glued-laminated timber test results obtained by Jöbstl and Schickhofer (2007). For long-term loads, however, a further increase of k_{def} or reduction of deformation limits is recommended.

Table 9

Deformation modification factor, k_{def} , adjusted to CLT (based on recommendations of Jöbstl and Schickhofer, 2007)

Material (Standard)	Service Class 1	Service Class 2	Service Class 3
CLT	0.90	1.10	N/A

In Eurocode 5, the final deformation is calculated for the quasi-permanent⁵ combination of actions. Assuming a linear relationship between the loads and the corresponding deformations, the final deformation (u_{fn}) may be calculated as a sum of the final deformation due to permanent loads ($u_{fn,p}$), the final deformation due to the main live loads ($u_{fn,Q1}$), and the final deformation due to accompanying live loads ($u_{fn,Qi}$) (Clause 2.2.3(5) of EN 1995-1-1).

$$u_{fn,p} = u_{inst,p} (1 + k_{def}) \text{ -- for permanent loads, P} \quad [2]$$

$$u_{fn,Q1} = u_{inst,Q1} (1 + \psi_{2,1} k_{def}) \text{ -- for main live loads, } Q_1 \quad [3]$$

$$u_{fn,Qi} = u_{inst,Qi} (\psi_{0,i} + \psi_{2,i} k_{def}) \text{ -- for accompanying live loads, } Q_i (i > 1) \quad [4]$$

$$u_{inst,p}, u_{inst,Q1}, u_{inst,Qi} = \text{instantaneous deformations for loads P, } Q_1, Q_i, \text{ respectively}$$

where,

$\psi_{2,1}, \psi_{2,i}$ = factors for the quasi-permanent value of live loads;

$\psi_{0,i}$ = factors for the combination value of live loads;

k_{def} = deformation factor.

The ψ factors given in EN 1990 (CEN, 2002a) are shown in Table 10.

⁵ Quasi-permanent combination is used mainly to take into account long-term effects.

Table 10Recommended values of ψ factors for buildings (from Table A.1.1 in EN 1990)

Action	ψ_0	ψ_1	ψ_2
Imposed loads in buildings, category (see EN 1991-1-1 ¹)			
Category A: domestic, residential areas	0.7	0.5	0.3
Category B: office areas	0.7	0.5	0.3
Category C: congregation areas	0.7	0.7	0.6
Category D: shopping areas	0.7	0.7	0.6
Category E: storage areas	1.0	0.9	0.8
Category F: traffic area, vehicle weight ≤ 6744 lb. (30 kN)	0.7	0.7	0.6
Category G: traffic area, 6744 lb. (30 kN) \leq vehicle weight ≤ 35970 lb. (160 kN)	0.7	0.5	0.3
Category H: roofs	0.0	0.0	0.0
Snow loads on buildings (see EN 1991-1-3 ² *)			
Finland, Iceland, Norway, Sweden	0.7	0.5	0.2
Remainder of CEN Member States, for sites located at altitude $H > 3281$ ft. (1000 m) a.s.l.	0.7	0.5	0.2
Remainder of CEN Member States, for sites located at altitude $H \leq 3281$ ft. (1000 m) a.s.l.	0.5	0.2	0.0
Wind loads on buildings (see EN 1991-1-4 ³)	0.6	0.2	0.0
Temperature (non-fire) in buildings (see EN 1991-1-5 ⁴)	0.6	0.5	0.0

Notes: The ψ values may be set by the National annex.

* For countries other than Finland, Iceland, Norway and Sweden, see relevant local conditions.

¹ Eurocode 1, Part 1-1 (CEN, 2002b)² Eurocode 1, Part 1-3 (CEN, 2002c)³ Eurocode 1, Part 1-4 (CEN, 2002d)⁴ Eurocode 1, Part 1-5 (CEN, 2002e)

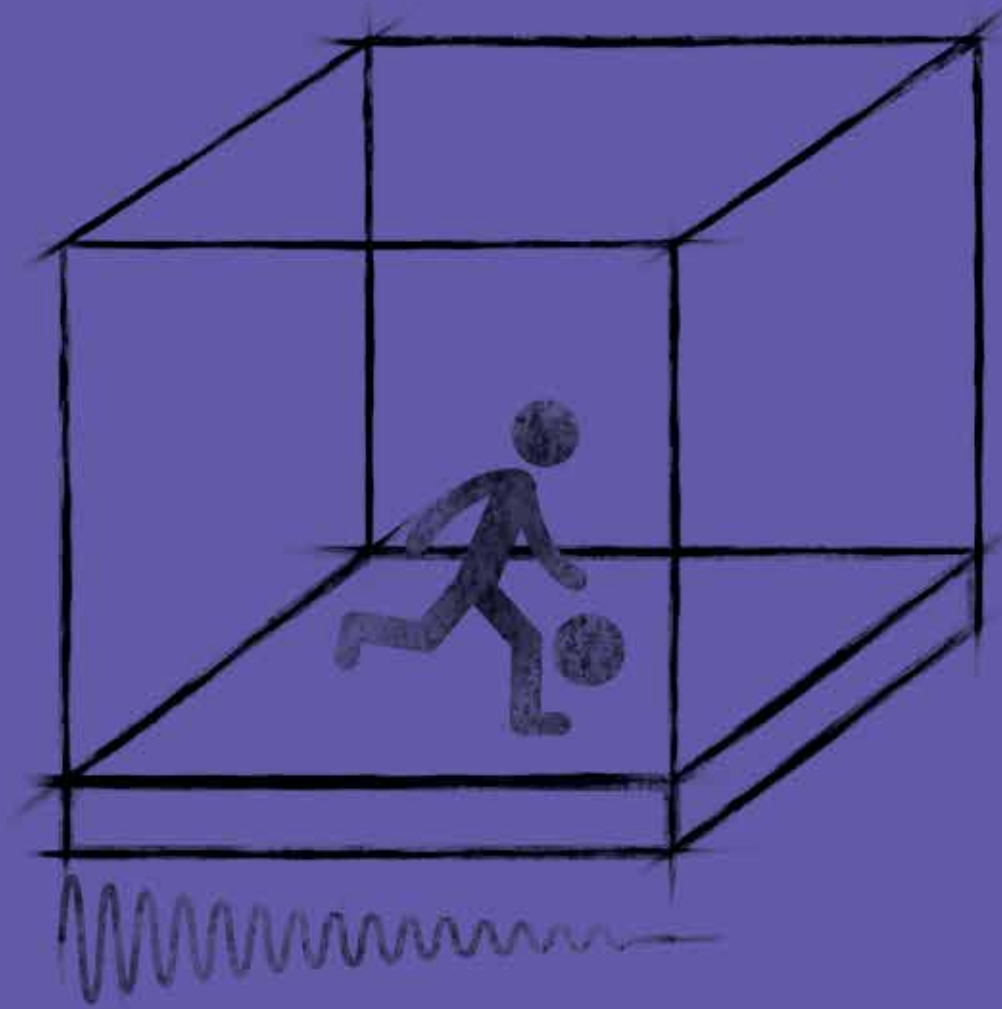

vibration

Vibration performance of
cross-laminated timber floors

CHAPTER 7

Authors

Lin Hu, Ph.D., FPIInnovations
Dr. Ying-Hei Chui, University of New Brunswick, Canada

Peer Reviewers

Bradford Douglas, P.E., American Wood Council
Borjen Yeh, Ph.D., P.E., APA
Dr.techn. Gerhard Schickhofer, Graz University of Technology, Austria

ACKNOWLEDGEMENTS

The U.S. Edition of the CLT Handbook: *cross-laminated timber* combines the work and knowledge of American, Canadian and European specialists. The handbook is based on the original Canadian Edition of the CLT Handbook: *cross-laminated timber*, that was developed using a series of reports initially prepared by FPInnovations and collaborators to support the introduction of CLT in the North American market. A multi-disciplinary team revised, updated and implemented their know-how and technologies to adapt this document to U.S. standards.

The publication of this handbook was made possible with the special collaboration of the following partners:



The editing partners would also like to express their special thanks to Binational Softwood Lumber Council, Forestry Innovation Investment (FII), Nordic Engineered Wood, Structurlam, and CLT Canada for their financial contribution to studies in support of the introduction of cross-laminated timber products in the United States of America.



© 2013 FPInnovations and Binational Softwood Lumber Council. All rights reserved.

The U.S. Edition of the CLT Handbook: *cross-laminated timber* can be electronically downloaded without charge from the website www.masstimber.com. Additional information can be obtained by visiting the websites of FPInnovations, USFPL, American Wood Council (AWC), APA and U.S. WoodWorks. Hard copies can be obtained through AWC (www.awc.org).

No part of this published Work may be reproduced, published, or transmitted for commercial purposes, in any form or by any means, electronic, mechanical, photocopying, recording or otherwise, whether or not in translated form, without the prior written permission of FPInnovations and Binational Softwood Lumber Council.

The information contained in this Work represents current research results and technical information made available from many sources, including researchers, manufacturers, and design professionals. The information has been reviewed by professionals in wood design including professors, design engineers and architects, and wood product manufacturers. While every reasonable effort has been made to insure the accuracy of the information presented, and special effort has been made to assure that the information reflects the state-of-the-art, none of the above-mentioned parties make any warranty, expressed or implied, or assume any legal liability or responsibility for the use, application of, and/or reference to opinions, findings, conclusions, or recommendations included in this published work, nor assume any responsibility for the accuracy or completeness of the information or its fitness for any particular purpose.

This published Work is designed to provide accurate, authoritative information but is not intended to provide professional advice. It is the responsibility of users to exercise professional knowledge and judgment in the use of the information.

ABSTRACT

Cross-laminated timber (CLT) is proving to be a promising solution for wood to compete in building sectors where steel and concrete have traditionally predominated. Studies at FPInnovations found that bare CLT floor systems differ from traditional lightweight wood joisted floors with typical mass around 4 lb./ft.² (20 kg/m²) and fundamental natural frequency above 15 Hz, and heavy concrete slab floors with a mass above 40 lb./ft.² (200 kg/m²) and fundamental natural frequency below 8 Hz. Based on FPInnovations' test results, bare CLT floors were found to have mass varying from approximately 6 lb./ft.² (30 kg/m²) to 30 lb./ft.² (150 kg/m²), and a fundamental natural frequency above 9 Hz. Due to these special properties, the existing standard vibration controlled design methods for lightweight and heavy floors may not be applicable for CLT floors.

Some CLT manufacturers have recommended that deflection under a uniformly distribution load (UDL) be used to control floor vibration problems. Using this approach, the success in avoiding excessive vibrations in CLT floors relies mostly on the designers' judgement. Besides, static deflection criteria can only be used as an indirect control method because designers ignore the influence of mass characteristics of the floors. Therefore, a new design methodology is needed to determine the vibration controlled spans for CLT floors.

SINTEF's extensive CLT floor vibration field study found that FPInnovations' proposed design method, which uses a 225 lb. (1 kN) static deflection and fundamental natural frequency as design parameters to control vibration in lightweight joisted wood floor systems, predicted field CLT floor vibration performance that matched well with occupants' expectations. The proposed design method for CLT floors is a modified version of the original FPInnovations design method for wood joisted floors. It was based on FPInnovations laboratory study and the understanding that limiting the combination of the longitudinal stiffness and mass of CLT floors can effectively control CLT floor vibrations. This led to a proposed equation to directly calculate the vibration controlled spans from CLT longitudinal stiffness and density. Verification using results from CLT floor testing conducted by FPInnovations that included subjective ratings of the floor vibration performance showed that the proposed design method predicted well the vibration performance of the tested CLT floors. An impact study showed that the vibration controlled spans of CLT floors predicted by the proposed design method were almost identical to those calculated by the *CLTdesigner* software that was developed by researchers of University of Gratz, in Austria. Working examples are given to demonstrate the procedure of using the proposed design method. This method can be used for bare CLT floors, continuous multi-span CLT floors and CLT floors with a ceiling and topping.

It is concluded that the proposed design methodology to determine vibration controlled spans of CLT floors is simple as it only uses the design properties of CLT panels, and is user-friendly and reliable.

Wide acceptance of the proposed design method relies on the use and evaluation of the method by products manufacturers and designers. Authors of this Chapter are open to feedbacks and ready to evolve the design method according to the needs of the manufacturers and designers.

TABLE OF CONTENTS

Acknowledgements	ii
Abstract	iii
List of Tables	vi
List of Figures	vi
1	Fundamentals of CLT Floor Vibrations Induced by Footsteps of Human Normal Walking 1
1.1	Understanding Footstep Force 1
1.2	Unique Features of CLT Floors – Special Dynamic Properties 2
1.2.1	Construction 3
1.2.2	Dead Load 4
1.2.3	Fundamental Natural Frequency 4
1.2.4	Damping 4
1.3	Features of CLT Floor Responses to Footstep Force 5
1.4	Factors Affecting Human Perception of CLT Floor Vibration 5
2	Review of the Existing Design Methods for CLT Floors 6
2.1	Uniformly Distributed Load (UDL) Deflection Method 6
2.2	Conventional Design Methods for Wood and Steel-Concrete Floors 6
2.3	FPInnovations’ Design Method for Joisted Wood Floors 7
3	Proposed Design Method for CLT Floors 9
3.1	Scope 9
3.2	Design Criterion 9
3.3	Equations for Calculating the Criterion Parameters 10
3.4	Simple Form of Design Method 10
3.5	Verification 10
3.6	Impact Study 12
3.6.1	Comparing Proposed Design Method with UDL Deflection Method 12
3.6.2	Comparing CLT Floor Spans Determined Using the Proposed Design Method with Spans Determined Using the CLTdesigner Software 13
3.7	Work Example for the Design Method 13

4	Approaches for Special Cases	15
4.1	Continuous Multi-span CLT Floors	15
4.2	CLT Floor with a Suspended Ceiling	15
4.3	CLT Floor with a Suspended Ceiling and a Lightweight Overlay	15
4.4	CLT Floor with a Heavy Topping	16
5	Conclusion	17
6	Recommendations	18
7	References	19

List of Tables

- Table 1* Summary of dynamic characteristics of bare CLT floors with satisfied vibration performance 5
- Table 2* Summary of floor design methods in codes proposed for wood and steel-concrete floors and their scope 7
- Table 3* Vibration controlled CLT floor spans determined using the proposed design method and equivalent UDL deflection criterion 12
- Table 4* Vibration controlled CLT floor spans determined using the new design method vs. spans determined using the CLTdesigner software 13
- Table 5* Excel calculation for the example 14

List of Figures

- Figure 1* Measured load-time histories of footsteps from a person walking normally 2
- Figure 2* Fourier transform spectrum of the load-time history of normal walking action by a person 2
- Figure 3* Cross-section of a bare CLT floor 3
- Figure 4* Conventional lightweight wood floor built with joists and subfloor 4
- Figure 5* Comparison of FPInnovations' design criterion for joisted wood floors with the vibration performance of field CLT floors studied at SINTEF 8
- Figure 6* CLT floor built in laboratory for the vibration tests and subjective evaluation 11
- Figure 7* Predicted CLT floor vibration performance by the proposed design method vs. subjective rating by participants 12

1

FUNDAMENTALS OF CLT FLOOR VIBRATIONS INDUCED BY FOOTSTEPS OF HUMAN NORMAL WALKING

1.1 Understanding Footstep Force

Significant efforts were made towards understanding the nature of footstep force of human normal walking (Rainer and Pernica, 1986; Ohlsson, 1991; Ebrahimpour *et al.*, 1994; Keer and Bishop, 2001). Based on these findings, it can be concluded that the footstep force generated by walking comprises two components, as described in Ohlsson (1991). One component is a short duration impact force induced by the heel of each footstep on the floor surface, as illustrated in Figure 1. The duration of the heel impact varies from about 30 ms to 100 ms, depending on the conditions and the materials of the two contact surfaces (that of the floor and the footwear of the walking person), and on the weight and gait of the person. The other component is the walking rate, a series of footsteps consisting of a wave train of harmonics, at multiples of about 2 Hz (Figure 2).

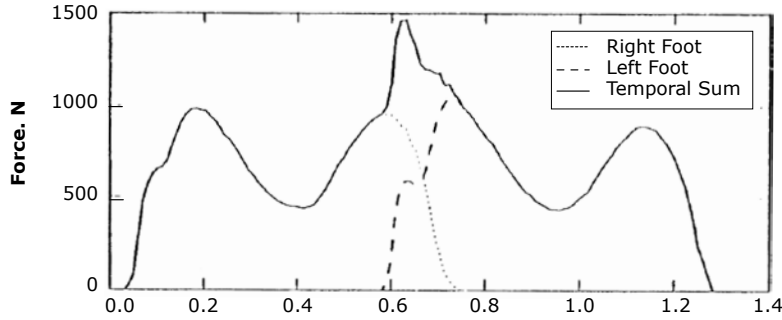

Figure 1
Measured load-time histories of footsteps from a person walking normally, by Ebrahimpour et al. (1994) (X-axis units is second)

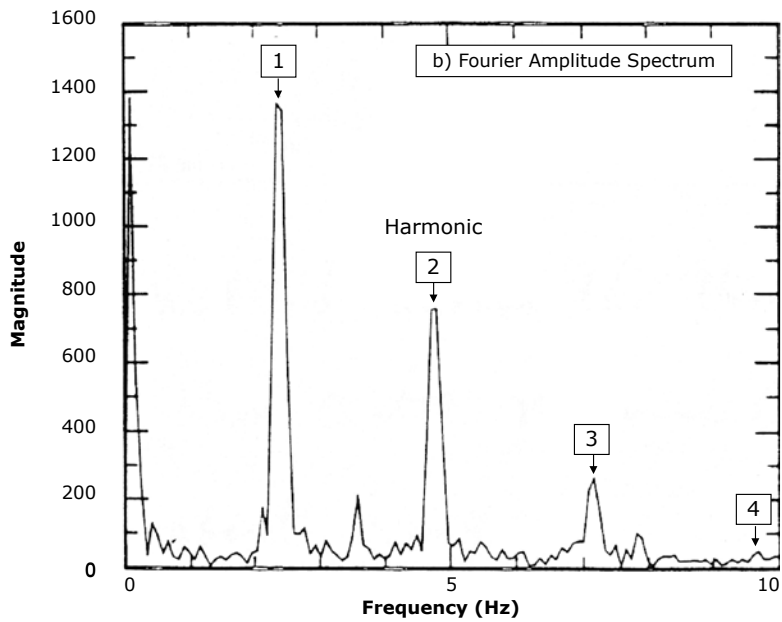

Figure 2
Fourier transform spectrum of the load-time history of normal walking action by a person, by Rainer and Pernica (1986) (Y-axis unit is Newton)

1.2 Unique Features of CLT Floors – Special Dynamic Properties

Figure 3 illustrates the cross-section of a bare CLT floor. Laboratory and field tests on CLT floors (Gagnon and Hu, 2007) have found that the vibration behavior of CLT floors is different from lightweight wood joisted floors and heavy concrete slab floors. Some explanations for such differences are given hereafter. Table 1 summarizes CLT floor dynamic properties.

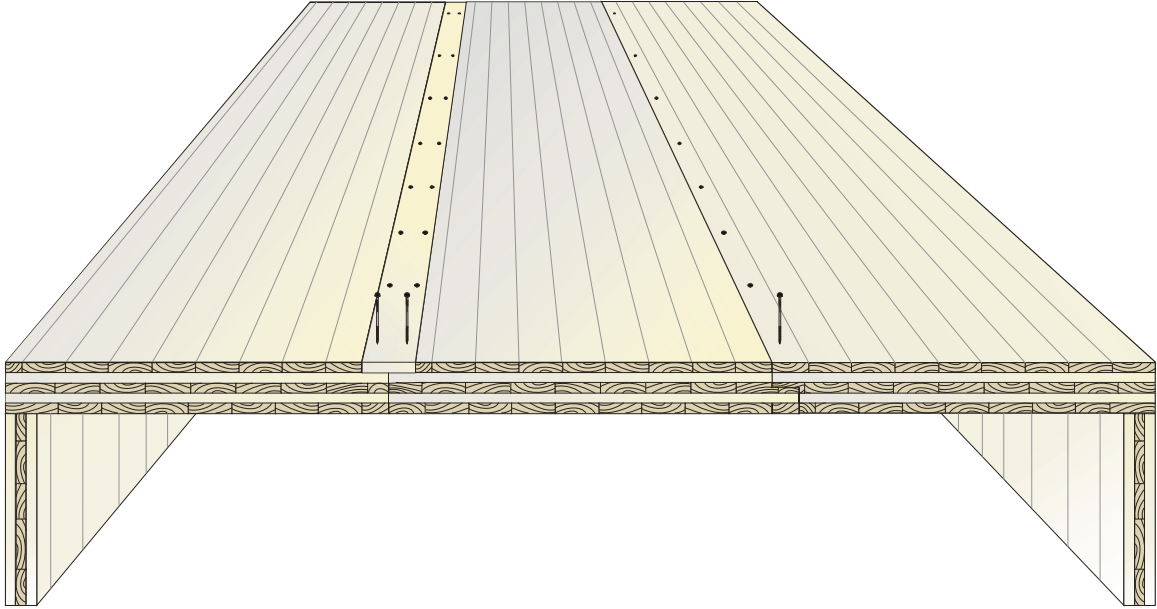

Figure 3
Cross-section of a bare CLT floor

1.2.1 Construction

Conventional lightweight wood joisted floors are usually built with joists spaced no more than 24 in. (600 mm) o.c. with a wood subfloor of 5/8 in. (15.5 mm) or 11/16 in. (18 mm) thick depending on the joist spacing (Figure 4). Conversely, CLT floors have no joists and are solid (Figure 3). The appearance of CLT plates is similar to concrete slabs.

Furthermore, in comparison with joisted floors having the same span and equivalent vibration performance, CLT floors are generally shallower than conventional lightweight joisted floors. For example, a 21 ft. (6.5 m) span floor can usually be built using 9 in. (230 mm) thick CLT panels. If the same floor is built using conventional wood joists, then at least 12 in. (300 mm) deep joists are needed.

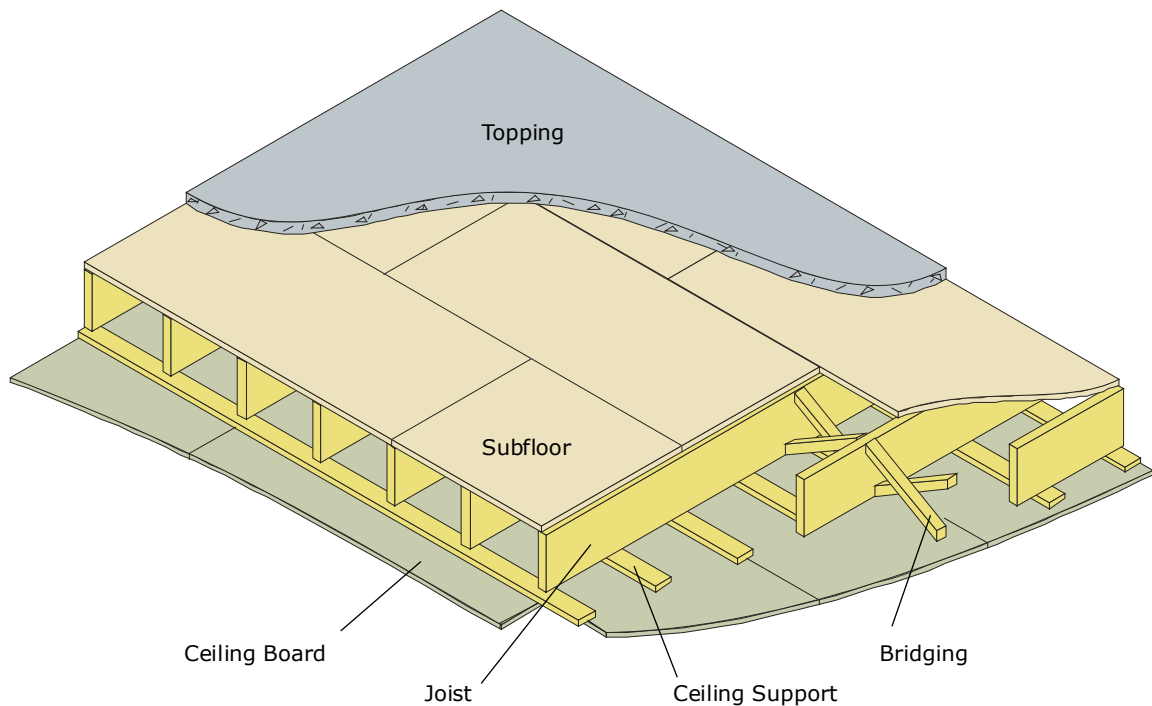

Figure 4
Conventional lightweight wood floor built with joists and subfloor

1.2.2 Dead Load

CLT floors are heavier than conventional joisted wood floors and lighter than concrete slab floors. Currently, thickness of CLT panels available on the market varies from about 2 3/8 in. (60 mm) to 12 5/8 in. (320 mm). For floor application, the minimum thickness will be about 4 in. (100 mm). Therefore, the area mass of CLT floors varies from about 10 lb./ft.² (50 kg/m²) to 30 lb./ft.² (150 kg/m²). Conventional wood joisted floor systems have an area mass of about 4 lb./ft.² (20 kg/m²) for bare floors and about 23 lb./ft.² (110 kg/m²) for bare floors with a 1 1/2 in. (38 mm) thick normal weight concrete topping. Concrete slab floors normally have an area mass above 40 lb./ft.² (200 kg/m²).

1.2.3 Fundamental Natural Frequency

Due to the specific mass to stiffness characteristic of CLT floors, their vibrations exhibit unique behavior indicated by the fundamental natural frequency. The lower bound of the measured fundamental natural frequencies for satisfactory bare CLT floors tested in our laboratory was found to be around 10 Hz (Hu, 2012).

We found that above 15 Hz is usually measured for satisfactory bare conventional wood joisted floors and above 10 Hz for satisfactory bare joisted floors with a concrete topping. The satisfactory concrete slab floors normally have a fundamental natural frequency below 8 Hz.

Humans are generally sensitive to vibration frequency within the range of 4 – 8 Hz. Therefore, the further away the natural frequencies of a floor from this sensitive range, the better the vibrational performance perceived by occupants.

1.2.4 Damping

The measured modal damping ratios of bare CLT floor specimens built with 5- or 7-layer CLT elements tested at FPInnovations were about 1% of the critical damping ratio (Hu, 2012). Conventional wood joisted floor systems

normally have damping ratios around 3%. Low damping results in the vibrations of CLT floors persisting longer and being more annoying to occupants than that in conventional lightweight wood joisted floors. The higher the damping, the easier it is to control vibrations. Damping is determined by the material and the construction details including structural and non-structural elements, supporting systems, etc. The detailed discussion on structural damping and its sources is provided by Ungar (1992).

Table 1

Summary of dynamic characteristics of bare CLT floors with satisfactory vibration performance

Damping	About 1%
Area Mass	About 10-30 lb./ft. ² (50-150 kg/m ²)
Fundamental Natural Frequency	> 9 Hz

1.3 Features of CLT Floor Responses to Footstep Force

The way a floor responds to footstep excitation depends on its inherent properties such as mass, stiffness, and capacity to absorb the excitation energy, i.e., damping of the floor system. Understanding the nature of the footstep force leads to the conclusion that the two components in the walking excitation can initiate two types of vibrations in a floor system, i.e., transient vibration or resonance, depending on the inherent properties of the floor.

If the fundamental natural frequency of a floor is above 8-10 Hz and far above the footstep frequency and its predominant harmonics, then the vibration induced by the footstep forces is most likely dominated by a transient response caused by the individual heel impact force from each footstep. The transient vibration disappears quickly, and occurs at the harmonics of the floor. The peak values of a transient vibration are mainly governed by the stiffness and mass of the system. On the other hand, if the floor fundamental natural frequency is below 8-10 Hz, and in the range of the footstep frequency and its predominant harmonics, then the floor will most likely resonate with one of the harmonics, and the resonance will be constantly maintained by the action of the walking excitation.

The fundamental natural frequency of a floor is governed by the stiffness and mass of the system. As previously discussed, the satisfactory bare CLT floors generally have fundamental natural frequency above 9 Hz. Therefore, in CLT floors, the footstep forces most likely cause transient vibrations which can be controlled by the stiffness and mass of the CLT floors. This understanding forms the basis for the development of the vibration controlled design method for CLT floors.

1.4 Factors Affecting Human Perception of CLT Floor Vibration

FPInnovations conducted subjective evaluations on series of CLT floors built with different types of joints between two adjacent CLT elements (Hu, 2012). It was found that the evaluators did not feel any difference in vibration responses when the types of joints were changed, and whether the joints were connected or not. The joint types and the joint connections also did not significantly affect the measured dynamic characteristics of the test floors. The longitudinal stiffness and mass of CLT floors were the two significant factors affecting human perception of CLT floor vibrations. This finding led to the conclusion that a simple design method to control CLT floor vibrations can be developed by using only the longitudinal stiffness and mass as the design parameters.

2

REVIEW OF THE EXISTING DESIGN METHODS FOR CLT FLOORS

2.1 Uniformly Distributed Load (UDL) Deflection Method

The uniformly distributed load (UDL) deflection method attempts to control vibrations by limiting the static deflection of a CLT floor under a uniform design load. For example, some CLT and indeed other engineered wood product (EWP) manufacturers recommend limiting the total UDL deflection to span/400. This approach assumes that the allowable deflection for controlling vibration is linearly proportional to the span of a floor. It means that the longer the span, the more deflection is allowed. This may explain why it was found in previous studies of light-framed floors that the UDL deflection method did not eliminate vibration problems in the long span category.

Therefore, if rationally using this method to avoid excessive vibrations in CLT floors, the engineer needs a good judgment to select a proper UDL deflection limit according to the floor spans. A standardized calculation procedure is then needed for CLT floor vibration controlled design so that all CLT floors can be economically designed with satisfactory in-service performance.

2.2 Conventional Design Methods for Wood and Steel-Concrete Floors

There are no floor vibration provisions in the U.S. codes. However, the 2005 National Building Code of Canada (NBCC) (NRC, 2005) recommends limits for static deflections of lightweight lumber joisted floors under 225 lb. (1 kN) static concentrated load at floor center. It was shown that this method is only applicable to wood joisted floors without topping, i.e., floors having an area mass less than 6 lb./ft.² (30 kg/m²) (Hu and Gagnon, 2009).

A design method was developed by Murray *et al.* (1997) for heavy steel joist-concrete slab floors having fundamental natural frequency below 9 Hz and is proposed in the Steel Design Guide (Murray *et al.*, 1997). This method limits the peak acceleration of a floor to control the vibrations of heavy floors.

Table 2 summarizes the scope of the two design methods. Also shown in Table 2 are the types of floor construction not currently covered or not covered adequately by existing design methods. As can be noted, the scope of the existing design methods in codes does not cover CLT floors.

Table 2

Summary of floor design methods in codes proposed for wood and steel-concrete floors and their scope

Design Method	2005 National Building Code of Canada (NRC 2005)	Currently not addressed in Codes	Murray <i>et al.</i> (1997) for Steel-Concrete
Floor Construction	Lightweight joisted floors without topping	1. Joisted floors with concrete topping 2. CLT	Steel joist-concrete slab
Floor Area Mass lb./ft. ² (kg/m ²)	3-6 (15-30)	6-30 (30-150)	> 30 (150)
Floor Natural Frequency Characteristics (Hz)	> 15	9-15	< 9

2.3 FPInnovations’ Design Method for Joisted Wood Floors

FPInnovations and the University of New Brunswick (UNB) in Canada developed a design method to control vibrations in a broad range of wood joisted floor systems with an area mass varying from 3 lb./ft.² (15 kg/m²) to 30 lb./ft.² (150 kg/m²) and for fundamental natural frequency above 9 Hz (Hu, 2007). The design method uses 225 lb. (1 kN) static deflection and fundamental natural frequency as design parameters so that the floor stiffness and mass are accounted for.

SINTEF (Homb, 2008), from Norway, has conducted extensive field and laboratory studies on the vibration performance of CLT floors. SINTEF found that the FPInnovations’ performance criterion, originally developed for lightweight wood joisted floors, predicted the vibration performance of CLT field floors that matched well the occupants’ expectation, as illustrated in Figure 5. Each symbol in the figure represents a CLT field floor. If the symbol is below the curve, it means that the CLT floor performance is acceptable according to the criterion. SINTEF’s field study has shown that the occupants were generally satisfied with the vibration performance of the floors tested.

SINTEF’s study confirmed that FPInnovations’ design criterion for joisted wood floors is applicable to CLT floors. However, the equations in FPInnovations’ design method were originally derived from conventional wood joisted floors (Chui, 2002) based on ribbed plate theory, not for non-joisted slab floors like CLT floors. New equations for calculation of the static deflection at mid-span under a concentrated load of 225 lb. (1 kN) and fundamental natural frequency of CLT floors needed to be developed. Meanwhile, the form of the criterion shown in Figure 5 also needed to be calibrated to the new equations to achieve a new design criterion for CLT floors. The next section provides details on the new proposed design method, including design criterion and calculation equations for CLT floors.

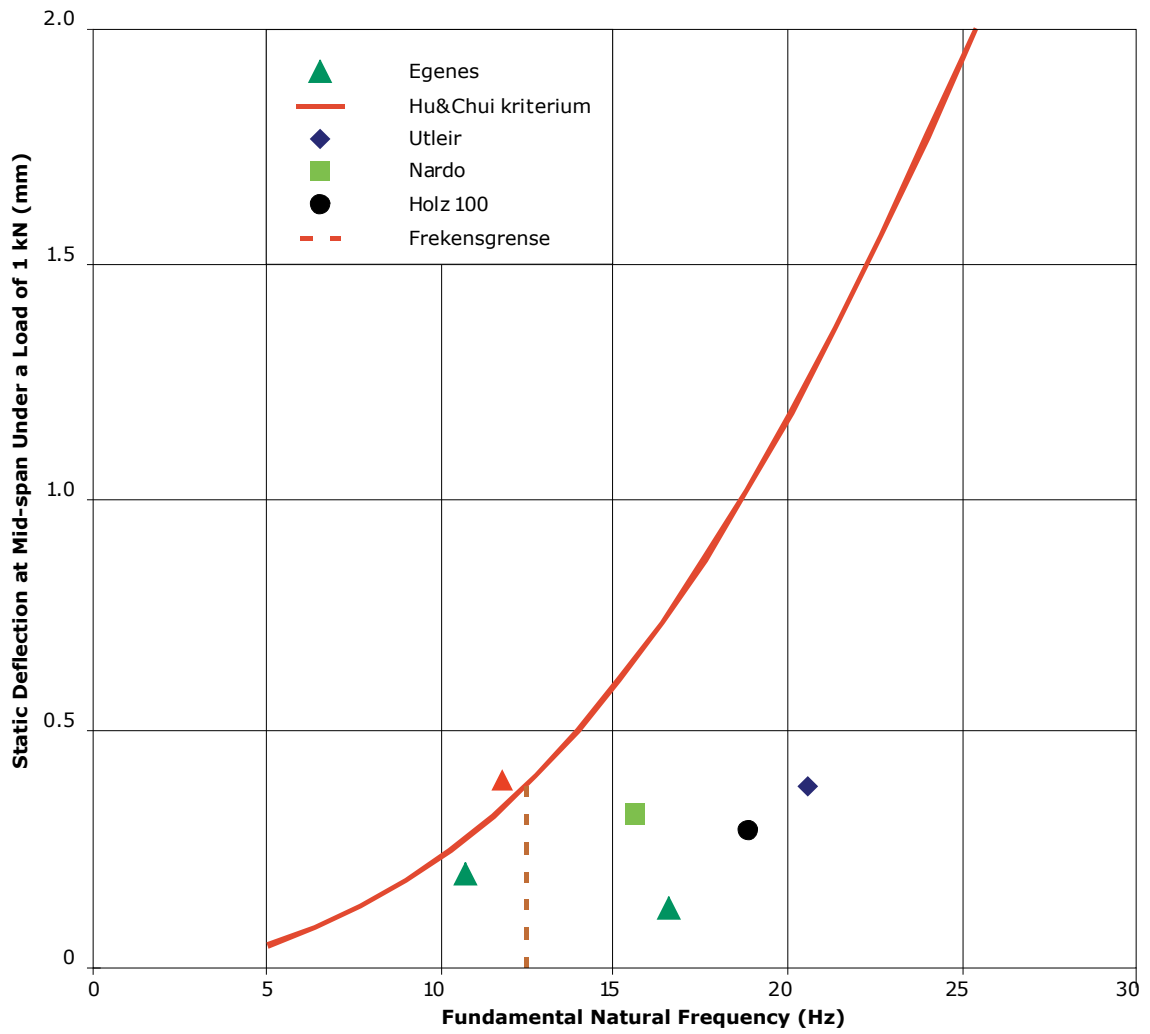

Figure 5

Comparison of FPInnovations' design criterion for joisted wood floors (Hu & Chui criterion) with the vibration performance of field CLT floors studied at SINTEF (Byggforsk, Norway) (Homb, 2008)

Note: The legend of each symbol was the test site name in Norway.

3

PROPOSED DESIGN METHOD FOR CLT FLOORS

3.1 Scope

At this point, the proposed new design method to control vibrations of CLT floors is applicable to the following situations:

1. Floors with or without topping and ceiling;
2. Simple or continuous multi-span system;
3. Vibrations induced by normal walking;
4. Well-supported floors;
5. Well-connected CLT panels.

The design method uses only the structure mass (dead load) in its calculation since FPInnovations' study found that the live load (such as occupants, furniture, etc.) enhances floor vibration performance to some degree; as live load changes from time to time, it should not be used as design parameters (Hu, 2007).

The proposed design method is user-friendly, with only hand calculations required. It is mechanics-based, requiring mechanical and physical properties of CLT panels, which are readily available from CLT manufacturers, as input properties.

3.2 Design Criterion

The design criterion is expressed in equation [1].

$$\frac{f}{d^{0.7}} \geq 125.1 \quad \text{or} \quad d \leq \frac{f^{1.43}}{993.3} \quad [1]$$

Where:

f = fundamental natural frequency calculated using equation [2] (Hz)

d = point load static deflection at middle span of a simple beam calculated using equation [3] (in.)

3.3 Equations for Calculating the Criterion Parameters

The fundamental natural frequency can be obtained as:

$$f = \frac{2.188}{2l^2} \sqrt{\frac{EI_{app}}{\rho A}} \quad [2]$$

Where:

- f = fundamental natural frequency of a 1ft. wide CLT panel simply supported at both ends (Hz)
- l = CLT floor span (ft.)
- EI_{app} = apparent stiffness in the span direction for a 1 ft. wide panel (lb.-in.²)
= apparent stiffness is the effective stiffness, EI_{eff} adjusted for the effects of shear deformation
- ρ = specific gravity of CLT (=1.0625 x oven-dry specific gravity of wood used for fabricating the CLT)
- A = cross sectional area of a 1 ft. wide CLT panel, i.e. thickness x 12 in. wide (in.²)

$$d = \frac{1728Pl^3}{48EI_{app}} \quad [3]$$

Where:

$$P = 68.56 \text{ lb.}$$

3.4 Simple Form of Design Method

Substituting equations [2] and [3] into equation [1], we obtain the simple form of the design method expressed by equation [4].

$$l \leq \frac{1}{12.05} \frac{(EI_{app})^{0.293}}{(\rho A)^{0.122}} \quad [4]$$

Using equation [4], we can determine the vibration controlled spans for CLT floors directly from the apparent stiffness in the span direction, density and cross-section area of 1 ft. wide CLT panels.

3.5 Verification

The design method was verified using FPInnovations' tests data (Hu, 2012) obtained from a limited laboratory study on floors built with 5- or 7-layer CLT panels having three thicknesses: 5 1/2 in. (140 mm), 7 3/16 in. (182 mm) and 9 in. (230 mm). In these tests, the performance of each floor was rated by a group of participants (subjective evaluation) using the rating scale and procedure originally developed at FPInnovations in the 1970's (Onysko and Bellosillo, 1978), evolved in the 1990's by Hu (1997), and recently simplified by Hu and Gagnon (2010). Figure 6 shows one CLT floor built in the laboratory for the vibration tests and subjective evaluation.

A point load of 225 lb. (1 kN) is assumed to be resisted by a 3.28 ft. (1 m) wide strip. That converts to 68.56 lb./ft. The static deflection and fundamental natural frequency of the loaded strip were calculated using equations [3] and [2] respectively. This allowed for the calculation of the performance parameter using equation [1].



Figure 6
CLT floor built in laboratory for the vibration tests and subjective evaluation

The comparison was also plotted on Figure 7. In the graph, each symbol represents a CLT floor while the curve is the design criterion defined by equation [1]. If the symbol is below the curve, it means the floor vibration performance is satisfactory and vice visa. The plot clearly demonstrates the reliability of the proposed design method for CLT floors.

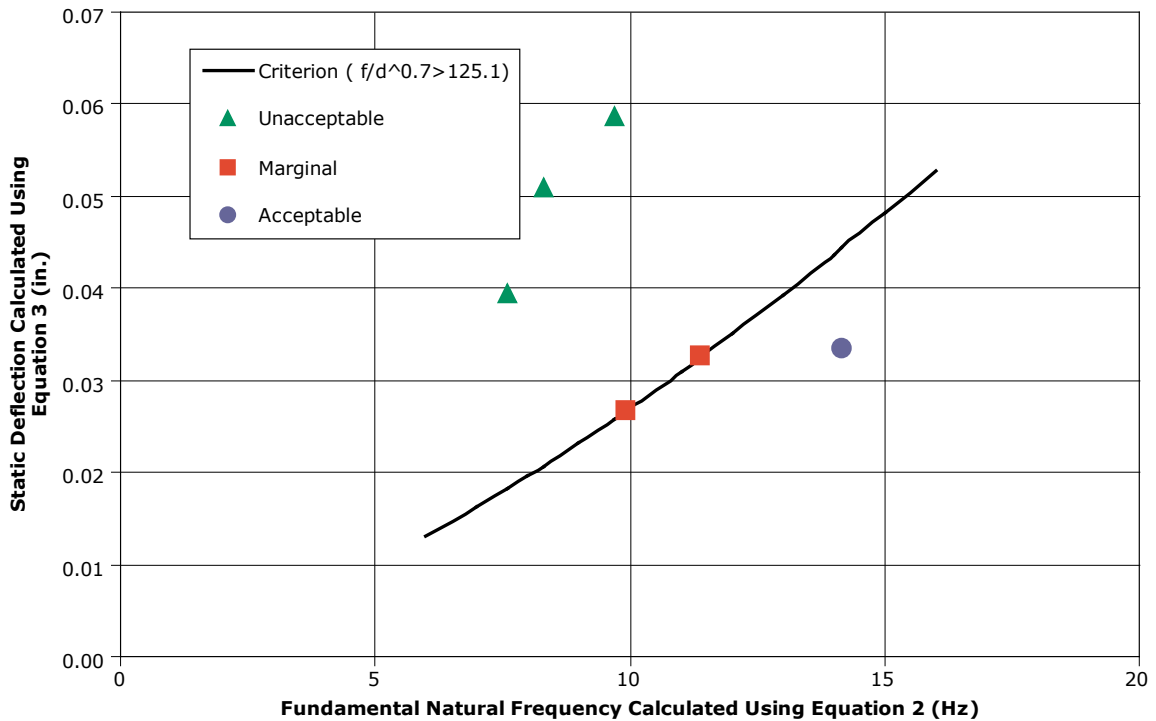

Figure 7
 Predicted CLT floor vibration performance by the proposed design method vs. subjective rating by participants

3.6 Impact Study

3.6.1 Comparing Proposed Design Method with UDL Deflection Method

The vibration controlled CLT floor spans determined using the proposed design method were used to derive the equivalent UDL deflection limits on products from KLH in Austria (2008) as an example. The total design load was 81.5 lb./ft.² (3.9 kN/m²), which consisted of 31.3 lb./ft.² (1.5 kN/m²) dead load and 50.2 lb./ft.² (2.4 kN/m²) live load. The UDL deflection limit would be span/400.

Table 3

Vibration controlled CLT floor spans determined using the proposed design method and equivalent UDL deflection criterion

Type of CLT	Thickness (in.)	Vibration Controlled Span, L (ft.)	Equivalent UDL Criterion
5-layer (5s)	5 1/2	15.6	Span/417
5-layer (5s)	7 3/16	18.0	Span/497
7-layer (7ss)	9	23.0	Span/606

Note:

5s stands for 5-layer CLT with single longitudinal layers on faces of panel (KLH, 2008)

7ss stands for 7-layer CLT with double longitudinal layers on faces of panel (KLH, 2008)

As shown in Table 3, according to the proposed design method, more stringent UDL deflection limits should be imposed for longer span floors. This is more rational than the traditional approach of adopting a fixed ratio, such as span/400, for all spans.

3.6.2 Comparing CLT Floor Spans Determined Using the Proposed Design Method with Spans Determined Using the CLTdesigner Software

The vibration controlled CLT floor spans determined using the proposed design method were compared with the spans determined using CLTdesigner (Holz.Bau Forschungs GmbH, 2010), a software developed at the Graz University of Technology, Austria (Schickhofer and Thiel, 2010). Table 4 provides the comparison.

Table 4

Vibration controlled CLT floor spans determined using the new design method vs. spans determined using the CLTdesigner software

CLT Thickness (in.)	FPInnovations' Design Method Proposed Span (ft.-in.)	CLTdesigner Proposed Span for 1% Damping and Floors without Topping (Schickhofer and Thiel, 2010) (ft.-in.)
3 15/16	11-9	11-7
4 3/4	12-4	12-4
5 3/4	14-9	14-6
6 5/16	15-9	15-7
7 1/8	16-11	16-10
7 7/8	18-7	18-7
8 11/16	19-1	19-4
9 7/16	20-0	20-3

As shown in Table 4, the vibration controlled spans of bare CLT floors predicted by the proposed design method are almost the same as the spans determined using the CLTdesigner software.

3.7 Work Example for the Design Method

Example is given below to calculate the vibration controlled spans of two CLT floors using the simple form of the proposed design method given in equation [4].

This example demonstrates the procedure to determine the vibration controlled spans for floors using CLT panels with the given EI_{eff} and GA_{eff} . The apparent bending stiffness EI_{app} can be determined using the following equation:

$$EI_{app} = \frac{1}{\frac{1}{EI_{eff}} + \frac{11.52}{GA_{eff} * (12 * l)^2}} \quad [5]$$

Design values of the CLT panel properties are provided by APA (PRG 320, 2011):

- Grade = E1
- Thickness = $6\frac{7}{8}$ in. (0.175 m)
- Specific gravity = 0.56 (560.66 kg/m³)
- $EI_{eff} = 440 \times 10^6$ lb.-in.²/ft. (4.140×10^6 N-m²/m)
- $GA_{eff} = 0.92 \times 10^6$ lb./ft. (1.343×10^7 N/m)
- l = vibration controlled span (ft.)

Calculation of the vibration controlled span for the above floor follows the steps below.

Step 1: Calculate the first trial span, assuming that the trial span is 30 times the thickness; this leads to the first trial span of 17.188 ft. (5.25 m).

Step 2: Insert the first trial span of 17.188 ft. (5.25 m) into equation [5] to determine the trial apparent stiffness, EI_{app} , from the design value of the EI_{eff} and GA_{eff} ; this leads to the new span of 17.100 ft.:

$$EI_{app} = 3.895 \times 10^8 \text{ lb.-in.}^2/\text{ft.}$$

Step 3: Insert the value of trial EI_{app} , the design values of density, thickness and 1 ft. width of the CLT panel into equation [4] to calculate the vibration controlled span; this leads to the new span of 17.100 ft.

Step 4: If the calculated new span in step 3 differs from the previous span, then repeat steps 2 and 3 using the calculated span in step 3 as the new trial span until the solution converges. The iterative calculation procedure can be implemented into an Excel spreadsheet, as shown in Table 5.

Table 5

Excel calculation for the example

Thickness (in.)	Trial Span (ft.)	EI_{eff} ($\times 10^6$ lb.- in. ² /ft.)	GA_{eff} ($\times 10^6$ lb./ft.)	EI_{app} Equation [5] ($\times 10^6$ lb.- in. ² /ft.)	Specific Gravity	New Span Equation [4] (ft.)
6.875	17.188	440	0.92	389.5	0.56	17.10
6.875	17.100	440	0.92	389.1	0.56	17.09
6.875	17.090	440	0.92	389.0	0.56	17.09

Finally, examining the iteration results shown in Table 5, we found that the solution converges to a span of 17.09 ft., which is the vibration controlled span for the CLT floor built with the $6\frac{7}{8}$ in. thick panels.

4

APPROACHES FOR SPECIAL CASES

4.1 Continuous Multi-span CLT Floors

FPIinnovations and University of New Brunswick studies found that, in comparison with the single span floors, the continuous multi-span floors are stiffer, which is indicated by the reduced 225 lb. (1 kN) static deflection. But the increase in stiffness of the floor is not very significant (Hu, 2007). Therefore, we have recommended that, for continuous multi-span CLT floors, the design equation [4] be used for estimating the vibration controlled CLT floor, assuming that the floor is a single span system with its span equal to the longest span in the actual multi-span system. Due to the significant flank transmission through the continuous multi-span floor systems, it is recommended to avoid using the continuous multi-span CLT floor system over two adjacent units in multi-family dwellings.

4.2 CLT Floor with a Suspended Ceiling

FPIinnovations' laboratory study found that adding a suspended ceiling to a CLT floor increased the damping ratio to 2-3%, and the mass of the CLT floor (Hu, 2012). The overall level of the vibration performance was not negatively affected according to the evaluators. Therefore, equation [4] can be used for CLT floors with suspended ceiling based on the bare floor properties.

4.3 CLT Floor with a Suspended Ceiling and a Lightweight Overlay

FPIinnovations' laboratory study also found that adding a suspended ceiling and a lightweight overlay such as wood panels onto a CLT floor increased the damping ratio to 2-3%, as well as stiffness and the mass of the CLT floor (Hu, 2012). The overall level of the vibration performance was not changed according to the evaluators. Therefore, equation [4] can be used for CLT floors with both a suspended ceiling and a lightweight overlay based on the bare floor properties.

4.4 CLT Floor with a Heavy Topping [$>20 \text{ lb./ft.}^2$ (100 kg/m^2)]

It is known that without a suspended ceiling, a heavy topping is normally necessary for CLT floor to achieve the satisfactory airborne and impact sound insulation. The heavy topping adds significant mass to the floor system, and reduces the fundamental natural frequency to below 9 Hz. Based on the experience of the authors, even though the topping increases the floor stiffness, the low first natural frequency makes the floor susceptible to annoying vibrations (Hu, 2007). For lightweight wood-joisted floor systems, the design method requires to reduce the spans of the joisted floors after a heavy cementitious topping is added (Hu, 2007). A similar approach should be applied to CLT floors with a heavy topping. As an interim measure, it is recommended that the span be calculated using equation [4] for vibration controlled design of such heavy topping CLT floor system, assuming the bare CLT floor mass and stiffness be reduced by 10%. This interim recommendation will be further refined through laboratory study.

5

CONCLUSION

It is concluded that the proposed design method to determine vibration controlled spans of CLT floors is mechanics-based, utilizes the fundamental mechanical properties of CLT, and is user-friendly and reliable.

Special Thanks

The authors wish to thank KLH for providing CLT panels for this study and the guidance on CLT floor construction. Thanks are also extended to Mr. Thomas Orskaug of KLH Solid Wood Scandinavia AB and Dr. Anders Homb of SINTEF Byggforsk for sharing their experience on massive wood slab non-joisted floor systems with us and for providing the opportunity to visit CLT buildings in Norway. Finally, the authors wish to thank Dr. Gerhard Schickhofer of Graz University of Technology, Institute of Timber Engineering and Wood Technology, Austria, for conducting the comparison of the vibration controlled spans estimated using the method developed by FPInnovations with the vibration controlled spans estimated with the CLTdesigner software developed by Holz.Bau Forschungs GmbH, Graz, and Mr. Loren Ross, of American Wood Council, for converting the units of the original equations into imperial units.

6

RECOMMENDATIONS

Wide acceptance of the proposed design method relies on its use and evaluation by product designers and manufacturers. Authors of this Chapter welcome feedback on the proposed design method. From a vibration control point of view, the perceived low damping ratio can be one of the major weaknesses of bare CLT floors. Any measures for increasing the damping ratio through CLT product design and floor construction detail will enhance the vibration performance of CLT floor systems.

7

REFERENCES

- APA – The Engineered Wood Association. 2011. *Standard for performance-rated cross-laminated timber*. ANSI/APA PRG 320. Tacoma, WA: APA. 23 p.
- Chui, Y.H. 2002. Application of ribbed-plate theory to predict vibrational serviceability of timber floor systems. In *Proceedings of the 7th World Conference on Timber Engineering*, August 12-15, 2002, Shah Alam, Malaysia, paper No. 9.3.1, vol. 4, 87-93.
- Ebrahimpour, A., R.L. Sack, W.N. Patten, and A. Hamam. 1994. Experimental measurements of dynamic loads imposed by moving crowds. In *Proceedings of Structures Congress XII*, April 1994, Atlanta, vol. 1, 1385-1390.
- Gagnon, S. and C. Pirvu, eds. 2011. *CLT Handbook : Cross-laminated timber*. Canadian ed. Special Publication SP-528E. Québec, QC: FPInnovations. 1 v.
- Gagnon, S., and L.J. Hu, 2007. Trip report: Sweden, Norway and France, November 1-11, 2007. Québec: FPInnovations. 22 p.
- Holz.Bau Forschungs GmbH. 2010. CLTdesigner. Version 1.1.2. <http://www.cltdesigner.at> (accessed July 1st, 2010)
- Homb, A. 2008. *Vibrasjonsegenskaper til dekker av massivtre* (in Norwegian). Prosjektrapport 24. Oslo, Norway: SINTEF Byggeforsk. 57 p.
- Hu, L.J. 1997. Serviceability design criteria for commercial and multi-family floors. Canadian Forest Service Report No. 4. Québec: Forintek Canada Corp. 9 p.
- _____. 2007. Design guide for wood-framed floor systems. Canadian Forest Service Report No. 32. Québec: FPInnovations. 60 p. + appendices.
- _____. 2012. Serviceability of next generation wood buildings: Laboratory study of vibration performance of cross-laminated-timber (CLT) floors. Internal report of project 301006159. Québec: FPInnovations. In progress.
- Hu, L.J., and S. Gagnon. 2009. Verification of 2005 NBCC maximum spans for concrete topped lumber joist floors. Canadian Forest Service Report No. 2. Québec: FPInnovations. 20 p.
- _____. 2010. Construction solutions for wood-based floors in hybrid building systems. Canadian Forest Service Report No. 1. Québec: FPInnovations. 5 p.

Kerr, S.C., and N.W.M. Bishop. 2001. Human induced loadings on flexible staircases. *Engineering Structures*, 23:34-45.

KLH. 2008. Engineering. Version 01/2008. www.klh.cc (accessed July 23, 2009).

Murray, T.M., D.E. Allen, and E.E. Ungar. 1997. *Floor vibrations due to human activity*. Steel Design Guide Series 11. Chicago: American Institute of Steel Construction and Canadian Institute of Steel Construction. 69 p.

National Research Council (NRC). 2005. *National building code of Canada, 2005*. Ottawa: Canada. National Research Council. 2 v.

Ohlsson, S.V. 1991. Serviceability criteria - especially floor vibration criteria. In *Proceedings of 1991 International Timber Engineering Conference*, September 1991, London, UK, vol. 1, 1.58-1.65.

Onysko, D., and S.B. Bellosillo. 1978. *Performance criteria for residential floors: Final report to Central Mortgage and Housing Corporation*. Grant No. 120-74. Ottawa: Canada. Eastern Forest Products Laboratory. 16 p.

Rainer, L.H., and G. Pernica. 1986. *Vertical dynamic forces from footsteps*. Report No. 25879. Ottawa: Canada. National Research Council. 21 p.

Schickhofer, G., and A. Thiel. 2010. Comments on FPInnovations new design method for CLT floor vibration control. E-mail message to author, July 1st, 2010.

Ungar, E.E. 1992. Structural damping. In *Noise and vibration control engineering: Principles and applications*, edited by Leo L. Beranek and Istvan L. Vér, 451-481. New York: John Wiley and Sons.

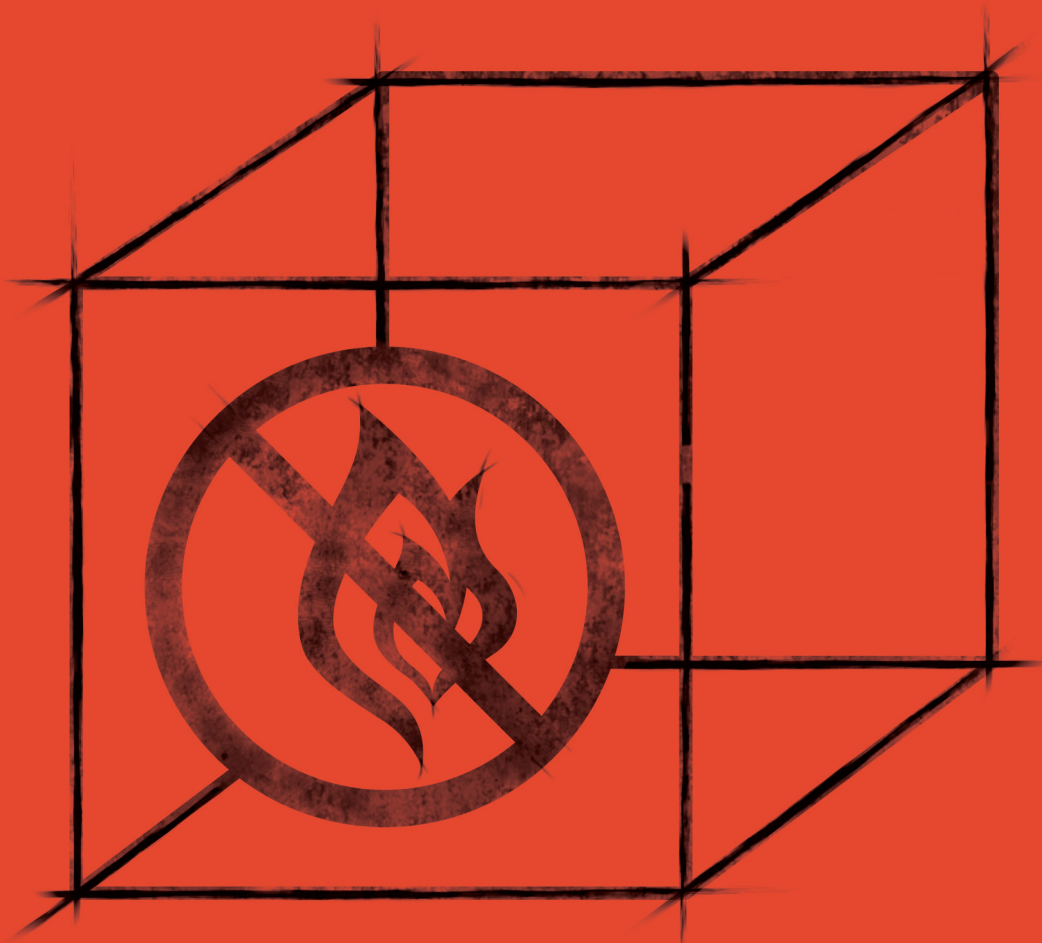

Fire

Fire performance of
cross-laminated timber assemblies

CHAPTER 8

Authors

Christian Dagenais, Eng., M.Sc., FPInnovations
Robert H. White, Ph.D., USDA Forest Products Laboratory
Kuma Sumathipala, Ph.D., P.Eng., American Wood Council

Peer Reviewers

Sam Francis, M.En.Sc., American Wood Council
James Churchill, P.E., M.Sc. Civil Engineering, Umass Amherst
Joe McElvaney, City of Phoenix
Prof. Dr. Andrea Frangi, ETH Zurich, Institute of Structural Engineering, Switzerland

ACKNOWLEDGEMENTS

The U.S. Edition of the CLT Handbook: *cross-laminated timber* combines the work and knowledge of American, Canadian and European specialists. The handbook is based on the original Canadian Edition of the CLT Handbook: *cross-laminated timber*, that was developed using a series of reports initially prepared by FPInnovations and collaborators to support the introduction of CLT in the North American market. A multi-disciplinary team revised, updated and implemented their know-how and technologies to adapt this document to U.S. standards.

The publication of this handbook was made possible with the special collaboration of the following partners:



The editing partners would also like to express their special thanks to Binational Softwood Lumber Council, Forestry Innovation Investment (FII), Nordic Engineered Wood, Structurlam, and CLT Canada for their financial contribution to studies in support of the introduction of cross-laminated timber products in the United States of America.



© 2013 FPInnovations and Binational Softwood Lumber Council. All rights reserved.

The U.S. Edition of the CLT Handbook: *cross-laminated timber* can be electronically downloaded without charge from the website www.masstimber.com. Additional information can be obtained by visiting the websites of FPInnovations, USFPL, American Wood Council (AWC), APA and U.S. WoodWorks. Hard copies can be obtained through AWC (www.awc.org).

No part of this published Work may be reproduced, published, or transmitted for commercial purposes, in any form or by any means, electronic, mechanical, photocopying, recording or otherwise, whether or not in translated form, without the prior written permission of FPInnovations and Binational Softwood Lumber Council.

The information contained in this Work represents current research results and technical information made available from many sources, including researchers, manufacturers, and design professionals. The information has been reviewed by professionals in wood design including professors, design engineers and architects, and wood product manufacturers. While every reasonable effort has been made to insure the accuracy of the information presented, and special effort has been made to assure that the information reflects the state-of-the-art, none of the above-mentioned parties make any warranty, expressed or implied, or assume any legal liability or responsibility for the use, application of, and/or reference to opinions, findings, conclusions, or recommendations included in this published work, nor assume any responsibility for the accuracy or completeness of the information or its fitness for any particular purpose.

This published Work is designed to provide accurate, authoritative information but is not intended to provide professional advice. It is the responsibility of users to exercise professional knowledge and judgment in the use of the information.

ABSTRACT

Cross-laminated timber (CLT) is a promising wood-based structural component and has potential to provide cost-effective building solutions for residential, commercial and institutional buildings as well as large industrial facilities. Market acceptance of CLT requires that it meets the applicable building code requirements.

CLT elements are used in building systems in a similar manner to concrete slabs and solid wall elements, as well as to those from heavy timber construction, by avoiding concealed spaces due to the use of massive timber elements, thus reducing the risk of fire spread beyond its point of origin. Moreover, CLT construction typically uses CLT panels for floor and loadbearing walls, which allow fire-rated compartmentalization, again reducing the risk of fire spread beyond its point of origin.

Structural fire performance of CLT assemblies can be assessed by conducting fire-resistance tests in accordance with ASTM E119 standard test methods. A fire-resistance rating is defined as the period of time a building element, component or assembly maintains the ability to perform its separating function (i.e., confining a fire by preventing or retarding the passage of excessive heat, hot gases or flames), continues to perform a given loadbearing function, or both. When designing CLT buildings, it is necessary to determine the fire-resistance rating provided by the assembly to ensure its performance satisfies the building code fire safety requirements.

The proposed design procedure for determining the fire resistance of CLT assemblies has been suitably adapted to the current design methodology found in Chapter 16 of the National Design Specification (NDS) for Wood Construction applicable to large timber elements. The proposed mechanics-based method which uses a standard nominal charring rate ($\beta_n = 1.5$ in./hr), a non-linear stepped charring rate adjustment, a zero-strength layer multiplier of 1.2, and a standard variability adjustment in the design to ultimate adjustment factor predicts average fire-resistance times for CLT wall and floor assemblies that closely track actual fire-resistance times for tested assemblies. While further refinements of this method are possible, these comparisons suggest that standardized adjustments to design stresses, a standardized stepped charring rate, and the use of the NDS behavioral equations adequately address fire-resistance design of CLT assemblies.

TABLE OF CONTENTS

Acknowledgements	ii			
Abstract	iii			
List of Figures	vi			
List of Tables	vi			
1	Introduction	1		
2	Fire Safety in Buildings	2		
	2.1	Objectives	2	
	2.2	Fire Performance Attributes of CLT	2	
	2.3	CLT and Fire Provisions of Building Codes	3	
3	Types of Construction and Occupancy Classification	4		
	3.1	Height and Area Limitations	4	
	3.2	Use of CLT in Type III Construction	5	
	3.3	Use of CLT in Type IV Construction	5	
	3.4	Use of CLT in Type V Construction	6	
	3.5	Types of CLT Fire-rated Walls	6	
4	Fire Resistance of CLT	7		
	4.1.1	Test Method – ASTM E119	9	
		4.1.1.1	Fire-resistance Requirements	11
	4.1.2	NDS Methodology for Wood Fire Design	11	
	4.1.3	Application of NDS Methodology to CLT	12	
		4.1.3.1	Charring Rate and Char Depth	12
		4.1.3.2	Effect of Adhesive Fire Performance on the Effective Char Depth	13
		4.1.3.3	Modified Effective Char Depth Calculation for CLT Assemblies	13
		4.1.3.4	Approximation of Member Strength and Capacity	15
		4.1.3.5	Structural Design of CLT Assemblies Exposed to Fire (Loadbearing Function)	15
	4.1.4	Fire Resistance of CLT Assemblies – Structural Requirement	16	
		4.1.4.1	Structural Fire Resistance	16
		4.1.4.2	Use of Protective Membranes to Increase Structural Fire Resistance	23

4.1.5	Fire Resistance of CLT Assemblies – Integrity Requirement	23
4.1.5.1	Effect of Joints on Integrity of CLT Walls and Floors	24
4.1.5.2	Use of Protective Membranes, Floor Coverings, and Interior Finish to Address Integrity	25
4.1.6	Fire Resistance of CLT Assemblies – Insulation Requirement	25
4.1.6.1	Theoretical Temperature Profiles for CLT Assemblies	25
4.1.6.2	Experimental Temperature Profile Data for CLT Assemblies	26
4.1.7	Comparison between Calculation Method and Experiments	28
4.1.8	Floor Design Example	31
4.1.8.1	Calculation of the Loadbearing Function after 90 Minutes of Standard Fire Exposure	31
4.1.8.2	Calculation of the Separating Function after 90 Minutes of Standard Fire Exposure	33
4.1.9	Wall Design Example	34
4.1.9.1	Calculation of the Loadbearing Function after 60 Minutes of Standard Fire Exposure	34
4.1.9.2	Calculation of the Separating Function after 60 Minutes of Standard Fire Exposure	37
5	Connections	38
6	Interior Finish	40
6.1	Flame Spread Index	40
6.1.1	Test Method – ASTM E84	40
6.1.2	Flame Spread Index (A, B and C Classes)	40
6.1.3	Areas of Likely Class A and Class B Requirements	41
6.1.4	Available Data for CLT and Other Wood Products	41
6.2	Fire-retardant Treatment and CLT	43
6.3	Use of Other Membrane Products to Address Interior Finish Requirements	44
6.4	Foam Plastic Insulation	44
6.5	Automatic Fire Sprinklers	44
7	Through Penetrations	45
7.1	Fire Stops through Fire Separations	45
7.2	Fire-resistant Joint Systems in CLT Construction	45
8	Nomenclature	48
9	Special Thanks	50
10	References	51
Appendix I – Additional Information		55
European Calculation Design Procedure		55
Canadian Calculation Design Procedure		56

List of Figures

- Figure 1** Fire resistance criteria per ASTM E119 8
- Figure 2** CLT fire-resistance wall tests conducted at NRCC in Ottawa (Canada) 9
- Figure 3** CLT fire-resistance floor tests conducted at NRCC in Ottawa (Canada) 10
- Figure 4** Standard time-temperature curve from ASTM E119 10
- Figure 5** Char depth adjusted for CLT assemblies with 1^{3/8} in. (35 mm) laminates (Test 4 from [24]) 14
- Figure 6** Char depth adjusted for CLT assemblies with 0.83" (21 mm) laminates (Test 8 from [24]) 15
- Figure 7** Nomenclature used in calculating fire resistance of a CLT exposed to fire from below 17
- Figure 8** CLT wall assembly subjected to combined bending and axial compression 22
- Figure 9** CLT panel-to-panel half-lapped joint detail 24
- Figure 10** Experimental temperature profiles from [24] and Equation 21 27
- Figure 11** Comparison between experiments and calculation methodology 30
- Figure 12** Examples of connections seen in CLT platform construction 39
- Figure 13** Examples of connections seen in CLT balloon construction 39
- Figure 14** Concealed metal plates 39
- Figure 15** Through and partial penetration in CLT assemblies 46-47

List of Tables

- Table 1** Example of basic height and area per floor limitations from Table 503 of the IBC 4
- Table 2** Example of height and total floor area limitations when sprinklered in accordance with NFPA 13 and open perimeter access from all sides, as per IBC 5
- Table 3** Effective charring rates and char layer thicknesses per the NDS methodology 12
- Table 4** Adjustment factors for fire design in accordance with [14] 16
- Table 5** Average maximum temperature rises at unexposed surface 28
- Table 6** CLT assemblies configuration details 29
- Table 7** Comparison between experiments and calculation methodology 30
- Table 8** Flame spread classes according with IBC 41
- Table 9** Flame spread indices for softwood lumber 42

1

INTRODUCTION

Cross-laminated timber (CLT) is a promising wood-based structural component and has great potential to provide cost-effective building solutions for residential, commercial, and institutional buildings as well as large industrial facilities. Code acceptance of CLT construction necessitates compliance with fire-related provisions of the building codes. This Chapter addresses some of the common code-mandated fire performance requirements.

In the United States, compliance with the building codes is generally accomplished by construction in accordance with the *International Building Code* (IBC) [1] or NFPA 5000 [2]. The intent of the IBC and NFPA 5000 is to establish minimum requirements to public safety through, among other things, structural strength, means of egress, stability, life safety, and property protection from fire as well as to provide safety for firefighters and first responders during emergency operations. As such, fire safety issues such as providing adequate structural integrity in fire conditions, limiting fire impact to people and property, as well as limiting fire spread through a building and to adjacent properties are critical attributes that need to be provided by every building design and structural systems. In this Chapter, the various aspects of the IBC fire-related provisions are addressed. In most cases, there are similar provisions in NFPA 5000.

Classification of a building as to its “type of construction” as defined in the IBC and NFPA 5000 is one of the key elements in identifying the limitations on the height and allowable floor areas of a building. As a relatively new type of construction in the United States, the inclusion of prescriptive language in the IBC and NFPA 5000 on CLT construction is only now being addressed. The 2015 edition of the IBC and NFPA 5000 would reference the ANSI/APA PRG 320 *Standard for Performance-Rated Cross-Laminated Timber* [3] as well as prescriptively allow CLT to be used in Type IV “Heavy Timber” construction.

2

FIRE SAFETY IN BUILDINGS

The building codes have historically been published as a prescriptive code and the requirements set forth within the building codes have traditionally been recognized as deemed-to-satisfy the Code objectives.

In the IBC, fire safety provisions are based on the NFPA Fire Concepts Tree [4] where fire impact management and fire ignition prevention are the two main cornerstones. Fire ignition may be addressed by following the International Fire Code and NFPA 1 [5, 6] while managing the impact of a fire is addressed by the many provisions given in the IBC.

2.1 Objectives

The fire safety provisions set forth in the IBC and NFPA 5000 interrelate to four fundamental objectives, which are as follow:

1. Provide life safety for the public, building occupants and emergency responders;
2. Protect property from fire as well as exposure to and from fire in adjacent buildings;
3. Provide limitation of financial loss (from the building and contents);
4. Limit the environmental impact of the fire.

These objectives can be met by different strategies taking into consideration the type of structure, the building occupancy, height and area as well as the active and passive fire protection systems. Another important fire safety measure is to subdivide the building into fire-rated compartments. Such compartmentalization concepts limit fire spread beyond its point of origin by using boundary elements (e.g., walls, ceilings, floors, partitions, etc.) having a fire-resistance rating not less than the minimum ratings prescribed in the IBC or NFPA 5000.

2.2 Fire Performance Attributes of CLT

CLT panels provide excellent fire resistance. This is due to the inherent nature of thick timber members to char slowly at a predictable rate, allowing massive wood systems to maintain significant structural capacity for extended durations when exposed to fire.

Being made from wood planks, CLT can contribute to the growth of a compartment fire. As such, a negatively perceived impact from using CLT is the potential increase of the fixed fuel load [7]. Limited research has been conducted to evaluate the impact of additional fixed fuel load from CLT panels to the fire growth. Frangi et al. [8] evaluated a 3-story CTL building built with $3 \frac{3}{8}$ in. (85 mm) thick wall panels and $5 \frac{1}{2}$ in. (142 mm) thick floor slabs exposed to a natural full-scale fire. In this particular experiment, walls were protected with a $\frac{1}{2}$ in. (12.7 mm) fire-rated gypsum board (directly exposed to fire) as well as a $\frac{1}{2}$ in. (12.7 mm) standard gypsum board while the ceilings were protected with 1 in. (25.4 mm) mineral wool insulation and a $\frac{1}{2}$ in. (12.7 mm) fire-rated gypsum

board. In an attempt to replicate a similar fire severity, such as those encountered in typical residential dwellings, a design fire load of 69,600 Btu/ft.² (790 MJ/m²) was used and burned for a duration of slightly over 1 hour. It is reported that flashover occurred after about 40 minutes. The fire severity started to decline after 55 minutes and was extinguished, as planned, after an hour-long duration. Furthermore, the measured charred depth on the gypsum-protected CLT compartment elements were very low, ranging from approximately $\frac{3}{16}$ in. to $\frac{3}{8}$ in. (5 mm to 10 mm). No elevated temperatures were measured and no smoke was observed in the room above the fire room. From this full-scale design fire test, one can conclude that CLT buildings can be designed to limit fire spread beyond the point of origin, even when massive timber construction is used.

2.3 CLT and Fire Provisions of Building Codes

CLT elements are used in building systems in a similar manner to concrete slabs and solid wall elements as well as to those from heavy timber construction by limiting concealed spaces due to the use of massive timber elements, thus reducing the risk of concealed space fires.

Moreover, CLT construction typically uses CLT panels for floor and loadbearing walls, which allow fire-resistance-rated compartmentalization, thus again reducing the risk of fire spread beyond its point of origin (compartment of origin).

The various types of constructions defined within the IBC are discussed in detail in Section 3 of this Chapter, which will also highlight areas where CLT components may be used in compliance with the IBC.

3

TYPES OF CONSTRUCTION AND OCCUPANCY CLASSIFICATION

The five types of construction used to classify buildings in the codes, Types I to V, are described in Chapter 6 of the IBC. Use and Occupancy in buildings are classified into ten categories as described in Chapter 3 of the IBC. The “Type of Construction” and “Use and Occupancy Classification” together dictate the fire-resistance requirements of the building assemblies and the height and area limitations for code compliance. CLT construction can comply with provisions in Types of construction III, IV and V, as defined in Section 602 of the IBC. Type I and II construction require the major building elements to be built with noncombustible materials.

3.1 Height and Area Limitations

The provisions for height and areas limits are found in Chapter 5 of the IBC. The key elements in determining the limitations on height and area are the type of construction and the use and occupancy classification. These two elements are used with Table 503 of the IBC to determine basic limitations on height and area. A few examples from IBC Table 503 are reproduced in Table 1.

Table 1

Example of basic height and area per floor limitations from Table 503 of the IBC

Occupancy	Type of Construction				
	III-A	III-B	IV	V-A	V-B
Business	5 floors 28,500 ft. ²	3 floors 19,000 ft. ²	5 floors 36,000 ft. ²	3 floors 18,000 ft. ²	2 floors 9,000 ft. ²
Residential (R-1 and R-2) Hotel/Motel Apartment	4 floors 24,000 ft. ²	4 floors 16,000 ft. ²	4 floors 20,500 ft. ²	3 floors 12,000 ft. ²	2 floors 7,000 ft. ²

In addition to the number of stories limitation based on occupancy, each type of construction has a height limitation, in feet above grade plane, which is independent of the use and occupancy classification.

The area limitations are for areas within the exterior walls. Interior walls built as “fire walls” (Section 706 of the IBC) can be used to subdivide a larger building into smaller areas, each of which may be considered a separate building that is within the limitations of Table 503. The tabular area, determined by finding the Type of Construction for a specific Use Group in Table 503 is then subject to increases for either Open Perimeter, or sprinkling, or both. Equation 5-1 in Section 506 of the IBC is used to calculate the maximum allowable building area per floor.

The allowable height and area of a building can also be increased when installing automatic fire sprinklers and providing perimeter access for emergency response vehicles. With the allowable increases, it is convenient to present allowable area as a total for the building rather than per floor. The following Table 2 presents this information for including automatic fire sprinklers in accordance with NFPA 13 [9] and perimeter access from all sides of the building.

Table 2

Example of height and total floor area limitations when sprinklered in accordance with NFPA 13 and open perimeter access from all sides, as per IBC

Occupancy	Type of Construction				
	III-A	III-B	IV	V-A	V-B
Business	6 floors 320,625 ft. ²	4 floors 213,750 ft. ²	6 floors 405,000 ft. ²	4 floors 202,000 ft. ²	3 floors 101,250 ft. ²
Residential (R-1 and R-2) Hotel/Motel Apartment	5 floors 270,000 ft. ²	5 floors 180,000 ft. ²	5 floors 230,625 ft. ²	4 floors 135,000 ft. ²	3 floors 78,750 ft. ²

3.2 Use of CLT in Type III Construction

In Type III construction, interior building elements can be combustible materials while the exterior walls are required to be of noncombustible materials. Thus, there is a potential to use CLT for the interior elements in Type III construction. Type III construction is further divided into subclassifications A and B based on the fire-resistance requirements.

3.3 Use of CLT in Type IV Construction

Type IV construction is also known as “Heavy Timber” (HT) construction. The 2015 IBC will prescriptively allow the use of CLT in Type IV construction, including exterior walls, interior walls, floors and roofs. CLT will be permitted within exterior wall assemblies not less than 6 inches (152 mm) in thickness and with a two-hour fire-resistance rating or less. CLT in exterior wall assemblies must be protected by fire retardant treated wood (FRTW) sheathing of not less than ¹⁵/₃₂ in. (12 mm) thick, gypsum board not less than ½ in. (13 mm) thick, or a noncombustible material on the exterior side of the exterior wall.

Loadbearing interior walls of CLT construction shall have a one-hour fire-resistance rating. Interior partitions shall be of solid wood construction formed by not less than two layers of 1 in. (25 mm) matched boards or 4 in. (102 mm) thick laminated construction, or of 1-hour fire-resistance-rated construction.

In Type IV construction, floors can be constructed with sawn or glued-laminated planks of a minimum thickness of 3 in. nominal (76 mm), splined or tongue-and-groove, that are covered with one of several prescribed floor coverings. CLT used as HT floors shall be not less than 4 in. (102 mm) in thickness. It shall be continuous from support to support and mechanically fastened to one another. Floors shall be constructed without concealed spaces.

Roofs shall also be without concealed spaces and can be constructed with sawn or glued-laminated planks of a minimum thickness of 2 in. nominal (50 mm), splined or tongue-and-groove. CLT used as timber roofs shall be not less than 3 in. nominal (76 mm) in thickness and shall be continuous from support to support and mechanically fastened to one another.

3.4 Use of CLT in Type V Construction

Type V construction is defined as that type of construction in which the structural elements, exterior walls, and interior walls can be of any materials permitted by the code. The 2015 editions of the IBC and NFPA 5000 would reference ANSI/APA PRG 320. As such, CLT complying with this standard would be permitted for use in Type V-A and Type V-B constructions. The subclassifications A and B are based on the fire-resistance requirements.

3.5 Types of CLT Fire-rated Walls

In the IBC, the terms used to describe various types of walls have very specific meanings in terms of the required fire performance. The following definitions are taken from the IBC:

- Fire wall (Section 706) is “*a fire-resistance-rated wall having protected openings, which restricts the spread of fire and extends continuity from the foundation to or through the roof, with sufficient structural stability under fire conditions to allow collapse of construction on either side without collapse of the wall*”;
- Fire barrier (Section 707) is “*a fire resistance-rated wall assembly of materials designed to restrict the spread of fire in which continuity is maintained*”;
- Fire partition (Section 709 of IBC) is “*a vertical assembly of materials designed to restrict the spread of fire in which openings are protected*”; and
- Smoke barrier (Section 710) is “*a continuous membrane, either vertical or horizontal, such as a wall, floor or ceiling assembly that is designed and constructed to restrict the movement of smoke*”.

4

FIRE RESISTANCE OF CLT

Structural fire performance of building assemblies are assessed by conducting fire-resistance tests in accordance with ASTM E119 [10]. A fire-resistance rating is defined as the period of time a building element, component, or assembly maintains the ability to perform its separating function (i.e., confining a fire by preventing or retarding the passage of excessive heat, hot gases or flames), continues to perform a given loadbearing function, or both. More specifically, a standard fire-resistance test entails three failure/acceptance criteria (Figure 1):

1. **Structural resistance:** the assembly must support the applied load for the duration of the test (relates to the loadbearing function);
2. **Integrity:** the assembly must prevent the passage of flame or gases hot enough to ignite a cotton pad (relates to the separating function);
3. **Insulation:** the assembly must prevent the temperature rise on the unexposed surface from being greater than 325°F (180°C) at any location, or an average of 250°F (140°C) measured at a number of locations, above the initial temperature (relates to the separating function).

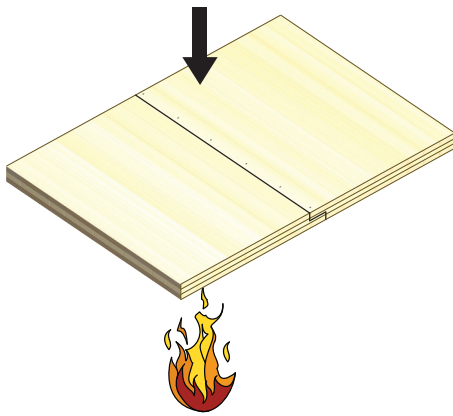

a) Structural resistance

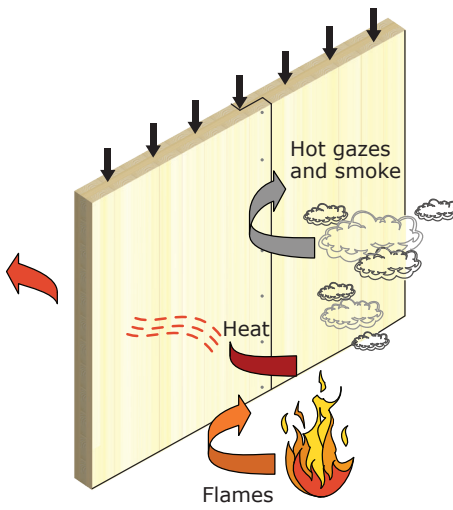

b) Integrity

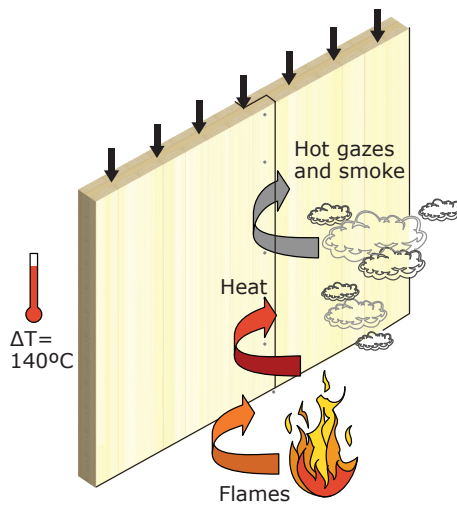

c) Insulation

Figure 1
Fire resistance criteria per ASTM E119

The time at which the assembly can no longer satisfy any one of these three criteria defines the assembly's fire resistance. Fire-resistance ratings are usually assigned in whole numbers of hours (e.g., 1 hour and 2 hours) or parts of hours (e.g., ½ hour or 30 min and ¾ hour or 45 min).

The requirements for the construction of fire-resistance-rated building elements are detailed in Chapter 7 of the IBC. These provisions include the details for addressing penetrations in rated building elements.

When designing CLT buildings, it is necessary to use products that comply with the required fire-resistance rating. In some instances, such as for some non-loadbearing partition wall assemblies, only the separating function is necessary in defining the fire resistance (e.g., the assembly must meet the insulation and integrity criteria only). In the case of loadbearing walls and all floor assemblies, the assembly must provide both the separating function as well as structural resistance not less than the duration of the fire-resistance rating required in the IBC. The determination of fire resistance of CLT assemblies has thereby been split into requirements for separating fire resistance and structural fire resistance in this Chapter.

The distinction of the portions of a CLT assembly needed for loadbearing and that needed for the separating fire protection function may provide opportunities for lower costs that have also been raised with respect to log structures. The full width of the CLT wall may not be needed to maintain the structural integrity of the wall during a fire. Thus, there is a potential to allow portions of the walls to be of different thicknesses. The entire wall would need to be thick enough to maintain the integrity and thermal criteria of the fire-resistance test, but only portions of the wall would need to be of the greater thickness for the structural criteria, if needed.

4.1.1 Test Method – ASTM E119

The fire-resistance rating of a building assembly is assessed by subjecting a specimen of the assembly to a standard fire-resistance test such as ASTM E119 or UL 263 [11] in the United States, as required by Section 703.2 of the IBC. Comparable standard tests such as ULC S101 [12] in Canada and ISO 834 [13] in some other countries are used in those countries. These three standards (ASTM E119, ULC S101 and ISO 834) have many similarities. They require a wall (Figure 2) or floor (Figure 3) assembly to be exposed to a post-flashover fire specified by a time-temperature curve (Figure 4).



a) Unprotected CLT before test b) Unexposed surface during test c) Protected CLT after test

Figure 2
CLT fire-resistance wall tests conducted at NRCC in Ottawa (Canada)



a) Unprotected CLT before test b) Unexposed surface during test c) Protected CLT after test

Figure 3

CLT fire-resistance floor tests conducted at NRCC in Ottawa (Canada)

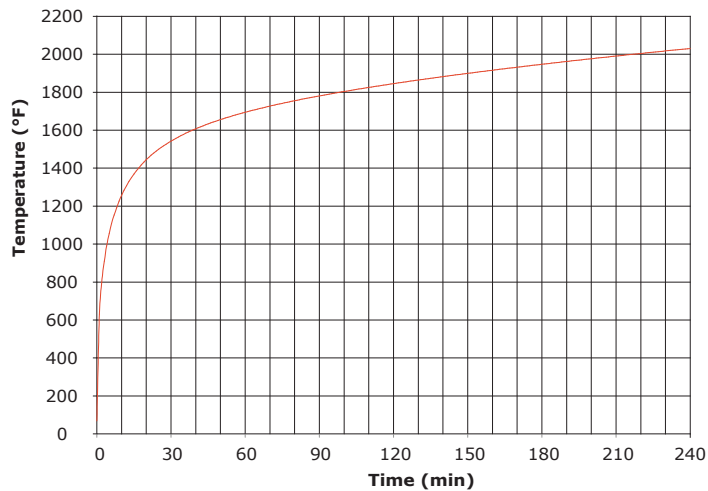

Figure 4

Standard time-temperature curve from ASTM E119

For loadbearing assemblies, the test standard requires the assembly to be loaded during fire exposure. It also requires the superimposed load to be the maximum load condition allowed under nationally recognized structural design criteria, such as those for allowable stress design in the *National Design Specification (NDS) for Wood Construction* [14], unless limited design criteria are specified and a corresponding reduced load is applied. A test conducted under the maximum load ensures that the fire-resistance rating obtained is appropriate for use in any equal or lesser loading conditions (assuming they satisfy the loadbearing requirements). Additional information regarding the loading conditions during a standard fire-resistance test of wood components can be found in ASTM D6513 and D7746 standards [15, 16].

However, it is rare that CLT structures will be structurally loaded anywhere near their ultimate capacity and quite often may be carrying loads below 20% of their design capacity due to serviceability limits (deflection or vibration). In addition, most test facilities do not have the capacity to load CLT assemblies to maximum loading conditions. As such, a rational fire-resistance calculation methodology, based on first principles such as charring rate, reduced effective cross-section, and load ratio, is more suitable to ensure an efficient and economical CLT building design.

4.1.1.1 Fire-resistance Requirements

The fire-resistance requirements stipulated in the IBC depend on the structural element, type of construction, use and occupancy classifications, distance from property line and other factors such as the special detailing requirements based on use and occupancy (Chapter 4 of IBC). The general requirements can be found in Table 601 of the IBC. For each type of building element, the table specifies the required fire-resistance rating depending on the type of construction. For example, exterior bearing walls must have a 1-hour rating in Type V-A construction and a 2-hour rating in Type IV construction. In Type V-B, the building elements are not required to have any fire resistance rating. As listed in Table 602 of the IBC, the fire-resistance ratings for the exterior walls are also a function of the fire separations distance from the adjacent property or building. For example, all buildings of occupancy group H (High-hazard) with a fire separation distance of less than 5 feet are required to have exterior walls with a 3-hour fire-resistance rating. There are also specific fire-resistance requirements for some specific circumstances, e.g., an exterior wall adjacent to exterior exit stairways (Section 1026.6) and exterior walls on each side of the intersection of fire wall (Section 706.5.1 of the IBC). In some limited situations, the installation of a NFPA 13 [9] automatic fire sprinkler system can be an alternative to a 1-hour fire-resistance requirement.

In addition, as stipulated in Section 705.5 of the IBC, when the fire separation distance is ten feet or less, the fire-resistance rating of an exterior wall must be determined from both sides, or symmetrically determined. When the fire separation distance is greater than ten feet, the fire resistance may be determined from the interior side only.

4.1.2 NDS Methodology for Wood Fire Design

The NDS methodology for determining the fire resistance of timber elements is a mechanics-based design method [17] based on ASD calculation procedures and is referenced in Section 721.1 of the IBC for exposed wood members and wood decking. It calculates the capacity of exposed wood members using basic wood engineering mechanics and has been incorporated in the 2001 and later editions of the NDS for fire-resistance calculations of up to 2 hours, limited by the test data available at the time.

The actual mechanical and physical properties of the wood are used and the capacity of the member is directly calculated for a given period of time. The section properties are computed assuming an effective charring rate (β_{eff}) at a given time (t) of fire exposure. Reductions of strength and stiffness of wood directly adjacent to the char layer are addressed by a zero-strength layer (d_o) that is 20% of the char depth. For a char depth of 1.5 in. (38 mm) at 60 minutes, the 20% corresponds to a zero-strength layer (d_o) of 0.3 in. (7.6 mm). The member strength properties are adjusted to the average strength value (i.e., mean or 50th percentile) based on existing accepted statistical procedures such as ASTM D2915 [18], used to evaluate allowable properties for structural lumber.

Finally, the wood members are designed using accepted engineering procedures found in the NDS and the failure occurs when the load applied on the member exceeds the member capacity which has been reduced due to fire exposure.

In order to estimate the reduced cross-sectional dimensions, the location of the char base must be determined as a function of time on the basis of empirical charring rate data. The char layer can be assumed to have zero strength and stiffness.

4.1.3 Application of NDS Methodology to CLT

4.1.3.1 Charring Rate and Char Depth

According to the NDS procedure, the effective charring rate and effective char depth can be estimated from published nominal 1-hour charring rate data using Equations 1 and 2.

$$\beta_{eff} = \frac{1.2\beta_n}{t^{0.187}} \quad [1]$$

$$a_{char} = \beta_{eff}t = 1.2\beta_n t^{0.813} \quad [2]$$

where β_{eff} is the effective charring rate (in./hr) adjusted for exposure time (t), β_n is the nominal linear charring rate (in./hr) based on a 1-hour exposure, t is the exposure time (hr) and a_{char} is the effective char depth (in.). According to Equation 1, the charring rate has a non-linear form [19] and therefore varies as a function of time. The 1.2 factor is the inclusion of the zero-strength layer within the effective charring rate β_{eff} . The charring rate that corresponds to visual observations of char depth is $\beta_n/t^{0.187}$. In addition to visual observation, the $\beta_n/t^{0.187}$ corresponds to char depths based on a 550°F (300°C) temperature criteria commonly used to measure the char depths over the duration of a fire test.

A nominal charring rate (β_n) of 1.5 in./hr (0.635 mm/min) is commonly assumed for solid-sawn and glue-laminated softwood members. For a nominal charring rate (β_n) of 1.5 in./hr, the effective charring rates (β_{eff}) and effective char layer thicknesses (a_{char}) for each exposed surface are shown in Table 3. Also shown in Table 3 are the corresponding visual char layer and zero-strength layer that make up the effective char layer thickness. The NDS limits the application of the methodology to ratings not exceeding 2 hours. Additional data is needed to validate the models for long periods. Deviations between the NDS model and a linear charring rate model used in other countries, which includes a fixed zero-strength layer, are more pronounced at durations exceeding 2 hours.

Table 3

Effective charring rates and char layer thicknesses per the NDS methodology

Required Fire Resistance	Effective Charring Rate, β_{eff} (in./hr)	Visual Char Layer Thickness (in.)	Zero-strength Layer (in.)	Effective Char Layer Thickness, a_{char} (in.)
45 min (¾-h)	1.90	1.19	0.24	1.42
60 min (1-h)	1.80	1.50	0.30	1.80
90 min (1½-h)	1.67	2.09	0.42	2.50
120 min (2-h)	1.58	2.64	0.53	3.16

4.1.3.2 Effect of Adhesive Fire Performance on the Effective Char Depth

ANSI/APA PRG 320 Standard for Performance-Rated Cross-Laminated Timber requires that, when for use in the United States, adhesive used in the manufacturing of CLT shall meet the requirements of AITC 405 [20] with the exception that Section 2.1.6 of AITC 405 (either ASTM D3434 [21] or CSA O112.9 [22]) is not required. Also, adhesives used shall be evaluated for heat performance in accordance with Section 6.1.3.4 of DOC PS1 [23]. Note 7 of ANSI/APA PRG 320 states “*The intent of the heat performance evaluation is to determine whether an adhesive has exhibited heat delamination characteristics, which may increase the char rate of the CLT when exposed to fire in certain applications. If heat delamination occurs, the CLT manufacturer is recommended to consult with the adhesive manufacturer and the approved agency to develop an appropriate adjustment in product manufacturing and/or an end-use recommendation.*”

The CLT panels used for developing the fire-resistance calculation methodology were manufactured with a structural polyurethane (PUR) adhesive conforming to ANSI/APA PRG 320 standard for use in both United States and Canada. During the full-scale fire research on CLT [24], small pieces of the charred layers have been observed to fall off when the temperature at the CLT lamination interface (glue line) approached 550°F (300°C), indicating an adhesive failure. Analysis of the data indicated an acceleration of the charring rate subsequent to the failure of a laminate. Loss of the char layer when the char front reaches the glue line effectively resets the nonlinear charring rate used in the NDS methodology, resulting in an accelerated charring rate.

Such delamination effect was also observed in experiments carried by Frangi et al. [7] on one-component polyurethane structural adhesive, where it actually increased the charring rate of the CLT when exposed to fire. It should be noted however that, in Europe, structural adhesives must comply with performance requirements given in EN 301 [25] and EN 15425 [26]. The highest temperature in the tests according to these European standards is 158°F (70°C), being held over two weeks under constant loading of the bonded specimens. Therefore, the current European standards provide little or no information nor do they give a classification for adhesives at elevated temperature, appropriate for fire resistance design [7]. Such temperature exposure is also much lower than the temperature of the base charred layer, generally taken as 550°F (300°C) [27]. The question of the integrity of a laminate that has charred therefore involves performance at temperatures of 550°F (300°C) and higher.

Thus, the char depth model shown in Equation 2, used in the fire-resistance calculations, needs to be modified to address the potential delamination of CLT laminates. Extensive testing with a variety of products made with phenol-resorcinol-formaldehyde adhesive has shown that charring does not result in delamination when this adhesive is used. The delamination in the series of tests performed in Canada using an adhesive in compliance with ANSI/APA PRG 320 indicates that the ASTM D7247 [28] test may not be severe enough to address glue lines in the char layer (550°F or 300°C). Additional fire testing of CLT manufactured with PUR adhesive is warranted.

4.1.3.3 Modified Effective Char Depth Calculation for CLT Assemblies

The modified char depth model for CLT products made of adhesives that might delaminate when the char depth reaches the glue line is a simple step-wise approach that resets the time in the charring rate equation (Equation 1 without the 1.2 factor) to zero whenever the calculated char depth reaches the glue line of adjacent laminates. In the Canadian tests, this modification of the NDS charring rate model resulted in calculated char depths consistent with the char depths indicated by thermocouples recording temperatures of 300°C along the boards interface (i.e., glue lines), a widely used criterion for the base of the char layer (Figures 5 and 6 show the charring rates from tests conducted with 1.375 in. (35 mm) and 0.83 in. (21 mm) laminates). It can be seen from these two figures that the charring rate for CLT is influenced by the thickness of the layers whereas thinner layers heat up more rapidly than thicker layers, resulting in a faster time for a glue line to reach its critical failure temperature, which may lead to fall-off of the laminates. It can also be observed that the stepped model provides an average linear charring rate of 1.56 in./hr (0.66 mm/min) and 1.74 in./hr (0.74 mm/min) for laminates with thickness of 1.375 in. and 0.83 in., respectively.

Once the char depth is calculated using the step-wise approach, the 1.2 factor is applied for determining the effective char layer into the structural fire-resistance calculations. For example, assuming a CLT manufactured with 1 3/8 in. (35 mm) thick lumber boards required to have a 1-hour fire resistance, the lamination char fall-off would occur at 54 min (e.g., $[1\frac{3}{8} \text{ in.} \div (1\frac{1}{2} \text{ in./hr})]^{1.23} = 0.90 \text{ hr} = 54 \text{ min}$). The remaining 6 minutes provide a char depth of 0.23 in. (e.g., $[(1\frac{1}{2} \text{ in./hr}) \times (6/60 \text{ hr})^{0.813}] = 0.23 \text{ in.}$), for a total char depth of 1.61 in. The effective char depth for structural fire resistance is then 1.93 in., which is a 7% increase when compared to the 1.8 in. effective char depth obtained from the NDS nonlinear model shown in Equation 2, which does not consider potential delamination.

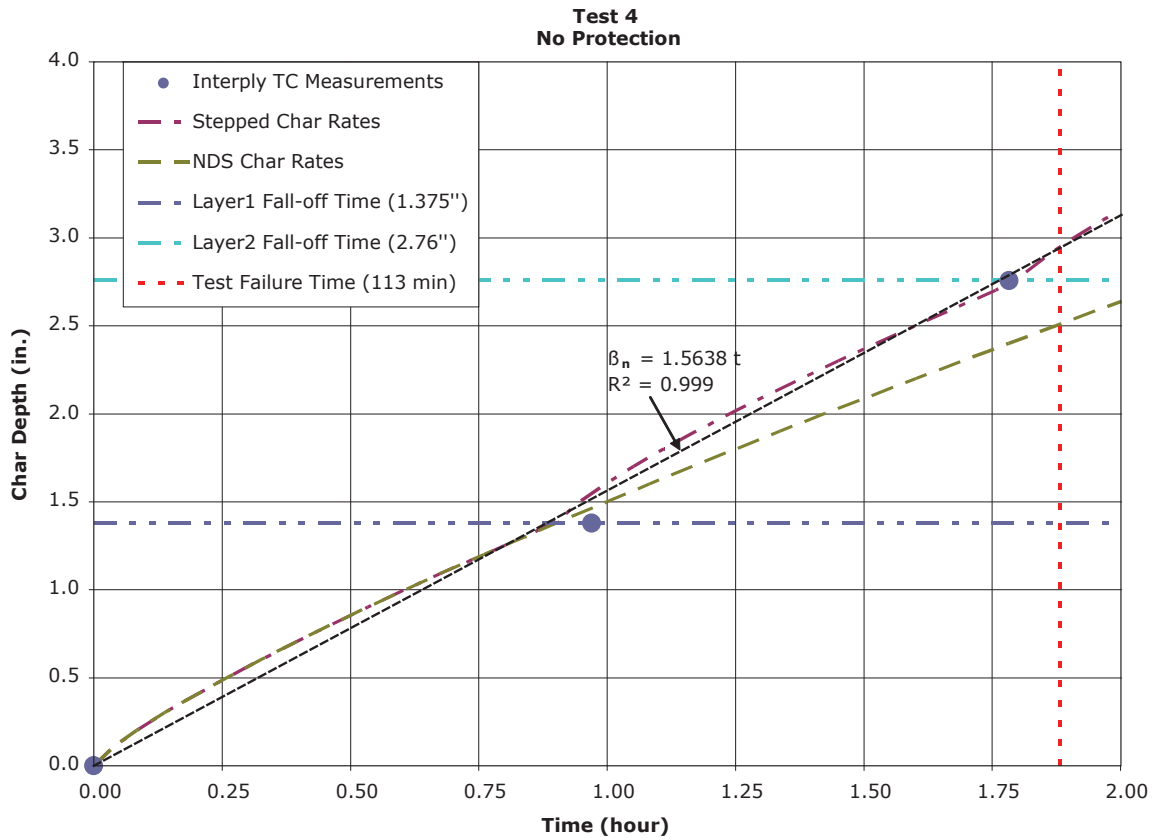

Figure 5
Char depth adjusted for CLT assemblies with 1 3/8 in. (35 mm) laminates (Test 4 from [24])

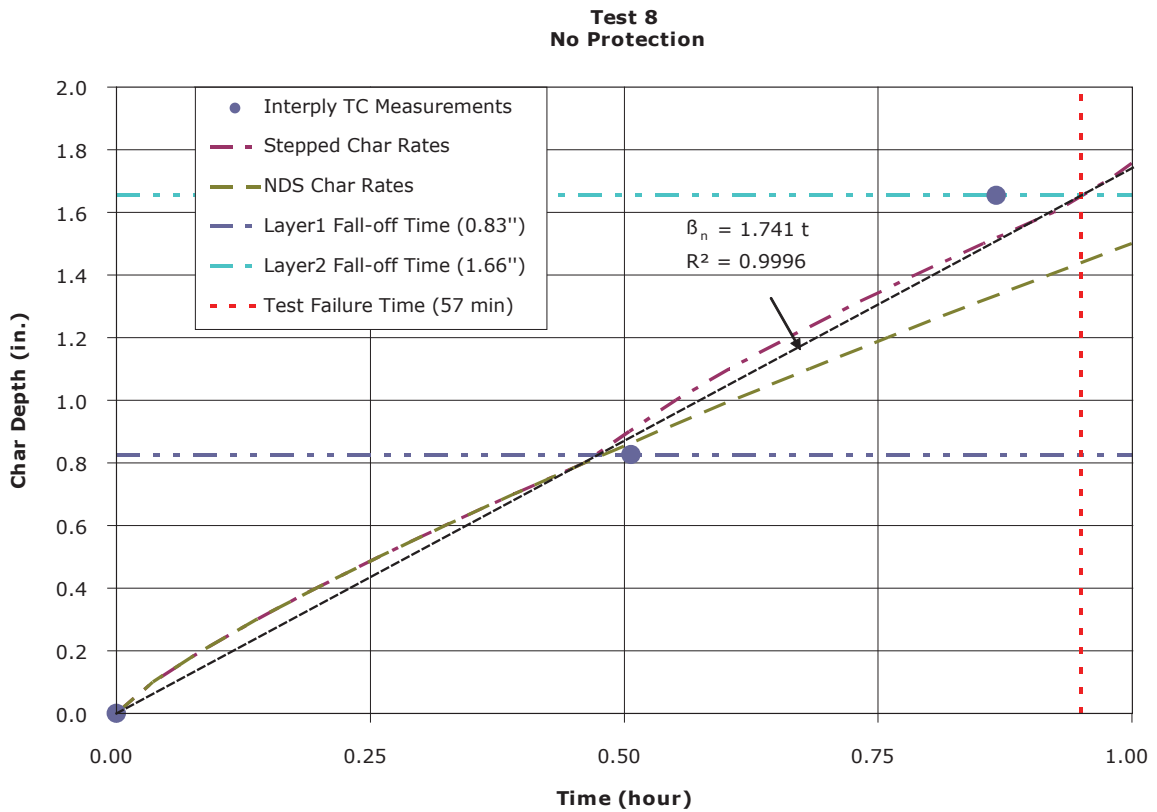

Figure 6
Char depth adjusted for CLT assemblies with 0.83" (21 mm) laminates (Test 8 from [24])

It is anticipated that CLT assemblies manufactured with adhesives that do not exhibit delamination at temperatures below the char front (i.e., that would char at a similar rate as a solid wood) may follow the standard NDS procedure for calculating the effective char depth, as per Equations 1 and 2, without the stepped charring rate adjustment.

4.1.3.4 Approximation of Member Strength and Capacity

As defined in ANSI/APA PRG 320, cross-laminated timber (CLT) is a prefabricated solid engineered wood product made from at least three (3) orthogonally bonded layers of finger jointed solid-sawn visually-graded or mechanically-graded lumber or structural composite lumber (SCL). As CLT is made of bonded layers similarly to glue-laminated timber, it is expected that the coefficient of variation for CLT is at least equal to or greater than clear wood; therefore, the strength adjustment factors (K) prescribed in [17] may be used. For CLT assemblies, the average strength can be approximated by multiplying design values (F_b , F_t , F_c , F_{bE} and F_{cE}) by the adjustment factors set forth in Table 16.2.2 of the NDS, which are summarized in Table 4.

Table 4

Adjustment factors for fire design in accordance with [14]

Strength	Strength Adjustment Factor (K)	Size Factor ⁽¹⁾	Volume Factor ⁽¹⁾	Flat Use Factor ⁽¹⁾	Beam Stability Factor ⁽²⁾	Column Stability Factor ⁽²⁾
Bending (F_b)	2.85	C_F	C_V	C_{fu}	C_L	-
Tensile (F_t)	2.85	C_F	-	-	-	-
Axial Compression (F_c)	2.58	C_F	-	-	-	C_P
Beam Buckling (F_{bE})	2.03	-	-	-	-	-
Column Buckling (F_{cE})	2.03	-	-	-	-	-

⁽¹⁾ Factor shall be determined using initial cross-section dimensions

⁽²⁾ Factor shall be determined using reduced cross-section dimensions

All member strength and cross-sectional properties should be adjusted prior to the interaction calculations. The interaction calculations should then be conducted in accordance with appropriate NDS provisions.

4.1.3.5 Structural Design of CLT Assemblies Exposed to Fire (Loadbearing Function)

Once the CLT assembly capacity has been determined using the effective section properties from Subsection 4.1.3.1 and the member strength approximations from Subsection 4.1.3.4 of this Chapter, the CLT assembly can be designed using accepted NDS design procedures for the loading condition shown in Equation 3.

$$L + D \leq KR_{ASD} \quad [3]$$

where $L+D$ are the load effect due to the sum of the live and dead loads and where KR_{ASD} is the nominal allowable design capacity adjusted to average ultimate capacity.

4.1.4 Fire Resistance of CLT Assemblies – Structural Requirement

The procedure set forth in ASTM E119 is applicable to floor and roof assemblies with or without attached, furred, or suspended ceilings and requires application of fire exposure to the underside of the specimen under test. When evaluating wall assemblies, the specimen is exposed to fire from one side only. This structural requirement is essential in limiting the risk of structural failure or collapse of physical elements due to the effects of a fire.

4.1.4.1 Structural Fire Resistance

This calculation procedure applies only to CLT panel assemblies exposed to the ASTM E119 standard fire-resistance test exposure.

Calculation of the structural fire-resistance failure time of CLT floor or wall assemblies is outlined in the five steps described hereafter. The time at which the CLT assembly can no longer support the applied load defines its structural fire resistance (t_{struc}).

Figure 7 shows a CLT panel exposed to fire and some of the nomenclature used in calculating its fire resistance. Note that the classical laminates wood composite theory, as described by Bödig & Jayne [29], is the most suitable method for fire design as the cross-section reduces as function of time and then becomes asymmetrical (e.g., unbalanced lay-up). Cross plies are not taken into account in the calculation of the design resistive moment for floors nor the resisting wall compression capacity (i.e., $E_{90} = G_0 = G_{90} = 0$). Also, calculations are typically made for a unit width of CLT panel, typically 1 foot.

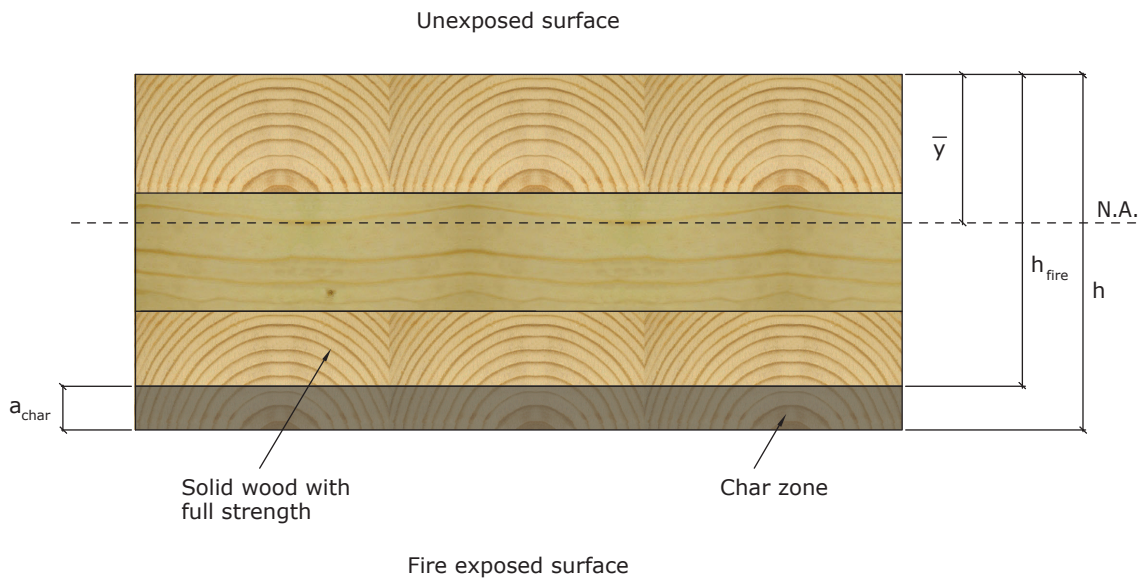

Figure 7

Nomenclature used in calculating fire resistance of a CLT exposed to fire from below

Step 1: Calculation of lamination fall-off time

Calculate the time required to reach every glued interface (i.e., glue lines) as per Equation 4. This time step will determine the number of charred layers considering potential delamination due to the adhesive performance at elevated temperature.

$$t_{fo} = \left(\frac{h_{lam}}{\beta_n} \right)^{1.23} \quad [4]$$

where:

- t_{fo} = time to reach a glued interface (hr)
- h_{lam} = lamella thickness (in.)
- β_n = nominal charring rate = 1.5 in./hour

The number of layers of laminations that may fall-off is then rounded to the lowest integer as follows:

$$n_{lam} = INT \left(\frac{t}{t_{fo}} \right) \quad [5]$$

where:

n_{lam} = number of laminations that may fall-off (rounded to lowest integer)
 t = required fire resistance (hours).

Step 2: Calculation of the effective char depth

Calculate the effective depth of char based on the number of laminations that may delaminate by using the stepped charring rate model described in Subsection 4.1.3.3 of this Chapter. The effective depth of char can be calculated as follows:

$$a_{char} = 1.2 \left[n_{lam} \cdot h_{lam} + \beta_n \left(t - (n_{lam} \cdot t_{fo}) \right)^{0.813} \right] \quad [6]$$

where:

a_{char} = effective depth of char (in.).

Step 3: Determination of effective residual cross-section

The effective cross-section depth remaining for design under fire conditions (h_{fire}) can be calculated as:

$$h_{fire} = h - a_{char} \quad [7]$$

where:

h_{fire} = effective cross-section depth (in.)
 h = initial cross-section depth of the CLT panel (in.)

Since the stiffness of the crossing plies is ignored (i.e., $E_{90} = 0$), should h_{fire} fall within a cross ply (i.e., between plies that are parallel to the applied stress), h_{fire} is reduced to the distance from the unexposed face to the edge of the nearest inner ply of the major strength direction.

Step 4: Find location of neutral axis and section properties of the effective residual cross-section

Equation 8 shall be used to calculate the location of the neutral axis (\bar{y}) when the plies parallel to the direction of the applied stress do not all have the same modulus of elasticity.

$$\bar{y} = \frac{\sum_i \tilde{y}_i h_i E_i}{\sum_i h_i E_i} \quad [8]$$

where:

\bar{y} = distance from the unexposed surface of the panel to the neutral axis (in.)
 \tilde{y}_i = distance from the unexposed surface of the panel to the centroid of ply i (in.)
 h_i = remaining depth of ply i (in.)
 E_i = modulus of elasticity of the ply i in the major strength axis (psi).

It should be reminded that the modulus of elasticity for plies perpendicular to the applied stress (i.e., E_{90}) can typically be approximated as $E/30$. However, in fire design, this value can conservatively be assumed to equal zero when calculating the neutral axis and section properties of asymmetrical cross-sections by the classical laminates wood composite theory.

If the plies in the direction of the applied stress all consist of the same grade and species group and therefore have the same modulus of elasticity, Equation 5 can be reduced to the following equation:

$$\bar{y} = \frac{\sum_i \tilde{y}_i h_i}{\sum_i h_i} \quad [9]$$

The effective bending stiffness of the effective residual cross-section can be determined using Equation 10 as follow:

$$EI_{eff} = \sum_i \frac{b_i h_i^3}{12} E_i + \sum_i b_i h_i d_i^2 E_i \quad [10]$$

where:

- EI_{eff} = effective bending stiffness (lb·in.²)
- d_i = distance from the neutral axis to the centroid of ply i (in.)
- b_i = unit width of the CLT panel (typically 1 foot)
- h_i = distance from the neutral axis to the centroid of ply i (in.).

Similarly, if the plies in the direction of the applied stress all consist of the same grade and species group and therefore have the same modulus of elasticity, Equation 10 can be reduced to the following equation for determining the moment of inertia of the effective residual cross-section:

$$I_{eff} = \sum_i \frac{b_i h_i^3}{12} + \sum_i b_i h_i d_i^2 \quad [11]$$

where:

- I_{eff} = moment of inertia of the effective residual cross-section (in.⁴).

Step 5: Calculation of structural resistance

Using the effective reduced cross-section determined in Step 3 and ignoring any contribution to the strength provided by the plies perpendicular to the applied stress, calculate the member capacity by multiplying the adjusted stress design values by using accepted NDS design procedures related to fire design of wood members.

The calculation of the design resisting moment and the resisting axial compression capacity has been split into Steps 5a and 5b respectively due to the different interactions used.

Step 5a: Calculation of the design resisting moment

The design resisting moment of a CLT assembly can be calculated using the procedure of Section 3.3 of NDS. The effective section modulus of the residual cross-section (S_{eff}) is calculated based on the moment of inertia of the plies running in the direction of the applied stress (I_{eff}) and the location of the neutral axis (\bar{y}) as shown in Equation 12.

$$S_{eff} = \frac{EI_{eff}}{E(h_{fire} - \bar{y})} \quad [12]$$

where:

S_{eff} = effective section modulus (in.³)

E = modulus of elasticity of the ply that sustains the greatest tensile stress, typically E_i (psi).

If the plies in the direction of the applied stress all consist of the same grade and species group and therefore have the same modulus of elasticity, Equation 12 can be reduced to the following equation:

$$S_{eff} = \frac{I_{eff}}{h_{fire} - \bar{y}} \quad [13]$$

The size factor (C_p), volume factor (C_v), and lateral stability factor (C_l) for CLT panels should all be set to unity. The design resisting moment of a CLT assembly is thereby calculated based on the adjusted allowable bending stress value of the wood and the effective section modulus of the residual cross-section as shown in Equation 14.

$$M' = KF_b S_{eff} = 2.85F_b S_{eff} \geq M \quad [14]$$

where:

M' = design resisting moment in fire design (lb.in.)

K = adjustment factor in bending as per Table 4 and NDS = 2.85

F_b = bending stress design value of the wood (Tables 4A, 4B, 4C or 4F of NDS)

S_{eff} = effective section modulus (in.³)

M = maximum induced moment (lb.in.).

Note that the residual cross-section, neutral axis, moment of inertia and section modulus are continually changing during fire exposure as the cross-section is being reduced. Therefore, in cases where fire resistance may be the controlling design factor, it is recommended that these calculations be completed in a spreadsheet so the bending moment resistance can be calculated as a function of time.

An example showing the calculation of the bending moment resistance of a CLT floor assembly is shown in Subsection 4.1.8 of this Chapter.

Step 5b: Calculation of resisting axial compression capacity

The resisting axial compression capacity of a CLT assembly can be calculated using the procedures of Sections 3.6 and 3.7 of NDS. The effective area of the residual cross-section (A_{eff}) is calculated based on the area of the plies running in the direction of the applied axial stress.

In order to calculate the CLT wall stability factor (C_p), the slenderness ratio must be calculated using Equation 15.

$$\text{Slenderness ratio} = \frac{l_e}{\sqrt{\frac{12I_{eff}}{A_{eff}}}} \quad [15]$$

where:

l_e = effective length, typically equal to the unbraced height of the wall assembly (in.)

I_{eff} = moment of inertia of the effective residual cross-section (in.⁴)

A_{eff} = area of the effective residual cross-section (in.²).

The CLT wall stability factor shall be calculated as follows:

$$C_P = \frac{1 + (P_{cE}/P_c^*)}{2c} - \sqrt{\left[\frac{1 + (P_{cE}/P_c^*)}{2c} \right]^2 - \frac{P_{cE}/P_c^*}{c}} \quad [16]$$

where:

C_P = CLT wall stability factor

$P_{cE} = \frac{\pi^2 EI'_{min}}{l_e^2}$ = resisting critical buckling capacity in fire design (lb.)

$P_c^* = KF_c^* A_{eff} = 2.58F_c^* A_{eff}$ (as per Table 4 and NDS) (lb.)

$EI'_{min} = E'_{min} I_{eff}$ (psi)

$E'_{min} = KE_{min} = 2.03 E_{min}$ (as per Table 4 and NDS) (psi)

$E_{min} = E[1 - 1.645 COV_E] \cdot 1.03/1.66 = 0.518 E$ (as per Table 4 and NDS) (psi)

$COV_E = 0.10$ (as per NDS)

$c = 0.9$ (applicable to glue-laminated timber, as per NDS)

The size factor (C_P) for CLT panels should be set to unity. The resisting axial compression capacity of a CLT assembly is thereby calculated based on the adjusted allowable axial compression stress value of the wood and the effective area of the residual cross-section as shown in Equation 17.

$$P' = KF_C A_{eff} C_P = 2.58F_C A_{eff} C_P \geq P_{load} \quad [17]$$

where:

P' = resisting axial compression capacity in fire design (lb.)

K = adjustment factor in compression as per Table 4 and NDS = 2.58

F_C = axial compression stress design value of the wood (Tables 4A, 4B, 4C or 4F of NDS)

A_{eff} = effective area (in.²)

P_{load} = axial compression load (lb.)

When exposed to fire, a CLT wall assembly is subjected to second-order effects (i.e., P-Δ effects) due to the charring of the fire exposed surface. The cross-section reduces as a function of time which causes the neutral axis to shift towards the unexposed surface, thus creating an increasing eccentricity as a function of time (Figure 8). It is strongly recommended to calculate the fire resistance of a CLT wall assembly by using the procedures of

Section 15.4 of NDS for combined bending and axial loading. The time at which the CLT wall assembly can no longer support the applied axial load defines its structural fire resistance (t_{Struct}). Equation 18 provides an alternate form of NDS Equation 15.4-2 for use with CLT assemblies.

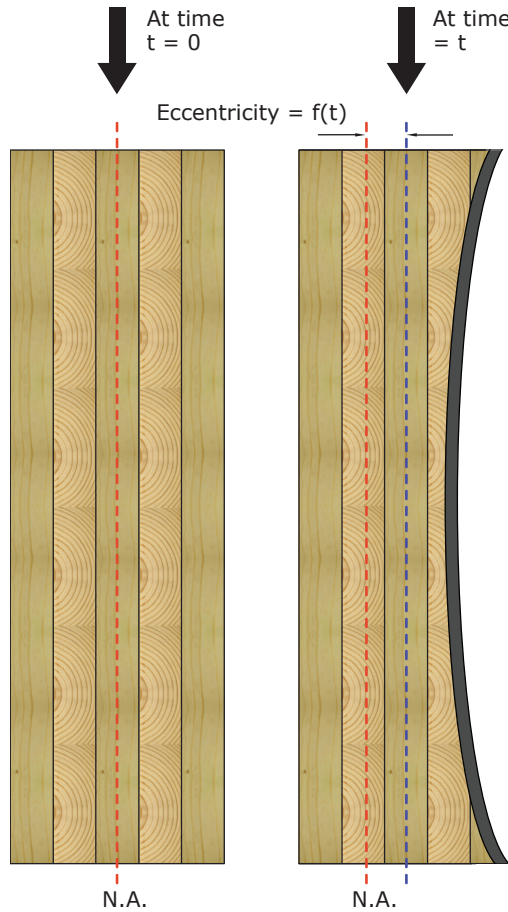

Figure 8
CLT wall assembly subjected to combined bending and axial compression

$$\left(\frac{P}{P'}\right)^2 + \frac{M + P\Delta\left(1 + 0.234\frac{P}{P_{cE}}\right)}{F'_b S_{eff}\left(1 - \frac{P}{P_{cE}}\right)} \leq 1.0 \quad [18]$$

where:

- P = axial compression load (lb.)
- P' = resisting axial compression capacity in fire design (lb.)
- M = maximum induced moment (lb.-in.)
- $P_{cE} = \frac{\pi^2 E'_{min}}{l_e^2}$ = resisting critical buckling capacity in fire design (lb.)
- $P^*_c = KF^*_c A_{eff} = 2.58F^*_c A_{eff}$ (as per Table 4 and NDS) (lb.)
- $EI'_{min} = E'_{min} I_{eff}$ (psi)
- $E'_{min} = KE_{min} = 2.03 E_{min}$ (as per Table 4 and NDS) (psi)

- $E_{\min} = E[1-1.645 \text{ COV}_E] \cdot 1.03/1.66 = 0.518 E$ (as per Table 4 and NDS) (psi)
 $\text{COV}_E = 0.10$ (as per NDS)
 Δ = deflection due to out-of-plane loading (bending), including the distance from the neutral axis to the centroid of load point (typically at mid-depth) (in.)
 F'_b = adjusted bending design value for fire design (Tables 4A, 4B, 4C or 4F of NDS)
 S_{eff} = effective section modulus (in.³).

Note that the residual cross-section, neutral axis, moment of inertia and slenderness ratio are continually changing during fire exposure as the cross-section is being reduced. Therefore, in cases where fire resistance may be the controlling design factor, it is recommended that these calculations be completed in a spreadsheet so the axial capacity can be calculated as a function of time.

An example showing the calculation of a CLT wall assembly subjected to combined bending and axial load is shown in Subsection 4.1.9 of this Chapter.

4.1.4.2 Use of Protective Membranes to Increase Structural Fire Resistance

The mechanics-based design procedure in NDS Chapter 16, as discussed in Subsections 4.1.2 to 4.1.4, is approved for fire-resistance calculations of exposed wood members up to 2 hours. Full-scale fire-resistance wall and floor tests have been conducted on CLT alone and with gypsum board protection and demonstrate that the NDS design procedure can also be used with CLT with a few slight modifications. While the NDS design procedure is currently limited to 2-hr resistance calculations of the wood members acting alone, fire-resistance tests exceeding 2 hours have been conducted and have shown that the fire resistance of CLT assemblies can be increased above the calculated fire resistance of the CLT alone when protective membranes are used.

The above calculations are based on an unprotected CLT panel fully exposed to standard fire exposure. If gypsum board is applied on the fire exposed sides, experiments completed on tension members by the U.S. Forest Products Laboratory (FPL) [30] and on CLT assemblies protected by Type X gypsum boards by FPInnovations [24, 31] indicate that the following times can be added to the structural failure time of unprotected assemblies calculated in accordance with Subsection 4.1.4.1 of this Chapter:

- a) 30 minutes when one (1) layer of $\frac{5}{8}$ in. (15.9 mm) Type X gypsum board is applied;
- b) 60 minutes when two (2) layers of $\frac{5}{8}$ in. (15.9 mm) Type X gypsum board are applied.

The gypsum board protective membranes shall be attached directly to the CLT panels using $2\frac{1}{4}$ in. (57 mm) Type S drywall screws spaced at 12 in. (305 mm) on center along the perimeter and throughout. Screws shall be kept at least $1\frac{1}{2}$ in. (38 mm) from the sides of each board edge. When using a single thermal protective membrane, the gypsum board joints shall be covered with tape and coated with joint compound. When using two layers of thermal protective membranes, the face layer joints shall be covered with tape and coated with joint compound. In all cases, the screw heads of the exposed layer shall also be covered with joint compound.

4.1.5 Fire Resistance of CLT Assemblies – Integrity Requirement

As mentioned in Subsection 4.1.1, integrity is one of the two requirements of the separating function of building assemblies. The time at which the CLT panel-to-panel joint detailing can no longer prevent the passage of flame or gases hot enough to ignite a cotton pad defines the integrity fire resistance (t_{int}). This requirement is essential in limiting the risk of fire spread to compartments beyond the compartment of fire origin.

Such panel-to-panel joint performance depends on its configuration and connection details (refer to Chapter 5 of this Handbook) whereas the integrity failure may occur when the connection detail can no longer withstand the applied load in either shear or withdrawal. For instance, when using wood screws to connect CLT panels together, a minimum of penetration not less than six times the wood screw diameter is required for single shear connections.

As the exposed face chars over a period of time, the allowable thickness for providing an adequate lateral or withdrawal capacity reduces. Further to the full-scale fire-resistance tests and inspired by the European methodology for timber assemblies, a simple calculation model has been developed for half-lapped CLT panel-to-panel joints (Figure 9) and is represented in Equation 19.

$$t_{Int} = K_j \frac{h}{\beta_n} = 0.35 \frac{h}{\beta_n} \quad [19]$$

where:

t_{Int} = integrity fire resistance time (hours)

K_j = CLT panel-to-panel joint coefficient = 0.35 (for half-lapped joint)

h = CLT panel thickness (in.)

β_n = nominal charring rate based on a 1-hour exposure (one-dimensional) = 1.5 in./hr.

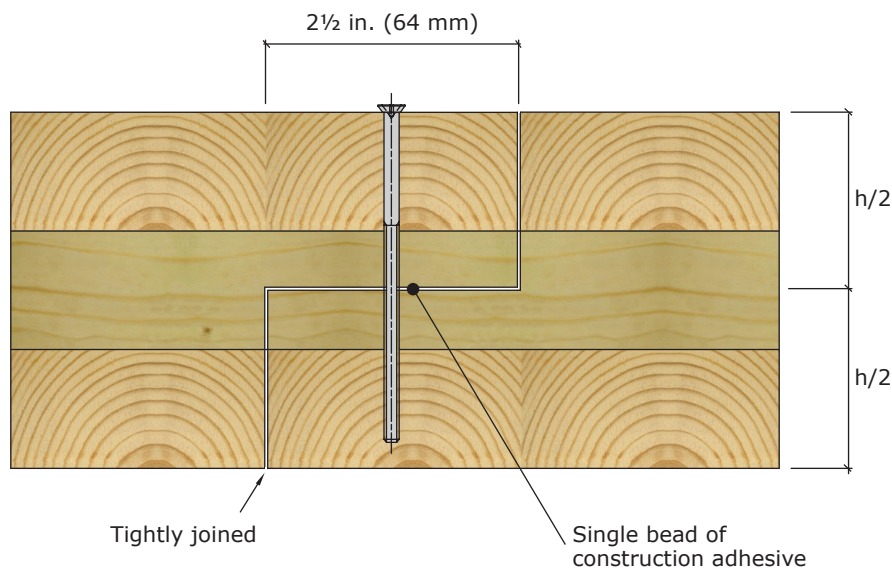

Figure 9
CLT panel-to-panel half-lapped joint detail

4.1.5.1 Effect of Joints on Integrity of CLT Walls and Floors

The panel-to-panel joint configuration can affect the integrity performance of CLT assemblies. The sides of individual CLT panels are shielded from full fire exposure by adjacent panels collectively acting as a joint. Partial exposure may occur as panels shrink and joints between panel open.

So far, only half-lapped joints have been evaluated (Figure 9) where the joint was located at mid-depth of the CLT panels and overlapping for at least 2 1/2 in. (64 mm). The joints were also fastened using self-tapping wood screws of 3 1/2 in. (90 mm), 6 1/4 in. (160 mm) and 8 3/4 in. (220 mm) for CLT assemblies made of 3-, 5- and 7-ply respectively. A bead of construction adhesive was also used to ensure that the joint was sealed.

However, connection details of CLT assemblies may also consist of single or double surface splines or internal spline(s). These tightly fitted joint profiles should provide sufficient fire resistance, but have yet to be properly evaluated for fire resistance in CLT assemblies.

The integrity of building assemblies is also regulated in the IBC by the requirements that through-penetrations (i.e., service penetrations) in assemblies be fire-resistance rated (refer to Section 7 for more details).

4.1.5.2 Use of Protective Membranes, Floor Coverings, and Interior Finish to Address Integrity

The calculation shown in Subsection 4.1.5 is based on an unprotected CLT panel-to-panel half-lapped joint fully exposed to standard fire exposure. When the integrity requirement cannot be fulfilled by the CLT panels alone, additional floor coverings or wall sheathings can be used to increase the integrity failure time. For example, the thickness of the floor coverings may be added to the CLT assembly thickness (b) when using Equation 19. If gypsum board is applied on the fire exposed side, the assigned time listed in Subsection 4.1.4.2 can be added to the unprotected CLT assembly integrity failure time.

Moreover, when adding a concrete topping, the integrity criteria may be assumed to be respected as the concrete topping will prevent the flame penetration through the assembly and the joint coefficient (k_j) may then be set to unity.

4.1.6 Fire Resistance of CLT Assemblies – Insulation Requirement

As mentioned in Subsection 4.1.1, insulation is one of the requirements of the separating function of building assemblies. The time at which the CLT assembly can no longer prevent the temperature on the unexposed surface from rising above 325°F (180°C) at any location, or an average of 250°F (140°C) measured at a number of locations, above the initial temperature, defines the insulative fire resistance (t_{ins}). This requirement is essential in limiting the risk of fire spread to compartments beyond the compartment of fire origin as well as allowing safe egress on the unexposed side of the assembly.

4.1.6.1 Theoretical Temperature Profiles for CLT Assemblies

Heat transfer occurs from regions of high temperature to regions of cooler temperature within solids (e.g., from the fire room of origin to adjacent compartments through a wall or floor assembly). Such heat transfer mode in solid materials is called conduction and is a well-known mechanism that satisfies Fourier's law of conduction. Conduction is also related to the material thermal conductivity (k) represented by the three dimensional (3-D) differential equation shown in Equation 20.

$$\rho c \frac{\partial T}{\partial t} = \frac{\partial}{\partial x} \left[k \frac{\partial T}{\partial x} \right] + \frac{\partial}{\partial y} \left[k \frac{\partial T}{\partial y} \right] + \frac{\partial}{\partial z} \left[k \frac{\partial T}{\partial z} \right] + \dot{Q} \quad [20]$$

where:

- ρ = density of material (kg / m³)
- c = specific heat of material (J / kg·K)
- k = thermal conductivity of material (W / m·K)
- $\partial T / \partial t$ = temperature as a function of time t (K / s)
- $\partial T / \partial x$ = temperature in the x -direction (K / m)
- $\partial T / \partial y$ = temperature in the y -direction (K / m)
- $\partial T / \partial z$ = temperature in the z -direction (K / m)
- \dot{Q} = rate of heat consumption per unit volume due to chemical reaction (W / m³).

The rate of heat absorption per unit volume due to chemical reaction consists of two parts: 1) the pyrolysis of the wood (Q''_{pw}) expressed by an Arrhenius function; and 2) the heat of evaporation of water per unit volume (Q''_w). More information in regards to the rate of heat, pyrolysis of the wood and heat of evaporation of water can be found in [32, 33].

Materials with a high thermal conductivity (such as steel) are usually considered to be good thermal conductors, while those having a low thermal conductivity (such as wood) are considered to be good thermal insulators. As such, the transient or steady-state heat transfer by conduction is low when compared with other materials having higher thermal conductivity.

Solving transient heat conduction through a solid material that exhibits charring can be challenging without the use of advanced computer models such as finite element software. Such temperature predictions may be useful for determining the time of charring of the wood when conducting a performance-based design.

4.1.6.2 Experimental Temperature Profile Data for CLT Assemblies

As the use of finite element analysis may not be available to most building designers, there are experimental temperature profile data for solid wood slabs. In one such generic profile [34], the temperature at a distance from the char front is given for when the member behaves as a semi-infinite solid, as shown in Equation 21:

$$T = T_i + (T_p - T_i) \left(1 - \frac{x}{a}\right)^2 \quad [21]$$

where:

- T = temperature (°C)
- T_i = initial temperature (°C)
- T_p = char front temperature (°C)
- x = distance from the char front (mm)
- a = thermal penetration depth (mm).

Based on data for eight species [19], the best fit values for the thermal penetration depth (a) were 1.34 in. (34 mm) for spruce, 1.30 in. (33 mm) for western red cedar and southern pine, and 1.38 in. (35 mm) for the redwood specimens [34]. In the 1993 Eurocode 5, “a” was assigned a value of 40 [34]. Thus, no temperature rise on the back surface is calculated to occur until the residual CLT thickness is less than 1.4 in. (35 mm) or 1.6 in. (40 mm). The thickness from the base of the char layer required to keep the temperature below the 250°F (140°C) average temperature rise criteria (or temperature of about 320°F (160°C)) indicated by Equation 21 is 0.5 in. (12 mm) but the slab (the backside being no longer at the ambient temperature) will no longer be behaving as a semi-infinite solid. Thus, the required thickness for the back surface is greater than this 0.5 inch value. The Wood Handbook [27] notes the temperature at ¼ in. (6 mm) inward from the base of the char layer in a semi-infinite slab subjected to ASTM E119 exposure is about 350°F (180°C).

In order to facilitate future Code acceptance for the design of CLT panels for fire resistance, a research project has recently been completed at FPInnovations. The main objective of the project aimed at developing and validating a generic calculation procedure to compute the fire-resistance ratings of CLT wall and floor assemblies. A series of full-scale wall and floor fire-resistance experiments in accordance with ASTM E119 standard time-temperature curve has been conducted to allow a comparison between the fire resistance measured during a standard fire-resistance test and that calculated using the proposed alternative method. Figure 10 shows the experimental temperature profile data obtained from this series of full-scale fire-resistances tests in accordance with ASTM E119 and ULC S101 standards compared to the profile obtained by using Equation 21.

It can be seen from the results in Table 5 that the insulation requirement is easily met, even for a temperature difference of 1836°F (1000°C) through an effective residual CLT thickness as thin as 1.92 in. (49 mm).

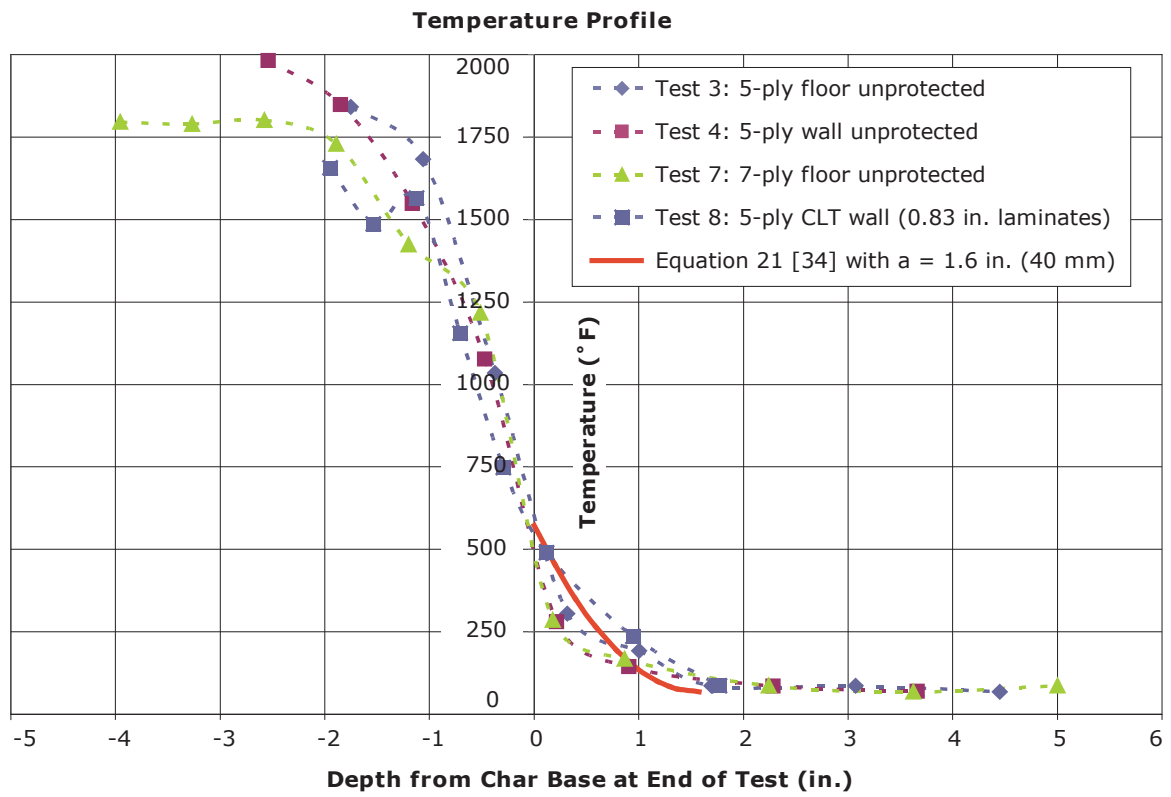

Figure 10
Experimental temperature profiles from [24] and Equation 21

Table 5

Average maximum temperature rises at unexposed surface

Assembly	Failure Time (min)	Effective Residual Thickness (in.)	Temperature			Temperature Rise on Unexposed Surface (°F)
			Furnace (°F)	Unexposed Surface (°F)	Initial Condition (°F)	
Wall 1	106	3.82	1817	75	73	2
Wall 2	113	3.62	1859	70	70	0
Wall 3	57	1.93	1922	86	70	16
Floor 1	77 *	4.13	1780	72	73	1
Floor 2	96	4.13	1800	68	68	0
Floor 3	86	2.20	1783	140	72	68
Floor 4	124	3.50	1843	81	73	8
Floor 5	178	4.13	1920	86	68	18

* Test was stopped due to equipment safety concerns. Failure was not reached.

4.1.7 Comparison between Calculation Method and Experiments

FPInnovations, in close collaboration with the National Research Council of Canada (NRCC), conducted eight fire-resistance tests to develop and validate a generic fire-resistance calculation procedure of CLT assemblies for code compliance (as described in Subsections 4.1.4 to 4.1.6 of this Chapter).

Different load ratios were applied depending on the number of plies and the assembly type (wall or floor). The assemblies were outfitted with thermocouples, embedded throughout the assemblies at five locations and in the panel-to-panel joints, and deflection gauges at nine locations.

Assemblies consisted of CLT panels, which were constructed either of SPF No.1, No.2, No.3 or MSR lumber boards and came from different manufacturers across Canada. The dimensions of the floor assemblies were 142 in. x 190 in. (3.61 m x 4.85 m) and the wall assemblies were 144 in. x 120 in. (3.66 m x 3.05 m) high. All assemblies used a half-lapped panel-to-panel joint which was fastened with self-tapping screws. The joints were also sealed during assembly using a ¼ in. (6 mm) bead of construction adhesive.

The panels were manufactured with a structural polyurethane adhesive conforming to ANSI/APA PRG 320 standard. Some of the CLT panels were fully exposed to fire (unprotected) while others were protected with Type X gypsum boards. Table 6 summarizes the configuration details of each tested CLT assemblies.

Table 6

CLT assemblies configuration details

	# of Plies	Lumber Grade in Major Strength Direction	Thickness in. (mm)	Gypsum Board Protection in. (mm)	Superimposed Load	Load Ratio (ASD) %
Wall	3	MSR 1650 f_b -1.5E	4.49 (114)	2 x ½ (12.7)	22818 lb./ft. (333 kN/m)	58
	5	MSR 1950 f_b -1.7E	6.89 (175)	Unprotected	22818 lb./ft. (333 kN/m)	29
	5	No.1/No.2	4.13 (105)	Unprotected	4934 lb./ft. (72 kN/m)	23
Floor	3	MSR 1650 f_b -1.5E	4.49 (114)	2 x ½ (12.7)	56 psf (2.7 kPa)	46
	5	MSR 1950 f_b -1.7E	6.89 (175)	Unprotected	246 psf (11.8 kPa)	75
	3	No.1/No.2	4.13 (105)	1 x ⅝ (15.9)	50 psf (2.4 kPa)	90
	5	No.1/No.2	6.89 (175)	1 x ⅝ (15.9)	169 psf (8.1 kPa)	120
	7	No.1/No.2	9.65 (245)	Unprotected	305 psf (14.6 kPa)	119

Note: Load ratios are based on $F_c' A_{eff}$ for walls and $F_b' S_{eff}$ for floors, under normal design conditions.

It should be noted that some specimens were loaded beyond their allowable strength capacities because the load ratios were derived based on ULC S101 requirement, which follows the limit states design philosophy (similar to LRFD), as opposed to the provisions given in ASTM D6513 and D7746, which follow the ASD philosophy.

The measured times to fire-resistance failure are compared to calculated fire resistance of CLT assemblies in Table 7 and Figure 11. The insulation requirement is not listed as this requirement was met in all cases, as shown in Table 5; therefore, only the structural (loadbearing) and integrity failure times are given, calculated as per Subsections 4.1.4 and 4.1.5 of this Chapter.

Table 7

Comparison between experiments and calculation methodology

	# of Plies	Experiments	Calculation Methodology		
		Failure Time (min)	Structural (min)	Integrity (min)	Assigned Fire Resistance (min)
Wall	3	106 (R)	63	102	63
	5	113 (R)	103	96	96
	5	57 (R)	53	57	53
Floor	3	77 (*)	81	102	81
	5	96 (E)	109	96	96
	3	86 (E)	59	87	59
	5	124 (E)	120	126	120
	7	178 (R)	107	135	107

* Test was stopped due to equipment safety concerns. Failure was not reached.
R = Structural Failure, E = Integrity Failure

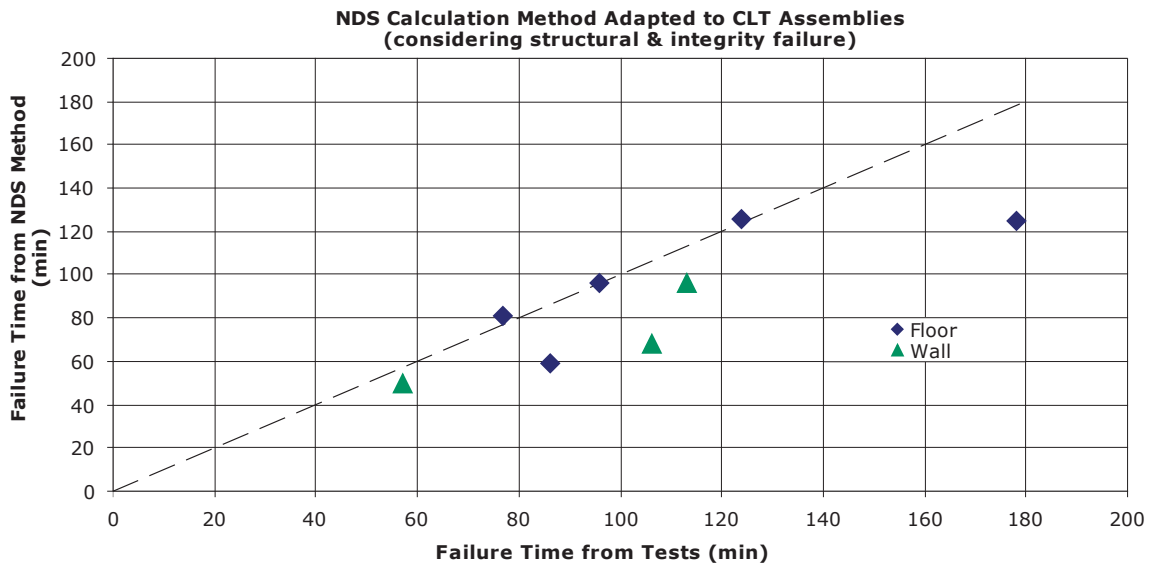

Figure 11

Comparison between experiments and calculation methodology

As can be seen in Figure 11, the mechanics-based method which uses a standard nominal charring rate ($\beta_n = 1.5$ in./hr), a non-linear stepped charring rate adjustment, a zero-strength layer multiplier of 1.2, and a standard variability adjustment in the design to ultimate adjustment factor predicts average fire-resistance times for CLT wall and floor assemblies that closely track actual fire-resistance times for tested assemblies. The experimental results that deviate the most from the predicted results were of a conservative nature since they exceeded the predicted results. While further refinements of this method are possible, these comparisons suggest that standardized adjustments

to design stresses, a standardized stepped charring rate, and the use of the NDS behavioral equations adequately address fire-resistance design of CLT assemblies.

4.1.8 Floor Design Example

The following floor design example follows the steps listed above for determining whether the fire resistance of an exposed 5-ply CLT floor assembly meets the hypothetically required fire-resistance rating of 90 minutes. The floor assembly has the following specifications:

- 5-ply CLT floor panel made from 1 3/8 in. x 3 1/2 in. lumber boards (CLT thickness of 6 7/8 in.)
- V2 CLT grade as per ANSI/PRG 320
 - $F_b S_{eff,0} = 4,675 \text{ lb.}\cdot\text{ft.}/\text{ft.}$
- Floor span = 18 feet (216 in.)
- Major strength direction plies
 - $F_{b,0} = 875 \text{ psi}$
 - $E_0 = 1.4 \times 10^6 \text{ psi}$
 - Specific gravity = 0.42 (26.1 lb./ft.³)
- Minor strength direction plies
 - $F_{b,90} = 500 \text{ psi}$
 - $E_{90} = 1.2 \times 10^6 \text{ psi}$
 - Specific gravity = 0.42 (26.1 lb./ft.³)
- Adhesive in accordance with ANSI/PRG 320 requirements (with potential delamination)
- Panels connected using a half-lapped joint as per Figure 9
- Applied load of 50 psf (live)
- Induced bending moment representing a load ratio of 56%.

4.1.8.1 Calculation of the Loadbearing Function after 90 Minutes of Standard Fire Exposure

Step 1: Calculation of lamination fall-off time

The time to reach a glue line is calculated from Equation 4 as follows:

$$t_{fo} = \left(\frac{h_{lam}}{\beta_n} \right)^{1.23} = \left(\frac{1\frac{3}{8}''}{1\frac{1}{2}''/hr} \right)^{1.23} = 0.90 \text{ h} = 54 \text{ min}$$

The number of layers of laminations that may fall-off is rounded to the lowest integer as follows:

$$n_{lam} = INT \left(\frac{90}{54} \right) = 1 \text{ laminate}$$

Step 2: Calculation of the effective char depth

The effective depth of char based on the number of laminations that may delaminate can be calculated as follows:

$$a_{char} = 1.2 \left[n_{lam} \cdot h_{lam} + \beta_n \left(t - (n_{lam} \cdot t_{fo}) \right)^{0.813} \right]$$
$$a_{char} = 1.2 \left[1 \cdot 1\frac{3}{8}'' + 1.5 \frac{in.}{hr} \left(\frac{90}{60} - \left(1 \cdot \frac{54}{60} \right) \right)^{0.813} \right] = 2.84 in.$$

Step 3: Determination of effective residual cross-section

The remaining cross-section is then calculated using Equation 4:

$$h_{fire} = h - a_{char} = 6\frac{7}{8} - 2.84 = 4.035 in.$$

In this example, the third ply has started to char and its residual thickness is 1.285 in. Its centroid is located at 3.393 in. from the unexposed side.

Step 4: Determination of location of neutral axis and section properties of the effective residual cross-section

Since the V2 CLT grade is of a symmetrical lay-up in accordance with ANSI/PRG 320, the simplified Equations 9 and 11 can be used to determine the neutral axis and the moment of inertia of the reduced cross-section:

$$\bar{y} = \frac{\sum_i \tilde{y}_i h_i}{\sum_i h_i} = \frac{\left(\frac{1.375}{2} \times 1.375 \right) + (3.393 \times 1.285)}{1.375 + 1.285} = 1.994 in.$$

$$I_{eff} = \sum_i \frac{b_i h_i^3}{12} + \sum_i b_i h_i d_i^2$$
$$= \left(\frac{12 \cdot (1.375)^3}{12} \right) + \left(\frac{12 \cdot (1.285)^3}{12} \right)$$
$$+ \left(12 \cdot 1.375 \cdot \left(1.994 - \frac{1.375}{2} \right)^2 \right)$$
$$+ (12 \cdot 1.375 \cdot (3.393 - 1.994)^2) = 63.1 \frac{in.^4}{ft.}$$

Step 5a: Calculation of design resisting moment

Using the effective reduced cross-section determined in Step 3 and ignoring any contribution to the strength provided by the cross-ply (i.e., minor strength direction), the design resisting moment of the CLT floor assembly capacity can be determined by using accepted NDS design procedures as described with Equations 13 and 14:

$$S_{eff} = \frac{I_{eff}}{h_{fire} - \bar{y}} = \frac{63.1 \frac{in.^4}{ft.}}{4.035 in. - 1.994 in.} = 30.9 \frac{in.^3}{ft.}$$

$$\begin{aligned} M' &= KF_b S_{eff} = 2.85 \cdot (0.85 \cdot 875 \text{ psi}) \cdot 30.9 \frac{in.^3}{ft.} = 65,498 \frac{lb. \cdot in.}{ft.} \\ &= 5,458 \frac{lb. \cdot ft.}{ft.} \end{aligned}$$

After 90 minutes of standard fire exposure, a thickness of 2.84 in. from the CLT panel has been volatilized into char ($h_{fire} = 4.035$ in.), which reduced the dead load portion of the applied load as follows:

$$w_{Total} = Live + Dead = 50 + \left(26.1 \cdot \frac{4.035}{12} \right) = 58.8 \text{ psf}$$

The induced bending moment in fire-resistance design is then equal to:

$$M_{max} = \frac{w_{Total} \cdot Span^2}{8} = \frac{58.8 \text{ psf} \cdot (18 \text{ ft.})^2}{8} = 2,381 \frac{lb. \cdot ft.}{ft.} \quad (\leq M')$$

The induced bending moment represents a load ratio of 44%, thus the CLT floor assembly meets the required 90 minutes fire resistance under these loads, span, and CLT grade and configurations.

It should be noted that, according to Subsection 4.1.4.2, a directly applied $\frac{5}{8}$ in. Type X gypsum board provides an extra 30 minutes to the fire resistance by delaying the time of ignition of the CLT panels. Therefore, the use of such protective membrane would provide a CLT assembly with 2 hours of fire resistance (90 min + 30 min = 120 min).

4.1.8.2 Calculation of the Separating Function after 90 Minutes of Standard Fire Exposure

The separating function of the CLT floor assembly is determined by using Equation 19 as follows:

$$t_{Int} = K_j \frac{h}{\beta_n} = 0.35 \times \frac{6\frac{7}{8} \text{ in.}}{1.5 \frac{in.}{hr}} = 1.6 \text{ hr} = 96 \text{ min}$$

As with the loadbearing function, a directly applied $\frac{5}{8}$ in. Type X gypsum board provides an extra 30 minutes to the fire resistance by delaying the time of ignition of the CLT panels underneath. Therefore, the use of such protective membrane would provide a CLT assembly with 2 hours of fire resistance (96 min + 30 min = 126 min).

4.1.9 Wall Design Example

The following wall design example follows the steps listed above for determining whether the fire resistance of a 3-ply CLT wall assembly meets the hypothetically required fire-resistance rating of 1 hour. The wall assembly has the following specifications:

- 3-ply CLT wall panel made from 1 3/8 in. x 3 1/2 in. lumber boards (CLT thickness of 4 1/8 in.)
- E1 CLT grade as per ANSI/PRG 320
 - $F_b S_{\text{eff},0} = 4,525 \text{ lb.}\cdot\text{ft.}/\text{ft.}$
 - $EI_{\text{eff},0} = 115 \times 10^6 \text{ lb.}\cdot\text{in.}^2/\text{ft.}$
 - $GA_{\text{eff},0} = 0.46 \times 10^6 \text{ lb.}/\text{ft.}$
- Wall height = 12 feet (144 in.)
- Major strength direction plies
 - $F_{b,0} = 1,950 \text{ psi}$
 - $F_{c,0} = 1,800 \text{ psi}$
 - $E_0 = 1.7 \times 10^6 \text{ psi}$
 - Specific gravity = 0.50 (31.1 lb./ft.³)
- Minor strength direction plies
 - $F_{b,90} = 500 \text{ psi}$
 - $E_{90} = 1.2 \times 10^6 \text{ psi}$
 - Specific gravity = 0.42 (26.1 lb./ft.³)
- Adhesive in accordance with ANSI/PRG 320 requirements (with potential delamination)
- Panels connected using a half-lapped joint as per Figure 9
- Panels protected by a one layer of 5/8 in. Type X gypsum board
- Applied load of 8,425 plf (live)
- Induced load representing a load ratio of 41% of the resisting axial compression capacity and 40% of the bearing capacity.

4.1.9.1 Calculation of the Loadbearing Function after 60 Minutes of Standard Fire Exposure

Since the protective membrane provides a 30 min onset of charring to the CLT panels in accordance with Subsection 4.1.4.2, the structural fire-resistance calculation is conducted for a fire exposure of 30 minutes only.

Step 1: Calculation of lamination fall-off time

The time to reach a glue line is calculated from Equation 4 as follows:

$$t_{fo} = \left(\frac{h_{lam}}{\beta_n} \right)^{1.23} = \left(\frac{1\frac{3}{8}''}{1\frac{1}{2}''/\text{hr}} \right)^{1.23} = 0.90 \text{ h} = 54 \text{ min}$$

Since the fire exposure of 30 minutes is lower than the estimated time of potential lamination fall-off, Equation 2 can be used to calculate the effective char depth.

Step 2: Calculation of the effective char depth

The effective charring rate can then be calculated using Equation 2 for a fire exposure of 30 minutes as follows:

$$a_{char} = \beta_{eff} t = 1.2 \beta_n t^{0.813} = 1.2 \cdot 1.5 \frac{in.}{hr} \cdot \left(\frac{30}{60}\right)^{0.813} = 1.02 in.$$

Step 3: Determination of effective residual cross-section

The remaining cross-section is then calculated using Equation 4:

$$h_{fire} = h - a_{char} = 4.125 - 1.02 = 3.105 in.$$

In this wall design example, since h_{fire} falls within a ply of the major strength direction (i.e., within the third ply), only a portion of the exposed ply ($1.375 - 1.02 = 0.35$ in.) and the complete first unexposed ply can still be considered for this fire resistance design example. The third ply centroid is located at 2.925 in. from the unexposed side.

Step 4: Determination of location of neutral axis and section properties of the effective residual cross-section

Since the E1 CLT grade is of a symmetrical lay-up (along the major strength direction) in accordance with ANSI/PRG 320, the simplified Equations 6 and 8 can be used to determine the neutral axis and the moment of inertia of the reduced cross-section:

$$\bar{y} = \frac{\sum_i \tilde{y}_i h_i}{\sum_i h_i} = \frac{\left(\frac{1.375}{2} \times 1.375\right) + (2.925 \times 0.35)}{1.375 + 0.35} = 1.14 in.$$

$$I_{eff} = \sum_i \frac{b_i h_i^3}{12} + \sum_i b_i h_i d_i^2 = \left(\frac{12 \cdot (1.375)^3}{12}\right) + \left(\frac{12 \cdot (0.35)^3}{12}\right) + \left(12 \cdot 1.375 \cdot \left(1.14 - \frac{1.375}{2}\right)^2\right) + \left(12 \cdot 0.35 \cdot (2.925 - 1.14)^2\right) = 19.4 \frac{in.^4}{ft.}$$

$$A_{eff} = \sum_i b_i h_i = (12 \cdot 1.375) + (12 \cdot 0.35) = 20.7 \frac{in.^2}{ft.}$$

Step 5b: Calculation of resisting axial compression capacity

Using the effective reduced cross-section determined in Step 3 and ignoring any strength and stiffness contribution from the cross-ply (i.e., minor strength direction), the resisting axial capacity of the CLT wall assembly can be determined by using accepted NDS design procedures as described with Equations 15 to 17.

$$\text{Slenderness ratio} = \frac{l_e}{\sqrt{\frac{12 I_{eff}}{A_{eff}}}} = \frac{144}{\sqrt{\frac{12 \times 19.4}{20.7}}} = 42.9 \quad (\leq 50)$$

$$\begin{aligned} E'_{min} &= 2.03 E [1 - 1.645 COV_E] \cdot \frac{1.03}{1.66} \\ &= 2.03 \cdot 1.7 \times 10^6 \text{ psi} \cdot (1 - 1.645 \cdot 0.10) \cdot \frac{1.03}{1.66} \\ &= 1.79 \times 10^6 \text{ psi} \end{aligned}$$

$$P_{cE} = \frac{\pi^2 E I'_{eff}}{l_e^2} = \frac{\pi^2 \cdot (1.79 \times 10^6 \cdot 19.4)}{(144)^2} = 16,528 \text{ plf}$$

$$\begin{aligned} P_c^* &= 2.58 \cdot F_c (C_D C_M C_t) \cdot A_{eff} = 2.58 \cdot 1,800 \cdot (1 \cdot 1 \cdot 1) \cdot 20.7 \\ &= 96,131 \text{ plf} \end{aligned}$$

$$\frac{P_{cE}}{P_c^*} = \frac{16,528}{96,131} = 0.17$$

$$\begin{aligned} C_P &= \frac{1 + (P_{cE}/P_c^*)}{2c} - \sqrt{\left[\frac{1 + (P_{cE}/P_c^*)}{2c} \right]^2 - \frac{P_{cE}/P_c^*}{c}} \\ &= \frac{1 + 0.17}{2 \cdot 0.9} - \sqrt{\left[\frac{1 + 0.17}{2 \cdot 0.9} \right]^2 - \frac{0.17}{0.9}} = 0.17 \end{aligned}$$

$$P' = K F_c A_{eff} C_P = 2.58 \cdot 1800 \text{ psi} \cdot 20.7 \frac{\text{in.}^2}{\text{ft.}} \cdot 0.17 = 16,342 \text{ plf or } \frac{\text{lb.}}{\text{ft.}}$$

After 30 minutes of standard fire exposure, a thickness of 1.02 in. from the CLT panel has been volatilized into char ($h_{\text{fire}} = 3.1$ in.) and the gypsum board has probably started to fall-off, which reduced the dead load portion of the induced axial load as follows:

$$\begin{aligned} P &= \text{Live} + \text{Dead} \\ &= 8,425 + \left(31.1 \cdot \frac{0.35 + 1.375}{12} \cdot 12 \right) \\ &\quad + \left(26.1 \cdot \frac{1.375}{12} \cdot 12 \right) = 8,515 \text{ plf} \end{aligned} \quad (\leq P')$$

Such induced axial load represents a load ratio of 52%, thus the CLT floor assembly meets the required 1 hour fire resistance under these loads, wall height, CLT grade and configurations as well as with a 5/8 in. Type X gypsum board protective membrane on the fire exposed side.

As mentioned in Subsection 4.1.4.1, a CLT wall assembly is subjected to second-order effects (i.e., P-Δ effects) due to the charring of the fire exposed surface (Figure 8). It is strongly recommended to calculate the fire resistance of a CLT wall assembly by using the procedures of Section 15.4 of NDS for combined bending and axial loading, as shown in Equation 18.

$$S_{eff} = \frac{I_{eff}}{h_{fire} - \bar{y}} = \frac{19.4 \frac{in.^4}{ft.}}{3.1 in. - 1.14 in.} = 9.9 \frac{in.^3}{ft.}$$

$$\begin{aligned} M' &= KF_b S_{eff} = 2.85 \cdot (0.85 \cdot 1950 \text{ psi}) \cdot 9.9 \frac{in.^3}{ft.} = 46,766 \frac{lb \cdot in.}{ft.} \\ &= 3,897 \frac{lb \cdot ft.}{ft.} \end{aligned}$$

$$e = \frac{h}{2} - \bar{y} = \frac{4\frac{1}{8}}{2} - 1.14 = 0.92 \text{ in.}$$

$$\Delta_f = \frac{(P e) l_e^2}{16 E I_{eff}} = \frac{8,515 \cdot \left(\frac{4\frac{1}{8}}{2} - 1.14\right) \cdot 144^2}{16 \cdot 1.7 \times 10^6 \cdot 19.4} = 0.31 \text{ in.}$$

$$\Delta = e + \Delta_f = 0.92 + 0.31 = 1.23 \text{ in.} = 0.10 \text{ ft.}$$

$$\left(\frac{P}{P'}\right)^2 + \frac{M + P\Delta \left(1 + 0.234 \frac{P}{P_{cE}}\right)}{F'_b S_{eff} \left(1 - \frac{P}{P_{cE}}\right)} \leq 1.0$$

$$\left(\frac{8,515}{16,342}\right)^2 + \frac{0 + \left[8,515 \cdot 0.10 \cdot \left(1 + 0.234 \times \frac{8,515}{16,528}\right)\right]}{3,897 \cdot \left(1 - \frac{8,515}{16,528}\right)} = 0.78 \quad (\leq 1.0)$$

4.1.9.2 Calculation of the Separating Function after 60 Minutes of Standard Fire Exposure

The separating function of the CLT wall assembly is determined by using Equation 19 as follows:

$$t_{Int} = K_j \frac{D}{\beta_n} = 0.35 \cdot \frac{4\frac{1}{8} \text{ in.}}{1.5 \frac{\text{in.}}{\text{hr}}} = 0.96 \text{ hr} = 57 \text{ min}$$

According to Subsection 4.1.4.2, a directly applied $\frac{5}{8}$ in. Type X gypsum board provides an extra 30 minutes to the fire resistance by delaying the time of ignition of the CLT panels. Therefore, the use of such protective membrane would provide a CLT assembly with 1 hour of fire resistance (57 min + 30 min = 87 min).

5

CONNECTIONS

As described in Chapter 5 of this Handbook, entitled *Connections in cross-laminated timber buildings*, there is a wide variety of fasteners and many different types of joint details that can be used to establish wall-to-wall, wall-to-floor, and inter-story connections in CLT assemblies or to connect CLT panels to other wood-based elements, or to concrete or steel in hybrid construction. While long self-tapping screws are typically recommended by CLT manufacturers and are commonly used for panel-to-panel connections in floor (as per Figure 9) and floor-to-wall assemblies, traditional dowel-type fasteners such as wood screws, nails, lag screws, rivets, bolts and dowels can also be effectively used in connecting panel elements.

Connections in heavy timber construction, including those built with CLT, play an essential role in providing strength, stiffness, stability, ductility and structural fire resistance. Moreover, connections using metallic fasteners such as bolts, dowels and steel plates or brackets are widely used to assemble heavy timber components or CLT panels and to provide an adequate load path for gravity and/or lateral loads. Consequently, these connections require designers' attention to ensure that connections are not the weak link in heavy timber buildings exposed to fire.

Performance of timber connections exposed to fire can be quite complex due to the influence of numerous parameters such as the type of fasteners, the geometry of the connection, different failure modes as well as different thermal conductivity properties of steel, wood and char layer components. As such, most building codes, including the IBC, do not provide specific fire design methodology for determining the fire performance of timber connections.

Due to the high thermal conductivity of steel, metallic fasteners and plates directly exposed to fire may heat up and conduct heat into the wood members. The wood components may then experience charring on the exposed surface and around the fastener. As a result, the capacity of a metallic connection is reduced to the strength reduction of the steel fasteners at elevated temperatures and the charring of the wood members [35-43]. Therefore, where a fire resistance rating is required by the IBC, connections and fasteners are required to be protected from fire exposure by wood, gypsum board or other protection approved for the required rating.

However, some connections are not vulnerable to the damaging impact of fire. For example, a CLT wall-to-floor connection used to resist wind or seismic load, as shown in Figure 12, will not be significantly impacted by fire. However, connections used to resist gravity loads, as shown in Figure 13, may require some special considerations for increasing their resistance to fire exposure from underneath.

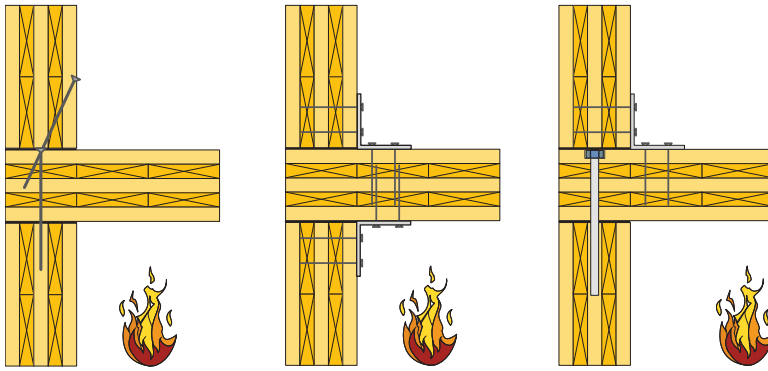

Figure 12
Examples of connections seen in CLT platform construction

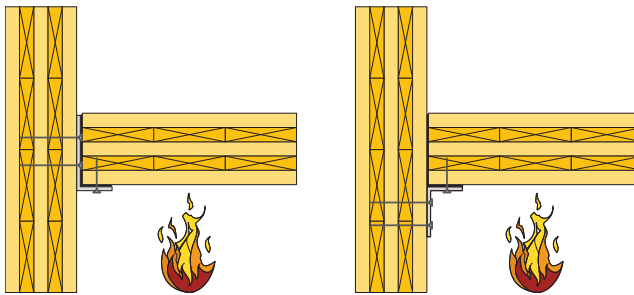

Figure 13
Examples of connections seen in CLT balloon construction

To improve aesthetics, designers often prefer to conceal connection systems. Hidden metal plates similar to those shown in Figure 14 can be used, but they require machining to produce the grooves in the CLT panel to conceal the metal plates.

When the connections are used in fire-retardant or preservative treated wood, recommendations with regard to the types of metal fasteners need to be obtained from the chemical manufacturer since some treatments cause corrosion of certain metals.

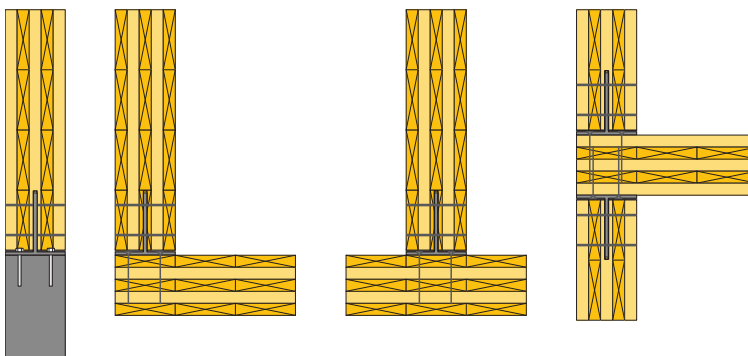

Figure 14
Concealed metal plates

It is advisable to review the recommendations provided in Chapter 5 of this Handbook with respect to proper detailing of connections in CLT assemblies.

6

INTERIOR FINISH

The spread of flames over solid materials is a fundamental behavior influencing the fire dynamics and growth within a compartment. Therefore, many provisions of the IBC and NFPA 5000 limit the use of combustible interior finishes such as the interior wall and ceiling finish as well as interior floor finish. The IBC and NFPA 5000 limit the allowable flame spread and smoke development of interior finishes based on the location, building occupancy and availability of an automatic fire suppression system. These provisions are set forth in Chapter 8 of the IBC and are intended to limit the spread of fire and products of combustion through a building in a manner that allows safe egress of the occupants and limits the damage to the building in which the fire originated.

6.1 **Flame Spread Index**

Interior finishes are traditionally classified with respect to their flame spread index and smoke development evaluated in accordance with ASTM E84 [44] standard for interior walls and ceiling finish. Interior floor finish and floor coverings may be regulated by the critical radiant flux test (ASTM E648 [45] or its NFPA 253 equivalent [46]).

The ASTM E84 standard is the most commonly used test method for determining the surface burning characteristics of building materials. A flame spread index (FSI), expressed as a dimensionless number, is defined as a comparative measure of surface flame spread. The smoke development index (SDI) is also expressed as a dimensionless number and is defined as a comparative measure of smoke density measurements.

6.1.1 **Test Method – ASTM E84**

The ASTM E84 standard test method, also called the “Steiner Tunnel”, exposes a nominal 24 ft. long x 20 in. wide (7.32 m x 508 mm) specimen to a controlled air flow and flaming fire exposure calibrated in a way to spread the flame through the entire length of the tunnel when testing red oak specimen for 5.5 min. This test method is also the UL 723 [47] standard.

6.1.2 **Flame Spread Index (A, B and C Classes)**

Interior finish materials are grouped in three classes in accordance with Section 803.1 of the IBC. Each class is assigned a range of FSI, as shown in Table 8. As noted in the Table, the SDI limit is 450 for all three classes.

Table 8

Flame spread classes according with IBC

Class	Flame Spread Index	Smoke Development Index
A	0-25	0-450
B	26-75	0-450
C	76-200	0-450

6.1.3 Areas of Likely Class A and Class B Requirements

FSI requirements are set forth in Table 803.9 of the IBC and are based on the building occupancy, location within the building, and whether the building is protected by automatic fire sprinklers. Exit enclosures, exit passageways, and corridors providing access to exits usually require materials having a more restrictive class (Class A and B), while other areas such as rooms and enclosed spaces may allow materials assigned as Class C.

Interior finish materials applied on walls, ceilings or structural elements required to provide a fire-resistance rating shall comply with Section 803.11 of the IBC with respect to interior finish directly attached to the structural elements or attached to furring strips not exceeding 1 3/4 in. (44 mm) in thickness directly applied to the structural elements.

6.1.4 Available Data for CLT and Other Wood Products

ASTM E84 is used only to provide dimensionless measures and description of the response of materials, products, or assemblies to heat and flame under controlled conditions. It does not by itself incorporate all factors required for fire-hazard or fire-risk assessment of materials, products, or assemblies under actual fire conditions. It also does not necessarily provide a good understanding of how fire would spread in real-scale scenarios.

A listing of flame spread data for generic wood products can be found in *Design for Code Acceptance (DCA) 1* published by the American Wood Council [48]. Per ANSI/APA PRG 320, the CLT can be constructed of any softwood lumber species or species combination recognized by the American Lumber Standards Committee (ALSC) under PS 20 [49] or by the Canadian Lumber Standards Accreditation Board (CLSAB) under CSA O141 [50] with a minimum published specific gravity of 0.35, as published in the NDS in the United States and CSA O86 [51] in Canada. Reported flame spread indices for softwood lumber of 1 in. thickness as reported in DCA No. 1 are listed in Table 9. As noted in the AWC DCA 1 publication, the ASTM E84 test method has been revised a number of times over the years referenced by the source reports. Slightly different flame spread indices, usually lower, result from more recent ASTM E84 flame spread tests when compared to older tests but the changes have not been deemed sufficient to change the classifications. As noted in the AWC DCA 1 publication, the available data for the smoke development index have all been less than the code prescribed limit of 450 for all three classes.

Table 9

Flame spread indices for softwood lumber

Species	Flame Spread Index
Cedar, Alaska yellow	50
Cedar, Pacific Coast yellow	78
Cedar, Port Orford	60
Cedar, Western Red	70-73
Cypress	145-150
Douglas-fir	70-100
Douglas-fir flooring, ¾ in.	83-98
Fir, Amabilis (Pacific Silver)	69
Fir, White	65
Hem-fir species group	60
Larch, Western	45
Pine, Eastern White	85
Pine, Idaho White	72
Pine, Lodgepole	98
Pine, Northern White	120-215
Pine, Ponderosa	105-230 ^a
Pine, Red	142
Pine, Southern Yellow	130-195
Pine, Sugar	95
Redwood	70
Spruce, Engelmann	55
Spruce, Northern	65
Spruce, Sitka	74

^a In 18 tests of ponderosa pine, three had values over 200 and the average of all tests is 154.

6.2 Fire-retardant Treatment and CLT

Wood products can be treated with fire retardants to increase their fire performance such as delaying time to ignition, reducing heat release rate, and lowering flame spread ratings. Such fire-retardant treatments (FRT) may also reduce the smoke development of FRT wood and wood-based products. While FRT enhances the flame spread performance of wood and wood-based products, such treatments do not make them noncombustible materials.

There are two types of FRT: coatings and pressure-impregnated chemicals. There are also two objectives for treating wood products with fire-retardant chemicals. One objective is to take advantage of provisions in the codes in with fire-retardant treated wood (FRTW) as a prescribed alternative. The other objective is to meet requirements in the codes for a specified flame spread index.

Only FRT by means of pressure-impregnated chemicals are an option for addressing code provisions that prescribe or allow for the use of FRTW including the FRTW specified as an option for protection of a CLT exterior wall in Type IV construction. The term “fire-retardant treated wood” is limited to wood pressure treated with fire retardant chemicals that comply with the requirements in the code for FRTW (Section 2303.2 of IBC). These requirements are more stringent than the Class A flame spread index requirement for interior finish applications. These requirements include the “30-min E84 test”, which is described in a new ASTM E2768 standard [52].

CLT components conforming to FRTW specifications are not expected to be available in the near future. The wood industry currently does not recommend the use of fire-retardant treatments of glulam. This is likely due to the potential effects of proprietary treatments on the mechanical properties and the performance of the adhesives.

If CLT components are subjected to pressure-impregnated fire-retardant treatments, it needs to be noted that the tabulated design values and capacities published in the NDS are for untreated members. The effect of FRT on mechanical properties will need to be addressed in the design. Reference design values, including connection design values, for lumber and CLT pressure-treated with fire retardant chemicals should be obtained from the manufacturer providing the treatment.

In addition to pressure treatments, fire-retardant surface treatments may also be used to address interior finish requirements that are more restrictive than the flame ratings for untreated wood. Surface treatments including clear intumescent coatings allow the designers to use CLT unprotected (e.g., without gypsum board or other cladding) while achieving the more restrictive finish rating requirements. While the code permits the use of coatings to address the finish rating requirements, field application of these coatings and questions of durability in certain applications may create difficulties in its acceptance in new construction by the authorities having jurisdiction. Structural wood panel products with a fire-rated factory-applied coating are available.

In an attempt to evaluate such effect on CLT assemblies, three treated CLT panels of 4 1/8 in. (105 mm) in thickness have been evaluated for flame spread in accordance with ULC S102 [53]. The tested specimens provided an average flame spread index of 25 [54]. It is expected that, when tested in accordance with ASTM E84, such fire-retardant coated CLT would exhibit a similar Class A rating.

Some components used in CLT construction may need to be treated with preservatives to improve resistance to decay and insects. Some commercial interior FR treatments do provide some resistance to decay and insects. This is likely due to boron chemicals in the formulations. Currently, there is no commercial treatment that is a combined treatment for preservation and fire in exterior applications. One option to address such situations is to use a FR coating on preservative-treated wood.

Pressure impregnated FR treatments are marketed to reduce the flame spread index and provide lower flammability performance. Such FR treatments do not have an appreciable effect on the charring rate which is the important parameter in the fire-resistance rating. Thus, they are not used to improve fire resistance ratings.

Past research by FPInnovations and FPL examined the potential for some coatings to improve the fire-resistance ratings of wood building elements. On this manner, Richardson & Cornelissen [55] conducted studies to identify coatings which could improve fire resistance of wood decking by delaying the onset of charring. Thirty coating systems were identified by manufacturers claiming intumescent properties on Douglas-fir tongue-and-groove planks coated on one side as per the manufacturers recommendations (e.g., exposed to an ASTM E119 standard fire for 30 minutes). Results showed that the char formation was reduced by as much as 70% and, therefore, applying such intumescent or fire-retardant coatings to purlins and undersides of heavy timber decking components will substantially improve the fire performance of such timber systems. FPL examined the effect of various coatings on the charring rate of wood [56] and developed equations that could be incorporated with current fire-resistance calculations for wood members [57]. However, at the present time, coatings do not have general code acceptance as a method to improve the fire resistance of wood products and are not marketed for such purpose.

6.3 Use of Other Membrane Products to Address Interior Finish Requirements

The most common method to address FSI and SDI interior finish requirements will likely be the installation of gypsum board. Gypsum board and gypsum sheathing have a Class A flame spread index. For situations where there is no fire-resistance rating requirement, regular gypsum board or non-fire-rated gypsum board can be used. When used to address fire-resistance requirements, the gypsum board will need to be fire-rated as either Type X or Type C. Likewise the interior finish requirements for low FSI can also be address by decorative hardwood plywood panels, particleboard, or medium density fiberboard panel products that have been treated with fire-retardant chemicals to achieve a Class A FSI. Such wood panel products are typically not treated to achieve the more stringent performance requirement for FRTW in the codes. Lumber and construction grade plywood panels are FR treated and marketed as products that satisfy the FRTW requirements in addition to the Class A flame spread index.

6.4 Foam Plastic Insulation

If foam plastic insulation is incorporated in CLT construction, the code provisions pertaining to foam plastic insulation will need to be addressed (Section 2603 of IBC). These provisions require foam plastic insulation to be protected from the interior by a 15 minute thermal barrier unless the application is one of those excluded. This requirement is normally satisfied with a ½ in. thick non-fire-rated gypsum board. Current acceptance requirements specified in the NFPA standard for thermal barriers cannot be met with untreated wood regardless of thickness. In addition to the thermal barrier requirement, Section 2603 of the IBC includes other provisions pertaining to the use of foam plastics in exterior walls of buildings of Types I, II, III, and IV construction.

6.5 Automatic Fire Sprinklers

Automatic fire sprinklers are an important fire safety feature in any building. They are addressed in Section 903 of the IBC. For certain buildings and occupancies, the codes will require the installation of an approved automatic fire sprinkler system. As discussed previously, the inclusion of such a system in a building may provide benefits in terms of allowable heights and areas and in terms of lower fire-resistance requirements for building elements. The applicable standards for automatic fire sprinkler systems are NFPA 13, 13R and 13D [9, 58, 59].

7

THROUGH PENETRATIONS

Penetrations in fire rated assemblies are required to be sealed to maintain the assembly's rating. Section 712 of the IBC requires penetrations of an assembly to have a fire-resistance rating and to be sealed by a fire stop system tested in accordance with ASTM E814 standard [60]. A fire stop system can be defined as a material, component, or system and its means of support, used to fill gaps between fire separations, fire separations and other construction assemblies, or used around items which wholly or partially penetrate fire separations, to restrict the spread of fire and often smoke thus maintaining the integrity of a fire separation [61]. It is thereby an essential fire protection measure for achieving a proper integrity performance of fire-rated assemblies.

7.1 Fire Stops through Fire Separations

As stipulated in section 712.3.1.1 of the IBC, penetrations in fire-rated assemblies such as fire separations shall be installed as tested in an approved fire-resistance rated assembly. Through penetrations, meaning an opening that passes through an entire assembly, shall be protected by an approved fire stop system, installed as tested per ASTM E814, with a minimum F-rating and T-rating not less than 1 hour. An F-rating can be defined as the time period where the through penetration fire stop system limits the spread of fire through the penetration while a T-rating is the time period where the fire stop system, including the penetrating element, limits the maximum temperature rise to 325°F (163°C) above its initial temperature through the penetration on the unexposed side.

7.2 Fire-resistant Joint Systems in CLT Construction

Very little information is available on the fire performance of fire stops used in CLT assemblies with partial and full penetrations. Further research needs to be carried out in a near future in order to adequately investigate the fire performance of fire stop systems in CLT construction.

However, there are numerous fire stop systems that are already approved for use with concrete and/or light-frame construction. Both of these types of constructions have similarities to CLT, where concrete is massive and typically does not have void cavities, and light-frame contains wood elements. Commonly-used fire stop systems can be classified under nine main categories, as follows:

1. Through-penetration fire stops;
2. Membrane-penetration fire stops;
3. Construction joint fire stops;
4. Building perimeter fire stops;
5. Caulks and sealants;
6. Mortar and grouts;
7. Foams;
8. Coatings, sprays and wraps;
9. Blocks, pillows and bags.

It is anticipated that fire stop systems, listed for use with wood-frame construction, may be acceptable for use with CLT construction (Figure 15). However, due to the proprietary nature of most fire stop systems, it is recommended that a qualified fire protection engineer undertakes or oversees the design and use of fire stop systems in CLT construction.

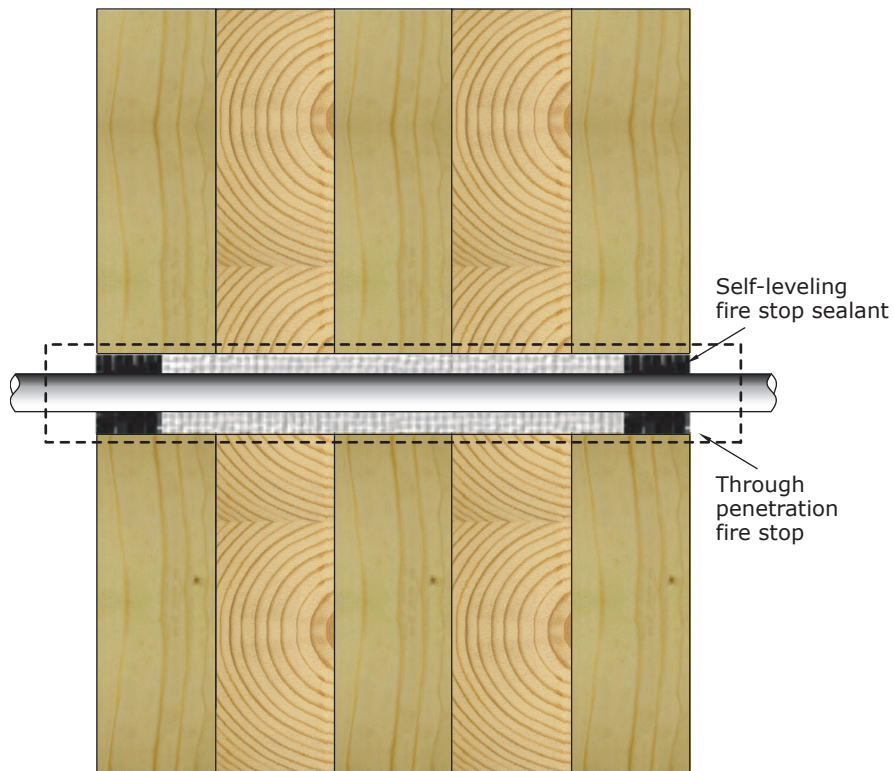

a) Fire stop sealant in a through penetration

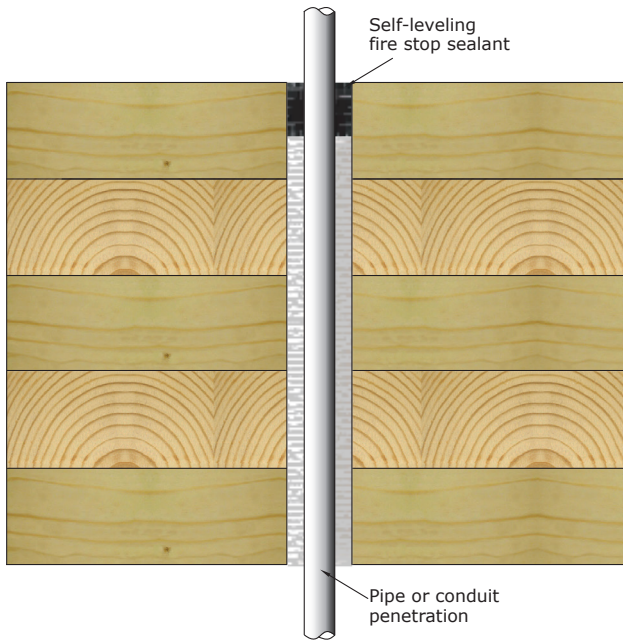

b) Fire stop sealant in a through penetration

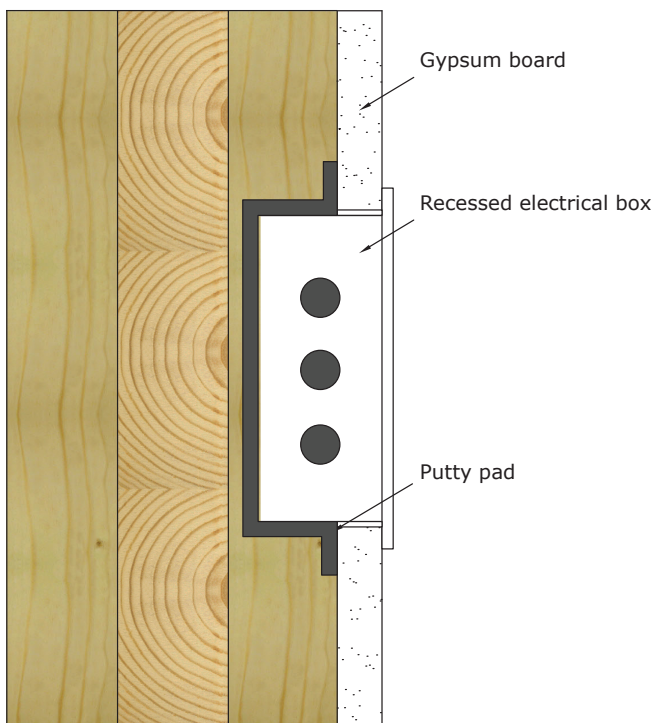

c) Membrane protection in a partial penetration

Figure 15
Through and partial penetration in CLT assemblies

8

NOMENCLATURE

β_{eff}	= effective charring rate (inches/hour)
β_n	= nominal charring rate = 1.5 inches/hour
Δ_f	= deflection due to out-of-plane loading (bending) (in.)
ρ	= density of material (kg / m^3)
a	= thermal penetration depth (mm)
a_{char}	= effective depth of char (in.)
b_i	= unit width of the CLT panel (typically 1 foot)
c	= 0.9 (applicable to glue-laminated timber, as per NDS)
c	= specific heat of material used for heat transfer calculations ($\text{J} / \text{kg}\cdot\text{K}$)
d_i	= distance from the neutral axis to the centroid of ply i (in.)
d_0	= zero-strength layer thickness (in.)
e	= distance from the neutral axis to the centroid of load point (typically at mid-depth) (in.)
h	= initial cross-section depth of the CLT panel (in.)
h_{fire}	= effective cross-section depth (in.)
h_i	= remaining depth of ply i (in.)
h_{lam}	= thickness of a laminate (in.)
k	= thermal conductivity of material ($\text{W} / \text{m}\cdot\text{K}$)
l_c	= effective length, typically equal to the unbraced height of a wall assembly (in.)
n_{lam}	= number of laminations that may fall-off (rounded to lowest integer)
t	= fire exposure time (hours)
t_{fo}	= time to reach a glued interface (hours)
t_{ins}	= fire resistance, insulation requirement (hours)
t_{int}	= fire resistance, integrity requirement (hours)
t_{struc}	= fire resistance, structural requirement (hours)
x	= distance from the char front (mm)
\bar{y}	= distance from the unexposed surface of the panel to the neutral axis (in.)
\bar{y}_i	= distance from the unexposed surface of the panel to the centroid of ply i (in.)

A_{eff}	= area of the effective residual cross-section (in. ²)
C_F	= size factor = 1.0 for CLT components
C_p	= CLT wall stability factor
COV_E	= modulus of elasticity coefficient of variation (as per NDS)
D	= applied permanent (dead) load (lb./ft. ² or lb./ft.)
E	= modulus of elasticity of the ply that sustains the greatest tensile stress, typically E_i (psi)
E_i	= modulus of elasticity of the ply i in the major strength axis (psi)
E_{90i}	= modulus of elasticity of the ply i in the minor strength axis (psi)
E_{min}	= modulus of elasticity for column stability design (as per NDS) (psi)
E'_{min}	= adjusted modulus of elasticity of the ply i in the major strength axis (psi)
EI_{eff}	= effective bending stiffness (lb.-in. ²)
EI'_{min}	= $E'_{\text{min}} I_{\text{eff}}$
F_b	= bending stress design value of the wood (Tables 4A, 4B, 4C or 4F of NDS)
F_{bE}	= beam buckling stress design value of the wood (Tables 4A, 4B, 4C or 4F of NDS)
F_c	= axial compression stress design value of the wood (Tables 4A, 4B, 4C or 4F of NDS)
F_t	= tensile stress design value of the wood (Tables 4A, 4B, 4C or 4F of NDS)
G_0	= shear modulus of the ply in the major strength axis (psi)
G_{90}	= shear modulus of the ply in the minor strength axis (psi)
I_{eff}	= moment of inertia of the effective residual cross-section (in. ⁴)
K	= adjustment factor as per Table 4 and NDS
K_j	= CLT panel-to-panel joint coefficient = 0.35 for half-lapped joints
L	= applied live load (lb./ft. ² or lb./ft.)
M	= maximum induced moment (lb.-in.)
M'	= design resisting moment in fire design (lb.-in.)
P	= axial compression load (lb.)
P_{cE}	= $\frac{\pi^2 EI'_{\text{min}}}{L_e^2}$ = resisting critical buckling capacity in fire design (lb.)
P^*_c	= $KF_c * A_{\text{eff}} = 2.58F_c * A_{\text{eff}}$ (as per Table 4 and NDS) (lb.)
P'	= resisting axial compression capacity in fire design (lb.)
Q	= rate of heat consumption per unit volume due to chemical reaction (W / m ³)
R_{ASD}	= allowable design capacity as per NDS
S_{eff}	= effective section modulus (in. ³)
T	= temperature (°C)
T_i	= initial temperature (°C)
T_p	= char front temperature (°C)
$\partial T / \partial t$	= temperature as a function of time t (K / s)
$\partial T / \partial x$	= temperature in the x-direction (K / m)
$\partial T / \partial y$	= temperature in the y-direction (K / m)
$\partial T / \partial z$	= temperature in the z-direction (K / m)

9

SPECIAL THANKS

The authors wish to express their thanks to FPInnovations' industry members Julie Frappier, Eng. from Nordic Engineered Wood and Andre Morf from Structurlam, and to Dr. Nourredine Bénichou of the National Research Council of Canada.

Special thanks to those who reviewed the Chapter and provided valuable comments. Specifically, the authors would like to thank Sam Francis of the American Wood Council, James Churchill, P.E. of Churchill Engineering Inc., Joe McElvaney from the City of Phoenix and Prof. Dr. Andrea Frangi from the Institute of Structural Engineering of ETH Zurich. The authors are also grateful for the extensive review and valuable comments made by Bradford Douglas from the American Wood Council.

10

REFERENCES

- [1] ICC. 2009. *International building code*. Washington, DC: International Code Council.
- [2] NFPA. 2012. *Building construction and safety code*. NFPA 5000. Quincy, MA: National Fire Protection Association.
- [3] ANSI. 2011. *Standard for performance-rated cross-laminated timber*. ANSI/APA PRG 320-2011. New York, NY: American National Standards Institute.
- [4] NFPA. 2012. *Guide to the Fire Safety Concepts Tree*. NFPA 550. Quincy, MA: National Fire Protection Association.
- [5] ICC. 2009. *International fire code*. Washington, DC: International Code Council.
- [6] NFPA. 2012. *Fire code*. NFPA 1. Quincy, MA: National Fire Protection Association.
- [7] A. Frangi, M. Fontana, E. Hugi and R. Jöbstl. 2009. Experimental analysis of cross-laminated timber panels in fire. *Fire Safety J.* 44 (8):1078-1087.
- [8] A. Frangi, G. Bochicchio, A. Ceccotti and M.P. Lauriola. 2008. Natural full-scale fire test on a 3-storey XLam timber building. Paper presented at the *World Conference on Timber Engineering*, 2008, Miyazaki, Japan.
- [9] NFPA. 2013. *Standard for the installation of sprinkler systems*. NFPA 13. Quincy, MA: National Fire Protection Association.
- [10] ASTM. 2012. *Standard test methods for fire tests of building construction and materials*. ASTM E119-12. West Conshohocken, PA: ASTM International.
- [11] UL. 2011. *Fire tests of building construction and materials*. UL 263. Canmas, WA: Underwriters Laboratories Inc.
- [12] ULC. 2007. *Standard method of fire endurance tests of building construction materials*. ULC S101-07. Toronto, ON: Underwriters Laboratories of Canada.
- [13] ISO. 1999. *Fire-resistance test - Elements of building construction - Part 1 : General requirements*. ISO 834-1. Geneva, Switzerland: International Standard Organization.
- [14] AF&PA. 2005. *National design specification (NDS) for wood construction*. Washington, DC: American Forest & Paper Association.
- [15] ASTM. 2008. *Standard practice for calculating the superimposed load on wood-frame walls for standard fire-resistance tests*. ASTM D6513-08. West Conshohocken, PA: ASTM International.
- [16] ASTM. 2011. *Standard practice for calculating the superimposed load on wood-frame floor-ceiling assemblies for standard fire-resistance tests*. ASTM D7746-11. West Conshohocken, PA: ASTM International.
- [17] AF&PA. 2003. *Calculating the fire resistance of exposed wood members*. Technical Report 10. Washington, DC: American Forest & Paper Association.

- [18] ASTM. 2003. *Standard practice for evaluating allowable properties for grades of structural lumber*. ASTM D2915-03. West Conshohocken, PA: ASTM International.
- [19] R.H. White. 1992. Charring rate of wood for ASTM E119 exposure. *Fire Technology* 28 (1):5-30.
- [20] AITC. 2008. *Standard for adhesives for use in structural glued laminated timber*. AITC 405. Centennial, CO: American Institute of Timber Construction.
- [21] ASTM. 2006. *Standard test method for multiple-cycle accelerated aging test (automatic boil)*. ASTM D3434-00(2006). West Conshohocken, PA: ASTM International.
- [22] CSA. 2010. *Evaluation of adhesives for structural wood products (exterior exposure)*. CSA O112.9-10. Mississauga, ON: Canadian Standards Association.
- [23] NIST. 2009. *Structural plywood*. Voluntary Product Standard PS 1. Gaithersburg, MA: National Institute of Standards and Technology.
- [24] L. Osborne, C. Dagenais and N. Bénichou. 2012. Preliminary CLT fire resistance testing report. Project No. 301006155. Ottawa, ON: FPInnovations.
- [25] CEN. 1997. *Adhesives, phenolic and aminoplastic for load-bearing timber structures*. EN 301. Brussels, Belgium: European Committee for Standardization.
- [26] CEN. 2008. *Adhesives - One component polyurethane for load bearing timber structures - Classification and performance requirements*. EN 15425. Brussels, Belgium: European Committee for Standardization.
- [27] R.H. White and M.A. Dietenberger. 2010. Fire safety of wood construction. Chapter 18 in *Wood handbook: Wood as an engineering material*, 18-1 - 18-22. Madison, WI: Forest Products Laboratory.
- [28] ASTM. 2007. *Standard test method for evaluating the shear strength of adhesive bonds in laminated wood products at elevated temperatures*. ASTM D7247-07a. West Conshohocken, PA: ASTM International.
- [29] J. Bodig and B.A. Jayne. 1993. *Mechanics of wood and wood Composites*. New York, NY: Van Nostrand Reinhold Company Inc.
- [30] R.H. White. 2009. Fire resistance of wood members with directly applied protection. Paper presented at the *Eleventh Fire and Materials Conference*, January 26-28, 2009, San Francisco, CA.
- [31] S.T. Craft, R. Desjardins and J.R. Mehaffey. 2011. Investigation of the behaviour of CLT panels exposed to fire. Paper presented at the *Twelfth International Fire and Materials Conference*, San Francisco, CA.
- [32] SFPE. 2008. *The SFPE handbook of fire protection engineering*. 4th ed. Quincy, MA: Society of Fire Protection Engineers.
- [33] L. Lu. 2012. Fire modelling heat transfer computer model of a 3-ply cross-laminated timber board under standard fire exposure using ANSYS. CFS Final Report 3.22. Ottawa, ON: FPInnovations.
- [34] M.L. Janssens and R.H. White. 1994. Short communication: Temperature profiles in wood members exposed to fire. *Fire & Materials* 18:263-265.
- [35] L. Peng, G. Hadjisophocleous, J. Mehaffey and M. Mohammad. 2010. On the fire performance of wood-wood-wood and wood-steel-wood connections using bolts and dowels as fasteners. Paper presented at *Interflam: 12th International Conference on Fire Science and Engineering*, 2010, Nottingham, UK.
- [36] SP Trätekt. 2010. *Fire safety in timber buildings - Technical guideline for Europe*. SP Report 2010:19. Stockholm, Sweden: SP Trätekt (Swedish Institute for Wood Technology Research).
- [37] A. Frangi, C. Erchinger and M. Fontana. 2010. Experimental fire analysis of steel-to-timber connections using dowels and nails. *Fire and Materials* 34:1-19.
- [38] M. Audebert. 2010. Approche expérimentale et modélisation du comportement au feu d'assemblages bois sous différents types de sollicitations. PhD diss., Université Blaise-Pascal - Clermont II, Clermont-Ferrand.
- [39] J. Norén. 1996. Load-bearing of nailed joints exposed to fire. *Fire and Materials* 20:133-143.
- [40] P. Lau. 2006. Fire resistance of connections in laminated veneer lumber (LVL). M.Sc. thesis, University of Canterbury, New-Zealand.

- [41] P. Moss, A.H. Buchanan, M. Fragiaco, P. Lau and T. Chuo. 2009. Fire performance of bolted connections in laminated veneer lumber. *Fire and Materials* 33:223-243.
- [42] P. Moss, A.H. Buchanan, T. Nilsen and M. Fragiaco. 2011. Fire resistance of connections using steel plates and mechanical fasteners in timber structures. *Journal of Structural Fire Engineering* 2:243-258.
- [43] P. Racher, K. Laplanche and D. Dhima. 2006. Thermo-mechanical modelling of the timber connection behaviour under fire. Paper presented at the *Fourth International Workshop Structures in Fire (SiF' 2006)*, Aveiro, Portugal.
- [44] ASTM. 2012. *Standard test method for surface burning characteristics of building materials*. ASTM E84-12. West Conshohocken, PA: ASTM International.
- [45] ASTM. 2012. *Standard test method for critical radiant flux of floor-covering systems using a radiant heat energy source*. ASTM E648-10e1. West Conshohocken, PA: ASTM International.
- [46] NFPA. 2011. *Standard method of test for critical radiant flux of floor covering systems using a radiant heat energy source*. NFPA 253. Quincy, MA: National Fire Protection Association.
- [47] UL. 2008. *Tests for surface burning characteristics of building materials*. UL 723. Canmas, WA: Underwriters Laboratories Inc.
- [48] AWC. 2010. *Design for code acceptance 1: Flame spread performance of wood products*. Washington, DC: American Wood Council.
- [49] NIST. 2010. *American softwood lumber*. Voluntary Product Standard PS 20. Gaithersburg, MD: National Institute of Standards & Technology.
- [50] CSA. 2010. *Softwood lumber*. CSA O141-05. Mississauga, ON: Canadian Standards Association.
- [51] CSA. 2009. *Engineering design in wood*. CSA O86-09. Mississauga, ON: CSA Standards.
- [52] ASTM. 2011. *Standard test method for extended duration surface burning characteristics of building materials (30 min tunnel test)*. ASTM E2768-11. West Conshohocken, PA: ASTM International.
- [53] ULC. 2010. *Standard method of test for surface burning characteristics of building materials and assemblies*. ULC S102-10. Toronto, ON: Underwriters Laboratories of Canada.
- [54] ITS. 2012. Surface burning characteristics of treated cross-laminated timber. Report No. 100712618OQ-001b. Coquitlam, BC: Intertek Testing Services NA Ltd.
- [55] L.R. Richardson and A.A. Cornelissen. 1987. Fire-resistant coatings for roof/ceiling deck timbers. *Fire and Materials* 11:191-194.
- [56] R.H. White. 1984. Use of coatings to improve fire resistance of wood. In *Fire resistive coatings: The need for standards*, 24-39. West Conshohocken, PA: ASTM International.
- [57] R.H. White. 1986. An empirical model for predicting performance of fire-resistive coatings in wood construction. *Journal of Testing and Evaluation* 14 (2):97-108.
- [58] NFPA. 2013. *Standard for the installation of sprinkler systems in residential occupancies up to and including four stories in height*. NFPA 13R. Quincy, MA: National Fire Protection Association.
- [59] NFPA. 2013. *Standard for the installation of sprinkler systems in one- and two-family dwellings and manufactured homes*. NFPA 13D. Quincy, MA: National Fire Protection Association.
- [60] ASTM. 2011. *Standard test method for fire tests of penetration firestop systems*. ASTM E814-11a. West Conshohocken, PA: ASTM International.
- [61] J.K. Richardson, J.D. Quirt and R. Hlady. 2007. Best practice guide on fire stops and fire blocks and their impact on sound transmission. NRCC-49677. Ottawa, ON: National Research Council Canada.
- [62] J. Schmid, J. König and J. Kohler. 2010. Design model for fire exposed cross-laminated timber. Paper presented at the *Sixth International Conference on Structures in Fire*, June 24, 2010, Michigan State University, East Lansing, MI.

- [63] CEN. 2004. *Eurocode 5 : Design of timber structures - Part 1-2 : General - Structural fire design*. Brussels, Belgium: European Committee for Standardization.
- [64] CEN. 2003. *Eurocode 0 : Basis*. Brussels, Belgium: European Committee for Standardization.
- [65] S. Craft. 2011. Fire performance of cross-laminated timber. Chapter 8 in *CLT handbook*. Québec, QC: FPInnovations.
- [66] AF&PA. 2006. Fire design. Chapter M16 in *ASD/LRFD manual for engineered wood construction*. 2005 ed. Washington, DC: American Forest & Paper Association.
- [67] S. Gagnon, and C. Pirvu, eds. 2011. *CLT handbook: Cross-laminated timber*. Canadian ed. Special Publication SP-528E. Quebec, QC: FPInnovations.

APPENDIX I

ADDITIONAL INFORMATION

European Calculation Design Procedure

There is a very limited quantity of full-scale fire resistance tests performed with CLT constructions. An adapted methodology for CLT assemblies has thereby been developed in Europe and is currently being used on proprietary basis by European CLT manufacturers [7, 62]. The European model follows the same principles as those prescribed in Eurocode 5: part 1-2 [63] applicable to timber components. However, it evaluates only the loadbearing function of CLT assemblies based on a one-dimensional charring rate. As of 2012, this new method has yet to be implemented into the European regulatory environment.

The design procedure prescribed in Eurocode 5: part 1-2 allows calculating the structural and the integrity requirements of timber components. The structural requirement can be determined using the reduced cross-section method using a constant charring rate as a function of time. The constant charring rate is however only valid for elements unprotected throughout the time of fire exposure. An advanced procedure for predicting the char rate of timber initially protected can also be found in Eurocode 5: part 1-2.

The European fire-resistance calculation method uses a strength adjustment factor (k_f), a modification factor for fire design ($k_{mod,fi}$) and a partial safety factor for fire design ($\gamma_{M,fi}$) as well as a zero-strength layer (d_0) of 7 mm ($^{9}/_{32}$ in.) to account for the wood heated zone (assumed to provide no strength, nor rigidity). According to Schmid et al. [62], the zero-strength layer for CLT assemblies should however be taken as 10 mm ($^{25}/_{64}$ in.) for floors and 16 mm ($^{5}/_{8}$ in.) for walls, and is a function of the number of plies, residual thickness, whether the assembly is protected or unprotected, and the stress distribution (exposed side in tension or compression). The strength adjustment factor allows converting the 5th percentile strength property to the 20th percentile in normal conditions and is based on products' coefficient of variation. For example, a solid timber beam would have a strength adjustment of 1.25 while a glued-laminated timber (who typically exhibits a lower COV than timber) would have a 1.15 strength adjustment factor. The modification and partial safety factors are both set to unity in fire design. Furthermore, a combination factor for quasi-permanent action ($\psi_{2,1}$) ranging from 0.3 to 0.8 depending on the building occupancy group in accordance with Eurocode 0 [64] is also recommended, thus providing a reduced load combination for fire design.

Furthermore, Eurocode 5: part 1-2 also prescribes a joint coefficient (k_j) for determining the integrity fire resistance of timber cladding and gypsum boards having gaps not more than roughly 2 mm ($^{1}/_{12}$ in.), similarly to Equation 19 of this Chapter. Profiles such as half-lapped joints greater than 30 mm ($1\ ^{3}/_{16}$ in.), single tongue-and-groove greater than 15 mm ($^{5}/_{8}$ in.), internal spline greater than 30 mm ($1\ ^{3}/_{16}$ in.) and double tongue-and-grooves have assigned joint coefficient (k_j) of 0.3, 0.4 and 0.6, respectively. The joint coefficient may also be set to unity when additional floor covering or wall sheathing is used over the joint.

The European method also stipulates that the requirements with respect to integrity are assumed to be satisfied where the requirements with respect to insulation have been satisfied and panels remain fixed to the timber frame on the unexposed side.

Canadian Calculation Design Procedure

More recently, a Canadian fire-resistance design method has been published in 2011 and is largely based on the European model [65]. The Canadian model, as of 2011, evaluates only the loadbearing function of CLT assemblies. Further investigations have been carried out by FPInnovations and the National Research Council of Canada in an attempt to better understand fire behavior of CLT assemblies in fire conditions. It has been found that integrity (i.e., panel-to-panel connection) is one of the predominant failure modes of CLT floor assemblies under load [24]. Such failure mode was not observed in CLT wall assemblies under load. The latter usually exhibits buckling due to second-order effects (i.e., $P-\Delta$ effects). The future edition of the Canadian CLT Handbook will address the fire integrity performance of CLT assemblies in a similar manner as it will be addressed in Subsection 4.1.5 of this Chapter.

It should be noted that both European and Canadian methods follow the limit states design philosophy, which is similar, to a certain degree, to the Load & Resistance Factor Design (LRFD) prescribed in [66]. Therefore, such methods should not be used in the United States when using the Allowable Stress Design (ASD) philosophy.



Sound

Sound insulation of
cross-laminated timber assemblies

CHAPTER 9

Authors

Lin Hu, Ph.D., FPInnovations
David L. Adams, P.E., FASA, D. L. Adams Associates, Inc.

Peer Reviewers

Bradford Douglas, P.E., American Wood Council
Ciprian Pirvu, Ph.D., P.Eng., FPInnovations
Jean-Luc Kouyoumji, Ph.D., FCBA, France

ACKNOWLEDGEMENTS

The U.S. Edition of the CLT Handbook: *cross-laminated timber* combines the work and knowledge of American, Canadian and European specialists. The handbook is based on the original Canadian Edition of the CLT Handbook: *cross-laminated timber*, that was developed using a series of reports initially prepared by FPInnovations and collaborators to support the introduction of CLT in the North American market. A multi-disciplinary team revised, updated and implemented their know-how and technologies to adapt this document to U.S. standards.

The publication of this handbook was made possible with the special collaboration of the following partners:



The editing partners would also like to express their special thanks to Binational Softwood Lumber Council, Forestry Innovation Investment (FII), Nordic Engineered Wood, Structurlam, and CLT Canada for their financial contribution to studies in support of the introduction of cross-laminated timber products in the United States of America.



© 2013 FPInnovations and Binational Softwood Lumber Council. All rights reserved.

The U.S. Edition of the CLT Handbook: *cross-laminated timber* can be electronically downloaded without charge from the website www.masstimber.com. Additional information can be obtained by visiting the websites of FPInnovations, USFPL, American Wood Council (AWC), APA and U.S. WoodWorks. Hard copies can be obtained through AWC (www.awc.org).

No part of this published Work may be reproduced, published, or transmitted for commercial purposes, in any form or by any means, electronic, mechanical, photocopying, recording or otherwise, whether or not in translated form, without the prior written permission of FPInnovations and Binational Softwood Lumber Council.

The information contained in this Work represents current research results and technical information made available from many sources, including researchers, manufacturers, and design professionals. The information has been reviewed by professionals in wood design including professors, design engineers and architects, and wood product manufacturers. While every reasonable effort has been made to insure the accuracy of the information presented, and special effort has been made to assure that the information reflects the state-of-the-art, none of the above-mentioned parties make any warranty, expressed or implied, or assume any legal liability or responsibility for the use, application of, and/or reference to opinions, findings, conclusions, or recommendations included in this published work, nor assume any responsibility for the accuracy or completeness of the information or its fitness for any particular purpose.

This published Work is designed to provide accurate, authoritative information but is not intended to provide professional advice. It is the responsibility of users to exercise professional knowledge and judgment in the use of the information.

ABSTRACT

The intent of this Chapter is to answer simple questions related to the definition of sound, its sources, quantification and methods of measurement, acceptable levels of sound, differences between sound and noise, etc. Of course, when verbalizing such questions, the solutions for sound control will be naturally unfolded to readers.

This Chapter is intended to thoroughly separate myth from reality. The Chapter also introduces the International Building Code (IBC) requirements for sound insulation in buildings. State of the art construction details for CLT walls and floor/ceiling assemblies generally meeting IBC requirements are provided herein and are based on results of tests performed in various laboratories in the world and in the field by FPInnovations. A step by step construction practices guide then leads the reader towards the final goal, which is the occupants' satisfaction. We expect that after reading this Chapter, the reader will be in a position to acknowledge that CLT buildings can achieve satisfactory sound insulation levels if proper design and installation are followed. Note that, considering the short history of CLT construction, the journey is only beginning.

TABLE OF CONTENTS

Acknowledgements	ii
Abstract	iii
List of Tables	vi
List of Figures	vii
1	Introduction 1
2	Fundamentals 2
2.1	Sound and its Source 2
2.2	Quantification of Sound and Measurement 3
2.2.1	Sound Pressure 3
2.2.2	Sound Pressure Level (SPL) 4
2.2.3	Measurement and Spectrum Analysis 5
2.3	Human Hearing and Perception 6
2.3.1	Audible Frequency Range and Auditory Area of Sound 6
2.3.2	Human Perception of Sound 6
2.3.3	Human Perception of Sound Level Change 6
2.4	Building Sound Insulation 7
2.4.1	Human Activity Induced Sound 7
2.4.2	Flanking Transmission 7
2.4.3	Sound Insulating Performance of Walls and Floor/Ceiling Assemblies Using a Single Number Rating 9
2.4.3.1	Determination of STC and IIC in the Laboratory 10
2.4.3.2	Determination of FSTC and FIIC in Buildings 11
2.4.3.3	General Factors Affecting STC and IIC 12
3	Acoustic Properties of Bare CLT Walls and Floors 13
4	International Building Code (IBC) Requirements for Sound Insulation of Demising Walls and Floor/Ceiling Assemblies 15
5	Examples of Construction Solutions for CLT Walls and Floors Meeting IBC's STC and IIC Requirements 16

6	Examples of Construction Solutions for CLT Walls and Floor/Ceiling Assemblies Meeting IBC's FSTC and FIIC Requirements	28
7	The Best Practices for Ensuring Occupants' Satisfaction - Step by Step Guide	35
7.1	Step 1: Selecting Construction Solutions for FSTC and FIIC 50	35
7.2	Step 2: Eliminating Avoidable Flanking Paths	35
7.3	Step 3: Measuring FSTC and FIIC after Finishing	36
8	Conclusion	37
9	Recommendation	38
10	References	39

List of Tables

- Table 1* Sound generated by various sources and their pressure 4
- Table 2* Perceptible change due to the change in sound level (dB) 7
- Table 3* Area mass of some CLT elements for wall and floor applications 13
- Table 4* Sound insulation performance of bare CLT floors and walls 14
- Table 5* IBC minimum requirements for sound insulation of demising walls and floor/ceiling assemblies 15
- Table 6* STC of CLT wall assemblies 17-18
- Table 7* STC and IIC of CLT floor assemblies without a ceiling 19-20
- Table 8* STC and IIC of CLT floors without topping and with only a ceiling 21
- Table 9* STC and IIC of CLT floors with flooring and ceiling 23
- Table 10* STC and IIC of CLT floors with topping and ceiling complete CLT building-1 24-25
- Table 11* STC and IIC of CLT floors with topping and ceiling in CLT building-2 without finishing 26-27
- Table 12* FSTC of CLT wall assemblies in complete CLT building-1 29
- Table 13* FSTC of CLT wall assemblies in CLT building-2 without finishing 30
- Table 14* FSTC and FIIC of CLT floors with flooring and a suspended ceiling 31-33
- Table 15* FSTC and FIIC of CLT floors with flooring and topping, wood exposed on ceiling side 34
- Table 16* Flanking path check list and general treatment; not limited to CLT buildings 36

List of Figures

- Figure 1* Simplified illustration of sound (pressure wave) propagation through air/solid structure 3
- Figure 2* Relationship between a power ratio and the decibel (dB) 4
- Figure 3* Sound pressure in linear and sound pressure level in dB 5
- Figure 4* Typical spectrum of sound pressure level measured below a wood-framed floor/ceiling assembly using a tapping machine and a sound level meter 5
- Figure 5* Range of human hearing 6
- Figure 6* Example of sound leak due to the cracks at the floor and wall junction and treatment 8
- Figure 7* Sound leak at the electrical outlets 8
- Figure 8* Floor surface as flanking path 9
- Figure 9* Simple illustration of laboratory acoustic chambers for testing walls 10
- Figure 10* Simple illustration of an acoustic chamber and impact insulation test on a floor 11
- Figure 11* Field wall sound transmission test for FSTC 11
- Figure 12* Field floor impact sound insulation test for FIIC using an ISO tapping machine 12
- Figure 13* Sound isolation clip (a) and resiliently suspended gypsum board ceiling from CLT floor with sound isolation clips supporting metal hat channels and gypsum boards (b) 22

1

INTRODUCTION

This Chapter addresses sound insulation for demising walls, partitions and floor/ceiling assemblies between adjacent spaces, such as dwelling units; and between dwelling units and adjacent public areas, such as halls, corridors, stairs or service areas in buildings employing CLT construction.

2

FUNDAMENTALS

Because it is too vast to cover, a complete knowledge of the fundamentals of acoustics will not be presented here. This section intends to provide basic information about what lies behind the building code requirements concerning sound insulation and specific solutions provided by CLT buildings.

2.1 Sound and its Source

Acoustics is typically defined as the science of sound. Acoustics is the interdisciplinary science that deals with the study of all mechanical waves in gases, liquids, and solids including vibration, sound, ultrasound and infrasound. A scientist who works in the field of acoustics is an acoustician while someone working in the field of acoustics technology may be called an acoustical engineer, although these terms are often used interchangeably. The application of acoustics can be seen in almost all aspects of modern society, with the most obvious being the audio and noise control industries.

Now, we might ask, what is sound and where does it come from? Sound has been defined as a physical disturbance in an elastic medium (i.e., in a gas, liquid, or solid) that is capable of being detected by the human ear. The medium in which the sound or pressure waves travel must have mass and elasticity. Thus, sound waves will not travel through a vacuum (Harris, 1991).

Sound waves in air are caused by variations in pressure above and below the static value of atmospheric pressure (Harris, 1991). These pressure variations originate in many ways, for example: 1) by a pulsating airstream, e.g., that produced by fan blades as they rotate, by a loudspeaker, etc.; 2) by supersonic flight of an aircraft, which creates shock waves; 3) by the vibration of a surface, such as wall or partition; and 4) by talking or by a musical instrument.

A pressure wave propagating through air is referred to as airborne sound while the pressure wave propagating through a solid structure is referred to as structure-borne sound. Figure 1 illustrates the propagation of pressure wave through both air and a solid structure (Kappagantu, 2010). It must be pointed out that, for the sake of simplicity, Figure 1 only illustrates a simple harmonic sound wave, which can be generated by most musical instruments that produce several simple harmonics simultaneously. On the other hand, sound produced by machines or structures do not behave as simple harmonic sound waves, they rather are random in time and are commonly known as noise (Crocker, 2007).

More basically, noise is commonly defined as “unwanted sound”; however, what might be noise to one person could be a valuable source of aural information to another. For example, consider the sound produced by a machine in a factory. To the office worker trying to concentrate on some mental task in an adjacent office, it is noise; whereas, to the operator of the machine, the sound provides him or her with audible clues as to whether the machine is operating properly or not.

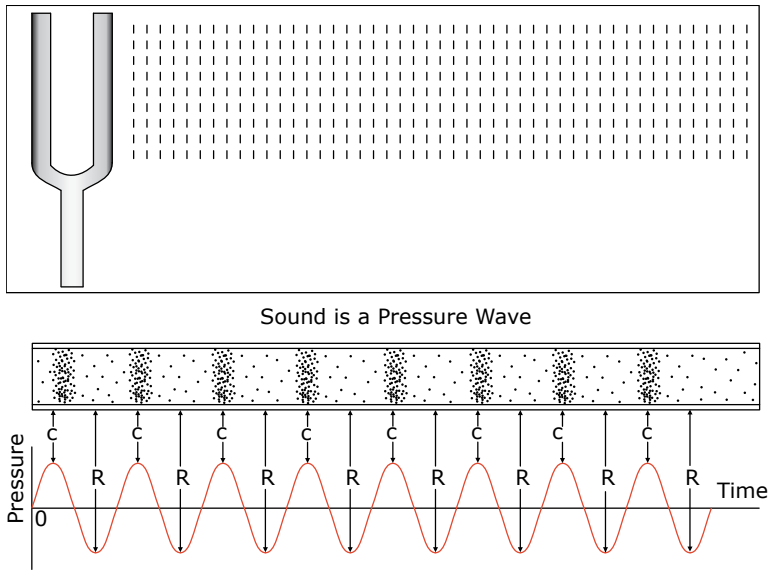

Note: In this figure, C signifies regions of compression and R signifies regions of rarefaction of the air molecules. Furthermore, the “0” pressure line in the graph represents the atmospheric pressure level.

Figure 1

Simplified illustration of sound (pressure wave) propagation through air/solid structure (Kappagantu, 2010)

2.2 Quantification of Sound and Measurement

2.2.1 Sound Pressure

Sound has numerous attributes and can be described by various quantities. Sound has level or magnitude. Sound has frequency content. And sound can vary in level and frequency as a function of time. With respect to the level or magnitude of sound, the most commonly used metric that can be directly measured is sound pressure. Other quantities can also be derived from sound pressure. Sound pressure is the pressure variation above and below the atmospheric pressure (Crocker, 2007). Sound pressure is a fluctuating quantity measured in Pascal units (Pa). Sound pressure is influenced by the energy produced by the sound source, the environment, and the distance between the source and the receiver (Pope, 2003). It is usually characterized by its Root Mean Square (RMS) or Peak values, with mean pressure disregarded (Pope, 2003).

To convey an understanding of sound pressure, Pope (2003) gave some examples of the sound produced by various sources and their pressure (Table 1).

Table 1

Sound generated by various sources and their pressure (Pope, 2003)

Source of Sound	RMS Pressure (Pa)
Music club (loud)	~ 10
Heavy traffic at 32.81 ft. (10 m)	~ 1
Busy office	~ 10 ⁻¹
Normal speech at 3.28 ft. (1 m)	~ 10 ⁻²

2.2.2 Sound Pressure Level (SPL)

Sound pressure is related to atmospheric pressure at the point where the sound pressure is measured. In contrast, sound is better quantified using absolute values independent of the atmospheric pressure for comparison of sound performance in various atmospheres. Therefore, sound pressure level is used. Sound pressure level (SPL) is the power ratio of sound pressure to a reference sound pressure. The unit of SPL is the decibel (dB), which unit is read on a logarithmic scale. Figure 2 demonstrates the relationship between the power ratio and dB.

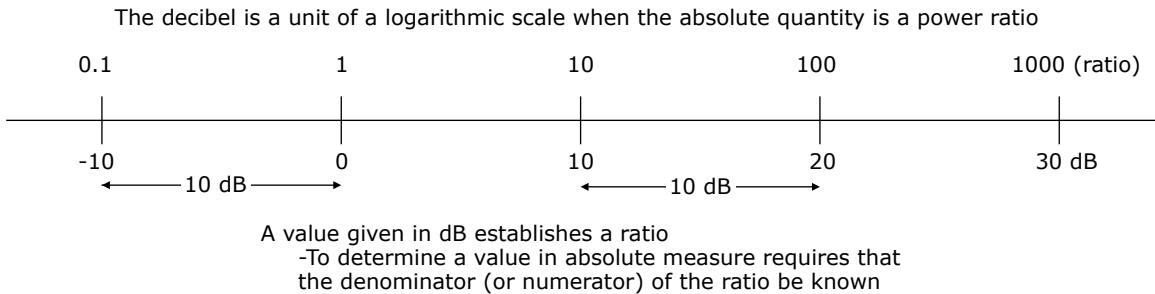
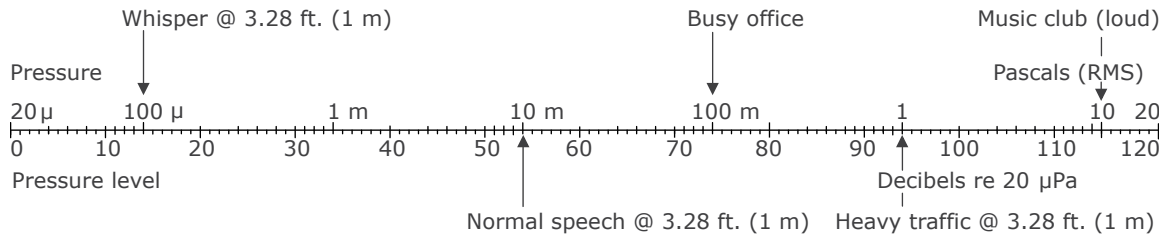

Figure 2

Relationship between a power ratio and the decibel (dB)(Pope, 2003)

As an explanation of why we use the logarithmic decibel scale rather than a linear scale, White (1975) stated the following: *“Because both the human ear and our acoustical instruments respond to changes in pressure, it is desirable to have a scale that will measure these changes in convenient notation. Since the ear can detect changes in pressure amplitude of 1,000,000 to 1, the scale should encompass a large dynamic range. Furthermore, it would be desirable if the physically measureable scale of pressure increments corresponded to our auditory perception of increasing “loudness.” The decibel scale satisfies both of these requirements, being formulated from observations and experiments in both physiology and electrical engineering.”*

Figure 3 illustrates the range of sound pressure in linear and dB scales corresponding to the range given in Table 1.



There is a one-to-one correspondence between pressure and pressure level

Figure 3
Sound pressure in linear and sound pressure level in dB (Pope, 2003)

2.2.3 Measurement and Spectrum Analysis

Sound pressure level can be measured with a Sound Level Meter (SLM). Another useful measuring instrument is the spectrum analyzer, which measures and presents sound pressure level as a function of frequency. With this instrument, sound level versus time signal is transformed into the frequency domain for spectrum analysis. It produces the frequency distribution of the sound pressure level of the signal. Spectrum analysis is important for understanding the behavior of sound and for developing noise control measures. Figure 4 shows a spectrum of a sound pressure level measured in a condominium located below another condominium in a wood-framed floor/ceiling assembly with a running ISO tapping machine on the floor. The graph shows how the measured sound pressure level varied with frequency.

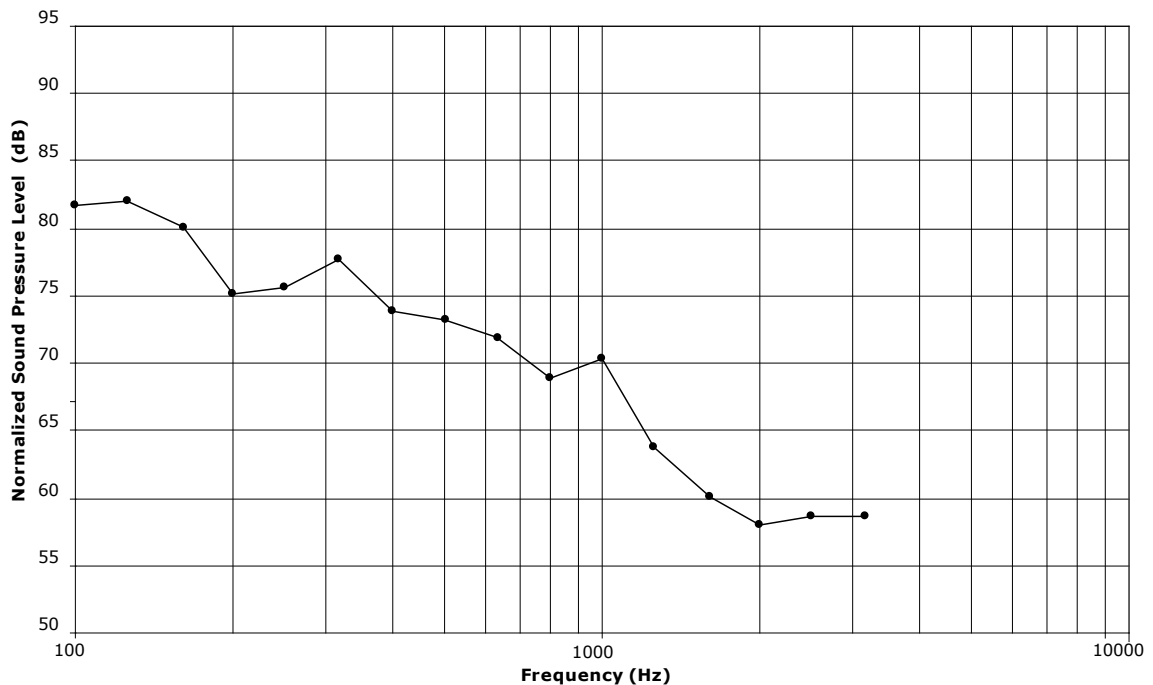

Figure 4
Typical spectrum of sound pressure level measured below a wood-framed floor/ceiling assembly using a tapping machine and a sound level meter

2.3 Human Hearing and Perception

2.3.1 Audible Frequency Range and Auditory Area of Sound

According to Crocker (2007), humans can hear sound in the frequency range between 15-16 Hz and 15-16 kHz. However, humans do not hear all sounds equally, meaning their hearing sensitivity is nonlinear. The sensitivity of human hearing is frequency- and sound pressure level-dependent. Humans are most sensitive to sounds at about 4000 Hz, and less sensitive to sounds below 200 Hz. Below that level, humans cannot hear sound well, unless the sound pressure level is high enough (Crocker, 2007). Figure 5 from White (1975) shows the average threshold curve for young adults with “normal” hearing. Note that the threshold of hearing is markedly dependent on frequency.

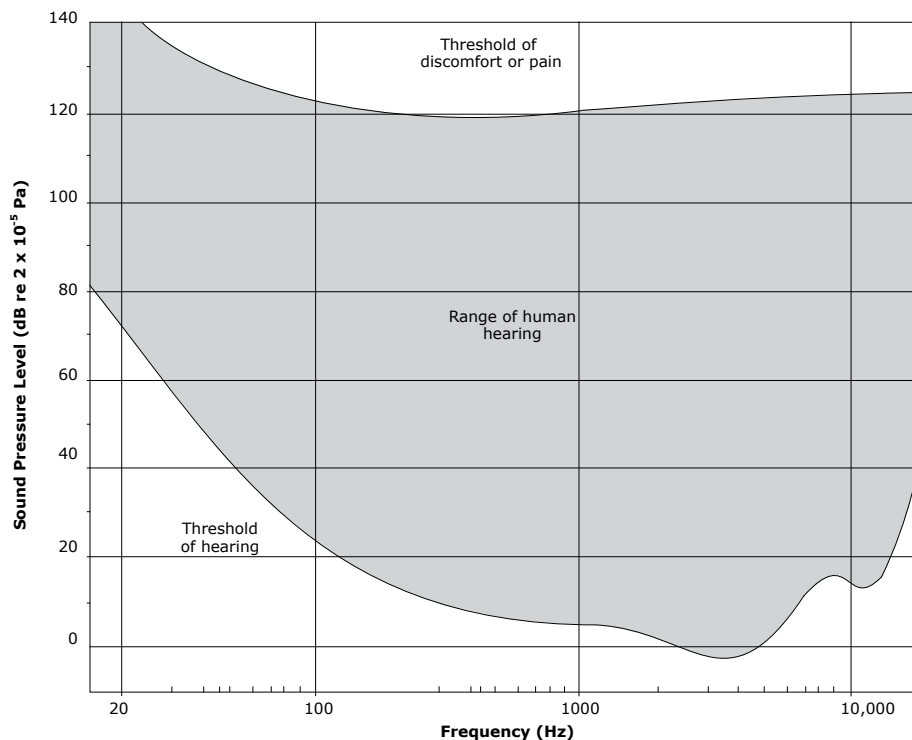

Figure 5
Range of human hearing (White, 1975)

2.3.2 Human Perception of Sound

Human perception of sound is both objective and subjective and several factors affect it:

- Level and frequency spectrum, sharpness, masking effects;
- Variations such as fluctuation, roughness, modulations, transients;
- Context such as day vs. night, music vs. machine, etc.;
- Individual preferences.

2.3.3 Human Perception of Sound Level Change

Pope (2003) described how humans perceive change in sound levels (Table 2). This knowledge is very useful to guide us to develop cost effective sound insulation solutions or to improve existing sound insulation strategies. Table 2 shows that a change (reduction or increase) in sound level of less than 3 dB will most likely not be perceived by a listener, while a change of 3 dB or greater will most likely be perceived by most people.

Table 2

Perceptible change due to the change in sound level (dB) (Pope, 2003)

Change in Sound Level (dB)	Change in Perceived Loudness
3	Just perceptible
6	Noticeable difference
10	Twice as loud, or reduced to half of the loudness
15	Three times as loud, or reduced to one third of the loudness
20	Four times as loud, or reduced to one quarter of the loudness

2.4 Building Sound Insulation

2.4.1 Human Activity Induced Sound

Building acoustics is a vast research area. This section focuses on the sound induced by human activities inside buildings such as talking, playing music, listening to the TV and radio, using various devices, and walking. The building sound insulation discussed below is limited to the interior building components such as common interior or demising walls, partitions and floor/ceiling assemblies between adjacent dwelling units or between dwelling units and adjacent public areas such as halls, corridors, stairs or service areas. Before further discussing sound insulation, it is important to first raise awareness on the unavoidable presence of flanking transmission in buildings.

2.4.2 Flanking Transmission

Flanking transmission is the sound transmission along paths other than the direct path through the common wall or floor/ceiling assembly (Institute for Research in Construction (IRC) of Canada, 2002).

Typical flanking sound transmission paths can include:

- Above and through the ceiling (plenum) spaces;
- Through floor deck and floor joist space;
- Through windows and doors;
- Through fixtures and electrical outlets, light switches, telephone outlets, and recessed lighting fixtures;
- Shared structural building components, such as floor boards, floor joists, continuous drywall partitions, continuous concrete floors, and cement block walls;
- Perimeter joints at wall and floor, through wall and ceiling junctions;
- Through plumbing chases and joints between the walls and floor slab above or at the exterior wall juncture;
- Around the edges of partitions through the adjacent wall.

Some examples of flanking paths are given hereafter. The IRC (2002) found that sound leaks may allow sound to bypass a wall or floor/ceiling assembly. The common problematic zones are cracks at wall/floor junctions, electrical outlets, tubs, medicine cabinets, etc. Figures 6 and 7 illustrate such problems and treatments (IRC, 2002). Figure 8 gives an example of how the floor surface can be a flanking path.

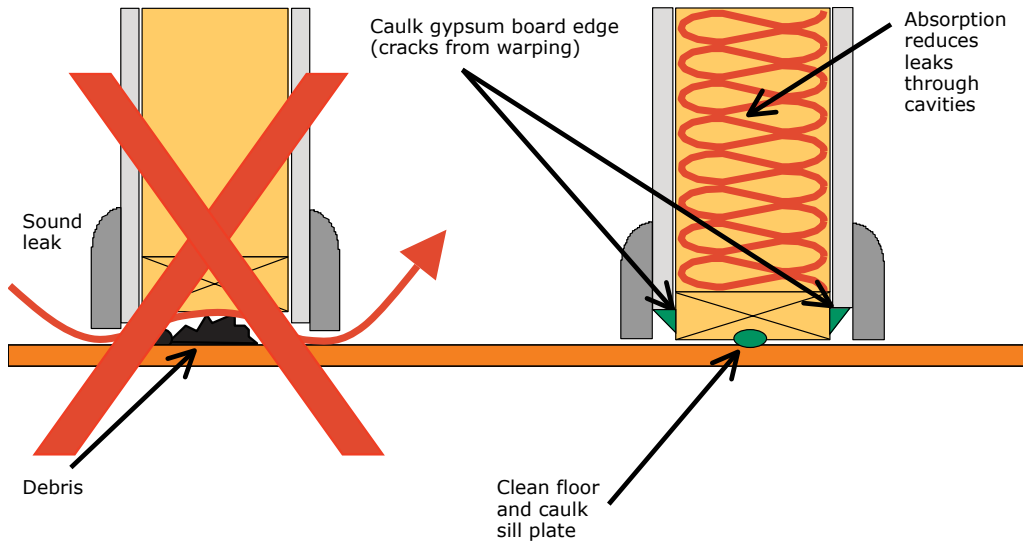

Figure 6
 Example of sound leak due to the cracks at the floor and wall junction and treatment (IRC, 2002)

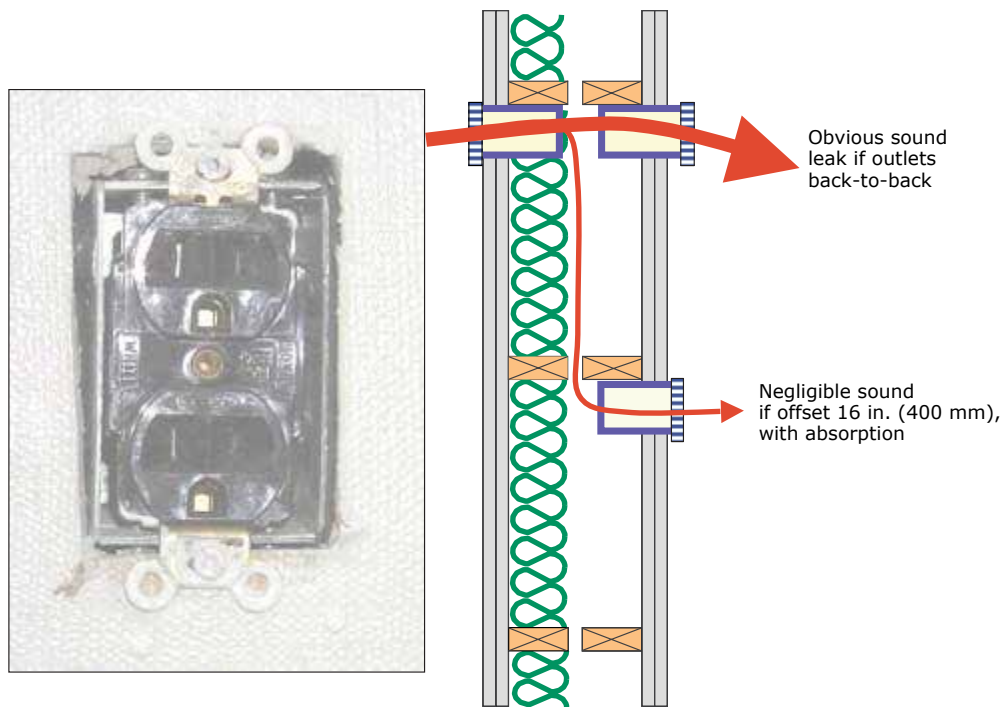
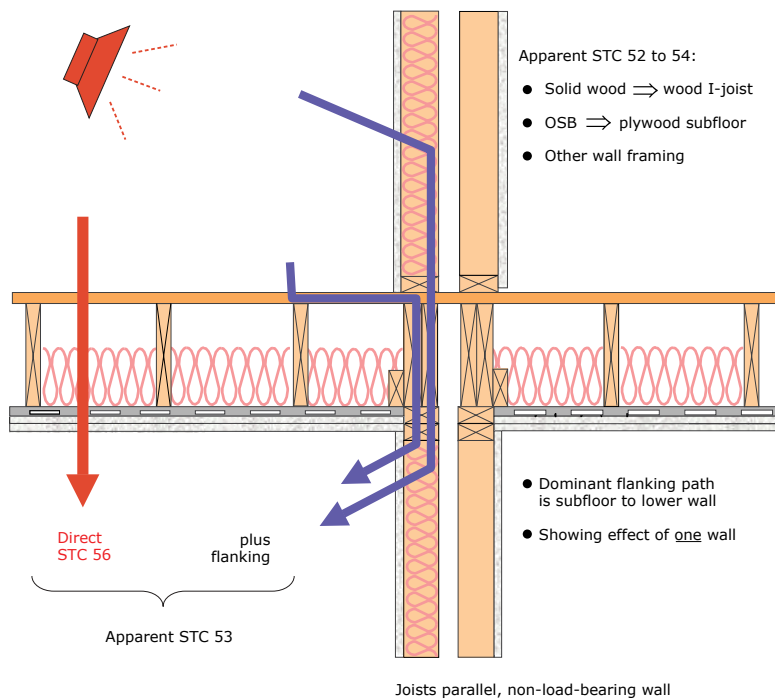

Figure 7
 Sound leak at the electrical outlets (IRC, 2002)



Note: the red arrow indicates the direct path, and blue arrows indicate the flanking path

Figure 8

Floor surface as flanking path (IRC, 2002)

Many studies have been conducted on flanking and methods to control this phenomenon. Section 7 of this Chapter summarizes the findings so far, including significant flanking paths and their treatments.

Flanking always exists to some degree in buildings (IRC, 2002). As demonstrated in Figure 8, flanking reduces the sound insulation performance of a separation in a building. Therefore, a high performance floor/ceiling assembly or wall does not guarantee good sound isolation unless proper attention has been given to eliminating or minimizing flanking paths.

2.4.3 Sound Insulating Performance of Walls and Floor/Ceiling Assemblies Using a Single Number Rating

The airborne sound insulating performance of a wall or a floor/ceiling assembly is measured by sound transmission loss through the wall or floor/ceiling assembly. Transmission Loss (TL) is the ratio of transmitted power over incident power, measured in dB. TL is the measure of sound attenuation through the wall or floor/ceiling assembly. The greater the TL value, the less sound is transmitted through the wall or floor/ceiling assembly, and the better the sound insulation of the wall or floor/ceiling assembly will be. Like sound pressure level, TL varies with frequency.

The single number rating of the airborne sound insulation of a building element, e.g., a wall or a floor/ceiling assembly is called Sound Transmission Class (STC). The greater the STC, the better the airborne sound insulation of the wall or the floor/ceiling assembly.

Similarly, the single number rating for the impact sound insulating performance of a floor/ceiling assembly is called Impact Insulation Class (IIC). As stated in ASTM E989, the greater the IIC value, the greater the impact sound insulation will be.

One should note that both STC and IIC ratings are just that—ratings. These ratings allow us to say one construction is better than another in terms of airborne or impact sound insulation and to judge which might be better in a certain situation. To fully understand the sound insulating performance of walls and floor/ceiling assemblies, please refer to the actual laboratory or field TL or SPL spectrum of the test. It also should be known that for floor/ceiling assemblies, there is no correlation between STC and IIC; a good STC does not guarantee good IIC, and vice versa (IRC, 2002). One such example is the case of a lightweight wood-framed floor/ceiling assembly with a carpet. This type of assembly can have a good IIC, but the STC can be very low due to lack of mass. On the other hand, a lightweight wood-framed floor/ceiling assembly layered with a 1.5 in. (38 mm) thick concrete topping directly poured on the subfloor, but without a carpet or floating flooring, can have a good STC, but very poor IIC due to the hard surface.

2.4.3.1 Determination of STC and IIC in the Laboratory

ASTM E90 standard specifies the test method for laboratory measurement of airborne sound transmission loss of building partitions and elements. This method requires conducting the test under ideal conditions, which means no flanking. Figure 9 (Harris, 1957) illustrates such a test for a wall between two adjacent reverberant chambers. The chambers for testing floor/ceiling assemblies are similar, but the two reverberant rooms are vertically stacked.

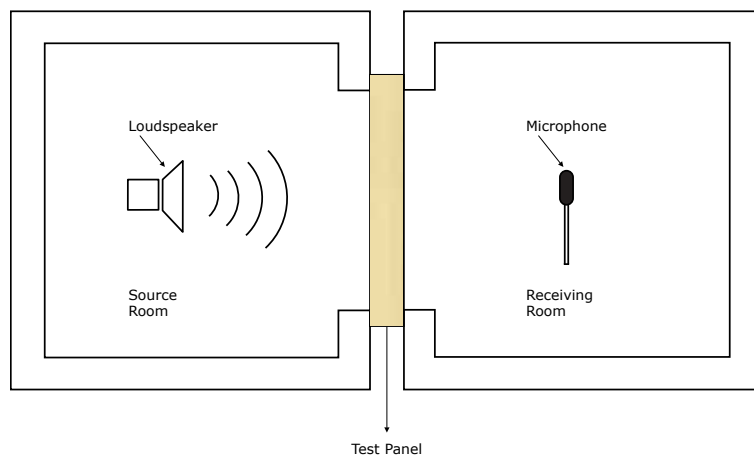
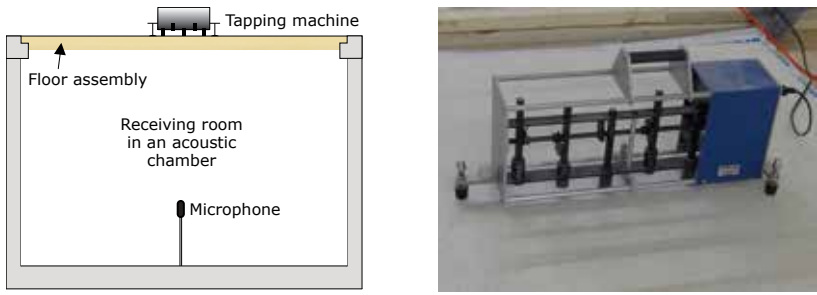

Figure 9
Simple illustration of laboratory acoustic chambers for testing walls (Harris, 1957)

While the test is conducted using the procedures of ASTM E90 standard, ASTM E413 standard provides the numerical procedure for determining the STC from the measured sound transmission loss data. According to E413 standard, STC ratings correlate in a general way with subjective impressions of sound transmission for speech, radio, television, and similar sources of noise in offices and buildings.

ASTM E492 standard specifies the test method for laboratory measurement of impact sound transmission through floor/ceiling assemblies using a tapping machine. This test method is also used for tests conducted in a laboratory under controlled conditions, meaning without flanking. Figure 10 (IRC, 2002) provides the simple illustration of such a test with a receiving room. ASTM E989 standard provides the classification for determination of IIC from the measured sound pressure level in the receiving room produced by the tapping machine on the floor/ceiling assembly being tested.



(a) Acoustic chamber showing the floor specimen and tapping machine (b) ISO tapping machine

Figure 10

Simple illustration of an acoustic chamber and impact insulation test on a floor (IRC, 2002)

2.4.3.2 Determination of FSTC and FIIC in Buildings

As discussed in section 2.4.2, some degree of flanking is unavoidable in buildings; therefore, STC and IIC measured on-site (i.e., during tests conducted in the field) are called Field Sound Transmission Class (FSTC), and Field Impact Insulation Class (FIIC). ASTM E336 standard specifies the test method for measurement of airborne sound insulation in buildings, and ASTM E413 standard is used to determine the FSTC from the measured sound transmission loss. ASTM E1007 standard specifies the test method for field measurement of tapping machine impact sound transmission through floor/ceiling assemblies and associated support structures. Finally, ASTM E989 standard is used to determine the FIIC from the measured sound pressure level of field floor/ceiling assemblies.

Figures 11 and 12 demonstrate the field measurements on a wall and a floor/ceiling assembly in a building under construction.



(a) Source room with an omnidirectional loudspeaker as the source and a sound level meter (b) Receiving room with a sound level meter to measure the sound transmitted through the wall

Figure 11

Field wall sound transmission test for FSTC



(a) Source room with the tapping machine on the floor in a field floor/ceiling assembly



(b) Receiving room under the source room with a sound level meter to measure the impact sound transmitted through the floor/ceiling assembly

Figure 12

Field floor impact sound insulation test for FIIC using an ISO tapping machine

2.4.3.3 General Factors Affecting STC and IIC

In general, the most important factors affecting airborne sound insulation of wall and floor/ceiling assemblies, and impact sound insulation of floor/ceiling assemblies, are (IRC, 2002):

- Total weight per unit area: the heavier, the better sound insulation, especially for low frequency sound;
- Stiffness: in general, the stiffer, the better sound insulation. However, it has been observed that very stiff wood-joisted floor/ceiling assemblies present greater low-frequency impact sound insulation;
- Porosity: the less porosity, the better sound insulation;
- Multi-layers with air space: the larger the airspace, the better sound insulation;
- Contacts between layers: the softer the contacts, the better sound insulation;
- Sound absorption: sound absorbing material in the air space or the cavity between layers is beneficial;
- Floor surface hardness: the harder the surface, the poorer the impact sound insulation, especially with high-frequency impact sound.

3

ACOUSTIC PROPERTIES OF BARE CLT WALLS AND FLOORS

Mass and damping are the two properties of CLT elements that significantly affect CLT floor and wall sound insulation. Mass is the most important factor amongst other factors affecting CLT floor and wall sound insulating performance: the greater the mass, the better the performance. Laboratory tests at FPInnovations showed that bare CLT floors have a damping ratio of approximately 1% of the critical damping ratio (Hu, 2013b). Table 3 provides the area mass of some CLT elements assuming the density of the CLT elements is 31.2 pcf (500 kg/m³). This table does not intend to extensively present all the CLT elements on the market, but merely to give some examples of the range in area mass of CLT elements. Understanding the area mass of CLT will greatly help in the sound insulation designs using CLT walls and floors.

Table 3

Area mass of some CLT elements for wall and floor applications

Number of Layers	Thickness in. (mm)	Area Mass lb./ft. ² (kg/m ²)
3	2.36 (60)	6.14 (30)
3	4.72 (120)	12.29 (60)
5	4.61 (117)	11.98 (58.5)
5	7.87 (200)	20.48 (100)
7	7.95 (202)	20.69 (101)
7	11.02 (280)	28.67 (140)
8	9.76 (248)	25.40 (124)
8	12.60 (320)	32.77 (160)

Table 4 provides the measured STC and IIC values for some bare CLT walls and floors in various laboratories (reported by Gagnon and Kouyoumji, 2011), and the FSTC and FIIC values measured by FPInnovations on bare CLT floors and walls in CLT buildings (Hu, 2013a). Since flanking paths were possibly present for the field test results, the FSTC and FIIC presented provide an indication of the sound insulating performance of bare CLT floors and walls in buildings.

Table 4

Sound insulation performance of bare CLT floors and walls

Number of Layers	Thickness in. (mm)	Assembly Type	STC	IIC
3	3.74 - 4.53 (95-115)	Wall	32-34	N/A
5	5.31 (135)	Floor	39	23
5	5.75 (146)	Floor	39	24
Measured on field bare CLT wall and floor (Hu, 2013a)				
Number of Layers	Thickness in. (mm)	Assembly Type	FSTC	FIIC
3	4.13 (105)	Wall	28	N/A
7	8.19 (208)	Floor	N/A	25

4

INTERNATIONAL BUILDING CODE (IBC) REQUIREMENTS FOR SOUND INSULATION OF DEMISING WALLS AND FLOOR/CEILING ASSEMBLIES

IBC (2009) provides the minimum requirements for sound insulation of demising walls and floor/ceiling assemblies between adjacent dwelling units or between dwelling units and public areas such as halls, corridors, stairs or service areas. Table 5 lists these requirements.

Table 5

IBC minimum requirements for sound insulation of demising walls and floor/ceiling assemblies

Assembly Type	Airborne Sound		Structure-borne Sound	
Wall	STC	50	N/A	
	FSTC	45 (field measured ¹)		
Floor	STC	50	IIC	50
	FSTC	45 (field measured ¹)	FIIC	45 (field measured ²)

Notes:

1. When tested in accordance with ASTM E90 for STC and ASTM E336 for FSTC
2. When tested in accordance with ASTM E492 for IIC and ASTM E1007 for FIIC

5

EXAMPLES OF CONSTRUCTION SOLUTIONS FOR CLT WALLS AND FLOORS MEETING IBC'S STC AND IIC REQUIREMENTS

Gagnon and Kouyoumji (2011) reported in the Canadian edition of the CLT Handbook several construction solutions for CLT walls and floors with STC and IIC ratings measured in laboratory acoustic chambers in various laboratories. Tables 6 to 11 list the wall and floor systems extracted from the Canadian CLT Handbook with the ratings meeting IBC's STC and IIC of 50 requirements.

Table 6

STC of CLT wall assemblies



Assembly Description from Top to Bottom (6.1)		STC
1	3-layer CLT panel of 3 3/4 in. ~ 4 1/2 in. (95 mm ~ 115 mm)	48 ~ 50
2	Mineral wool of about 1.18 in. (~ 30 mm)	
3	3-layer CLT panel of 3 3/4 in. ~ 4 1/2 in. (95 mm ~ 115 mm)	

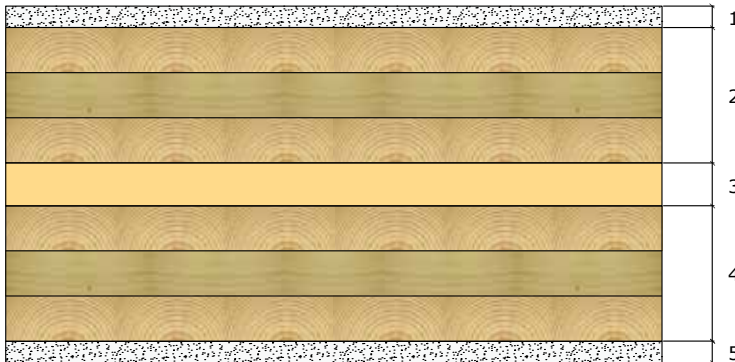

Assembly Description from Top to Bottom (6.2)		STC
1	Gypsum board of 5/8 in. (15 mm)	55 or above depending on CLT thickness
2	3-layer CLT panel of 3 3/4 in. ~ 4 1/2 in. (95 mm ~ 115 mm)	
3	Mineral wool of about 1.18 in. (~ 30 mm)	
4	3-layer CLT panel of 3 3/4 in. ~ 4 1/2 in. (95 mm ~ 115 mm)	
5	Gypsum board of 5/8 in. (15 mm)	

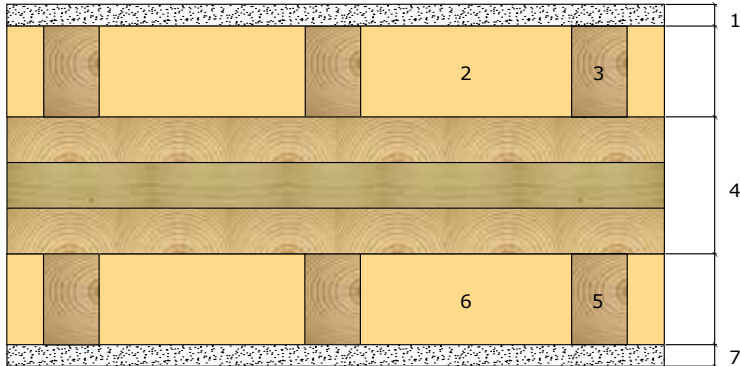

Assembly Description from Top to Bottom (6.3)		STC
1	Gypsum board of 5/8 in. (15 mm)	58 or above depending on CLT thickness
2	Mineral wool of about 2.36 in. (~ 60 mm)	
3	Lumber studs of 2 in. x 3 in. (38 mm x 63 mm) at least 16 in. (400 mm) o.c.	
4	3-layer CLT panel of 3 3/4 in. ~ 4 1/2 in. (95 mm ~ 115 mm)	
5	Mineral wool of about 2.36 in. (~ 60 mm)	
6	Lumber studs of 2 in. x 3 in. (38 mm x 63 mm) at least 16 in. (400 mm) o.c., attached to CLT and gypsum boards	
7	Gypsum board of 5/8 in. (15 mm)	

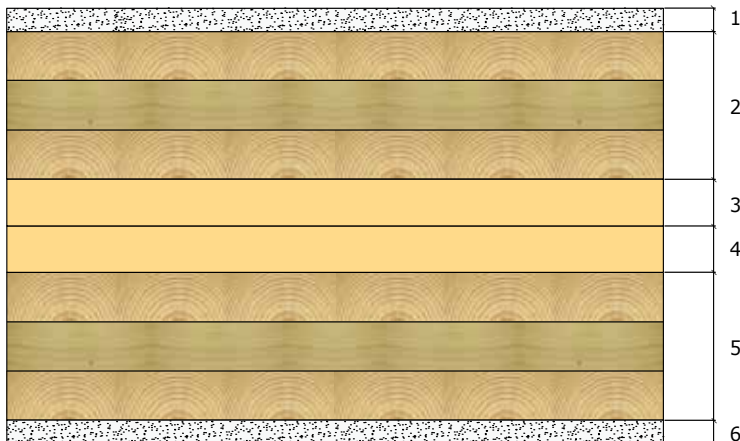

Assembly Description from Top to Bottom (6.4)		STC
1	Gypsum board of 5/8 in. (15 mm)	60 or above depending on CLT thickness
2	3-layer CLT panel of 3 3/4 in. ~ 4 1/2 in. (95 mm ~ 115 mm)	
3	Mineral or rock wool of about 1.18 in. (~ 30 mm)	
4	Sound insulation material (mineral or rock wool) of about 1.18 in. (~ 30 mm)	
5	3-layer CLT panel of 3 3/4 in. ~ 4 1/2 in. (95 mm ~ 115 mm)	
6	Gypsum board of 5/8 in. (15 mm)	

Note: Lumber in the outer layer of CLT is vertical. Observing Tables 6.1 to 6.4, we find that:

1. For double CLT walls with mineral wool in the gap between two walls, adding the 5/8 in. (15 mm) gypsum boards on the two surfaces increases the measured STC from 5 to 7 points.

2. For double CLT walls with mineral wool in the gap between two walls, increasing the gap from 1.18 in. (30 mm) to 2.36 in. (60 mm) increases the STC by at least 5 points.
3. For a single CLT wall with two 2 in. x 3 in. (38 mm x 63 mm) lumber stud walls directly attached to the CLT walls and with 5/8 in. (15 mm) gypsum boards on the surfaces and mineral wool in the wall cavities, the STC was 3 points higher than the double CLT walls with 5/8 in. (15 mm) gypsum boards on surfaces, and 1.18 in. (30 mm) gap between two CLT walls and the gap filled with insulation material.

Table 7

STC and IIC of CLT floor assemblies without a ceiling

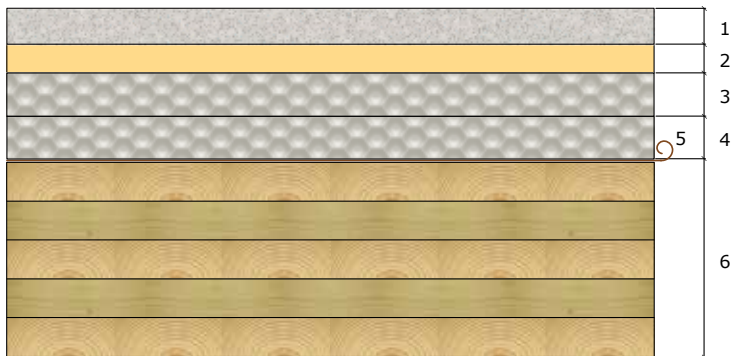

Assembly Description from Top to Bottom (7.1)		STC	IIC
1	Gypsum fiberboard FERMACELL of 1.0 in. (25 mm)	62	59
2	Sub-floor ISOVER EP3 of 0.79 in. (20 mm)		
3	Honeycomb acoustic infill FERMACELL of 1.18 in. (30 mm)		
4	Honeycomb acoustic infill FERMACELL of 1.18 in. (30 mm)		
5	Kraft paper underlayment		
6	5-layer CLT panel of 5 5/16 in. (135 mm)		



Assembly Description from Top to Bottom (7.2)		STC	IIC
1	Prefabricated concrete topping of 0.79 in. (20 mm)	64	60
2	Kraft paper underlayment		
3	Subfloor ISOVER EP2 of 1 in. (25 mm)		
4	Honeycomb acoustic infill FERMACELL of 1.18 in. (30 mm)		
5	Honeycomb acoustic infill FERMACELL of 1.18 in. (30 mm)		
6	Kraft paper underlayment		
7	5-layer CLT panel of 5 5/16 in. (135 mm)		

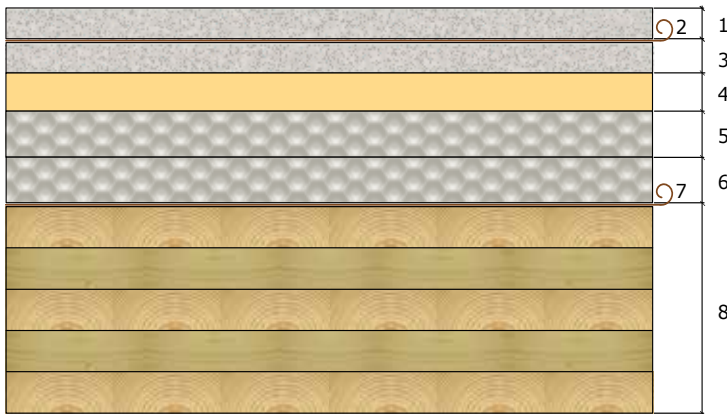

Assembly Description from Top to Bottom (7.3)		STC	IIC
1	Prefabricated concrete topping of 0.79 in. (20 mm)	64	72
2	Kraft paper underlayment		
3	Prefabricated concrete topping of 0.79 in. (20 mm)		
4	Subfloor ISOVER EP1 of 1.18 in. (30 mm)		
5	Honeycomb acoustic infill FERMACELL of 1.18 in. (30 mm)		
6	Honeycomb acoustic infill FERMACELL of 1.18 in. (30 mm)		
7	Kraft paper underlayment		
8	5-layer CLT panel of 5 5/16 in. (135 mm)		

Table 8

STC and IIC of CLT floors without topping and with only a ceiling

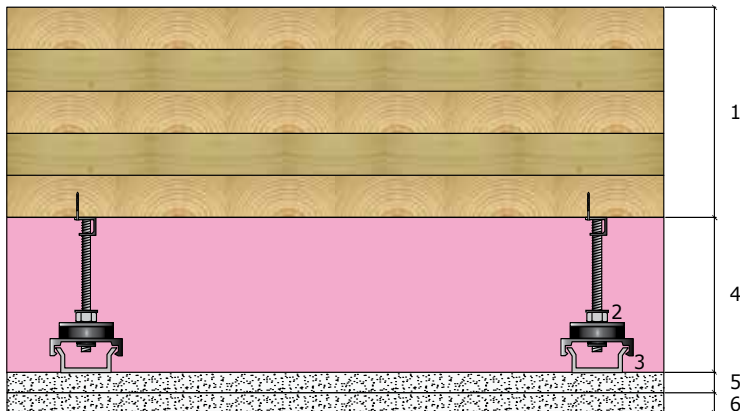

Assembly Description from Top to Bottom (8.1)		STC	IIC
1	5-layer CLT panel of 5 3/4 in. (146 mm)	64	59
2	Sound isolation clips of 4 in. (100 mm) high (Figure 13)		
3	Metal hat channel at minimum spacing of 16 in. (400 mm) o.c.		
4	Sound absorption material (such as fiberglass) of 4 in. (100 mm)		
5	Gypsum board of 1/2 in. (13 mm)		
6	Gypsum board of 1/2 in. (13 mm)		
1	5-layer CLT panel of 5 3/4 in. (146 mm)	63	62
2	Sound isolation clips of 8 in. (200 mm) high (Figure 13)		
3	Metal hat channel at minimum spacing of 16 in. (400 mm) o.c.		
4	Sound absorption material (such as fiberglass) of 8 in. (200 mm)		
5	Gypsum board of 1/2 in. (15 mm)		
6	Gypsum board of 1/2 in. (15 mm)		

Observations:

1. With a suspended ceiling, without the need of a topping, this CLT construction can achieve higher STC and IIC than the code requirement of STC 50 and IIC 50 for floor/ceiling assemblies.
2. When increasing the ceiling cavity depth from 4 in. (100 mm) to 8 in. (200 mm), and the thickness of gypsum boards from 1/2 in. (13 mm) to 5/8 in. (15 mm), the STC of the CLT floor/ceiling assembly was not affected, but the IIC increased by 3 dB.



(a)



(b)

Figure 13

Sound isolation clip (a) and resiliently suspended gypsum board ceiling from CLT floor with sound isolation clips supporting metal hat channels and gypsum boards (b)

Table 9
STC and IIC of CLT floors with flooring and ceiling

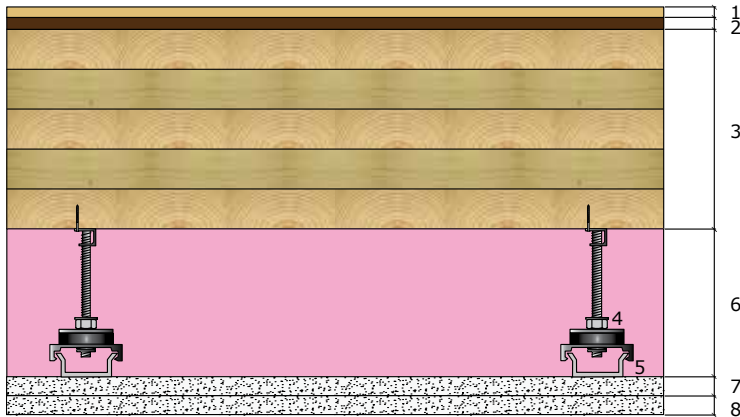

Assembly Description from Top to Bottom (9.1)		STC	IIC
1	Laminated flooring of 1/4 in. (6.4 mm)	62	63
2	Low-density wood fiberboard of 0.2 in. (5 mm) (PHALTEX)		
3	5-layer CLT panel of 5 3/4 in. (146 mm)		
4	Sound isolation clips of 4 in. (100 mm) high (Figure 13)		
5	Metal hat channel at minimum spacing of 16 in. (400 mm) o.c.		
6	Fiberglass of 4 in. (100 mm)		
7	Gypsum board of 1/2 in. (13 mm)		
8	Gypsum board of 1/2 in. (13 mm)		
1	Laminated flooring of 1/4 in. (6.4 mm)	63	64
2	Low-density wood fiberboard of 0.4 in. (10 mm) (PHALTEX)		
3	5-layer CLT panel of 5 3/4 in. (146 mm)		
4	Sound isolation clips of 4 in. (100 mm) high (Figure 13)		
5	Metal hat channel at minimum spacing of 16 in. (400 mm) o.c.		
6	Fiberglass of 4 in. (100 mm)		
7	Gypsum board of 1/2 in. (13 mm)		
8	Gypsum board of 1/2 in. (13 mm)		

Observations:

1. Adding a floating floor to the CLT floor with the suspended ceiling system increased the IIC by 4 points
2. Increasing the thickness of underlayment for the floating floor did not significantly improve the STC and IIC

Table 10

STC and IIC of CLT floors with topping and ceiling (a)

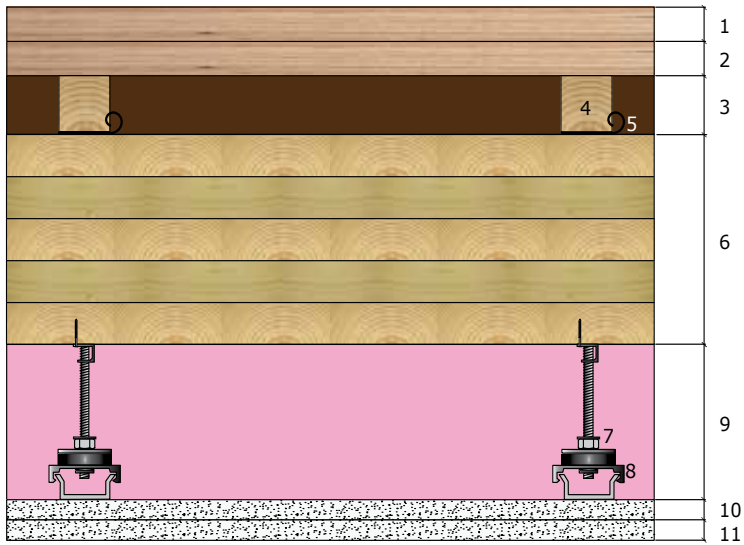

Assembly Description from Top to Bottom (10.1)		STC	IIC
1	Particleboard panel of 7/8 in. (22 mm)	67	62
2	Particleboard panel of 7/8 in. (22 mm)		
3	Mineral wool of about 1 5/8 in. (~ 40 mm)		
4	Lumber sleepers of 1 5/8 in. x 1 5/8 in. (40 mm x 40 mm) at least 16 in. (400 mm) o.c. attached to particleboard		
5	REGULPOL underlayment		
6	5-layer CLT panel of 5 3/4 in. (146 mm)		
7	Sound isolation clips of 4 in. (100 mm) high (Figure 13)		
8	Metal hat channel at minimum spacing of 16 in. (400 mm) o.c.		
9	Fiberglass of 4 in. (100 mm)		
10	Gypsum board of 1/2 in. (13 mm)		
11	Gypsum board of 1/2 in. (13 mm)		

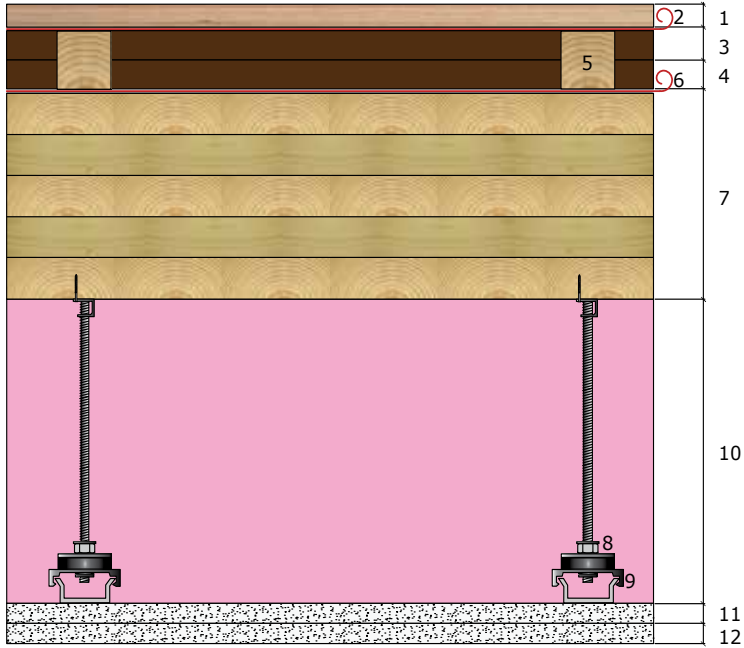

Assembly Description from Top to Bottom (10.2)		STC	IIC
1	OSB panel of 5/8 in. (15 mm) attached to sleepers	62	62
2	Flooring underlayment ROBERTS		
3	Low-density wood fiberboard THERMISOREL of 0.78 in. (20 mm)		
4	Low-density wood fiberboard THERMISOREL of 0.78 in. (20 mm)		
5	Lumber sleepers of 1 5/8 in. x 1 5/8 in. (40 mm x 40 mm) at least 16 in. (400 mm) o.c. attached to OSB		
6	Flooring underlayment ROBERTS		
7	5-layer CLT panel of 5 3/4 in. (146 mm)		
8	Sound isolation clips of 8 in. (200 mm) high (Figure 13)		
9	Metal hat channel at minimum spacing of 16 in. (400 mm) o.c.		
10	Fiberglass of 8 in. (200 mm)		
11	Gypsum board of 5/8 in. (15 mm)		
12	Gypsum board of 5/8 in. (15 mm)		

Observations:

- The effect of the topping systems seems almost equivalent to that of the floating floor (Table 8) in terms of the effectiveness of improving STC and IIC, except that the topping was on the lumber sleepers. In comparison with the floating floor in Table 8, adding this topping to the CLT floor with the suspended ceiling increased the STC by 3 points.

Table 11

STC and IIC of CLT floors with topping and ceiling (b)

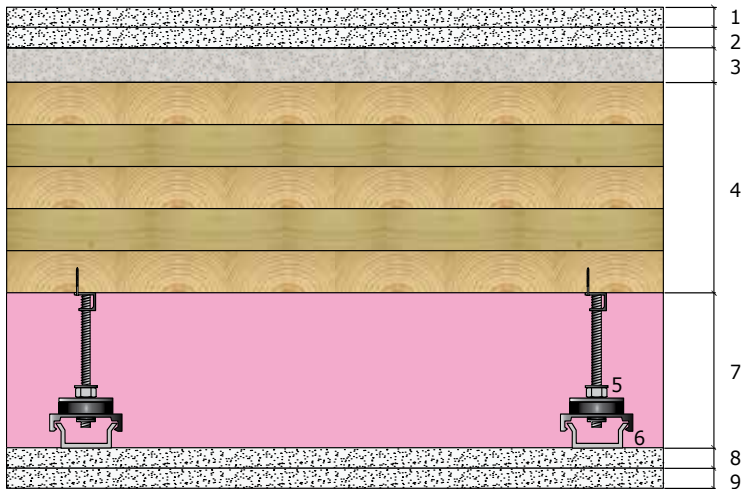

Assembly Description from Top to Bottom (11.1)		STC	IIC
1	Gypsum board of 1/2 in. (13 mm)	63	63
2	Gypsum board of 1/2 in. (13 mm)		
3	Dry topping of at least 0.78 in. (20 mm) and 7.17 lb./ft. ² (35 kg/m ²), ex. FERMACELL, cement-fiberboard, etc.		
4	5-layer CLT panel of 5 3/4 in. (146 mm)		
5	Sound isolation clips of 4 in. (100 mm) high (Figure 13)		
6	Metal hat channel at minimum spacing of 16 in. (400 mm) o.c.		
7	Fiberglass of 4 in. (100 mm)		
8	Gypsum board of 1/2 in. (13 mm)		
9	Gypsum board of 1/2 in. (13 mm)		

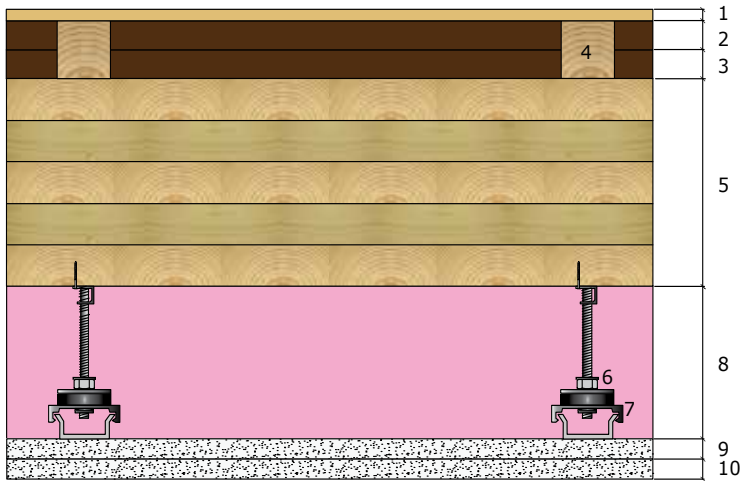

Assembly Description from Top to Bottom (11.2)		STC	IIC
1	Floorboard attached to sleepers		
2	Low-density wood fiberboard THERMISOREL of 0.78 in. (20 mm)		
3	Low-density wood fiberboard THERMISOREL of 0.78 in. (20 mm)		
4	Lumber sleepers of 1 5/8 in. x 1 5/8 in. (40 mm x 40 mm) at least 16 in. (400 mm) o.c. attached to CLT		
5	5-layer CLT panel of 5 3/4 in. (146 mm)	64	65
6	Sound isolation clips of 4 in. (100 mm) high (Figure 13)		
7	Metal hat channel at minimum spacing of 16 in. (400 mm) o.c.		
8	Fiberglass of 4 in. (100 mm)		
9	Gypsum board of 1/2 in. (13 mm)		
10	Gypsum board of 1/2 in. (13 mm)		

6

EXAMPLES OF CONSTRUCTION SOLUTIONS FOR CLT WALLS AND FLOOR/CEILING ASSEMBLIES MEETING IBC'S FSTC AND FIIC REQUIREMENTS

Field sound insulation tests were conducted on some CLT wall and floor/ceiling assemblies in two new CLT buildings. Tables 12 and 13 summarize the CLT wall assemblies that were tested in the two CLT buildings (Hu, 2013a) meeting the IBC's sound insulation requirements of FSTC 45. Tables 14 and 15 summarize the CLT floor/ceiling assemblies that were tested at FPInnovations' acoustic facility, i.e. the mock-up of a two-story CLT condominium meeting IBC's requirements of FSTC 45 and FIIC 45. It must be noted that, if the flanking paths can be minimized (i.e., avoidable flanking paths can be eliminated), then the FSTC and FIIC are expected to be higher than those provided in these tables.

Table 12

FSTC of CLT wall assemblies in complete CLT building-1

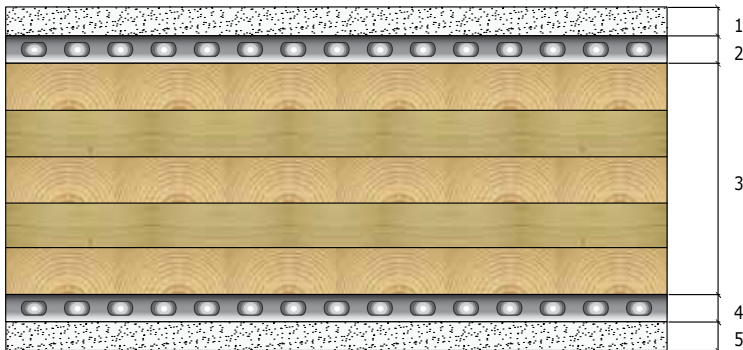

Assembly Description from Top to Bottom (12.1)		FSTC
1	Gypsum board of 5/8 in. (16 mm) about 2.25 lb./ft. ² (11 kg/m ²)	46
2	Type RC-1 (one-leg) 25 gauge resilient channels at 24 in. (600 mm) o.c.	
3	5-layer CLT panel of 7 1/4 in. (184 mm)	
4	Type RC-1 (one-leg) 25 gauge resilient channels at 24 in. (600 mm) o.c.	
5	Gypsum board of 5/8 in. (16 mm) about 2.25 lb./ft. ² (11 kg/m ²)	

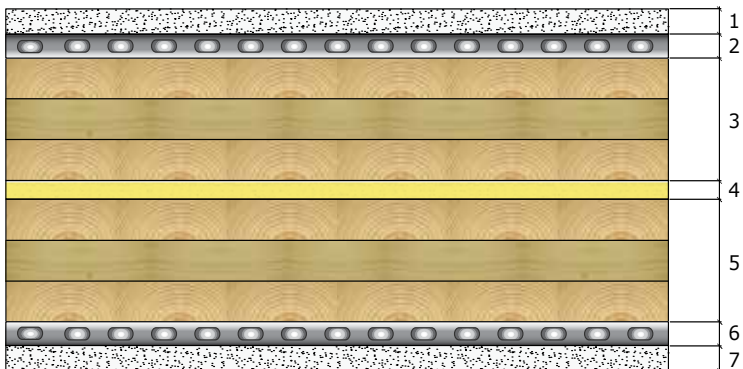

Assembly Description from Top to Bottom (12.2)		FSTC
1	Gypsum board of 5/8 in. (16 mm) about 2.25 lb./ft. ² (11 kg/m ²)	47
2	Type RC-1 (one-leg) 25 gauge resilient channels at 24 in. (600 mm) o.c.	
3	3-layer CLT panel of 3 in. (78 mm)	
4	Air gap of 1 in. (25 mm) filled with mineral wool	
5	3-layer CLT panel of 3 in. (78 mm)	
6	Type RC-1 (one-leg) 25 gauge resilient channels at 24 in. (600 mm) o.c.	
7	Gypsum board of 5/8 in. (16 mm) about 2.25 lb./ft. ² (11 kg/m ²)	

Table 13

FSTC of CLT wall assemblies in CLT building-2 without finishing

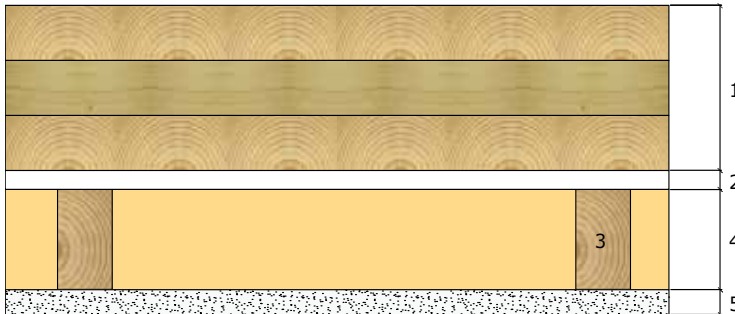

Assembly Description from Top to Bottom (13.1)		FSTC
1	3-layer CLT of 4 1/8 in. (105 mm)	47
2	Air gap of 1/2 in. (12 mm)	
3	Wood studs of 2 in. x 3 in. (38 mm x 64 mm) at 16 in. (400 mm) o.c.	
4	Mineral wool of 2 1/2 in. (64 mm) in the wall cavity	
5	Gypsum board of 5/8 in. (16 mm) about 2.25 lb./ft. ² (11 kg/m ²)	

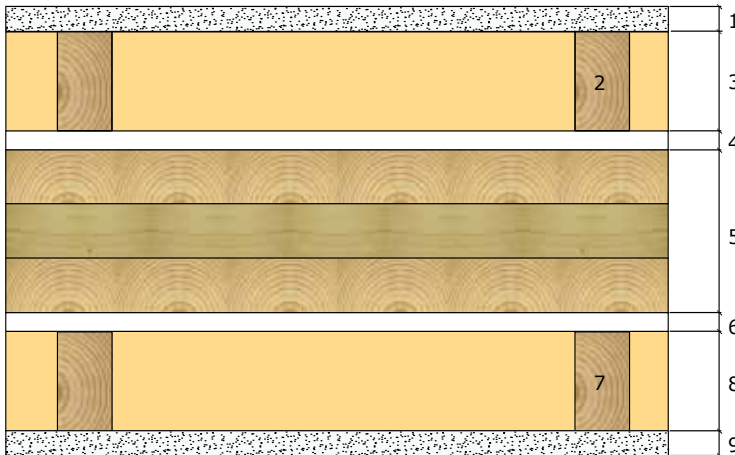

Assembly Description from Top to Bottom (13.2)		FSTC
1	Gypsum board of 5/8 in. (16 mm) about 2.25 lb./ft. ² (11 kg/m ²)	50
2	Wood studs of 2 in. x 3 in. (38 mm x 64 mm) at 16 in. (400 mm) o.c.	
3	Mineral wool of 2 1/2 in. (64 mm) in the wall cavity	
4	Air gap of 1/2 in. (12 mm)	
5	3-layer CLT of 4 1/8 in. (105 mm)	
6	Air gap of 1/2 in. (12 mm)	
7	Wood studs of 2 in. x 3 in. (38 mm x 64 mm) at 16 in. (400 mm) o.c.	
8	Mineral wool of 2 1/2 in. (64 mm) in the wall cavity	
9	Gypsum board of 5/8 in. (16 mm) about 2.25 lb./ft. ² (11 kg/m ²)	

Table 14

FSTC and FIIC of CLT floors with flooring and a suspended ceiling

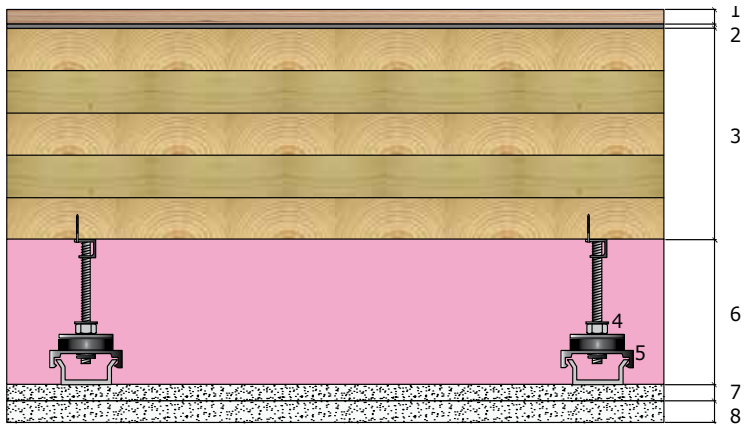

Assembly Description from Top to Bottom (14.1)		FSTC	FIIC
1	Around 2/5 in. (10 mm) laminated or engineered wood flooring		
2	Around 0.12 in. (3 mm) resilient underlayment (rubber mat, e.g. InsonoBois or similar; textured felt, e.g. Thermason HD or similar)	>50	>50
3	5-layer CLT panel of 6 7/8 in. (175 mm)	Depending on the thickness of CLT and flooring, RC spacing and cavity height	Depending on the type of underlayment, thickness of flooring and CLT, RC spacing and cavity height
4	Sound isolation clips of 4 in. (100 mm) high (Figure 13)		
5	Metal hat channel at minimum spacing of 16 in. (400 mm) o.c.		
6	Fiberglass of 4 in. (100 mm)		
7	Gypsum board of 1/2 in. (12 mm) type C about 1.84 lb./ft. ² (9 kg/m ²)		
8	Gypsum board of 5/8 in. (15 mm) type X about 2.25 lb./ft. ² (11 kg/m ²)		

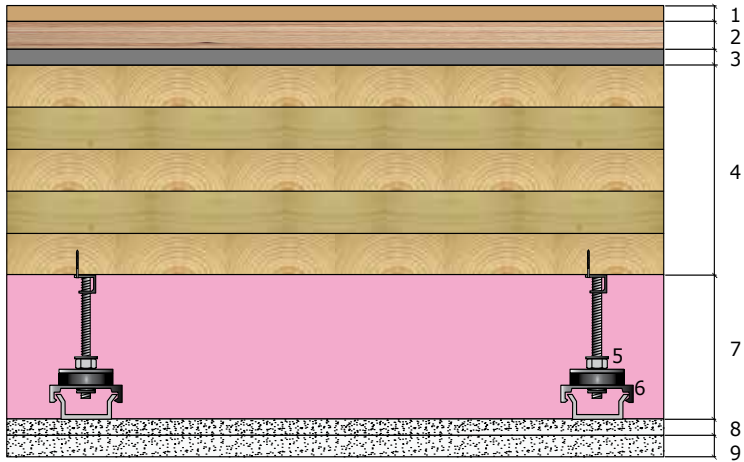

Assembly Description from Top to Bottom (14.2)		FSTC	FIIC
1	Hardwood flooring attached to the plywood		
2	3/4 in. (18 mm) plywood		
3	Around 2/5 in. (10 mm) underlayment (rubber mat, e.g. InsonoMat or similar; textured felt, e.g. Felt S-125 or similar)	>53	>53
4	5-layer CLT panel of 6 7/8 in. (175 mm)	Depending on the thickness of CLT and flooring, RC spacing and cavity height	Depending on the type of underlayment, thickness of flooring and CLT, RC spacing and cavity height
5	Sound isolation clips of 4 in. (100 mm) high (Figure 13)		
6	Metal hat channel at minimum spacing of 16 in. (400 mm) o.c.		
7	Fiberglass of 4 in. (100 mm)		
8	Gypsum board of 1/2 in. (12 mm) type C about 1.84 lb./ft. ² (9 kg/m ²)		
9	Gypsum board of 5/8 in. (15 mm) type X about 2.25 lb./ft. ² (11 kg/m ²)		

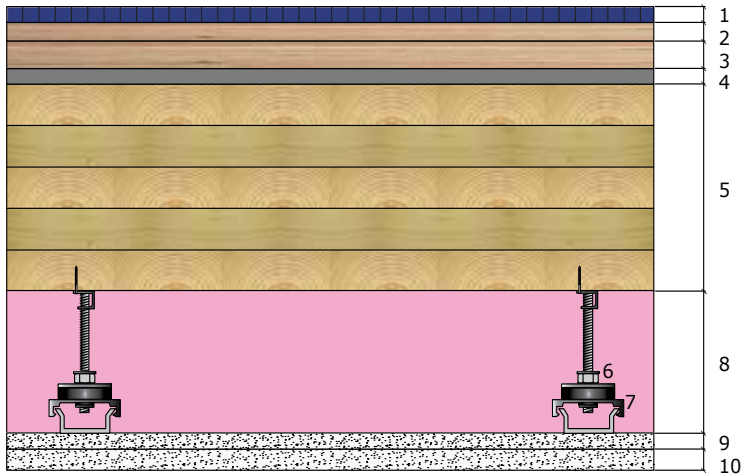

Assembly Description from Top to Bottom (14.3)		FSTC	FIIC
1	Ceramic tiles glued to plywood		
2	1/2 in. (12 mm) plywood		
3	3/4 in. (19 mm) plywood	>53	>53
4	Around 2/5 in. (10 mm) underlayment (rubber mat, e.g. InsonoMat or similar; textured felt, e.g. Felt S-125 or similar)	Depending on the thickness of CLT and tile, RC spacing and cavity height	Depending on the thickness of CLT and tile, the type of tile and underlayment, RC spacing and cavity height
5	5-layer CLT panel of 6 7/8 in. (175 mm)		
6	Sound isolation clips at 4 in. (100 mm) high (Figure 13)		
7	Metal hat channel at minimum spacing of 16 in. (400 mm) o.c.		
8	Fiberglass of 4 in. (100 mm)		
9	Gypsum board of 1/2 in. (12 mm) type C about 1.84 lb./ft. ² (9 kg/m ²)		
10	Gypsum board of 5/8 in. (15 mm) type X about 2.25 lb./ft. ² (11 kg/m ²)		

Table 15

FSTC and FIIC of CLT floors with flooring and topping, wood exposed on ceiling side



Assembly Description from Top to Bottom (15.1)		FSTC	FIIC
1	About 2/5 in. (10 mm) carpet or floating flooring on 0.12 in. (3 mm) resilient underlayment (rubber mat, e.g. InsonoBois or similar; textured felt, e.g. Thermason HD or similar)	>45 Depending on the thickness of CLT, topping and flooring	>45 Depending on the thickness of CLT, topping and flooring, and the type of flooring, topping and underlayment
2	At least 5.12 lb./ft. ² (25 kg/m ²) dry topping, e.g. 0.8 in. (20 mm) Fermacell, cement fiberboard, Fibrerock or similar		
3	Resilient underlayment, e.g. 2/5 in. (10 mm) rubber mat (IsonoMat), 3/4 in. (18 mm) textured felt (Felt S-125), 1/2 in. (12 mm) low density wood fiberboard, or similar		
4	5-layer CLT of 6 7/8 in. (175 mm)		



Assembly Description from Top to Bottom (15.2)		FSTC	FIIC
1	About 2/5 in. (10 mm) carpet or floating flooring on 0.12 in. (3 mm) resilient underlayment (rubber mat, e.g. InsonoBois or similar; textured felt, e.g. Thermason HD or similar)	>50 Depending on the thickness of CLT, topping and flooring	>50 Depending on the thickness of CLT, topping and flooring, and the type of flooring, topping and underlayment
2	At least 15.6 lb./ft. ² (76 kg/m ²) wet topping (concrete, gypcrete, gypsum, or similar)		
3	Resilient underlayment, e.g. 2/5 in. (10 mm) rubber mat (Insonomat), 3/4 in. (18 mm) textured felt (Felt S-125), 1/2 in. (12 mm) low density wood fiberboard, etc.		
4	5-layer CLT of 6 7/8 in. (175 mm)		

7

THE BEST PRACTICES FOR ENSURING OCCUPANTS' SATISFACTIONS - STEP BY STEP GUIDE

While Sections 5 and 6 provide examples of solutions to meet IBC requirements for sound insulation, this Section provides step-by-step guidance towards satisfactory sound insulation for CLT projects. If in doubt or if sound insulation is critical, it is strongly recommended to engage the services of an acoustical consultant.

7.1 Step 1: Selecting Construction Solutions for FSTC and FIIC 50

Experts experience in field surveys and investigations has shown that even meeting the minimum IBC requirements (i.e., FSTC and FIIC of 45) does not always eliminate occupants complaints. While not always possible, it is suggested to strive for FSTC and FIIC ratings of 50 or more, particularly in multiple dwelling units.

7.2 Step 2: Eliminating Avoidable Flanking Paths

To optimize the efficiency of the sound insulation solutions selected in Sections 5 and 6, a quality-controlled installation protocol must be implemented in order to eliminate avoidable flanking paths.

There are two types of flanking transmission, i.e. sound leaking through any openings, and vibration transfer between the coupled surfaces or through the continuous structure elements. The basics of flanking control are to seal the openings, to decouple the surfaces, and to discontinue the structural elements if it does not affect the structural safety and serviceability. However, there is always a trade-off. Table 16 provides a flanking path check list and corresponding treatment. The list includes the most obvious and crucial flanking paths that must be controlled or eliminated. If the flanking paths can be controlled, then the solutions provided should provide satisfactory sound insulation for CLT buildings.

Table 16

Flanking path check list and general treatment; not limited to CLT buildings

Flanking Path	Treatment
Leaks around the edge of partitions (ASTM E336)	Seal the leaks with tape, gaskets, or caulking compound (ASTM E336)
Cracks at wall/floor junctions	Caulk joint between gypsum board and floor, Figure 6 (IRC, 2002)
Debris between floor and wall sill plates	Clean floor and caulk sill plate (IRC, 2002)
Leaks through electrical outlets	Avoid back-to-back outlets by offsetting them 16 in. (400 mm) or at least one stud space from side to side, Figure 7 (IRC, 2002)
If gypsum board is rigidly attached to studs or the wall framing, the wall could contribute to flanking (IRC, 2002)	Attach gypsum board on resilient channels (IRC, 2002)
Joint between the flooring, topping and the surrounding walls, especially if the flooring topping is floating or not rigidly attached to the subfloor	Leave a gap around the entire flooring topping assembly and walls. Fill it with resilient perimeter isolation board or backer rod and seal the joint with acoustical caulk
Continuous subflooring, joists, and CLT elements between two adjacent units	Discontinue subflooring, joists, and CLT as much as possible. Add floating topping and floating flooring if the continuity is not avoidable

7.3 Step 3: Measuring FSTC and FIIC after Finishing

To ensure your trust in the airborne and impact sound insulation of the finished walls and floors, it is a good idea to measure the FSTC and FIIC to confirm that they meet or exceed expected values. In the worst case scenario, a flag can be raised to remedy this situation before the occupants move in and raise the issue in the form of a complaint.

8

CONCLUSION

A great deal of the task of achieving adequate and acceptable airborne and impact sound insulation is simply giving adequate attention to details in the design and construction. Such details consist in proper use of sealants or caulking to seal sound leaks, avoiding rigid contact between building elements where the transfer of vibrational energy between spaces is possible, and using appropriate materials (e.g., materials with sufficient mass). Laboratory and field testing to date show that buildings constructed using CLT materials can provide satisfactory sound insulation if proper design and installation are implemented. While many acoustical tests have been conducted using CLT materials, there are many CLT construction methods and assemblies still to be tested. As these tests are completed, there will be additional confidence that the application of CLT materials will prove to be useful in achieving the acoustical criteria required by building codes and by occupants of buildings we construct.

Special Thanks

The authors would like to thank Mr. Jean-Luc Kouyoumji for his much appreciated measurements and development of the solutions for the CLT assemblies in his laboratory at FCBA, as well as Mr. Wolfgang Weirer and Mr. Thomas Orskaug, from KLH; and Ms. Julie Frappier from Nordic Wood Structures for their special contributions to this study.

9

RECOMMENDATION

This Chapter illustrates state of the art solutions for buildings using CLT materials to achieve satisfactory sound insulations based on research and experience to date. It is recommended that implementation of the solutions provided in this document, be checked and/or validated prior to use with the installation specifications of the various flooring materials with respect to other requirements, such as allowable maximum deformation, moisture stability, etc. Furthermore, in critical situations or when assurance or written documentation is needed that the chosen design meets the building code STC (FSTC) and/or IIC (FIIC) minimum requirements, it is strongly recommend engaging the services of an acoustical consultant to assist.

In closing, the authors would like to point out that, considering the short history of CLT construction, the journey is only beginning. It is hoped that this document will spark inner creative stirrings and be inspiring when considering the sound insulation materials and solutions that have been developed for CLT buildings. We encourage you to share your feedback concerning the application of the solutions provided in your CLT projects.

10

REFERENCES

- ASTM International. 2006. *Classification for determination of impact insulation class (IIC)*. ASTM E989. West Conshohocken, PA: ASTM. 3 p.
- _____. 2009. *Standard test method for laboratory measurement of airborne sound transmission loss of building partitions and elements*. ASTM E90. West Conshohocken, PA: ASTM. 15 p.
- _____. 2009a. *Standard test method for laboratory measurement of impact sound transmission through floor-ceiling assemblies using the tapping machine*. ASTM E492. West Conshohocken, PA: ASTM. 9 p.
- _____. 2009b. *Standard test method for sound absorption and sound absorption coefficients by the reverberation room method*. ASTM C423. West Conshohocken, PA: ASTM. 11 p.
- _____. 2010. *Classification for rating sound insulation*. ASTM E413. West Conshohocken, PA: ASTM. 4 p.
- _____. 2011a. *Standard terminology relating to environmental acoustic*. ASTM C634. West Conshohocken, PA: ASTM. 15 p.
- _____. 2011b. *Standard test method for field measurement of tapping machine impact sound transmission through floor-ceiling assemblies and associated support structures*. ASTM E1007. West Conshohocken, PA: ASTM. 11 p.
- _____. 2011c. *Standard test method for measurement of airborne sound insulation in buildings*. ASTM E336. West Conshohocken, PA: ASTM. 15 p.
- Crocker, M.J. 2007. *Handbook of noise and vibration control*. Hoboken, NJ: John Willey & Sons. 1569 p.
- Gagnon, S. 2011. Acoustics: Acoustic performance of cross-laminated timber assemblies. Chapter 9 in *CLT handbook: Cross-laminated timber*. Canadian ed. Québec, QC: FPInnovations. 1 v.
- Gagnon, S. and C. Pirvu, eds. 2011. *CLT Handbook : Cross-laminated timber*. Canadian ed. Special Publication SP-528E. Québec, QC: FPInnovations. 1 v.
- Harris, C.M., ed. 1957. *Handbook of noise control*. New York: McGraw-Hill. 1 v.
- _____. 1991. *Handbook of acoustical measurements and noise control*, 3rd ed. New York: McGraw-Hill. 1 v.

Hu, L.J. 2013a. Serviceability of new generation wood buildings: Case study of two cross-laminated timber (CLT) buildings. Internal report of project 301006159. Québec, QC: FPInnovations. In progress.

_____. 2013b. Serviceability of new generation wood buildings: Laboratory study of vibration performance of cross-laminated timber (CLT) floors. Internal report of project 301006159. Québec, QC: FPInnovations. In progress.

Institute for Research in Construction (IRC). 2002. Leaks and flanking sound transmission. Presentation at seminar, Sound Isolation and Fire Containment – Details that Work, Building Science Insight Seminar Series, December 2002, Montréal, QC.

International Code Council (ICC). 2009. Sound transmission. Section 1207 in *International building code (IBC)*. Falls Church, VA: ICC. 676 p.

Kappagantu, R. 2010. LMS-acoustics-experimental and fundamentals. Presentation at FPInnovations, December 2010, Québec, QC.

Pope, J. 2003. Principles of acoustics: Principles of acoustics and the measurement of sound. Presentation at B&K (Brüel & Kjær) Seminar, April 10-11, 2003, Norcross, GA.

White, F. A. 1975. *Our acoustic environment*. New York: John Wiley & Sons. 501 p.

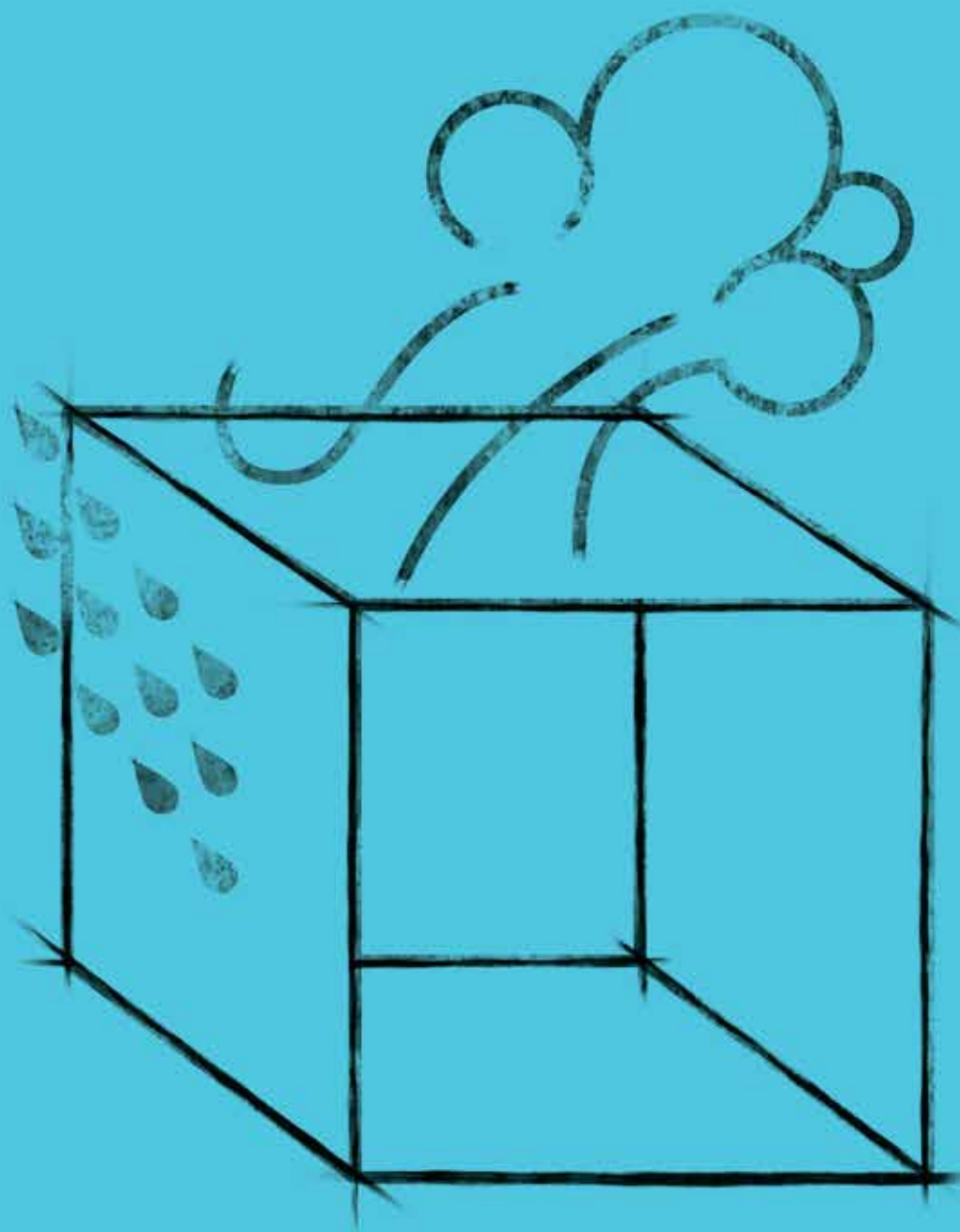

Enclosure

Building enclosure design for
cross-laminated timber construction

CHAPTER 10

Authors

Samuel V. Glass, Ph.D., USDA Forest Products Laboratory
Jieying Wang, Ph.D., FPInnovations
Steve Easley, Steve Easley & Associates Inc.
Graham Finch, M.A.Sc., P.Eng., RDH Building Engineering Ltd.

Peer Reviewers

Vince Cammalleri, AIA, Simpson Gumpertz & Heger
Loren A. Ross, M.Sc., EIT, American Wood Council
Paul I. Morris, Ph.D., FPInnovations

ACKNOWLEDGEMENTS

The U.S. Edition of the CLT Handbook: *cross-laminated timber* combines the work and knowledge of American, Canadian and European specialists. The handbook is based on the original Canadian Edition of the CLT Handbook: *cross-laminated timber*, that was developed using a series of reports initially prepared by FPInnovations and collaborators to support the introduction of CLT in the North American market. A multi-disciplinary team revised, updated and implemented their know-how and technologies to adapt this document to U.S. standards.

The publication of this handbook was made possible with the special collaboration of the following partners:



The editing partners would also like to express their special thanks to Binational Softwood Lumber Council, Forestry Innovation Investment (FII), Nordic Engineered Wood, Structurlam, and CLT Canada for their financial contribution to studies in support of the introduction of cross-laminated timber products in the United States of America.



© 2013 FPInnovations and Binational Softwood Lumber Council. All rights reserved.

The U.S. Edition of the CLT Handbook: *cross-laminated timber* can be electronically downloaded without charge from the website www.masstimber.com. Additional information can be obtained by visiting the websites of FPInnovations, USFPL, American Wood Council (AWC), APA and U.S. WoodWorks. Hard copies can be obtained through AWC (www.awc.org).

No part of this published Work may be reproduced, published, or transmitted for commercial purposes, in any form or by any means, electronic, mechanical, photocopying, recording or otherwise, whether or not in translated form, without the prior written permission of FPInnovations and Binational Softwood Lumber Council.

The information contained in this Work represents current research results and technical information made available from many sources, including researchers, manufacturers, and design professionals. The information has been reviewed by professionals in wood design including professors, design engineers and architects, and wood product manufacturers. While every reasonable effort has been made to insure the accuracy of the information presented, and special effort has been made to assure that the information reflects the state-of-the-art, none of the above-mentioned parties make any warranty, expressed or implied, or assume any legal liability or responsibility for the use, application of, and/or reference to opinions, findings, conclusions, or recommendations included in this published work, nor assume any responsibility for the accuracy or completeness of the information or its fitness for any particular purpose.

This published Work is designed to provide accurate, authoritative information but is not intended to provide professional advice. It is the responsibility of users to exercise professional knowledge and judgment in the use of the information.

ABSTRACT

Cross-laminated timber (CLT) was developed in Europe for the prefabricated construction of wall, roof, and flooring elements. Adaptation of CLT for use in the United States requires consideration of the different climates, building codes, and construction methods in this country.

Building enclosure design has important implications for the energy performance and durability of the structure as well as indoor air quality. The key performance requirements of the enclosure discussed in this Chapter are prevention of water intrusion and control of heat flow, air flow, and moisture flow. The use of prefabricated CLT panels does not change the basic heat, air, and moisture control design principles for an exterior wall or roof assembly. However, the design of CLT assemblies requires attention to the unique characteristics of this product. CLT panels are massive solid wood elements and therefore provide some level of thermal insulation, thermal mass, and airtightness (a separate continuous air barrier system is nevertheless recommended). CLT panels have a relatively high capacity to store moisture but relatively low vapor permeability. If exposed to excessive wetting during transport, storage on the jobsite, construction, or in building service, the panels may absorb a large amount of moisture, and the subsequent drying may be slower than it is for lightweight wood-frame construction.

This Chapter provides guidance on heat, air, and moisture control in wall and roof assemblies that utilize CLT panels in U.S. climate zones. The overarching strategies are to prevent wetting of CLT panels by using drained wall systems, to control airflow using an air barrier on the exterior of the CLT panels, to place rigid insulation to the exterior of the panels, to prevent moisture from accumulating within the panels, and to allow the panels to dry should they get wet. In certain climates, preservative treatment of CLT is recommended to provide additional protection against potential hazards such as decay and termites.

It is intended that these guidelines should assist practitioners in adapting CLT construction to U.S. conditions and ensuring a long life for their buildings. However, these guidelines are not intended to substitute for the input of a professional building scientist. This may be required in some jurisdictions and is recommended in all areas at least until such time as CLT construction becomes common practice.

TABLE OF CONTENTS

Acknowledgements	ii
Abstract	iii
List of Tables	vi
List of Figures	vi
1 Introduction	1
2 Heat, Air, and Moisture Control Strategies	3
2.1 Wood Properties Related to Heat, Air, and Moisture	3
2.1.1 Density and Specific Gravity	4
2.1.2 Moisture Storage and Moisture Transfer	4
2.1.2.1 Moisture Content and Fiber Saturation Point	4
2.1.2.2 Water Vapor Sorption	5
2.1.2.3 Water Vapor Permeability	6
2.1.2.4 Liquid Water Absorption	8
2.1.3 Dimensional Changes	8
2.1.4 Heat Storage and Heat Transfer	9
2.1.5 Air Permeability	9
2.1.6 Moisture and Wood Durability	10
2.2 Exterior Water Management	10
2.2.1 Moisture Transfer Mechanisms	11
2.2.2 Water Management Strategies for Walls	11
2.2.3 Approaches to Water Management in Exterior Walls	12
2.2.3.1 Face-sealed Systems	12
2.2.3.2 Storage or Mass Systems	13
2.2.3.3 Drained Wall Systems	13
2.2.3.4 Drained and Ventilated Wall Systems	13
2.2.4 Cladding Systems	13
2.2.5 Water-resistive Barriers	14

2.3	Control of Air Flow	14	
2.4	Control of Water Vapor Diffusion	15	
2.5	Control of Heat Flow	19	
	2.5.1	Reasons for Exterior Insulation 19	
	2.5.2	Dynamic Thermal Performance and CLT Thermal Mass 19	
3	Recommended Building Enclosure Conceptual Design	22	
	3.1	Exterior Wall Assemblies 22	
		3.1.1	Detailing Installation of Windows and Doors 27
		3.1.2	Detailing Foundation/Wall Intersections and Considerations at Grade 29
		3.1.3	Balconies 30
	3.2	Roof Assemblies 30	
		3.2.1	Water Managed Roof Design Tips 30
		3.2.2	Sloped Roofs 30
		3.2.3	Low-slope Roof Decks and Parapets 33
4	Control of Moisture during Construction	35	
5	Wood Preservative Treatment for Increased Durability	36	
6	Concluding Comments	37	
7	References	38	

List of Tables

- Table 1* Vapor permeance of CLT at different thicknesses and relative humidity levels 7
- Table 2* Thermal resistance of typical softwood at various thicknesses and 12% moisture content 9
- Table 3* Vapor permeance categories 17
- Table 4* Appropriate types of exterior insulation for CLT wall assemblies with vapor permeable WRB and poorly-ventilated or non-ventilated reservoir claddings 18

List of Figures

- Figure 1* CLT panel constructed of three layers of cross-laminated board lumber to create a solid wood panel 1
- Figure 2* Three principal axes of wood with respect to grain direction and growth rings 3
- Figure 3* Generic sorption isotherms for wood from the Wood Handbook 5
- Figure 4* Water vapor permeability of CLT specimens 7
- Figure 5* Best practice rainwater management strategy for CLT wall assembly 12
- Figure 6* Space conditioning energy savings from CLT thermal mass for a two-story single-family residence (left axis), with heating and cooling degree days (right axis) 20
- Figure 7* Space conditioning energy savings from CLT thermal mass for a four-story multi-unit residential building (left axis), with heating and cooling degree days (right axis) 21
- Figure 8* Peak cooling load reduction from CLT thermal mass for a two-story single-family residence and a four-story multi-unit residential building 21
- Figure 9* CLT exterior wall assembly with exterior insulation and ventilated cladding, showing material sequencing and schematic window flashing details 23
- Figure 10* Cladding support strategy using vertical furring through rigid insulation boards 24
- Figure 11* Cladding support strategy using two layers of rigid insulation and two strapping members: this configuration allows for the use of shorter screws and greater insulation thicknesses, while minimizing thermal bridging 25
- Figure 12* Cladding support strategy using low conductivity spacers with screws providing rigid support to hang exterior vertical girt and cladding (used with permission of FPInnovations, RDH Building Engineering, and other partners) 26
- Figure 13* Window installation schematic using sloped wood sill 28

Figure 14 Schematic of CLT wall assembly and concrete foundation at grade 29

Figure 15 Top view of a sloped CLT roof assembly showing material sequencing and transition to a CLT exterior wall with exterior insulation and ventilated cladding (certain roofing materials may require a vented air space between the roofing and the membrane, which can be created using purlins or other methods) 31

Figure 16 Bottom view of a sloped CLT roof assembly showing material sequencing and transition to a CLT exterior wall with exterior insulation and ventilated cladding 32

Figure 17 Low-slope CLT roof detail showing material sequencing of a conventional roofing assembly with tie-in to CLT parapet wall (slope to drains is achieved either by sloping the roof deck or by tapering the rigid insulation) 33

1 INTRODUCTION

Cross-laminated timber (CLT) was developed in Europe for the prefabricated construction of wall, roof, and flooring elements. Adaptation of CLT for use in the United States requires consideration of the different climates, building codes, and construction methods in this country.

CLT panels are typically constructed by laminating three or more layers of lumber together, with each layer oriented 90° relative to the neighboring layers (Figure 1). The lumber is most commonly adhered using a structural adhesive, with or without edge gluing between boards in the same layer. Manufacturing methods and lumber quality may have an impact on the final product properties but they do not affect the overall design strategy.



Figure 1

CLT panel constructed of three layers of cross-laminated board lumber to create a solid wood panel

Building enclosure design has important implications for the energy performance and durability of the structure as well as indoor air quality and occupant comfort. The key performance requirements of the enclosure discussed in this Chapter are prevention of water intrusion and control of heat flow, air flow, and moisture flow. The building enclosure serves a number of other functions, such as providing structural support for the building, controlling solar radiation, noise and fire, and providing an aesthetically pleasing finish. Many of these functions are discussed in other chapters of this Handbook.

Exterior wall and roof assemblies that use prefabricated CLT panels follow the same basic heat, air, and moisture control design principles as all building enclosures. The enclosure separates the interior environment of the building from the exterior environment, so it must handle loads such as precipitation, solar radiation, temperature gradients, humidity gradients, and air pressure differences. Building enclosure design must consider the outdoor climate as well as the intended building use and indoor environment. All building systems and materials can be compromised by water and air infiltration, and by vapor migration should it result in condensation or excessive

moisture levels. Whether it be steel, concrete, masonry, or wood frame, no construction system is immune from the effects of moisture-related problems. These problems can be avoided with thoughtful attention to water management principles and proper enclosure details. Wood has been successfully used to construct durable building enclosures for centuries.

As a building system, CLT has a number of unique characteristics. Prefabrication means that buildings can be constructed quickly, which may reduce the exposure of building components to wet weather. CLT panels have good thermal properties: their thickness provides some level of thermal insulation as well as thermal mass. Although CLT panels may have some inherent level of airtightness, an additional air barrier membrane is recommended (given the possibility that gaps between boards may develop as a result of drying-related shrinkage). The monolithic nature of CLT panels makes it possible to apply a single membrane as the water-resistive barrier and continuous air barrier. CLT panels have a relatively high capacity to store moisture but relatively low vapor permeability. If exposed to excessive wetting during construction or in building service, the panels may absorb a large amount of moisture, and the subsequent drying may be slower than it is for lightweight wood-frame construction.

CLT panels are not a cladding material and are not designed to be exposed to the exterior environment. They are a moisture sensitive structural assembly and therefore must be protected from rain and other moisture sources through the use of properly designed wall and roof assemblies.

This Chapter provides design guidance for CLT building enclosures in U.S. climate zones. The overarching strategies are to prevent wetting of CLT panels by using drained wall systems, to control airflow using an air barrier to the exterior of the CLT panels, to place rigid insulation to the exterior of the panels, to prevent moisture from accumulating within the panels, and to allow the panels to dry should they get wet. In certain climates, preservative treatment of CLT is recommended to provide additional protection against potential hazards such as decay and termites.

2

HEAT, AIR, AND MOISTURE CONTROL STRATEGIES

One of the primary functions of the building enclosure is the environmental separation between conditioned and unconditioned spaces. The enclosure should be designed to keep out liquid water, stop airflow between the interior and exterior, manage water vapor diffusion, and manage heat flow. These functions are important because heat, air, and moisture impact energy performance, durability, indoor air quality, and occupant comfort in all buildings. Several key wood properties are first addressed to provide a foundation for understanding the heat, air, and moisture control strategies for CLT enclosures.

2.1 Wood Properties Related to Heat, Air, and Moisture

Wood is a natural material that has been used successfully as a building material for centuries. Wood, if kept dry, does not deteriorate easily. As a natural material, wood is anisotropic and inhomogeneous; the properties can be different depending on the direction relative to the grain, and properties can also depend on which part of the tree the wood comes from (e.g., sapwood versus heartwood). Figure 2 shows the three principal grain directions in a piece of lumber. Wood shows larger variations in properties than most man-made building materials. The variations are usually larger between different wood species than within the same species. For example, Douglas-fir generally has lower density and lower permeability (higher resistance) to water and vapor movement compared with southern pine species. Softwoods, which are the species mostly used for construction as well as CLT manufacturing in North America (APA, 2011), generally have lower inter-species variations than hardwoods.

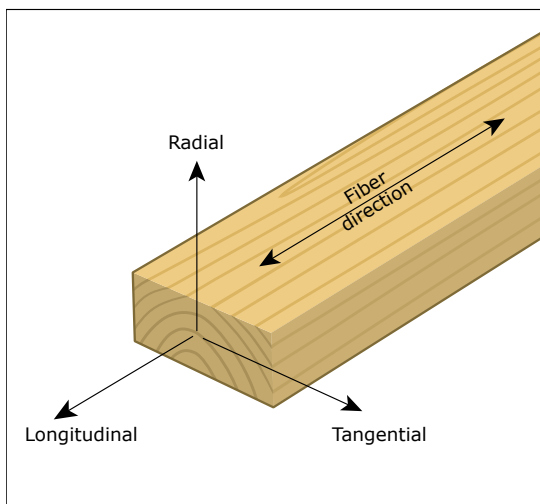

Figure 2

Three principal axes of wood with respect to grain direction and growth rings

The impact of wood property variations is manageable during design and construction. It is usually not possible or necessary to precisely evaluate the moisture and thermal properties of the specific material being used in building design. However, the understanding of these properties becomes more important to the design of CLT building enclosure assemblies than traditional wood-frame assemblies because of the massive solid wood nature of CLT. This section aims at providing generic physical properties of wood to help with CLT building enclosure design and related performance prediction using hygrothermal models.

2.1.1 Density and Specific Gravity

Density (or specific gravity) is one of the most important properties of wood related to building design. Density is defined as the mass of wood divided by the volume of the specimen at a given moisture content, usually expressed in $\text{lb}\cdot\text{ft}^{-3}$ ($\text{kg}\cdot\text{m}^{-3}$ or $\text{g}\cdot\text{cm}^{-3}$). Specific gravity is defined as the ratio of the density of a substance to the density of water at a specified reference temperature, typically 39°F (4°C), where the density of water is $62.43 \text{ lb}\cdot\text{ft}^{-3}$ ($1,000 \text{ kg}\cdot\text{m}^{-3}$ or $1.0 \text{ g}\cdot\text{cm}^{-3}$). If a wood specimen has a density of $31.2 \text{ lb}\cdot\text{ft}^{-3}$ ($500 \text{ kg}\cdot\text{m}^{-3}$ or $0.5 \text{ g}\cdot\text{cm}^{-3}$), it has a specific gravity of 0.5. The specific gravity of most softwood species ranges from 0.3 to 0.6. Specific gravity varies slightly with moisture content because wood undergoes dimensional changes with changing moisture content below about 28-30% (see Section 2.1.3). The values used in design specifications in North America are based on mass and volume under oven-dry conditions (AF&PA, 2005; CSA, 2009). The CLT manufacturing standard (APA, 2011) requires that softwood lumber species or species combinations used for CLT manufacturing have a minimum published specific gravity of 0.35, and that the same lumber species or species combinations be used within a single layer of CLT. The major softwood species or species combinations used for structures in North America, such as SPF (spruce-pine-fir), Hem-fir (hemlock-fir), southern pine, and Douglas-fir, all meet this requirement. The effect on density of the adhesive used to glue boards can be neglected due to the small amount of adhesive compared with the mass of wood.

Density or specific gravity has an important effect on all the physical properties of CLT, including thermal properties, as discussed in Section 2.1.4. The density or specific gravity of CLT can be further assessed based on methods developed for solid wood specimens such as ASTM D2395 (2007b), if the value is critical for building design or hygrothermal modeling.

2.1.2 Moisture Storage and Moisture Transfer

Moisture-related properties of wood are critically important for understanding and predicting the response of CLT building assemblies that are exposed to varying environmental conditions, including precipitation, temperature, humidity, and solar radiation. Understanding the moisture-related properties of wood is essential for designing CLT structures that avoid problems such as mold growth, decay, and dimensional changes.

2.1.2.1 Moisture Content and Fiber Saturation Point

Many physical and mechanical properties of wood vary with moisture content (Stamm, 1964; Siau, 1984; Skaar, 1988; USDA, 2010b). Moisture content is the ratio of the mass of water in wood to the mass of the oven-dry wood, usually expressed as a percentage. In living softwood trees, the moisture content of wood ranges from 30% to over 200%, depending on the species, growth season, and whether it is sapwood or heartwood. The wood starts losing moisture once a tree is cut. At the theoretical point when all the liquid water inside cells (“free water”) is gone but the cell walls are completely saturated with moisture (“bound water” adsorbed to the hygroscopic portions of the cell wall), the wood is considered to be at the fiber saturation point. This point averages about 28-30% on an oven-dry basis, varying by several percentages with wood species and other factors. In practice, the moisture content of wood is rarely homogeneous. Nevertheless, the fiber saturation point is considered as the critical moisture content in the relationships between moisture content and physical or mechanical properties, such as shrinkage and swelling, thermal and electrical properties, and strength. These properties change with moisture content only below the fiber saturation point.

2.1.2.2 Water Vapor Sorption

Wood is hygroscopic and has inherent moisture-storage capacity. It exchanges moisture with the surrounding air under ambient conditions. The amount of moisture gain or loss largely depends on the relative humidity but also on the temperature, drying history of the wood (wood can be made somewhat hydrophobic by intense drying or deliberate high-temperature treatment), and other factors. The loss of moisture is referred to as “desorption” and the gain of moisture as “adsorption”. When the wood no longer gains or loses moisture, it reaches equilibrium moisture content (EMC) under a specific set of environmental conditions. Figure 3 illustrates the relationship between EMC and relative humidity for a few selected temperatures (these curves are known as sorption isotherms). For example, at a temperature of 70°F (21°C), the average equilibrium moisture content is about 12% at a relative humidity of 65%; it decreases to 6% when the relative humidity is 30% and increases to 20.5% when the relative humidity is 90%. Water vapor sorption from air cannot bring the moisture content above the fiber saturation point. Higher moisture contents can occur only through condensation or exposure to other sources of liquid water.

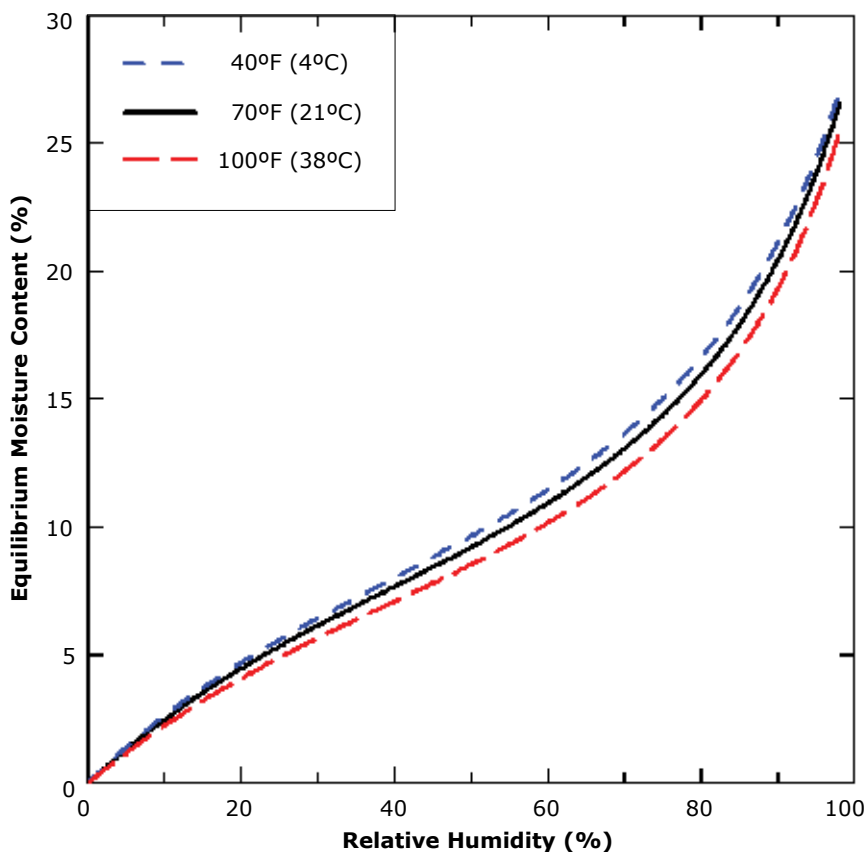

Figure 3

Generic sorption isotherms for wood from the Wood Handbook (USDA, 2010b)

In building service, wood is exposed to both long-term (such as seasonal) and short-term (such as daily) changes in relative humidity and temperature. As a result, the moisture content fluctuates within a range. Wood has a delayed response to changing environment, depending on its size, vapor permeability, the environmental conditions, and coatings or treatment. In a large CLT panel, the moisture content of the surface can change quickly, but it takes much longer time (weeks or months) for the center to show response to the changing environmental condition. The CLT manufacturing standard (APA, 2011) requires that the moisture content of lumber at the time of CLT manufacturing shall be $12\% \pm 3\%$. For structural composite lumber (lumber made from strands, flakes, or veneer), the moisture content shall be $8\% \pm 3\%$ at the time of CLT manufacturing. Typical EMCs of wood materials

within building enclosures are from 8% to 12%. This means that, to adjust to typical building service conditions, CLT panels exhibit only small changes in moisture content after installation, depending on the outdoor and indoor conditions. The hygric capacity of CLT can be advantageous in that CLT enclosures can buffer or accommodate short-term changes in humidity and temperature, unlike metal-framed enclosures. However, when CLT panels are subjected to extremely low or high levels of humidity or liquid water during installation and building service, wood may significantly lose or gain moisture. This will increase the risk of dimensional change-associated defects such as checking and warping and should therefore be avoided. Dimensional changes are discussed further in Section 2.1.3.

2.1.2.3 Water Vapor Permeability

Vapor permeability describes the rate of moisture transfer through a material under a gradient in water vapor pressure. This property can also be expressed as vapor permance for a given thickness (the reciprocal of vapor permance is vapor resistance).¹

This important property is associated with two major strategies of building enclosure design: to minimize moisture accumulation within the building enclosure, and to maximize drying capability by generally using materials with high vapor permeability. These two strategies may conflict, and it is important to coordinate them in design. Section 2.4 discusses control of water vapor diffusion in more depth.

Vapor permeability values in the literature are typically based on standard tests such as ASTM E96-05 (2005) using wet-cup and dry-cup methods. The vapor permeability of a number of solid wood species and wood-based products (e.g., plywood and oriented strand board) has been measured and incorporated into hygrothermal models. Two important trends are highlighted. First, vapor permeability increases with increasing relative humidity (or increasing moisture content). This is also generally observed for other hygroscopic materials such as building paper, plaster, and masonry. Second, at a given relative humidity, the vapor permeability of solid wood in the longitudinal direction (with the grain) is much greater than that in the transverse directions (across the grain). Vapor diffusion through the thickness of the CLT panel is across the grain, and measurements for this direction are given below. More rapid diffusion with the grain may be beneficial because it means that if wetting occurs at one location, moisture can be redistributed through the panel more quickly, which could allow faster drying.

Specimens as thick as full CLT panels are not suitable for testing according to standard test methods; however, thinner sections taken from CLT panels have been characterized. Figure 4 shows the vapor permeability of ¾ in. (19 mm) thick specimens cut from SPF and Hem-fir CLT panels, which include one layer of adhesive (NRC, 2012). The measurements were done through the panel thickness (across the grain). Just like solid wood or plywood, the vapor permeability of CLT increases with increasing relative humidity. Values range from 0.09 perm in. ($0.1 \text{ ng}\cdot\text{m}^{-1}\cdot\text{s}^{-1}\cdot\text{Pa}^{-1}$) at 10% RH to 5.7 perm in. ($8.3 \text{ ng}\cdot\text{m}^{-1}\cdot\text{s}^{-1}\cdot\text{Pa}^{-1}$) at 90% RH. It was observed that wood species or the type of adhesive used for CLT manufacturing did not have an appreciable effect on the vapor permeability.

¹The I-P unit for vapor permance is the “perm”; 1 perm is equivalent to $1 \text{ grain}\cdot\text{ft}^{-2}\cdot\text{h}^{-1}\cdot(\text{in. Hg})^{-1}$. At 73°F (23°C) where laboratory permance measurements are typically performed, $1 \text{ perm} = 57.4525 \text{ ng}\cdot\text{m}^{-2}\cdot\text{s}^{-1}\cdot\text{Pa}^{-1}$ (Thompson and Taylor 2008; note that the conversion from in. Hg to Pa is temperature dependent). The I-P unit for vapor permeability is the “perm inch”; 1 perm in. is equivalent to $1 \text{ grain}\cdot\text{in.}\cdot\text{ft}^{-2}\cdot\text{h}^{-1}\cdot(\text{in. Hg})^{-1}$. At 73°F (23°C), $1 \text{ perm in.} = 1.45929 \text{ ng}\cdot\text{m}^{-1}\cdot\text{s}^{-1}\cdot\text{Pa}^{-1}$.

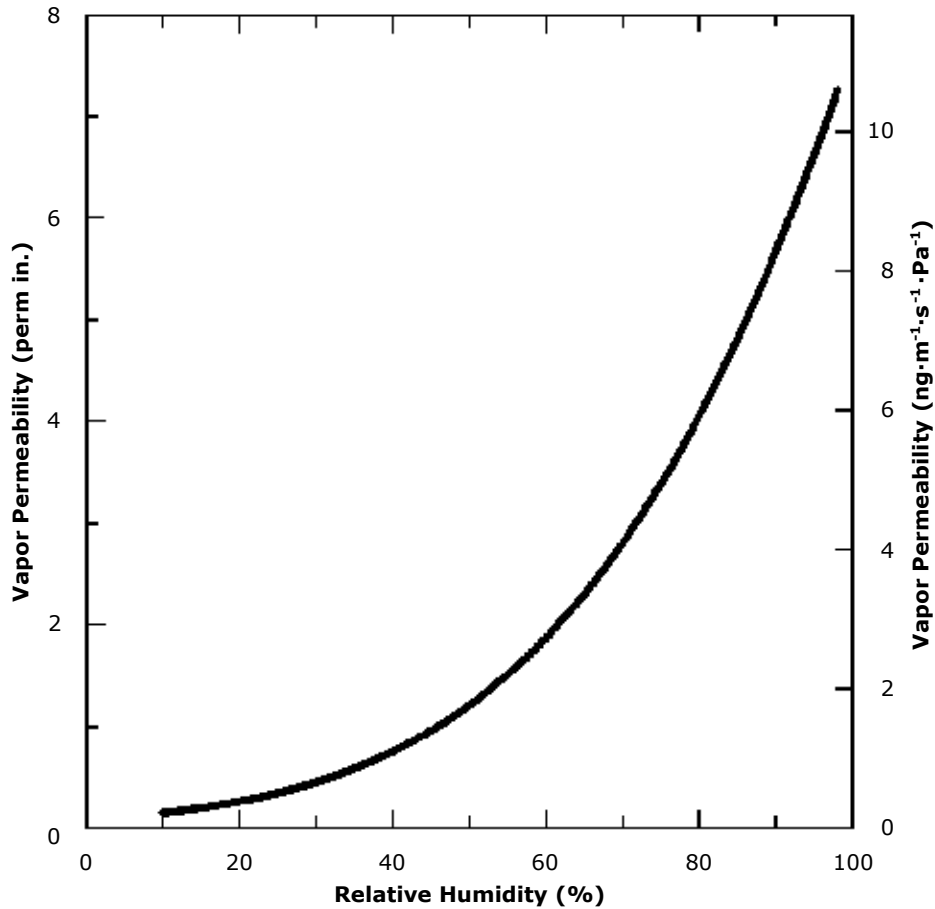

Figure 4
Water vapor permeability of CLT specimens (NRC, 2012)

Table 1 gives the vapor permeance values of CLT at different thicknesses. Based on these permeance values, typical CLT panels would be considered vapor impermeable or semi-impermeable and function as Class I or Class II vapor retarders in building enclosure assemblies based on the definitions of these terms adopted by the International Energy Conservation Code (IECC) (Lstiburek, 2006b). In many circumstances, no additional vapor retarder or barrier is therefore required to meet the building code (Gagnon et al., 2011). Note that the need for an air barrier is a separate issue (see Sections 2.1.5 and 2.3).

Table 1
Vapor permeance of CLT at different thicknesses and relative humidity levels (based on NRC, 2012)

Relative Humidity %	Vapor Permeance, U.S. perms (ng·m ⁻² ·s ⁻¹ ·Pa ⁻¹)		
	4 in. (100 mm)	6 in. (150 mm)	8 in. (200 mm)
20	0.06 (3.4)	0.04 (2.3)	0.03 (1.7)
50	0.31 (18)	0.21 (12)	0.15 (9.0)
80	1.00 (59)	0.68 (39)	0.51 (30)

2.1.2.4 Liquid Water Absorption

Wood absorbs liquid water (by capillary suction) when it is exposed to rain, condensation, or other wetting sources. The ability to absorb and the rate of absorption are closely associated with its permeability to liquid water, varying greatly with species, grain orientation, and prior history of wetting and drying. Such properties highly depend on the micro-structures such as the size of cells, pits (openings) between cells, and presence of extractives (Stamm, 1964; Siau, 1984; Skaar, 1988). For example, wood tends to be less permeable when a high proportion of the pits are closed or plugged with extractives, as in the heartwood of many species. The sapwood of North American Western and Northern species or species combinations such as SPF, Hem-fir, and Douglas-fir generally has lower permeability than the sapwood of the southern pines, and the former species also have greater proportions of low permeability heartwood.

Compared with water vapor sorption, liquid water absorption can lead to rapid increase in moisture content. Therefore, exposure to excessive liquid water should be minimized during transport, storage, construction, and building service to prevent adverse impacts on durability. The same can be said in general for many other building materials. The actual moisture content that wood reaches when exposed to liquid water mostly depends on its permeability to liquid water. In highly permeable woods, the maximum moisture content (at which all the cell cavities are filled and which depends on porosity or density) may be reached in some parts of the material. For wood with low permeability, it is very difficult for water to penetrate deep into wood and fill every cell, even under high pressure conditions (Wang et al., 2012).

For a given specimen, water absorption is usually much more rapid in the longitudinal direction, i.e., through end grain, than in the transverse (radial and tangential) directions (Siau, 1984; Skaar, 1988). The implications for control of moisture during construction are discussed in Section 4. Water absorption rates can be measured by a method based on the International Standard ISO 15148 (2002). An associated index, liquid water diffusivity, is often calculated based on water absorption coefficients (Straube and Burnett, 2005).

2.1.3 Dimensional Changes

Wood shrinks when it loses moisture and swells when it gains moisture at moisture content below the fiber saturation point. Wood shrinks or swells more across the grain than lengthwise. Dimensional changes are greater in the direction of the annual growth rings (tangential), about half as much across the growth rings (radial), and usually very slight along the grain (longitudinal) (USDA, 2010b). For example, the average shrinkage of spruce from fiber saturation point to oven-dry state (with moisture content change from 30% to 0%) is about 7-8% in the tangential direction, 4% in the radial direction, and 0.1-0.2% in the longitudinal direction (USDA, 2010b). Wood used in construction and similarly in CLT manufacturing always has a mixture of growth ring orientations. It is recommended to use an average shrinkage coefficient of 0.2-0.25% per 1% change in moisture content for cross sections of most softwood lumber (Breyer et al., 2006; NIST, 2010). With care in manufacturing, transport, storage, and construction, the moisture content will only change within a small range, and consequently the shrinkage will be much smaller. For example, if the lumber has an average moisture content of 12% during CLT manufacturing and the equilibrium moisture content in service is 10%, the moisture content change is 2%, which is associated with potential shrinkage of around 0.4-0.5% in the thickness direction of the CLT panel. Although the potential shrinkage in the width direction of the individual boards would be the same as that in the thickness direction, the cross lamination of boards in CLT panels minimizes the in-plane dimensional changes due to the good longitudinal stability of the adjacent lamina, as in plywood (Carll and Wiedenhoef, 2009; CertiWood™, 2012). Experience with multi-story CLT buildings in Europe has shown that vertical shrinkage is typically only about 1/8 in. (3 mm) per story.

The shrinking and swelling of individual boards in CLT can cause warping and checking on the CLT panel surfaces if large moisture content changes occur. Research (Gereke et al., 2009) has shown that the use of thicker outer layers could result in increased cupping of the panel, and that careful arrangement of lumber with respect to its growth ring orientation may improve the dimensional stability of a CLT panel.

Wood undergoes thermal expansion in addition to the moisture-related dimensional changes discussed above. Wood expands when heated and contracts when cooled. This effect is considerably smaller than moisture-related dimensional changes. Under most conditions for buildings, dimensional changes in wood are dominated by moisture effects (USDA, 2010b).

2.1.4 Heat Storage and Heat Transfer

Heat (storage) capacity is the amount of energy required to increase the temperature of one unit of mass by one degree, often expressed in $\text{Btu}\cdot\text{lb}^{-1}\cdot^{\circ}\text{F}^{-1}$ (or $\text{J}\cdot\text{kg}^{-1}\cdot\text{K}^{-1}$). The heat capacity of wood depends on the temperature and moisture content but is practically independent of density or wood species (USDA, 2010b). Density is important, however, when considering heat capacity on a volume basis (as opposed to a mass basis). More information about calculation and measurements of specific heat capacity is available in the literature (TenWolde et al., 1988; Kumaran et al., 2002; Carmeliet et al., 2003; ASHRAE, 2009; USDA, 2010b). Compared with light-frame construction, the thermal mass of CLT can help moderate heating and cooling energy consumption in certain climates, as discussed in Section 2.5.

Thermal conductivity describes the rate of heat flow through a material under a gradient in temperature, often expressed in $\text{Btu}\cdot\text{in}\cdot\text{h}^{-1}\cdot\text{ft}^{-2}\cdot^{\circ}\text{F}^{-1}$ (or $\text{W}\cdot\text{m}^{-1}\cdot\text{K}^{-1}$). Thermal conductance for a given thickness is the thermal conductivity divided by thickness. Thermal resistance is the reciprocal of conductance, often expressed in imperial R-value ($\text{h}\cdot\text{ft}^2\cdot^{\circ}\text{F}\cdot\text{Btu}^{-1}$) or international system RSI ($\text{m}^2\cdot\text{K}\cdot\text{W}^{-1}$); these can be interconverted using $R = 5.678 \text{ RSI}$.

The thermal conductivity of wood depends on a number of variables, such as grain orientation, wood moisture content, and density. For building enclosure applications, heat flow is typically across the grain, and a moisture content of 12% is commonly assumed. The thermal conductivity of commonly used structural softwood lumber at 12% moisture content ranges from 0.7 to 1.0 $\text{Btu}\cdot\text{in}\cdot\text{h}^{-1}\cdot\text{ft}^{-2}\cdot^{\circ}\text{F}^{-1}$ (0.10 to 0.14 $\text{W}\cdot\text{m}^{-1}\cdot\text{K}^{-1}$) (TenWolde et al., 1988; ASHRAE, 2009; USDA, 2010b). This is much lower than other structural materials such as metals and concrete (about one twentieth that of steel), and it is only about 2 to 4 times that of common insulation materials. The measured thermal conductivity of CLT specimens made with SPF and Hem-fir (NRC, 2012) is consistent with the reported values of solid wood. CLT panels can add a fair amount of thermal resistance to building enclosure assemblies depending on thickness. Table 2 provides design R-values for softwood CLT panels of various thicknesses.

Table 2

Thermal resistance of typical softwood at various thicknesses and 12% moisture content

Thickness	1 in. (25 mm)	4 in. (100 mm)	6 in. (150 mm)	8 in. (200 mm)
R-value ($\text{h}\cdot\text{ft}^2\cdot^{\circ}\text{F}\cdot\text{Btu}^{-1}$)	1.25	5.00	7.50	10.00
RSI ($\text{m}^2\cdot\text{K}\cdot\text{W}^{-1}$)	0.22	0.88	1.30	1.80

2.1.5 Air Permeability

Air permeability refers to the rate of air flow through a material under a gradient in air pressure. This property can also be expressed as air permeance for a given thickness. Wood-based structural panels such as plywood and oriented strand board have inherent low permeability to air flow (Kumaran et al., 2002; Carmeliet et al., 2003; Lstiburek, 2006a). In wood-frame building enclosure assemblies, these panels can function as components in an air barrier system provided gaps between panels are properly sealed (i.e., with sheathing tapes or sealant). If CLT is to be used as the air barrier (which is not recommended here), the airtightness of CLT building enclosure assemblies will depend mainly on the joints between individual CLT panels, whether there are gaps between individual boards or layers, and whether checking and gaps between boards occur resulting from wood shrinkage (Gagnon et al., 2011; Skogstad et al., 2012). Based on the measurement of air permeability of CLT specimens made with different wood species using a modified ASTM C522-03 method (2009), the air permeability is

negligible provided no visible gaps or checking exist in the CLT specimen (NRC, 2012). However, gaps between boards within full size panels may develop, which could result in air flow. Section 2.3 discusses control of air flow in greater detail.

2.1.6 Moisture and Wood Durability

Durability of wood components in the context of this Chapter means resistance to biodeterioration. A number of biological agents including decay fungi and insects can attack wood and cause structural degradation under suitable conditions (Morris, 1998; Carll and Highley, 1999; USDA, 2010a). On a national scale in the United States, decay fungi are a larger threat than insects (including termites) (USDA, 2010a). The key conditions for fungi to grow in wood include suitable moisture conditions and suitable temperature. Generally, it requires free water inside wood cells for decay fungi to grow and progress. Research (Wang and Morris, 2010; Wang et al., 2010) has shown that decay fungi can colonise kiln-dried wood products if the moisture content rises to a threshold of 26%, which can be considered as the low end of fiber saturation point; it then takes months for detectable structural damage to occur under such marginal conditions. However, when there is more free water available with moisture content ranging from 40% to 80%, strength loss can occur rapidly (in weeks in some susceptible wood species). Preventing extended exposure to excessive moisture is the key to preventing decay throughout the service life of buildings. Compared with decay, mold growth occurs on surfaces and is more associated with the relative humidity of the environment and the surface relative humidity of building components. It does not affect wood strength. The infestation of insects may also require certain moisture conditions. Termites, in particular the Formosan subterranean termite (*Coptotermes formosanus*), can be very destructive to wood structures in areas with termite hazard (USDA, 2010a). However, methods exist to prevent termite infestation, and wood buildings have performed well in such areas.

Sapwood of all wood species has low natural durability. Heartwood is generally more durable than sapwood. Wood species vary widely in the natural durability of their heartwood (USDA, 2010a). The heartwood of SPF and Hem-fir species is not durable, while the heartwood of Douglas-fir and western larch is moderately durable. The heartwood of species such as western red cedar, California redwood (old growth) and yellow cedar has high natural resistance to decay. The heartwood of yellow cedar and California redwood (old growth) also has high resistance to termites. When the wood is not naturally durable enough to prevent attack by decay fungi or insects in building service, it can be treated with preservatives to improve long-term durability. Section 5 provides more information on preservative treatment.

2.2 Exterior Water Management

The most important function of the building enclosure is to keep water out. Water intrusion in buildings has long been a major cause of construction related defects, whether they be steel, concrete, masonry, or wood-frame buildings. No construction system is immune to the effects of moisture-related problems. These problems can be avoided with thoughtful attention to water management principles and proper enclosure details.

There are well-designed, well-built, and well-maintained wood structures that are centuries old and still in service today. As with all building materials and systems, care must be taken in the design and construction of CLT building systems to avoid moisture-related problems.

Water management starts with minimizing the amount of moisture brought into the building enclosure with the construction materials. As discussed above, moisture management protocols for CLT enclosures start at the time of manufacture. The APA (2011) standard governs panel moisture content at the time of manufacture. Applying water repellents to end grain of CLT panels and other wood-based materials may effectively retard liquid water absorption; however, film-forming coatings may also retard drying. With or without such treatment, CLT panels must be protected from water during shipping, storage, and construction. Section 4 addresses moisture control during construction in further detail. A number of references provide general guidance on moisture control in buildings (ASHRAE, 2009; Brock, 2005; HPO, 2011; Lstiburek, 2006c; Lstiburek and Carmody, 1994; Rose, 2005; Straube, 2012; Straube and Burnett, 2005; Trechsel and Bomberg, 2009).

2.2.1 Moisture Transfer Mechanisms

Understanding how building materials get wet and dry out is crucial to designing and building long lasting, durable enclosures. There are four major mechanisms of moisture movement in buildings:

1. Liquid water flow, such as gravity-driven water intrusion through enclosure leaks;
2. Capillary action, which is the movement of water within the spaces of a porous material due to the forces of adhesion, cohesion, and surface tension. This can occur when porous materials are wetted by precipitation or are in contact with wet ground;
3. Airflow, which carries water vapor. Infiltration refers to air leakage into the building through the enclosure; exfiltration refers to outward air leakage;
4. Water vapor diffusion, resulting from differences in water vapor pressure between indoor and outdoor environments.

All four of the mechanisms above can wet building components, but water intrusion is usually the largest source of wetting and the most important to address. Water intrusion can be prevented by proper design, detailing, and assembly of building materials as outlined later in the Chapter. However, building materials get wet, drying can occur by drainage, airflow, evaporation, and diffusion. The key to durability is to reduce wetting and promote drying.

The relationships between air flow, surface temperatures of building materials, insulation systems, vapor diffusion, and drying rates of materials and assemblies are complicated. Developing a working understanding of these interwoven relationships is necessary in order to design and build any structure that is durable, energy efficient, and healthy to live and work in. Air flow is discussed in further detail in Section 2.3, vapor diffusion in Section 2.4, and heat flow in Section 2.5.

2.2.2 Water Management Strategies for Walls

Water management for CLT construction generally follows the same principles used in wood-frame construction or in other construction types. Rainwater coming in contact with the building enclosure can follow a number of different pathways:

- being deflected away from the enclosure by a water-shedding structure or surface;
- bypassing the water-shedding surface and be drained away from the enclosure by way of a drainage cavity, water-resistive barrier (WRB), and flashings;
- being absorbed and stored by porous building materials (and possibly transferred by capillary action or diffusion to other materials in the assembly); or
- intruding past the enclosure into the building.

The building enclosure must be designed to prevent water intrusion into moisture-sensitive materials. Water management strategies are generally based on deflection, drainage, drying, and durable materials (Hazleden and Morris, 1999):

Deflection: The first priority is to deflect as much rainwater away from the building as possible before it has a chance to penetrate the building enclosure. Roof overhangs, kick-out flashings at roof-wall intersections, drip edges, and sloping surfaces direct water down and away from the enclosure.

Drainage: Create pathways for water to easily drain from the assembly so it has less time to be absorbed by building materials.

Drying: Design the enclosure with assemblies that have the capability to dry. The use of a ventilated cavity between the cladding and the rest of the assembly reduces moisture transfer from the cladding into the assembly and improves the drying potential of the assembly.

Durable materials: Select naturally durable wood species or use preservative-treated wood where necessary (see Section 5 of this Chapter).

Drainage and drying strategies are illustrated in Figure 5, which shows a ventilated and drained cladding system where the primary cladding and secondary drainage planes are provided in addition to ventilation behind the cladding.

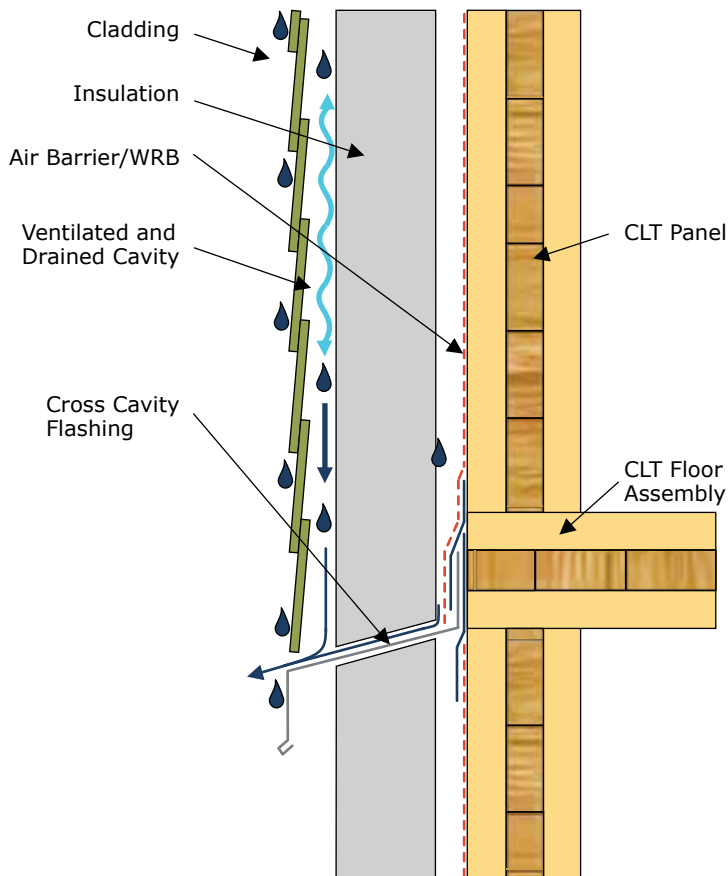

Figure 5
Best practice rainwater management strategy for CLT wall assembly

2.2.3 Approaches to Water Management in Exterior Walls

There are several approaches to water management for exterior walls, as described below.

2.2.3.1 Face-sealed Systems

The success of this approach requires perfect design, meticulous sealing of all penetrations and material interfaces at the exterior face of claddings, and a rigorous program of maintenance. This system is both labor and material intensive. It also is typically the least effective in the long term because expecting perfection is unrealistic and the system has no redundancy. If the sealant fails or separates from other materials as is common over the service life of the assembly, leaks will occur. Face-sealed systems are not recommended for CLT enclosures in any climate.

2.2.3.2 Storage or Mass Systems

This approach is traditionally used in thick stone or masonry walls. Water that does not drain away is absorbed and, in the absence of freeze-thaw cycles, safely retained until it can evaporate. The assembly must have sufficient safe moisture storage capacity (with no deterioration) to prevent moisture from being transmitted all the way to the interior. This approach is clearly not appropriate for CLT construction.

2.2.3.3 Drained Wall Systems

This approach assumes that claddings leak and that some water will breach the cladding. This system requires a water-resistive barrier (WRB) and drainage plane that is skillfully integrated in shingle fashion with window, door, through-wall, and all other flashings in order to drain water by gravity to the exterior. A 1/16 in. (1 mm) gap was shown to provide drainage reasonably well (Straube and Smegal, 2007). Adhered veneers, such as adhered masonry veneer, stucco, or stone often require two layers of WRB to allow drainage and prevent buildup of hydrostatic pressure. Three-dimensional “drainage wraps” and matrix materials can also aid in drainage and prevent inward moisture movement by capillary action. When rigid foam insulation is placed to the exterior of the WRB, use of a “drainage wrap” or grooves cut in the back of the foam insulation can enhance drainage and facilitate drying by diffusion (Lstiburek, 2010a). WRBs are described further below.

2.2.3.4 Drained and Ventilated Wall Systems

An important variation on the drained wall system is commonly known as a “rain screen”. This system employs a cavity directly behind the cladding, which creates a larger path for gravity drainage and allows ventilation airflow for improved drying (Figure 5). Rain screen systems are considered the most effective for drainage of water and for drying of transmitted moisture. They are required by the building codes for the wet-climate coastal areas of Canada and many other countries. The unfilled air space separates the cladding from the WRB and the structural wall assembly behind it. This air cavity promotes drainage and provides a capillary break to eliminate absorption of water into inner enclosure materials. This cavity also allows for airflow which further helps to dry the cladding and the rest of the wall assembly if it gets wet (Hazleden and Morris, 2001). A ventilated rain screen cavity can be designed to be pressure moderated, which reduces the potential for water being transmitted into the assembly by pressure differentials across the cladding. The most common example of a rain screen system in the United States is brick masonry veneer with the code required drainage cavity, as well as through-wall flashing and weep holes for drainage and ventilation.

The choice between a simple drained wall system and a rain screen system may depend on a variety of factors. A primary consideration is the amount of wind-driven rain to which walls are exposed, which depends on climate, building height, and roof design. Taller buildings generally have higher exposure to wind-driven rain than shorter buildings. Exposure of walls to wind-driven rain generally decreases as the extent of roof overhang increases, particularly for low-rise buildings. The drying potential of the climate is another consideration. In addition to these factors, a practical consideration for walls with exterior insulation is attachment of the cladding system.

2.2.4 Cladding Systems

Many different cladding systems can be applied using a rain screen system. For cladding attachment, continuous vertical furring (strapping) strips can be screwed through the rigid insulation to the CLT panel and the cladding can then be attached to the furring with short fasteners (CCHRC, 2009; Baker, 2012). Depending on loading conditions, a structural analysis of this cladding attachment scheme may be required. The gap between the furring strips creates an air space behind the cladding, which is beneficial for both drainage and ventilation. This air space should then be at minimum vented and drained (opened at the bottom) or ideally ventilated and drained (i.e., by providing openings in the cladding at both the top and bottom).

The practice of back-ventilating sidings such as wood, hardboard, and cement board is strongly recommended by most manufacturers to better ensure the stability and long-term performance of their products. It is also beneficial to provide an outlet for moisture driven inward by solar heating from more absorptive claddings such as brick, stucco, stone, and other porous materials.

The extent of airflow and drying capability in a ventilated cavity depend in part on the net free area of vent openings. For example, claddings attached to ¾ in. (19 mm) strapping, such as wood siding, cement board, or stucco applied over backer board, with continuous vents at top and bottom have much higher ventilation rates than brick veneer with a 1 in. (25 mm) cavity and weep holes spaced every two bricks at top and bottom (Burnett et al., 2004; Finch and Straube, 2007).

The cladding surface will shed the majority of the rainwater load on the wall; however, it is not the only line of water penetration resistance. Moisture that does penetrate past the cladding will either run down the backside of the cladding, the strapping, the surface of the exterior insulation if present, or the final line of protection, i.e., the lapped and sealed WRB. Any moisture that penetrates the cladding must then be drained back out of the assembly using flashings attached to the CLT panel behind the WRB at floor levels and around penetrations such as windows.

2.2.5 Water-resistive Barriers

The function of the WRB in a drained wall system is to prevent water that has bypassed the cladding and exterior insulation from intruding further into the wall. The WRB is an essential part of the drainage plane. This protective barrier must be properly overlapped between sheets, and integrated with window flashings and other flashings to shed water to the exterior. It must also be sealed at all plumbing, mechanical, electrical, and structural penetrations. Section 3 provides a series of details showing integration of the WRB with such flashings.

In most cases, the same material can function as the WRB and the air barrier, as discussed further in Section 2.3. A number of different materials can do this: self-adhered membranes, fluid-applied membranes, or mechanically-fastened building wraps (such as a non-perforated polyolefin membrane). Primary considerations in selecting a WRB are its resistance to liquid water and resistance to airflow. An additional consideration is vapor permeance of the WRB/air barrier, which is discussed in Section 2.4. Vapor permeable products promote faster outward drying of CLT assemblies, should they get wet during transport, storage, or construction. Perforated building wraps are not recommended because they are less resistant to water intrusion and do not qualify as air barrier materials.

2.3 Control of Air Flow

After stopping water intrusion, stopping air flow is the most important job of the enclosure because moving air carries heat and water vapor. Uncontrolled air leakage through the enclosure can cause unwanted heat loss or heat gain as well as unwanted moisture accumulation or interstitial condensation, which can lead to mold growth or even decay. Air leakage can thus negatively impact building energy performance, durability, indoor air quality, and occupant comfort.

Air flows are driven by differences in air pressure. A number of different physical forces can create air pressure differences:

- Wind and the associated airflows around the outside of a building create complicated pressure fields. The outside of the building is typically at positive pressure relative to the inside of the building on the windward side and at negative pressure on the leeward side;
- The stack effect refers to buoyancy caused by differences in air density between indoor and outdoor air. Air density (at a given barometric pressure) depends primarily on temperature: warm air has a lower density than cold air. In cold weather, warmer indoor air leaks out at the top of the building and cold air infiltrates at the bottom. In hot weather, the opposite occurs in air-conditioned buildings: warmer outdoor air leaks in at the top and cooler indoor air leaks out at the bottom. Stack effect pressure depends on the height of the building; it increases as buildings get taller;
- Mechanical equipment for heating, ventilation, and air-conditioning (HVAC) can also create air pressure differences across the enclosure. For example, fans for exhaust or supply air ventilation and duct leakage can create pressure imbalances across the enclosure.

Stopping air flow through the enclosure requires a continuous air barrier system over the entire building enclosure, which includes roofs, walls, and floors. Such a system can be made up of a series of overlapping and sealed materials, each with high resistance to air flow (low air permeance). It is essential that the system be continuous to minimize air leakage at interfaces between different materials. As mentioned in Section 2.1.5, measurements have shown that CLT panels themselves initially can have extremely low air permeance. If the CLT panels are to be used as part of the air barrier assembly within a building (not recommended here), appropriate measures such as flexible sealant joints between CLT panels and other elements of the air barrier assembly would be required for air barrier continuity.

The issue of whether CLT panels remain airtight in service has not been determined yet. Gaps between individual boards or layers and checking in boards may occur due to dimensional changes during storage, transportation, and construction as a result of drying or cyclical wetting and drying. It is reasonable to expect that manufacturing processes such as edge-gluing between boards help improve the long-term airtightness of the panels. However, in most cases, it would be prudent not to rely on the CLT panels themselves being the primary air barrier.

Considering that CLT panels must be protected with a water-resistive barrier (see Section 2.2), it is recommended that the WRB serve as the primary air barrier as well. The effective implementation of the air barrier system would then rely on the details to achieve continuity at exterior wall penetrations such as windows or doors, as well as at interfaces with floors, ceilings, balconies, decks, roofs, interior partitions, and various structural, mechanical, electrical, and plumbing penetrations. The details for such transitions would be similar to those used in traditional wood-frame construction.

Air sealing from the inside is also an option, using gypsum board with sealants or gaskets, sometimes referred to as the airtight drywall approach. However, this approach is not preferred as the primary air barrier because of the difficulty of executing a continuous seal at the interior, which typically has many intersecting materials.

Moving air carries water vapor along with it. If uncontrolled, this could lead to moisture accumulation in building enclosure assemblies by either of the following two ways:

1. Exfiltration during cold weather—humid indoor air leaks out and moisture accumulates in cold CLT members. Making the enclosure airtight and placing the thermal insulation to the exterior of the CLT practically eliminates the chances of this occurring. CLT panels stay warm and dry when insulation is to the exterior (see Section 2.5);
2. Infiltration during hot, humid weather—humid outdoor air leaks in and moisture accumulates in CLT panels, which are colder than outdoors because of air-conditioning. An air barrier system on the exterior side of the CLT minimizes the chances of this occurring. As previously discussed, a practical solution is to use a continuous membrane on the exterior of the CLT that functions as an air barrier and water-resistive barrier.

An airtight building must be provided with a mechanical ventilation system for ensuring indoor air quality. Further information about ventilation can be found in the *ASHRAE Handbook – Fundamentals* (ASHRAE, 2009). Local building codes typically address ventilation requirements.

2.4 Control of Water Vapor Diffusion

The two key strategies for moisture control in buildings are 1) to prevent materials from getting wet; and 2) to maximize their capability for drying in the event they do get wet. Other sections of this Chapter deal with preventing CLT panels from getting wet during construction (Section 4), during building service by liquid water (precipitation or capillary action, see Section 2.2) or by water vapor carried by airflow (Section 2.3). This Section deals with vapor diffusion, addressing its role in both wetting and drying.

Given the importance of vapor diffusion for drying, it is generally desirable to make CLT enclosure assemblies vapor permeable. The vapor permeability of CLT increases with increasing relative humidity, as depicted in Figure 4 and discussed in Section 2.1.2. This property is advantageous in the sense that when CLT gets wet, moisture transfer occurs at a faster rate, enabling redistribution of moisture and drying. However, this drying capability should not be relied on as a justification for allowing CLT to get wet. Therefore, the designer should evaluate the potential impacts of using low-permeance materials in building enclosures incorporating CLT. Decisions regarding the exterior insulation and WRB/air barrier, for instance, may benefit from project-specific hygrothermal analysis. Low-permeance materials will impede drying but may be necessary in some cases for preventing moisture accumulation in CLT.

Moisture accumulation in CLT could potentially occur by either of the following two ways:

1. During cold weather (in heating-dominated climates), when indoor vapor pressure is greater than outdoor vapor pressure (outward vapor drive), moisture might accumulate at the cold side of the assembly if the rate of diffusion into the assembly exceeds the rate of diffusion out of the assembly. In lightweight wood-frame construction, the phenomenon can occur in the exterior sheathing (OSB for example) if the interior side is too vapor-permeable and the insulation is placed in the stud cavity. However, when exterior insulation is placed outside the OSB in a wood-frame wall, the OSB sees a higher temperature and lower moisture content. CLT exterior walls differ from wood-frame walls in that vapor diffusion through CLT is much slower than through gypsum board and fibrous insulation, slow enough that it does not lead to high moisture levels. As in log home construction, the massive nature of a CLT panel will control the rate of vapor flow through the assembly. As shown previously in Table 1, the vapor permeance of a softwood CLT panel 4 in. (100 mm) thick or greater is less than 0.5 U.S. perms ($29 \text{ ng}\cdot\text{m}^{-2}\cdot\text{s}^{-1}\cdot\text{Pa}^{-1}$) at normal indoor humidity levels (typically less than 60% RH). Moreover, field and laboratory research as well as hygrothermal modeling indicate that, in cold climates, no additional interior vapor retarder is needed to prevent excessive moisture levels in CLT walls with exterior insulation (Lepage, 2012; McClung et al., 2012). In summary, CLT walls are expected to perform very well in cold climates when insulation is to the exterior and there is no additional interior vapor retarder;
2. During warm, humid weather, when outdoor vapor pressure is greater than indoor vapor pressure (inward vapor drive), moisture might accumulate if the interior side of the assembly is too low in permeance relative to the exterior side of the assembly. In wood-frame construction, this problem has been observed when low-permeance materials such as polyethylene or vinyl wall covering are used on the interior. It is critical that inward drying not be impeded. Laboratory research and hygrothermal modeling have shown that CLT walls, with vapor-permeable exterior insulation and a vapor-permeable interior finish, are expected to perform well in a hot, humid climate (Goto et al., 2011). Hygrothermal modeling by the authors (unpublished data) of CLT walls with non-reservoir claddings in hot, humid U.S. locations confirms this finding.

However, inward vapor drive can be magnified considerably when the cladding acts as a moisture reservoir. Reservoir claddings include brick veneer, stone veneer, stucco, uncoated cement board, uncoated wood, etc. The phenomenon of solar-driven inward moisture diffusion in walls with such absorptive claddings is well-documented (Derome, 2010). In some cases, coatings may be used to limit rain absorption in such claddings. The magnitude of the inward vapor drive also depends on the climate—for example, the amount of wind-driven rain that hits the wall, whether the rain occurs significantly during the warmer months of the year, and how quickly solar irradiance increases after rain. Much of the eastern United States has such weather patterns. Inward vapor drives are most significant in the southeastern United States, but can also be significant even in the upper Midwest and Northeast, as discussed below.

Two methods are generally recommended to limit inward moisture flows from reservoir claddings: 1) back ventilation of the cladding; or 2) placement of a non-moisture-sensitive, low-permeance material between the cladding and the rest of the assembly, such as extruded polystyrene insulation. Back ventilation of claddings is achieved by creating a cavity between the cladding and the rest of the assembly that is open to airflow (see Section 2.2). Brick veneer, for example, is typically installed with a drainage cavity and weep holes. Air exchange rates in brick veneer cavities are typically much smaller than in cavities that have larger openings at top and bottom, such as wood siding or cement board installed on furring strips (Burnett et al., 2004; Finch

and Straube, 2007). Back ventilation may not be a reliable strategy for brick veneer constructed using common practice, given the lower air exchange rates and the possibility of localized areas where mortar bridges the cavity. Adhered veneers such as stucco and manufactured stone veneer can be installed on backer board over furring strips to create a ventilated cavity.

For brick veneer and for other reservoir claddings that are not installed with a ventilated cavity, the designer should consider the second method—use of a low-permeance material between the cladding and the rest of the assembly. This material could be the exterior insulation or the WRB/air barrier. For CLT assemblies, a vapor permeable WRB/air barrier membrane is desirable, specifically to allow drying of construction moisture (prior to installation of exterior insulation and cladding) and to allow drying in service when conditions are favorable. Therefore, the use of vapor semi-impermeable exterior insulation is preferred when reservoir claddings are used in climates with significant wind-driven rain during warm weather. The interior of the enclosure assembly should be vapor permeable to allow inward drying.

In the absence of field or laboratory research on CLT assemblies with reservoir claddings, hygrothermal modeling was used to establish conservative initial guidance on appropriate vapor permeance of exterior insulation for preventing moisture accumulation in CLT panels (assuming a vapor permeable WRB/air barrier). CLT wall assemblies clad with brick veneer or regular Portland cement stucco were simulated by the authors with three different types of rigid exterior insulation in eight U.S. cities. The three types of exterior insulation differ considerably in vapor permeability. Table 3 provides a vapor permeance classification for materials (based on Lstiburek, 2006b). Rigid mineral wool insulation is highly vapor permeable. The vapor permeance classes for expanded polystyrene (EPS) and extruded polystyrene (XPS) depend on thickness (and also on density) (BSC, 2007). At 1 in. (25 mm) thick, unfaced EPS is typically considered vapor semi-permeable; it transitions from semi-permeable to semi-impermeable at roughly 3 in. (76 mm) thickness. At 1 in. (25 mm) thick, unfaced XPS is considered borderline semi-permeable/semi-impermeable and is semi-impermeable at greater thicknesses. Rigid polyisocyanurate insulation (not simulated) is typically foil-faced; this facing makes it vapor impermeable.

For hygrothermal modeling, an insulation thickness was selected for a given climate to provide an effective R-value which, in combination with the R-value of 4 in. (100 mm) thick CLT, would be equivalent to the effective R-value required of wood-frame construction as per the IECC (ICC, 2009). As a criterion for acceptable performance, the exterior insulation was considered appropriate if simulated wood moisture content remained below 19% on a 30-day average basis throughout the entire CLT thickness. Table 4 summarizes the simulation results.

Table 3

Vapor permeance categories (Lstiburek, 2006b)

Designation	Vapor Permeance Range	Vapor Retarder Class
Vapor impermeable	0.1 perm or less	Class I vapor retarder (considered a vapor barrier)
Vapor semi-impermeable	1.0 perm or less and greater than 0.1 perm	Class II vapor retarder
Vapor semi-permeable	10 perms or less and greater than 1.0 perm	Class III vapor retarder
Vapor permeable	Greater than 10 perms	Not considered a vapor retarder

Table 4

Appropriate types of exterior insulation for CLT wall assemblies with vapor permeable WRB and poorly-ventilated or non-ventilated reservoir claddings

City	Climate Zone	Exterior Insulation Type		
		Extruded Polystyrene	Expanded Polystyrene	Rigid Mineral Wool
Miami	1A	Yes	No	No
Houston	2A	Yes	No	No
Atlanta	3A	Yes	Yes	No
San Francisco	3C	Yes	Yes	Yes
Seattle	4C	Yes	Yes	Yes
Boston	5A	Yes	Yes	No
Minneapolis	6A	Yes	Yes	No
Anchorage	7	Yes	Yes	Yes

Hygrothermal simulation by the authors (unpublished data) suggests that extruded polystyrene insulation is appropriate in conjunction with poorly-ventilated or non-ventilated reservoir claddings in all the climates investigated. Its resistance to vapor diffusion essentially protects CLT from inward vapor drive. Foil-faced polyisocyanurate insulation (not simulated) would be expected to perform similar to extruded polystyrene. Expanded polystyrene is appropriate in all locations except the hot humid Southeast (zones 1A and 2A). Finally, rigid mineral wool insulation is appropriate in western U.S. locations (San Francisco, Seattle, Anchorage). These locations typically see precipitation during colder months and dry weather during warmer months, so inward vapor drives are fairly weak. Cold climates such as Boston (5A) and Minneapolis (6A) see enough wind-driven rain in the warmer months for rigid mineral wool insulation to be potentially problematic in conjunction with a vapor permeable WRB and poorly-ventilated or non-ventilated reservoir claddings.

Hygrothermal modeling also indicates several other important trends.

- The issue of inward vapor drive becomes less significant when a well-ventilated reservoir cladding is selected, such as wood siding, cement board, or stucco applied over backer board, attached to 3/4 in. (19 mm) strapping with continuous vents at top and bottom. Inward vapor drive is even less significant when a ventilated non-reservoir cladding is selected, such as painted wood, metal, or vinyl. That is, lower permeance on the exterior is not needed to prevent moisture accumulation in CLT in any climate with well-ventilated reservoir claddings or non-reservoir claddings. From a vapor diffusion perspective, all of the insulation types mentioned above are appropriate with well-ventilated reservoir claddings and non-reservoir claddings, assuming CLT panels are dry to begin with;
- Outward drying capability improves as the vapor permeance of the exterior insulation increases; CLT wall assemblies have less outward drying capability with vapor semi-impermeable exterior insulation than with vapor permeable exterior insulation;
- In any climate, outward drying capability is greater with a non-reservoir, ventilated cladding than with a ventilated reservoir cladding; similarly, outward drying capability is greater with a ventilated reservoir cladding than with a non-ventilated reservoir cladding.

In summary, vapor diffusion can be important in both wetting and drying. In general, given the low vapor permeance of CLT itself, it is desirable to maximize the drying capability of CLT assemblies by selecting vapor permeable materials for the WRB/air barrier and thermal insulation and a vapor permeable interior finish. When using poorly-ventilated or non-ventilated reservoir claddings in certain climates, impermeable or semi-impermeable exterior insulation is preferred to prevent moisture accumulation in CLT from inward moisture diffusion (Table 4). However, low-permeance exterior insulation will reduce the outward drying ability, and wetting during construction and in service must be minimized. An alternative method to prevent moisture accumulation in CLT from inward moisture diffusion is to specify a low-permeance WRB/air barrier. For example, if rigid mineral wool exterior insulation (which is vapor permeable) is desired for fire resistance, a low-permeance WRB/air barrier may be necessary in certain climates when using poorly ventilated or non-ventilated reservoir claddings. If rigid foam insulation is incorporated in CLT construction, the fire code provisions pertaining to foam plastic insulation will need to be addressed (see Chapter 8 of the CLT Handbook).

2.5 Control of Heat Flow

Thermal insulation is used to minimize heat loss or gain through the building enclosure. Air leakage control is also a key element of heat flow control as discussed previously (Section 2.3).

Being laminated solid wood, CLT inherently offers a fair amount of thermal resistance. R-values were previously given in Table 2 (Section 2.1.4). For a CLT panel made from typical softwood species, the panel provides an R-value of approximately R-1.25 per inch (i.e., R-5 for a 4 in. thick panel). Additional insulation is generally required for the wall assembly to meet local energy code requirements or the particular energy performance goals for a given building. It is recommended that insulation be placed to the exterior of the CLT panel (Section 2.5.1). CLT panels also provide thermal mass (Section 2.5.2).

2.5.1 Reasons for Exterior Insulation

The preferred location for placing insulation in CLT assemblies in all climates is to the exterior. There are several reasons why exterior insulation is preferred over interior insulation. First, placing the insulation to the exterior allows the insulation to be continuous, whereas interior insulation would be discontinuous where floors or interior walls intersect the exterior walls or roof. Continuity of insulation is important for reducing thermal bridging and improving energy performance. Second, exterior insulation shields the CLT structure and the air barrier system from temperature extremes (Lstiburek, 2010b). That way, these components see conditions that are close to the indoor environment, meaning less expansion and contraction. Third, exterior insulation capitalizes more on the thermal mass benefit of CLT panels (Section 2.5.2). Fourth, the placement of the insulation can significantly affect the moisture levels and durability of CLT panels in service. For cold climates, exterior insulation keeps the wood in a relatively constant warm and dry indoor environment. Warmer wood surfaces translate into lower surface relative humidity and less potential for microbial growth. As discussed in Section 2.3, exterior insulation minimizes the chance of moisture accumulating in CLT from air exfiltration during cold weather. For hot, humid climates, exterior insulation keeps the CLT closer to the drier indoor environment. Exterior insulation also improves the inward drying capability of CLT. The selection of exterior insulation type in relation to climate and type of cladding is discussed in Section 2.4.

2.5.2 Dynamic Thermal Performance and CLT Thermal Mass

CLT panels, both in the building enclosure and in interior floors and walls, can act as thermal mass that stores heat during the day and releases it at night. Thermal mass can reduce heating and cooling peak loads, shift the time of peak loads, lower overall building energy use, and enhance occupant comfort. The effectiveness of thermal mass can depend on a variety of factors: climate; building geometry and orientation; solar heat gains; internal heat generation; density, amount, location, and surface area of the mass; and rate of heat transfer into the mass.

The benefit of CLT thermal mass was investigated by the authors through hourly building energy simulation (unpublished data). The space conditioning energy savings from thermal mass of CLT were determined relative to

light-frame construction for two building types in nine locations. The building types include a two-story single-family dwelling (1,860 ft.² or 173 m²) and a four-story multi-unit residential building (40 suites; 31,000 ft.² or 2,880 m²). In order to isolate the effect of thermal mass, both the CLT and light-frame version of each building type are identical in terms of effective R-values for the enclosure, airtightness, occupancy, fenestration, lighting, and systems for heating, ventilation, and air-conditioning. (Effective R-values followed the 2009 IECC for the single-family dwelling and ASHRAE 90.1-2007 for the multi-unit residential building.) CLT enclosures were modeled with exterior insulation having an R-value that, in combination with the R-value of the CLT, was equivalent to the effective R-value of the code referenced enclosure. It should be noted that the results apply only to the specific buildings modeled, and simulation results can be sensitive to many inputs. Energy performance of a particular building in a particular location should be gauged through specific modeling.

Figures 6 and 7 depict energy savings for the CLT structures relative to the light-frame structures for each building type. Savings are separated into heating energy, cooling energy, and energy use for operation of fans. These are each expressed as a percentage savings for the CLT structure relative to the space conditioning energy use (heating + cooling + fans) of the light-frame structure of the same type. Heating Degree Days (HDD) and Cooling Degree Days (CDD) are also plotted for each location (65°F basis). The figures show that CLT thermal mass has some benefit in all locations, though the greatest benefit is seen in mixed climates (e.g., Sacramento and Atlanta). Energy savings from CLT thermal mass tend to be greater during seasons when outdoor temperatures fluctuate above and below indoor temperature. The energy savings for the CLT two-story single-family dwelling in a given location are greater than for the four-story multi-unit residential building. This is likely because the latter has a lower enclosure to floor area ratio and a greater intensity of internal heat gains; in addition, a greater portion of the space conditioning load is for ventilation.

Figure 8 shows the percentage reduction in the peak cooling load from CLT thermal mass for both types of buildings. CLT thermal mass is beneficial in all locations (except Fairbanks, where cooling was not included in the model). Again, the peak load reduction is greater for the single-family dwelling than for the multi-unit residential building for the reasons mentioned above. In summary, CLT thermal mass can provide significant savings in both space conditioning energy use and peak cooling loads.

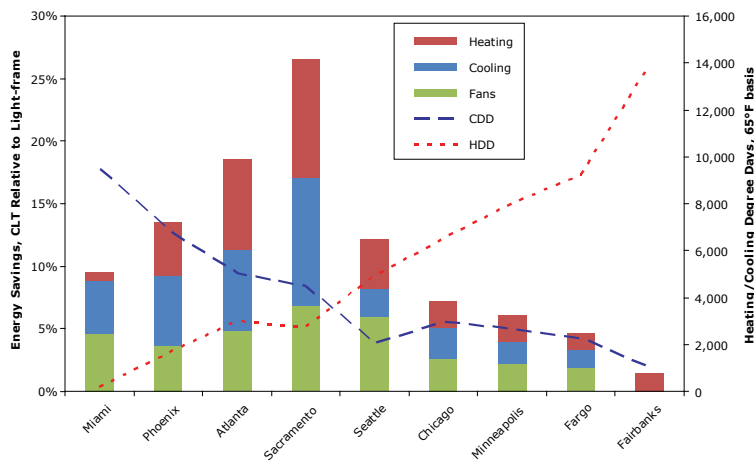

Figure 6 Space conditioning energy savings from CLT thermal mass for a two-story single-family residence (left axis), with heating and cooling degree days (right axis)

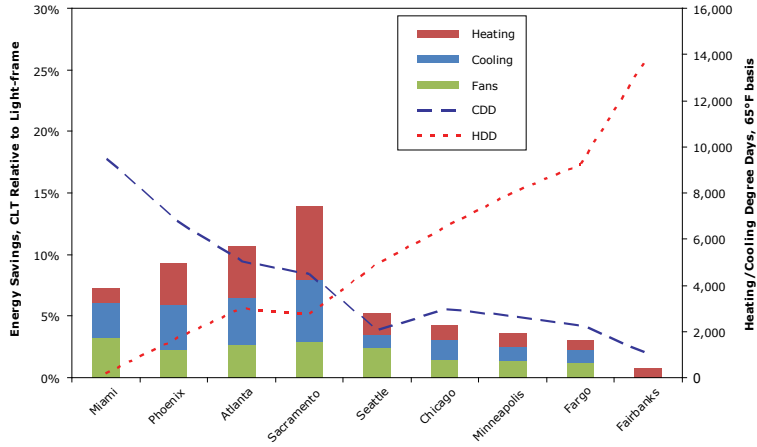

Figure 7
Space conditioning energy savings from CLT thermal mass for a four-story multi-unit residential building (left axis), with heating and cooling degree days (right axis)

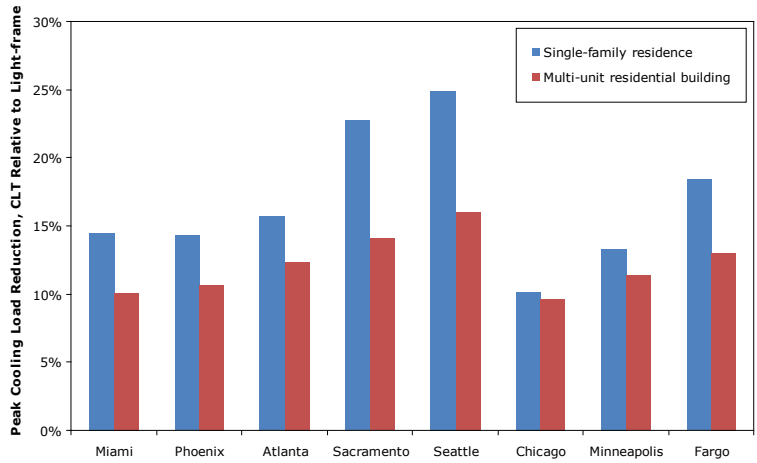

Figure 8
Peak cooling load reduction from CLT thermal mass for a two-story single-family residence and a four-story multi-unit residential building

3

RECOMMENDED BUILDING ENCLOSURE CONCEPTUAL DESIGN²

3.1 Exterior Wall Assemblies

Figures 9 and 10 depict a CLT assembly where the exterior insulation is sufficiently rigid (extruded polystyrene, expanded polystyrene, polyisocyanurate, rigid mineral wool)³ to allow that furring strips be screwed directly through it onto the CLT panel with minimal compression. In this assembly, a continuous vapor permeable WRB/air barrier membrane is applied before the rigid insulation is placed on the exterior of the panel. Vertical furring such as strips of plywood or 1x4 in. lumber are fastened directly through one layer of insulation to the CLT panels with screws of sufficient length to provide attachment points for the cladding, assuming this meets the structural requirements of cladding attachment (CCHRC, 2009; Baker, 2012). This assembly is the most thermally efficient of those illustrated in this Handbook. The space between the furring strips is left open to provide drainage behind the cladding, and openings are provided at the top and bottom of the wall for ventilation of the cavity. The assembly shown does not contain gypsum drywall on the interior. Where required for fire safety and acoustic control purposes, gypsum drywall would be fastened to the CLT panels or supported on vertical furring strips to allow for wiring and other services to be concealed.

Figures 11 and 12 illustrate two alternate cladding support strategies. Figure 11 shows two strapping members attached through the insulation to the CLT panels. The first strapping member would typically be a 2x2 in., and the second member a 2x2 in. or a size that suits the thickness of insulation. The first strapping member is attached to the CLT panels with screws through the rigid insulation, and the second is then attached to the first strapping member. This method may be necessary where greater thicknesses of insulation are required. It also offers benefits for detailing around penetrations and allows the insulation to be installed with staggered joints. Depending on the weight of the cladding system and the insulation thickness, a structural analysis may be necessary for the fastening system.

Given that the cavity is designed to drain liquid water that intrudes past the cladding, wood furring members placed to the exterior of the WRB/air barrier may require protection with some level of wood preservative depending on the exposure and local building code requirements. Attention should be given to the selection of appropriate corrosion resistant fasteners suitable for use with the preservative chosen for wood treatment.

Figure 12 shows a cladding support strategy using low conductivity spacers that are attached with screws to the CLT wall, providing rigid support to hang exterior vertical girt and cladding. In comparison to a system with metal clips that pass through the exterior insulation layer, this approach reduces thermal bridging.

²It is not at all sufficient for designers and specifiers to simply provide the construction trades with the text or the conceptual drawings shown in this section as instruction on moisture management detailing.

³If rigid foam insulation is incorporated in CLT construction, the fire code provisions pertaining to foam plastic insulation will need to be addressed (see Chapter 8 of the CLT Handbook).

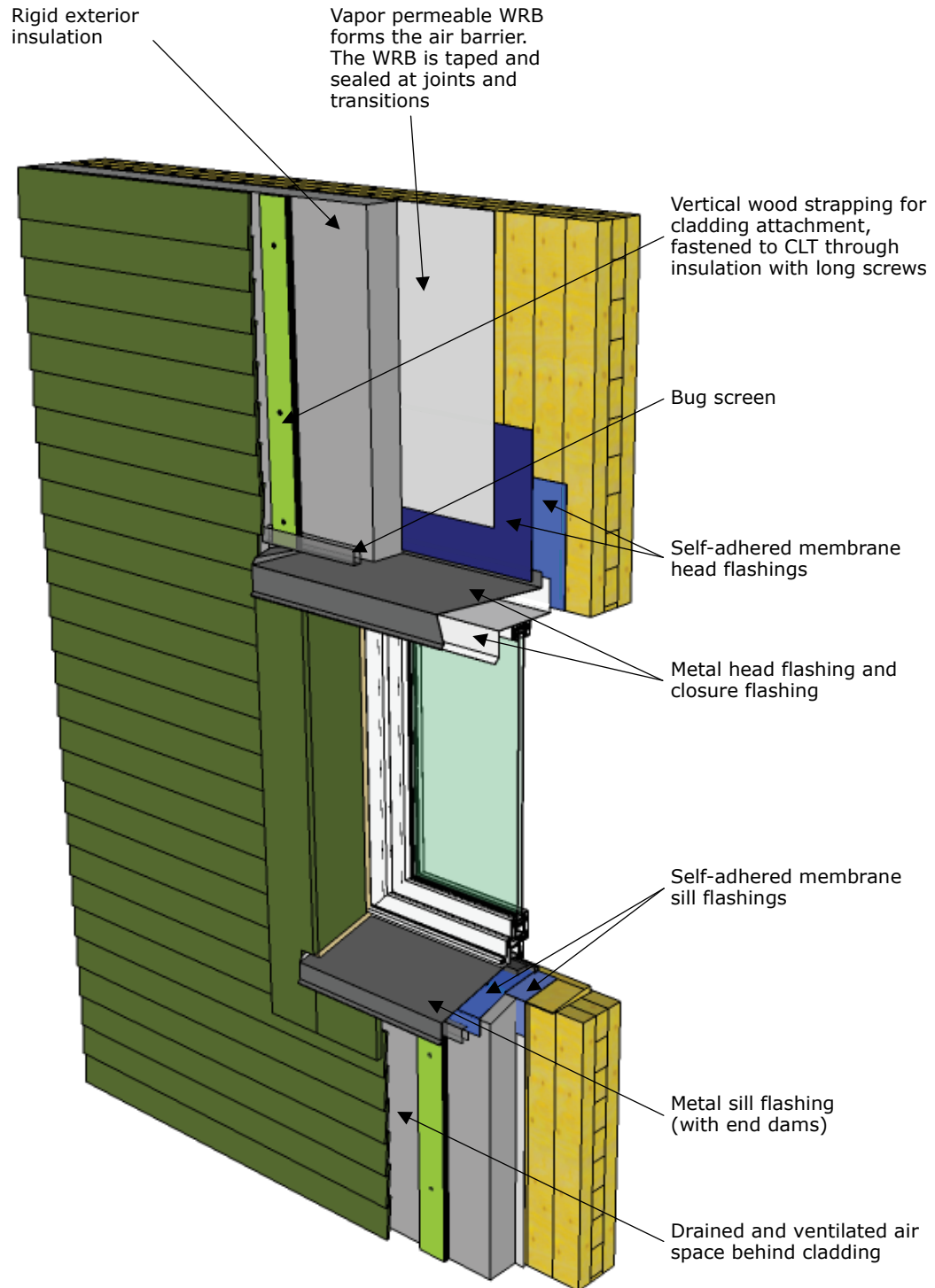

Figure 9
CLT exterior wall assembly with exterior insulation and ventilated cladding, showing material sequencing and schematic window flashing details

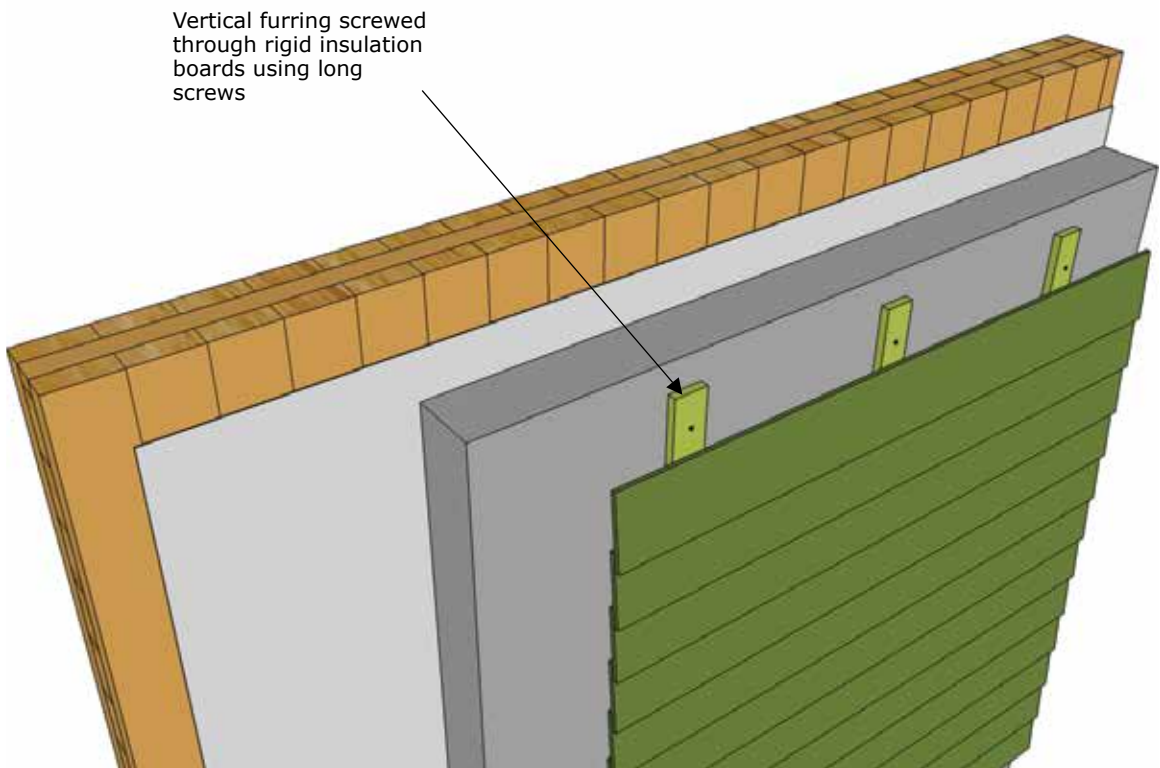

Figure 10
Cladding support strategy using vertical furring through rigid insulation boards

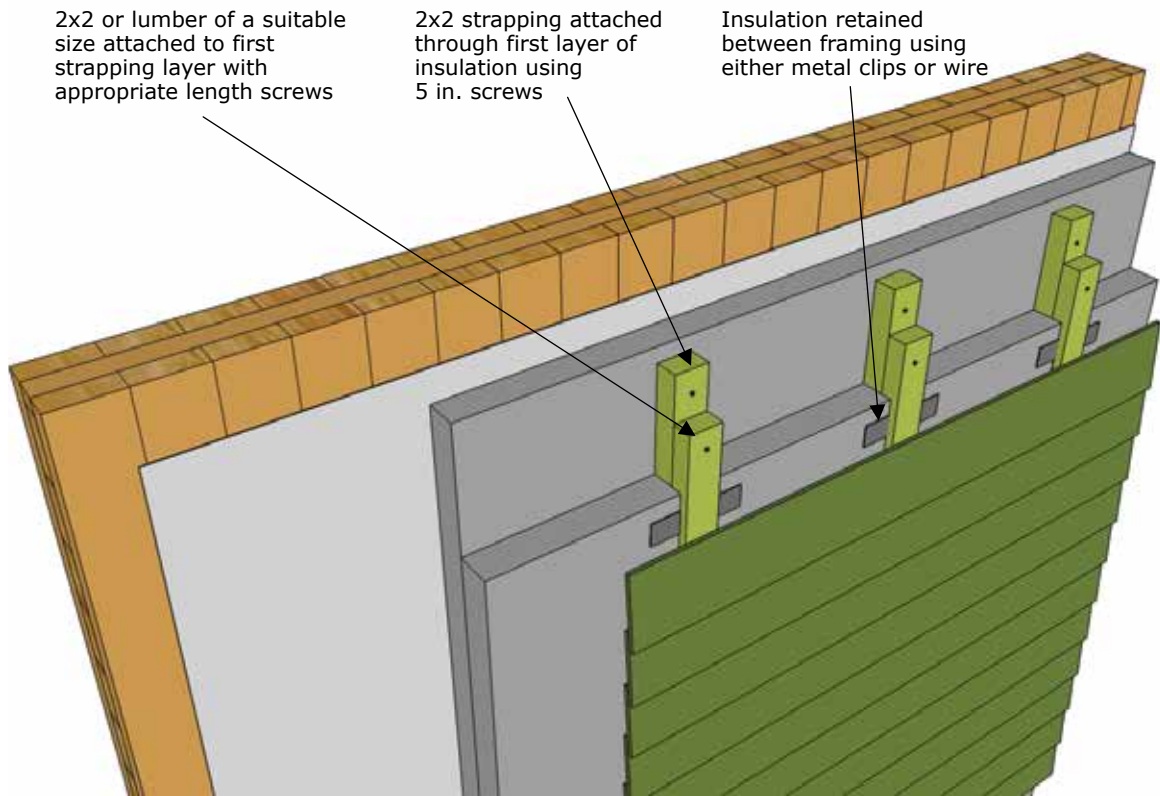

Figure 11

Cladding support strategy using two layers of rigid insulation and two strapping members: this configuration allows for the use of shorter screws and greater insulation thicknesses, while minimizing thermal bridging

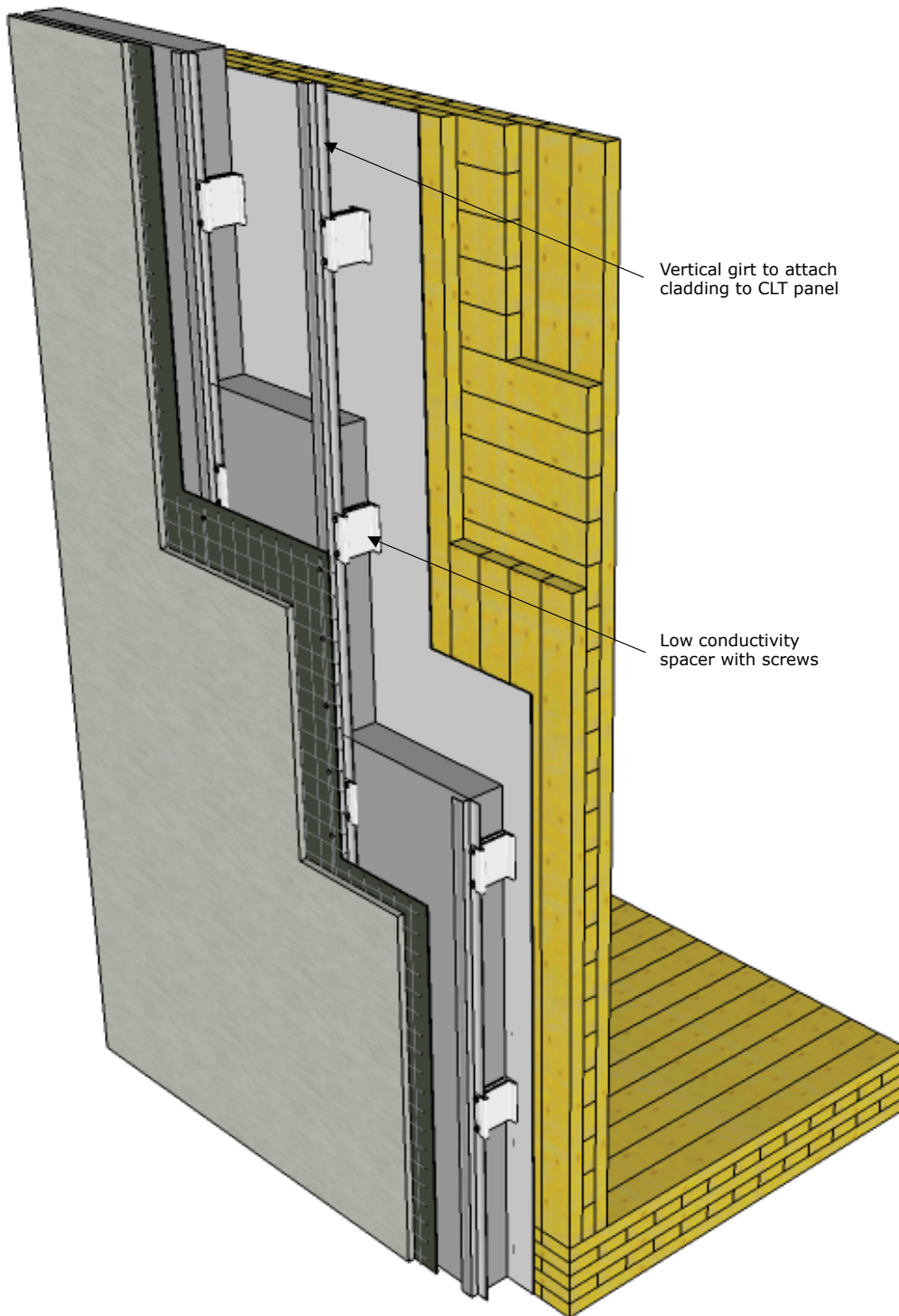

Figure 12

Cladding support strategy using low conductivity spacers with screws providing rigid support to hang exterior vertical girt and cladding (used with permission of FPInnovations, RDH Building Engineering, and other partners)

3.1.1 Detailing Installation of Windows and Doors

The installation of windows in a CLT wall assembly must follow basic water management principles as well as conform to window manufacturer instructions and consensus standards such as ASTM E2112 (2007a). When installing a window into an exterior insulated assembly, several window installation techniques are possible depending on the placement of the window frame. Placing the exterior side of the window frame in the same plane as the WRB on the exterior of the CLT panel is recommended.

A general schematic of a window installation is provided in Figure 9. In addition, Figure 13 depicts a cross section of the detailing at the window sill. A sloped metal sill flashing below the window directs water running off the window to the exterior of the cladding. Below the window, a sloped wood sill is placed over the CLT rough opening. This sill is covered with a self-adhered flashing that overlaps the WRB shingle fashion below the rough opening. A second piece of self-adhered flashing covers the first piece and laps over the exterior insulation. Both of these flashings have upturned end dams to ensure that the sill-jam intersections are protected. Key points to consider when detailing include:

- Air barrier continuity must be maintained from the WRB at the CLT surface, through the rough opening and to the window frame;
- The membrane used at the window sill should be resistant to standing water and vapor impermeable. All other membranes should preferably be vapor permeable to prevent water from being trapped within the CLT panel;
- Water should not be drained behind the insulation/WRB interface below a window or other penetration. Water should be drained to the exterior of the insulation or directly to the exterior where possible.

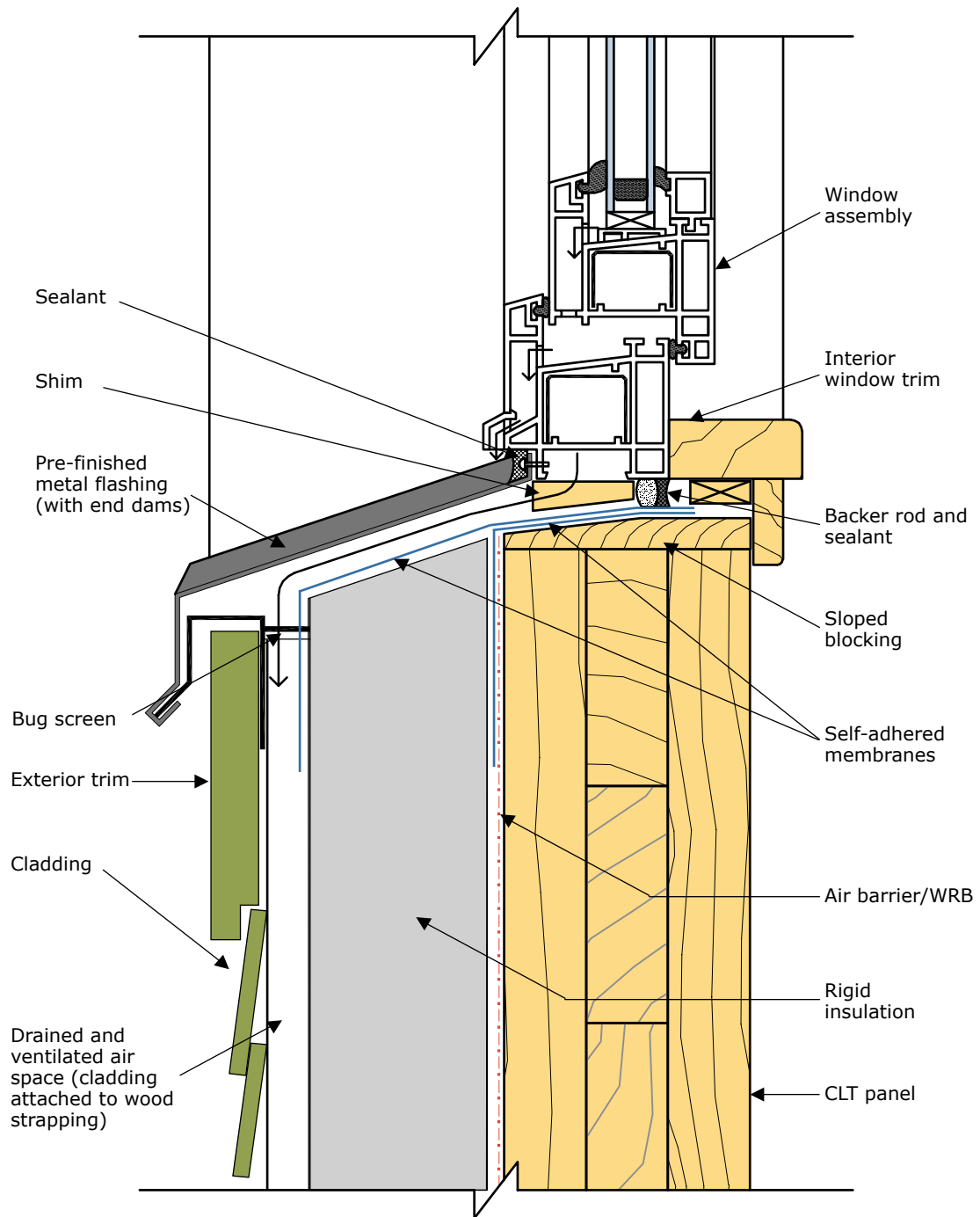

Figure 13
Window installation schematic using sloped wood sill

3.1.2 Detailing Foundation/Wall Intersections and Considerations at Grade

CLT panels must be protected from moisture at grade. Typical wood-frame construction best practice regarding clearance between grade and wood should be followed: a minimum of 6 in. (150 mm) or local code required clearance should be maintained between the bottom of the CLT panel and the finished ground level after landscaping. The CLT panel should also be separated from the concrete using a waterproof membrane and a treated wood sill plate is recommended to prevent capillary water absorption through the end grain of vertical boards in the CLT (Figure 14). A sill gasket and sealant can be provided for air sealing.

As shown in Figure 14, the exterior insulated above-grade CLT wall assembly details easily into an exterior insulated below grade basement wall or slab footing. Flashing is provided at the base of the above grade CLT wall which can be profiled to cover the below grade insulation. This insulation (typically extruded polystyrene, XPS, or rigid mineral wool) is placed on the exterior of the concrete and should be placed up tight to the underside of the flashing. Since this can provide hidden access for termites, the XPS insulation should be borate-treated and the flashing should be installed in such a manner to act as a termite shield where this hazard exists. Other termite management measures may be required by local building codes as discussed below in Section 5.

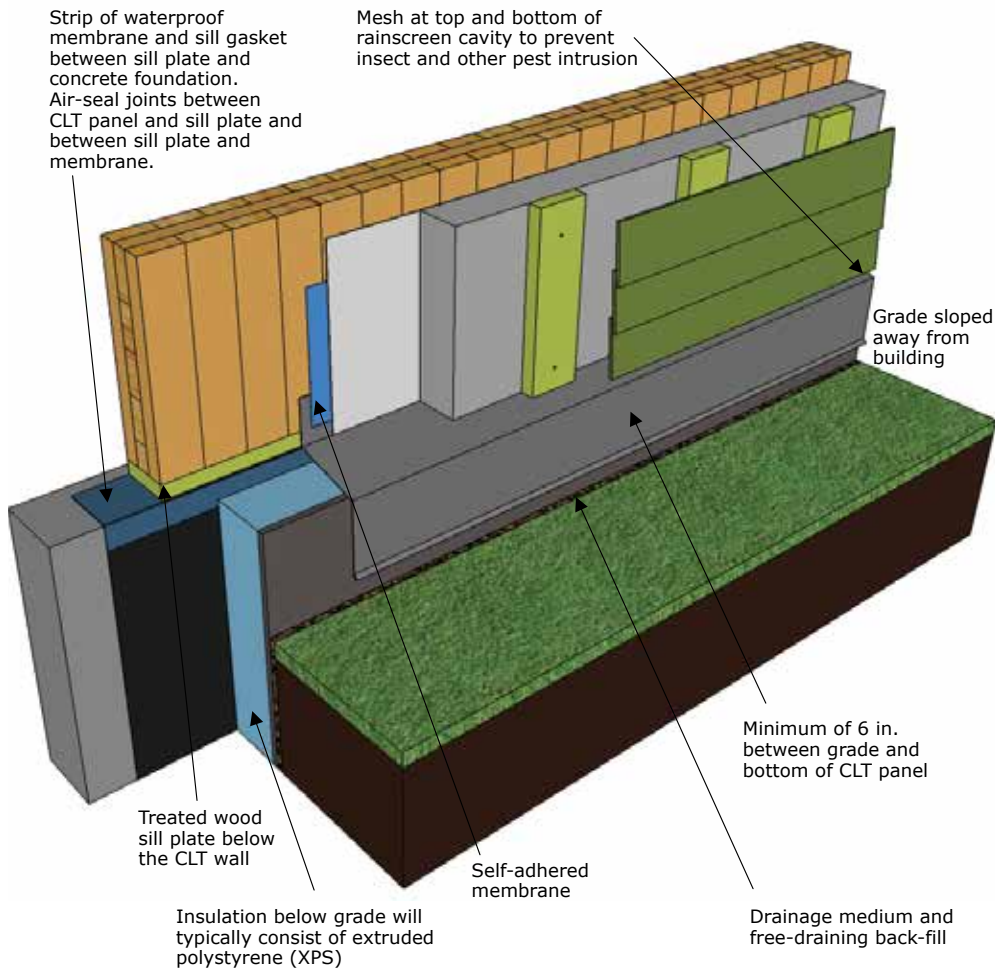

Figure 14
Schematic of CLT wall assembly and concrete foundation at grade

3.1.3 Balconies

Cantilevered balconies can be problematic in terms of durability and thermal performance in any type of structure. Cantilevered CLT balconies are not recommended because of the risk of water intrusion. Balconies historically had major moisture-related problems in wood-frame buildings when poorly-executed details allowed water intrusion into structures (Morrison Hershfield Ltd., 1998). A balcony, from the perspective of water management detailing, is equivalent to a low-slope roof that intersects an exterior wall. Proper detailing would require a waterproof membrane properly lapped into the wall's drainage plane and positive drainage of the balcony away from the balcony/wall intersection, so that water is not directed back into the building and does not pond on the membrane. CLT is typically made with lumber that is not preservative-treated, and most of the wood species used for CLT are vulnerable to decay if they get wet and remain wet for an extended period (moisture content exceeding ~26%). If decay were to occur in the deck of a cantilevered CLT balcony, there would be great difficulty and cost involved in repairing the structure, because the CLT panel that served as the balcony deck would be the same panel that served as the structural floor inside the building.

If the building will have balconies, the best approach for a CLT structure is to offset the balcony from the exterior wall. For all but the driest of climates, it would be preferable to construct a wood-frame balcony using pressure-treated lumber rather than CLT. There are a number of ways to keep the balcony thermally isolated from the building—connecting the balcony structure to the CLT structure intermittently through the exterior insulation, combining offset point supports with tie rods, or providing the balcony with its own structural frame and foundation. Water proofing membranes typically require a positive slope of at least 2% (¼ in. per foot or 20 mm per meter). The designer must also consider wood shrinkage and other potential movement. See other references for connections and water management detailing (Lstiburek, 2007, 2011; Smith, 2007; HPO, 2011; Straube, 2012).

3.2 Roof Assemblies

Effective water management starts with thoughtful design that deflects and drains water from the roof, walls, and foundation away from the building. Directing water from the roof away from the enclosure reduces the moisture load on walls and foundations.

3.2.1 Water Managed Roof Design Tips

- Create designs that do not trap or channel water into the building;
- Avoid roof designs with horizontal valleys that trap water;
- Avoid roof designs that slope into vertical walls;
- Always use seamless kick-out flashings at roof/wall intersections. Such flashings should be properly integrated with the WRB. A self-adhered flashing is recommended from the kick-out and step flashing onto the CLT wall. This will deflect any water that gets behind the WRB onto the flashing to the exterior;
- Remember that floor plans dictate roof plans and roof drainage paths. Every jog in the floor plan typically telegraphs to a more complicated roof plan;
- Keeping the roof design simple reduces complex framing and minimizes flashing errors;
- Gutters and downspouts should direct water to a drain or to the ground (away from the building) rather than onto a lower-pitched roof or slab.

3.2.2 Sloped Roofs

CLT panels can be effectively used for roof panels. CLT roof panels can provide more interior volume, which can become an aesthetically appealing design element if the fire codes allow the panels to be exposed to the interior. The thickness of CLT roof panels is based on loads, structural supports, design and span of the panels. A variety of roofing material approaches can work with CLT as long as thoughtful attention is paid to design details for insulation and moisture management. Water management strategies for roofs are similar to the design considerations for walls—deflection, drainage, drying, and durable materials (Section 2.2.2). In a one inch rain, roofs are exposed to and must deflect 640 gallons per 1000 square feet of roof area.

Energy codes dictate higher R-value insulation requirements for roofs than walls. A common design is to have the insulation, moisture control layer and air barrier placed on the exterior side of the panel, similar to the CLT wall assemblies presented above. Rigid insulation⁴, with a plywood or OSB nail base for attaching roofing materials, may provide a slimmer roof profile that can make for easier interfacing of insulation, roof flashings, and trim components. Figures 15 and 16 show material sequencing of a sloped CLT roof and tie-in details to a CLT wall assembly at the underside.

Since bulk water deflection is a primary requirement for roofs, a vapor impermeable, self-adhered membrane is applied over the plywood or OSB sheathing as a secondary water control underlayment. Prior to installation of the rigid insulation, plywood or OSB sheathing, and self-adhered membrane, the CLT roof panels should be covered with a water-resistive material such as roofing felt. Roof assemblies generally have greater insulation levels than walls, and drying is facilitated to the inside through the CLT panel with a vapor permeable interior finish.

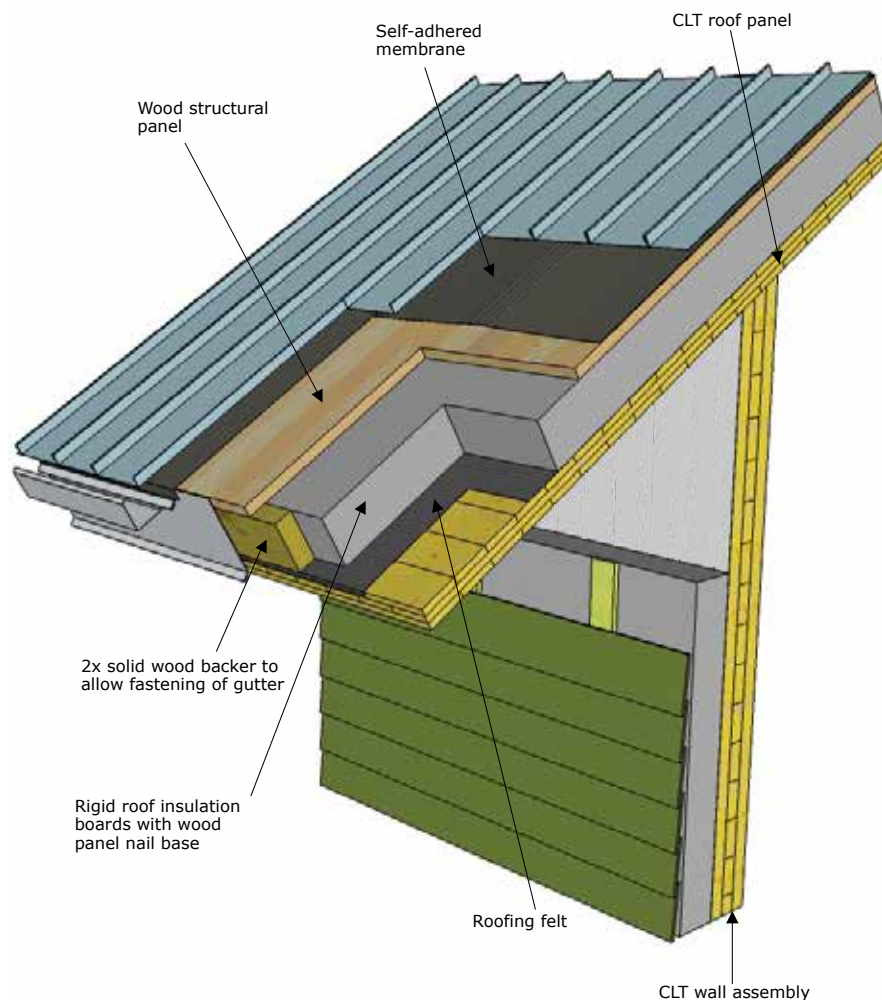

Figure 15

Top view of a sloped CLT roof assembly showing material sequencing and transition to a CLT exterior wall with exterior insulation and ventilated cladding (certain roofing materials may require a vented air space between the roofing and the membrane, which can be created using purlins or other methods)

⁴If rigid foam insulation is incorporated in CLT construction, the fire code provisions pertaining to foam plastic insulation will need to be addressed (see Chapter 8 of the CLT Handbook).

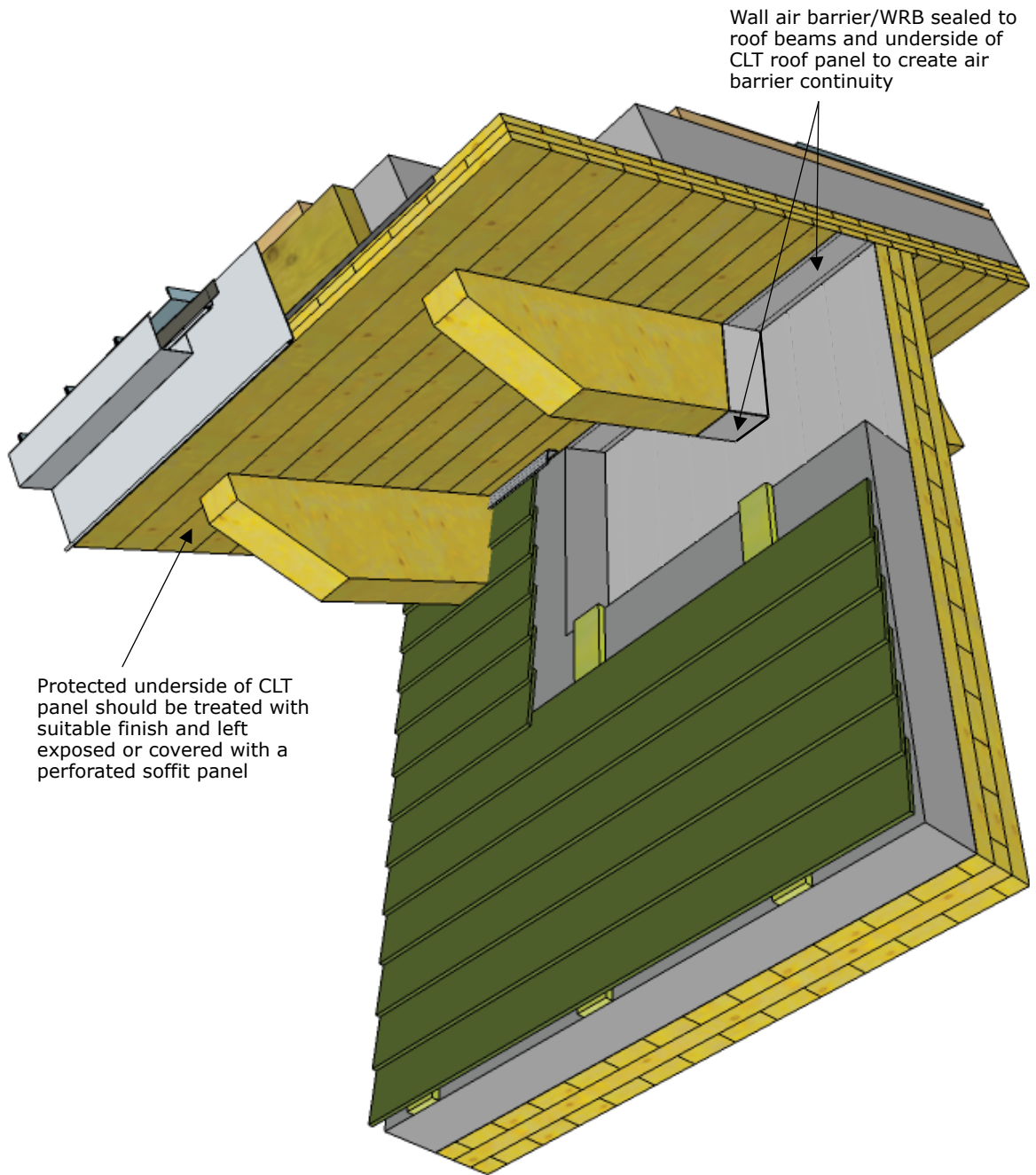

Figure 16

Bottom view of a sloped CLT roof assembly showing material sequencing and transition to a CLT exterior wall with exterior insulation and ventilated cladding

3.2.3 Low-slope Roof Decks and Parapets

Low-slope roof assemblies for CLT construction have design requirements for water management similar to sloped roofs. Protection of CLT roof panels during construction is most critical (Section 4). Conventional flat roofing systems can be applied for use with CLT roof construction. It is crucial that underlayment membranes be redundant and carefully interfaced with parapet wall flashing to provide proper shingling, and deflection of water away from roof-wall intersections and penetrations. Rigid insulation joints should be staggered and sealed to reduce airflow and prevent water penetration.⁵ Figure 17 shows material sequencing of a low-slope CLT roof and tie-in details to a CLT wall assembly.

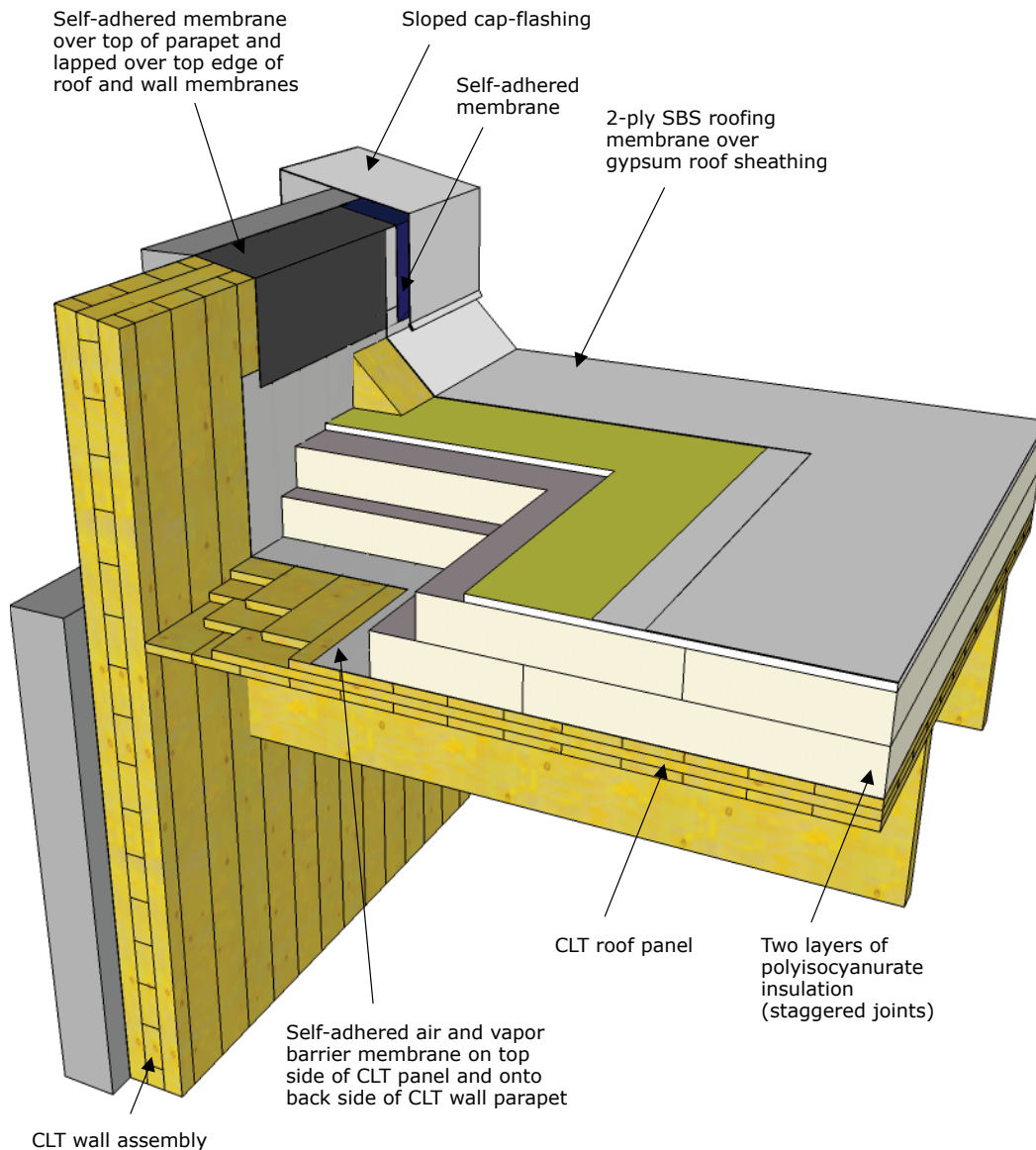

Figure 17

Low-slope CLT roof detail showing material sequencing of a conventional roofing assembly with tie-in to CLT parapet wall (slope to drains is achieved either by sloping the roof deck or by tapering the rigid insulation)

⁵If rigid foam insulation is incorporated in CLT construction, the fire code provisions pertaining to foam plastic insulation will need to be addressed (see Chapter 8 of the CLT Handbook).

Another option for low-slope roofs is the application of high density (approx. 3 lb. \cdot ft.⁻³) closed-cell spray polyurethane foam (ccSPF) insulation with a polymeric topcoating. This type of insulation can be sprayed directly over a membrane on the CLT. It absorbs a negligible amount of water, is air impermeable, and is vapor semi-impermeable at 2 in. (50 mm) or greater thickness. A polymeric top coat over the ccSPF can provide mechanical and UV protection and must be properly maintained. When applied as a roofing substrate, ccSPF insulation practically eliminates thermal bridging and provides air sealing at parapet walls, curbs, and other roofing penetrations. Gravel-surfaced systems and single-ply membrane technology (i.e., fully adhered fleece-backed membranes, loose-laid ballasted) can also be used with ccSPF roof systems.

4

CONTROL OF MOISTURE DURING CONSTRUCTION

CLT panels, similar to other wood products, should always be protected from exposure to rain, snow, and wet ground during transport, jobsite storage, and construction process (see also Chapter 12). CLT panels are vulnerable to damage from excessive wetting due to the nature of their laminated construction and because they may absorb large quantities of water through the faces, exposed end grain, and gaps between the panel laminations. Recall that liquid water absorption is much more rapid at end grain surfaces. Applying water repellents to end grain of CLT panels may effectively retard water absorption; however, film-forming coatings may retard drying.

CLT panels are much more massive than standard dimension lumber and structural panels such as plywood and OSB. The mass and thickness of CLT means that these panels will likely take longer to dry out if allowed to become wet. In addition, cyclic wetting and drying can cause wood expansion and contraction, which may damage the laminations and lead to distortion of the panels. Therefore, prevention of wetting should be a priority in construction.

Wetting of CLT panels during construction can be minimized by paying careful attention to weather and construction schedules, delivering the product just on time, minimizing construction time, and protecting CLT panels from wetting once they are installed. Temporary protection can be attached in the manufacturing facility and should be maintained while stored on site. This protection should also be maintained as the panels are erected in place in order to protect them until the roof or other elements, such as the WRB, provide adequate protection.

CLT exterior walls should be protected as soon as possible with a WRB. A vapor permeable WRB is desirable to allow the wood to dry while preventing further water absorption. CLT roof panels should likewise be protected as soon as possible with a waterproof membrane, preferably while the panels are dry. Applying an impermeable membrane over CLT panels that are already wet is problematic for two reasons. First, drying of the CLT will be impeded. Second, the membrane may not adhere well to wet wood. If roof panels are wetted before the protective membrane is applied, it may be necessary to provide temporary shelter above the roof and to dry the panels.

Even with these precautions, it is likely that CLT panels will experience some wetting during transport or construction, and be installed with built-in moisture in localized areas. Therefore, the most durable wall design strategies will use vapor permeable materials to allow for excess moisture to escape from the assembly, thereby preventing any damage and deterioration. In cases where exterior materials with low vapor permeance are selected, the CLT panels should be dry prior to their installation.

5

WOOD PRESERVATIVE TREATMENT FOR INCREASED DURABILITY

CLT panels, especially any exposed portions and parts in direct contact with foundations less than 6 in. (150 mm) above finished ground level, would benefit from wood preservative treatment, particularly in wetter or more humid climates or where termites are prevalent. While best practice construction and design strategies attempt to minimize exposure of the wood panels to wetting, some CLT panels will inevitably be exposed to moisture during their lifetime and the additional factor of safety provided by wood preservatives can be beneficial to the durability of the buildings.

In terms of treatment, the water-borne preservatives used for treatment of lamina prior to manufacture of glulam posts and beams can generally be applied to lumber destined for manufacture of CLT. Manufacturers should ensure that the preservatives used do not adversely affect glue bonds or that resin modifiers are added as needed. This approach could be applied to the entire CLT panel or to parts of the panel anticipated to be exposed to conditions conducive to decay. Conventional pressure treatment with waterborne preservatives post manufacture would likely cause excessive distortion of CLT panels. New processes are available using low uptake spray, dip or very brief pressure treatments followed by conditioned storage to facilitate further penetration. These may prove suitable for CLT. Non-swelling oil-based treatments used for industrial glulam post manufacture are not a preferred approach for CLT buildings due to VOC emissions; most are not registered for interior use. Non-penetrating surface treatments are not likely to be effective against decay or termites but may be effective against surface mold. Where moisture ingress will be highly localized and predictable, boron or boron/copper rods can be used for local protection. In most cases, boron rods should be used in combination with a borate/glycol surface treatment and a film-forming coating to prevent leaching.

Subterranean and drywood termites would be much more difficult to eradicate from CLT panels than from platform frame construction. In areas with a high native termite hazard plus the Formosan subterranean termite, multiple lines of defense should be implemented to prevent termite damage to CLT panels and other wood or cellulose-based building components. The use of termite soil barriers such as termiticide soil treatment, and slab and foundation detailing to prevent termite intrusion should be taken into consideration during design. Preservative treated wood is also recommended in these areas for CLT panels and other wood components. Site management measures should eliminate nests and termite food sources such as stumps, formwork and other untreated wood in the soil. In addition, termite control measures should also be provided to below grade insulation materials such as XPS. Regular surveillance is also recommended to detect and treat termite infestation before it gets well established.

The use of fire retardants may help meet fire safety requirements and warrant the use of exposed CLT panels for aesthetic purposes. Some fire retardants contain boron and will also provide decay and termite resistance.

6

CONCLUDING COMMENTS

This Chapter provides guidance to assist practitioners in designing building enclosures with CLT panels that are suited to U.S. conditions. The Chapter emphasizes heat, air, and moisture control strategies and details for durability, energy performance, indoor air quality, and occupant comfort. The overarching strategies are to prevent wetting of CLT panels by drained wall systems, to control airflow using an air barrier to the exterior of the CLT panels, to place rigid insulation to the exterior of the panels, to prevent moisture from accumulating within the panels, and to allow the panels to dry should they get wet. In certain climates, preservative treatment of CLT is recommended to provide additional protection against potential hazards such as decay and termites. However, these guidelines are not intended to substitute for the input of a professional building scientist. This may be required in some jurisdictions and is recommended in all areas at least until such time as CLT construction becomes common practice.

7

REFERENCES

- AF&PA. 2005. *National design specification (NDS) for wood construction*. ANSI/AF&PA NDS-2005. Washington, DC: American Forest & Paper Association. American Wood Council. 174 p.
- APA. 2011. *Standard for performance-rated cross-laminated timber*. ANSI/APA PRG 320-2011. Tacoma, WA: APA – The Engineered Wood Association.
- ASHRAE. 2007. *Energy standard for buildings except low-rise residential buildings*. ANSI/ASHRAE/IESNA Standard 90.1-2007. Atlanta, GA: American Society of Heating, Refrigerating and Air-Conditioning Engineers.
- _____. 2009. *ASHRAE handbook - Fundamentals*. Atlanta, GA: American Society of Heating, Refrigerating and Air-Conditioning Engineers.
- ASTM. 2005. *Standard test methods for water vapor transmission of materials*. ASTM E96 / E96M – 05. West Conshohocken, PA: ASTM International.
- _____. 2007a. *Standard practice for installation of exterior windows, doors and skylights*. ASTM E2112 – 07. West Conshohocken, PA: ASTM International.
- _____. 2007b. *Standard test methods for specific gravity of wood and wood-based materials*. ASTM D2395-07ae1. West Conshohocken, PA: ASTM International.
- _____. 2009. *Standard test method for airflow resistance of acoustical materials*. ASTM C522-03(2009)e1. West Conshohocken, PA: ASTM International.
- Baker, P. 2012. *External insulation of masonry walls and wood framed walls*. Research Report 1204. Somerville, MA: Building Science Corporation.
- Breyer, D., K. Fridley, K. Cobeen, and J.D. Pollock. 2006. *Design of wood structures*. 6th ed. New York: McGraw-Hill Professional.
- Brock, L. 2005. *Designing the exterior wall: An architectural guide to the vertical envelope*. Hoboken, NJ: John Wiley & Sons.
- BSC. 2007. *Guide to insulating sheathing*. Westford, MA: Building Science Corporation.
- Burnett, E., J. Straube, and A. Karagiozis. 2004. *Synthesis report and guidelines*. Report 12 of *Development of design strategies for rainscreen and sheathing membrane performance in wood frame walls*. ASHRAE Research Project 1091. Atlanta, GA: American Society of Heating, Refrigerating and Air-Conditioning Engineers.

- Carll, C., and T.L. Highley. 1999. Decay of wood and wood-based products above ground in buildings. *Journal of Testing and Evaluation* 27 (2):150-158.
- Carll, C., and A.C. Wiedenhoef. 2009. Moisture-related properties of wood and the effects of moisture on wood and wood products. In *Moisture control in buildings: The key factor in mold preventions*, edited by H.R. Trechsel and M.T. Bomberg. 2nd ed. Chapter 4, p. 54-79. West Conshohocken, PA: ASTM International.
- Carmeliet, J., H. Hens, and G. Vermeir, eds. 2003. *Research in building physics: Proceedings of the 2nd International Conference on Building Physics, 14-18 September 2003, Antwerpen, Belgium*. Exton, PA: A.A. Balkema Publishers.
- CCHRC. 2009. *REMOTE: A manual*. Fairbanks, AK: Cold Climate Housing Research Center, 42 p. http://cchrc.org/docs/best_practices/REMOTE_Manual.pdf (accessed November 26, 2012).
- CertiWood™. 2012. *Plywood design fundamentals*. North Vancouver, BC: CertiWood™ Technical Centre. http://www.canply.org/pdf/main/plywood_designfund.pdf (accessed June 30, 2012).
- CSA. 2009. *Engineering design in wood*. CAN/CSA O86-09. Toronto, ON: Canadian Standards Association.
- CWC. 2005. *Introduction to wood design*. Ottawa, ON: Canadian Wood Council. 400 p.
- Derome, D. 2010. *The nature, significance and control of solar-driven diffusion in wall systems*. ASHRAE Research Project 1235. Atlanta, GA: American Society of Heating, Refrigerating and Air-Conditioning Engineers.
- Finch, G., and J. Straube. 2007. Ventilated wall claddings: Review, field performance, and hygrothermal modeling. In *Proceedings, Thermal Performance of the Exterior Envelopes of Whole Buildings X International Conference, December 2-7, 2007, Clearwater Beach, Florida*. Paper 51. Atlanta, GA: American Society of Heating, Refrigerating and Air-Conditioning Engineers.
- Gagnon, S., and C. Pirvu, eds. 2011. *CLT handbook: Cross-laminated timber*. Canadian ed. Special Publication SP-528E. Quebec, QC: FPInnovations. 1 v.
- Gereke, T., P.J. Gustafsson, K. Persson, and P. Niemz. 2009. Experimental and numerical determination of the hygroscopic warping of cross-laminated solid wood panels. *Holzforschung* 63(2009):340-347.
- Goto, Y., K. Ghazi Wakili, Y. Ostermeyer, Th. Frank, N. Ando, and H. Wallbaum. 2011. Preliminary investigation of a vapor-open envelope tailored for subtropical climate. *Building and Environment*. 46(2011):719-828.
- Hazleden, D.G., and P.I. Morris. 1999. Designing for durable wood construction: the 4 Ds. In *Proceedings, 8th International Conference on Durability of Building Materials and Components*, Lacasse, M.A and Vanicier, D.J., eds. 1:734-745. Ottawa, ON: NRC Research Press.
- Hazleden, D.G., and P.I. Morris. 2001. The influence of design on drying of wood-frame walls under controlled conditions. In *Proceedings, Performance of Exterior Envelopes of Whole Buildings VIII: Integration of Building Envelopes*, Clearwater Beach, Florida. Paper 70. Atlanta, GA: American Society of Heating, Refrigerating and Air-Conditioning Engineers.
- HPO. 2011. *Building enclosure design guide: Wood-frame multi-unit residential buildings*. Vancouver, BC: BC Housing, Homeowner Protection Office.
- ICC. 2009. *International energy conservation code*. Washington, DC: International Code Council.
- ISO. 2002. *Hygrothermal performance of building materials and products-determination of water absorption coefficient by partial immersion*. ISO 15148:2002. Geneva, Switzerland: International Organization for Standardization.

- Kumaran, M.K., J.C. Lackey, N. Normandin, F. Tariku, and D. van Reenen. 2002. *A thermal and moisture transport database for common building and insulating materials*. ASHRAE Research Project RP-1018. Atlanta, GA: American Society of Heating, Refrigerating and Air-Conditioning Engineers.
- Lepage, R. 2012. Moisture responses of wall assemblies of cross-laminated timber construction in cold climates. M.A.Sc. Thesis, Civil Eng. Dept., University of Waterloo, ON.
- Lstiburek, J. 2006a. *Understanding air barriers*. Building Science Digests, BSD-104. Somerville, MA: Building Science Corporation.
- _____. 2006b. *Understanding vapor barriers*. Building Science Digests, BSD-106. Somerville, MA: Building Science Corporation.
- _____. 2006c. *Water management guide*. Westford, MA: Building Science Press.
- _____. 2007. A bridge too far: Thermal bridges—Steel studs, structural frames, relieving angles and balconies. *ASHRAE Journal* 49(10): 64-68.
- _____. 2010a. *Mind the gap, eh!* Building Science Insight, BSI-038. Somerville, MA: Building Science Corporation.
- _____. 2010b. *The perfect wall*. Building Science Insight, BSI-001. Somerville, MA: Building Science Corporation.
- _____. 2011. Decks: Roofs you can walk on. *ASHRAE Journal* 53(3):62-68.
- Lstiburek, J., and J. Carmody. 1994. *Moisture control handbook: Principles and practices for residential and small commercial buildings*. New York: John Wiley & Sons.
- McClung, R., J. Straube, H. Ge, and J. Wang. 2012. Field study of hygrothermal performance of cross-laminated timber wall assemblies with built-in moisture. In *Proceedings of the 5th International Building Physics Conference, May 28th to 31st, 2012, Kyoto*. 361-368.
- Morris, P.I. 1998. Understanding biodeterioration of wood in structures. Report to British Columbia Building Envelope Council. Vancouver, BC: Forintek. 23 p.
- Morrison Hershfield Ltd. 1998. *Survey of building envelope failures in the coastal climate of British Columbia*. Technical Series 98–102. Ottawa: Canada Mortgage and Housing Corporation. 56 p.
- NIST. 2010. *American softwood lumber standard*. Voluntary Product Standard PS 20-10. Gaithersburg, MD: National Institute of Standards and Technology.
- NRC. 2012. Characterization of hygrothermal properties of CLT. Report to FPInnovations. Ottawa, ON: National Research Council of Canada.
- Rose, W.B. 2005. *Water in buildings: An architect's guide to moisture and mold*. Hoboken, NJ: John Wiley & Sons.
- Siau, J.F. 1984. *Transport processes in wood*. New York: Springer-Verlag. 245 p.
- Skaar, C. 1988. *Wood-water relations*. New York: Springer-Verlag. 283 p.

- Skogstad, H.B., L. Gullbrekken, and K. Nore. 2012. *Air leakages through cross laminated timber (CLT) constructions*. Oslo, Norway: Norwegian Institute of Wood Technology (Treteknisk). http://www.treteknisk.com/Air_leakages_in_cross_laminated_timber_constructions_28022011_docx_xy7tg.pdf (accessed June 30, 2012).
- Smith, A. 2007. Repairing cantilevered balconies. In *The JLC guide to moisture control: Practical details for durable buildings*, 239-243. Williston, VT: Hanley Wood.
- Stamm, A.J. 1964. *Wood and cellulose science*. New York: Ronald Press, 549 p.
- Straube, J. 2012. *High performance enclosures: Design guide for institutional, commercial, and industrial buildings in cold climates*. Somerville, MA: Building Science Press.
- Straube, J., and E. Burnett. 2005. *Building science for building enclosures*. Westford, MA: Building Science Press.
- Straube, J., and J. Smegal. 2007. The role of small drainage gaps behind wall claddings on drainage and drying. In *Proceedings, 11th Canadian Conference on Building Science and Technology, Banff, Alberta, Canada*.
- TenWolde, A., J.D. McNatt, and L. Krahn. 1988. *Thermal properties of wood and wood panel products for use in buildings*. ORNL/Sub/87-21697/1. Oak Ridge, TN: Oak Ridge National Laboratory. 38 p.
- Thompson, A., and B.N. Taylor. 2008. *Guide for the use of the International System of Units (SI)*. NIST Special Publication 811. Gaithersburg, MD: National Institute of Standards and Technology.
- Trechsel, H.R., and M.T. Bomberg, eds. 2009. *Moisture control in buildings: The key factor in mold prevention*. 2nd ed. West Conshohocken, PA: ASTM International.
- USDA. 2010a. Biodeterioration of wood. In *Wood handbook: Wood as an engineering material*. Gen. Tech. Rep. FPL-GTR-113. Chapter 14. Madison, WI: U.S. Department of Agriculture. Forest Service. Forest Products Laboratory.
- _____. 2010b. Moisture relations and physical properties. In *Wood handbook: Wood as an engineering material*. Gen. Tech. Rep. FPL-GTR-113. Chapter 4. Madison, WI: U.S. Department of Agriculture. Forest Service. Forest Products Laboratory.
- Wang, J., J. Clark, P. Symons, and P.I. Morris. 2010. Time to initiation of decay in plywood, OSB and solid wood under critical moisture conditions. In vol. 2 of *Proceedings of the International Conference on Building Envelope Systems and Technologies (ICBEST 2010)*, edited by A. Baskaran. Ottawa, ON: National Research Council of Canada. Institute for Research in Construction.
- Wang, J., and P.I. Morris. 2010. *A review on conditions on decay initiation and progression*. International Research Group on Wood Protection, Document No. IRG/WP/10-20444. Stockholm, Sweden: IRG. 10 p.
- Wang, J., M. Phalguni, and P.I. Morris. 2012. Sorption and capillary condensation in wood and the moisture content of red pine at high relative humidity. *Journal of Building Physics*. Published online, doi: 10.1177/1744259112453829.

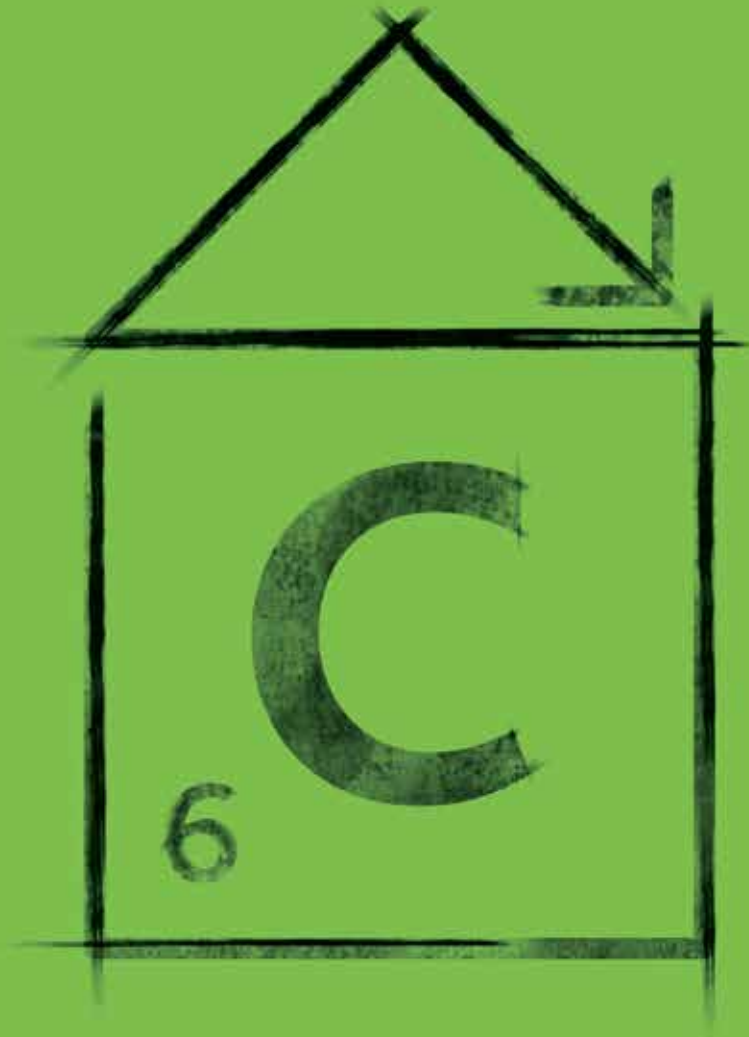

Environmental

Environmental performance
of cross-laminated timber

CHAPTER 11

Authors

Jennifer O'Connor, M.Arch., FPIInnovations
Lisa Podesto, M.S., P.E., WoodWorks
Alpha Barry, Ph.D., MBA, FPIInnovations
Blane Grann, M.Sc., FPIInnovations

Peer Reviewers

Kenneth Bland, P.E., American Wood Council
Liv Haselbach, Ph.D., P.E., LEED-AP BD+C, Washington State University

ACKNOWLEDGEMENTS

The U.S. Edition of the CLT Handbook: *cross-laminated timber* combines the work and knowledge of American, Canadian and European specialists. The handbook is based on the original Canadian Edition of the CLT Handbook: *cross-laminated timber*, that was developed using a series of reports initially prepared by FPInnovations and collaborators to support the introduction of CLT in the North American market. A multi-disciplinary team revised, updated and implemented their know-how and technologies to adapt this document to U.S. standards.

The publication of this handbook was made possible with the special collaboration of the following partners:



The editing partners would also like to express their special thanks to Binational Softwood Lumber Council, Forestry Innovation Investment (FII), Nordic Engineered Wood, Structurlam, and CLT Canada for their financial contribution to studies in support of the introduction of cross-laminated timber products in the United States of America.



© 2013 FPInnovations and Binational Softwood Lumber Council. All rights reserved.

The U.S. Edition of the CLT Handbook: *cross-laminated timber* can be electronically downloaded without charge from the website www.masstimber.com. Additional information can be obtained by visiting the websites of FPInnovations, USFPL, American Wood Council (AWC), APA and U.S. WoodWorks. Hard copies can be obtained through AWC (www.awc.org).

No part of this published Work may be reproduced, published, or transmitted for commercial purposes, in any form or by any means, electronic, mechanical, photocopying, recording or otherwise, whether or not in translated form, without the prior written permission of FPInnovations and Binational Softwood Lumber Council.

The information contained in this Work represents current research results and technical information made available from many sources, including researchers, manufacturers, and design professionals. The information has been reviewed by professionals in wood design including professors, design engineers and architects, and wood product manufacturers. While every reasonable effort has been made to insure the accuracy of the information presented, and special effort has been made to assure that the information reflects the state-of-the-art, none of the above-mentioned parties make any warranty, expressed or implied, or assume any legal liability or responsibility for the use, application of, and/or reference to opinions, findings, conclusions, or recommendations included in this published work, nor assume any responsibility for the accuracy or completeness of the information or its fitness for any particular purpose.

This published Work is designed to provide accurate, authoritative information but is not intended to provide professional advice. It is the responsibility of users to exercise professional knowledge and judgment in the use of the information.

ABSTRACT

The environmental footprint of CLT is frequently discussed as potentially beneficial when compared to functionally equivalent non-wood alternatives, particularly concrete systems.

In this Chapter, the role of CLT in sustainable design is addressed. The embodied environmental impacts of CLT in a mid-rise building are discussed, with preliminary results from a comprehensive life cycle assessment (LCA) study.

We also discuss other aspects of CLT's environmental profile, including impact on the forest resource and impact on indoor air quality from CLT emissions. The ability of the North American forest to sustainably support a CLT industry is an important consideration and is assessed from several angles, including a companion discussion regarding efficient use of material. Market projections and forest growth-removal ratios are applied to reach a clear conclusion that CLT will not create a challenge to the sustainable forest practices currently in place in North America and safeguarded through legislation and/or third party certification programs.

To assess potential impact on indoor air quality, CLT products with different thicknesses and glue lines were tested for their volatile organic compounds (VOCs) including formaldehyde and acetaldehyde emissions. CLT was found to be in compliance with European labeling programs as well as the most stringent CARB limits for formaldehyde emissions. Testing was done on Canadian species, as there was no U.S. supplier of CLT at the time of this writing; because VOC emissions are affected by species, this work should be repeated for products made from different species.

TABLE OF CONTENTS

Acknowledgements	ii
Abstract	iii
1 Introduction	1
2 Life Cycle Environmental Impacts of a CLT Mid-rise Building	2
2.1 Description of the LCA Study	2
2.2 Results	3
3 Potential Indoor Air Quality Impacts of Using CLT in Buildings	8
4 Resource Assessment: Impact of CLT on the Forest	9
5 Potential Contribution of CLT to Green Building Objectives	13
6 Material Disclosure	16
7 Conclusions	17
8 References	18
Appendix A: Literature Review	22
A1 Literature Review on Environmental Performance of CLT	22
Appendix B: Details on the Mid-rise LCA Study	24
B1 Objective and Method	24
B1.1 Life Cycle Inventory	26
B2 Results	29
B2.1 Assumptions and Limitations	30
B2.2 Sensitivity	31
B3 Discussion	32
B3.1 End-of-life Scenarios	32
B3.2 Carbon Storage	32
Appendix C: Details of the VOC Testing	34
C1 Objectives and Background	34

C2	Procedures and Results	34
	C2.1	Materials Sampling, Packaging, Transportation and Conditioning 34
	C2.2	Method 35
	C2.3	Quantification of Formaldehyde 38
	C2.4	Quantification of the TVOC 38
C3	Results and Discussions	38
C4	Conclusions and Recommendations	45

List of Tables

- Table 1* Material disposal assumptions 28
- Table 2* Absolute values for total life cycle impacts 29
- Table 3* Small chamber operating conditions 36
- Table 4* TDU/GC/MS and HPLC operating conditions 37
- Table 5* Samples 24-hour individual VOCs (iVOCs), TVOC as toluene, between n-C6 and n-C16 including formaldehyde ($\mu\text{g}/\text{m}^3$) 39
- Table 6* Samples 24-hour individual VOCs (iVOCs), TVOC as toluene, between n-C6 and n-C16 including formaldehyde ($\mu\text{g}/\text{m}^3$) 40
- Table 7* Example of some European emission labeling systems 42
- Table 8* Samples 24-hour iVOCs, TVOC as toluene, between n-C6 and n-C16 emission factors including formaldehyde ($\mu\text{g}/\text{m}^2\cdot\text{h}$) 43
- Table 9* Samples 24-hour iVOCs, TVOC as toluene, between n-C6 and n-C16 emission factors including formaldehyde ($\mu\text{g}/\text{m}^2\cdot\text{h}$) 44
- Table 10* 24-hour formaldehyde emissions as a function of product types 45

List of Figures

- Figure 1* Preliminary LCA results – relative life cycle impacts, excluding operational phase and equivalent building components, broken down by life cycle stage 4
- Figure 2* Results normalized to total U.S. results from 1999 using data from Bare, Gloria & Norris (2006) 6
- Figure 3* Growth-removal ratios by softwoods and hardwoods, 1952-2006 11
- Figure 4* Certified forest area in North America as of August 2012 12
- Figure 5* System boundary 25
- Figure 6* Picture showing a prepared sample with edges sealed ready to be put in the chamber 35
- Figure 7* A general view of the 1 m³ environmental chamber used for emissions testing 36
- Figure 8* 24-hour VOCs including formaldehyde and acetaldehyde off gassing as a function of samples types 40
- Figure 9* 24-hour VOCs including formaldehyde and acetaldehyde off gassing as a function of samples types 41
- Figure 10* 24-hour TVOC emissions as a function of cross-laminated products 41

1

INTRODUCTION

The environmental footprint of CLT is frequently discussed as beneficial. This Chapter considers the criteria for determining environmental performance of CLT systems; we also quantify that performance where possible.

Environmental expectations for CLT would align with common sustainable design objectives. For example, some questions that might be asked of CLT include:

- What are the embodied life cycle assessment impacts of CLT buildings?
- Does CLT adversely affect indoor air quality?
- Does it minimize the use of materials?
- Does it reduce operating energy in buildings?
- Does it contain recycled material?
- Is there enough forest to sustainably support manufacturing?

This is not an exhaustive list of sustainability criteria but a good starting point. In this Chapter, we address in detail the questions of embodied effects, indoor air quality and forest resource. Specific embodied effects examined include consumption of material and energy resources, creation of solid wastes, and life cycle assessment impact measures such as global warming potential, acidification potential and eutrophication potential. We touch on other topics throughout the Chapter and in our closing remarks.

As we will show in this Chapter, the attributes of CLT construction systems are consistent with some important sustainable design criteria.

2

LIFE CYCLE ENVIRONMENTAL IMPACTS OF A CLT MID-RISE BUILDING

One of the most valuable tools for measuring environmental impacts of a product or process is life cycle assessment (LCA). LCA is a scientific technique, guided by international standards, to measure flows between a product and nature and to assess the impact of those flows in categories such as global warming potential, acidification potential and smog potential.

Manufacturers use LCA to identify environmental hot spots in the life cycle of their products so that improvements can be sought. In addition, if LCA data exists for most construction products, designers can perform an LCA for whole buildings and compare impacts of different material decisions. Publically-available LCA data also helps meet a potential market demand for environmental disclosure from manufacturers inspired, for example, by the LEED® program.

An LCA for North American CLT has been published (Athena Sustainable Materials Institute, 2012b). This product information allows us to calculate various embodied impacts of a CLT building. In this section, we provide preliminary findings for a LCA study of a mid-rise CLT building, which are to be published in a comparative building LCA by FPIInnovations in 2013. The intended use of the results in a comparative LCA leads to the exclusion of several building components from the analysis which were deemed to be identical between the CLT building and the building it will be compared with. Building components excluded from this study include: foundation walls, windows, doors, plumbing, electrical, hand railings, and HVAC equipment. Please see Appendix B for full details of the assessment method for these preliminary results.

2.1 Description of the LCA Study

The LCA study was performed on an existing CLT apartment building located in Québec, Canada. The building is 43,700 square feet in area (4,060 square meters) and has four stories plus one underground level. A brief overview of the study along with results and discussion are provided below. Refer to Appendix B for additional information on the methodology, assumptions, limitations, parameter sensitivity and additional discussion.

The Athena Impact Estimator for Buildings is an LCA-based modeling tool that was used in this analysis, along with additional methods to address gaps in the Impact Estimator. The Impact Estimator provides cradle-to-grave LCA results; in other words, it includes the impacts of resource extraction and material production, construction,

maintenance and replacement, demolition, and associated transport processes. In this study, the building lifetime is assumed to be 60 years. Operating energy is not included in the assessment, in order to better isolate the embodied impacts of the materials.

The Impact Estimator draws on embedded LCA databases for materials, construction processes, maintenance and replacement activities, transportation and energy. Because CLT systems are not yet included in the Impact Estimator, additional LCA resources had to be applied to this analysis. Specifically, this study augmented Impact Estimator results using data from a published LCA study for the CLT product that was used in this building (Athena Sustainable Materials Institute, 2012b).

The Impact Estimator produces a subset of results according to a common North American impact assessment method known as TRACI¹. These impact categories from TRACI include:

- Global Warming Potential (GWP measured in kg of CO₂ equivalent)
- Acidification Potential (AP measured in moles of hydrogen ion (H⁺) equivalents)
- Respiratory Effects (RE measured in kg of particulate matter (PM) up to 10 microns)
- Eutrophication Potential (EP measured in kg nitrogen (N) equivalent)
- Ozone Depletion Potential (OD measured in kg chlorofluorocarbon-11 (CFC-11) equivalent)
- Smog Potential (measured in kg of ozone (O₃) equivalent)

The Impact Estimator excludes TRACI impacts for human toxicity and ecotoxicity, which are listed as optional measures in ISO 21930 (2007) due to greater uncertainty in these measures. Fossil fuel consumption is also an indicator category used by the Impact Estimator which refers to non-renewable fossil fuel energy consumption plus feedstock fossil fuel² and includes direct and indirect energy use along the supply chain.

2.2 Results

LCA results are best used to help guide decisions with an understanding that there is always uncertainty in an estimate of future states. For example, end-of-life assumptions can make a difference in the results for wood. Two end-of-life scenarios are included for both buildings to consider; landfilling and incineration. An additional scenario was considered for a second generation CLT building where 50% of the CLT panels are assumed to be from reused sources and 50% of the CLT panels are kept out of the landfill at the end-of-life for future reuse.

LCA results for the CLT building are given in Figure 1 normalized to the total emissions from the scenario where landfilling is used to dispose of un-recycled materials and no CLT panels are reused. In the following paragraphs, the results for each impact category are discussed. Following this, the results are presented normalized to total per capita U.S. emissions in 1999 to help contextualize the magnitude of the results.

In Figure 1, benefits from substituting the energy content of forest products for fossil fuel in the incineration scenario are kept separate from total impacts to differentiate between actual emissions and avoided emissions which, by definition, never physically exist. The net GWP benefit from wood products is also presented separately while detailed contributions from end-of-life and forest regrowth are discussed in the GWP section.

¹ U.S. EPA's Tool for the Reduction and Assessment of Chemical and Other Environmental Impacts (TRACI) 2.0 (Bare, 2011).

² Feedstock energy refers to the energy content of the material.

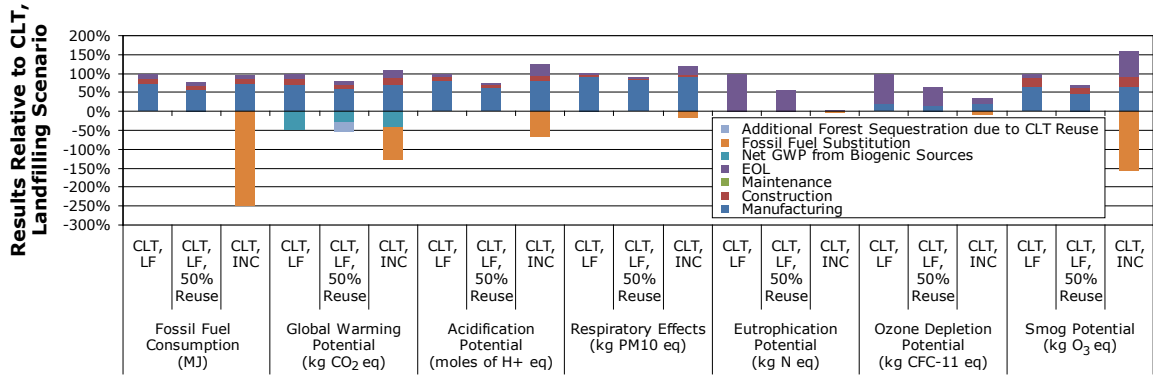

Note: Two end-of-life scenarios were modeled: landfilling (LF) and incineration (INC). In addition, a scenario is shown where 50% reclaimed CLT panels are used for the building and 50% of the panels are sent for reuse when the building is demolished. Results are presented relative to the landfilling scenario with no reused panels. Given that these results are intended to be used in a comparative building LCA published by FPInnovations in 2013, the system boundary excludes operational energy consumption, fenestration, foundation elements and other elements identified in Appendix B, as these elements were deemed equivalent between the building intended for comparison.

Figure 1

Preliminary LCA results – relative life cycle impacts, excluding operational phase and equivalent building components, broken down by life cycle stage

Fossil Fuel Consumption

Fossil fuel consumption is dominated by the material manufacturing stage. For the scenarios without reused panels, less than 8% of the emissions from the material manufacturing stage are due to transportation. Floors represent roughly 50% of fossil fuel consumption from the manufacturing stage which is almost exclusively from CLT production. When looking at CLT production, roughly 45% of fossil fuel use comes from the manufacturing of CLT while another 50% is from the rough dry lumber. When landfilling is used to dispose of un-recycled materials at the end-of-life, the same building made with 50% reused CLT panels allows for a 2% reduction in fossil fuel consumption. Relative to the modeled system, we also see that using wood products to produce heat at the end-of-life allows for the displacement of a significant quantity of fossil fuel use.

Global Warming

As the emissions driving GWP largely result from fossil fuel consumption, it is not surprising to find similar comparative results for GWP and fossil fuel consumption. We see significant potential for avoiding emissions in the incineration scenario when wood is used to produce energy at the end-of-life and substitute for natural gas use.

For the two scenarios not using reused CLT panels, the avoided GWP (-583 metric tons CO₂ eq) as carbon is re-sequestered during forest re-growth on the harvested land more than offsets the GWP from landfilling with no reused panels (452 metric tons CO₂ eq) and the incineration scenario (472 metric tons CO₂ eq). For the landfilling scenario with 50% reused panels, the avoided GWP from forest re-growth is -399 kg CO₂ eq while the landfilling emissions are 249 tons of CO₂ eq. The avoided emissions include the carbon that is re-sequestered on the land that was harvested to provide the wood for the building, but also the additional carbon that can be sequestered from the continued growth of trees that were not harvested due to the use of reused CLT panels if these trees were to continue to mature. Alternatively, this wood could be harvested and used in another building. At the same time, landfilling emissions are decreased in the scenario with reused CLT panels because it is assumed that 50% of the CLT panels are again reused at the end-of-life with less wood ending up in the landfill.

While methane is released when wood is landfilled, a large portion of wood is permanently sequestered so that the net GWP due to biogenic sources for landfilling and incineration is similar over a 100 year period. Appendix B provides additional information regarding end-of-life modeling.

Acidification

Emissions resulting in acidification were highest for the incineration scenario due to additional stack emissions. However, we also see a significant potential for avoiding acidification when the heat from wood incineration is used to displace natural gas use in a boiler. The potential for significant reductions in acidification are also found in a building with 50% reused CLT panels due to the high share of total acidification emissions which are due to CLT, the primary building material.

Respiratory Effects

Respiratory effects are similar across scenarios as the driver for these emissions are spread across the material manufacturing stage of several materials including gypsum, rebar, and concrete, and to a lesser extent mineral wool and CLT. While the combustion of wood products to produce heat at the end-of-life contributes additional particulate emissions, a large portion of these are offset by the direct and indirect emissions from avoided natural gas use.

Eutrophication

Eutrophication emissions result almost exclusively from the landfilling of wood products. Given that landfilling emissions and impacts are very site specific, results from eutrophication should be interpreted with caution. The landfill modeling undertaken in Simapro v7.3.3 using ecoinvent v2.2 data allows for the exclusion of long-term (> 100 year) emissions which results in a reduction in eutrophication emissions by a factor of over 100. The uncertainty involved in modeling the fate and impacts of long-term emissions suggests the need for further caution when interpreting these results. It is possible that the low levels of the emissions driving eutrophication over a long period of time will have minor negative impacts.

Ozone Depletion

Ozone depleting emissions also result mainly from landfilling. However, since ozone depleting emissions are shown below to be trivial when normalized to per capita yearly emissions in the United States, they are not discussed further.

Smog

Significant smog emissions occur across life cycle stages. At the end-of-life, smog emissions are mainly from the incineration of wood, but also from grinding up concrete and chipping wood. During the construction stage, smog emissions are almost exclusively from the transport of materials to the construction site of which the 310 miles (500 km) CLT transport is dominant. During the manufacturing stage, smog emissions result from CLT production, the production of concrete and rebar for the footings, as well as from gypsum and mineral wool production.

Normalization to Per Capita U.S. Emissions in 1999

Normalizing the environmental indicators of an LCA to total yearly per capita levels is useful for determining the significance of different impact categories. In Figure 2, results from this study are normalized to per capita U.S. emissions in 1999 using data from Bare, Gloria & Norris (2006) and the World Bank (2012). Noticeably long-term eutrophication emissions are quite high. Issues with this indicator have been addressed above. While ozone depleting emissions are relatively minor, other impact categories are equivalent to between 5 and 15 yearly per capita U.S. levels in 1999. Relative to the 20 odd apartment suites in the building, these normalized figures are small. However, the clean hydroelectricity sources in Québec that underpin the production of locally produced manufactured goods heavily influenced the results from this study. Normalizing GWP emissions (positive emissions in the graph) for the CLT building with landfilling to per capita GHG emissions in Québec in 2009, for example, is equivalent to 27 compared to around 10 in Figure 2³.

³ Per capita greenhouse gas emissions in the Province of Québec were 10.4 metric tons CO₂ equivalent in 2009 (ministère des Finances du Québec, 2012).

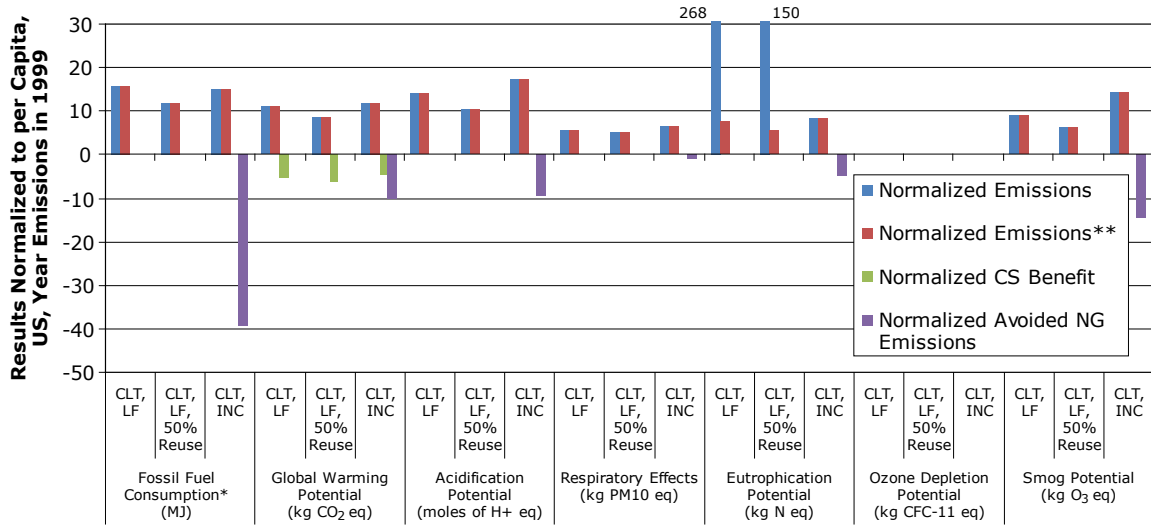

NB: CS = carbon sequestration; NG = natural gas

*Normalization values for fossil fuel consumption from World Bank (2012).

**Normalization excludes long-term emissions (>100 years) from landfill degradation.

Figure 2

Results normalized to total U.S. results from 1999 using data from Bare, Gloria & Norris (2006)

With the growing importance of global warming in environmental discussions, it is useful to discuss the carbon aspects of this analysis. The LCA study to be published by FPInnovations in 2013 will discuss the concept of a potential carbon offset value for CLT substitution. A carbon offset is also known as greenhouse gas displacement; it refers to the greenhouse gas emissions avoided by choosing an alternate practice over standard practice. Mid-rise buildings in Québec are not typically made with wood systems, therefore the use of wood in that application would be considered an alternate practice. In that context, if CLT results in reduced greenhouse gas emissions compared to standard practice, one could quantify the greenhouse gas displacement. Such a displacement is a permanent and cumulative benefit for climate change mitigation.

Carbon storage is an important attribute of long-lived wood products like structural components. The carbon in wood comes from carbon dioxide which was removed from the atmosphere by the tree as it grew. While this carbon returns to the atmosphere over the long term, completing the natural carbon cycle, the temporary storage in wood products allows additional CO₂ to be removed from the atmosphere during the building lifetime through the re-growth of trees. Wood products are not a permanent greenhouse gas removal mechanism; however, the temporary carbon storage in wood products can be reasonably considered a carbon credit, depending on time frame and end-of-life assumptions. This reasoning largely stems from the current urgency around climate change, where any delay in carbon emission is helpful in “buying time” to find mitigation solutions to climate change.

For traditional wood structural systems, the carbon mass of wood is relatively small compared to the carbon emissions avoided by using wood instead of steel or concrete (Sathre, O’Connor, 2010). Therefore, an important focus in the use of wood to combat climate change is to increase our rate of wood substitution for other materials, with less emphasis on carbon storage. With CLT, the relationship is the opposite: the carbon mass of wood is quite large compared to the avoided emissions of alternate materials. In this case, there is an interest in putting a value on that stored carbon, with a motivation to keep the carbon in service for as long as possible, and to capture the energy value of that carbon to replace fossil fuel at the end of service life. In total, the wood content of the

modeled CLT building equates to about 951 metric tons of CO₂. To put this amount in context, 951 metric tons of CO₂ are emitted in one year of driving 186 cars⁴.

It is important to recognize that the carbon profile of wood construction and any claimed carbon benefits rely on an assumption of sustainable forest management, such that long-term carbon stocks in forests do not decline due to the use of wood products; see the section on forest resource implications of CLT for discussion on that topic. In addition, note that carbon accounting with regards to wood and forestry is complex, as further discussed in Appendix B.

As a prefabricated product, CLT has good potential for recovery at the end of a building's service life for use in another building. Reusing CLT panels reduces GWP by 263 metric tons of CO₂ equivalent when the end-of-life scenarios include landfilling by reducing production and transport emissions and prolonging the release of stored carbon to the atmosphere.

⁴Conversion to cars was calculated using the U.S. EPA Greenhouse Gas Equivalencies Calculator, <http://www.epa.gov/cleanenergy/energy-resources/calculator.html>.

3

POTENTIAL INDOOR AIR QUALITY IMPACTS OF USING CLT IN BUILDINGS

In this section, we provide preliminary findings regarding emissions to indoor air from cross-laminated timber. This data applies to CLT made from two Canadian wood species, which is the only North American CLT commercially available at the time of this writing. Note that wood product emissions are species-specific, and these test results may not apply to products made from different manufacturers.

As regulatory and non-governmental organizations (NGOs) address indoor air quality issues, they tend to focus on volatile organic compounds (VOCs), including formaldehyde, as key factors relating to the discomfort reported by people working or living inside “air tight” buildings. For wood products, VOCs and specifically formaldehyde are of interest in products containing adhesives, which can be associated with emissions.

In this work, CLT samples were examined for VOC emissions in the FPInnovations laboratory, following applicable test method standards. Please see Appendix C for details on the test methods and the results.

Five CLT products were tested for their volatile organic compounds (VOCs), including formaldehyde and acetaldehyde emissions. The tested laminated products had different thicknesses and different numbers of glue lines. Emissions were collected after 24 hours of samples exposure in the environmental chamber. The adhesive used to manufacture the CLT products was a polyurethane glue (Purbond HB E202), while polyurethane Ashland UX-160/WD3-A322 glue was used for finger jointing.

Results did not show any correlation between individual VOCs (iVOCs), including formaldehyde and acetaldehyde, or total VOCs (TVOCs) and the thickness of the cross-laminated timber panel or the number of glue lines. All five products showed very low levels of iVOC (the highest level was observed with alpha-pinene and $340 \mu\text{g}/\text{m}^3$ for TVOC emissions); most of the detected VOCs consisted of terpene compounds that are naturally found in the wood material itself. Therefore, it can be concluded that the CLT tested will have a negligible or zero impact on indoor air quality.

The formaldehyde emission limits set forth by the Californian Air Resource Board (known under the acronym CARB Phase I and Phase II) are some of the most rigorous emission limits in the United States for wood composite products and have been in effect since July 1st, 2012. Results reported here show that the CLT samples tested easily meet the most stringent CARB limits.

In addition, the results for the five samples were generally lower than limits set forth by European emission labeling systems. In fact, the 24-hour CLT test results were lower than European limits intended for measurement after three days.

Please see Appendix C for details and further results.

4

RESOURCE ASSESSMENT: IMPACT OF CLT ON THE FOREST

When compared to traditional light-frame construction, CLT may appear to be at odds with one of the cornerstones of sustainable design—the efficient use of materials—potentially increasing the volume of wood used in a project substantially. We will discuss the topic of material efficiency later in this Chapter. In this section, we discuss the ability of North American forests to accommodate the use of a product that appears to consume a large amount of wood.

Traditionally, designers have relied on heavy construction materials such as concrete tilt up, steel frames, and composite decking systems to achieve a solid structure with large spans and tall plate heights. Anecdotal information from the WoodWorks⁵ team suggests that designers are increasingly considering the use of a timber alternative because of their perception that timber has carbon benefits when substituted for other materials and a relatively small manufacturing energy input; however, some have questioned whether an increase in demand for lumber will negatively impact our forest resources. If designers in the United States begin to replace construction materials typically used in commercial buildings with mass timber products such as CLT, will we create an unsustainable trend leading to forest resource depletion?

The answer is no. Stringent sustainable forest management practices in the United States and Canada restrict harvesting levels (while additionally maintaining other forest values such as biodiversity and wildlife habitat). Still, CLT users may wonder if a major uptake of CLT would be felt in the forest. In this Section, we use market data to demonstrate hypothetical scenarios; we show how many CLT buildings can easily be accommodated within historic sustainable supply capacity. Note that we do not address the availability of CLT; many other products compete for forest resources. In this exercise, we simply put theoretical CLT consumption in the context of current construction wood usage in order to provide a sense of magnitude of the potential impact of CLT.

In Chapter 1 of this Handbook, an assessment of the market opportunity for CLT was completed whereby the estimated 2015 volume of new construction was overlaid by market segment with the scenarios of CLT capturing both 5% and 15% of that new construction market. If CLT was used for 15% of new multi-residential and non-residential construction projects (1 to 10 stories) built in 2015, there would be a 12% increase in the overall board footage demand over 2011 levels. To put this in perspective, in 2011 the estimated U.S. lumber consumption was 22.6 billion board feet (BBF) (RISI), while in 2005, when the United States was at its peak for lumber demand, it is estimated that 45.5 BBF (RISI) was consumed—a difference of 186%. For the lumber market

⁵ WoodWorks is an initiative of the Wood Products Council established to provide free technical support as well as education and resources related to the design of non-residential and multi-family wood buildings.

to see 2005 levels of demand based on the construction expectations for 2015, CLT would have to comprise over 100% of the multi-residential and non-residential market.⁶

Potential impact on total consumption can be explored deeper in the context of a prototypical CLT building. The Stadthaus project in the United Kingdom is an eight-story, 24,000 square foot CLT structure, built over one story of concrete with 29 residential units and an office. This structure is one of the tallest modern timber structures in the world and includes an estimated 33,500 cubic feet (950 cubic meters) of timber (Waugh, 2009).

CLT is not currently being commercially produced in the United States for structural purposes, however domestic interests are high and the U.S. wood industry anticipates some local production by 2015. As such, it is pertinent to explore the effects of CLT use on U.S. forests. In 2006, 9.86 billion cubic feet of softwood lumber was harvested from U.S. forest lands, which means the lumber harvested for wood products in 2006 in the United States alone could build over 295,000 CLT structures equivalent in volume to the Stadthaus project or 7.06 billion square feet of CLT projects with equivalent density (cubic feet of timber/square foot of floor area).⁷

While the Stadthaus example may seem irrelevant because CLT construction would not replace current wood construction but rather represent additional demands, let's put this in another context. The 2012 demand for wood products is down more than 45% (RISI) from 2006 levels. Consider that, in addition to domestic supply, the United States imports on average 25-33% (RISI) of its wood supply from Canada. Because we know that the 2006 level of production did not adversely affect the domestic or Canadian standing inventory, it is plausible that, based on forecasts for 2012 U.S. construction, North American forests could accommodate over 176,696 CLT structures equivalent in volume to the Stadthaus project (or 4.24 billion square feet) in addition to the current demands for light-frame wood products.⁸

North American forestry has a proven record of maintaining the standing forest. Figure 3 shows the growth-removal ratios (growth/harvest) for U.S. forests in recent history. Since 1952, the growth-removal ratios for both softwood and hardwood demonstrate that growth has exceeded harvest and the United States has not been depleting its forest resources from a timber volume standpoint, even during periods of high demand. In 2006, when 1.7% of the standing volume of the forest was harvested (Smith et al., 2009; Table 17) and the United States produced 45.5 BBF of lumber (RISI), forest growth still exceeded harvest by close to 1%.

⁶ As previously noted, there are many end uses for forest resources, all of which may compete for a finite supply of raw materials depending on market economics. Should U.S. housing starts ever return to 2005 peak levels and thereby once again create a large demand for framing lumber, restricted supply of raw resources and the resulting effect on market prices may affect the availability of raw resources for CLT production. The current example is not meant to suggest that enough CLT would necessarily be available for building 100% of all multi-residential and non-residential buildings.

⁷ Again, this example is simply provided to convey a concept of scale, and to illustrate the vast number of CLT buildings that could be erected if all lumber supply were directed to this use.

⁸ Calculated based on the following:

- Volume of softwood lumber harvested in the United States in 2006 = $9.86 \times 10^9 \text{ ft.}^3$
- Estimated total volume of North American lumber consumed in 2006 (based on 25% historical Canadian imports) = $13.15 \times 10^9 \text{ ft.}^3$
- Estimated volume of softwood lumber harvested in the United States in 2012 = $5.42 \times 10^9 \text{ ft.}^3$
- Estimated total volume of North American lumber consumed in 2012 (based on 25% historical Canadian imports) = $7.23 \times 10^9 \text{ ft.}^3$
- Estimated volume of CLT in Stadthaus project = $33,500 \text{ ft.}^3$
- CLT Plan Square footage of Stadthaus project = $24,000 \text{ ft.}^2$
- Estimated additional capacity available = $(13.15 \times 10^9 \text{ ft.}^3 - 7.23 \times 10^9 \text{ ft.}^3) / 33,500 \text{ ft.}^3 = 176,696$ Stadthaus equivalent structures
- Estimated additional demand capacity available = $176,696 \text{ structures} \times 24,000 \text{ ft.}^2 / 1 \text{ structure} = 4.24 \times 10^9 \text{ ft.}^2$

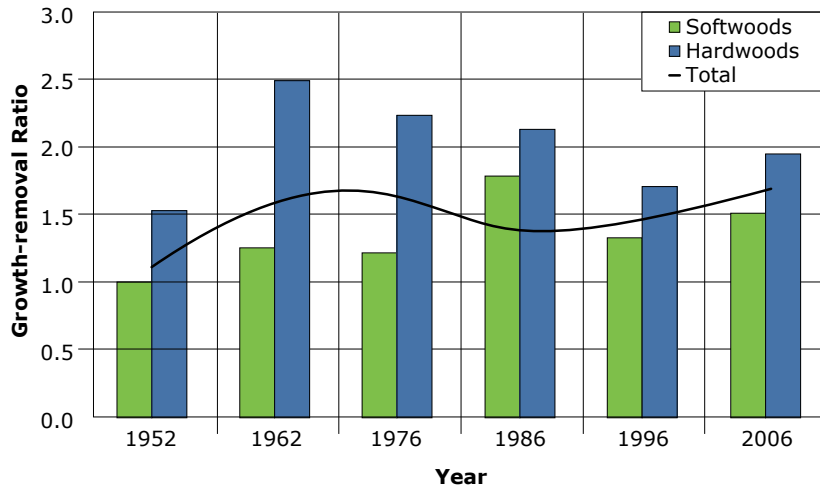

Figure 3
Growth-removal ratios by softwoods and hardwoods, 1952-2006 (Data source: Smith et al., 2009)

Overall, forest standing inventory is affected by more than growth and removal. Forest mortality due to insect, disease and fire also needs to be taken into account. While the mortality rate has been steadily increasing, the overall rate of loss remains less than 1% of the growing stock. This means that the overall standing inventory of softwood and hardwood continues to grow even with harvest and natural mortality factored in. Because CLT has the ability to utilize lower grade dimensional lumber, it also offers an opportunity to utilize a large percentage of forests devastated by insect and disease. CLT offers the possibility for the standing dead wood in such forests to be used in a high value product, financially incentivizing the use of what would otherwise be considered a wasted resource, provided the trees are accessible and near a mill.

Users of any wood products including CLT can be confident that North American forest practices comply with strict harvesting controls. Numerous government and industry publications provide detailed data on an annual basis for the purpose of transparent disclosure to the public about forests, harvesting and forest management. According to “Sustainable Forestry in North America”, a pamphlet that concisely summarizes this data, “there are a large number of federal policies covering U.S. forests, and the State and local legal requirements are also extensive. During the past 50 years, less than 2 percent of the standing tree inventory in the U.S. was harvested each year, while net tree growth was 3 percent.” Note that a portion of wood used in U.S. construction comes from Canada. “In Canada, 93 percent of the forests are publicly owned and forest companies operate under some of the most stringent sustainability laws and regulations in the world. Less than one half of one percent of the managed forest is harvested annually, and the law requires all areas to be promptly regenerated.”⁹

Worldwide, only 10 percent of forests are certified to one or more sustainable forest certification standards. These standards tend to have more similarities than differences and, while there are those who debate the merits of one over another, the real issues of concern—such as deforestation and illegal logging—are occurring in forests that are not certified and located in developing countries with insufficient laws and governing structures to ensure sustainable forest management.

⁹ For these forestry statistics and more information on forest practices in the United States and Canada, see “Sustainable Forestry in North America”, available at www.woodworks.org

As of August 2012, more than 500 million acres of forest in Canada and the United States were certified under one of the four internationally recognized programs used in North America: the Sustainable Forestry Initiative (SFI), Canadian Standards Association’s Sustainable Forest Management Standards (CSA), Forest Stewardship Council (FSC), and American Tree Farm System (ATFS), accounting for approximately 29% of North American forests (SFI, personal communication) (Figure 4). In the United States, the majority of non-certified forests are small (<10 acres) family-owned stands. There typically is no financial incentive for these small-scale operations to obtain third-party certification. A more pressing concern is to ensure these operations continue to maintain forested land—these small family-owned operations account for approximately 60 percent of the wood harvested in the United States—rather than be sold and converted into non-forest uses if there is inadequate financial incentive for productive forestry (Smith et al., 2009).

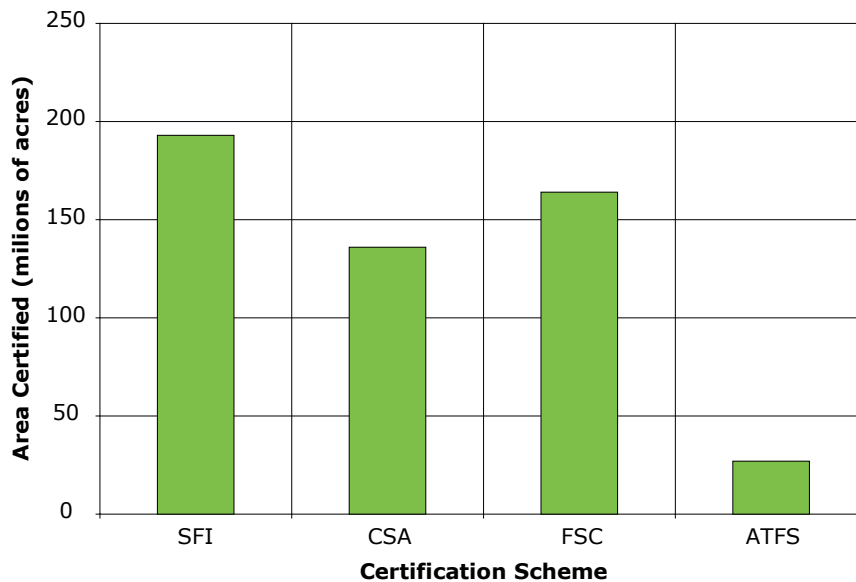

Figure 4
 Certified forest area in North America as of August 2012 (Sources: www.pefc.org, www.fscus.org, www.fscscanada.org, www.fsc.org, www.certificationcanada.org, www.mtc.com.my)

According to Kenneth Skog (personal communication) from the USDA Forest Products Laboratory, “Timber demand is projected to recover from recession levels over time with the recovery of the housing market and the general economy. Previous higher levels of timber demand have been well within the productive capacity of U.S. forests. Increases in demand for softwood lumber will increase revenue to forest landowners and increase the likelihood that land will be retained as forest and increase the likelihood of conversion of some non-forest or natural forest to plantation.”

5

POTENTIAL CONTRIBUTION OF CLT TO GREEN BUILDING OBJECTIVES

In green building programs, there are currently limited incentives that would directly encourage the use of CLT on environmental merits. Some direct and indirect green building motivations relevant to CLT might include:

- **Renewable materials:** as a wood material, CLT is renewable. Forest practices in North America are typically aligned with sustainable forest management principles, ensuring that wood is renewed. CLT consumption will not overly burden the sustainable supply capacity of North American forests as demonstrated in the previous section.
- **Local materials:** CLT is manufactured in North America and potentially can be sourced within a radius deemed “local,” depending on the definition of local, location of final installation, and the possible future emergence of more manufacturers than the two currently in operation at the time of this writing (both are located in Canada).
- **Certified wood:** CLT manufacturers can obtain chain-of-custody certification for sustainable forestry management.
- **Carbon storage:** if incentives should emerge for the value of the carbon stored for decades in buildings, CLT might have a market advantage over other structural systems.
- **Carbon offsets:** if incentives should emerge for the value of the greenhouse gas emissions avoided when using CLT in place of other materials with a higher greenhouse gas footprint (in other words, a carbon offset), CLT may experience market advantage.
- **LCA used during building design:** a number of design guidelines for green design such as the California Green Building Standards Code, the International Green Construction Code, Green Globes® and LEED¹⁰ contain possible motivators for designers to use life cycle assessment during the design process with the goal that they produce buildings having minimal LCA impact. Previous literature suggests that CLT systems have lower LCA impacts than alternative systems (see literature review in Appendix A).
- **EPD credits:** at the time of this writing, the draft of LEED v.4, anticipated for release in summer 2013, includes a Materials and Resources credit for designers to select products that have published environmental product declarations (EPDs) or have a published manufacturer-specific cradle-to-gate LCA study. In addition, at the time of this writing, LEED has a pilot credit for EPDs and manufacturer-specific LCAs. At this time, the two North American manufacturers of CLT (Structurlam and Nordic) have LCA reports and are developing EPDs.

¹⁰ LEED Pilot Credit 63 (in place as of this writing; future status unknown given the pending arrival of LEED v.4) provides an incentive for designers to use whole-building LCA to show improvement of a final design over a reference building. This credit, in a slightly different form, is a new credit proposed for LEED v.4 (the 5th comment period version).

- **Health, comfort and well-being benefits:** Occupants exposed to wood have shown benefits in their well-being [Fell, 2010]; CLT—if left exposed—may contribute to a health and comfort objective. CLT does not adversely affect indoor air quality, as shown in the previous section.
- **Reusability:** As a panelized system, CLT has good potential for disassembly and reuse. Realizing this potential will require development of construction details for disassembly and the infrastructure to transfer products to a new site.
- **Operating energy savings:** CLT is a massive material with some thermal mass; thermal mass is often identified as a contributor to overall savings in a building’s heating and cooling loads and/or costs due to peak load shifting.
- **Efficient use of resources:** As a prefabricated product, CLT has minimal construction site waste, and construction time is shortened. Waste created at the time of manufacture is minimized by automation and can be fed back into the manufacturing plant’s biofuel plant for use as carbon neutral energy.

Material efficiency is an important sustainable design objective that requires discussion with respect to CLT. CLT buildings are massive, which is an unusual use of wood from the North American light-frame perspective. At first glance, CLT may appear wasteful, if we are comparing CLT to light-frame wood.

However, the distinction between light-frame and “heavy” construction is important in the assessment of efficiency and a key element in determining the environmental benefits of CLT. For example, when light gauge metal is compared with heavy steel braced frames, the question of material efficiency probably doesn’t arise. This is because most architects and engineers understand that there is a difference in application and required performance for each of these structural systems.

The intent of CLT is not to replace light-frame construction, but rather to offer a low-carbon alternative to “heavy” construction materials such as concrete and steel. There are building applications where light-frame construction is less appropriate, such as an industrial warehouse with 40’ walls that need to withstand the impacts of heavy machinery, or a Class A office building where few partition walls and minimal floor vibrations are desired. Traditionally, designers have relied on heavy construction materials such as concrete tilt up, steel frames and composite decking systems to achieve a solid structure with large spans and tall plate heights. Today, more designers are considering the use of a timber alternative.

When CLT is properly considered within the context of heavy construction systems, it can be an efficient use of wood. Nonetheless, every construction system should be designed for maximum efficiency, and there are methods for maximizing the effectiveness of CLT systems. For example:

- **Optimize span capabilities.** Whether it is tailoring a design to meet the maximum span of a specific CLT product or optimizing the layout to meet the demands of the design, designers and manufacturers should work together to maximize utilization of CLT’s structural capacity. Final CLT shop drawings and design are done by the manufacturer and each manufacturer will differ in their panel dimensions, lamination thicknesses, connections, wood species and preferred layout configurations. For this reason, it is important to engage the preferred fabricator early in the design process if some of these factors are critical for architectural or other requirements.
- **Optimize the openings.** When the panel layouts are established for a design, use beams over doorways and place windows in between full size panels to avoid waste that might be created if a full panel was used with cut out openings. Using more full sized panels also allows more versatility to reuse the panels later in the product lifecycle.

Both of these strategies may be initiated by CLT manufacturers in order to reduce costs. There are also more elaborate ways for designers to ensure efficient use of CLT:

- **Use folded diaphragms.** This is a sophisticated technique used with other heavy construction materials that enables CLT panels to span greater distances without increasing the wood fiber needed in the lamination. A folded plate design borrows stiffness from the out-of-plane diaphragm to increase the moment of inertia or stiffness of an assembly by increasing the effective distance between the extreme fibers in the bending plane. Connection design at the fold is critical but the load can be distributed along the entire joint instead of concentrated at discrete points.
- **Employ 3D structural analysis techniques.** CLT structures have the ability to act in three dimensions. Similar to a folded diaphragm, the cube effect takes advantage of CLT's ability to transfer load in all three axes in the same panel. A single CLT panel can take a vertical axis load anywhere in the plane of the panel, lateral shear load in the other axis of the same plane, and a bending load into the face of the panel and transfer the resulting shear in a third axis. Therefore, including a structural analysis that takes advantage of this cube effect may reduce the amount of material required in the overall structural design.
- **Account for disaster resilience capabilities.** In the world of sustainable design, the concept of disaster resilience is only going to become more prominent. There is a considerable advantage to having a building with the ability to quickly return to operation after a disaster and in the process minimizing the life cycle impacts associated with its repair. Based on the full scale seismic testing discussed in Chapter 4 entitled *Lateral design of cross-laminated timber buildings*, CLT structures may offer more disaster resilience than those built with other heavy construction materials. Because failures are designed to happen at the connections, the test building suffered isolated and minimal structural damage even after 14 consecutive shake table tests. Assuming the same results for an actual building, the rehabilitation and repair required following an earthquake would also be minimal.

6

MATERIAL DISCLOSURE

Cross-laminated timber contains only two materials: lumber and adhesive. For the two North American CLT manufacturers in commercial production at the time of this writing, lumber is locally sourced (maximum transportation distance 329 miles/530 km) and comprises a few softwood Canadian species. Two adhesives are used: polyurethane and arclin melamine.

7

CONCLUSIONS

In this Chapter, we assessed several attributes of CLT to determine if this product could be a contributor to green building objectives. Our conclusion is yes, CLT meets many criteria designers might be looking for when specifying materials for sustainable construction.

In particular, the use of wood in buildings prior to using the wood to produce energy offers clear advantages. As reported in numerous other studies¹¹, wood products typically contain more carbon than is emitted during harvest, manufacturing, transportation and end-use. This carbon was removed from the atmosphere when the living tree absorbed the greenhouse gas carbon dioxide. Based on our preliminary results, a significant portion of material-related greenhouse gas emissions from a CLT building in Québec are offset by the carbon storage benefits of wood and the potential for substituting fossil fuel energy sources with wood at the end of the building life.

From an environmental standpoint, carbon storage benefits involve a delayed greenhouse gas emission during the time that forests re-grow and re-sequester carbon; the carbon storage in wood products is temporary as the carbon will eventually return to the atmosphere, and, therefore, over a long time frame, has no effect on global carbon balances. However, a carbon-balance does not equal climate-neutral and delayed emissions from the storage of wood products provide quantifiable benefits for avoiding atmospheric warming over the short term (~100 years or so), as demonstrated by our results, that diminish over extended time horizons (Guest, Cherubini & Strømman, 2012).¹² Based on the urgent need to reduce greenhouse gas emissions in the short term to avoid “dangerous anthropogenic interference with the climate system” — internationally recognized as a global temperature change of more than 2°C (UNFCCC, 2010, p. 5) — the avoided GWP from using wood products in buildings presents an opportunity to contribute to short-term emissions reductions.

The carbon stored in wood products in long-term use such as construction is a substantial carbon pool which would be increased with the use of CLT. This product might help extend the timeline for this stored carbon, as CLT panels may be good candidates for recovery at the end of building life, for reuse in another building.

¹¹ For example, see the 40 papers reviewed in Werner, F. and Richter, K., 2007, *Wooden building products in comparative LCA: A literature review*; *International Journal of Life Cycle Assessment*, 12(7): 470-479; and the 66 papers reviewed in Sathre, R and O'Connor, J., 2010, *A Synthesis of Research on Wood Products and Greenhouse Gas Impacts*, 2nd Edition, FPInnovations.

¹² For a 100 year rotation period, Guest et al. (2012) show that 1 kg of wood products stored for 60 years has a GWP using a 100 year time frame of around -0.07 kg CO₂ eq, when incinerated at year 60, vs. a GWP using a 500 year time frame of -0.01 kg CO₂ eq.

8

REFERENCES

ASTM International. 1996. *Standard test method for determining formaldehyde concentration in air from wood products using a small-scale chamber*. ASTM D6007-96. West Conshohocken, PA: ASTM. 8 p.

_____. 2002. *Standard test method for determining formaldehyde concentrations in air and emission rates from wood products using a large chamber*. ASTM E1333-96(2002). West Conshohocken, PA: ASTM. 12 p.

_____. 2003. *Standard test method for determination of formaldehyde and other carbonyl compounds in air (active sampler methodology)*. ASTM D5197-03. West Conshohocken, PA: ASTM. 15 p.

_____. 2006. *Standard guide for small-scale environmental chamber determination of organic emissions from indoor materials/products*. ASTM D5116-06. West Conshohocken, PA: ASTM. 15 p.

Athena Sustainable Materials Institute. 2009. *A cradle-to-gate life cycle assessment of Canadian softwood lumber*. Ottawa, ON: Athena Sustainable Materials Institute.

Athena Sustainable Materials Institute. 2012a. *Impact estimator*. Retrieved July 12, 2012, from <http://calculatelca.com>.

Athena Sustainable Materials Institute. 2012b. *Lifecycle assessment of cross-laminated timber produced at Nordic Engineered Wood Products*. Ottawa, ON: Athena Sustainable Materials Institute.

Bare, J. 2011. TRACI 2.0: The tool for the reduction and assessment of chemical and other environmental impacts 2.0. *Clean Technologies and Environmental Policy* 13 (5):687–696. doi:10.1007/s10098-010-0338-9.

Bare, J., T. Gloria, and G. Norris. 2006. Development of the method and U.S. normalization database for Life Cycle Impact Assessment and sustainability metrics. *Environmental Science & Technology*, 40 (16):5108–5115. doi:10.1021/es052494b.

Barry, A. 1995. Measurement of VOCs emitted from particleboard and MDF panel products supplied by CPA mills: A report by Forintek Canada Corporation for the Canadian Particleboard Association. Quebec, QC: Forintek. 20 p.

Barry, A., and D. Corneau. 1999. Volatile organic chemicals emissions from OSB as a function of processing parameters. *Holzforschung* 53:441-446.

Barry, A., D. Corneau, and R. Lovell. 2000. Press volatile organic compounds emissions as a function of wood processing parameters. *Forest Products Journal* 50 (10):35-42.

BIFMA International. 2007. *Standard test method for determining VOC emissions from office furniture systems, components and seating*. ANSI/BIFMA M7.1-2007. Grand Rapids, MI: BIFMA International. 53 p.

Bright, R.M., F. Cherubini, and A.H. Strømman. 2012. Climate impacts of bioenergy: Inclusion of carbon cycle and albedo dynamics in life cycle impact assessment. *Environmental Impact Assessment Review* 37:2–11. doi:10.1016/j.eiar.2012.01.002.

Cherubini, F., G.P. Peters, T. Berntsen, A.H. Strømman, and E. Hertwich. 2011a. CO₂ emissions from biomass combustion for bioenergy: Atmospheric decay and contribution to global warming. *GCB Bioenergy* 3 (5):413–426. doi:10.1111/j.1757-1707.2011.01102.x.

Cherubini, F., A.H. Strømman, and E. Hertwich. 2011b. Effects of boreal forest management practices on the climate impact of CO₂ emissions from bioenergy. *Ecological Modelling* 223(1):59–66. doi:10.1016/j.ecolmodel.2011.06.021.

Commission of the European Communities. 1989. *Formaldehyde emission from wood based materials: Guideline for the determination of steady state concentrations in test chambers*. Report no. 2 of EUR 12196 - European concerted action: Indoor air quality and its impact on man. COST Project 613. Brussels, Luxembourg: Office for Official Publications of the European Communities. 24 p.

Fell, D. 2010. Wood in the human environment: Restorative properties of wood in the built indoor environment. PhD diss., University of British Columbia. 134 p.

Gagnon, S., and C. Pirvu, eds. 2011. *CLT handbook: Cross-laminated timber*. Canadian ed. Special Publication SP-528E. Quebec, QC: FPIInnovations. 1 v.

Guest, G., F. Cherubini, and A. H. Strømman. 2012. Global warming potential of carbon dioxide emissions from biomass stored in the anthroposphere and used for bioenergy at end of life. *Journal of Industrial Ecology* doi:10.1111/j.1530-9290.2012.00507.x.

Gustavsson, L., A. Joelsson, and R. Sathre. 2010. Life cycle primary energy use and carbon emission of an eight-story wood-framed apartment building. *Energy and Buildings* 42 (2):230-242.

Intergovernmental Panel on Climate Change (IPCC). 2006. Solid waste disposal. Chapter 3 in Waste, vol. 5 of *2006 IPCC guidelines for national greenhouse gas inventories*. Retrieved from <http://www.ipcc-nggip.iges.or.jp/public/2006gl/vol5.html>.

John, S., B. Nebel, N. Perez, and A. Buchanan. 2009. Environmental impacts of multi-storey buildings using different construction materials. Research Report 2008-02. Christchurch, New Zealand: University of Canterbury, Department of Civil and Natural Resources Engineering. 135 p.

Kostiuk, A.P., and F. Pfaff. 1997. *Conversion factors for the forest products industry in eastern Canada*. Sainte-Foy, QC: Forintek Canada Corp., Eastern Division.

Lvasseur, A., P. Lesage, M. Margni, L. Deschênes, and R. Samson. 2010. Considering time in LCA: Dynamic LCA and its application to global warming impact assessments. *Environmental Science & Technology* 44 (8):3169–3174. doi:10.1021/es9030003.

Lvasseur, A., P. Lesage, M. Margni, and R. Samson. 2012. Biogenic carbon and temporary storage addressed with dynamic life cycle assessment. *Journal of Industrial Ecology*. doi:10.1111/j.1530-9290.2012.00503.x.

- Mahalle, L., J. O'Connor, and A. Barry. 2011. Environmental performance of cross-laminated timber. Chapter 11 in *CLT handbook: Cross-laminated timber*. Canadian ed. Québec, QC: FPInnovations. 1 v.
- Malmsheimer, R.W., J.L. Bowyer, J.S. Fried, E. Gee, R.L. Izlar, R.A. Miner, I.A. Munn, et al. 2011. Managing forests because carbon matters: Integrating energy, products, and land management policy. *Journal of Forestry* 109 (7S):S7–S51.
- McKeever, D.B., C. Adair, and J. O'Connor. 2006. *Wood products used in the construction of low-rise nonresidential buildings in the United States*, 2003. Tacoma, WA: Wood Products Council. 63 p.
- Meil, J., M. Lucuik, J. O'Connor, and J. Dangerfield. 2006. A life cycle environmental and economic assessment of optimum value engineering in houses. *Forest Products Journal* 56 (9):19-25.
- Micales, J.A., and K.E. Skog. 1997. The decomposition of forest products in landfills. *International Biodeterioration & Biodegradation* 39 (2-3):145–158. doi:10.1016/S0964-8305(97)83389-6.
- Muter, D., and J. O'Connor. 2009. Market and GHG assessment of new wood applications. Vancouver, BC: FPInnovations. 32 p.
- O'Halloran, T.L., B.E. Law, M.L. Goulden, Z. Wang, J.G. Barr, C. Schaaf, M. Brown, et al. 2012. Radiative forcing of natural forest disturbances. *Global Change Biology* 18 (2):555–565. doi:10.1111/j.1365-2486.2011.02577.x
- Olutimayin, S.O., C. Simonson, J. O'Connor, M. Salonvaara, and T. Ojanen. 2005. Effect of moisture storage on indoor humidity and vapor boundary layer thickness. In *Proceedings of the 10th Canadian Conference on Building Science and Technology, May 12-13, Ottawa*, vol. 1, 194-203.
- Québec (Province). Ministère des Finances. 2012. *Quebec and climate change: A greener environment*. Quebec, QC: Finances Québec. Retrieved from <http://www.budget.finances.gouv.qc.ca/Budget/2012-2013/en/>.
- Resource Information Systems, Inc. (RISI). 2012a. *North American Lumber Annual Historical Data*. Bedford, MA: RISI.
- Resource Information Systems, Inc. (RISI). 2012b. *North American Wood Panels Annual Historical Data*. Bedford, MA: RISI.
- Robertson, A. 2011. A comparative life cycle assessment of mid-rise office building construction alternatives: Laminated timber or reinforced concrete. Master's thesis, University of British Columbia. Retrieved from <https://circle.ubc.ca/>.
- Robertson, A.B., F.C.F. Lam, and R.J. Cole. 2012. A comparative cradle-to-gate life cycle assessment of mid-rise office building construction alternatives: Laminated timber or reinforced concrete. *Buildings* 2 (3):245–270. doi:10.3390/buildings2030245.
- Sathre, R. and J. O'Connor. 2010. *A synthesis of research on wood products and greenhouse gas impacts*. 2nd ed. Technical Report TR-19R. Vancouver, BC: FPInnovations. 117 p.
- Skog, K. 2008. Sequestration of carbon in harvested wood products for the United States. *Forest Products Journal* 58 (6):56–72.
- Smith, W.B., P.D. Miles, C.H. Perry and S.A. Pugh. 2009. *Forest resources of the United States, 2007*. Gen. Tech. Rep. WO-78. Washington, DC: USDA Forest Service. 336 p.

Thompson, H. 2009. *A process revealed*. London, UK: FUEL Publishing. 96 p.

United Nations Framework Convention on Climate Change (UNFCCC). 2010. *Copenhagen Accord*. Retrieved from <http://unfccc.int/2860.php>.

World Bank. 2012. *Data: Energy & mining - Energy use*. Retrieved from <http://www.worldbank.org/>.

APPENDIX A

LITERATURE REVIEW

A1 Literature Review on Environmental Performance of CLT

There is very little existing LCA data or validated comparative studies addressing CLT. Several promotional pieces on the mid-rise Stadthaus building in England make comparative assertions about CLT, but these lack support literature, clarity and methodological accuracy.

Gustavsson et al. (2010) performed a full life cycle assessment of energy use and greenhouse gas emissions for a CLT mid-rise building in Sweden (part of the Limnologen project). Energy use and carbon flows are tracked along the entire chain and include carbon stocks in building products and avoided fossil fuel combustion emissions where biofuel residues are used as a substitute energy source for fossil fuel. The authors argue that a major carbon benefit for this wood-intensive building is the side effect of using wood residues as an energy substitute for fossil fuel. The biofuel can be collected in the form of harvesting residues, wood manufacturing residues, and—eventually—the CLT panels themselves at the end of their useful life.

Robertson (2010, 2012) conducted a comparative LCA study on a five-story office building made of concrete versus a CLT and glulam hybrid building, using a life cycle inventory from primary data gathered at a CLT pilot plant in British Columbia. Results indicate a lower environmental impact for the glulam/CLT building over the concrete building in nine out of eleven environmental indicators.

A mid-rise LCA study by John et al. (2009) could provide a comparative basis for examining the CLT results in the Swedish study. This New Zealand study performed full LCA for four different structural approaches to a six-story office building (concrete, steel, and two different wood versions). While results from the New Zealand study are not directly comparable to those of the Swedish study, we can potentially draw general conclusions about the likely comparative results for CLT. It is useful to look at the two versions of wood buildings in the New Zealand study. One used a fairly conventional quantity of structural wood while the other (called “timber plus” by the authors) increased the use of wood in that model by assuming wood substitution for additional products such as windows, ceilings and exterior cladding. The study found that total life cycle energy consumption and carbon footprint both decrease as the use of wood increases. A similar examination was performed by Meil et al. (2006) with similar results. In both studies, the reason for this benefit is the substitution of wood for non-wood materials that have a heavier energy/greenhouse gas footprint.

In the New Zealand study, various end-of-life scenarios were examined and operating energy was included; these are two important factors to consider when properly comparing wood to other materials in construction. In this study, thermal mass in the buildings was accounted for in the energy modeling, and the concrete building had the lowest operating energy consumption. However, this was overtaken by the embodied energy savings of the “timber plus” version over the concrete version due to product substitution. For the end-of-life landfilling scenario, the authors also contend that a significant portion of the carbon contained in the wood materials is stored permanently, giving both wood versions of the building lower total life cycle carbon footprints than the steel and concrete versions. The “timber plus” version has a substantially lower total carbon footprint than the other wood version due to embodied energy savings in product substitution, lower operating energy consumption due to thermal mass, and a greater mass of wood carbon in permanent landfill storage.

From this study, we can perhaps form a hypothesis about likely comparative performance of CLT. If we assume that CLT has a smaller manufacturing carbon footprint than concrete and that all other life cycle factors are similar to the “timber plus” model, it would follow that a CLT version would perform similarly or perhaps better than the “timber plus” model, given that it would have more wood mass available for permanent landfill storage at end of life.

In the Canadian edition of the CLT Handbook, a hypothetical LCA comparison was conducted (Mahalle et al., 2011). Glulam was used as a proxy for CLT, as no LCA data was available at that time. CLT was compared to concrete functional equivalents in the context of a mid-rise building and in the context of a floor. In both cases, the CLT option showed lower results in all impact measures and resource consumptions addressed in the study.

APPENDIX B

DETAILS ON THE MID-RISE LCA STUDY

B1 Objective and Method

The objective of the work reported here is to provide preliminary findings from an environmental life cycle assessment (LCA) of a 43,700 square foot, four-story (plus one underground level) CLT apartment building.

LCA is a ISO 14040/14044 (2006; 2006) standardized tool used to evaluate the environmental performance of a product, service or system.¹³ It involves evaluating the energy and material inputs, as well as wastes that are produced, throughout the supply chain and end-of-life disposal of a product. LCA is useful for identifying environmental hot-spots along the supply chain, for avoiding problem shifting where one environmental problem is 'solved' by shifting the environmental burdens in time or space from one phase of a product lifecycle to another phase, and for highlighting trade-offs between different environmental indicators.

Engineering and architectural drawings for an existing four-story CLT apartment building in Chibougamau, Québec, are used to create a detailed bottom-up material inventory for this assessment. The building lifetime is assumed to be 60 years. The Athena Impact Estimator is the building LCA tool adopted for this analysis. The Impact Estimator uses regional information in its calculations; Québec City was chosen as a location because it is the Impact Estimator predefined location closest to Chibougamau where the actual building is located.

As the results from this study are intended for use in a comparative building assessment to be released by FPIInnovations in 2013, building elements that were known or assumed to be identical were excluded. Those include: fenestration, exterior cladding, flooring, HVAC, hand railings, plumbing and electrical equipment, etc.

The system boundary describes the phases of the building lifecycle included in the analysis. These are: resource extraction and material production, construction, maintenance and replacement, demolition, and associated transport processes (see Figure 5). Building operation was assumed to be equivalent and excluded from the analysis. Further exclusions due to a lack of data included architectural and engineering services, and worker transport.

¹³The terms product, system and service are used interchangeably throughout the rest of this Chapter and simply refer to the object of the LCA investigation.

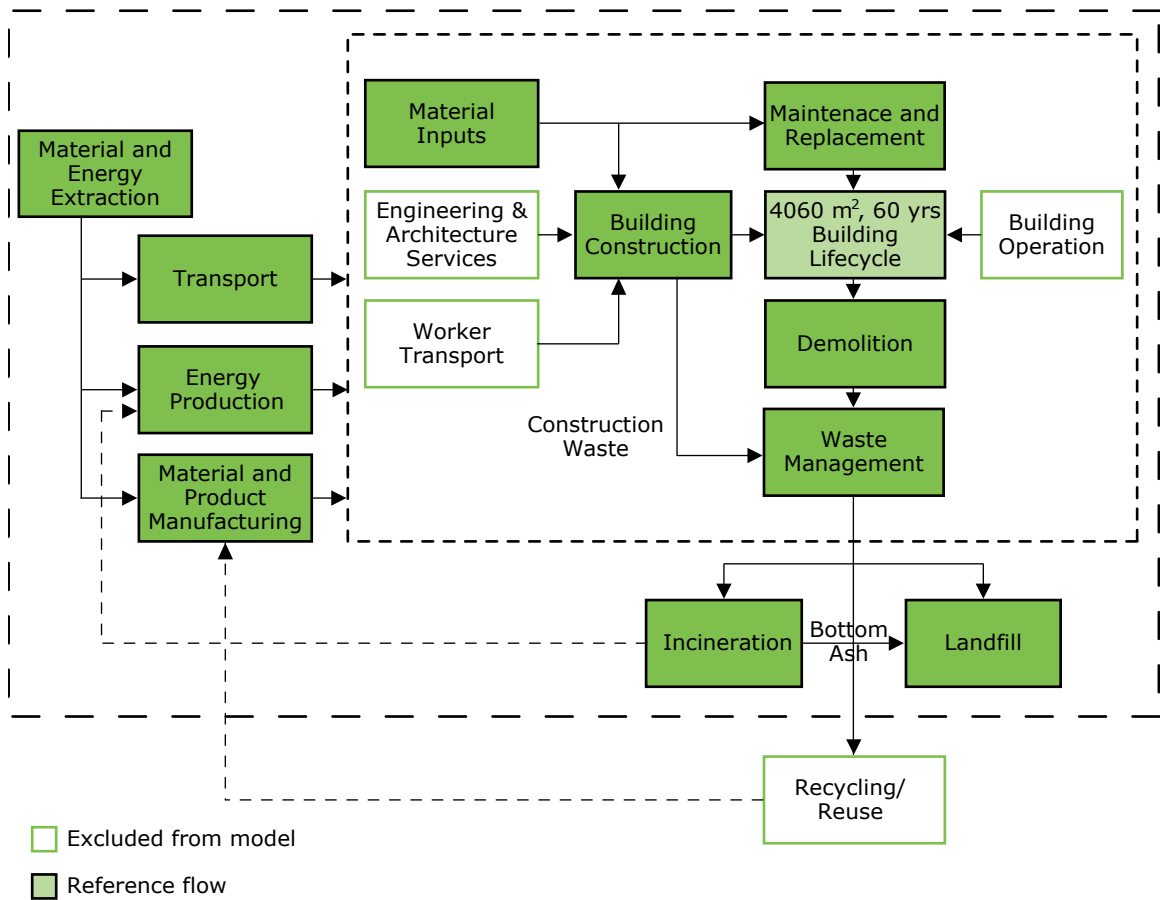

Figure 5
System boundary

Data collection for LCA involves developing a life cycle inventory (LCI) for all material, energy and service inputs and outputs of the system. When describing data requirements for a LCA, it is useful to distinguish between the foreground system, what is explicitly modeled, and the background system, which relies on secondary data sources.

The foreground system for this particular system was developed through detailed, bottom-up material estimates for a residential CLT building. An overview of the LCI developed for the foreground system is presented below.

The main sources for background data are embedded in the Athena Impact Estimator (v4.2.0130 (Athena Sustainable Materials Institute, n.d.)). The Impact Estimator includes the Athena Institute's regional, North American LCI database for building products, as well as energy and transport LCI data from the USLCI database. Additionally, the Impact Estimator includes estimates for transportation requirements, construction waste coefficients, construction effects, maintenance and replacement activities, and end-of-life treatment. A final important source of background data included cradle-to-grate LCI data for the manufacture of CLT in Chibougamau, Québec, over 310 miles (500 km) north of Québec City (Athena Sustainable Materials Institute, 2012b).

The impact assessment methodology and impact categories adopted for this assessment are a subset of the U.S. EPA's Tool for the Reduction and Assessment of Chemical and Other Environmental Impacts (TRACI) 2.0 (Bare, 2011), which is used by the Impact Estimator. The TRACI impact categories include:

- Global Warming Potential (GWP, measured in kg of CO₂ equivalent)
- Acidification Potential (AP, measured in moles of hydrogen ion (H⁺) equivalents)
- Respiratory Effects (RE, measured in kg of particulate matter (PM) up to 10 microns)
- Eutrophication Potential (EP, measured in kg nitrogen (N) equivalent)
- Ozone Depletion Potential (OD, measured in kg chlorofluorocarbon-11 (CFC-11) equivalent)
- Smog Potential (measured in kg of ozone (O₃) equivalent)

The Impact Estimator excludes TRACI impacts for human toxicity and ecotoxicity, which are listed as optional measures in ISO 21930 (2007) due to greater uncertainty in these measures. Fossil fuel consumption is also an indicator category used by the Impact Estimator which refers to non-renewable fossil fuel consumption plus feedstock fossil fuel and includes direct and indirect energy use along the supply chain.

CLT results from the Athena Sustainable Materials Institute (ASMI, 2012b) were developed in Simapro v7.3.3 using the TRACI 2.0, v4.00, methodology in addition to the Cumulative Energy Demand (CED) v1.06 method which was used for estimating total fossil fuel use in megajoules (MJ) for the production and delivery of CLT to the construction site.

B1.1 Life Cycle Inventory

Material quantities for the existing CLT building were estimated from structural engineering and architectural drawings for a recently completed CLT building in Chibougamau, Québec.

Construction effects in the Impact Estimator modeling include transport to the building site, construction waste factors, and the use of a diesel powered crane. Transport for the CLT panels, which are currently not contained within the Impact Estimator, were modeled using the USLCI process for diesel powered combination trucks and an estimated transport distance of 320 miles (515 km) from the CLT producer in Chibougamau to the building site in Québec City. Additionally, equivalent weight glulam data was used as a proxy in the Impact Estimator to estimate diesel consumption from crane operation during construction. Construction waste for CLT was assumed to be 0% since off-cuts, and cuts for doors and windows are accounted for upstream at the CLT manufacturing plant.

Maintenance and replacement is modeled using replacement schedules in the Impact Estimator. The exclusion of equivalent materials and building products, however, is such that most items requiring maintenance and replacement have been excluded from this study including paint, windows and doors, and finished flooring.

End-of-life effects in the Impact Estimator include demolition energy per unit of structural material and transport to the landfill. Transport to the landfill in the Impact Estimator is based on the percentage of materials that end up at the landfill, and an average, location specific, landfill distance. Impact Estimator assumptions for transport distances and material fractions ending up in disposal are hidden from the user. This study uses end-of-life transport assumptions from the Impact Estimator and applies these assumptions in Table 1 for modeling additional end-of-life processes. Those additional processes including incineration, landfilling and recycling are modeled using Simapro v7.3.3. Transportation of recycled materials from the building site is not included as these impacts are considered to belong to the next product lifecycle. Glulam results from the Impact Estimator were again used as a proxy of end-of-life results for CLT.

End-of-life impacts from wood products were assessed via scenario analysis of 1) landfilling, 2) municipal waste incineration and wood combustion in an industrial boiler and 3) avoided natural gas use due to the embodied energy content of the wood. Landfilling and incineration were assessed using ecoinvent v 2.2 waste treatment processes adjusted for a Québec electricity mix.

Wood combustion in an industrial boiler was modeled using the Franklin and Associates process for ‘Wood into Industrial Boiler FAL’ in Simapro v7.3.3. The wood moisture content for the Franklin and Associates process for ‘Wood into Industrial Boilers’ is not provided in the process documentation. The inventory of the process indicates that 1,000 lb. (454 kg) of wood is consumed to produce 1,050 lb. (476 kg) of biogenic CO₂. Assuming 50% of the mass of oven dry wood is carbon, this suggests an oven dry mass input of roughly 572 lb. (260 kg) of wood using a molar ratio of 12/44 for C/CO₂. In order to maintain the carbon balance, the stack emissions from wood combustion were estimated based on 1,000 lb. (454 kg) of wood into the process ‘Wood into Industrial Boiler FAL’ for every 572 lb. (260 kg) of oven dry wood waste. This assumes that the combustion emissions for a unit of wood are independent of the moisture content for that unit of wood. For the 1,143,073 lb. (518,489 kg) of oven dry wood in the CLT building, the emissions profile from 1,995,840 lb. (905,297 kg) of wood combustion from the Franklin and Associates process for ‘Wood into Industrial Boilers’ was inventoried.

The major particulate matter emission from the Franklin & Associates process for ‘Wood into Industrial Boiler’ was particulate matter (PM) <10 microns. Through the results, it was discovered that the TRACI 2.0 methodology has no respiratory effect emissions factor for these emissions. To address this deficiency, an average of the PM<10 emission factors from IMPACT 2002+ and RECIPE impact assessment methodologies available in Simapro V7.3.3 were used after re-scaling them to be consistent with TRACI 2.0 characterization factors.

Landfill gas capture is not included in the model for landfilling so the wood carbon is released as carbon dioxide and methane. A further adjustment for landfill modeling was to increase the assumed wood carbon released to the atmosphere for landfilled wood products, which is assumed in ecoinvent v2.2 (Doka, 2009) to be 1.5% following Micales & Skog (1997), to 23% following Skog (2008) with half of the wood decaying over 29 years. A proportion of 45% of landfilled carbon is assumed to be released as methane, while 55% are released as CO₂. These figures are representative of an anaerobic, managed landfill as defined by the IPCC (2006).

The energy content of wood—based on the lower heating value of red spruce with a wet basis moisture content of 20% (16.24 MJ/kg) and a boiler efficiency of 75% (Kostuik & Pfaff, 1997)—was assumed to avoid an equivalent amount of energy produced from natural gas consumed in an industrial boiler with a thermal efficiency of 80%.

The potential avoided emissions due to end-of-life metal recycling were excluded due to limitations with the Impact Estimator data. However, LCI data already includes benefits due to recycled products (e.g., rebar is made of mainly recycled steel) on the production side. To evaluate the potential benefits of reusing CLT panels, one scenario was developed to consider a second generation CLT building constructed with 50% reused CLT panels which were transported 31 miles (50 km) from a local storage facility.

Table 1

Material disposal assumptions

Materials	Landfilling	Incineration ¹	
	Reuse/Recycling %	Reuse/Recycling %	Incineration %
CLT	0	0	100
Kiln dried lumber	0	0	100
Plywood	0	0	100
PSL	0	0	100
Fiberboard	0	0	100
Gypsum board	15	15	0
Gypsum fiberboard	15	15	0
Steel	90	90	0
Galvanized steel	90	90	0
Concrete 20 MPa	100	100	0
Concrete 30 MPa	100	100	0
Mineral wool	50	50	0
Extruded polystyrene type IV	50	0	50
Expanded polystyrene type II	50	0	50
Polyisocyanurate (JME 3)	50	0	50
Polyurethane insulation	50	0	50

¹Materials not reused/recycled or incinerated are landfilled

Finally, the net GWP due to biogenic carbon is estimated as the difference in GWP due to carbon sequestration from forest growth and the GWP due to biogenic carbon emissions over a 100 year period (Bright, Cherubini, & Strømman, 2012; Cherubini, Peters, Berntsen, Strømman, & Hertwich, 2011a; Guest, Cherubini, & Strømman, 2012; Levasseur, Lesage, Margni, Deschênes, & Samson, 2010). The Schnute model (Cherubini, Strømman, & Hertwich, 2011b referencing Schnute, 1981) was used to model forest regrowth. The model was parameterized using data from Bright et al. (2012) based on a harvest cycle of 90 years for a boreal forest in Eastern Canada (Athena Sustainable Materials Institute, 2009). The end of the 90 year growth cycle was normalized to the total quantity of wood in the CLT building. Numerical approximation was used to compute the results using a 1 year time-step.

B2 Results

Absolute values for the results presented in the report can be found in Table 2.

Table 2
Absolute values for total life cycle impacts

		Manufacturing	Construction	Maintenance	EOL	EOL - no long-term emissions	Net Biogenic GWP	Additional Forest Sequestration due to CLT Reuse	Fossil Fuel Substitution
Fossil Fuel Consumption (MJ)	CLT, LF	3.2E+06	6.7E+05	0.0E+00	5.6E+05	5.58E+05	0.0E+00	0.0E+00	0.0E+00
	CLT, LF, 50% Reuse	2.5E+06	5.1E+05	0.0E+00	3.5E+05	3.54E+05	0.0E+00	0.0E+00	0.0E+00
	CLT, INC	3.2E+06	6.7E+05	0.0E+00	3.7E+05	3.74E+05	0.0E+00	0.0E+00	-1.1E+07
Global Warming Potential (kg CO ₂ eq)	CLT, LF	2.0E+05	4.5E+04	0.0E+00	3.3E+04	3.26E+04	-1.3E+05	0.0E+00	0.0E+00
	CLT, LF, 50% Reuse	1.6E+05	3.3E+04	0.0E+00	2.1E+04	2.09E+04	-7.2E+04	-7.7E+04	0.0E+00
	CLT, INC	2.0E+05	4.5E+04	0.0E+00	4.9E+04	4.91E+04	-1.1E+05	0.0E+00	-2.5E+05
Acidification Potential (moles of H ⁺ eq)	CLT, LF	8.4E+04	1.4E+04	0.0E+00	5.8E+03	5.76E+03	0.0E+00	0.0E+00	0.0E+00
	CLT, LF, 50% Reuse	6.3E+04	9.8E+03	0.0E+00	3.8E+03	3.77E+03	0.0E+00	0.0E+00	0.0E+00
	CLT, INC	8.4E+04	1.4E+04	0.0E+00	3.0E+04	3.05E+04	0.0E+00	0.0E+00	-7.0E+04
Respiratory Effects (kg PM ₁₀ eq)	CLT, LF	6.3E+02	2.1E+01	0.0E+00	3.1E+01	3.08E+01	0.0E+00	0.0E+00	0.0E+00
	CLT, LF, 50% Reuse	5.8E+02	1.7E+01	0.0E+00	1.9E+01	1.89E+01	0.0E+00	0.0E+00	0.0E+00
	CLT, INC	6.3E+02	2.1E+01	0.0E+00	1.6E+02	1.58E+02	0.0E+00	0.0E+00	-1.1E+02
Eutrophication Potential (kg N eq)	CLT, LF	8.0E+01	1.4E+01	0.0E+00	4.7E+03	4.00E+01	0.0E+00	0.0E+00	0.0E+00
	CLT, LF, 50% Reuse	6.5E+01	1.0E+01	0.0E+00	2.6E+03	2.27E+01	0.0E+00	0.0E+00	0.0E+00
	CLT, INC	8.0E+01	1.4E+01	0.0E+00	5.2E+01	5.20E+01	0.0E+00	0.0E+00	-8.7E+01
Ozone Depletion Potential (kg CFC-11 eq)	CLT, LF	8.1E-04	1.8E-06	0.0E+00	3.2E-03	3.18E-03	0.0E+00	0.0E+00	0.0E+00
	CLT, LF, 50% Reuse	5.7E-04	1.3E-06	0.0E+00	1.9E-03	1.89E-03	0.0E+00	0.0E+00	0.0E+00
	CLT, INC	8.1E-04	1.8E-06	0.0E+00	5.4E-04	5.37E-04	0.0E+00	0.0E+00	-3.3E-04
Smog Potential (kg O ₃ eq)	CLT, LF	1.8E+04	6.9E+03	0.0E+00	2.5E+03	2.51E+03	0.0E+00	0.0E+00	0.0E+00
	CLT, LF, 50% Reuse	1.2E+04	5.0E+03	0.0E+00	1.7E+03	1.67E+03	0.0E+00	0.0E+00	0.0E+00
	CLT, INC	1.8E+04	6.9E+03	0.0E+00	1.9E+04	1.86E+04	0.0E+00	0.0E+00	-4.3E+04

B2.1 Assumptions and Limitations

There are a few limitations to note with respect to these preliminary results which are discussed briefly in this section.

A minor issue in the current model includes missing elements in the life cycle inventory beyond the intended exclusions listed previously. These include balconies, stairs, and hardware connections. While these will be incorporated in the comparative building LCA produced by FPInnovations in 2013, their impact on the overall result is expected to be minor given the scale of these materials compared to the overall building. While material requirements for connections of wood columns and beams were estimated using the column and beam assembly tool in the Impact Estimator, hardware for other assemblies including CLT walls and floors are currently excluded from the CLT building.

For many products, manufacturer specific LCI data was not immediately available. While many types of mineral wool were used in the CLT building, for example, they were all inventoried in the Impact Estimator using the generic mineral wool product in the Impact Estimator database. Due to extensive data requirements in LCA, such practices are common for modeling large systems and allow for order of magnitude considerations for different materials. For designers, product specific data is more useful when choosing between functionally equivalent products.

For products such as concrete and steel where the type and quantity can have an important influence on impact categories such as fossil energy consumption and climate change, it is important to be as precise as possible when inventorying materials. Unfortunately, the Impact Estimator only has 2,900, 4,350 and 8,700 pounds per square inch (psi) concrete as inventory items whereas 3,625 and 5,075 psi concrete was indicated in the structural engineering documents for various footing, and column elements. As a conservative assumption, concrete strength was rounded down to the nearest strength grade present in the AIE which implies a lower quantity of greenhouse gas-intensive cementitious material. All concrete was assumed to have average fly ash content.

Due to the high demolition energy required for glulam, future work should investigate the legitimacy of assuming that glulam can act as a proxy for CLT. The important question is whether or not the massive quantity of CLT can be reused or whether it will be chipped into small pieces similar to glulam beams.

The current work assumes the forest products are harvested from sustainably managed forests, since the Québec CLT producer uses wood certified by the Forest Stewardship Council, such that the net change to forest biomass is constant over the building life cycle. Land-use changes represent an important contributor to greenhouse gas emissions. If the harvesting rate were to exceed the annual growth rate of the forest, or the harvested forest area is used for agriculture or urbanization, the loss in forest stock would represent a net source/sink of carbon that would be important to allocate to forestry activities. As previously elaborated in Section 4, however, the growth rate of U.S. forests continues to outpace the removal rate.

The model for forest re-growth in this analysis takes place at the level of the individual stand of trees required to replace the quantity of wood stored in the building. Analysis at this level has been criticized for lacking perspective of the dynamics that occur at the landscape level where biomass stocks can be constant or increasing while harvesting takes place (Malmshheimer et al., 2011). On the one hand, the view expressed by Malmshheimer et al. fails to consider changes in the total landscape carbon stock due to continued forest operations. Presumably the entire forest stock of the United States would be able to sequester more carbon if left un-harvested up to a point where forest mortality from natural causes is equal to the growth rate. On the other hand, stand level analysis such as that undertaken in this assessment, do not consider risks from forest fire, pests and other natural events. Accounting for these events would increase the GWP benefit of using a wood product like CLT due to the potential for avoiding biogenic carbon emissions that would otherwise be released into the atmosphere from forests such as those devastated by the pine beetle in the Northwestern United States. However, as Malmshheimer et al. (2011) point out, “tracking down wood over long time intervals in an extensive forest inventory still is not feasible because no system of accounting for components of change, analogous to growth, removals, and mortality of standing trees, has been

developed” (p. S38). Given the present dilemma, analysis at the stand level provides a useful first approximation of the GWP benefits from using wood resources.

A final limitation of the current analysis is that changes in albedo of the land due to harvesting are also excluded from the model due to significant uncertainties in quantifying this parameter over the harvest cycle (Bright et al., 2012). Albedo is a measure of how reflective the surface of the earth is. The change in albedo due to glacial melting in the arctic, for example, is a significant concern for global warming because ice reflects significant amounts of solar radiation which provides a cooling effect on the planet. The exclusion of albedo changes is an important limitation as preliminary results suggest that changes in albedo due to forest harvesting in northern latitudes are potentially significant in the first decade after harvesting (Bright et al., 2012; O’Halloran et al., 2012).

B2.2 Sensitivity

This section qualitatively addresses the sensitivity of the results to key parameters. These parameters are related to fossil fuel substitution and the GWP from biogenic carbon.

Fossil Fuel Substitution

For estimating the potential benefits for substituting wood bioenergy for fossil fuels, natural gas was selected as the fossil fuel. While the quality of individual fuel sources varies, natural gas represents a relatively clean fossil fuel with comparatively low life cycle emissions compared to coal and oil. According to Franklin & Associates process in Simapro v7.3.3, Life cycle GHG emissions per unit energy are 18-49% lower per unit of energy for natural gas compared to coal, distillate fuel oil and residual fuel oil. Of the reported emissions in this study, only acidification emissions are higher for natural gas compared to coal and this is due emissions upstream from the combustion process. Compared to oil, respiratory effects, smog, and eutrophication emissions are comparable to residual fuel oil, and 35-40% higher than distillate fuel oil.

The Franklin and Associates (FAL) process was selected for being representative of North American data. Of note, smog emissions and acidification emissions are significantly higher for the FAL process for natural gas combustion in an industrial boiler compared to ecoinvent processes that have been adjusted to a North American electricity mix via the US-EI database (Earthshift, n.d.). At the same time, ozone depleting and eutrophic emissions were lower for the FAL process. However, it should be pointed out that the avoided emissions from these later categories did not register when the results were normalized to per capita, yearly U.S. emissions (refer back to Figure 2).

GWP of Biogenic Carbon

Several parameters affect the GWP of biogenic carbon, including the carbon storage period in the anthroposphere (i.e. building lifetime), the growth rate of trees, and forest management practices (Guest et al., 2012; Cherubini et al., 2011b).

Guest et al. (2012) demonstrate that longer storage periods lead to larger reductions in GWP from biogenic sources as the harvested land is capable of re-absorbing more of the CO₂ extracted for the building products. Quicker growing trees lead to a greater GWP benefit (reduction in GWP) while slower growing trees create less of a GWP benefit trees harvested after the same period of time (Cherubini et al., 2011a and b). Finally, economic pressure, for example, to harvest early in their growth cycle will lower the GWP benefits from using wood products while delayed harvesting will also provide greater GWP benefits (Cherubini et al., 2011a and b).

B3 Discussion

The results presented in this preliminary analysis demonstrate significant benefits from the carbon storage of wood products and the importance that end-of-life management has for overall results. The potential for using wood to produce heat and substituting for natural gas, for example, implies potentially making the CLT system described above—which has excluded various building elements for simplification—a net negative consumer of fossil fuels and a negative emitter of greenhouse gases and acidifying substances.

Comparisons with other studies need to be made with caution to consider the influence of differences in system boundaries, production technologies, energy supply, impact assessment methodologies and more. As discussed in the literature review, Robertson et al. (2012) is the only previous work known to us to consider lifecycle impacts of a CLT building. Their study compares the CLT building to a functionally equivalent alternative. Unfortunately the majority of their results are presented in terms of the relative difference between the two buildings rather than in absolutes, which would have facilitated our interpretation of and comparison with their findings.

B3.1 End-of-life Scenarios

As seen in the results section, end-of-life scenarios have the potential to significantly impact the overall results. When landfilled, for example, a large fraction of carbon continues to be sequestered in the wood while a smaller fraction decomposes over an extended time horizon leading to the release of CO₂ and methane (CH₄) which is 23 times more potent than CO₂ on a mass basis. Greenhouse gas emissions are often assessed over a 100 year time frame. If we assume a service life of 60 years, then wood in landfill slowly releases greenhouse gases starting at year 60. The incineration scenario, which captures the wood's embodied energy as heat in a waste to energy facility, on the other hand, releases all of the wood's stored carbon as CO₂ at year 60. Interestingly, however, the reduction in global warming potential of the CLT building due to carbon sequestration is similar over a 100 year time span for both the landfill scenario and the incineration scenario. While the landfill emissions occur more slowly, the methane release is a more powerful greenhouse gas such that at year 100, the avoided global warming potential due to carbon sequestration is almost the same for landfilling compared to incinerating the wood in a waste to energy facility.

Reusing CLT panels has the potential to further reduce emissions by 12-44%, depending on the impact category, and can further enhance the removal of carbon from the atmosphere by avoiding the harvest of wood from forests which can continue to mature and absorb carbon.

By incinerating the CLT and capturing its embodied energy in a waste to energy facility, it is also possible to avoid the use of fossil energy sources which can potentially lead to significant reductions in fossil fuel consumption, global warming potential, acidification, and smog formation.

B3.2 Carbon Storage

Wood is about half carbon, and wood in long-term service such as buildings represents a significant pool for carbon. Over the long term, this carbon will return to atmosphere and complete the natural carbon cycle; in other words, wood products are not a permanent GHG removal mechanism. But the temporary carbon storage in wood products can be reasonably taken as a carbon credit, depending on time frame and end-of-life assumptions. This reasoning largely stems from the current urgency around climate change, where any delay in carbon emission is helpful in “buying time” to find mitigation solutions to climate change. Over a longer time frame, issues regarding landfill decomposition and potential release of methane become important. If the wood is burned at end of life for energy recovery to replace fossil fuel, the avoided GHG emissions from fossil fuel are included in the assessment.

For traditional wood structural systems, the carbon mass of wood is relatively small compared to the carbon emissions avoided by using wood instead of steel or concrete. Therefore, an important focus in the use of wood to combat climate change is to increase our rate of wood substitution for other materials, with less emphasis on carbon storage. With CLT, the relationship is the opposite: the carbon mass of wood is quite large compared

to the avoided emissions of alternate materials. In this case, there would be an interest in putting a value on that stored carbon, with a motivation to keep the carbon in service for as long as possible, and to capture the energy value of that carbon to replace fossil fuel at the end of service life.

However, there are important considerations before simplistically taking a credit for the carbon stored in wood; these are discussed here briefly but are beyond the scope of this Chapter. The climatic significance of carbon storage in wood products partly depends on the dynamics of the products pool as a whole, i.e., whether the total quantity of stored carbon is increasing, decreasing or is stable. Atmospheric carbon concentration is affected by *changes in the size* of the wood product pool, rather than by the *size* of the pool itself. In the short to medium terms, significant climate benefits can result from increasing the total stock of carbon stored in wood products, by using more wood products or using longer-lived wood products. In the long term, as the stored carbon in the stock of products stabilizes at a higher level, wood products provide a stable pool of carbon as new wood entering the pool is balanced by old wood leaving the pool, with climate benefits accruing from the carbon re-sequestered through tree regrowth and the substitution effects of avoided emissions. As discussed in Sathre O'Connor (2010), some wood substitution studies have covered a relatively short time frame, and have considered carbon storage to be equivalent to avoided emissions, while other studies have considered the long term carbon dynamics of wood products, and show that the substitution effect of avoiding fossil emissions is ultimately much more significant than the carbon stored in wood products.

Guest, Cherubini, & Strømman, (2012), and Levasseur et al. (2012) point out that the benefits of carbon storage are typically unaccounted for in LCA studies as biogenic carbon emissions are treated as having no effect on the climate due to their origin in the biosphere. This simplifying assumption can lead to perverse outcomes when long lived products are being evaluated (Malmshemer et al., 2011). However, there is disagreement about exactly how the benefits from carbon storage should be modeled.

Guest et al. (2012) and Levasseur et al. (2012) both survey common approaches for estimating the benefits from carbon storage in LCA and suggest that a dynamic approach, accounting for the point in time when carbon emissions are sequestered and released, provides a more realistic picture of the benefits of carbon storage from long-lived wood products. These authors both consider the harvesting and regrowth of a particular stand of trees in their respective analysis. While such a narrow spatial focus on a particular stand of trees misses the important dynamics occurring at the landscape level, the lack of current models for comprehensively evaluating forest growth, removals and mortality have already been mentioned (Malmshemer et al., 2011).

Given the complications and lack of agreed upon methodology for modeling forest dynamics in life cycle assessments of wood products, the benefits from carbon sequestration in this study should be interpreted with caution and likely under report the actual benefits due to carbon storage in the anthroposphere. While the methodology used in this study provides a useful starting point for considering the GWP benefits from CLT use, important methodological work is needed to evaluate the effects from changes in albedo in addition to forest dynamics that operate at the landscape level.

APPENDIX C

DETAILS OF THE VOC TESTING

In this Section, we provide preliminary findings regarding emissions to indoor air from cross-laminated timber. This data applies to CLT made from Canadian species.

C1 Objectives and Background

As regulatory and non-governmental organizations (NGOs) address indoor air quality issues, they tend to focus on volatile organic compounds (VOCs), including formaldehyde, as key factors relating to the discomfort reported by people working or living inside “air tight” buildings. The World Health Organisation (WHO) has defined VOCs as organic compounds with boiling points between 122°F (50°C) and 500°F (260°C). Wood composite products are suspected of emitting some of these organic chemicals, namely formaldehyde, alpha- and beta-pinene, carene, camphene, limonene, aldehydes, ketones and acetic acid. Although VOC and formaldehyde emissions from unfinished and finished wood composite panels are well documented, very little if any data exist on multi-ply products (in other words, products with multiple wood layers like cross-laminated timber and plywood).

C2 Procedures and Results

All measures were done in general agreement with the specified standards and protocols. The precision levels were in accordance with the technical requirements.

C2.1 Materials Sampling, Packaging, Transportation and Conditioning

Duplicate test samples of 11 inches x 30 inches (280 mm x 760 mm) (Figure 6) were cut 12 inches (300 mm) from each end of an 18 feet (5.5 meters) long original CLT panel. In order to avoid any potential contamination of samples, latex gloves were worn during the whole sampling and packaging processes; also, before cutting the samples, a towel was used to clean the saw blade. Samples were wrapped with plastic foil with no writing on the sample or on the packaging and stacked in a conditioned room ($23\pm 1^\circ\text{C}$ and $50\pm 5\%$ RH) until ready for testing. All samples were tested within one month after production.

VOC and formaldehyde tests were performed from the same sample and at similar conditions, at a loading ratio of $0.44\text{ m}^2/\text{m}^3$ with all edges sealed with a non-emitting aluminum tape material leaving two flat surfaces exposed.



Figure 6

Picture showing a prepared sample with edges sealed ready to be put in the chamber

C2.2 **Method**

A constant and adjustable airflow, conditioned for relative humidity, was fed through small environmental chamber at a rate which corresponds to an air change rate of one per hour. The VOC sampling procedures excluding formaldehyde were similar to those described in the ASTM D5116-97 and ANSI/BIFMA M 7.1-2007 standards. The chamber was constructed in stainless steel and the interior surfaces were electropolished to minimize chemical adsorption. The chamber was equipped with suitable accessories such as inlet and outlet ports for airflow and an inlet port for temperature/humidity measurements. The air sampling was accomplished from the airflow outlet port. The small chamber was placed inside a controlled temperature room. The humidity of the air flowing through the chamber was controlled by adding deionized water to the air stream, as shown in Figure 7.



Figure 7

A general view of the 1 m³ environmental chamber used for emissions testing

The collection of VOCs on an appropriate adsorbent medium is required to avoid overloading of the analytical equipment. In order to maintain integrity of the airflow in the small chamber, the sampling flow rate was 100 ml/min for a sampling period of 120 minutes for VOC sampling, while the formaldehyde sampling rate was set at 1.5 L/min for 120 minutes for a total of 180 L.

Tenax cartridges were used to sample VOCs and derivatized DNPH cartridges were used to sample low molecular weight formaldehyde and acetaldehyde. Higher molecular weight aldehydes are sampled with tenax tubes used for sampling VOCs. VOC sample tubes were analyzed by desorbing the VOCs through a thermal desorption system and then injected into a gas chromatograph equipped with a mass detector (GC/MS). Aldehyde tubes were desorbed with acetonitrile solvent and injected into a high performance liquid chromatograph (HPLC). Table 3 describes the small chamber operating conditions, while Table 4 summarizes the GC/MS and the HPLC operating conditions.

Table 3

Small chamber operating conditions

Parameter	Symbol	Unit	Value
Chamber volume	V	m ³	1.0
Loading ratio	Lr	m ² /m ⁻³	0.44
Temperature	T	°C	23±1
Relative humidity	RH	%	50±5
Air exchange rate	ACH	h ⁻¹	1.0
Sampling time		Hours	24

Table 4

TDU/GC/MS and HPLC operating conditions

Thermal Desorption Unit (Type ACM 900)	
Desorption temperature	250°C
Desorption time	6 min
Cryofocus Unit Model 951	
Cooling temperature	-50°C
Time	4 min
Desorption temperature	150°C
Desorption time	15 min
GC/MS: Agilent 5890 Series II Plus	
Carrier gas	He, 43.2 cm/sec
Column J&W Scientific DB-1	30 m x 0.25 mm ID, 1.0 µm
Injection type	Split: 22:1 at 230°C
Oven heating program	10 min at 70°C
	8°C/min at 200°C
	3 min at 200°C
Detector	MSD, transfer line temp. 280°C
HPLC Type: Agilent Series 1100	
Column Zorbax Eclipse XDB-C18	Analytical 4.6 mm x 150 mm, 5 microns
Phase mobile	70% ACN:30% water
Flow rate	1.0 mL/min
Total injected volume	25 µL
Column temperature	20°C
Detector	DAD 360 nm

C2.3 Quantification of Formaldehyde

Formaldehyde emissions were quantified according to the modified National Institute of Occupational Safety and Health (NIOSH) Test Method 3500. The method can be summarized as follows: 4 mL of the scrubber's content and 0.1 mL of 1.0% chromotropic acid are poured in a 50 mL Pyrex® test tube with a screw top cap. Six mL of concentrated sulphuric acid (96%) are slowly added and agitated for 2 minutes, then heated for 30 minutes at 100°C and cooled and tested in triplicate. Solution absorbencies were read through a UV-visible spectrophotometer set at 580 nm. Distilled water was run as a blank, and with a formaldehyde solution calibration curve, absorbency readings are then converted into µg/mL of formaldehyde. When the condensate samples were too concentrated to yield absorbencies in the linear range of the calibration curve, aliquots of these samples were diluted with distilled water to a level within the linear range of the calibration curve. The concentration obtained from this dilution was back-calculated to the original concentration and presented as micrograms of formaldehyde per liter, which is then converted into parts per million (ppm) and in emission factors as mg/m³.h.

C2.4 Quantification of the TVOC

VOC measurements from panel samples were conducted in accordance with the ASTM D5116-97 guide and described in great detail in Barry et al. (1999). A Thermal Desorber/Gas Chromatograph/Mass Spectrometer (TDU/GC/MS) system was utilized to desorb and quantify the total volatile organic compounds (TVOC). A “cryo-trap” device was connected to the GC column in order to “cryofocus” the thermally desorbed chemicals prior to their injection into the GC. The GC oven was programmed for 10 minutes at 70°C, followed by ramping up the heat to 200°C at a rate of 8°C/min, and held for 10 minutes. The mass scan ranged from 29 to 550 atomic mass units (amu). Quantitative evaluation was achieved by comparing the chromatogram peak area of each compound to the corresponding peak area of a standard.

C3 Results and Discussions

Tables 5 and 6 summarize the emitted VOCs including formaldehyde, acetaldehyde and acetone expressed in micrograms per cubic meter (µg/m³). To better illustrate the variation of emissions as a function of the product types, the results are graphically shown in Figures 8 and 9; the same scale was applied to both figures for an easy comparison. As one can see from these figures, no correlation exists between emission results and the number of glue lines involved in each product category or product thicknesses. Also, most of the emitted VOCs, if we except formaldehyde and acetaldehyde, are those usually emitted from softwood species, indicating that only formaldehyde and acetaldehyde could really be associated with the products manufacturing processes. Figure 10 compares the total volatile organic compounds (TVOC), excluding formaldehyde, acetaldehyde and acetone, emitted from the five different products tested; as for individual VOCs, no correlation can be established between TVOCs, the thickness or the number of plies in cross-laminated lumber products.

Table 5

Samples 24-hour individual VOCs (iVOCs), TVOC as toluene, between n-C6 and n-C16 including formaldehyde ($\mu\text{g}/\text{m}^3$)

VOCs	CAS #	114-3S			95-3S		
		A	B	Mean	A	B	Mean
Acetic acid	64-19-7	N/A*	6.7	6.7	2.4	<2.0	2.4
Hexanal	66-25-1	5.0	9.4	7.2	2.9	4.3	3.6
Alpha-pinene	7785-70-8	134.7	218.1	176.4	44.7	26.2	35.4
Beta-pinene	18172-67-3	14.6	32.7	23.6	9.9	7.8	8.8
Alpha-phellandrene	99-83-2	4.7	N/A*	4.7	2.7	3.1	2.9
3-carene	13466-78-9	19.1	51.0	35.0	3.6	8.3	6.0
Para-cymene	99--87--6	78.6	5.9	42.3	43.0	45.4	44.2
Limonene	95327-98-3	7.6	11.7	9.6	3.3	2.8	3.0
Unknown	- - -	- - -	- - -	- - -	4.9	5.3	- - -
TVOC _{alpha-pinene}	- - -	264.3	335.5	299.9	117.3	103.2	110.2
Formaldehyde	50-00-0	16.6	21.5	19.1	9.6	8.7	9.1
Acetaldehyde	75-07-0	70.1	149.7	109.9	107.3	51.0	79.1
Acetone	67-64-1	33.2	65.3	49.2	45.7	24.4	35.0

* Compound which $\mu\text{g}/\text{m}^3$ concentration is below the quantification limit allowed by ANSI BIFMA.

Table 6

Samples 24-hour individual VOCs (iVOCs), TVOC as toluene, between n-C6 and n-C16 including formaldehyde ($\mu\text{g}/\text{m}^3$)

VOCs	CAS #	190-5S			152-5S			210-7S		
		A	B	Mean	A	B	Mean	A	B	Mean
Acetic acid	64-19-7	3.8	3.9	3.9	2.8	<2.0	2.8	2.8	2.1	2.4
Hexanal	66-25-1	4.4	3.8	4.1	3.1	2.6	2.8	4.4	2.1	3.2
Alpha-pinene	7785-70-8	67.9	143.5	105.7	98.6	20.5	59.6	64.9	35.2	50.0
Beta-pinene	18172-67-3	14.0	8.5	11.3	7.3	4.5	5.9	7.9	6.7	7.3
Alpha-phellandrene	99-83-2	2.7	<2.0	2.7	<2.0	2.3	2.3	<2.0	<2.0	<2.0
3-carene	13466-78-9	9.3	9.6	9.5	36.2	5.9	21.1	8.3	5.5	6.9
Para-cymene	99--87--6	36.4	<2.0	36.4	2.8	32.5	17.7	3.0	13.6	8.3
Limonene	95327-98-3	10.7	4.6	7.7	3.4	2.3	2.8	4.2	2.7	3.5
Unknown	---	---	---	---	---	2.4	---	---	---	---
TVOC _{alpha-pinene}	---	149.2	174.1	161.7	154.3	72.9	113.6	95.4	68.0	81.7
Formaldehyde	50-00-0	9.4	8.8	9.1	5.7	6.5	6.1	6.0	5.4	5.7
Acetaldehyde	75-07-0	71.5	68.5	70.0	72.6	74.4	73.5	73.6	59.4	66.5
Acetone	67-64-1	22.3	27.6	24.9	31.2	29.8	30.5	21.5	16.1	18.8

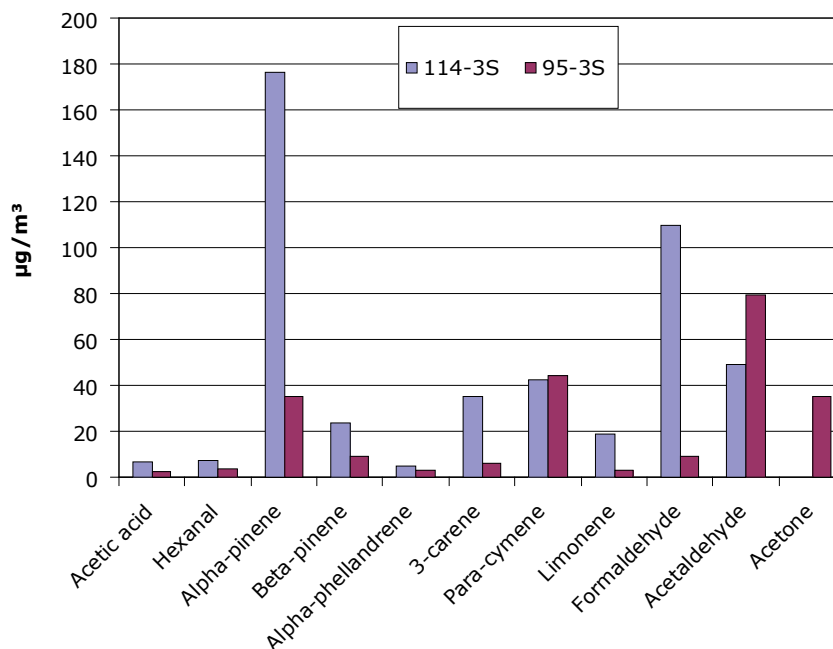

Figure 8

24-hour VOCs including formaldehyde and acetaldehyde off gassing as a function of samples types

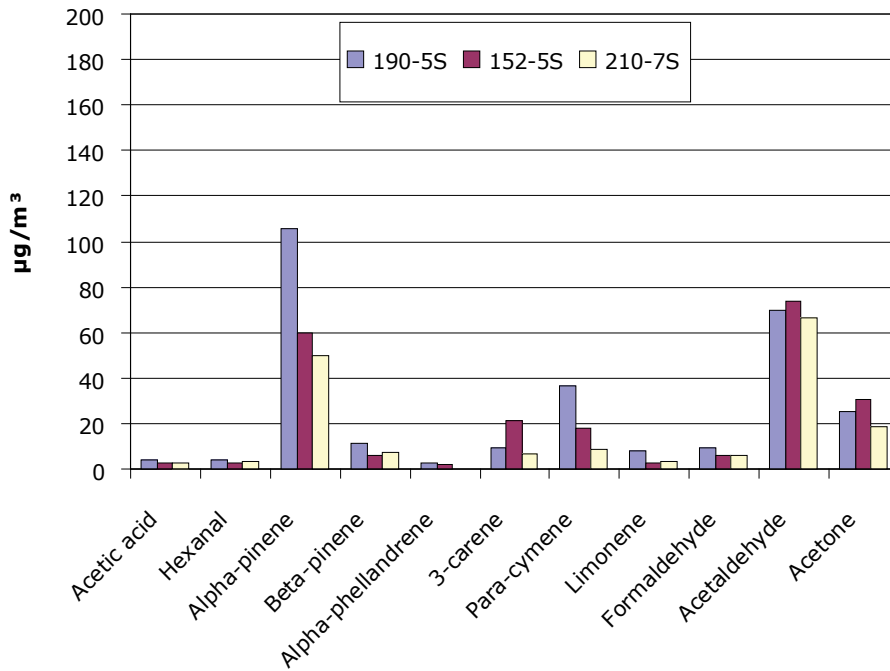

Figure 9
24-hour VOCs including formaldehyde and acetaldehyde off gassing as a function of samples types

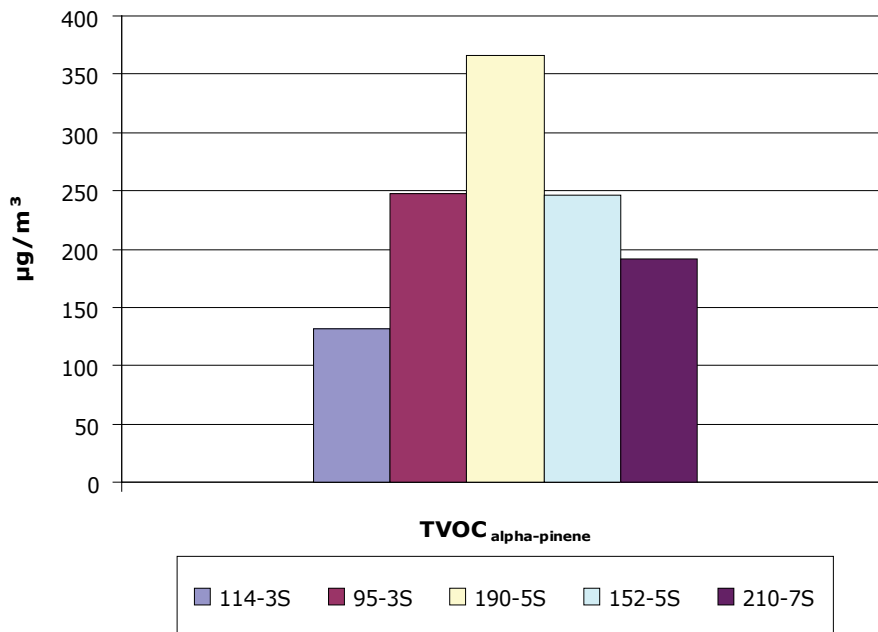

Figure 10
24-hour TVOC emissions as a function of cross-laminated products

Examples of emission labeling systems in Europe in terms of VOCs, including formaldehyde and acetaldehyde, are summarized in Table 7 in order to put the tested cross-laminated timber products emissions in context and to allow manufacturers interested in labeling their products for overseas market. Because few individual VOC emission limits are expressed in emission factors (EF), i.e., mass of the emitted VOC per square meter of the product tested per hour ($\mu\text{g}/\text{m}^2\cdot\text{h}$), the cross-laminated timber products emissions results have been converted into emission rates and summarized in Table 8 and Table 9. Results of emission factors reported in Tables 8 and 9 were calculated from the 24-hour sampling time compared to the voluntary limits listed in Table 7 calculated after 3, 10 or 28 days of samples exposure in the environmental chamber. One should expect that the cross-laminated timber emission factors would be much lower if their exposure is prolonged for an additional 3, 10 or 28 days and meet the most stringent Blue Angel or GUT (Germany) TVOC emission limits not met after 24 hours of exposure.

To convert measured individual VOC emissions or total VOC, both expressed in $\mu\text{g}/\text{m}^3$, in the environmental chamber into emission factors, knowing the flow rate $Q(\text{m}^3/\text{h})$ and the total exposed surface area of the sample $A(\text{m}^2)$, one can use the following equation:

$$\text{EF} (\mu\text{g}/\text{m}^2\cdot\text{h}) = C(\mu\text{g}/\text{m}^3) * Q(\text{m}^3/\text{h})/A(\text{m}^2)$$

Table 7

Example of some European emission labeling systems

Label	Origin	TVOC	Aldehydes Additional Requirements
AgBB	Germany	10 mg/m^3 (3 days) 1 mg/m^3 (28 days)	DIBt: 120 $\mu\text{g}/\text{m}^3$ (28 days)
CESAT	France	5000 $\mu\text{g}/\text{m}^3$ (3 days) 200 $\mu\text{g}/\text{m}^3$ (28 days)	Formaldehyde: 10 $\mu\text{g}/\text{m}^3$ (28 days)
M1	Finland	200 $\mu\text{g}/\text{m}^3$ (28 days)	Formaldehyde: 50 $\mu\text{g}/\text{m}^3$ (28 days)
LAQI Scheme	Portugal	5000 $\mu\text{g}/\text{m}^2\cdot\text{h}$ (3 days) 200 $\mu\text{g}/\text{m}^2\cdot\text{h}$ (28 days)	Formaldehyde: 10 $\mu\text{g}/\text{m}^3$ (28 days)
Natureplus	Germany	5000 $\mu\text{g}/\text{m}^2\cdot\text{h}$ (3 days) 200 $\mu\text{g}/\text{m}^2\cdot\text{h}$ (28 days)	Formaldehyde: 36 $\mu\text{g}/\text{m}^3$ after 3 days or 28 days
Blue Angel	Germany	200 or 300 $\mu\text{g}/\text{m}^3$ (28 days)	Formaldehyde: 60 $\mu\text{g}/\text{m}^3$ (28 days)
Austrian Ecolabel	Austria	1.2 mg/m^3 (3 days) 0.36 mg/m^3 (28 days)	Hexanal: 70 $\mu\text{g}/\text{m}^2\cdot\text{h}$ (28 days), nonanal: 20 $\mu\text{g}/\text{m}^2\cdot\text{h}$ after 3 days
GUT	Germany	300 $\mu\text{g}/\text{m}^3$ (3 days)	Formaldehyde: 10 $\mu\text{g}/\text{m}^3$ after 28 days
EMICODE EC1 such as adhesives	Germany	500 $\mu\text{g}/\text{m}^3$ (10 days)	Formaldehyde and acetaldehyde: 50 $\mu\text{g}/\text{m}^3$ each after 24 hours
Scandinavian Trade Standards	Sweden	Declaration of TVOC after 28 days and 26 weeks no limits specified	Formaldehyde and acetaldehyde according to WHO

Table 8

Samples 24-hour iVOCs, TVOC as toluene, between n-C6 and n-C16 emission factors including formaldehyde ($\mu\text{g}/\text{m}^2\cdot\text{h}$)¹⁴

VOCs	CAS #	114-3S			95-3S		
		A	B	Mean	A	B	Mean
Acetic acid	64-19-7	<2.0	2.9	2.9	5.1	N/A*	5.1
Hexanal	66-25-1	2.2	4.1	3.2	6.3	10.1	8.2
Alpha-pinene	7785-70-8	59.0	95.5	77.2	96.6	61.5	79.1
Beta-pinene	18172-67-3	6.4	14.3	10.3	21.3	18.3	19.8
Alpha-phellandrene	99-83-2	2.1	<2.0	2.1	5.9	7.3	6.6
3-carene	13466-78-9	8.3	22.3	15.3	7.7	19.6	13.7
Para-cymene	99--87--6	34.4	2.6	18.5	92.9	106.6	99.8
Limonene	95327-98-3	3.3	5.1	4.2	7.1	6.5	6.8
Unknown	- - -	- - -	- - -	- - -	10.5	12.4	- - -
TVOC _{alpha-pinene}	- - -	115.7	146.9	131.3	253.5	242.3	247.9
Formaldehyde	50-00-0	8.4	10.9	9.7	16.2	18.7	17.5
Acetaldehyde	75-07-0	35.9	76.5	56.2	182.0	109.6	145.8
Acetone	67-64-1	16.7	32.9	24.8	77.5	52.6	65.1

* Compound which $\mu\text{g}/\text{m}^3$ concentration is below the quantification limit allowed by ANSI BIFMA.

¹⁴**1 $\mu\text{g}/\text{m}^2\cdot\text{h}$ corresponds to $1.55 \cdot 10^3 \mu\text{g}/\text{m}^3\cdot\text{h}$

Table 9

Samples 24-hour iVOCs, TVOC as toluene, between n-C6 and n-C16 emission factors including formaldehyde ($\mu\text{g}/\text{m}^2\cdot\text{h}$)

VOCs	CAS #	190-5S			152-5S			210-7S		
		A	B	Mean	A	B	Mean	A	B	Mean
Acetic acid	64-19-7	8.7	9.0	8.8	5.9	N/A*	5.9	6.4	5.1	5.8
Hexanal	66-25-1	9.9	8.7	9.3	6.6	5.9	6.2	10.3	4.9	7.6
Alpha-pinene	7785-70-8	153.1	326.6	239.9	210.1	46.2	128.1	151.9	83.1	117.5
Beta-pinene	18172-67-3	31.6	19.5	25.5	15.6	10.1	12.9	18.6	15.8	17.2
Alpha-phellandrene	99-83-2	6.2	N/A*	6.2	N/A*	5.2	5.2	N/A*	N/A*	N/A*
3-carene	13466-78-9	21.0	21.9	21.4	77.1	13.4	45.2	19.4	13.1	16.2
Para-cymene	99--87--6	82.1	N/A*	82.1	6.0	73.5	39.8	7.1	32.2	19.6
Limonene	95327-98-3	24.1	10.5	17.3	7.2	5.3	6.2	9.9	6.4	8.1
Unknown	---	---	---		---	5.3	2.7	---	---	
TVOC _{alpha-pinene}	---	336.7	396.2	366.4	328.5	164.7	246.6	223.5	160.6	192.0
Formaldehyde	50-00-0	18.9	20.1	19.5	10.6	12.3	11.5	14.1	12.8	13.5
Acetaldehyde	75-07-0	144.2	155.9	150.0	132.9	139.5	136.2	172.3	140.2	156.3
Acetone	67-64-1	45.0	62.9	54.0	58.0	56.6	57.3	50.3	38.1	44.2

* Compound which $\mu\text{g}/\text{m}^3$ concentration is below the quantification limit allowed by ANSI BIFMA.

On the other hand, the levels of the emitted formaldehyde converted into parts per billion (ppb) are summarized in Table 10 and, as one can see, emissions are just in the order of few parts per billion. Compared to the European E1 wood products formaldehyde emission limit of 0.1 ppm (100 ppb), all five cross-laminated timber tested products had emissions 6 to 20 times lower than the E1 required emission limits, indicating that these products could be installed in any European country embracing the E1 grade. When compared to the voluntary formaldehyde emission limits for labeling (Table 7), three of the five samples meet the formaldehyde emission limits and two samples encoded as 114-3S and 190-5S would need to be tested for longer periods of time ranging from two to three days in order to be qualified for the most stringent GUT (Germany) labeling system, for which the formaldehyde emission limit is set at $10\mu\text{g}/\text{m}^3$ after three days of sample exposure in the controlled environmental chamber.

Table 10

24-hour formaldehyde emissions as a function of product types

Formaldehyde	CAS #	114-3S		95-3S		190-5S		152-5S		210-7S	
		µg/m ³	ppb	µg/m ³	ppb	µg/m ³	ppb	µg/m ³	ppb	µg/m ³	ppb
	50-00-0	19.1	15	9.1	7	19.5	16	6.1	5	5.7	5

The new formaldehyde emission limits set forth by the Californian government known under the acronym of CARB Phase I and Phase II for wood composite products particleboard, MDF, thin MDF and hardwood plywood (HWPW) with composite core (HWPW-CC) or veneer core (HWPW-VC) have been in effect since July 1st, 2012. The final formaldehyde emission limits are: 0.13 ppm (130 ppb) for thin MDF, 0.11 ppm for normal MDF, 0.09 ppm for particleboard and 0.05 ppm for both hardwood plywood (HWPW) with veneer core (VC) or composite core (CC). By comparing these limits to those from the cross-laminated timber products shown in Table 10, one can conclude that the cross-laminated timber products easily meet the most stringent CARB limits of 50 parts per billion (ppb).

C4 Conclusions and Recommendations

Five CLT products were tested for their volatile organic compounds (VOCs), including formaldehyde and acetaldehyde emissions, in order to assist architects, engineers and builders to better select construction materials with low-emitting characteristics having less impact on indoor air quality. The tested laminated products had different thicknesses and different number of glue lines. Emissions were collected after 24 hours of samples exposure in the environmental chamber.

Results did not show any correlation between individual VOCs (iVOCs), including formaldehyde and acetaldehyde or TVOC and the thickness of the cross-laminated timber panel or the number of glue lines. All five products showed very low level of iVOC and TVOC emissions; most of the detected VOCs consisted of terpene compounds originating from the soft wood material itself used to in the cross-laminated timber products.

In terms of evaluating the products impact on indoor air quality, one can easily conclude that it would be negligible if any. The five cross-laminated timber products TVOCs and formaldehyde 24-hour results were generally lower than those set forth by some European emission labeling systems even if those limits were emissions measured after 3, 10 or 28 days of sample exposure. Also, the European E1 grade for wood products formaldehyde emissions set at 0.1 parts per million (ppm) or 100 parts per billion (ppb) is 6 to 20 times higher than those measured from the cross-laminated timber products.

Comparing the limits enforced by CARB, one can conclude that the CLT products tested in this study would easily meet the most stringent CARB limit of 50 ppb. However, we recommend, when architects, builders and engineers are using CLT products other than those tested here, to validate that emissions still meet the requirements because emissions are species characteristics.

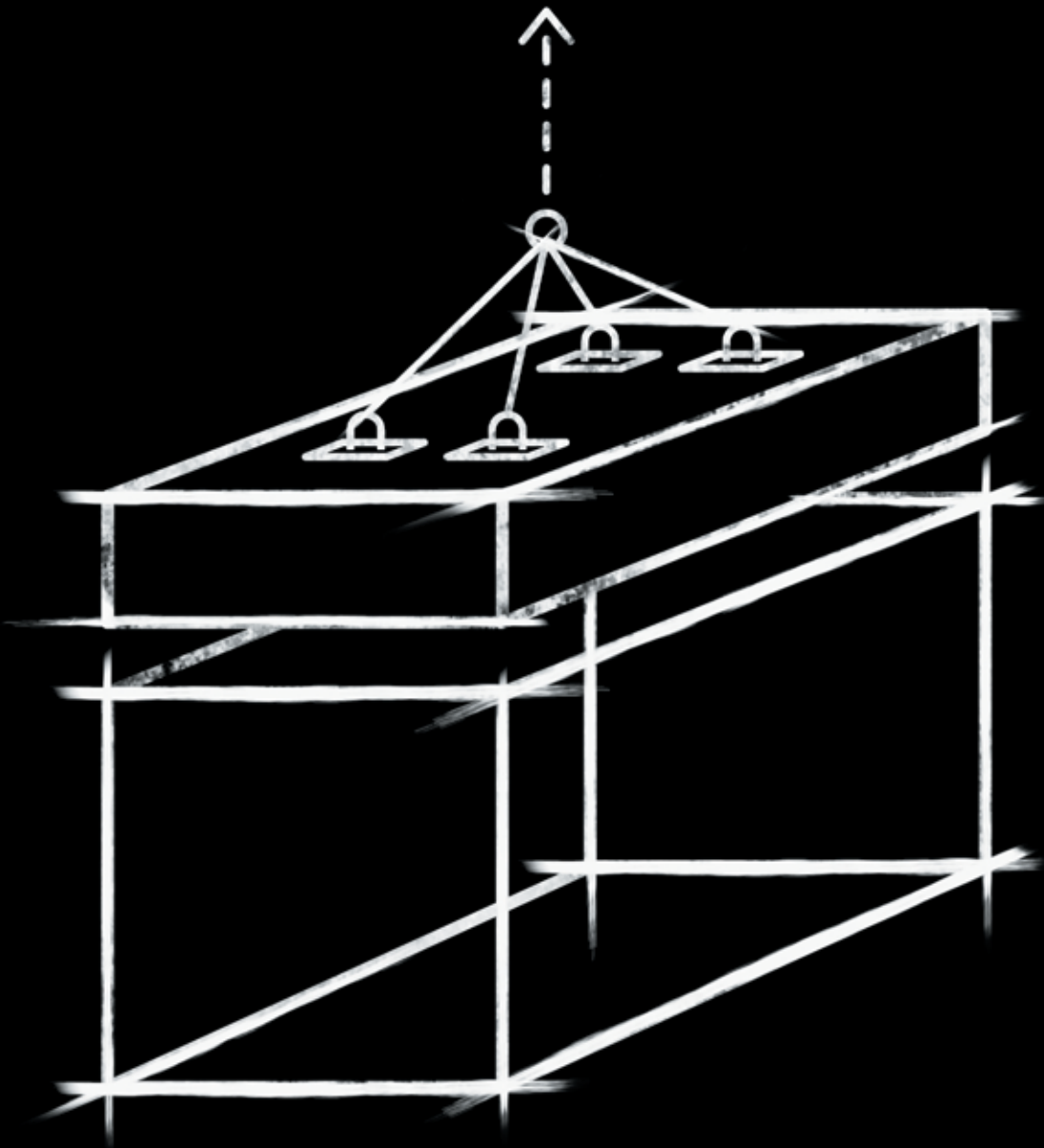

Lifting

Lifting and handling of
cross-laminated timber elements

CHAPTER 12

Authors

Sylvain Gagnon, Eng., FPIInnovations
Sam Francis, M.En.Sc., American Wood Council
Bruce M. Stockton, Stockton Solutions

Peer Reviewers

Edward Keith, M.S., P.E., APA
Tom Williamson, P.E., T. Williamson Timber Engineering LLC

ACKNOWLEDGEMENTS

The U.S. Edition of the CLT Handbook: *cross-laminated timber* combines the work and knowledge of American, Canadian and European specialists. The handbook is based on the original Canadian Edition of the CLT Handbook: *cross-laminated timber*, that was developed using a series of reports initially prepared by FPInnovations and collaborators to support the introduction of CLT in the North American market. A multi-disciplinary team revised, updated and implemented their know-how and technologies to adapt this document to U.S. standards.

The publication of this handbook was made possible with the special collaboration of the following partners:



The editing partners would also like to express their special thanks to Binational Softwood Lumber Council, Forestry Innovation Investment (FII), Nordic Engineered Wood, Structurlam, and CLT Canada for their financial contribution to studies in support of the introduction of cross-laminated timber products in the United States of America.



© 2013 FPInnovations and Binational Softwood Lumber Council. All rights reserved.

The U.S. Edition of the CLT Handbook: *cross-laminated timber* can be electronically downloaded without charge from the website www.masstimber.com. Additional information can be obtained by visiting the websites of FPInnovations, USFPL, American Wood Council (AWC), APA and U.S. WoodWorks. Hard copies can be obtained through AWC (www.awc.org).

No part of this published Work may be reproduced, published, or transmitted for commercial purposes, in any form or by any means, electronic, mechanical, photocopying, recording or otherwise, whether or not in translated form, without the prior written permission of FPInnovations and Binational Softwood Lumber Council.

The information contained in this Work represents current research results and technical information made available from many sources, including researchers, manufacturers, and design professionals. The information has been reviewed by professionals in wood design including professors, design engineers and architects, and wood product manufacturers. While every reasonable effort has been made to insure the accuracy of the information presented, and special effort has been made to assure that the information reflects the state-of-the-art, none of the above-mentioned parties make any warranty, expressed or implied, or assume any legal liability or responsibility for the use, application of, and/or reference to opinions, findings, conclusions, or recommendations included in this published work, nor assume any responsibility for the accuracy or completeness of the information or its fitness for any particular purpose.

This published Work is designed to provide accurate, authoritative information but is not intended to provide professional advice. It is the responsibility of users to exercise professional knowledge and judgment in the use of the information.

ABSTRACT

Cross-laminated timber (CLT) construction is a relatively new process. There is therefore very little specific technical documentation for the erection of structures designed and built with CLT panels. Current CLT manufacturers provide recommendations on lifting systems for the installation of prefabricated wood assemblies. However, technical documents currently available mostly come from Europe or Canada and may appear incomplete to some design professionals and builders/contractors in the United States.

This Chapter presents a variety of lifting systems that can be used in the construction of structures using CLT panels. We discuss the basic theory required or suggested for proper lifting techniques. In addition, we introduce various tools and accessories that are frequently required for CLT construction, as well as good building practices to help contractors build safe and efficient CLT panel structures. Finally, we discuss issues related to the transportation of CLT assemblies from factory to building site. Regulatory aspects of transportation are also discussed.

It is important to note that the lifting, handling, and installation of CLT panels involve multiple interest groups including design professionals, contractors/erectors and CLT manufacturers, each with different areas of interest and expertise. Therefore, the information presented in this Chapter is broad in scope and may or may not be relevant to each interest group.

TABLE OF CONTENTS

Acknowledgements	ii
Abstract	iii
List of Tables	vi
List of Figures	vi
1 Introduction	1
1.1 Parallel with Precast Concrete Industry	1
1.2 Lifting and Handling of CLT Elements	2
2 Slinging and Fastening Systems for the Lifting and Handling of CLT Panels	9
2.1 Contact Lifting Systems	9
2.1.1 Single Lifting Loop with Threaded Sleeve Used with Socket Steel Tube Welded onto Flat Steel Plate	10
2.1.2 Articulated Lifting Loop with Threaded Sleeve Used with Socket Steel Tube Welded onto Flat Steel Plate	11
2.1.3 Articulated Lifting Hook with Threaded Sleeve Used with Socket Steel Tube Welded onto Flat Steel Plate	11
2.1.4 Threaded Eyelet Bolt Used with Socket Steel Tube Welded onto Flat Steel Plate	12
2.1.5 Threaded Eyelet Bolt Used with Plate and Nut	13
2.1.6 Eyelet Used with Bolt or Threaded Sleeve and Steel Plate	14
2.1.7 Threaded Eyelet Bolt, Threaded Socket, Threaded Bolt and Steel Plate	15
2.1.8 Threaded Eyelet Bolt, Threaded Socket and Steel Round Rod	15
2.1.9 Soft Lifting Sling Used with Support	16
2.1.10 Soft Lifting Sling Without Support for Vertical Elements	17
2.1.11 Soft Lifting Sling Without Support for Horizontal Elements	19
2.2 Screw Hoist Systems	20
2.2.1 Screwed Anchor	20
2.2.2 Screwed Plate and Lifting Ring	22
2.2.3 Double-threaded Socket with Eyelet Bolt or Lifting Loop with Threaded Sleeve	23
2.2.4 Innovative Lifting System with Wood Screws and Eyelet Bolt	24

2.3	Integrated Lifting Systems	25
2.3.1	Inserted Rod with Soft Sling	25
2.3.2	Inserted Rod with Lifting Hook	28
3	General Principles for Lifting and Handling CLT Elements	29
3.1	Lifting Station and Devices	29
3.2	Determining the Weight and Center of Gravity of CLT Elements	30
3.3	Dynamic Acceleration Factors	31
3.3.1	Lifting System Used	31
3.3.2	Other Effects to Consider	32
3.4	Asymmetrical Distribution of Load According to Center of Gravity	32
3.5	Determining Forces According to Lifting Angles	34
3.6	Determining Load Distribution According to the Number of Effective Anchors (Suspension in Several Effective Points « N »)	35
3.7	Calculation of Forces Resulting from Lifting with Anchors	44
4	Other Accessories and Materials	45
4.1	Fire-resistant “Rope” (Fibrous Caulking Material) and Joint Sealing Tapes	45
4.2	Adjustable Steel Shoring	48
4.3	Beam Grip with Ratchet and Hooks	50
4.4	Beam Grip with Ratchet and Screw Plate	51
4.5	Manual Winch with Cables or Slings	52
4.6	Steel Shims and Cement-based Grout with no Shrinkage	54
5	Transportation of CLT Elements	55
5.1	Standard Weights and Dimension Regulations	55
5.1.1	Dimension Limits	56
5.1.2	Weight Limits	58
5.1.3	Other Canadian Legal Configurations	58
5.2	Oversize and Overweight Permits	60
5.3	Construction Site Limitations and Considerations	60
5.4	Other Transport Considerations	61
6	Positioning of Materials on Construction Site and Protection Against Weather	62
6.1	Positioning of Materials on Construction Site	62
6.2	Construction Load on Frame	65
6.3	Temporary Protection During Construction	65
7	References	69

List of Tables

- Table 1* Dynamic acceleration factors (f) 31
- Table 2* Coefficient of lifting angle (β) 34
- Table 3* Maximum payloads by jurisdiction for 5- and 6-axle tractor/semi-trailer combinations (t) 58

List of Figures

- Figure 1* Lifting and handling of precast concrete elements 2
- Figure 2* Lifting and handling of CLT elements by cableway 3
- Figure 3* Lifting and handling of CLT elements by helicopter 4
- Figure 4* Lifting and handling of relatively light CLT elements, in Norway 5
- Figure 5* Lifting and handling of CLT wall elements, in Belgium 5
- Figure 6* Lifting and handling of CLT elements, in Canada 6
- Figure 7* Lifting and handling of CLT elements in an hybrid structure, in the United States 6
- Figure 8* Lifting and handling of CLT elements, in Canada 7
- Figure 9* Lifting and handling of CLT elements, in Sweden 7
- Figure 10* Lifting and handling of CLT elements, in Norway 8
- Figure 11* Single lifting loop with threaded sleeve used with socket steel tube welded onto flat steel plate 10
- Figure 12* Articulated lifting loop with threaded sleeve used with socket steel tube welded onto flat steel plate 11
- Figure 13* Articulated lifting hook with threaded sleeve used with socket steel tube welded onto flat steel plate 11
- Figure 14* Threaded eyelet bolt (with base) used with socket steel tube welded onto flat steel plate 12
- Figure 15* Correct use of threaded eyelet bolt (with and without eyelet base) 12
- Figure 16* Threaded eyelet bolt used with steel plate and nut 13
- Figure 17* Eyelet used with threaded bolt or sleeve and steel plate 14
- Figure 18* Threaded eyelet bolt, threaded socket, threaded bolt or sleeve and steel plate 15

- Figure 19* Threaded eyelet bolt, threaded socket and steel round rod 15
- Figure 20* Single lifting sling used with support 16
- Figure 21* Lifting sling without support (with hole) 17-18
- Figure 22* Lifting sling without support (without hole) 19
- Figure 23* Lifting sling without support (with holes) 19
- Figure 24* Lifting system with self-tapping screw 20
- Figure 25* Screwed anchor 21
- Figure 26* Screwed plate and lifting ring 22
- Figure 27* Double-threaded socket with eyelet bolt or lifting loop with threaded sleeve 23
- Figure 28* Innovative lifting system with wood screw (with or without recess) 24
- Figure 29* Inserted rod with soft sling 25-26-27
- Figure 30* Inserted rod with lifting hook 28
- Figure 31* Calculating the weight of a CLT slab 31
- Figure 32* Element lifted with a spreader system 33
- Figure 33* CLT wall lifted with two slings symmetrically positioned – good and bad practices 36
- Figure 34* CLT wall lifted with two slings symmetrically positioned with F_{tot} in line with the center of gravity ($N = 2$) 37
- Figure 35* CLT wall lifted with two slings asymmetrically positioned with F_{tot} in line with the center of gravity, with single spreader ($N = 2$) 38
- Figure 36* CLT slab lifted with four slings symmetrically positioned to the center of gravity, without spreader and without compensation system ($N = 2$) 39
- Figure 37* CLT slab lifted with four slings symmetrically positioned to the center of gravity, with compensation system ($N = 4$) 40
- Figure 38* CLT slab lifted with four slings symmetrically positioned to the center of gravity, with single spreader ($N = 4$) 41
- Figure 39* CLT slab lifted with four slings symmetrically positioned to the center of gravity, with single spreader, with three fixed spreaders ($N = 2$) 42
- Figure 40* CLT slab lifted with four slings symmetrically positioned to the center of gravity, with single spreader, with three free spreaders ($N = 4$) 43

- Figure 41* Sealing joint between floor, wall, and connectors 46
- Figure 42* Joint between floor and wall with semi-rigid membrane 47
- Figure 43* Joint between two floor slabs with flexible membrane 47
- Figure 44* Adjustable shoring for walls 48-49
- Figure 45* Beam grip with ratchet and hooks 50
- Figure 46* Beam grip with ratchet and screw plate 51
- Figure 47* Manual winch used with soft slings 52-53
- Figure 48* Junction between concrete foundation and CLT walls with steel winch and cement-based grout without shrinkage 54
- Figure 49* Available load space on a flatbed semi-trailer 56
- Figure 50* Flatbed semi-trailer 57
- Figure 51* Drop deck semi-trailer 57
- Figure 52* Double drop deck semi-trailer 57
- Figure 53* Super B-train flat deck combination 59
- Figure 54* U.S. motor carrier flatbed 59
- Figure 55* Storage on construction site – individually wrapped bundles stacked on lumber skids 63
- Figure 56* Truck platform left on construction site – it will be recovered on the next trip 64
- Figure 57* CLT slabs temporarily stored on a floor 65
- Figure 58* Use of a temporary tarpaulin 66
- Figure 59* Use of a water-proof tarpaulin outside scaffoldings – Germany 67
- Figure 60* Use of an adjustable tent – Sweden 68

1

INTRODUCTION

This Chapter presents a variety of lifting systems that can be used in the construction of structures made of cross-laminated timber (CLT) panels. We discuss the basic theory required for proper lifting techniques. In addition, we introduce various tools and accessories that are frequently required during CLT construction, as well as good building practices to help contractors build safe and efficient CLT panel structures. Finally, we discuss issues related to the transportation of CLT assemblies from factory to building site. Regulatory aspects of transportation are also discussed.

1.1 Parallel with Precast Concrete Industry

CLT construction is a relatively new process. There is therefore very little specific technical documentation for the erection of structures designed and built with CLT panels. Current CLT manufacturers provide recommendations on lifting systems for the installation of prefabricated wood assemblies. However, technical documents currently available mostly come from Europe or Canada and, to some design professionals and builders/contractors in the United States, these documents may seem incomplete or insufficiently adapted to the standard construction techniques that they use. This Chapter intends to correct that situation.

A close look at Figure 1 reveals that precast concrete construction using large concrete slabs is, in many ways, similar to the current techniques used in CLT construction. As the precast concrete construction industry is more developed and experienced, it is advantageous for CLT designers and contractors to obtain or use systems and lifting accessories adapted to this more mature industry and to build on their experience.

For example, certain systems discussed in this Chapter, which are sometimes used in CLT construction, are directly inspired by the systems used in precast concrete construction. In addition, a large amount of technical data contained in the following sections is taken from documentation developed and provided by major producers of precast concrete or by manufacturers of lifting devices specialized for use with precast concrete.



Figure 1
Lifting and handling of precast concrete elements

1.2 Lifting and Handling of CLT Elements

The emerging CLT construction industry offers various techniques for lifting and handling CLT panels so that they can be used in the erection of buildings and other structures. The complexity of the building or its location often dictates the techniques and systems to be used. Of course, erecting a 5-story building in a downtown area typically requires more preparation and precaution than a single-family residence built in the suburbs or surrounding rural country. But if that country house is to be perched high in the mountains, the techniques used may often be surprising (Figures 2 and 3).



Figure 2
Lifting and handling of CLT elements by cableway (courtesy of KLH)



Figure 3
Lifting and handling of CLT elements by helicopter (courtesy of KLH)

Figures 4 to 10 show examples of CLT panels during the lifting and handling process on construction sites. The techniques and lifting systems used are discussed in detail further in this Chapter.



Figure 4
Lifting and handling of relatively light CLT elements, in Norway
(courtesy of Brendeland and Kristoffersen, Architects)



Figure 5
Lifting and handling of CLT wall elements, in Belgium (courtesy of HMS)



Figure 6
Lifting and handling of CLT elements, in Canada (courtesy of KLH ELEMENT, photo: © Marc Cramer)



Figure 7
Lifting and handling of CLT elements in an hybrid structure, in the United States (courtesy of Binderholz)



Figure 8
Lifting and handling of CLT elements, in Canada (courtesy of Nordic Engineered Wood)



Figure 9
Lifting and handling of CLT elements, in Sweden



Figure 10
Lifting and handling of CLT elements, in Norway
(courtesy of Brendeland and Kristoffersen Architects)

2

SLINGING AND FASTENING SYSTEMS FOR THE LIFTING AND HANDLING OF CLT PANELS

A variety of systems available for lifting and handling CLT panels are presented in this section. Some systems are commonly used in CLT construction. Others are for illustrative purposes, some of which are inspired by systems used in the precast concrete industry.

Many of the systems proposed use slings. A sling is a cable that connects the fastening system to the lifting device. It usually consists of textile rope, synthetic fiber woven strips, steel cables, or chains. Slings must always be calibrated (working load permitted) and validated (wear and tear) before use. Also, the inspection of all lifting devices is the responsibility of the user and must be done by qualified people.

Please refer to the applicable U.S. Department of Labor, Occupational Safety and Health Administration regulations (OSHA) for more information.

2.1 Contact Lifting Systems

Lifting systems using steel plates that provide compressive resistance on the lower face of the panels during lifting are popularly considered the safest CLT panel handling methods. However, to avoid accidents on the lower levels of the building once the panels are in place, great care must be taken when removing the system as the steel plates are usually not secured once the system is unbolted.

This lifting technique typically requires in-plant drilling to allow the insertion of dowels or threaded sleeves with nuts. This technique uses the wood's efficient strength in compression perpendicular to the grain. However, when CLT elements are intended to be visible inside the building, local repairs will be required using wooden dowels.

It is important to note that, in all cases outlined hereafter, the holes must be sealed to ensure proper air tightness and to limit the spread of sound, smoke, and fire.

The following examples describe some contact lifting systems; cutaway views are shown for simplicity and clarity.

2.1.1 Single Lifting Loop with Threaded Sleeve Used with Socket Steel Tube Welded onto Flat Steel Plate

The system, comprised of a single lifting loop with threaded sleeve, is widely used in the construction of precast concrete. The system shown in Figure 11 is a modification of the system commonly used to lift precast concrete. Instead of enclosing the welded plate socket in concrete at the plant, the socket is welded to a steel plate and inserted into a previously machined hole. The lifting loop is then screwed from above using the threaded sleeve. This system is considered simple, safe, economical, and quick to use on the construction site.

The single lifting loop used in the precast concrete industry can be reused but the contractor must verify its ongoing performance through rigorous design and a careful inspection and quality control system to ensure safety. When using this system, the recommended maximum angle (β) is 30° (see Figure 34). The use of a spreader beam can help reduce the lifting angle. It is also recommended that the radius of the hook be at least equal to the diameter of the lifting loop steel cable. When handling is completed, the two components must be removed carefully.

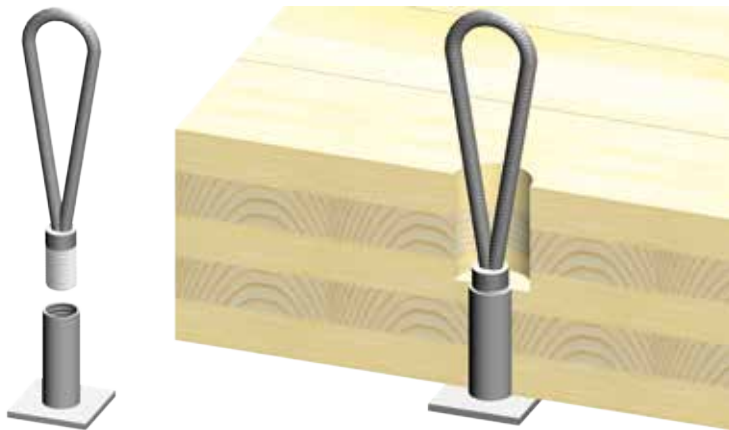

Figure 11
Single lifting loop with threaded sleeve used with socket steel tube welded onto flat steel plate

2.1.2 **Articulated Lifting Loop with Threaded Sleeve Used with Socket Steel Tube Welded onto Flat Steel Plate**

The system made of an articulated lifting loop with threaded sleeve also comes from the precast concrete industry and is installed in the same manner as the previous system. One advantage of this system is the ability of the steel cable to rotate in all directions around the threaded sleeve. However, the lifting angle should still be limited to 30°. When handling is completed, the two components must be removed carefully.

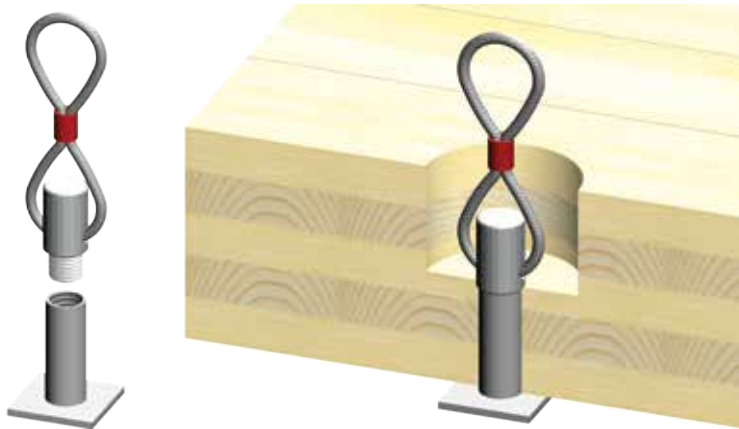

Figure 12

Articulated lifting loop with threaded sleeve used with socket steel tube welded onto flat steel plate

2.1.3 **Articulated Lifting Hook with Threaded Sleeve Used With Socket Steel Tube Welded onto Flat Steel Plate**

The system with articulated lifting hook and threaded sleeve used with a socket steel tube welded onto a flat steel plate also comes from the precast concrete industry. The hook allows for quick installation on the lifting system and has the ability to rotate around the steel ring. The lifting angle should still be limited to 30°. When handling is completed, the two components must be removed carefully.

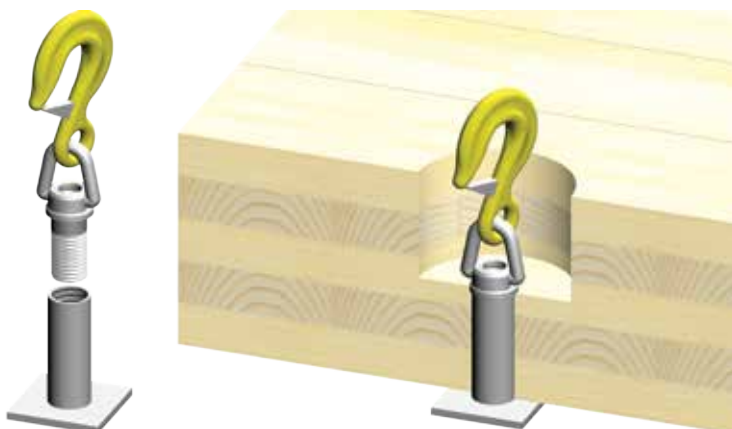

Figure 13

Articulated lifting hook with threaded sleeve used with socket steel tube welded onto flat steel plate

2.1.4 Threaded Eyelet Bolt Used with Socket Steel Tube Welded onto Flat Steel Plate

The threaded eyelet bolt used in conjunction with a socket steel tube welded onto a flat steel plate is also a good option for quick and safe lifting. However, it is important to choose the right eyelet bolt and to install it correctly (Figures 14 and 15). It is recommended to use an eyelet base bolt when lifting heavy loads at an angle. Ensure there is proper contact between the base and the wood panel. Ensure sufficient thread engagement between the eyelet and threaded sleeve. Plain or regular eyelet bolts (without base) are normally used in straight tension when lifting light loads; that is, when used with a spreader beam or with only one attachment point. Also, according to good practice, the eyelet bolts must be oriented in the same direction as the tensioned slings since the eyelet could bend under heavy oblique loads. When handling is completed, the two components must be removed carefully.

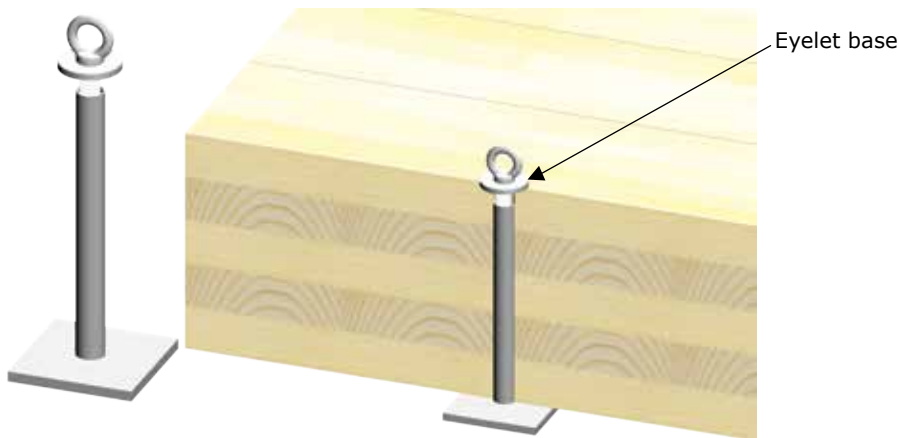

Figure 14

Threaded eyelet bolt (with base) used with socket steel tube welded onto flat steel plate

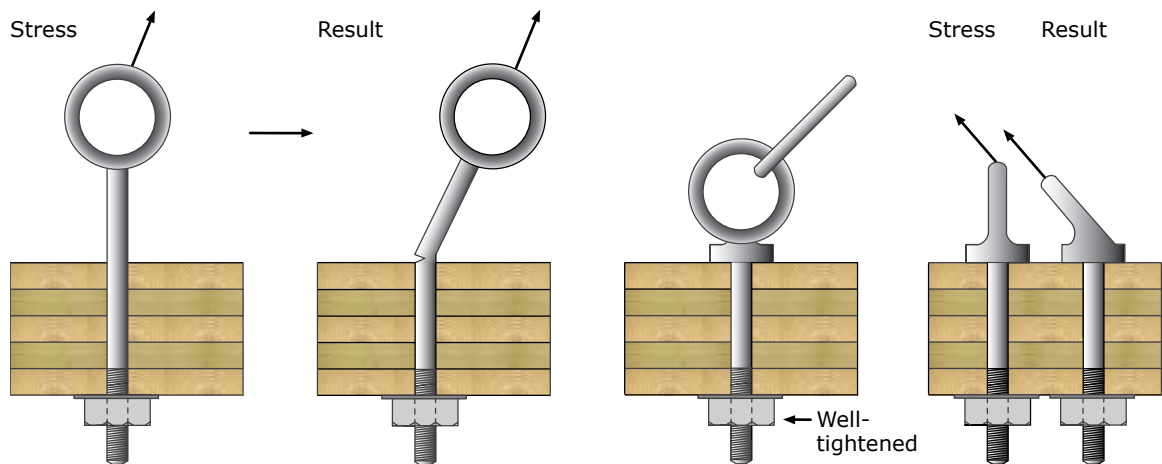

Figure 15

Correct use of threaded eyelet bolt (with and without eyelet base)

2.1.5 Threaded Eyelet Bolt Used with Steel Plate and Nut

The system using the threaded eyelet bolt in conjunction with a steel plate and nut is widely used in CLT construction. However, it is important to choose the proper eyelet bolt and to install it correctly. The use of an eyelet base bolt when lifting at an angle is also strongly recommended. Also, according to good practice, the eyelet bolts must be oriented in the same direction as the tensioned slings since the eyelet could bend under heavy oblique loads. When handling is completed, the system must be carefully removed.

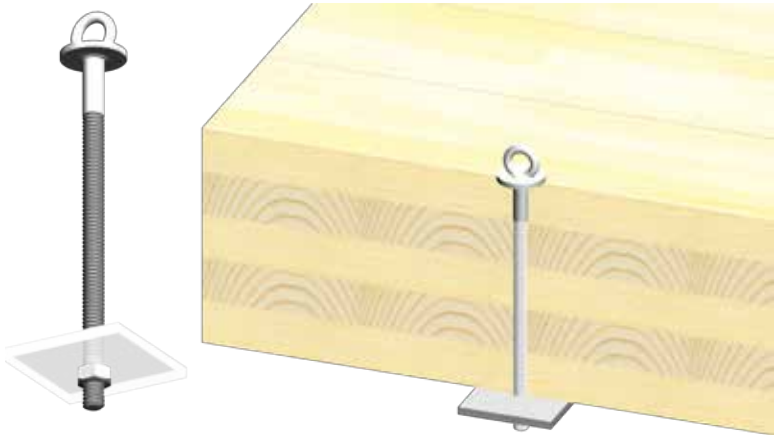

Figure 16
Threaded eyelet bolt used with steel plate and nut

2.1.6 Eyelet Used with Bolt or Threaded Sleeve and Steel Plate

The following system is similar to the system presented in 2.1.5, and the same recommendations apply. In this case, the eyelet is independent from the sleeve or bolt. It is important to use an eyelet with base when lifting at an angle. Baseless eyelets should only be used when lifting in straight tension. When handling is completed, the system must be completely and carefully removed.

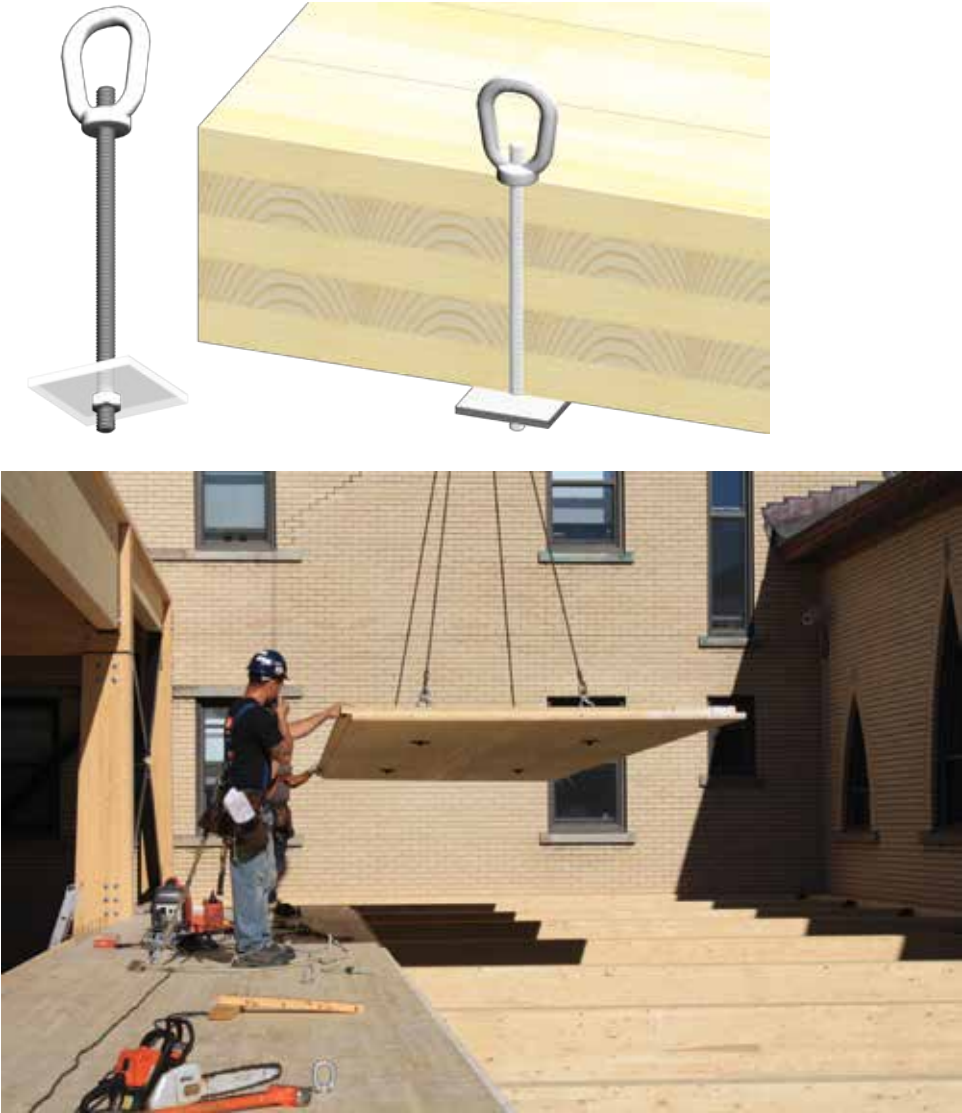

Figure 17
Eyelet used with threaded bolt or sleeve and steel plate (courtesy of Nordic Engineered Wood)

2.1.7 Threaded Eyelet Bolt, Threaded Socket, Threaded Bolt and Steel Plate

The threaded eyelet bolt can be used with a threaded socket, a bolt, or a threaded rod and steel plate. The threaded socket is normally pre-installed in the CLT plant for future use on site. On the construction site, the eyelet bolt and the single bolt or the threaded rod are easily screwed to the plate. Again, it is important to choose the right eyelet bolt and to install it correctly. When handling is completed, the two bolts and the steel plate are removed. The threaded socket remains in place for future use. For instance, adaptability and dismantling in a building, as well as repairing and upgrading operations, require the presence of elements or tools that facilitate the future handling process of building components.

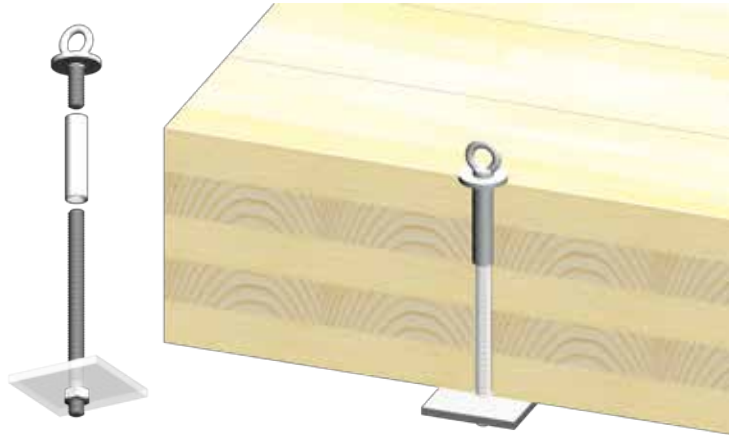

Figure 18

Threaded eyelet bolt, threaded socket, threaded bolt or sleeve and steel plate

2.1.8 Threaded Eyelet Bolt, Threaded Socket and Steel Round Rod

Another product that comes from the precast concrete construction industry can inspire a new system for lifting light CLT panels. A threaded socket with holes at the tip is inserted into the CLT slab. This socket is normally embedded in the concrete. An eyelet bolt is screwed into the socket. The lifting system is then locked with a steel round rod that is in contact with wood. When handling is completed, the three elements are removed. However, this system can leave marks on the timber and may not be suitable if the panel must remain visible on the underside. This proposed system is suitable for lightweight CLT panels only (e.g., less than ½ ton).



Figure 19

Threaded eyelet bolt, threaded socket and steel round rod

2.1.9 Soft Lifting Sling Used with Support

Another system widely used in CLT construction is shown in Figure 20. A hole is drilled into the panel usually at the plant (2~3 inches or 50~75 mm in diameter). On the construction site, a soft sling is inserted into the hole and a locking piece is used on the underside. The next figure shows a piece of dimensional lumber being used. However, it is important to ensure that the locking parts are properly fixed and will not slip during handling. This proposed system is suitable for small and lightweight CLT panels only (e.g., less than ½ ton).



Figure 20
Single lifting sling used with support

2.1.10 **Soft Lifting Sling Without Support for Vertical Elements**

The lifting systems presented in the previous examples are intended mainly for floor and roof slabs. For wall assemblies, a simple system requiring only one hole and a flexible sling is often used. The sling must be load rated for the panels being tilted and/or lifted. Since walls are often lighter than thick floor slabs, this system is often appropriate for tilting up, lifting, and placement of the panels. The holes must be plugged once handling is completed, especially those in the exterior walls.





Figure 21
Lifting sling without support (with hole)

2.1.11 Soft Lifting Sling Without Support for Horizontal Elements

This simple lifting system requires no holes to be drilled in the panels. However, this technique comes with a risk of instability due to the possibility of slings slipping during lifting. Also, in order to leave enough space to release the slings once the element is in place, the panels cannot be completely juxtaposed. Therefore, they must be drawn together with the appropriate tools (refer to Sections 4.3 to 4.5).



Figure 22
Lifting sling without support (without hole)

The next technique requires two holes drilled in the CLT panel for each anchor point. These holes have a diameter of approximately 2 inches (50 mm) and are relatively close together but not less than an amount equal to the thickness of the CLT panel. A soft sling is inserted as shown in Figure 23.



Figure 23
Lifting sling without support (with holes)

2.2 Screw Hoist Systems

There are several lifting techniques that rely only on the withdrawal resistance of fastenings. Although these techniques are simple and effective, they require a careful design analysis for the loads involved and strict control during installation and use. One advantage of this system is that it does not affect the wood appearance when sections must remain visible on one side. This section describes some examples.

2.2.1 Screwed Anchor

The most widely used screw hoist system in Europe is shown in Figure 24. This system is based on an anchor used in precast concrete construction. The original system uses an anchor embedded in the concrete with a protruding head to allow connection to a lifting ring.

Figure 24 shows the two components required for lifting. A self-tapping screw makes the connection between the CLT panel and the lifting ring. It is strongly recommended to use the self-tapping screw only once. The self-tapping screw is usually installed in plant by the CLT manufacturer as a recess is normally required in order to embed the fixed piece. The lifting ring must be inspected frequently to ensure safety. This system can be installed on both the top and side of the panels. It is important to refer to the manufacturer's technical data in order for the design professional to determine the allowable loads and for usage and installation specifications.



Figure 24
Lifting system with self-tapping screw



Figure 25
Screwed anchor

2.2.2 Screwed Plate and Lifting Ring

There are various lifting systems using screws or lag screws in combination with steel plates with holes. Figure 26a shows a system that uses only two self-tapping screws. This system offers very little flexibility in terms of allowable capacity.

However, it is possible to increase the number of screws in order to increase its lifting capacity. Figure 26b shows a much more flexible system. The plate has sufficient pre-drilled holes to accommodate several lag screws or wood screws. Thus, the plate provides the design professional in charge of designing the lifting systems with much more flexibility since the same plate can be used repeatedly. The steel plates, lifting ring, and lag screws should be checked regularly to ensure they have not been damaged during previous uses. Figure 26c shows a light panel being lifted. Lag screws should only be installed in a properly sized lead hole (see National Design Specification (NDS) for Wood Construction for more information) and care must be taken during installation of the lag screws to prevent stripping out of the wood. When pneumatic or electric tools are used to drive lag screws, proper calibration and maintenance of torque-limiting clutch systems is essential.



a)

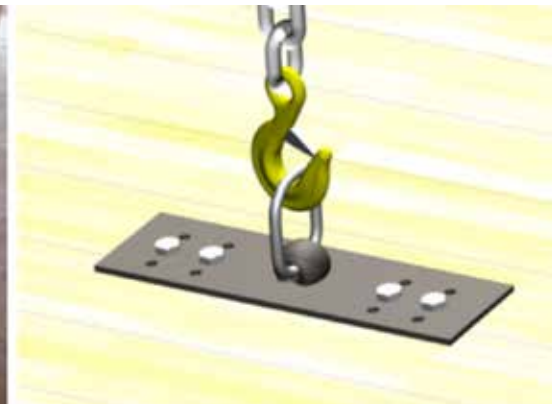

b)



c)

Figure 26
Screwed plate and lifting ring (courtesy of Tergos)

2.2.3 Double-threaded Socket with Eyelet Bolt or Lifting Loop with Threaded Sleeve

Another lifting method consists of using a double-threaded socket (i.e., threaded inside and outside) together with an eyelet bolt or lifting loop. This system is screwed in place into the panel. Similar to a lag screw, a hole with a diameter equal to 75 ~ 90% of the socket diameter must first be drilled in the wood. It is important that the design professional refers to the manufacturer's technical data to determine the acceptable installation and usage of these proprietary lifting systems.

On the construction site, the eyelet bolt (or lifting loop with threaded sleeve) is installed for lifting. Once handling is completed, the bolt is removed. The double-threaded sleeve remains in place for future use. This system can be installed on both the top and side of the panels. It is important to refer to the manufacturer's technical data to determine the allowable loads and for usage specifications.

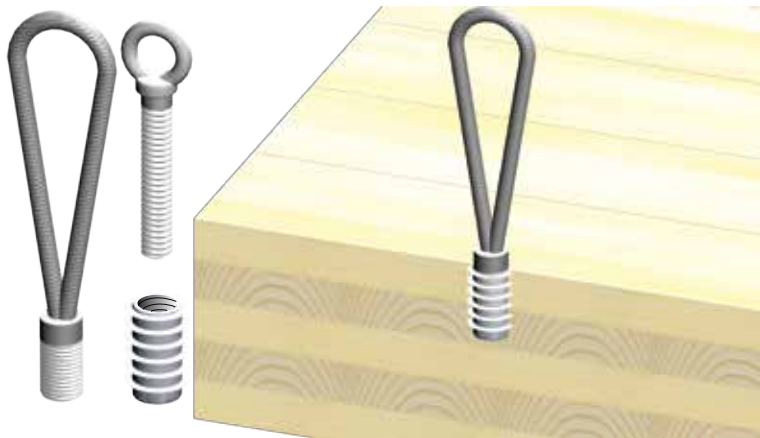

Figure 27

Double-threaded socket with eyelet bolt or lifting loop with threaded sleeve

2.2.4 Innovative Lifting System with Wood Screws and Eyelet Bolt

Some manufacturers may offer other innovative anchoring systems. An example is shown in Figure 28. Wood screws are used to screw the cylindrical steel component to the panel. This piece is usually attached on the top of the panel. However, a recess can be performed into the panel at the CLT plant in order to embed the fixed piece, thus allowing stacking of the panels during transportation. It is important to refer to the manufacturer's technical data to determine the allowable loads and for usage specifications. Again, it is important that the design professional refers to the manufacturer's technical data to determine the acceptable installation and usage of these proprietary lifting systems.

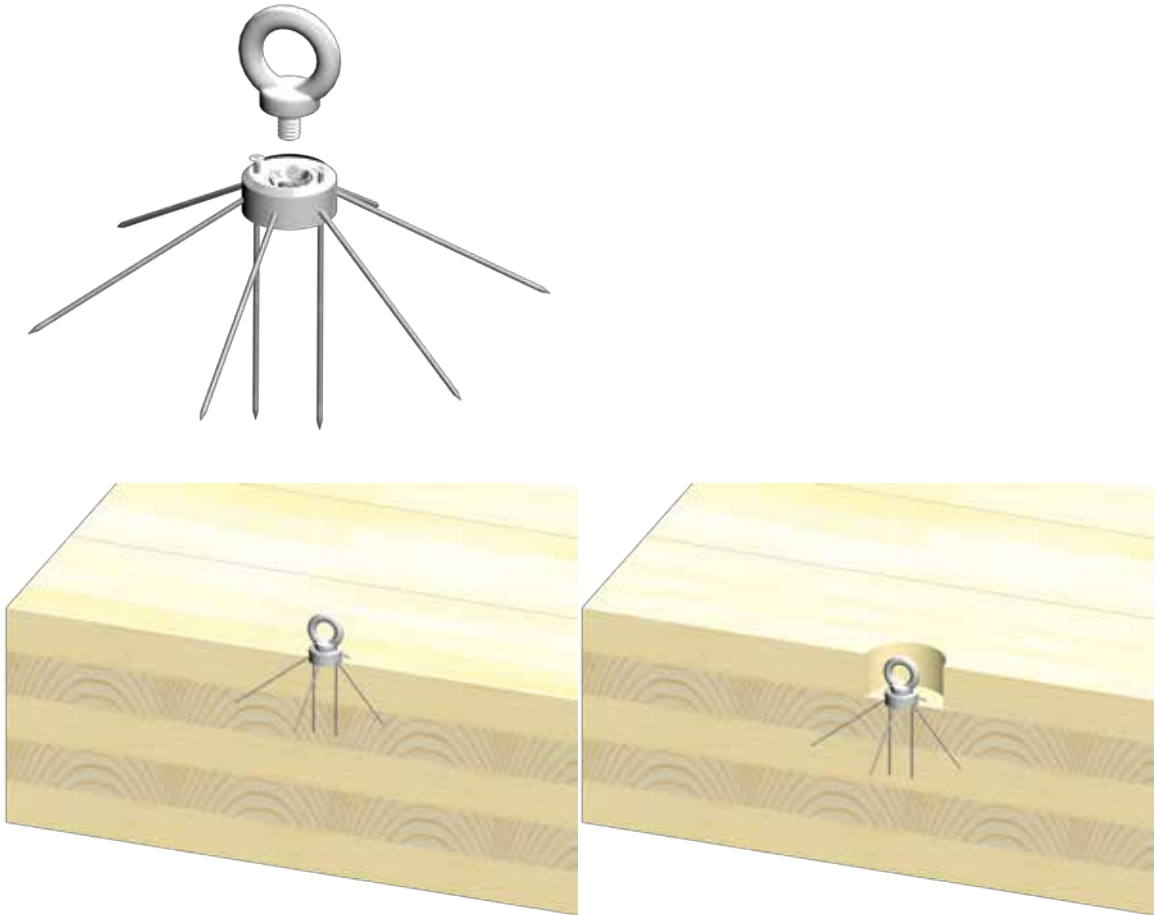

Figure 28
Innovative lifting system with wood screw (with or without recess)

2.3 Integrated Lifting Systems

The principle of using plant-integrated support parts lends speed to jobsite execution on construction sites. These systems are simple and safe. In addition, if the ceilings of buildings should remain visible, no major repair is required. However, it is better to seal the holes to ensure air tightness and to limit the spread of sound, smoke, and fire. Some examples are given in this section.

2.3.1 Inserted Rod with Soft Sling

This technique is frequently used in Europe and Canada. It consists of first drilling one hole on the top of the panel a few inches from the edge depending on the dowel bearing strength of the CLT panel (see Chapter 5). This hole, which has a diameter of about 2~3 inches (50~75 mm), is drilled at the plant by a CNC machine at a depth equivalent to about one half to two thirds of the thickness of the panel. Then, using a long drill, a hole is drilled on the side facing the axis of the hole made on the top of the panel. A steel rod with a diameter equal to that of the hole is then inserted into the hole. It is possible to use smooth rods or steel reinforcing bars. Upon insertion of the rod, a soft sling is installed and held by the rod (at the plant). The sling should be able to be positioned within the hole for easy stacking during transportation. Once the lifting and handling steps have been completed, the sling is either cut or inserted into the hole for future use. Figure 29a shows the first system.



(a)

Figure 29b shows a similar system. However, instead of drilling a hole, a groove is made on the top of the panel a few inches from the edge. The alteration is performed using a CNC machine at the plant at a depth equivalent to about one half to two thirds of the thickness of the panel. Then, using a long drill, a hole is drilled on the side. A steel rod with a diameter equal to that of the hole is then inserted into the hole. Once the panel is on the construction site, a soft sling is simply slipped under the rod; this sling can be removed once the panel is positioned. The steel bar remains in place and the hole should be sealed.





b)

Figure 29
Inserted rod with soft sling

2.3.2 Inserted Rod with Lifting Hook

The next system is once again inspired by the precast concrete construction industry. This method consists of drilling one hole on the top of the panel (re-entrant), a few inches from the edge depending on the dowel bearing strength of the CLT panel used (see Chapter 5). The diameter of this hole must be large and deep enough to allow insertion of a lifting hook, as shown in Figure 30. Then, with a long drill, a second hole is drilled at the plant using a CNC machine on the side facing the axis of the hole made on top of the panel. A steel rod with a diameter equal to that of the hole is then inserted into the hole. Once the panel is on the construction site, the hook is attached to the rod for the lifting and handling phase. The steel rod remains in place and the hole should be sealed.

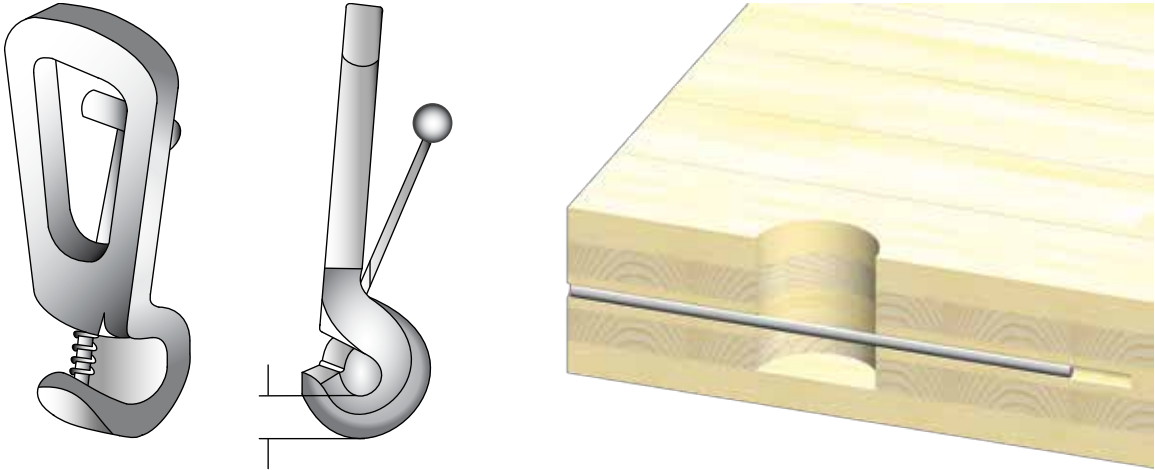

Figure 30
Inserted rod with lifting hook

3

GENERAL PRINCIPLES FOR LIFTING AND HANDLING CLT ELEMENTS

There are several types of lifting equipment that can be used on construction sites. Each has its own characteristics for lifting and handling heavy loads such as CLT panels. It is therefore essential to choose the right lifting and handling system for each type of component.

It is also of the utmost importance that lifting equipment be positioned and operated properly. Several criteria must be verified and validated prior to and during work on site. Design professionals and contractors/builders in charge of a construction project involving CLT panels need to consider certain important points. Some recommended considerations are presented in the following sections.

3.1 Lifting Station and Devices

The lifting station is undoubtedly a key location on the construction site. The lifting device must be selected and positioned according to several criteria. Certain construction sites may require more than one lifting device and some sites may need to change the type of device being used during the construction phase.

Here are some of the elements to be considered when choosing a lifting device. The device must, without limitation:

- Be able to lift all required loads for the duration of construction:
 - Types of loads may vary on the same construction site;
 - If possible, the lifting device should not be moved. However, the lifting device should be capable of being moved as jobsite and erection conditions require;
- Reach appropriate height and distance with required maximum load:
 - Appropriate range must be attained for all required distances, from point A to point B;
 - The travel path of the element to be lifted to reach the desired location must be clear of any obstacles;
- Be efficient, be able to maintain the needed working pace and be flexible, while keeping safety first.

In addition, consideration must be given to the type of land upon which the construction will be done, as well as the immediate surroundings. To avoid unplanned consequences, it is strongly recommended to inspect the site before choosing the type of device.

The grounds (slopes, streams, etc.) and the soil's bearing capacity (sand, clay, etc.) are important points to consider. As well, the stability of the operating devices must be maintained at all times. For example:

- A crane can collapse under the weight of excessive load;
- The ground can degrade under the device's bearing points;
- A device that is too close to a slope can become unstable and tip over;
- The device's range may allow it to come into contact with obstacles (e.g., buildings, trees, a second crane, power lines, etc.).

Despite all precautions that can be taken, accidents may occur. Thus, it is strictly forbidden to handle loads directly above workers or the public. Also, to avoid serious accidents, the worker in charge of positioning the slings should never stand between the load to be lifted and a fixed object, in case of load instability or improper operation during lifting. Other safety-related recommendations are available from regulatory authorities (please refer to the applicable U.S. Department of Labor, Occupational Safety and Health Administration regulations (OSHA) for more information).

3.2 Determining the Weight and Center of Gravity of CLT Elements

Before choosing the proper lifting system, it is important to know the total weight of the element to be lifted, as well as the position of its center of gravity. The whole weight of the load is considered concentrated at this center of gravity.

Although density of wood greatly varies depending on wood species (specific gravity) and moisture content, i.e., between 20 and 45 pound per cubic foot (320 and 720 kg/m³) (Wood Handbook, 2010), it is recommended to use an average density varying between 25 and 37 pound per cubic foot (400 and 600 kg/m³) for the calculation of the total weight of CLT elements made of softwood lumber. Note that this density is about five times lower than the density used for precast reinforced concrete elements, which is usually about 150 pound per cubic foot (2400 kg/m³). Nevertheless, the total weight of CLT elements can be considerable. As an example, a 8 feet x 52 feet x 1 foot (2.4 m x 16 m x 300 mm) thick CLT slab weighs about 12,000 pounds (≈6 tons). We suggest verifying the CLT panel weights with the manufacturers as they will vary by species used. The following section illustrates how to calculate the weight of a CLT panel.

The total weight of a CLT slab is simply calculated as follows:

$$P = V \times \rho_{CLT} \quad [1]$$

$$V = b \times L \times h \quad [2]$$

where:

P = CLT slab weight (lb.)

V = Volume of slab to be lifted and handled (ft.³)

b = Slab width (ft.)

L = Slab length (ft.)

h = Slab thickness (ft.)

ρ_{CLT} = CLT slab average density (25 ~ 37 lb./ ft.³)

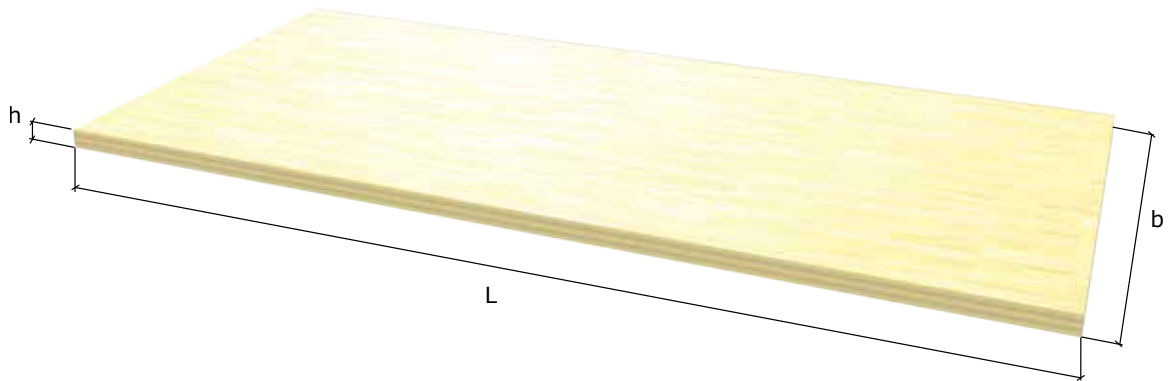

Figure 31
Calculating the weight of a CLT slab

3.3 Dynamic Acceleration Factors

3.3.1 Lifting System Used

During lifting and handling maneuvers, elements are subject to dynamic forces that must be taken into account. These forces mainly depend on the chosen system, the lifting speed, and the type of ground on which the elements are being handled.

Table 1 provides an overview of suggested lifting and handling dynamic acceleration factors for specific devices used in construction. These factors should be taken into account for the calculation of forces.

IMPORTANT: Note that the tabulated values are provided for informational purposes only. It is important to refer to normalized values, if any, as provided by the relevant authorities (e.g., States, federal, local, etc.).

Table 1
Dynamic acceleration factors (f)

Lifting Device	Dynamic Coefficient of Acceleration f
Fixed crane	1.1 ~ 1.3
Mobile crane	1.3 ~ 1.4
Bridge crane	1.2 ~ 1.6
Lifting and moving on flat terrain	2.0 ~ 2.5
Lifting and moving on rough terrain	3.0 ~ 4.0 and +

Source: FPInnovations, CLT Handbook, Chapter 12

3.3.2 Other Effects to Consider

Wind can significantly increase forces in lifting systems. CLT manufacturers, contractors and design professionals in charge of a project should consider such loads in their calculations based on the surface in contact with the wind as well as the location and height of assemblies requiring lifting.

However, it is normally unwise to lift loads when weather conditions are deemed dangerous. Prefabricated CLT elements are subject to wind movement and this phenomenon should not be underestimated.

The use of guide ropes is recommended to prevent rotation of assemblies during lifting.

Finally, it is recommended that each lifting job be performed in a single operation or in compliance with the (sequence of) operations intended by the engineer.

3.4 Asymmetrical Distribution of Load According to Center of Gravity

It is always better to fix anchors in a way to limit the eccentricity due to the center of gravity of the element to be lifted. If anchors are asymmetric with regard to the center of gravity, forces will not be equally distributed during lifting and must be calculated accordingly. Tensile and shear forces must be calculated for each component to be lifted, or the most critical elements must be taken into consideration.

Furthermore, to limit the tilt and sway of panels during lifting and handling, it is possible to use a spreader system. Simply align the center of gravity of the element as calculated exactly facing the hook installed on the spreader beam to prevent rotation. Figure 32 shows the appropriate method. However, if the lifting of an element is done without a spreader beam, which is often the case in CLT construction, it is important to check the balance of the load when lifting. Wind can also swing and spin the load.

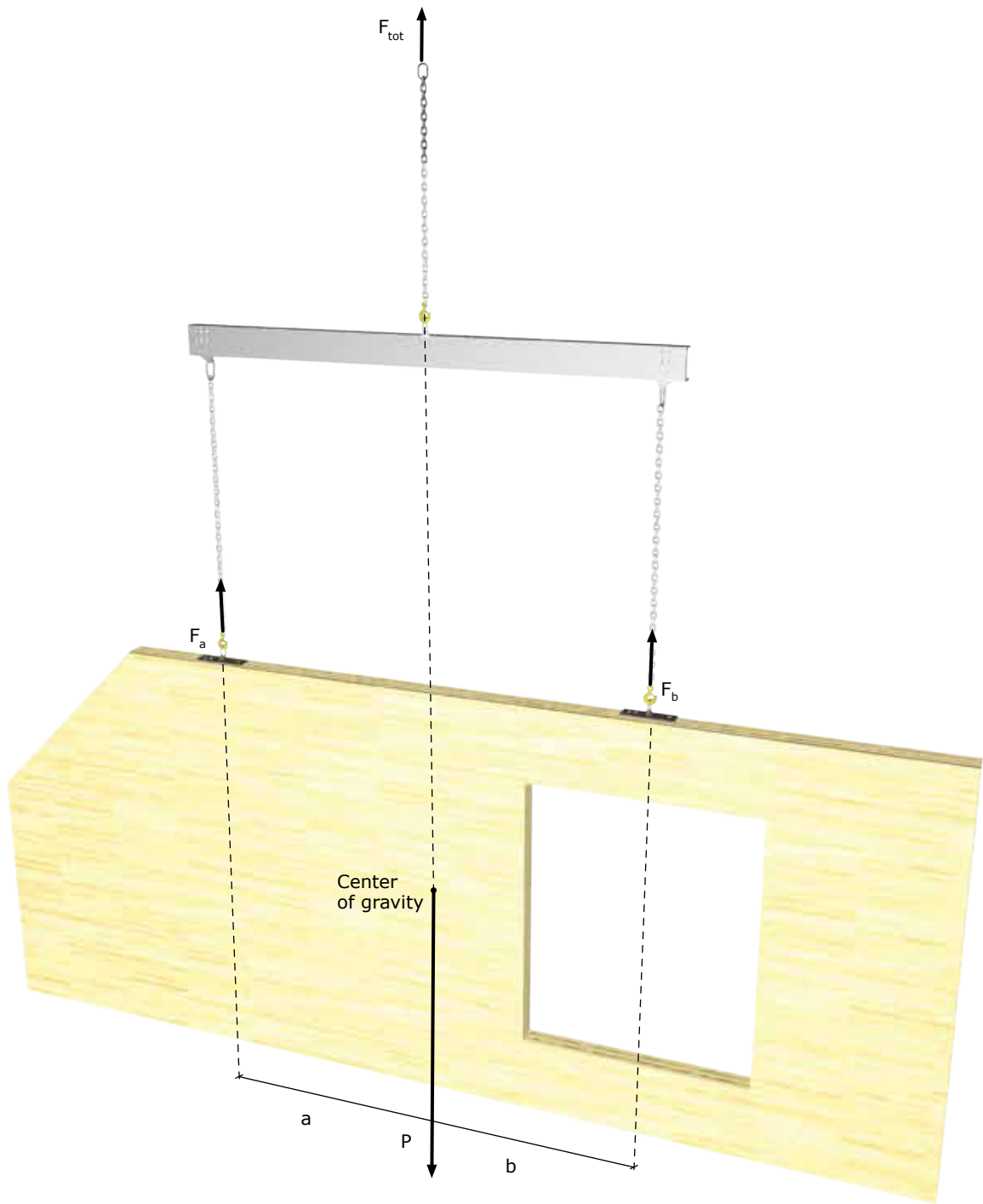

Figure 32
Element lifted with a spreader system

For example, the next equations are used to calculate forces in two anchors placed asymmetrically to the center of gravity of an element that is being lifted with a spreader system. The center of gravity required for determining measures “a” and “b” may be given by the CLT manufacturer when CAD software and CNC machines are used.

$$F_a = \frac{P \times b}{(a + b)} \quad [3]$$

$$F_b = \frac{P \times a}{(a + b)} = P - F_a \quad [4]$$

3.5 Determining Forces According to Lifting Angles

When a spreader system, similar to that shown in Figure 32, is not used for lifting assemblies, it is necessary to adjust forces in the anchors by taking into account the lifting angles. In this case, the inclination angle of the cables or slings will vary depending on their length.

The adjustment is done by evaluating the coefficient of angle z. A range of coefficients z is presented in Table 2 according to the inclination angle β. Refer to Figure 34 for more details about angles. These coefficients are used in the Equation 5 presented later in this Chapter.

Table 2

Coefficient of lifting angle (β)

Cable Angle β ⁽¹⁾	Angle α ⁽²⁾	Angle Coefficient z ⁽³⁾
0°	0°	1.000
7.5°	15°	1.009
15°	30°	1.035
22.5°	45°	1.082
30°	60°	1.155
37.5°	75°	1.260
45°	90°	1.414
52.5°	105°	1.643
60°	120°	2.000

(1) It is strongly recommended to limit β to 30°

(2) α = 2 x β

(3) z = 1/cos β

3.6 Determining Load Distribution According to the Number of Effective Anchors (Suspension in Several Effective Points « N »)

It is common practice to use only two anchor points when CLT wall or beam elements are handled on the construction site. In these cases, it is normally sufficient to determine forces in the two anchors ($N = 2$) according to the position of the center of gravity, the lifting system, and the lifting angle.

However, for floor and roof slabs, or for long wall assemblies, the use of three or four anchors is generally required. Thus, if more than two anchors are used, it may be impossible to accurately determine the load applied to each anchor, even when anchors are positioned symmetrically to the center of gravity. Indeed, there is no guarantee that the load will be perfectly symmetrical to the center of gravity or that the slings will be exactly the same length. It is therefore strongly suggested to correctly establish the maximum forces by using only two effective anchors ($N = 2$).

In special cases, for example, when the loads are not precisely known, or the element is irregular in shape, each anchor should be calculated so as to be capable of supporting the total load of the assembly ($N = 1$).

Furthermore, to ensure proper distribution of forces in each anchor considered to be effective, it is important to use systems with minimal friction. The use of free spreaders, pulleys, or shackles helps reduce unwanted friction.

Note that, in all cases, it is recommended not to use excessively long slings so as to avoid instability or to create high angles when lifting. Also, if assemblies that require lifting and handling are too long, the use of a spreader system might be a better option, as it will limit the length of the slings.

Figures 33 to 40 present typical cases of CLT element lifting and the number of effective anchors suggested in the calculations.

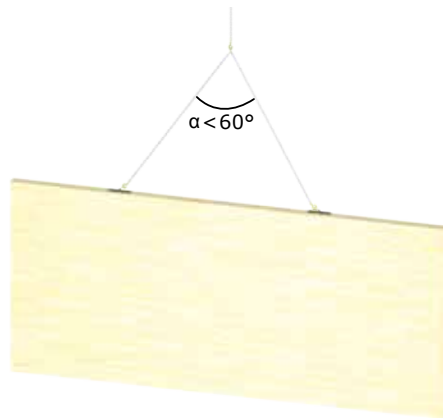

Proper angle

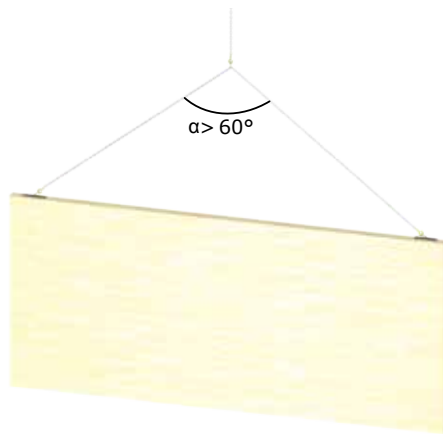

Angle too sharp



Better performance using spreader

Figure 33
CLT wall lifted with two slings symmetrically positioned – good and bad practices

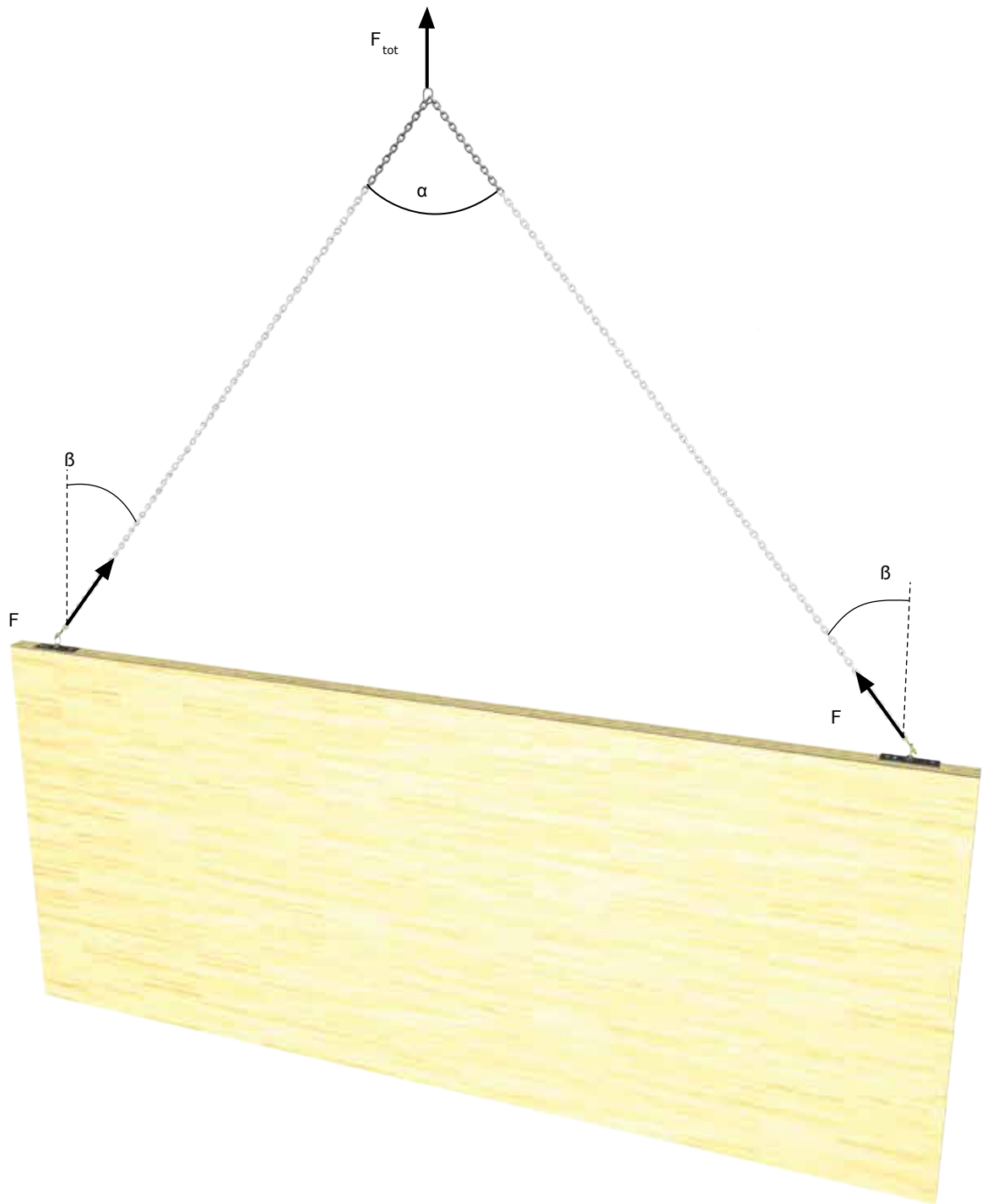

Number of effective anchors = 2

Figure 34
CLT wall lifted with two slings symmetrically positioned with F_{tot} in line with the center of gravity ($N = 2$)

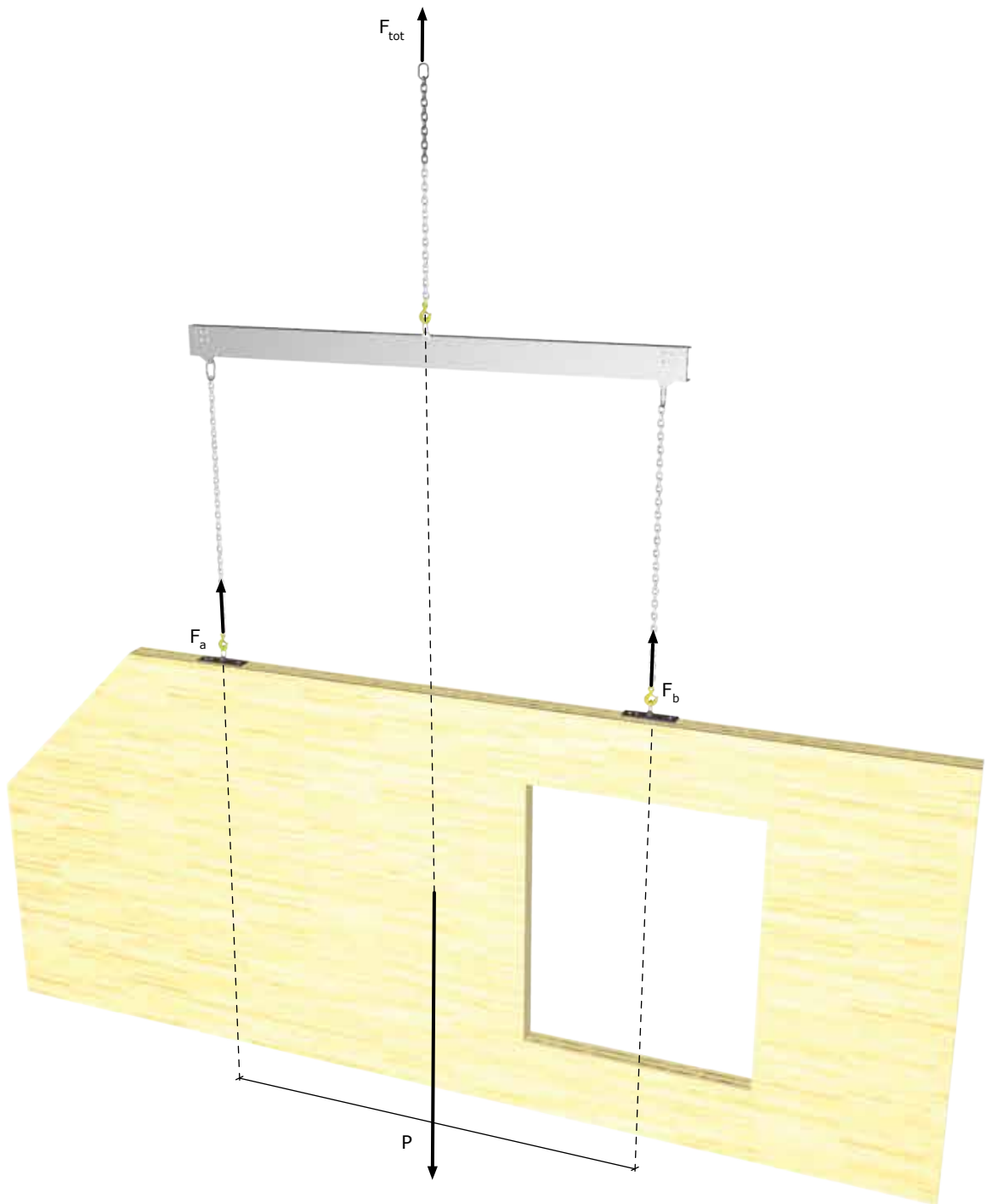

Number of effective anchors = 2

Figure 35

CLT wall lifted with two slings asymmetrically positioned with F_{tot} in line with the center of gravity, with single spreader ($N = 2$)

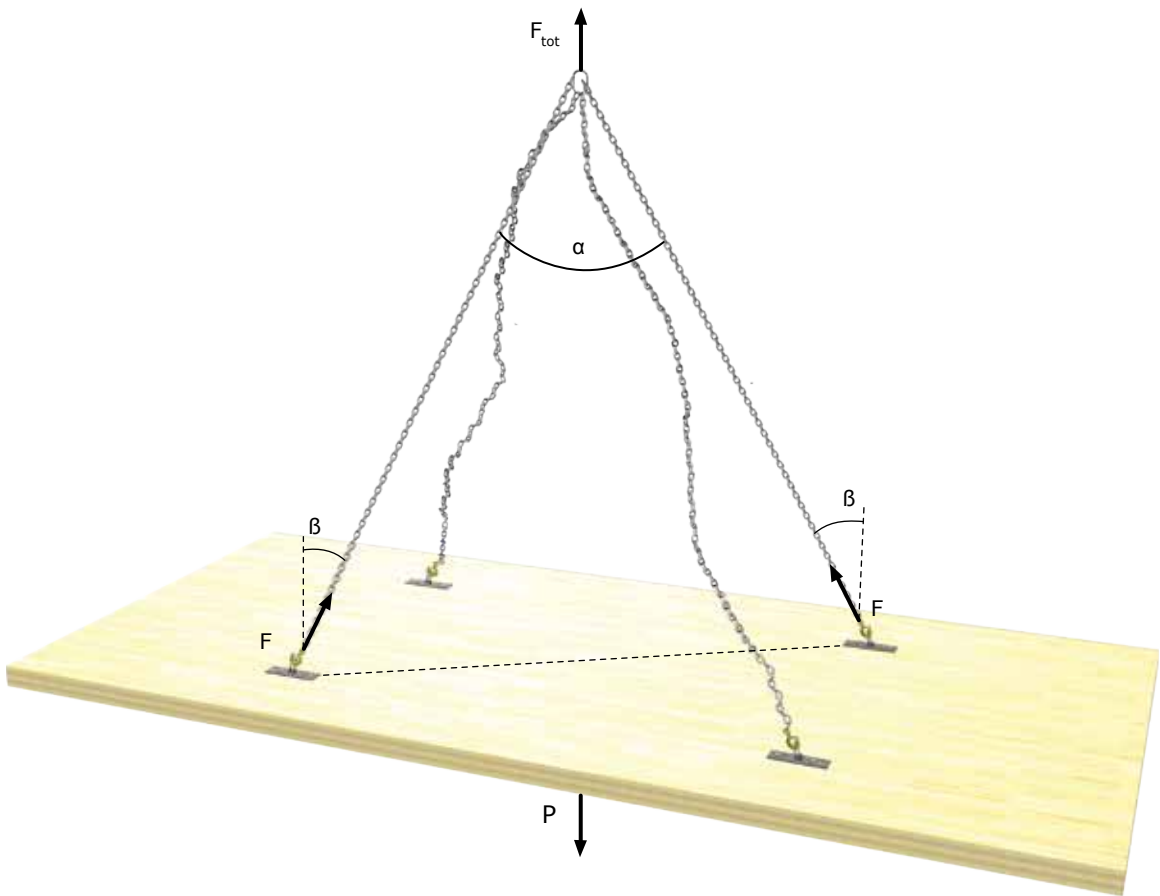

Number of effective anchors = 2

Figure 36
CLT slab lifted with four slings symmetrically positioned to the center of gravity, without spreader and without compensation system ($N = 2$)

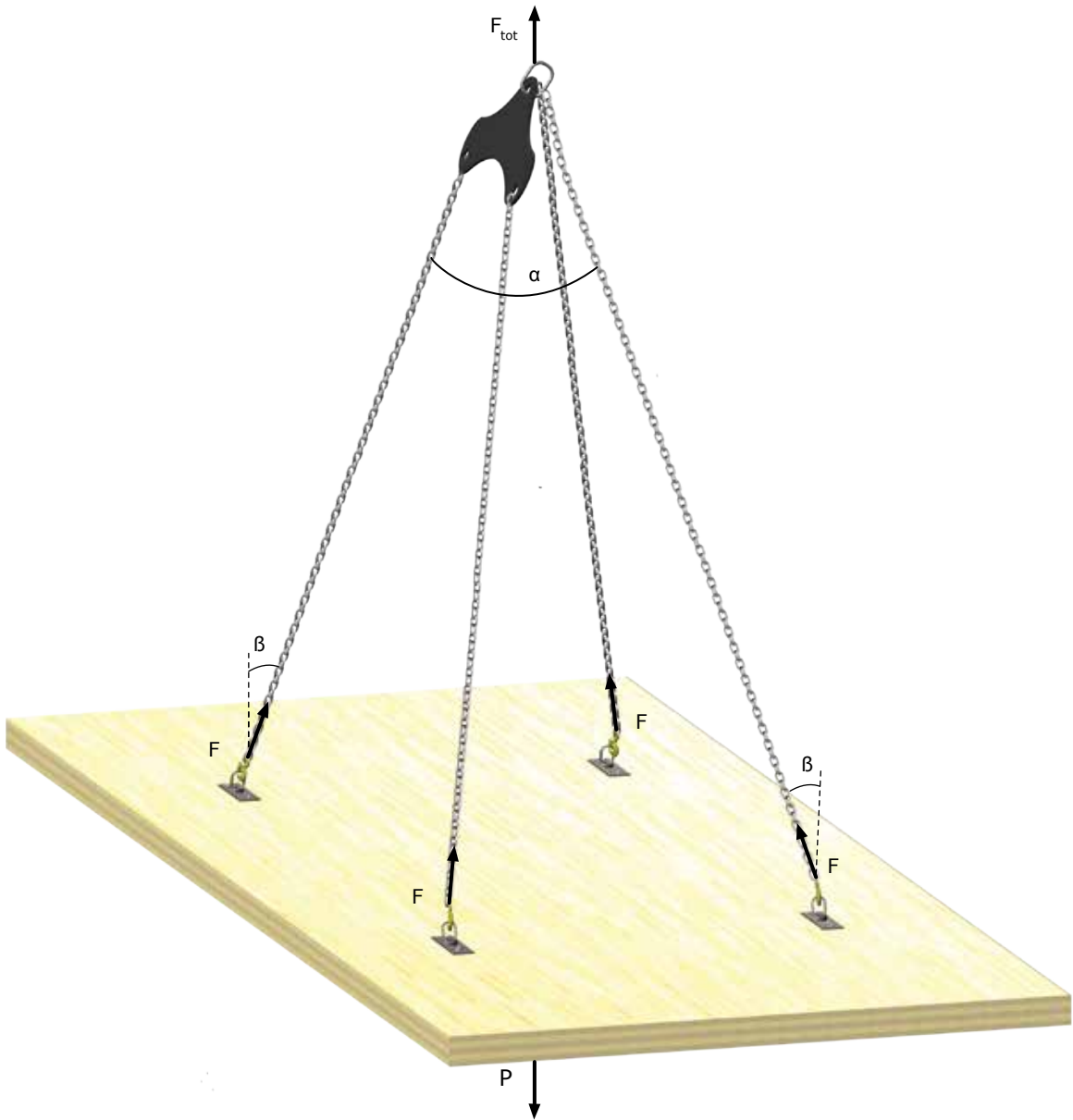

Number of effective anchors = 4

Figure 37

CLT slab lifted with four slings symmetrically positioned to the center of gravity, with compensation system ($N = 4$)

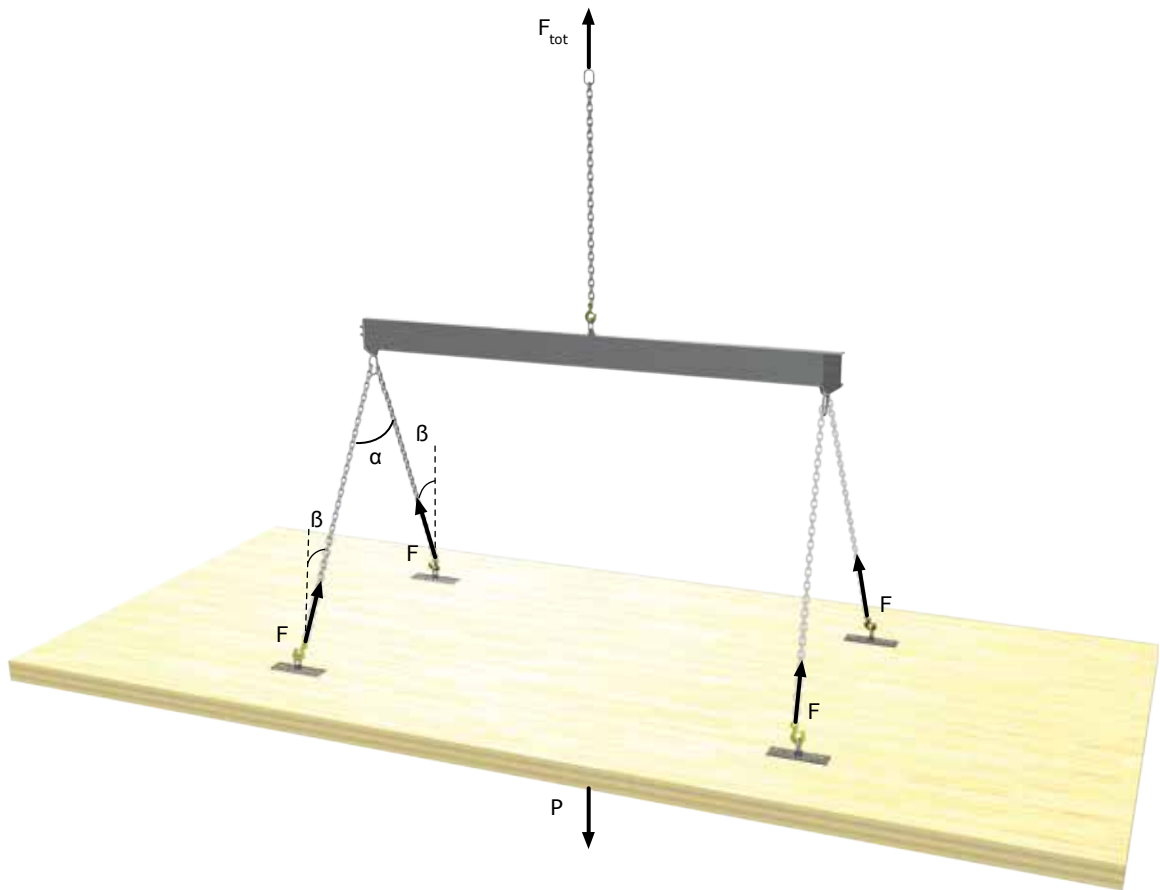

Number of effective anchors = 4

Figure 38

CLT slab lifted with four slings symmetrically positioned to the center of gravity, with single spreader ($N = 4$)

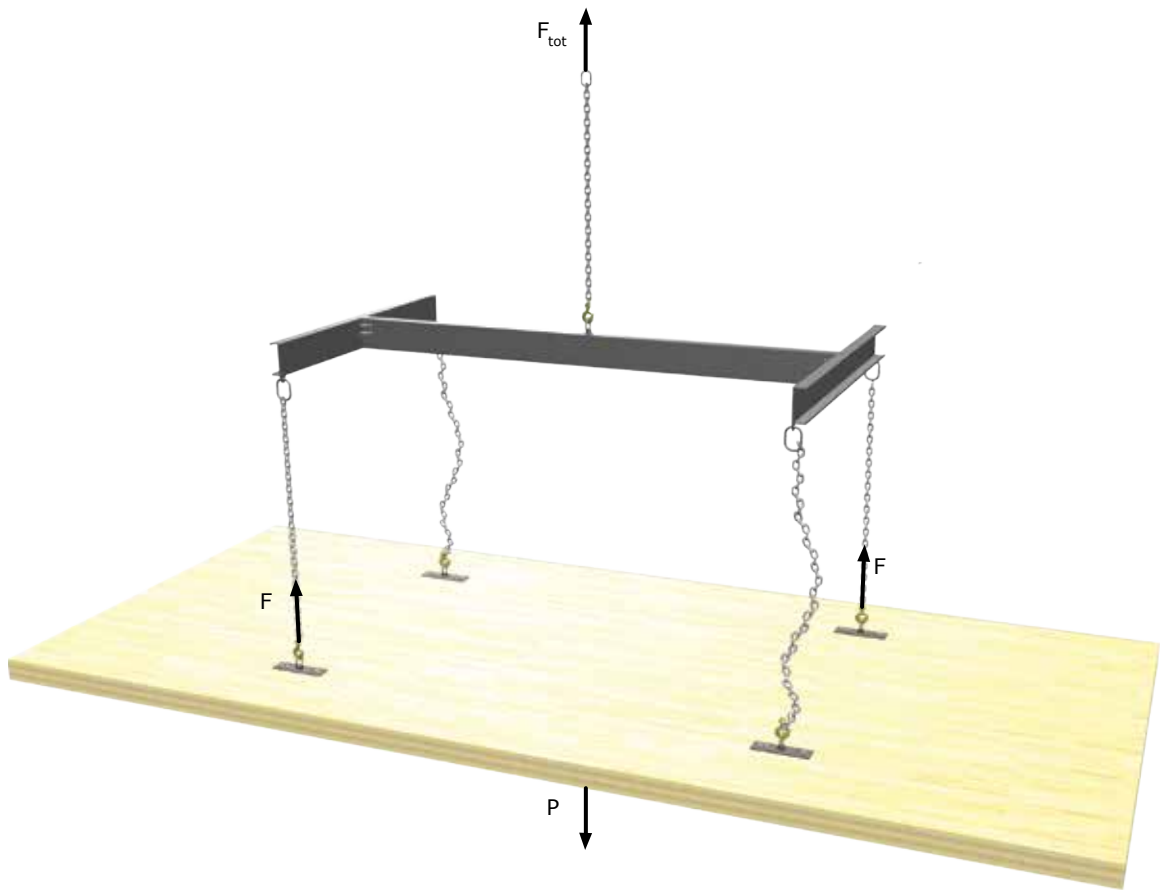

Number of effective anchors = 2

Figure 39

CLT slab lifted with four slings symmetrically positioned to the center of gravity, with single spreader, with three fixed spreaders ($N = 2$)

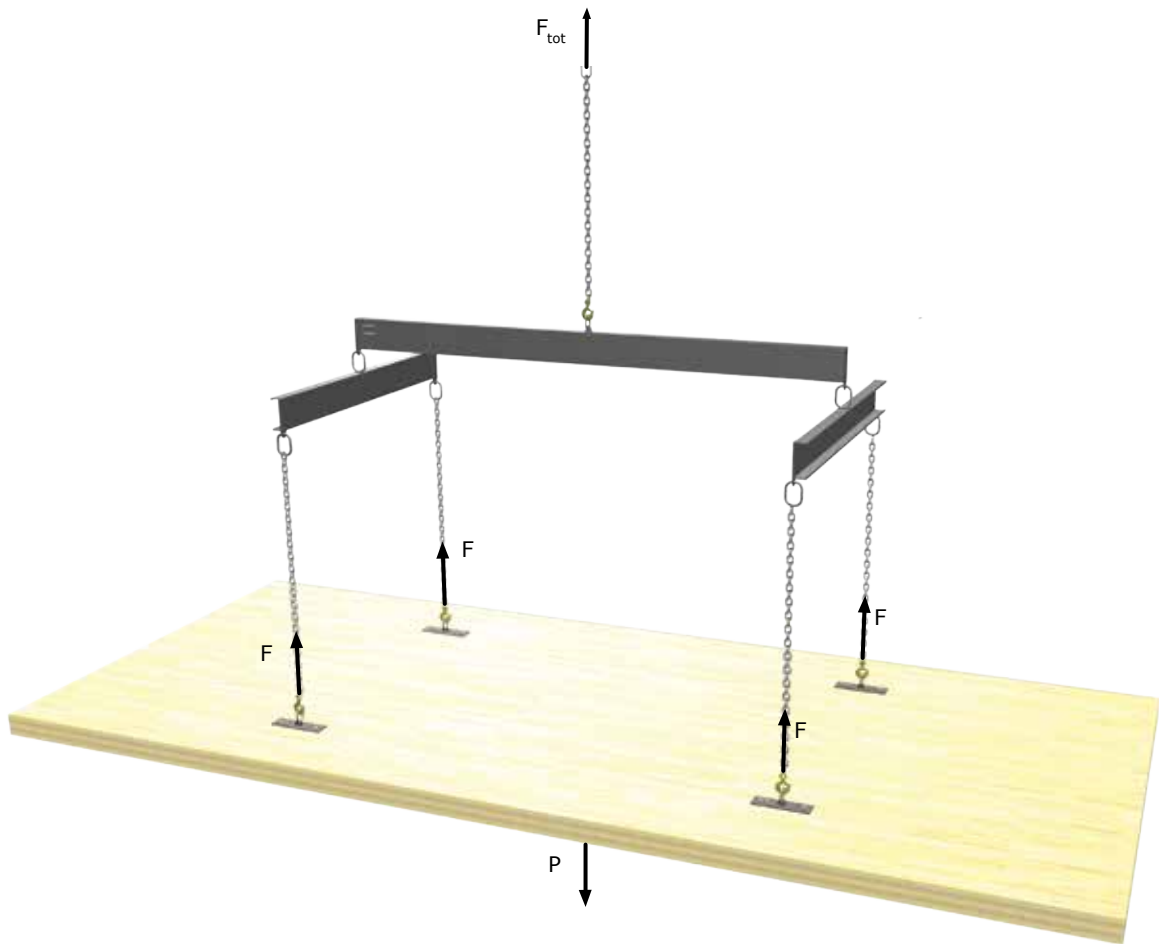

Number of effective anchors = 4

Figure 40

CLT slab lifted with four slings symmetrically positioned to the center of gravity, with single spreader, with three free spreaders ($N = 4$)

3.7 Calculation of Forces Resulting from Lifting with Anchors

The maximum forces resulting from lifting using anchors must be evaluated at each stage of lifting and handling. The maximum unfavorable value will determine the design of the lifting systems.

For example, different lifting systems can be used in the plant and on site (e.g., travelling crane in the plant vs. stationary crane on construction site). Furthermore, a component can be raised and handled in several stages and with slings of different lengths. Also, if the same lifting systems are used more than once during handling between the plant and its final destination, it may be required to use an oversize anchor to accommodate the effects of repetition.

For loads that require lifting with slings placed symmetrically to the center of gravity, force per anchor is calculated as follows:

$$F_i = \frac{F_{tot} \times f \times z}{N} \quad [5]$$

where:

F_i = Resultant anchor force (lb.)

F_{tot} = P = Total weight of assembly to be lifted (lb.)

f = Dynamic acceleration factor (Table 1)

z = Angle coefficient (Table 2)

N = Number of effective anchors (see Figures)

Finally, tensile and shear stress in anchors can be established based on the lifting angle. The anchoring system can then be correctly designed by the design professional or by the manufacturer.

Important notes:

- If anchors are not symmetrical to the center of gravity, the resultant forces must be adjusted by using the appropriate static equations (see Equations [1] and [2]).
- Other effects such as wind may significantly influence load movement on lifting systems.
- If the same lifting system is used more than once during the same handling/lifting operation, it may be necessary to adjust the allowable anchor capacity to account for previous stressing of the system.
- It is important to ensure that the calculated and provided capacities of anchorage systems are compatible.
- Laboratory tests may be required (e.g., when proprietary lifting devices are used).

4

OTHER ACCESSORIES AND MATERIALS

Numerous construction accessories and materials are required on a construction site. In this section, in addition to items and tools normally required in conventional wood construction, we suggest the following products, tools, and accessories that may be useful or essential on a construction project using CLT panels.

4.1 Fire-resistant “Rope” (Fibrous Caulking Material) and Joint Sealing Tapes

To ensure proper sealing of CLT panel joints (i.e., floor-to-floor or floor-to-wall joints), it is recommended to use products that are specifically intended for this purpose. There are a variety of acceptable products on the market.

Typically, the proposed products should perform the following in-service functions:

- Help reduce sound transmission through floors and walls;
- Ensure effective protection against fire and hot combustion gasses;
- Improve energy efficiency by reducing heat loss and by limiting air flow (for CLT elements that are part of the enclosure).

Intersecting fire resistance rated assemblies may need to have the joints or intersection protected by a fire resistance joint system complying with ASTM E1966.

Fire

Fire-resistant materials used to seal joints and openings are typically flexible. Some products are made from noncombustible mineral fiber inserted into a fiberglass wire netting. These materials must provide effective protection against fire and hot combustion gases.

Acoustics

Acoustic membranes or tapes are specially designed and formulated to effectively stop sound transmission between walls and partitions. Some suppliers also indicate that the tapes are used to control the vibrations of floor slabs (damping).

Air

To ensure air tightness, polyethylene foam-type products are often used on concrete foundation joints and on the roof. Other types of membranes (e.g., rubber-based) can be used.

Figures 41 to 43 show some examples of tight joints between CLT elements.



Figure 41
Sealing joint between floor, wall, and connectors



Figure 42
Joint between floor and wall with semi-rigid membrane



Figure 43
Joint between two floor slabs with flexible membrane

4.2 Adjustable Steel Shoring

During frame assembly, it is crucial to have the right tools at hand. Figure 44 shows adjustable steel shoring for assuring that walls are plumb. Shoring can be adjusted with screws or with steel dowels that can be placed at frequent intervals. This instrument is essential to ensure a precise angle of installation. The fastening at both ends is done with screws. If the CLT panels are to remain visible, repairs may be required when the operation is complete.

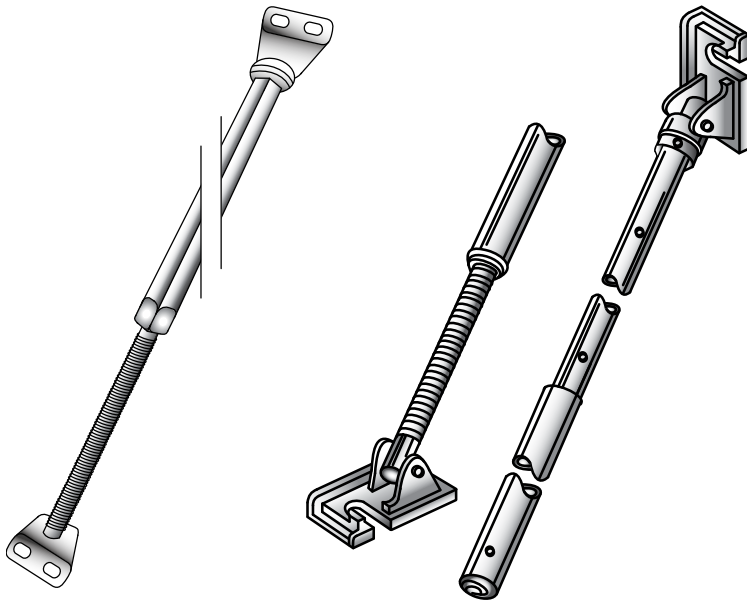



Figure 44
Adjustable shoring for walls

4.3 Beam Grip with Ratchet and Hooks

Figure 45 shows a beam grip with ratchet and hooks. This instrument is primarily used to bring the CLT panels together once they are supported and juxtaposed. It is necessary to use this type of instrument to ensure that there is proper contact between wall, floor, or roof panels. Figure 45 shows a beam grip being used to bring two floor panels together. It can be noticed that the forged hooks have been driven in line with the exterior walls that will be subsequently installed. If the floor must remain visible, it is essential to position the beam grip strategically so as not to mark the wood.

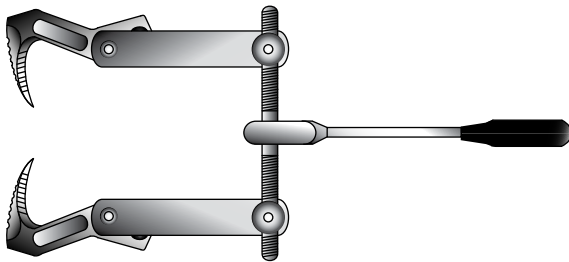

Figure 45
Beam grip with ratchet and hooks

4.4 Beam Grip with Ratchet and Screw Plate

The beam grip can also be used to ensure proper contact between two panels that are installed perpendicularly. Instead of hooks, the beam grip is used with two perforated plates. The beam grip is screwed onto the CLT wall and roof elements. The clamping is then performed and the panels are screwed to one another using self-tapping screws or other systems (refer to Chapter 5 for more information). Tightening will ensure proper contact between the elements to limit air infiltration and sound transmission. Note in Figure 46 the weatherproofing membrane used at the junction of the panels.

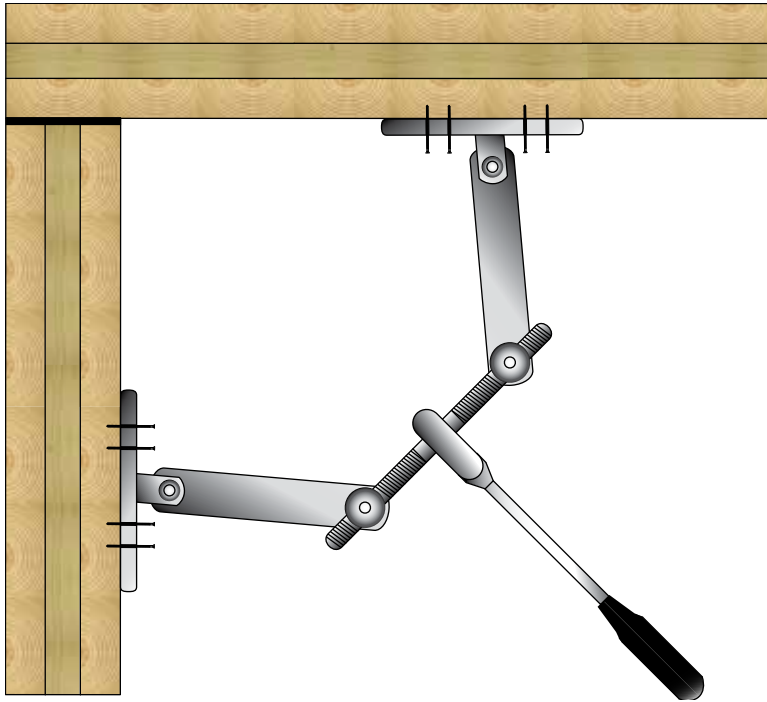

Figure 46
Beam grip with ratchet and screw plate

4.5 Manual Winch with Cables or Slings

Instead of a beam grip, a hand winch attached to cables or slings can be used to bring the CLT panels together. Figure 47 shows the system in use. Steel plates are installed on the panels with screws or lag screws. A flexible sling is used as the link between the winch and the plate. Once proper contact has been made between the panels, they are assembled using self-tapping screws or wood screws (refer to Chapter 5 for more information).





Figure 47
Manual winch used with soft slings

4.6 Steel Shims and Cement-based Grout with no Shrinkage

It is sometimes necessary to use steel shims of different thicknesses under CLT walls, at the junction of concrete foundations, for them to be perfectly square. Once the wall has been properly installed and is at a right angle, the gap is usually filled with a cement-based grout. It is imperative to use a waterproof membrane at the base between the concrete and the wood to limit the migration of water into the wood.



Figure 48

Junction between concrete foundation and CLT walls with steel winch and cement-based grout without shrinkage

5

TRANSPORTATION OF CLT ELEMENTS

Before undertaking the design of a CLT building, consideration must be taken with regards to the transportation of the prefabricated CLT elements. Transporting CLT panels can be costly and, depending on the size of the element, may require specialized transportation services. It is important to understand that the transportation of CLT panels may involve the design professional, the contractor/erector and the CLT manufacturer; therefore, the information that follows is intended to address the concerns of each of these team members as it is applicable.

As shown in Chapter 1, CLT panels can be quite large. Typical panel widths are 4 ft. (1.2 m), 8 ft. (2.4 m) and 10 ft. (3 m) while maximum lengths are dependent on the press type and may reach 60 ft. (18 m). As well, panels can be quite heavy. Because of the potential size and weight of the elements, there are two main factors regarding transportation that must be considered when planning CLT elements: highway regulations and construction site limitations.

5.1 Standard Weights and Dimension Regulations

In the United States, vehicle weights and dimensions fall under the Federal Motor Carrier Safety Regulations (FMCSR) and are regulated by the Federal Motor Carrier Safety Administration (FMCSA).

While each of the States may have varying rules and regulations for weights and dimensions, the FMCSR have been adopted by all States and take precedence over any individual State regulations. Under the Motor Carrier Safety Assistance Program (MCSAP) and the Safety Management System (SMS), the FMCSA allows certain roads and bridges to be restricted from truck travel if the size and weight of such roads and bridges will not safely accommodate commercial vehicles. Keep in mind that States are allowed (and many do) to set more liberal or more stringent weight and dimension restrictions within their jurisdictions and may also require special permitting for loads considered over dimensional or those that exceed the maximum allowable gross vehicle weight rating. The motor carrier being selected should have previous experience in safely securing and transporting flatbed shipments and efficiently handling cross border traffic. Motor carriers may be called upon to deliver in any State within the United States, so they must have operating authority in the U.S. territory and be familiar and comply with State and federal regulations governing interstate motor carriers.

It is also recommended that the motor carriers' Compliance, Safety & Accountability (CSA) record be reviewed prior to contracting for the movement of products. A motor carrier's safety record is available online through FMCSA's website and can be searched by either the motor carriers name or their assigned Department of Transportation (DOT) number.

In Canada, vehicle weights and dimensions (W&D) fall within provincial jurisdictions and limits vary from province to province. However, the provinces and territories have agreed on National Standards for the weight and dimension limits of heavy vehicles used in interprovincial transportation. These are contained in a Federal/Provincial/Territorial Memorandum of Understanding (MOU). Under the terms of the MOU, each of the

provinces and territories will permit vehicles which comply with the appropriate weights and dimensions described in the agreement to travel on a designated system of highways within their jurisdiction. Keep in mind, however, that the provinces are allowed (and many do) to set more liberal W&D within their jurisdictions. More information on the MOU may be obtained by visiting the Council of Ministers Responsible for Transportation and Highway Safety website.

5.1.1 Dimension Limits

In terms of dimension limits, here are the main points with regard to road vehicles (according to dimensional limits applicable to the U.S. territory, which are slightly more restrictive than Canadian limitations):

- Vehicle height, including load, is limited to 13'6" (4.11 m);
- Vehicle width, including load but excluding load covering or securing devices, cannot exceed 8'6" (2.6 m);
- Semi-trailer length, including load, cannot exceed 53' (16.15 m).

The FHWA website discusses in detail the size and weight limitations of commercial motor vehicles.

Figure 49 presents these limits in a graphical format.

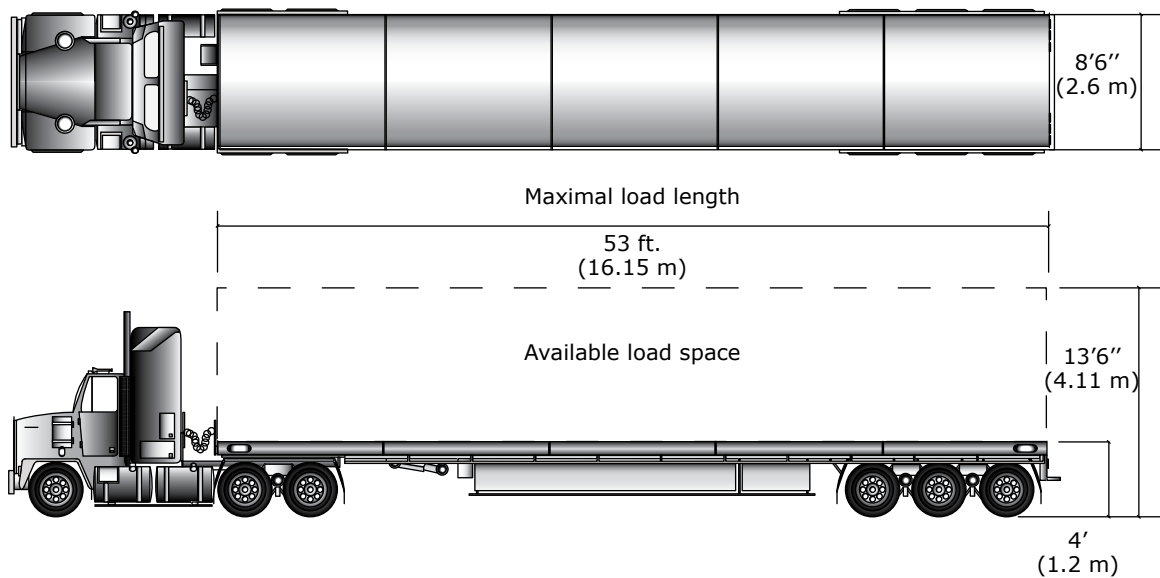

Figure 49
Available load space on a flatbed semi-trailer

Exceptions

Some States allow what are called over dimensional loads to be hauled with special restrictions and permitting. Over dimensional loads (or OD loads as they are commonly referred to) generally require a minimum of the following:

1. OD loads may consist only of indivisible products. Definitions and exceptions to this rule may be found by visiting the FHWA website.
2. OD loads may, in most cases, only be transported during daylight hours.
3. Special vehicle markings are typically required with placards or banners showing oversized or over width loads.
4. Special permits must be ordered from each State well in advance with specific routes traveled being strictly adhered to.

5. Some OD loads may require a safety escort service to lead and, in some cases, follow the OD load, depending on the required routes to be traveled.

Motor carriers with experience transporting OD loads are responsible for obtaining the proper markings, permits and any safety escorts to comply with all federal, State and other municipality rules and regulations.

The majority of CLT panels will be transported by the use of a flatbed semi-trailer (Figure 50). These trailers have the advantage of being open on all sides, which facilitates loading, and having a continuous deck space from front to back. Given that the normal height off the ground of the deck of a flatbed semi-trailer is about 4'11" (1.51 m) (at the front of the trailer, which is the highest point), this permits load heights of 8'6" (2.6 m). Overall, this means that a CLT load, comprised of one or more elements, must fit into a box with a height of 8'6" (2.6 m), a width of 8'6" (2.6 m), and a length of 53' (16.15 m) if it is to be transported by a flatbed semi-trailer. This type and size of trailer is the most commonly utilized in the United States while some motor carriers still have 48' (14.6 m) length trailers in their fleet. It is recommended, when ordering a truck, to be specific about your length requirements.

For taller structures, drop deck (also called step deck) semi-trailers can also be used. However, as can be seen in Figure 51, unlike flatbed semi-trailers, the deck of a drop deck is not continuous. A drop deck flatbed with smaller 255/70R22.5 type tires (but still using normal axle hubs and brakes) can be used to allow a 9'10" (3 m) tall load on the rear 42' (12.8 m) section and a 8'6" (2.6 m) tall load on the front 11' (3.35 m) section.

Other semi-trailers with even more load height are available, such as double drop decks (Figure 52), but they can be difficult to load, and the deck is divided into three sections with the lowest section having a length of about 29'6" (9 m) and a deck height of 1'9" (0.55 m), allowing products of up to 11'8" (3.56 m) in height.

Although all of these semi-trailer types can be as long as 53' (16.15 m), many are 48' (14.63 m) in length. The dimensions given here are presented as guidelines.

IMPORTANT: It is important that you check with your transportation provider to verify the dimensions of their vehicles before going forward with any transportation plan.

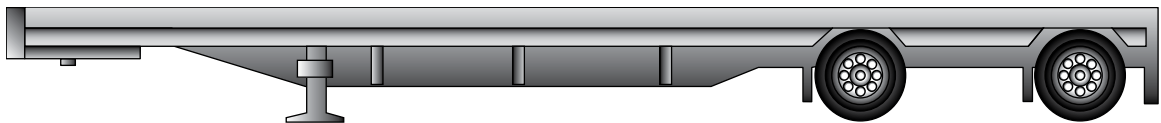

Figure 50
Flatbed semi-trailer

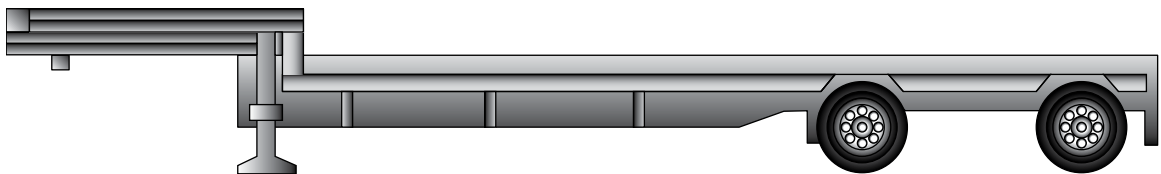

Figure 51
Drop deck semi-trailer



Figure 52
Double drop deck semi-trailer

5.1.2 Weight Limits

When it comes to weight limits, the situation is more complex since the CLT panels may be crossing the U.S./Canada border and weight limits and axle configurations vary between the United States and Canada. Legal Gross Vehicle Weight (GVW) is the weight of the vehicle and its load. Legal GVW varies not only by province in Canada, as previously mentioned, but also by the type of vehicle, the number of axles on the vehicle, and the distance between the axles. Nonetheless, a simplified picture can be drawn. When delivering within Canada, 6-axle semi-trailer combinations (e.g., a tandem drive tractor with a 3-axle semi-trailer) can be used in every jurisdiction although at different allowable GVWs. In the United States, tractor/semi-trailer combinations are limited to 5 axles.

Table 3 presents the maximum payloads authorized with 5- and 6-axle flatbed combinations by jurisdiction, taking into account the typical tare weights for these units (14.5 t {29,000 lb.} for a 5-axle unit and 16 t {32,000 lb.} for a 6-axle unit) and the legal GVW in each jurisdiction. It should be kept in mind that these are only guidelines. It may be possible to have higher payloads with some of the superlight trailers available on the market. Also, trucks are limited in the amount of weight that different individual axles or axle groups can carry. With odd-shaped loads, it is often difficult to distribute the load properly between axles and thus the legal GVW cannot be obtained while maintaining legal axle or axle group weights.

Table 3

Maximum payloads by jurisdiction for 5- and 6-axle tractor/semi-trailer combinations (t)

Jurisdiction	5-axle Combinations	6-axle Combinations
United States	23.3 (46,600 lb.)	N/A
MOU*	26.5	32
Atlantic Provinces and Quebec	28.5	35
Ontario†	28.5	36.6

* Manitoba, Saskatchewan, Alberta and B.C. limits all follow the MOU

† Although higher GVW may be allowed in the regulation, we have included the highest practical GVW

5.1.3 Other Canadian Legal Configurations

Quebec also allows the use of 4-axle semi-trailers while Ontario allows 4- and even 5-axle semi-trailers with much higher payloads. Given that these vehicles cannot travel outside their jurisdictions, we have not presented payload maximums for these types of units. As well, the Canadian MOU allows the use of 8-axle B-train units (a tractor pulling two semi-trailers; see Figure 53) at a GVW of 62.5 tons. However, the length of both trailers combined is 65'7" (20 m), with a lead trailer typically having a deck length of 32' (9.75 m) and a rear trailer with a deck of 27'10" (8.5 m). Because each trailer unit articulates separately (steering and suspension systems), a load cannot span from the deck of the lead unit to the rear unit. As such, the longest panels that super B-trains can accommodate are 32' (9.75 m). Typical tares are in the range of 18 t (36,000 lb.), so loads of up to 44.5 t are possible. Gross vehicle weight in the U.S. is 80,000 lb. or 40 t.

Different possible configurations are also available in the United States, the most common being spread tandem axle semi-trailers. In these configurations, the space between the two axles of a tandem group is increased from the standard 48 inches to a space reaching up to 121 inches.

Figure 54 presents a typical U.S. motor carrier flatbed with spread axle configurations and a 53' trailer



Figure 53
Super B-train flat deck combination



Figure 54
U.S. motor carrier flatbed

5.2 Oversize and Overweight Permits

In every U.S. and Canadian jurisdiction, oversize and overweight permits are required when the dimensions or weight of a vehicle exceed the normal limits permitted by legislation. Larger CLT panels may exceed these dimension limits and a truckload of panels may also cause the vehicle to exceed the legally allowable Gross Vehicle Weight. Keep in mind that these permits are only available for indivisible loads.

The regulations, permitting, and logistics of oversize and overweight transportation are quite complex. The planning and organization of such hauls is best left to the CLT manufacturers and transport companies that specialize in this type of work. If it is determined that CLT elements do not fit in the standard legal dimensions or weights described in Section 5.1, it is important to contact one specialist. For more information on oversize and overweight permitting, refer to local State or provincial authorities. A complete understanding of the size and weight limits as well as State by State lists may be obtained on the U.S. Federal Highway Administration website.

5.3 Construction Site Limitations and Considerations

Transporting CLT elements to the construction site is only part of the challenge. The construction site itself may have restrictions that are more limiting than weights and dimension regulations. First off, the contractor, working in conjunction with the CLT manufacturer and their selected transport company, must ensure that the route from the plant to the construction site will allow movement of the truck, including its load, without any obstacles being in place that would interfere with the transport of the CLT panels. This is especially critical for oversize loads.

A common problem at construction sites occurs when a long trailer arrives and the width of the driving space (which was fine for a shorter truck) does not allow enough clearance for the off-tracking of the rear trailer wheels when a short radius turn is needed. Moving a fence, a shed or piles of materials, for example, to make driving space changes can disrupt and delay deliveries and increase costs.

This can be a challenge when working in tight urban areas where the space for storing building materials and the allowance for turns is very limited. The off-tracking is a function of the sum of the squares of the vehicle combination wheelbases so an extra-long trailer will intrude inward on a tight turn much more than shorter wheelbase trailers. A data chart and other methods to estimate off-tracking (SAE J 695) are available to the Society of Automotive Engineers.

Awareness of local city regulations and pre-planning to match construction site challenges are advisable to ensure a smooth efficient delivery without delays and cost overruns.

5.4 Other Transport Considerations

It is a large advantage for the design professional working in concert with the CLT manufacturer to design the loads to fit on normal equipment, which allows the option to use for-hire carriers to deal with long distance one-way hauls where many loads must arrive and be staged at a jobsite within a close period of time. It also reduces the vulnerability by having access to replacement vehicles when a specialized vehicle has downtime and to deal with swings in demand.

When normal flatbeds are used, it is generally best to lay the load horizontally for easiest tarping and to have the load center as low and stable as possible for safety and load security. Tarping and load tie-down requirements must take into account the fact that federal safety regulations limit the height at which workers can work without a fall restraint system to 10' (3 m) off the ground and that many drivers are not willing to climb up high to manually tarp a difficult load because of the safety risk.

Having each lift of CLT wrapped in a waterproof package can be helpful as long as it has a way to drain trapped water and breathe out condensation at the bottom in case the wrapping gets damaged during handling or in case there is an air void that allows condensation to accumulate. It is best to also have a physical tarp over the load as the primary protection against rain, ice and debris.

In addition to the general standards described here, U.S. federal law includes provisions, exemptions, and variations applicable to particular States, routes, vehicles, or operations. For more details, please consult 23 CFR Part 658, available on FHWA's Office of Freight Management and Operations website.

6

POSITIONING OF MATERIALS ON CONSTRUCTION SITE AND PROTECTION AGAINST WEATHER

6.1 Positioning of Materials on Construction Site

Once the materials have been delivered to the construction site, wood-based building materials must be stored properly if they are not used immediately. Good planning is essential to ensure that materials have the necessary space and proper logistics control during construction as there are costs associated with handling each piece or shipment.

If panels must be placed temporarily on the ground prior to use, great care must be taken to protect them against weather elements and vandalism. The panels must be installed on skids at least 6 inches above the ground; skids must be in sufficient numbers to protect panels from water runoffs and appropriate tarpaulins should be used to protect them from direct exposure to the elements.

Figure 55 shows CLT panel packs in the process of being unloaded from a truck for storage on site. The packs are completely wrapped (six faces) and are deposited on wood skids to protect them from water runoffs. Although this packaging practice may be adequate, it is recommended that high-quality tarpaulins are also used. Every effort should be made to ensure that the packs remain sealed since, if there are openings, water could infiltrate and become trapped. Therefore, the bottom of the wrapping must be slit at the jobsite to permit any moisture that may become entrapped to escape. Also, CLT bundles should be stacked properly to avoid overloading the lower assemblies. Skids must be properly aligned to ensure load transfer from one bundle to another.

Figure 56 shows a truck platform left on construction site. It will be recovered on the next trip. This can reduce costs by allowing independent scheduling of transportation and unloading.

Finally, it should be noted that the stacking of the panels on the construction site should match the planned installation sequence when possible. Unnecessary handling leads to additional costs and risks of accidents or damage.



Figure 55
Storage on construction site – individually wrapped bundles stacked on lumber skids



Figure 56
Truck platform left on construction site – it will be recovered on the next trip

6.2 Construction Load on Frame

Stacking and storage of CLT elements or other heavy materials must be made while taking into account the maximum anticipated loads for the building. If assemblies need to be placed on the construction frame, ensure that the provisional loads do not exceed the engineer's expected loads during construction.

It is recommended that CLT slabs be placed flat on the frame so they are not exposed to winds. Skids in sufficient numbers and at regular intervals should be placed between panels (see Figure 57).



Figure 57
CLT slabs temporarily stored on a floor

6.3 Temporary Protection During Construction

As indicated in section 6.1, the wood components should be protected as much as possible against the elements during frame set-up operations. The CLT components are primarily intended for use in dry conditions with limited exposure to water, so they should be protected from direct rain, snow and ice, especially from long exposure to these elements. Otherwise, the wood may become discolored or dirty during construction.

In addition, due to the hygroscopic nature of wood, CLT panels may vary slightly in size during construction due to swelling if exposed to the elements and problems can occur at joints. For example, connections can be difficult to perform on the construction site, especially if accuracy is important.

There are some effective techniques used to provide adequate protection against weather elements during frame set-up operations. Figures 58 to 60 show techniques used mainly in Europe to protect components from the weather during construction. While these erection techniques are not commonly used in the United States, there could be applications where such protection could be beneficial.

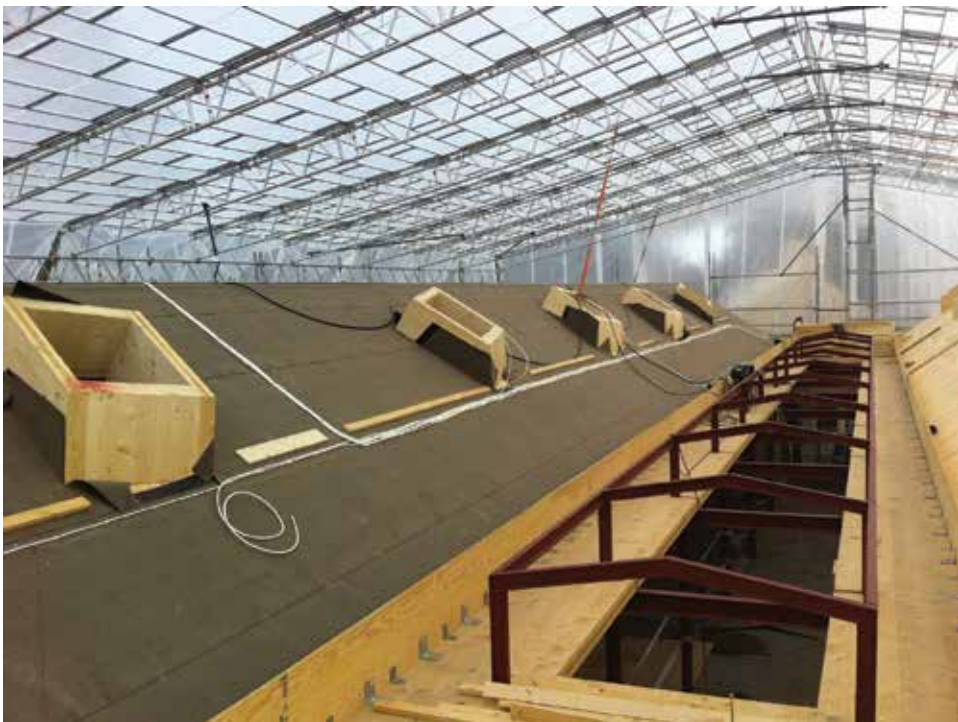

Figure 58
Use of a temporary tarpaulin (courtesy of Fristad Bygg, Sweden)



Figure 59
Use of a water-proof tarpaulin outside scaffoldings – Germany



Figure 60
Use of an adjustable tent – Sweden

7

REFERENCES

American Wood Council (AWC). 2012. *National design specification (NDS) for wood construction*. 2012 ed. ANSI/AWC NDS-2012. Leesburg, VA: AWC.

Canadian Centre for Occupational Health and Safety (CCOHS). 2010. *Materials handling: Lifting with eye bolts*. http://www.ccohs.ca/oshanswers/safety_haz/materials_handling/eye_bolts.html.

Canadian Council of Motor Transport Administrators (CCMTA). 2005. *Driver's handbook on cargo securement*. http://www.ccmta.ca/english/pdf/cargo_driver_handbook.pdf.

Council of Ministers Responsible for Transportation and Highway Safety. 2011. *National standards for heavy vehicle weights and dimensions*. <http://www.comt.ca/english/programs/trucking/standards.html>.

Gagnon, S. and C. Pirvu, eds. 2011. *CLT Handbook : Cross-laminated timber*. Canadian ed. Special Publication SP-528E. Québec, QC : FPInnovations. 1 v.

Society of Automotive Engineers (SAE). 2011. *Turning ability and off tracking: Motor vehicles*. SAE J695. Warrendale, PA: SAE. 13 p.

U.S. Department of Agriculture. Forest Products Laboratory (FPL). 2010. *Wood handbook: Wood as an engineering material*. Madison, WI: FPL. 1 v.

U.S. Department of Labor. Occupational Safety and Health Administration (OSHA). 2012. OSHA. <http://www.osha.gov/>.

U.S. Department of Transportation. Federal Highway Administration (FHWA). 2011. *Federal size regulations for commercial motor vehicles*. http://ops.fhwa.dot.gov/freight/publications/size_regs_final_rpt/index.htm#tts.

U.S. Department of Transportation. Federal Highway Administration (FHWA). 2012. *Oversize/overweight load permits*. http://www.ops.fhwa.dot.gov/freight/sw/permit_report/index.htm.

U.S. Department of Transportation. Federal Motor Carrier Safety Administration (FMCSA). 2012. *Safety and Fitness Electronic Records (SAFER) System*. <http://safer.fmcsa.dot.gov/CompanySnapshot.aspx>.



570, boul. St-Jean
Pointe-Claire, QC
Canada H9R 3J9
514 630-4100

www.fpinnovations.ca



Forest Products
Laboratory

1 Gifford Pinchot Drive
Madison, WI
USA 53726
608 231-9200

www.fpl.fs.fed.us

BSLC

Woodland Softwood Lumber Council

P.O. Box 45029
Ocean Park RPO
Surrey, BC
Canada V4A 9L1
604 536-7730

www.softwoodlumber.org

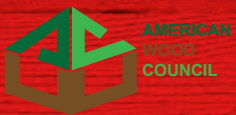

222 Catocin Circle SE
Suite 201
Leesburg, VA
USA 20175
202 463-2766

www.awc.org



7011 S 19th Street
Tacoma, WA
USA 98466-5333
253 565-6600

www.apawood.org



WoodWorks

1111 19th Street NW
Suite 800
Washington, DC
USA 20036
866 966-3448

www.woodworks.org



Forestry Innovation Investment

1130 West Pender Street
Suite 1200
Vancouver, BC
Canada V6E 4A4
604 685-7507

www.bcfii.ca