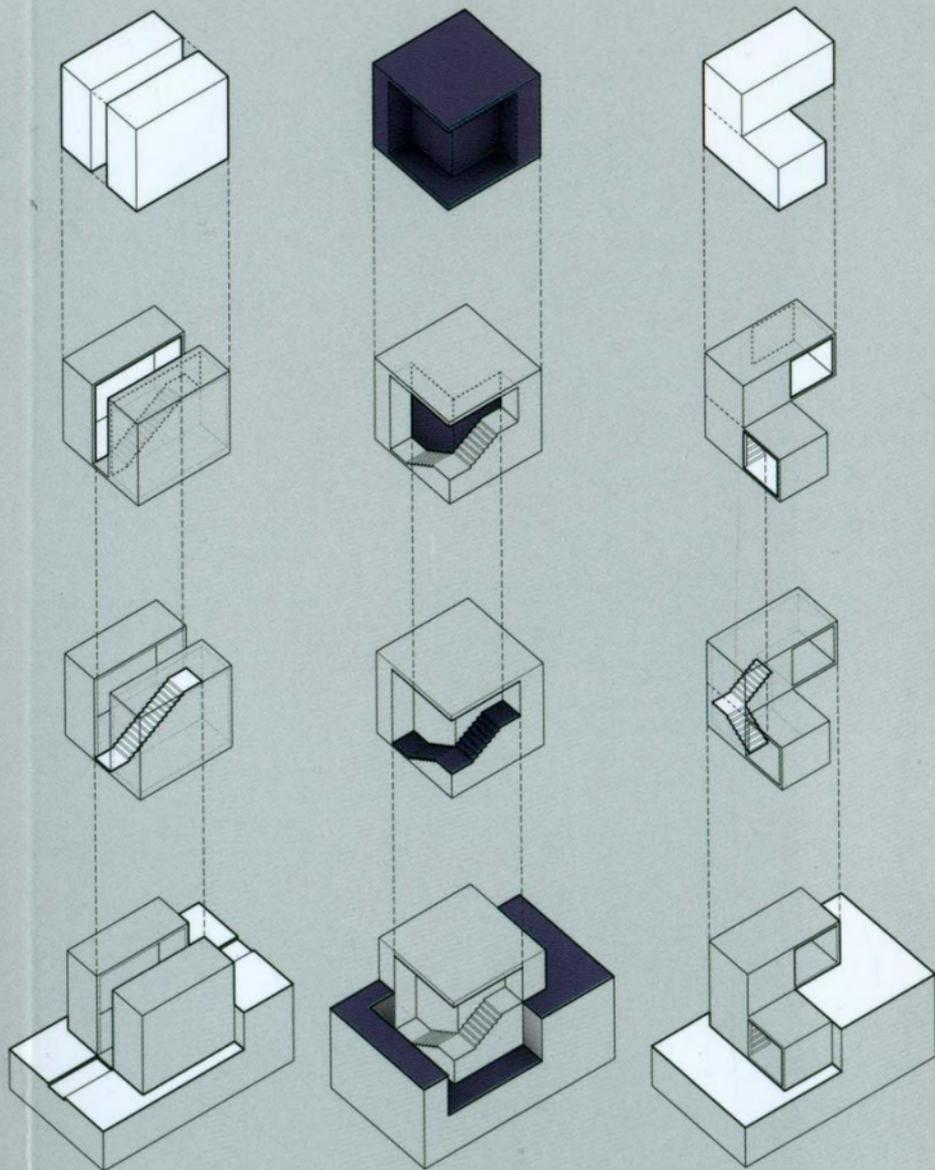


CONDITIONAL DESIGN

An Introduction to Elemental Architecture

Anthony Di Mari



Di Mari, Anthony

Conditional Design: An Introduction to Elemental Architecture

BIS Publishers
Het Sieraad Building
Postjesweg 1
1057 DT Amsterdam
The Netherlands

T +31 (0)20 5150230
F +31 (0)20 5150239
bis@bispublishers.nl
www.bispublishers.nl

ISBN: 978-90-6369-365-7

Copyright © 2014 BIS Publishers and Anthony Di Mari

All rights reserved. No part of this publication may be reproduced or transmitted in any form or by any means, electronic or mechanical, including photocopy, recording or any information storage and retrieval system, without permission in writing from the copyright owners.

While every effort has been made to trace all present copyright holders of the material in this book, any unintentional omission is hereby apologized for in advance, and we should of course be pleased to correct any errors in acknowledgments in any future editions of this book.

The drawings in this book are entirely the work and interpretation of the author, based on publicly available information on the works represented.

CONDITIONAL DESIGN

An Introduction to Elemental Architecture

Anthony Di Mari

BISPUBLISHERS

6

Foreword

8

Introduction

16

Conditions

84

Combinations

112

Aggregations

132

Implementations

Foreword

Since publishing *Operative Design: A Catalogue of Spatial Verbs*, Anthony and I have had the opportunity to test ideas from the book hands on, working with design students through various studios and workshops. In employing the concepts from *Operative Design* as a pedagogical approach, we saw a natural progression toward creating a framework that could highlight the various conditions that were being created through the volumetric operations. As students' work became more sophisticated and complex, moving beyond the abstract volumetric studies, a new catalogue of these conditions/opportunities began to emerge. These ideas show how one could continue using the logic developed in *Operative Design* in order to further develop an architectural proposal.

The conditions shown in this book are also a set of iterations and design possibilities, set to instigate further study and exploration. They are directly tied to the original volumetric manipulations, but push it one step further -- seeing what those original operative verbs can yield, within an existing spatial condition, and what new conditions they themselves could create, through the addition of an aspect we deliberately kept abstract in the first book: the factor of scale.

Conditional Design translates scale through three basic architectural elements: vertical circulation, apertures, and site. These three elements are each fundamental to architecture in that they inherently connect constructed space back to the individual experiencing it. In essence, all three are about connection - connection within spaces, connection from within a space to without, and connection between a space and its surrounding site. I see *Conditional Design* as a natural continuation to the discussion started by *Operative Design* in that it proposes a bridge between abstract volumetric operations and what those operations could yield, through responding to programmatic requirements and given site conditions within a consistent methodology.

It should be noted that this is but one follow-up continuation to the large, abstracted base we began to construct in *Operative Design*. The fundamental basis of *Conditional Design* is its proposed use as a tool; it is meant to be an

approach, not definitive or defined, that can be applied iteratively for various uses, conditions, and needs.

For those learning about spatial design, it emphasizes the deliberation inherent in how a designer makes design moves, and what those moves yield: it connects the design process with the character of the space created. As a designer, this is what I find most exciting about this book -- that it continues to delineate the various paths we can use as we approach a given project, beginning from abstract spatial play, to balancing program and site, in order to create truly intriguing, complex, and inspiring spaces.

Nora Yoo
June 2014

Introduction

This book is a natural sequential project to *Operative Design: A Catalogue of Spatial Verbs*. In *Operative Design*, spatial formation was construed as a process that could be derived from fundamental actions, and the book indexed a lexicon of illustrated verbs to activate architectural inquiry and to ignite the design process. This book builds squarely upon that base.

Spatially, the conditional is the result of the operative. As one manipulates volumes with operative verbs, different spatial conditions start to emerge. At that moment of volumetric manipulation, the designer is presented with an opportunity to consider one of several conditional opportunities: to connect one volume to another volume, to open the volume to receive light or entry, and to situate the volumes in relation to a ground plane, or consider how the set of manipulated volumes relate to and affect the ground condition.

For example, when two volumes are arranged to **overlap** with each other, one volume rests atop the other, and there is an interior zone that both volumes share as a result of the operation. Within that zone, one can establish the connection between both volumes. The operation has yielded both a formal strategy and revealed the connection between the volumes; simultaneously, the spatial moment defined by the operation allows the designer to consider the internal qualities of the design move they have just created. When one **carves** away at a volume, the act of removing a part of the volume allows the designer to question and at the same time confirm that this move sets up another spatial opportunity, to create apertures in the area of the subtraction, for example.

This systematic approach minimizes random placement of these elements and integrates them with a design method. One should still be critical of such methodical moves, because design should still be responsive to conditions outside of volumetric operations, including program, light, and access. These manipulations might react to an already existing condition or create a new set of conditions based on the operation and the ground plane. As a method, conditional design is a bridge between abstract volumetric manipulations and design that considers program, site, scale, and structure.

Elemental Architecture : Code + Character

By setting up a systematic process, opportunities for a focused design are facilitated by a set of deliberate moves. This can be referred to as a code of design and an attempt to develop a design methodology. In using the word code, the key goal is not a clear legibility of form, but a clear legibility of process. The design logic that results from the systematic approach creates consistency in the process and, ideally, the result. This does not suggest anything short of multiple iterations, for the system contains a variety of design conditions based on the original operations. It is a system of options. As in *Operative Design*, *Conditional Design* is in search of variation through a directed working method, which in turn can be used as a basis upon which to critique the design.

Ultimately, the end design relates back to the actual spaces that are created, and how one would experience the volumetric manipulations. The conditional moves allow for the incorporation of elements such as light, ground, and circulation, while acknowledging and addressing the experience of these spaces in the context of existing conditions and constraints of a design project.

Revisiting Planes: Connection + Aperture + Ground

Conditional Design takes the original volumes from *Operative Design* and considers them as planar constructs. In this sense, *Conditional Design* will stray from its spatially abstract predecessor. *Operative Design* presented opportunities to iteratively study volumetric relationships. In order to further understand these volumetric studies, it is imperative to give the volumetric envelope a scale. The operations still stand as isolated moments initially, and eventually build upon themselves through combinations and aggregations, with the focus now on the planes comprising the volumes as they start to craft spatial character. The type of operation (single, multiple, add, displace, or subtract), again helps to index how these various conditions are created, while highlighting the iterative operative process. With this focus now on the volume planes, the interior of the volumes is considered, as well as the resultant interior/exterior dynamic.

The reading of planes extends to that of the ground plane. As *Conditional Design* begins to explore the relationship of volumetric manipulations to the ground, it instigates further study on how the original operations can enhance or generate new ground conditions. Each design move has the potential to consider the ground. Steven Holl's *Correlational Programming*¹ diagrams inspire a unique understanding of four ground conditions: on the ground, in the ground, below the ground, and above the ground. *Conditional Design* will elaborate on several of these conditions through iterative operations.

The basic planar elements of stairs, apertures, and the abstracted ground are not to be interpreted as absolute or literal in their representation. Rather, the aim of introducing these spatial elements is to highlight the conditional opportunities yielded by the original operative moves.

Combinations + Aggregations

With the foundation that verbs can be combined or one could operate multiple times using the same verb to develop several conditions, the combinations herein will focus on the highlighted conditions of aperture, connection, and the ground. There could be more than one occurrence of the operation in a given set of volumes, one operation could be used to explore multiple conditions, or one could explore distinct conditions through different operations. By using multiple design moves under the onus of a single operation, design consistency is established, especially when conditions are considered. For example, several **shifts** could produce multiple openings, or one could use the operation to create both openings and connections. By combining multiple operations, one could also expand on this consistency and develop a design hierarchy.

Once a condition is determined, the base volumes can be aggregated to study the multiplication of the condition. Any of the base aggregation operations - **array, stack, pack, reflect, join** - can be used to explore the potential of the series of conditions. For example, a connection is formed at the moment when multiple volumes **overlap**, so one could vertically aggregate the module by **stacking** the overlapping volumes while connecting each level of the massing.

¹ Steven Holl, 'Correlational Programming' in *Parallax*. Princeton. New York 2000.

Implementations

The operative approach provided not only a working method based on formal iteration, but also an opportunity to interpret existing built work. By further exploring volumetric manipulation at the scale of architecture, the conditional is present where formal moves are complemented by elements such as a connection between volumes or an opportunity for opening. The manner in which these volumes relate to the ground also refines these spatial ideas and moves them toward creating architecture.

When considering the assembly of multiple programmatic volumes, conditional moves can also begin to organize program. The connective element might delineate an area of utility versus a space of dwelling. Recall Pezo von Ellrichshausen's Poli House from *Operative Design*. The **offset** volume creates a perimeter thickened with program and utility. Through this operation of **offset**, Pezo von Ellrichshausen develops an overall volumetric manipulation, as well as local conditions within this larger move. Another project, the Wolf House, is a clear example of an **expanded** volume that is systematically formed while maintaining a clear organization of program. Along with the stairs, the operation creates a zone for service-based program (i.e. bathroom, utility, and mechanical spaces), while also defining dwelling spaces (living areas, bedrooms). This clear organization is clarified through the design move, or operation, **expand**. Pezo von Ellrichshausen handles these simple volumetric manipulations effectively, creating opportunities for circulation, a logic for openings, and careful consideration of the site. Solo House explores a clear design strategy through **lift** when circulation is created through this volumetric operation, in addition to highlighting how the original volumes relate to the ground.

These projects serve as strong examples of clear design logic, functional groupings of program, clean details, and overall consistency. As the program requirements, site, and general scale becomes specific to each project, the consideration of conditions becomes more significant.

Conditional Design can thus be useful as an interpretive device. Interpreting the implementations through the lens of *Conditional Design* allows one to appreciate the careful handling of spatial connections, openings, and site considerations unique to each project.



Solo House
Operation - Lift
Condition - Ground + Connect

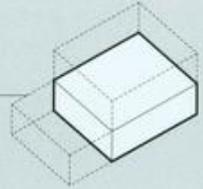
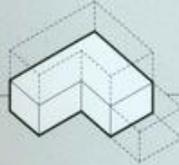
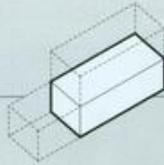


Poli House
Operation - Offset
Condition - Connect + Open

Photos by Cristóbal Palma

Base Volumes + Elements

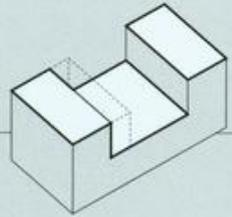
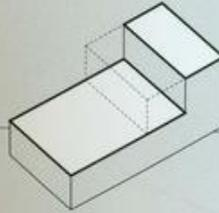
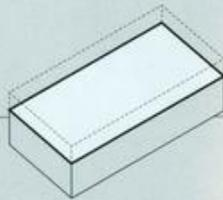
Variations on Base Volumes



Element - Connection



Element - Ground



Element - Opening



Connect

Expand

Nest

Split

Interlock

Lift

Overlap

Shift

Carve

Fracture

Extract

Ground

Expand

Merge

Split

Interlock

Intersect

Lift

Overlap

Shift

Carve

Extract

Open

Extrude

Branch

Split

Intersect

Lift

Shift

Carve

Fracture

Embed

Extract

Connect

Expand

Nest

Split

Interlock

Lift

Overlap

Shift

Carve

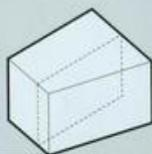
Fracture

Extract



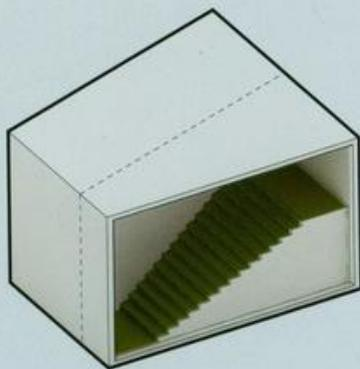
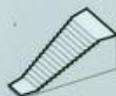
Expand

Condition | Connect

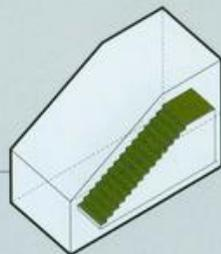


Operation - Expand

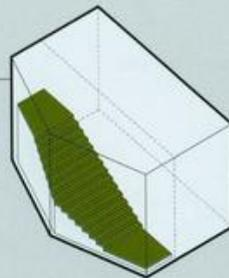
Condition - Connect



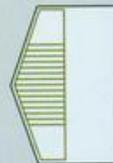
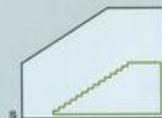
Vertical - Expand



Horizontal - Expand

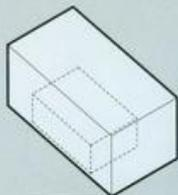


Variations



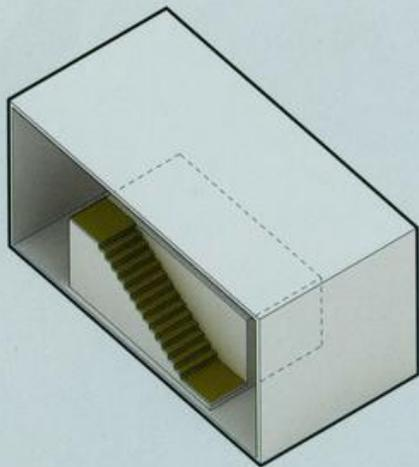
Nest

Condition | Connect

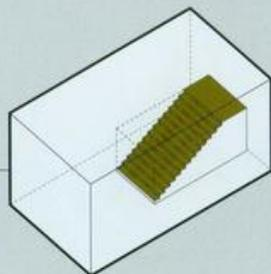


Operation - Nest

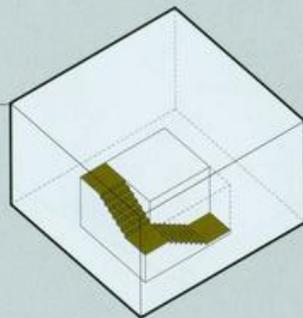
Condition - Connect



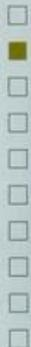
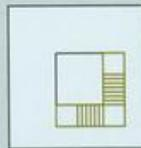
Horizontal + Vertical - Nest



Horizontal + Vertical - Nest

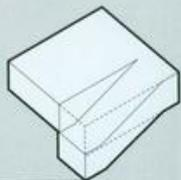


Variations



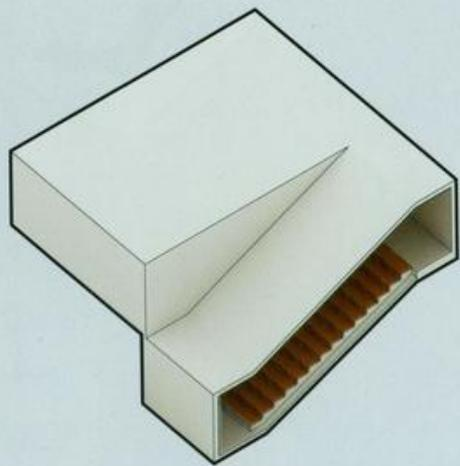
Split

Condition | Connect

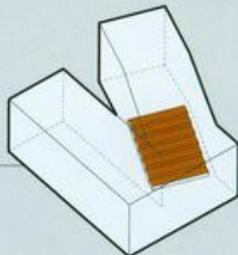


Operation - Split

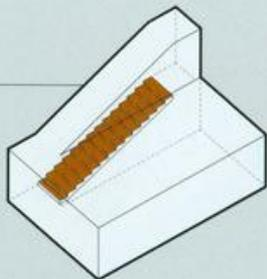
Condition - Connect



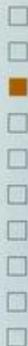
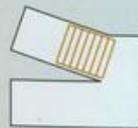
Horizontal + Vertical - Split



Vertical - Split

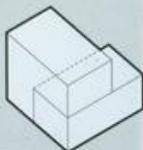


Variations



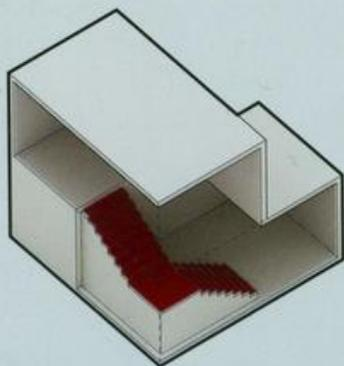
Interlock

Condition | Connect

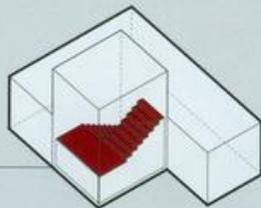


Operation - Interlock

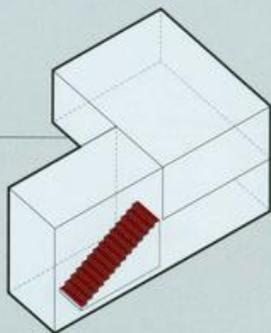
Condition - Connect



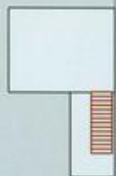
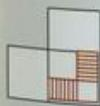
Horizontal + Vertical - Interlock



Horizontal + Vertical - Interlock



Variations



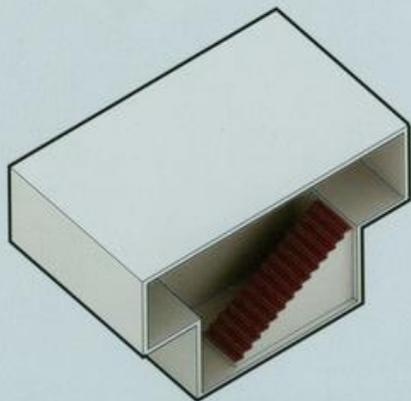
Lift

Condition | Connect

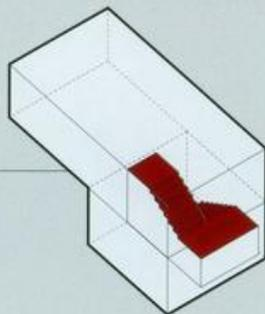


Operation - Lift

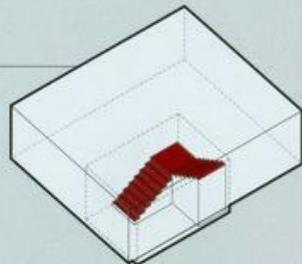
Condition - Connect



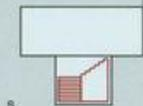
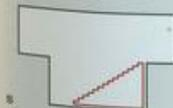
Vertical - Lift



Vertical - Lift

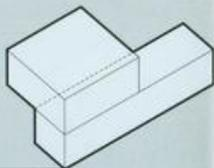


Variations



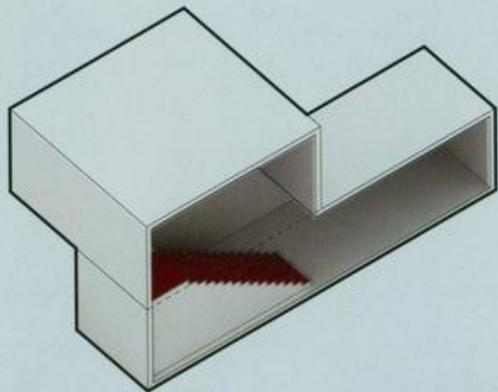
Overlap

Condition | Connect

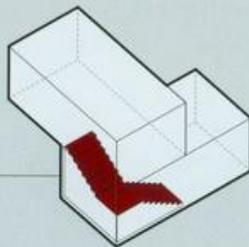


Operation - Overlap

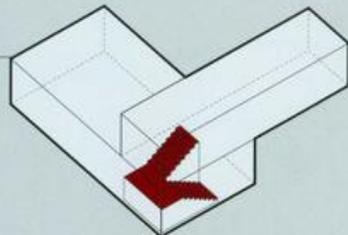
Condition - Connect



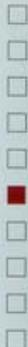
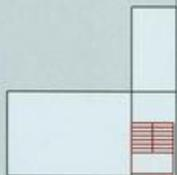
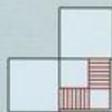
Horizontal + Vertical - Overlap



Horizontal + Vertical - Overlap

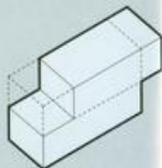


Variations



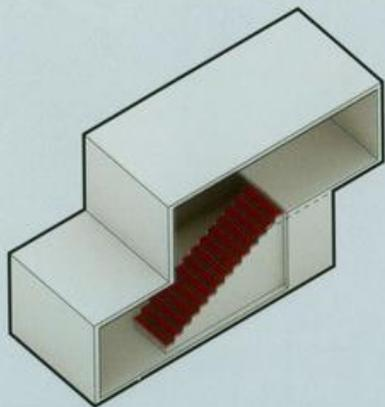
Shift

Condition | Connect

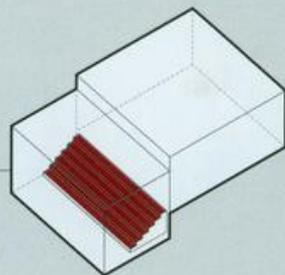


Operation - Shift

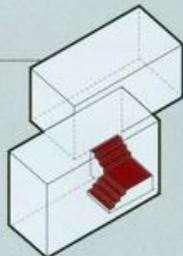
Condition - Connect



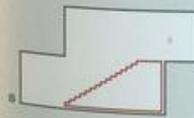
Vertical - Shift



Horizontal + Vertical - Shift



Variations



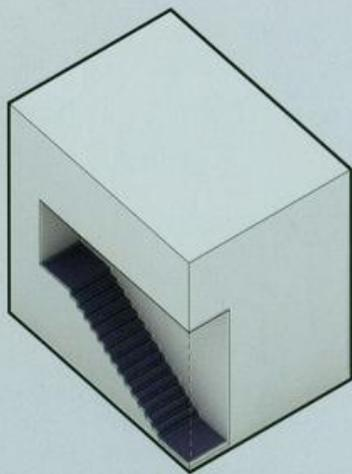
Carve

Condition | Connect

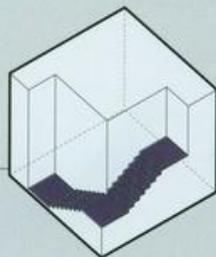


Operation - Carve

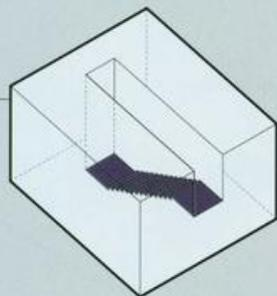
Condition - Connect



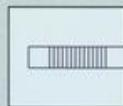
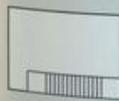
Horizontal + Vertical - Carve



Horizontal + Vertical - Carve

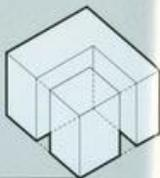


Variations



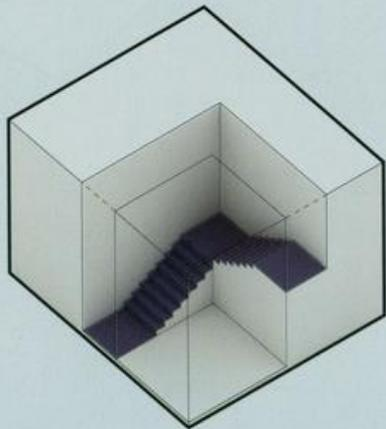
Fracture

Condition | Connect

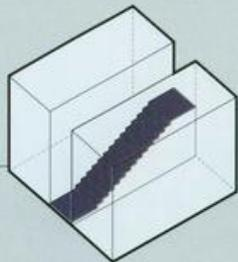


Operation - Fracture

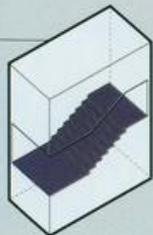
Condition - Connect



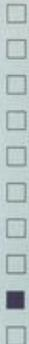
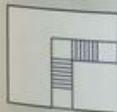
Horizontal - Fracture



Vertical - Fracture

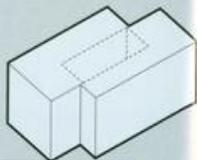


Variations



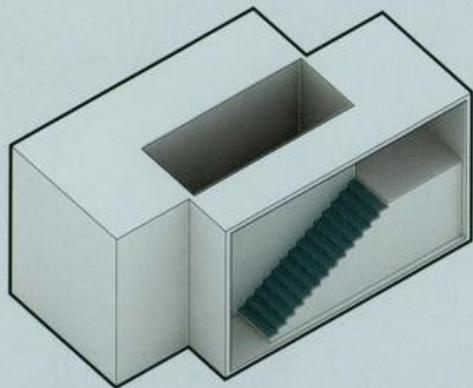
Extract

Condition | Connect

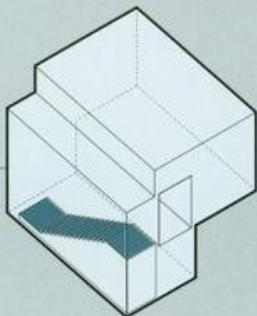


Operation - Extract

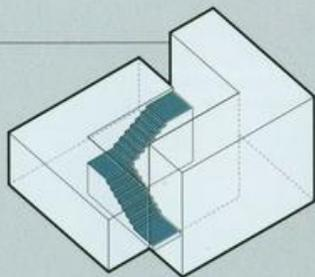
Condition - Connect



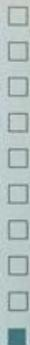
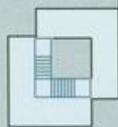
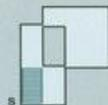
Vertical - Extract



Horizontal - Extract



Variations



40

Conditions

Ground

Expand

Merge

Split

Interlock

Intersect

Lift

Overlap

Shift

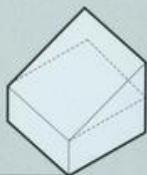
Carve

Extract

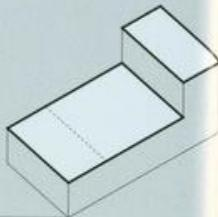


Expand

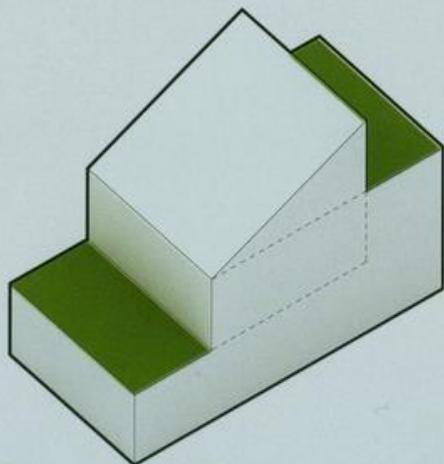
Condition | Ground



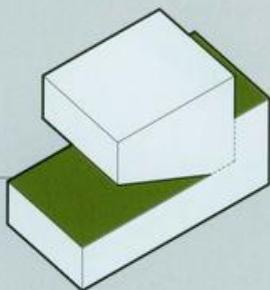
Operation - Expand



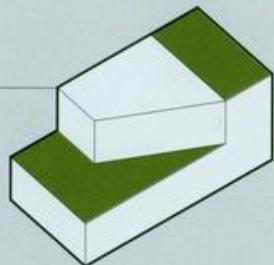
Condition - Ground



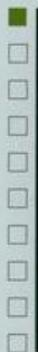
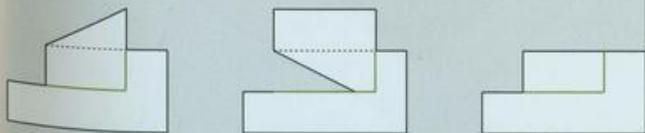
Vertical - Expand



Horizontal - Expand



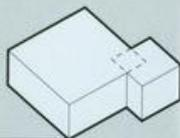
Variations



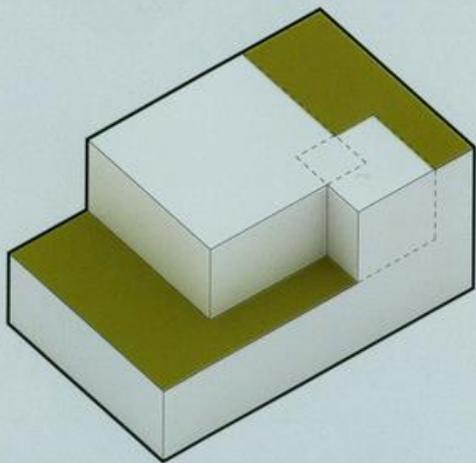
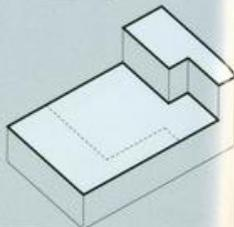
Merge

Condition | Ground

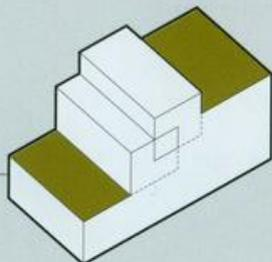
Operation - Merge



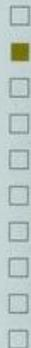
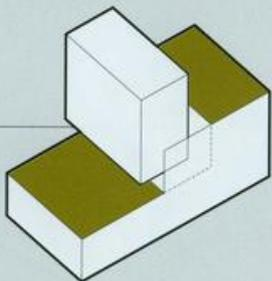
Condition - Ground



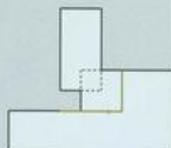
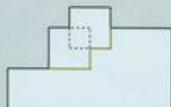
Vertical - Merge



Vertical - Merge

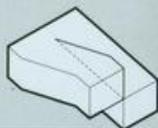


Variations

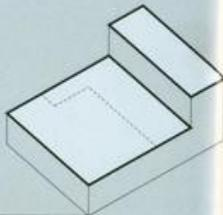


Split

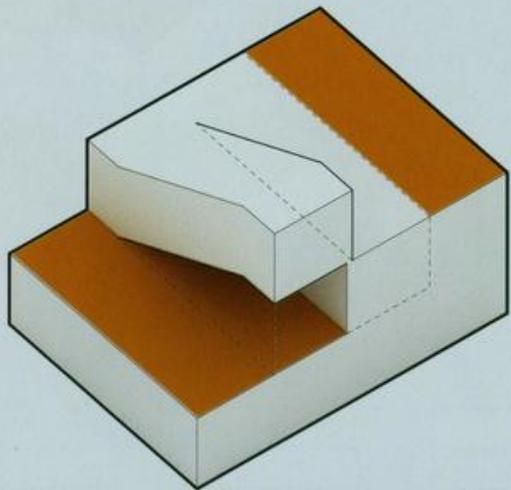
Condition | Ground



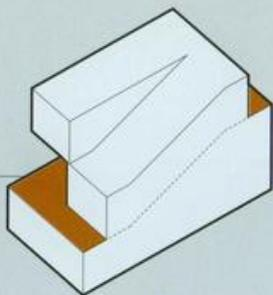
Operation - Split



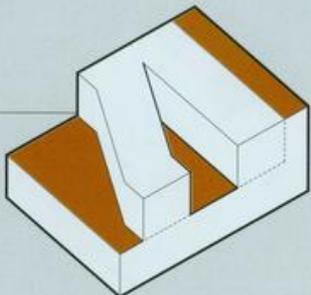
Condition - Ground



Vertical - Split



Horizontal - Split

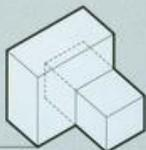


Variations

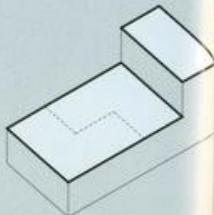


Interlock

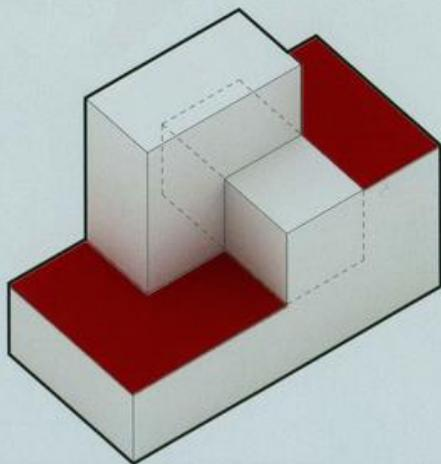
Condition | Ground



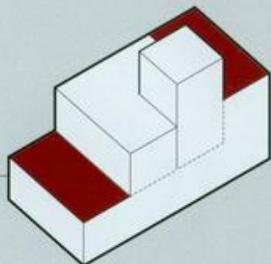
Operation - Interlock



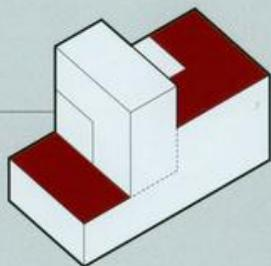
Condition - Ground



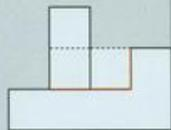
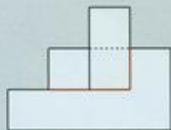
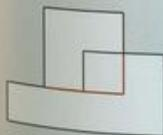
Horizontal - Interlock



Horizontal + Vertical - Interlock

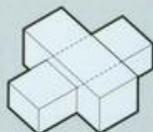


Variations

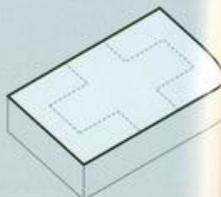


Intersect

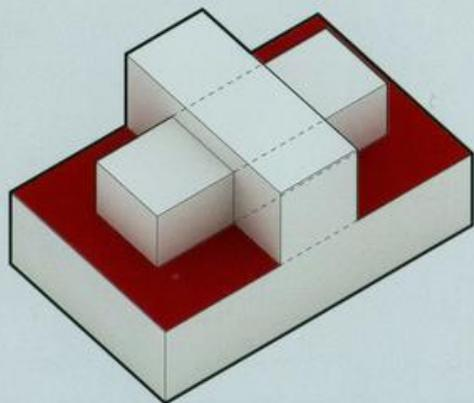
Condition | Ground



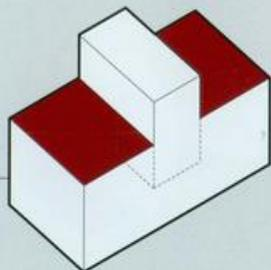
Operation - Intersect



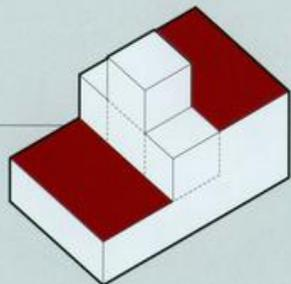
Condition - Ground



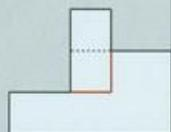
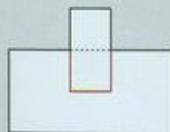
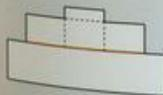
Vertical - Intersect



Vertical - Intersect

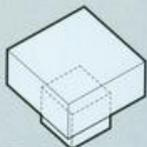


Variations

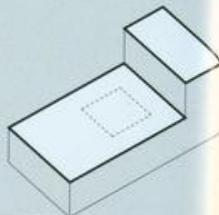


Lift

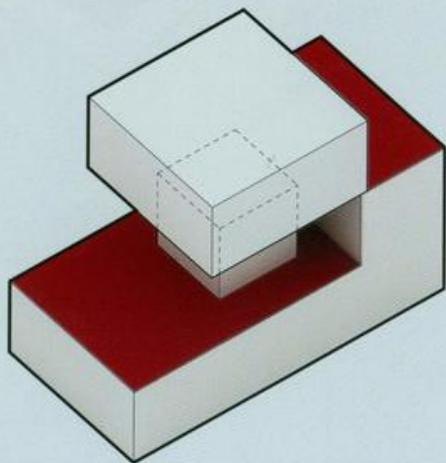
Condition | Ground



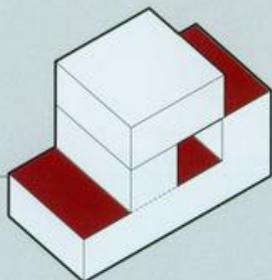
Operation - Lift



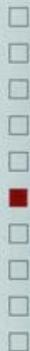
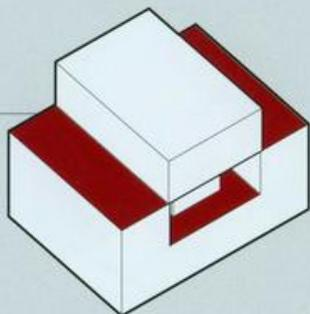
Condition - Ground



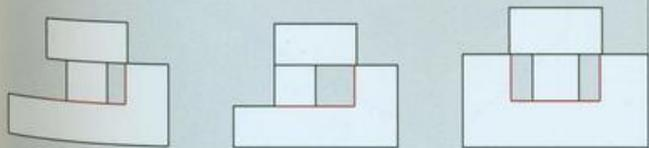
Vertical - Lift



Vertical - Lift

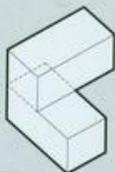


Variations

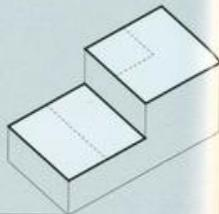


Overlap

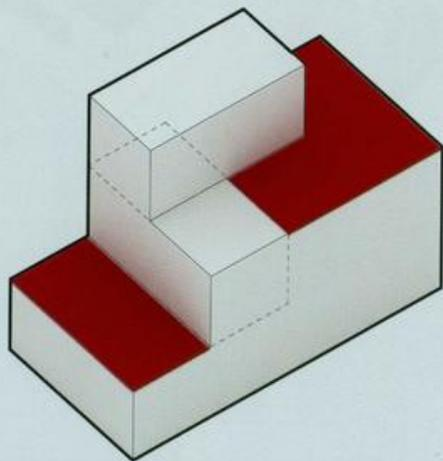
Condition | Ground



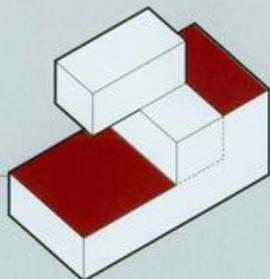
Operation - Overlap



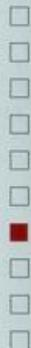
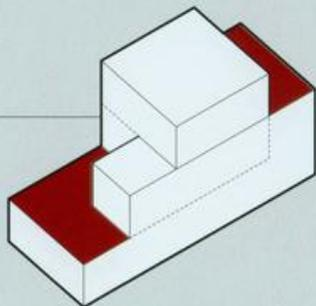
Condition - Ground



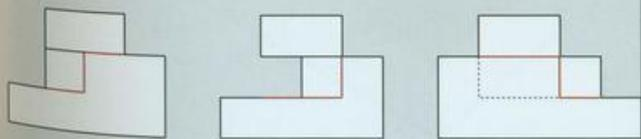
Vertical - Overlap



Vertical - Overlap

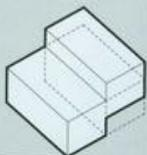


Variations

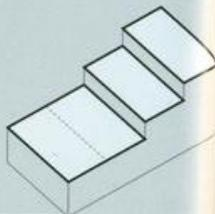


Shift

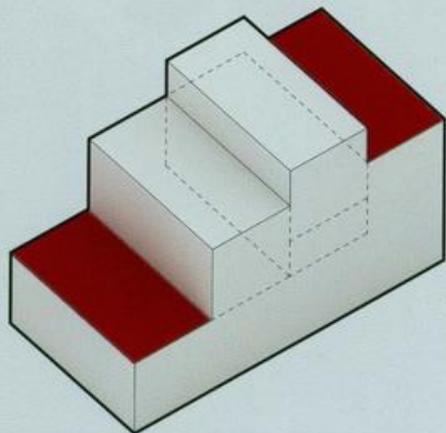
Condition | Ground



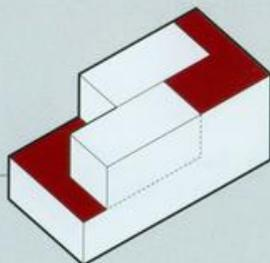
Operation - Shift



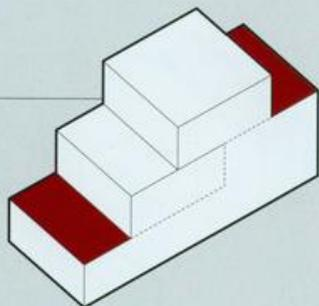
Condition - Ground



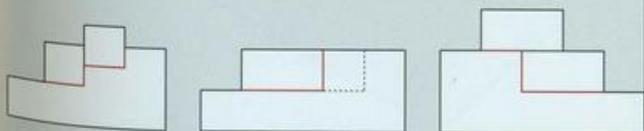
Horizontal - Shift



Horizontal - Shift

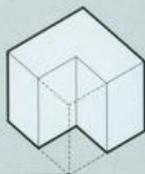


Variations

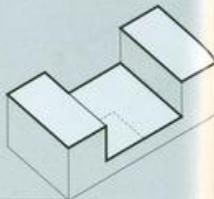


Carve

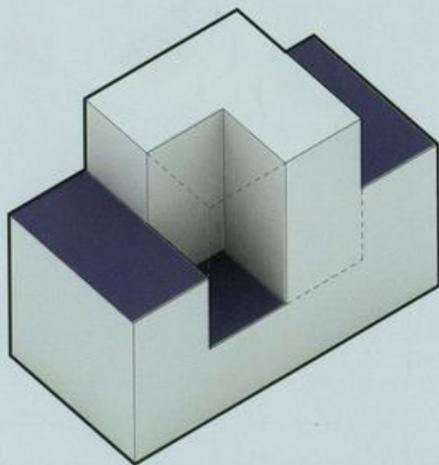
Condition | Ground



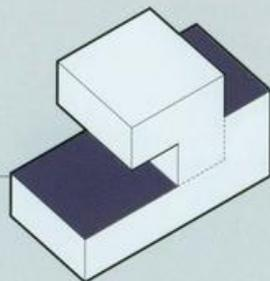
Operation - Carve



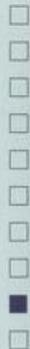
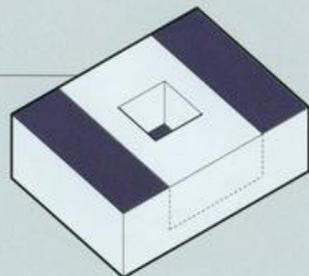
Condition - Ground



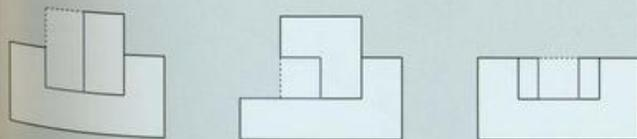
Horizontal - Carve



Vertical - Carve

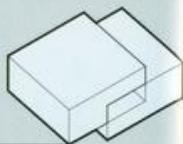


Variations

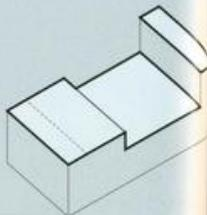


Extract

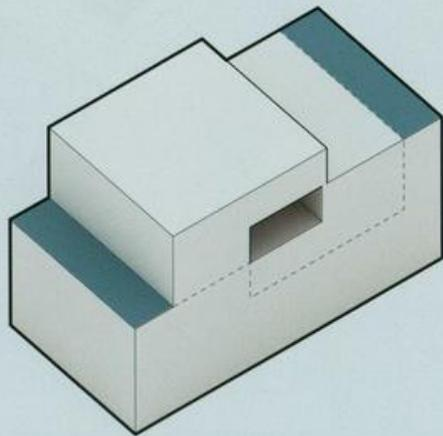
Condition | Ground



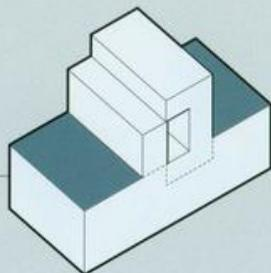
Operation - Extract



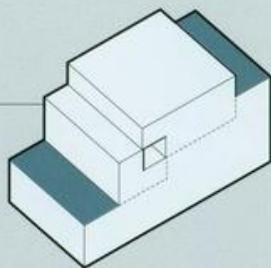
Condition - Ground



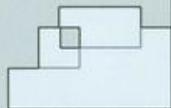
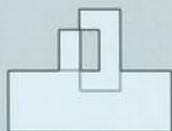
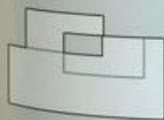
Vertical - Extract



Vertical - Extract



Variations



Open

Extrude

Branch

Split

Intersect

Lift

Shift

Carve

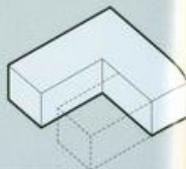
Fracture

Embed

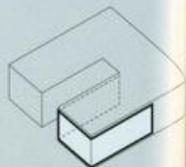
Extract

Extrude

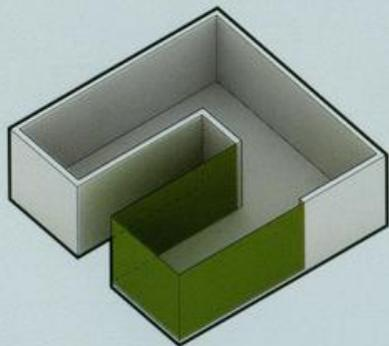
Condition | Open



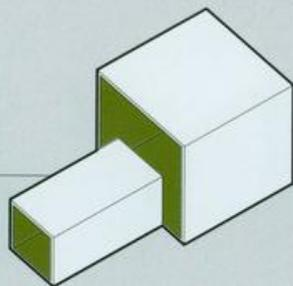
Operation - Extrude



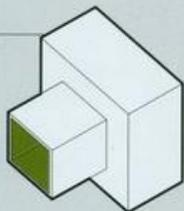
Condition - Open



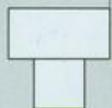
Horizontal - Extrude



Horizontal - Extrude

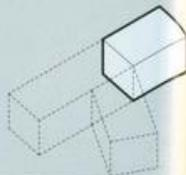


Variations

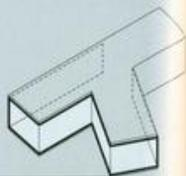


Branch

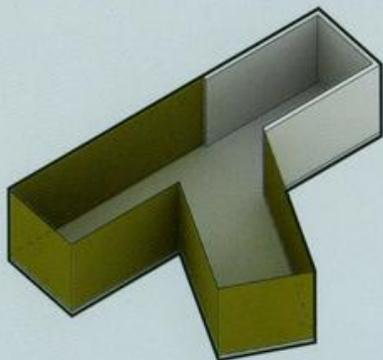
Condition | Open



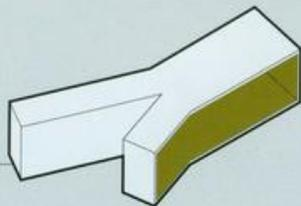
Operation - Branch



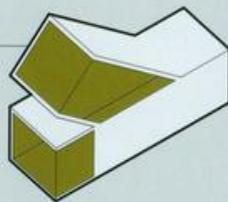
Condition - Open



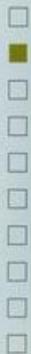
Horizontal - Branch



Horizontal + Vertical - Branch

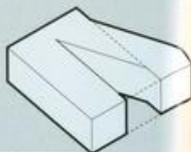


Variations

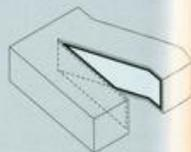


Split

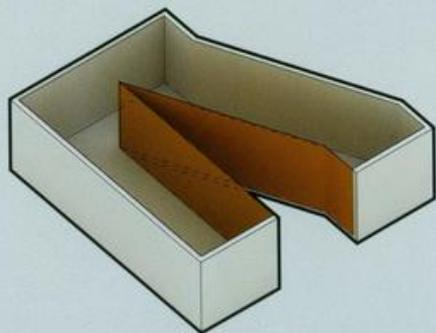
Condition | Open



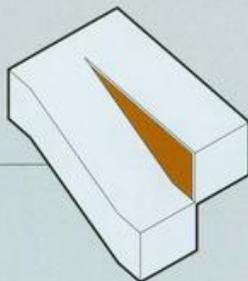
Operation - Split



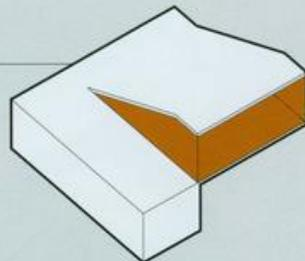
Condition - Open



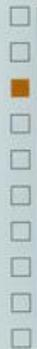
Vertical - Split



Vertical - Split

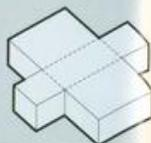


Variations

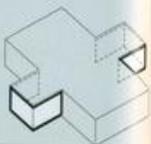


Intersect

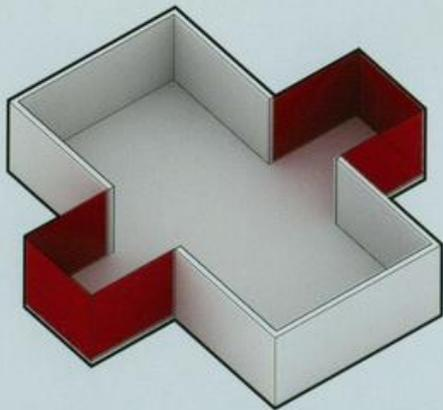
Condition | Open



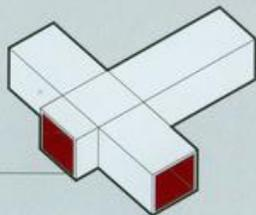
Operation - Intersect



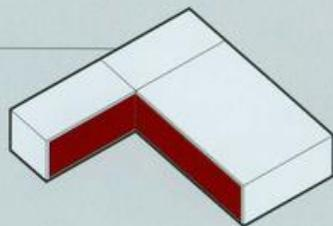
Condition - Open



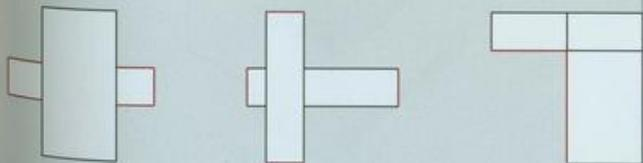
Horizontal - Intersect



Horizontal - Intersect

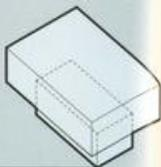


Variations

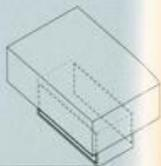


Lift

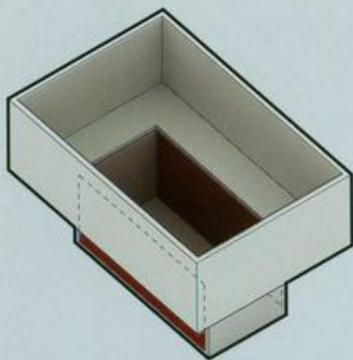
Condition | Open



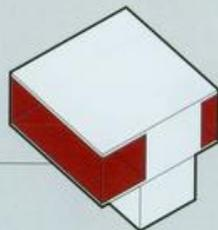
Operation - Lift



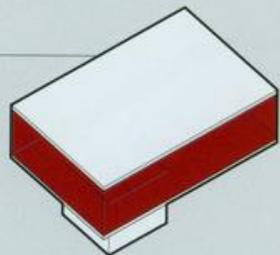
Condition - Open



Vertical - Lift



Vertical - Lift

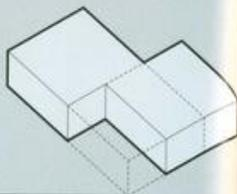


Variations

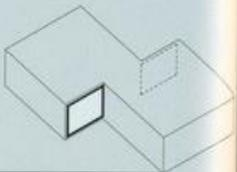


Shift

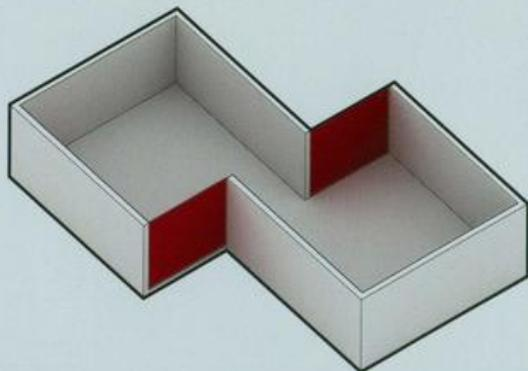
Condition | Open



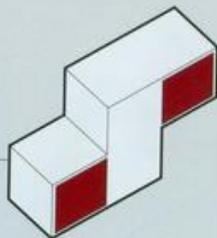
Operation - Shift



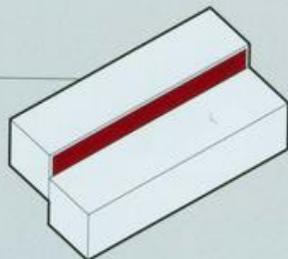
Condition - Open



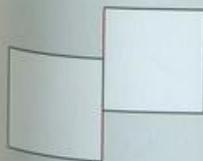
Horizontal - Shift



Vertical - Shift

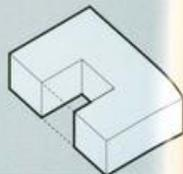


Variations



Carve

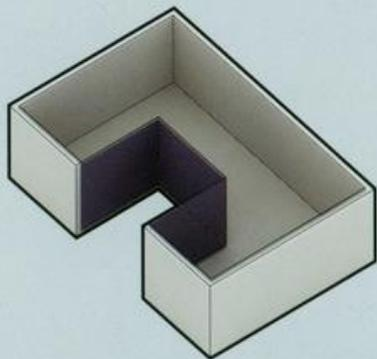
Condition | Open



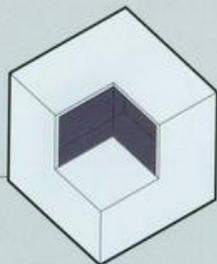
Operation - Carve



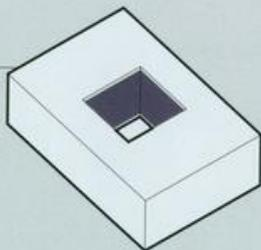
Condition - Open



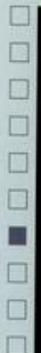
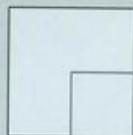
Horizontal + Vertical - Carve



Vertical - Carve

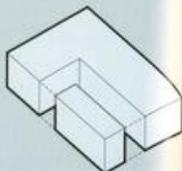


Variations



Fracture

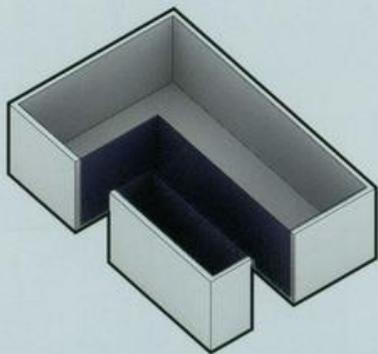
Condition | Open



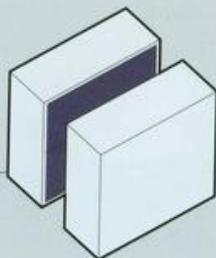
Operation - Fracture



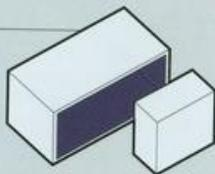
Condition - Open



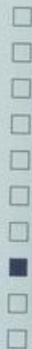
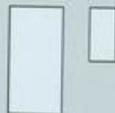
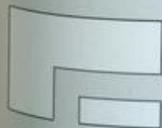
Vertical - Fracture



Vertical - Fracture

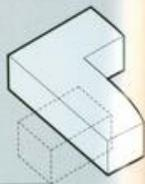


Variations



Embed

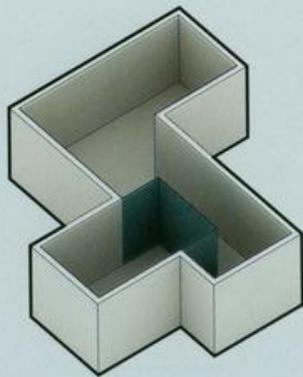
Condition | Open



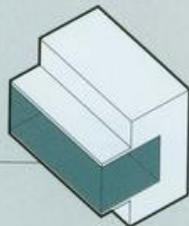
Operation - Embed



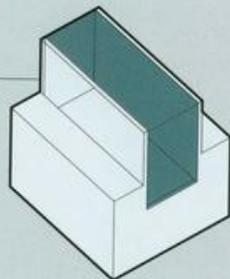
Condition - Open



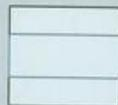
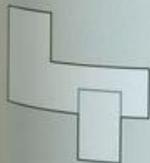
Horizontal - Embed



Vertical - Embed



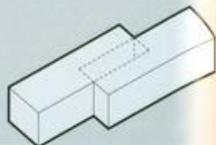
Variations



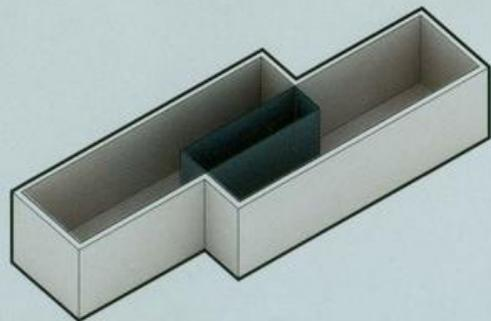
Extract

Condition | Open

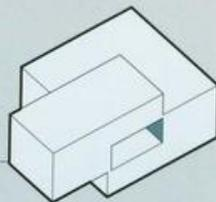
Operation - Extract



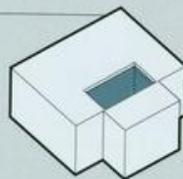
Condition - Open



Horizontal - Extract

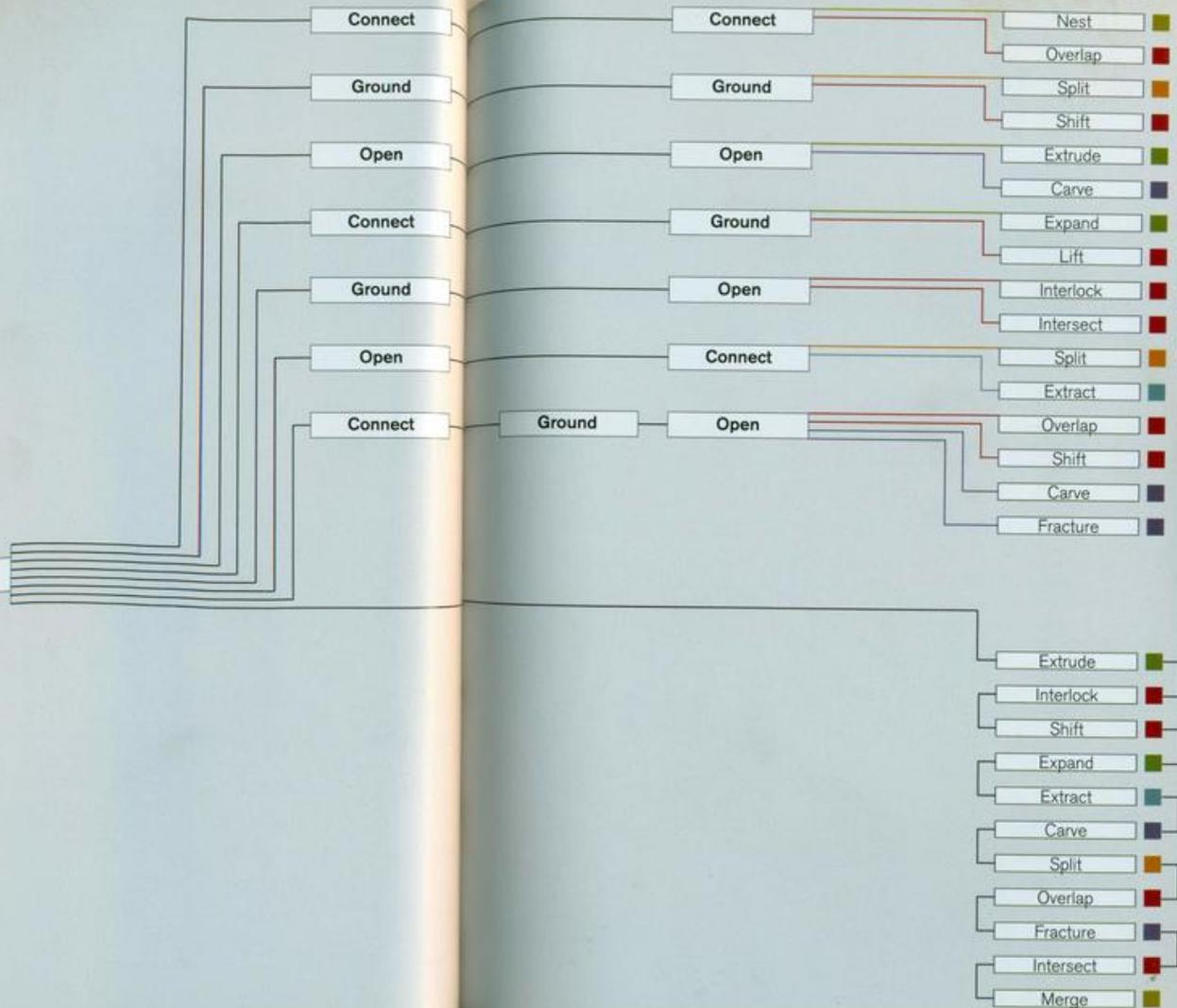


Vertical - Extract



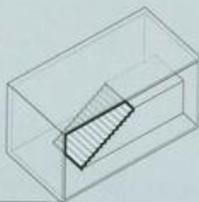
Variations



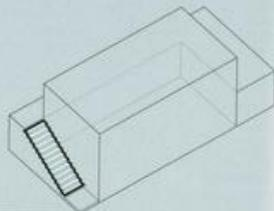


Nest

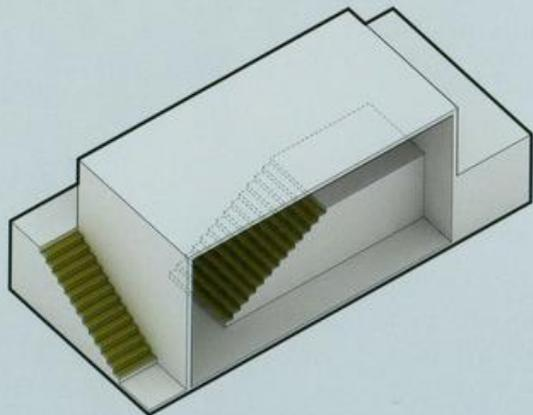
Single Operation | Single Condition



Condition - Connect

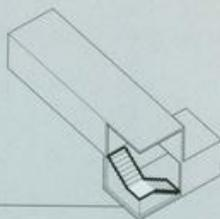


Condition - Connect

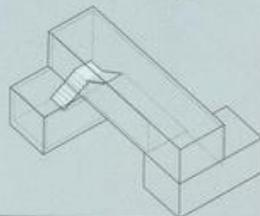


Overlap

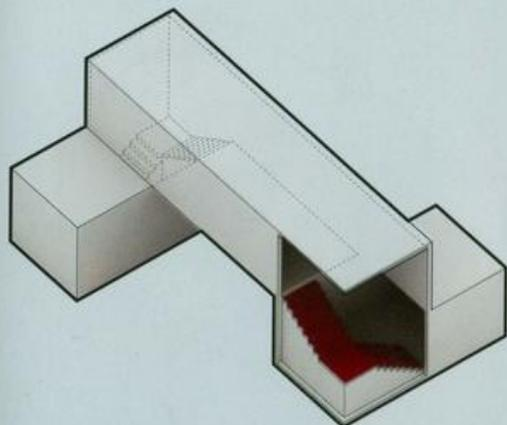
Single Operation | Single Condition



Condition - Connect

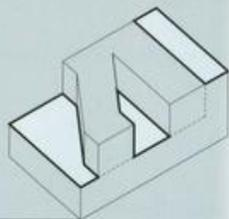


Condition - Connect

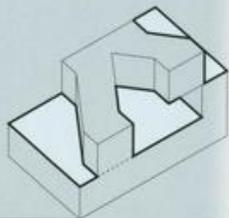


Split

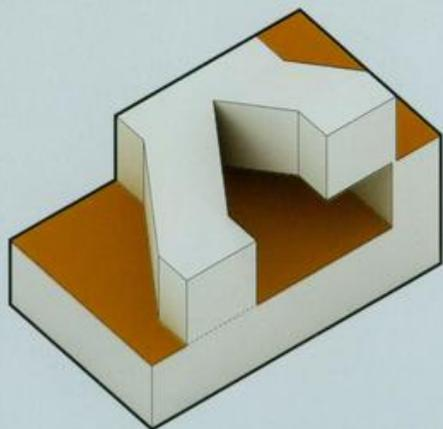
Single Operation | Single Condition



Condition - Ground

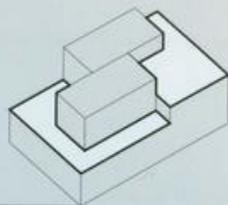


Condition - Ground

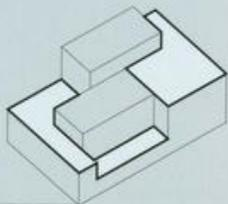


Shift

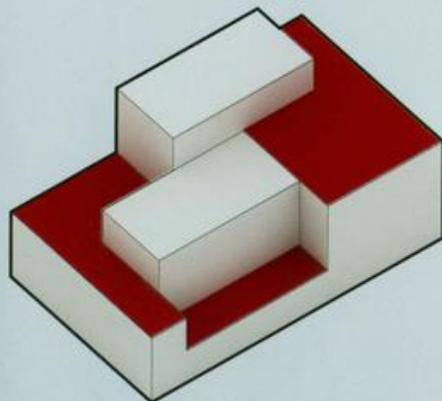
Single Operation | Single Condition



Condition - Ground

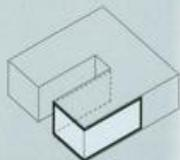


Condition - Ground

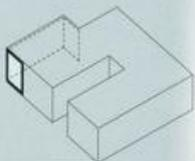


Extrude

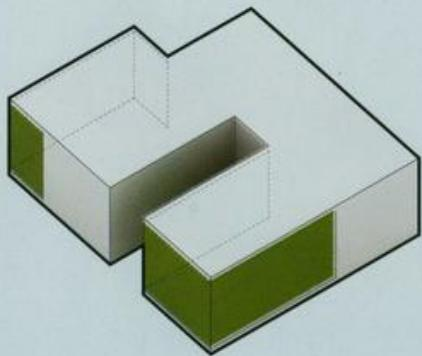
Single Operation | Single Condition



Condition - Open

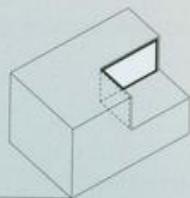


Condition - Open

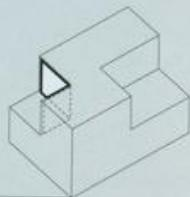


Carve

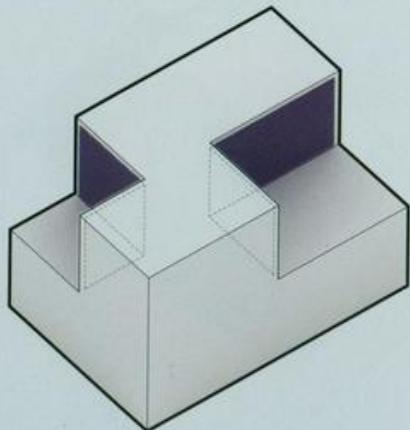
Single Operation | Single Condition



Condition - Open

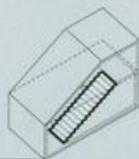


Condition - Open

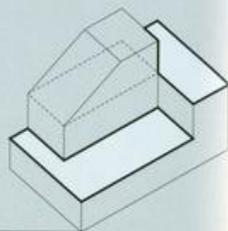


Expand

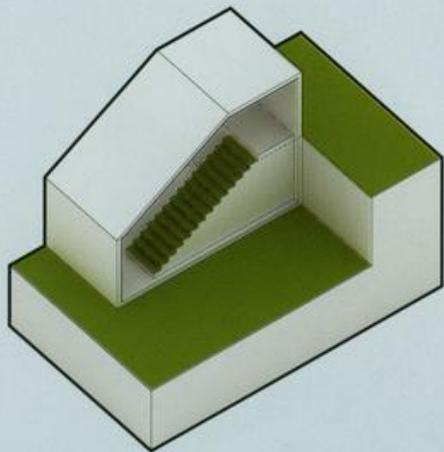
Single Operation | Multiple Conditions



Condition - Connect

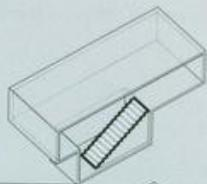


Condition - Ground

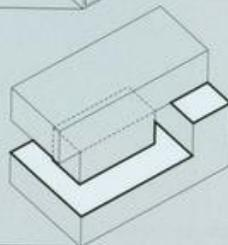


Lift

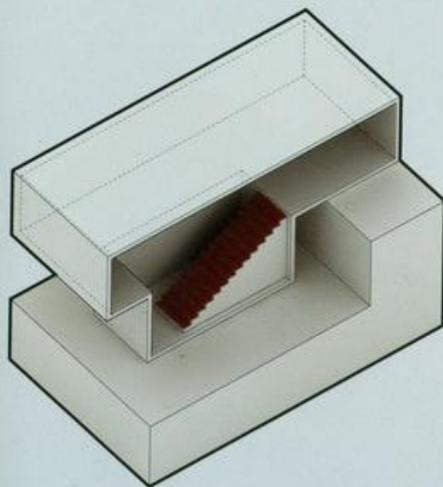
Single Operation | Multiple Conditions



Condition - Connect

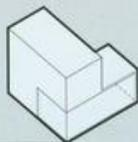


Condition - Ground

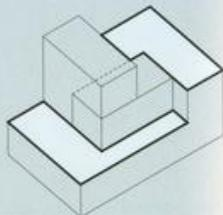


Interlock

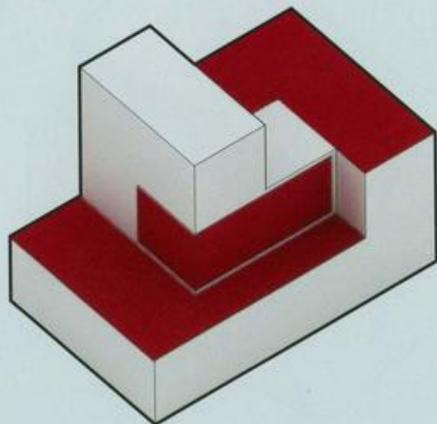
Single Operation | Multiple Conditions



Condition - Open



Condition - Ground

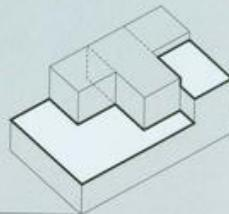


Intersect

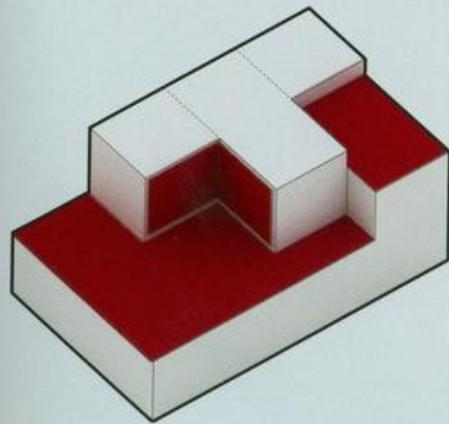
Single Operation | Multiple Conditions



Condition - Open

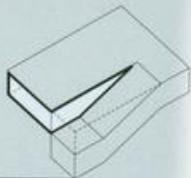


Condition - Ground

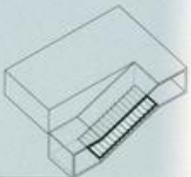


Split

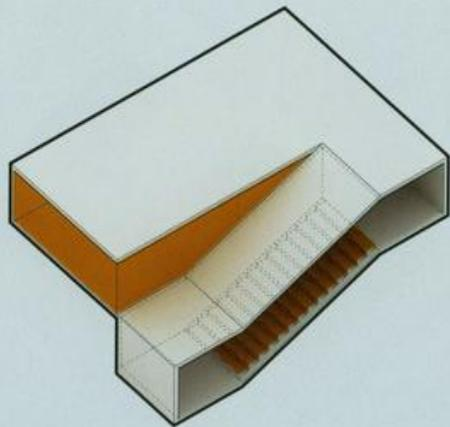
Single Operation | Multiple Conditions



Condition - Open

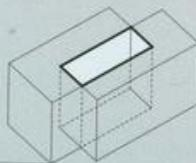


Condition - Connect

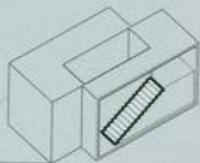


Extract

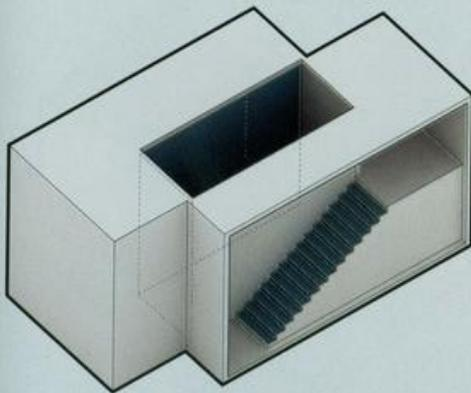
Single Operation | Multiple Conditions



Condition - Open



Condition - Connect



Overlap

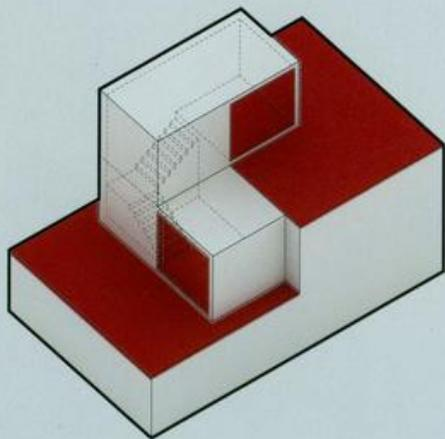
Single Operation | Multiple Conditions



Condition - Open

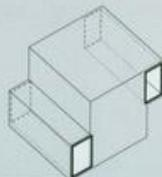


Condition - Connect

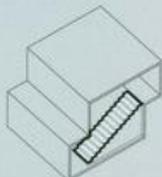


Shift

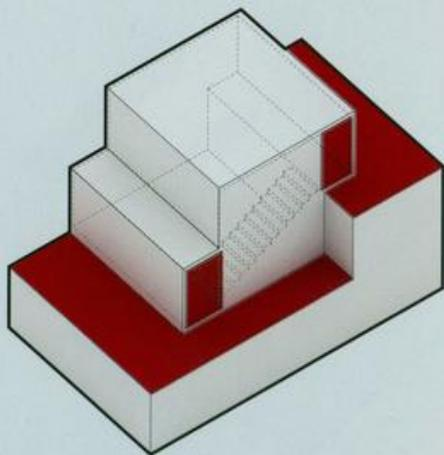
Single Operation | Multiple Conditions



Condition - Open

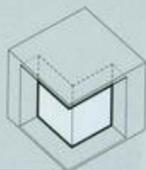


Condition - Connect

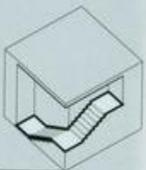


Carve

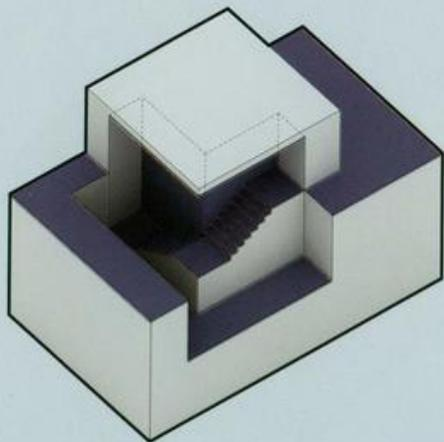
Single Operation | Multiple Conditions



Condition - Open

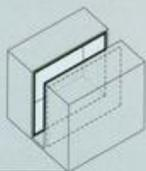


Condition - Connect

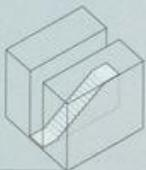


Fracture

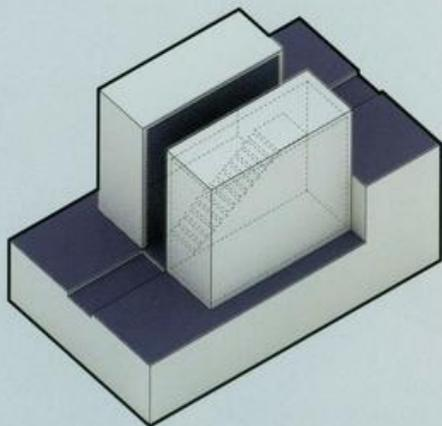
Single Operation | Multiple Conditions



Condition - Open



Condition - Connect

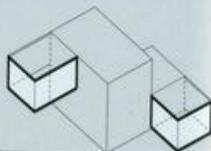


Interlock + Extrude

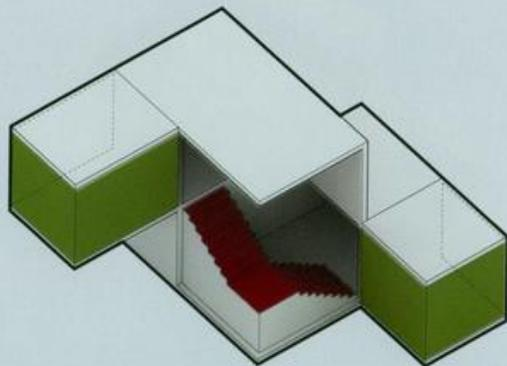
Multiple Operations | Multiple Conditions



Operation - Interlock | Condition - Connect

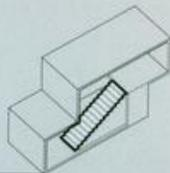


Operation - Extrude | Condition - Open

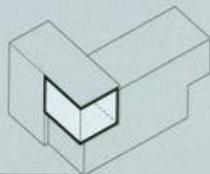


Interlock + Shift

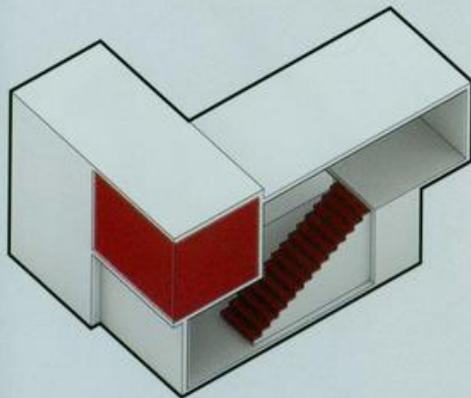
Multiple Operations | Multiple Conditions



Operation - Shift | Condition - Connect

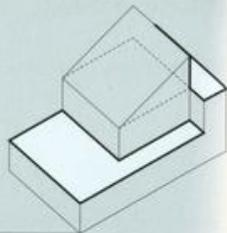


Operation - Interlock | Condition - Open

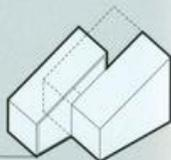


Shift + Expand

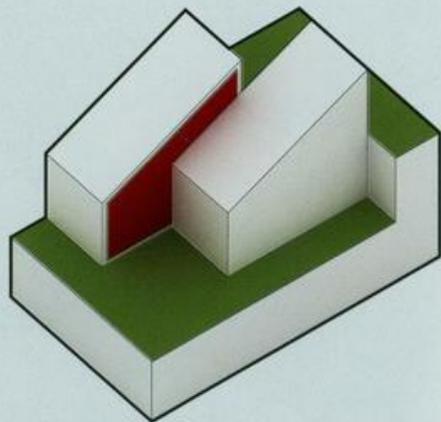
Multiple Operations | Multiple Conditions



Operation - Expand | Condition - Ground

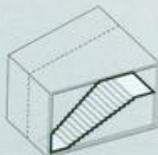


Operation - Shift | Condition - Open

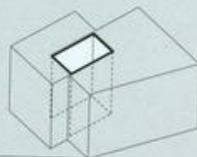


Expand + Extract

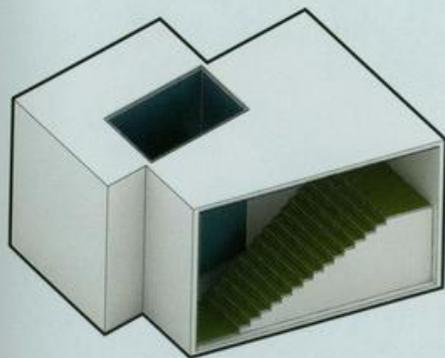
Multiple Operations | Multiple Conditions



Operation - Expand | Condition - Connect

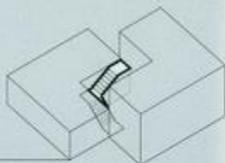


Operation - Extract | Condition - Open



Extract + Carve

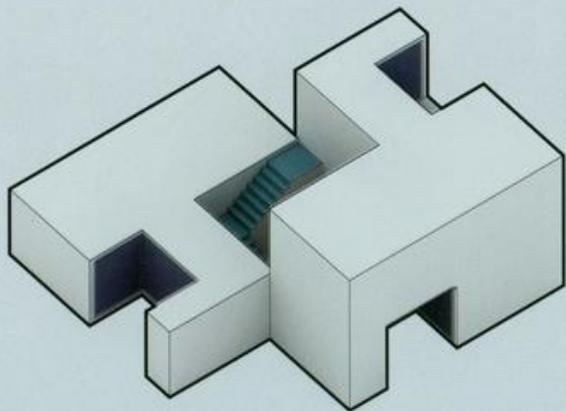
Multiple Operations | Multiple Conditions



Operation - Extract | Condition - Connect

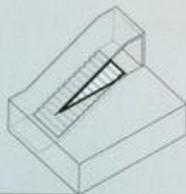


Operation - Carve | Condition - Open

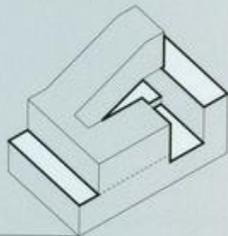


Carve + Split

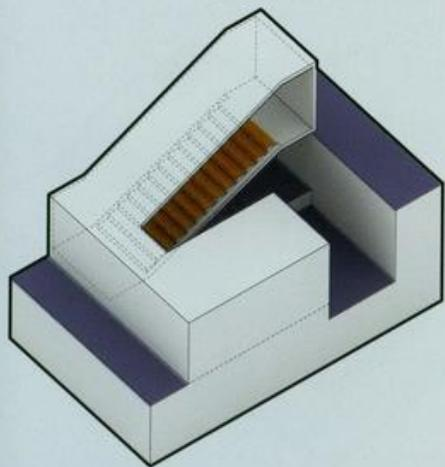
Multiple Operations | Multiple Conditions



Operation - Split | Condition - Connect

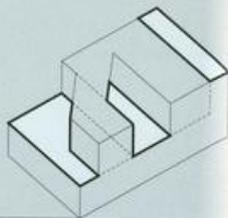


Operation - Carve | Condition - Ground



Split + Overlap

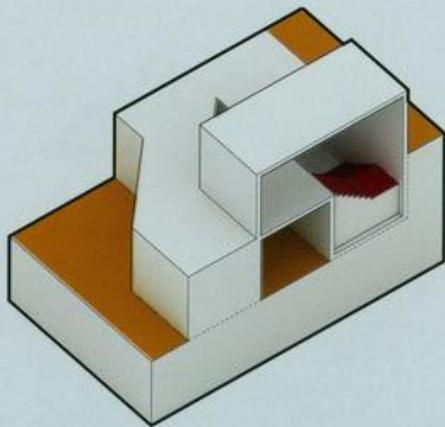
Multiple Operations | Multiple Conditions



Operation - Split | Condition - Ground

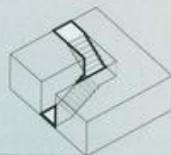


Operation - Overlap | Condition - Connect

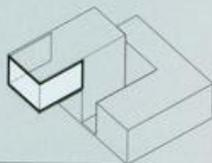


Overlap + Fracture

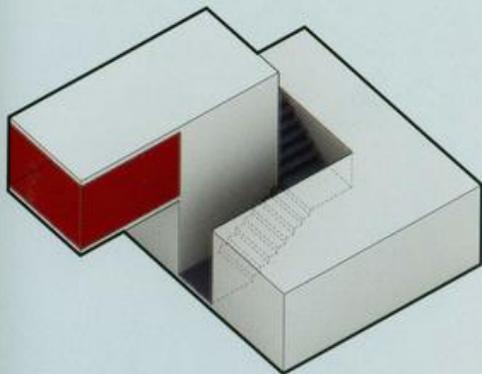
Multiple Operations | Multiple Conditions



Operation - Fracture | Condition - Connect

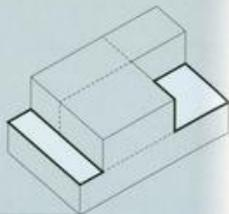


Operation - Overlap | Condition - Open

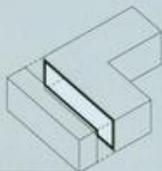


Fracture + Intersect

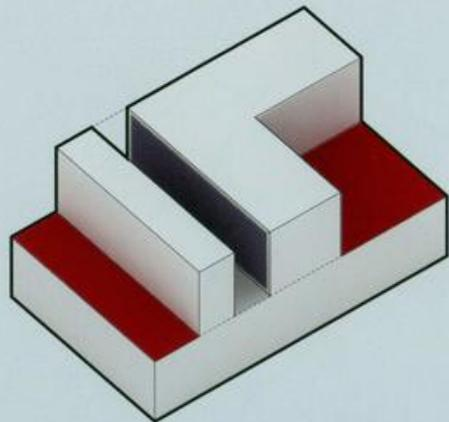
Multiple Operations | Multiple Conditions



Operation - Intersect | Condition - Ground

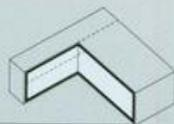


Operation - Fracture | Condition - Open

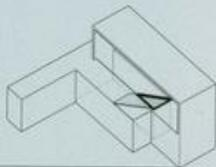


Intersect + Merge

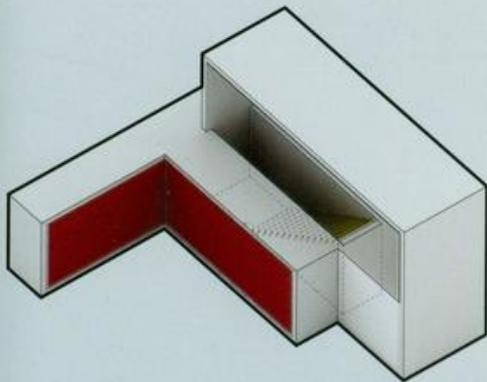
Multiple Operations | Multiple Conditions



Operation - Intersect | Condition - Open



Operation - Merge | Condition - Connect



Aggregations



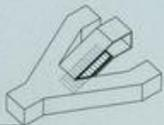
Reflect | Branch

Single Aggregation Method

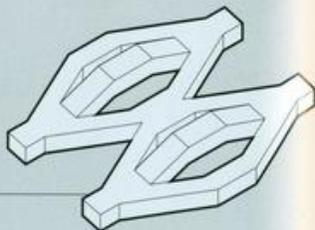
Operation - Branch



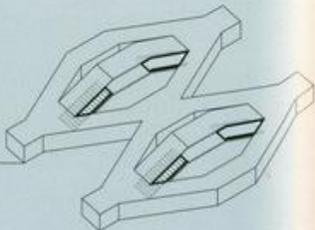
Condition - Connect



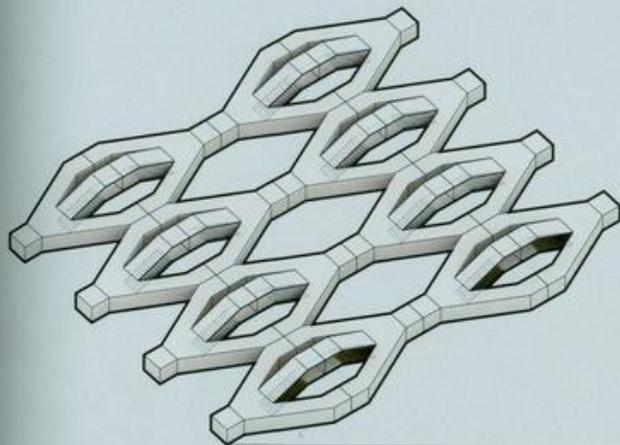
Aggregation Method - Reflect



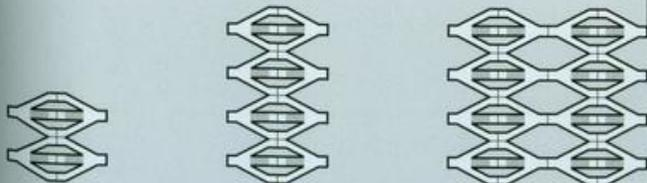
Condition - Connect



Aggregation

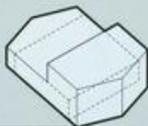


Variations



Reflect + Pack | Expand

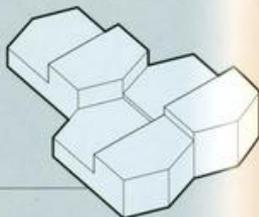
Multiple Aggregation Method



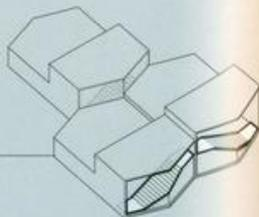
Operation - Expand



Condition - Connect

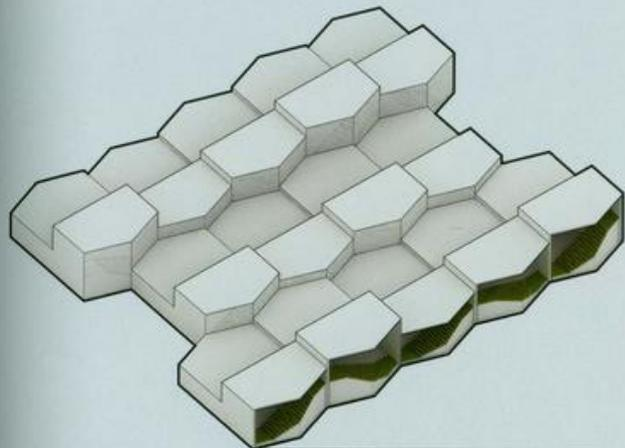


Aggregation Method - Reflect + Pack

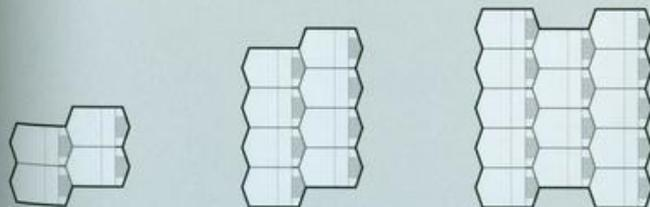


Condition - Connect

Aggregation

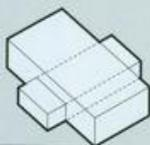


Variations

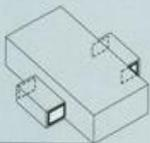


Pack | Intersect

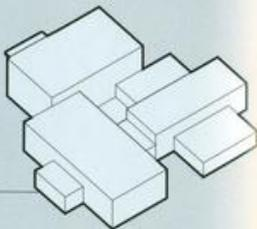
Single Aggregation Method



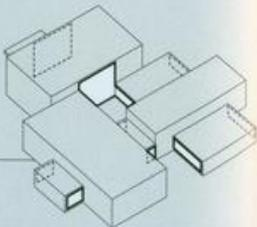
Operation - Intersect



Condition - Open

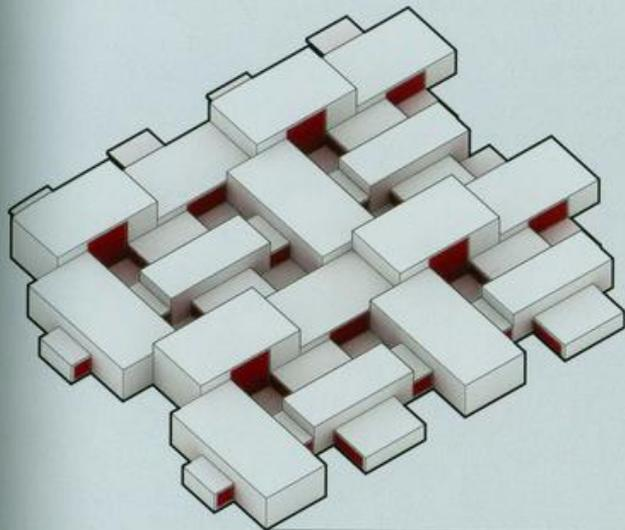


Aggregation Method - Pack

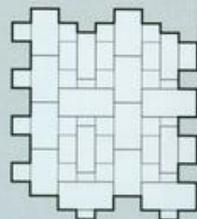
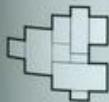


Condition - Open

Aggregation

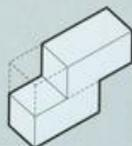


Variations

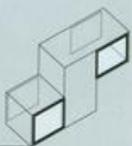


Pack + Stack | Shift

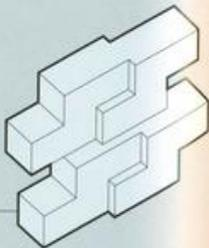
Multiple Aggregation Method



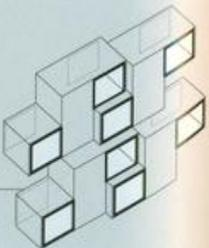
Operation - Shift



Condition - Open

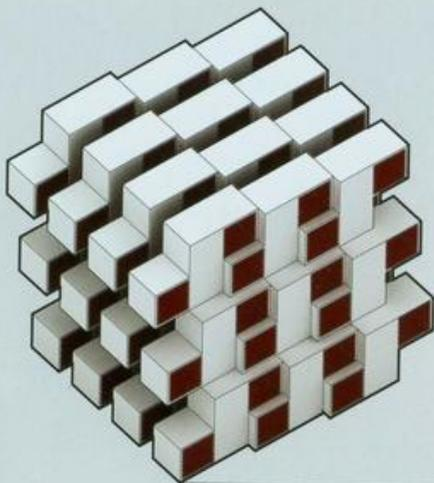


Aggregation Method - Pack + Stack

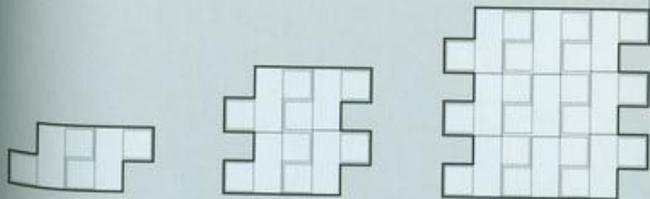


Condition - Open

Aggregation

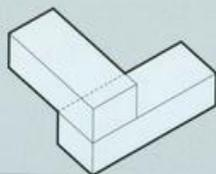


Variations

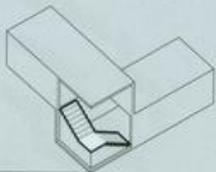


Stack | Overlap

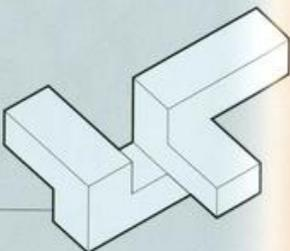
Single Aggregation Method



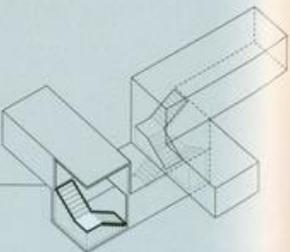
Operation - Overlap



Condition - Connect

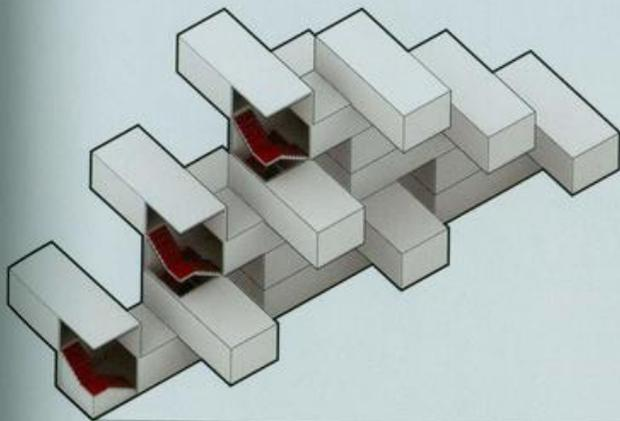


Aggregation - Stack

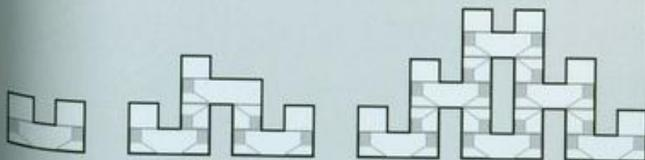


Condition - Connect

Aggregation

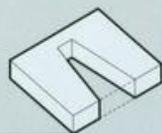


Variations

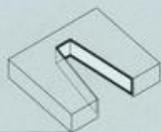


Array + Stack | Carve

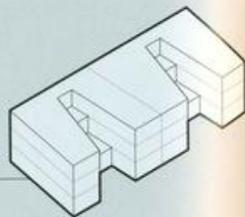
Multiple Aggregation Method



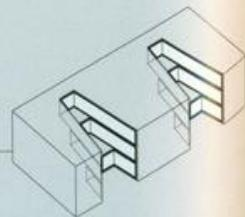
Operation - Carve



Condition - Open

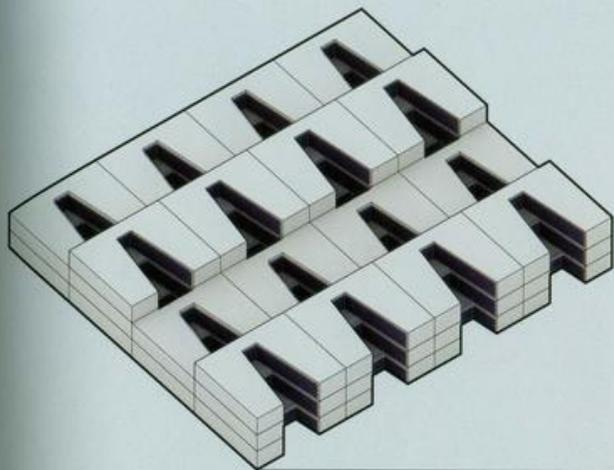


Aggregation Method - Array + Stack

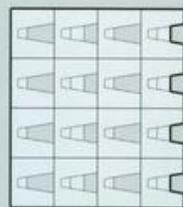
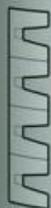


Condition - Open

Aggregation

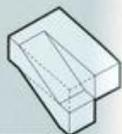


Variations

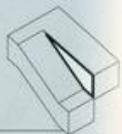


Array | Split

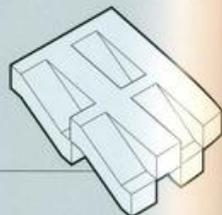
Single Aggregation Method



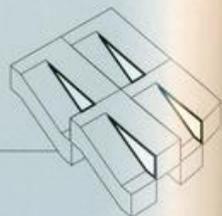
Operation - Split



Condition - Open

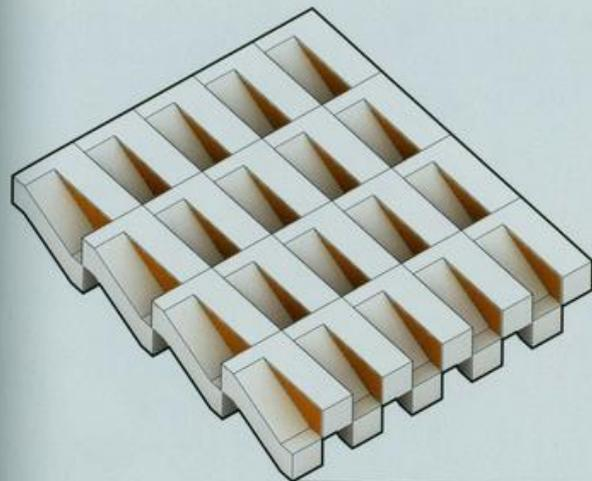


Aggregation Method - Array

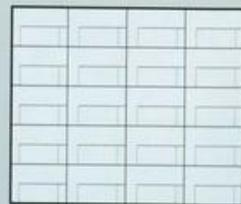


Condition - Open

Aggregation

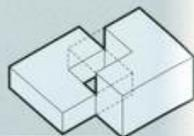


Variations

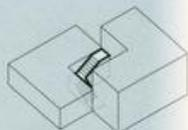


Join + Array | Extract

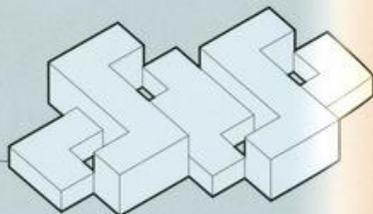
Multiple Aggregation Method



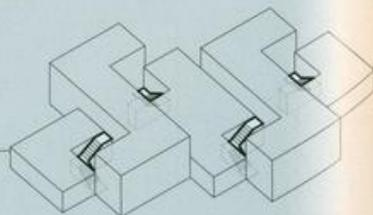
Operation - Extract



Condition - Connect

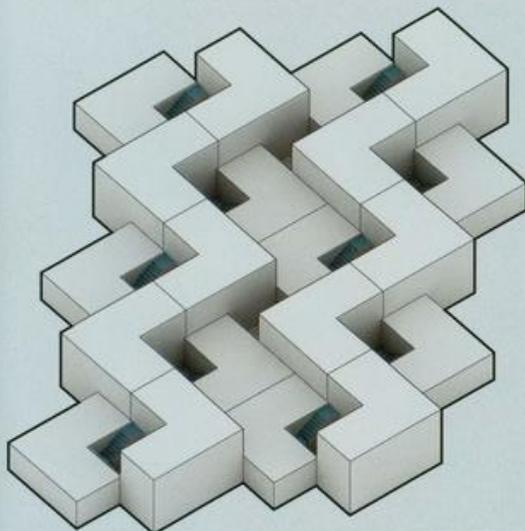


Aggregation Method - Join + Array

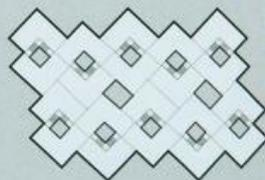
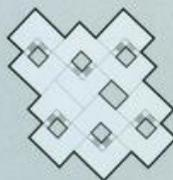


Condition - Connect

Aggregation



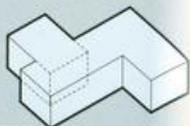
Variations



Join | Embed

Single Aggregation Method

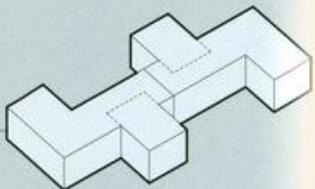
Operation - Embed



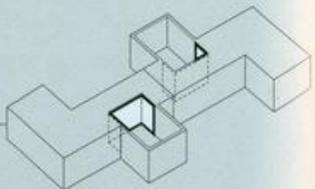
Condition - Open



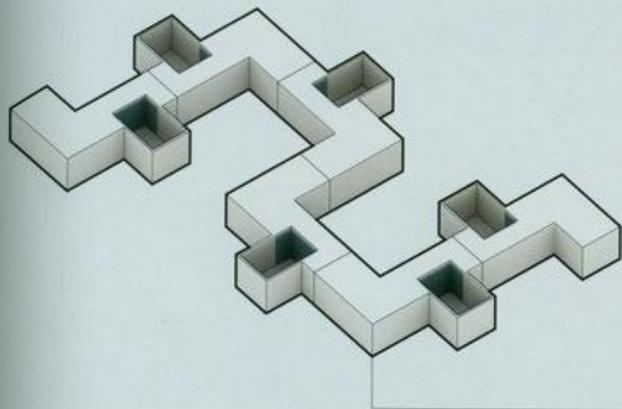
Aggregation Method - Join



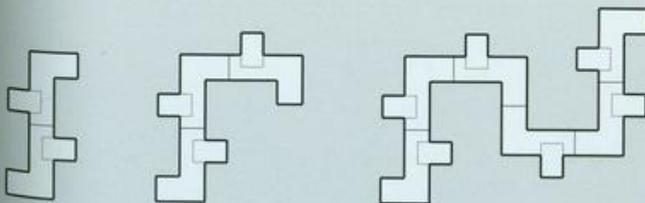
Condition - Open

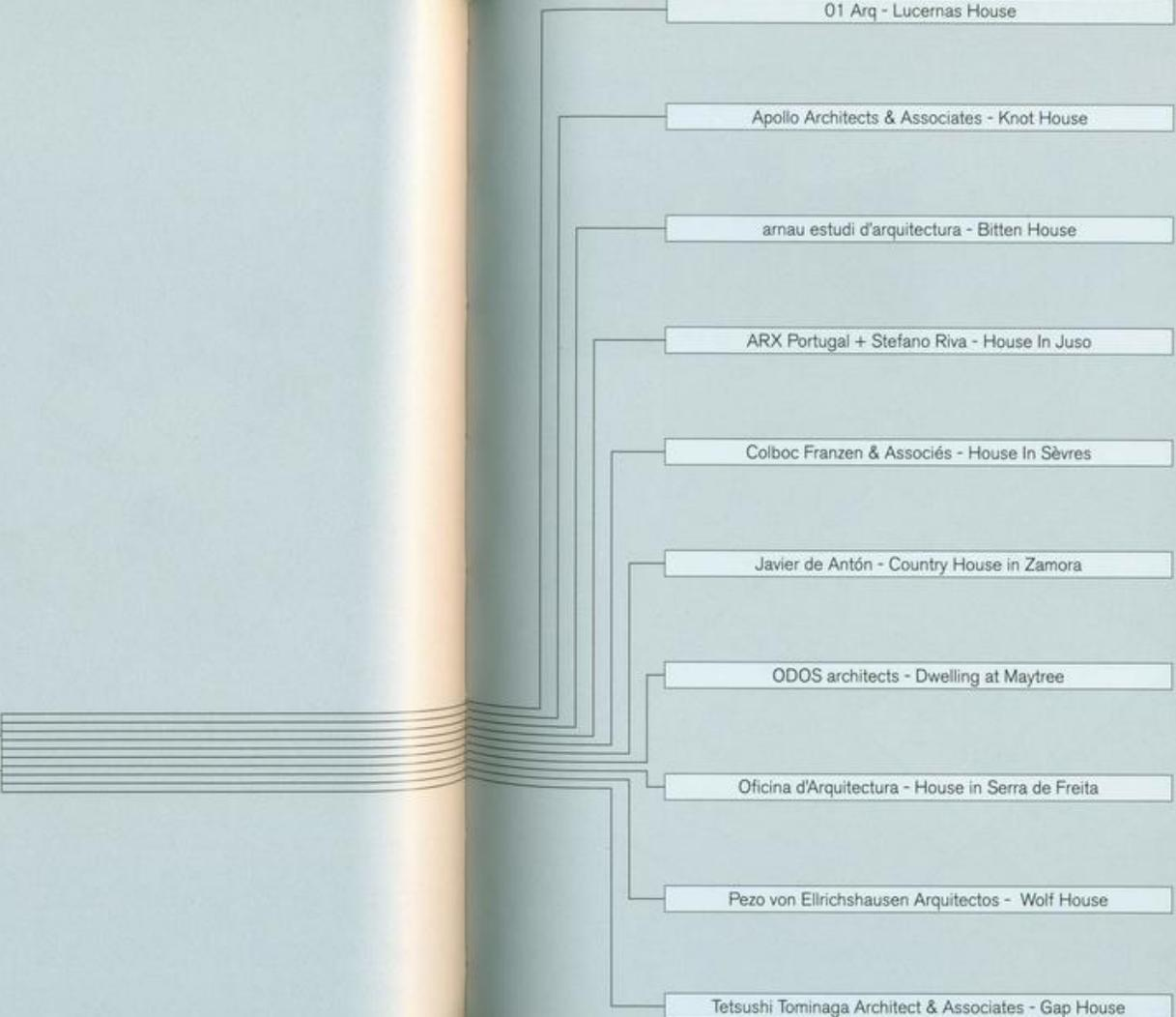


Aggregation



Variations





01 Arq - Lucernas House

Apollo Architects & Associates - Knot House

arnau estudi d'arquitectura - Bitten House

ARX Portugal + Stefano Riva - House In Juso

Colboc Franzen & Associés - House In Sèvres

Javier de Antón - Country House in Zamora

ODOS architects - Dwelling at Maytree

Oficina d'Arquitectura - House in Serra de Freitas

Pezo von Ellrichshausen Arquitectos - Wolf House

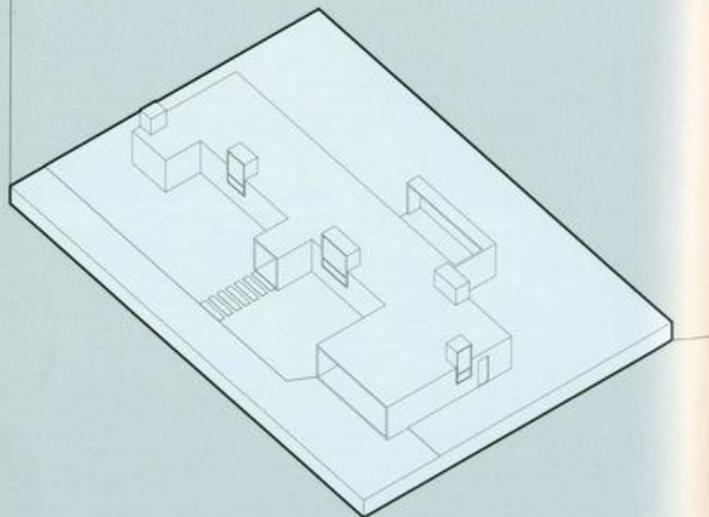
Tetsushi Tominaga Architect & Associates - Gap House

Lucernas House

01 Arq

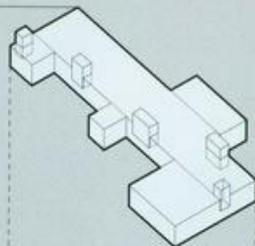


Photo by Aryeh Kornfeld

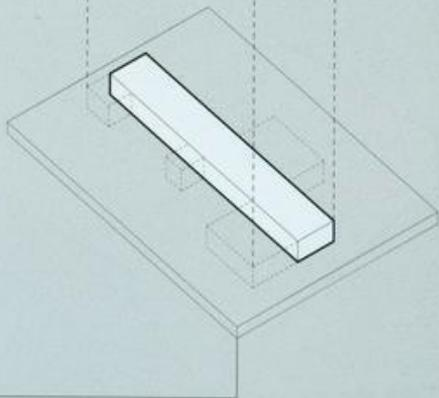
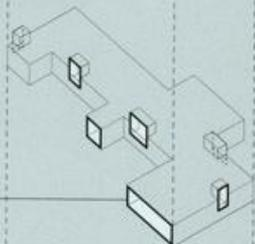


Embed

Operation - Embed



Condition - Open



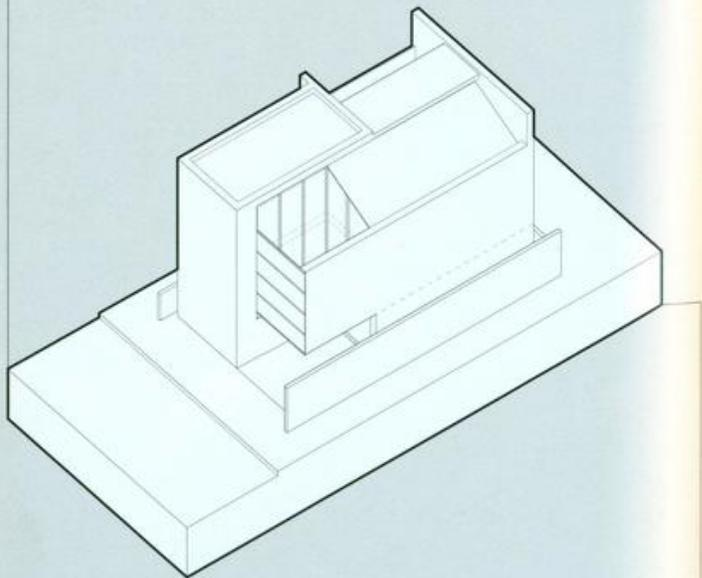
Base Volumes

Knot House

Apollo Architects & Associates

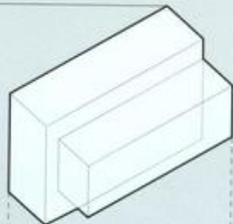


Photo by Masao Nishikawa

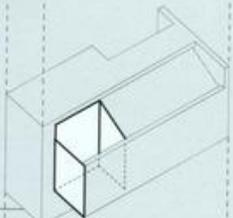


Extrude

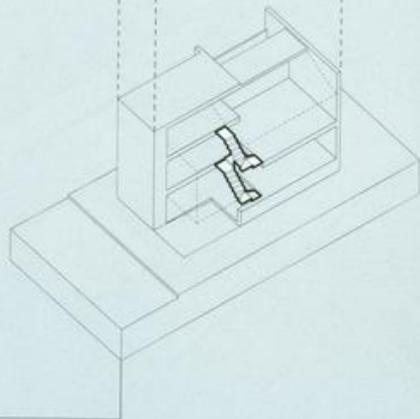
Operation - Extrude



Condition - Open



Condition - Connect

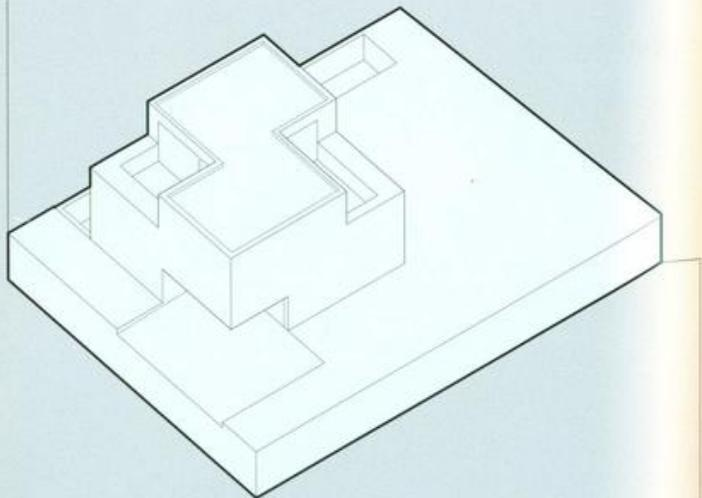


Bitten House

arnau estudi d'arquitectura

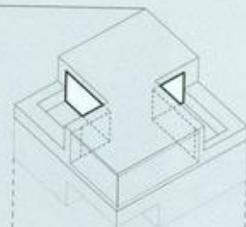


Photo by Marc Torra



Carve

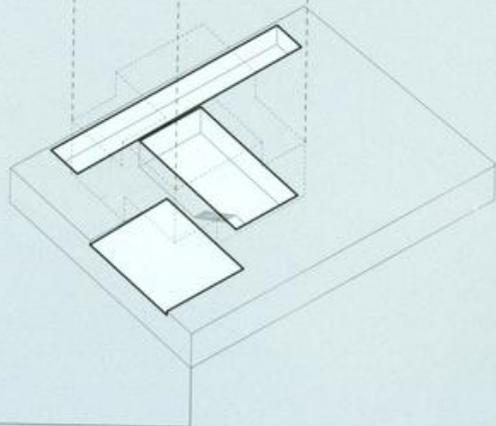
Condition - Open



Condition - Connect + Open



Condition - Ground

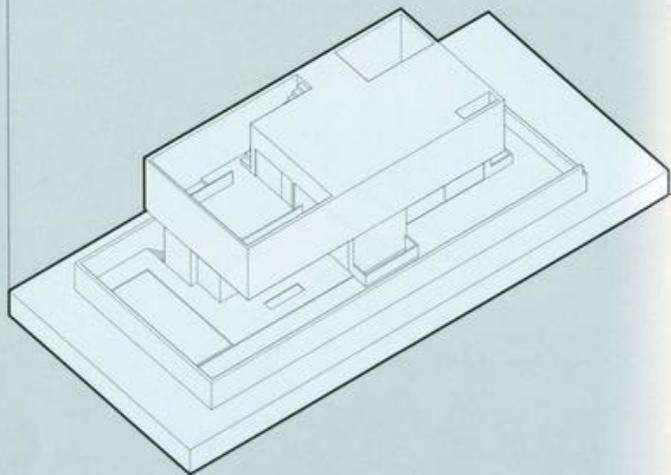


House In Juso

ARX Portugal + Stefano Riva

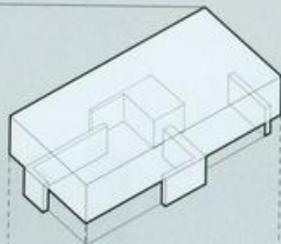


Photo by FG+SG fotografia de arquitectura

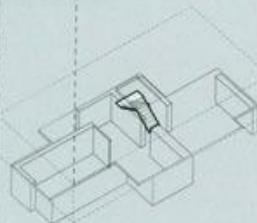


Lift

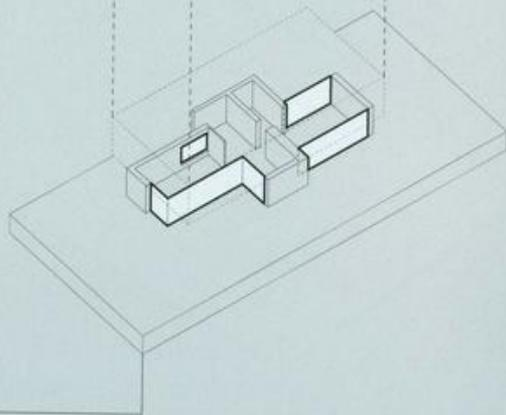
Operation - Lift



Condition - Connect



Condition - Open

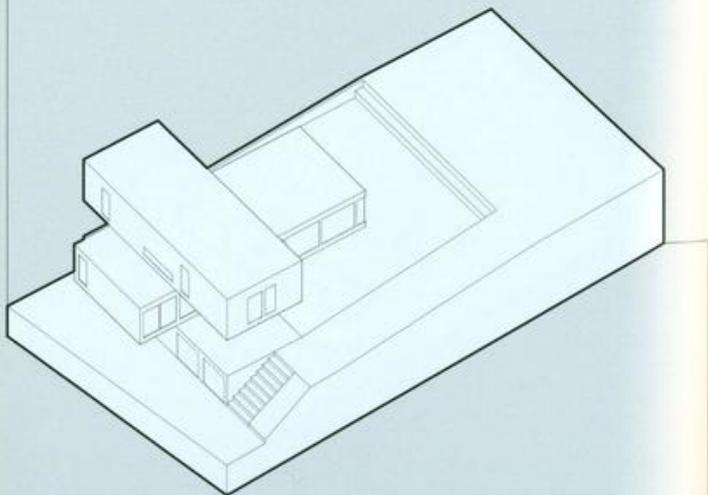


House In Sèvres

Colboc Franzen & Associés

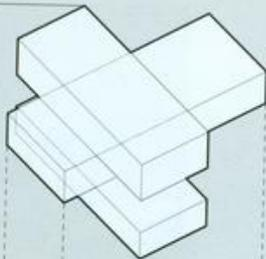


Photo by Cécile Septet

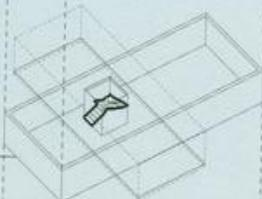


Overlap

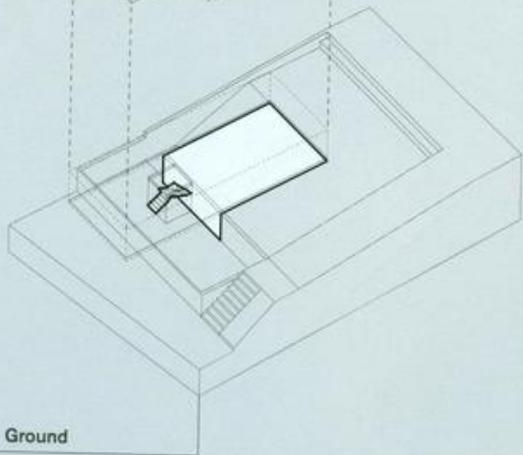
Operation - Overlap



Condition - Connect



Condition - Connect + Ground

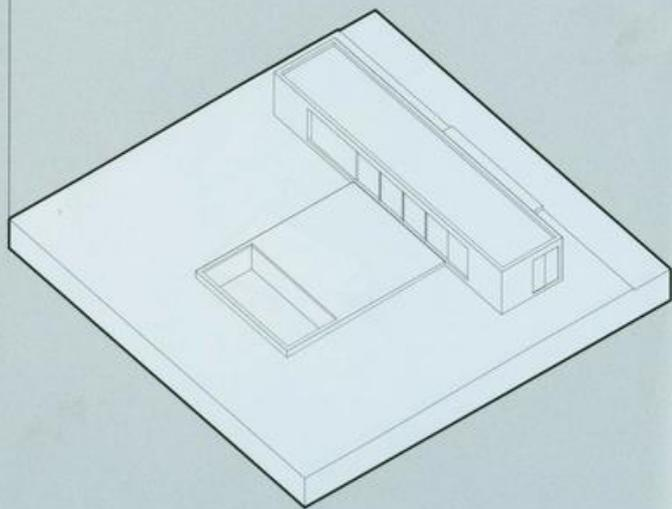


Country House in Zamora

Javier de Antón

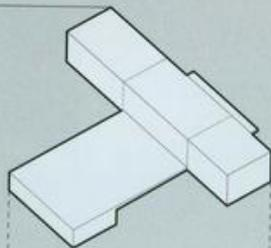


Photo by Esau Acosta

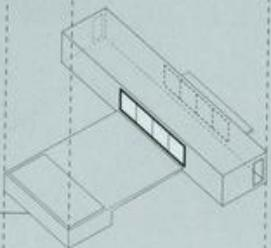


Intersect

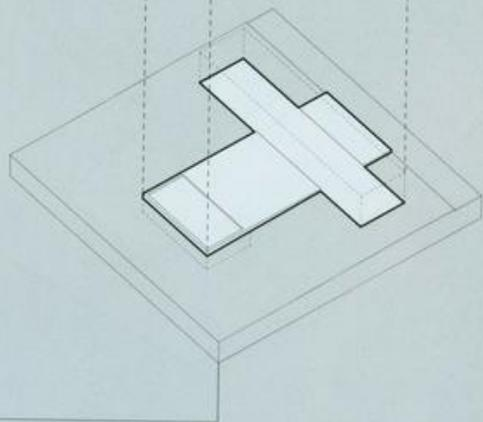
Operation - Intersect



Condition - Open



Condition - Ground

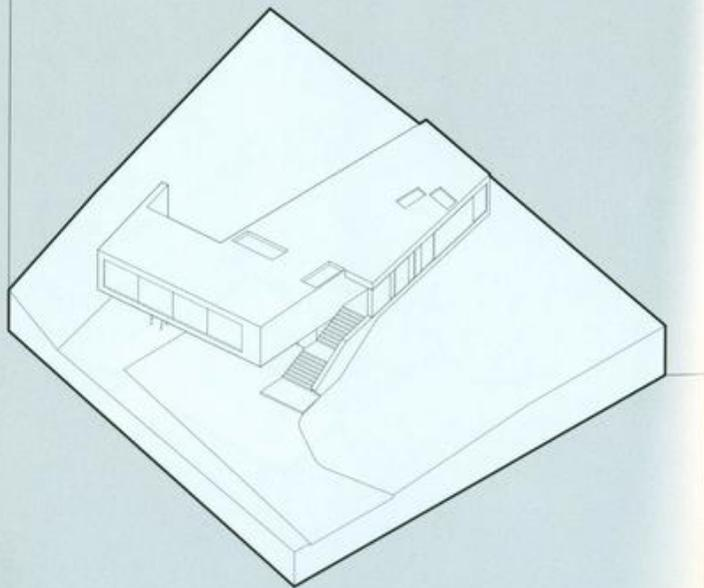


Dwelling at Maytree

ODOS architects

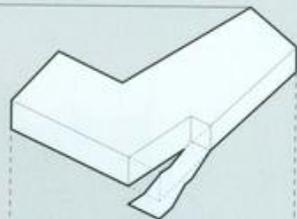


Photo by Ros Kavanagh

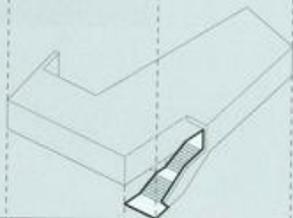


Split

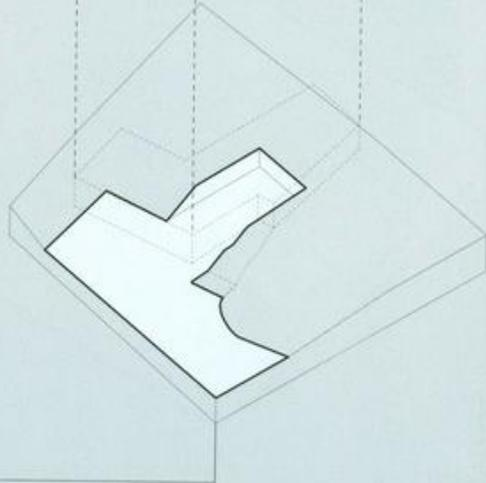
Operation - Split



Condition - Connect



Condition - Ground

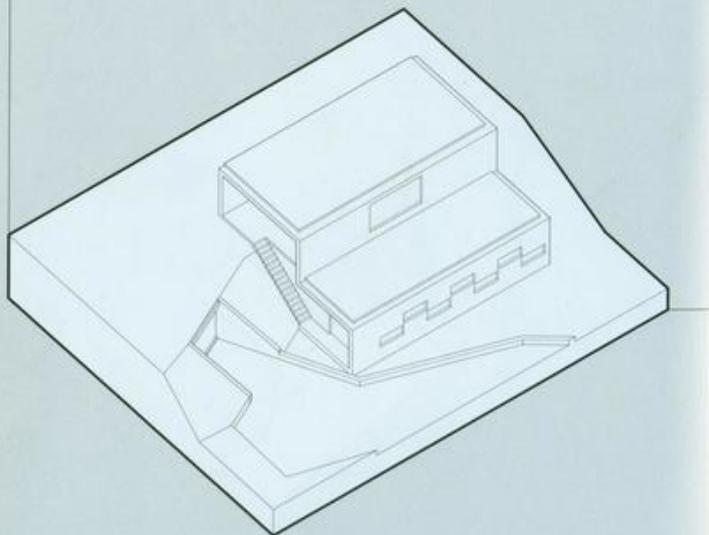


House in Serra de Freitas

Oficina d'Arquitectura

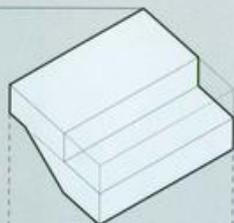


Photo by Oficina d'Arquitectura

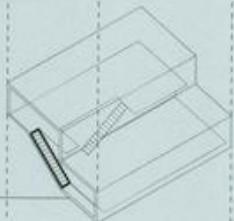


Shift

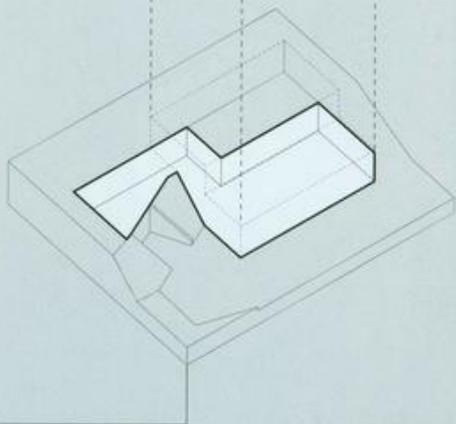
Operation - Shift



Condition - Connect



Condition - Ground

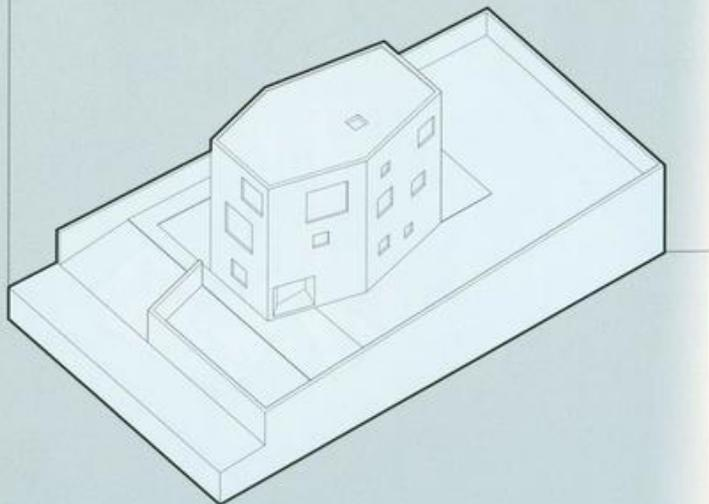


Wolf House

Pezo von Ellrichshausen Arquitectos

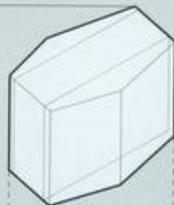


Photo by Cristóbal Palma

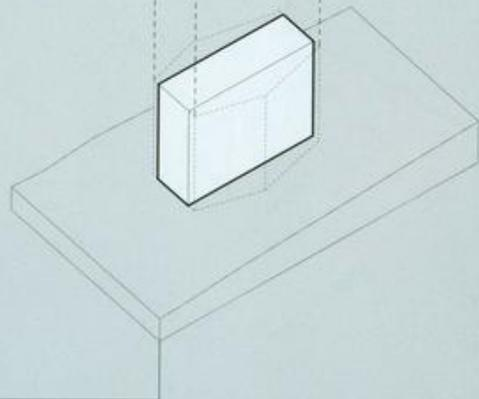
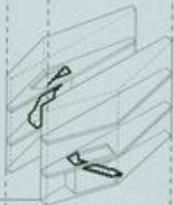


Expand

Operation - Expand



Condition - Connect



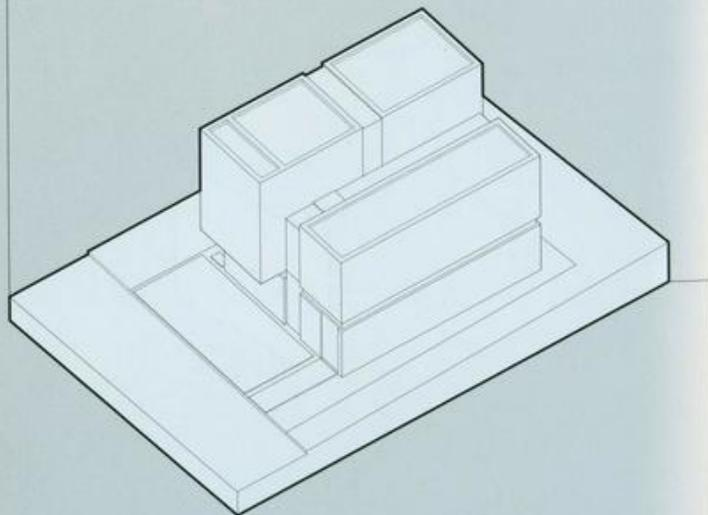
Dwelling Volumes

Gap House

Tetsushi Tominaga Architect & Associates

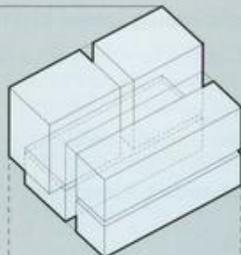


Photo by Suzuki Ken'ichi

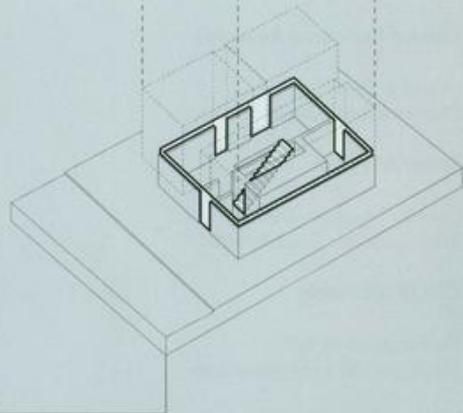
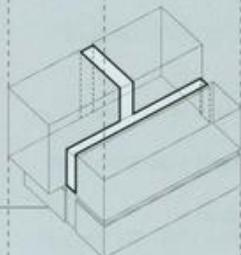


Fracture

Operation - Fracture



Condition - Open



Condition - Open + Connect

Acknowledgements

To firms and photographers that have contributed to this publication :

01 Arq

Lucernas House
Photographer : Aryeh Kornfeld

Apollo Architects & Associates

Knot House
Photographer : Masao Nishikawa

arnau estudi d'arquitectura

Bitten House
Photographer : Marc Torra

ARX Portugal + Stefano Riva

House in Juso
Photographer : FG+SG fotografia
de arquitectura

Colboc Franzen & Associés

House in Sèvres
Photographer : Cécile Septet

Javier de Antón

Country House in Zamora
Photographer : Esau Acosta

ODOS architects

Dwelling at Maytree
Photographer : Ros Kavanagh

Oficina d'Arquitectura

House in Serra de Freita
Photographer : Oficina d'Arquitectura

Pezo von Ellrichshausen Arquitectos

Wolf House, Poli house, Solo House
Photographer : Cristóbal Palma

Tetsushi Tominaga Architect & Associates

Gap House
Photographer : Suzuki Ken'ichi

I am grateful

to the students with whom I have worked: the small group of architecture students from Tufts University and all my students from Northeastern University's School of Architecture. Our collaboration has inspired this book.

to BIS Publishers and to Rudolf van Wezel, for his consistent trust in my work.

to my friends and family, for their encouragement and pride in me.

to Sandra Roque, for her support and patience.

to Nora Yoo, for her continued help with this project, her editing, and advice.

Biography

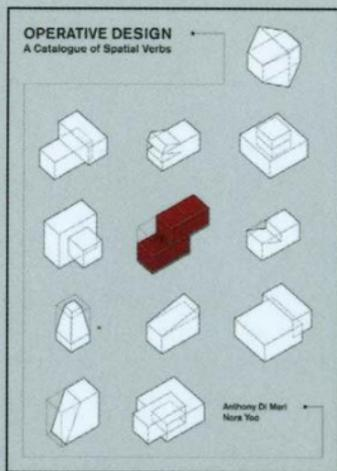
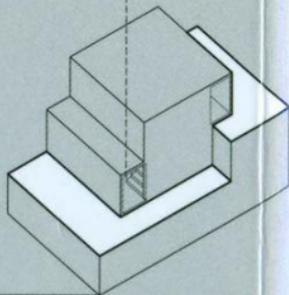
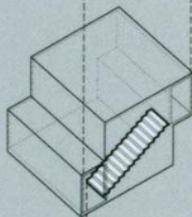
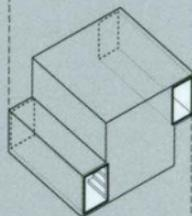
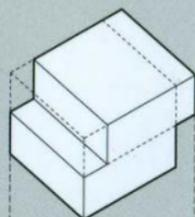
Anthony Di Mari

Anthony Di Mari has taught fundamental architecture studio courses at Northeastern University's School of Architecture and Tufts University. He was a studio and drawing instructor at Harvard University's Career Discovery Program in architecture. He is the co-author of *Operative Design: A Catalogue of Spatial Verbs*. Anthony's current design research focuses on dynamic patterns, interactive fields, and land art.

www.anthonymari.com

Operative Design introduced spatial formation as an active process derived from fundamental volumetric manipulations. This catalogue of illustrated verbs aimed to ignite architectural inquiry and instigate a formal design process. *Conditional Design* continues to build a systematic and iterative design logic while introducing scale through three basic architectural elements: connections, openings, and the ground.

Conditional Design further develops the operative method by bridging between abstract volumetric constructs and fundamental architectural elements.



ISBN 978-90-6369-365-7



9 789063 693657 >