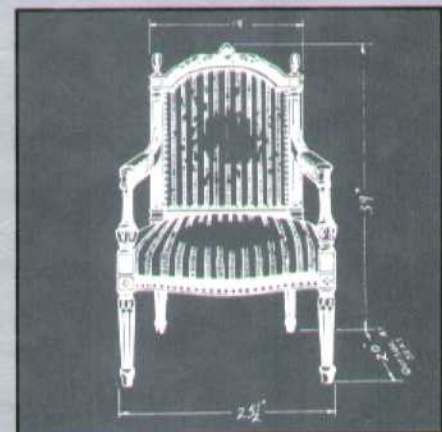
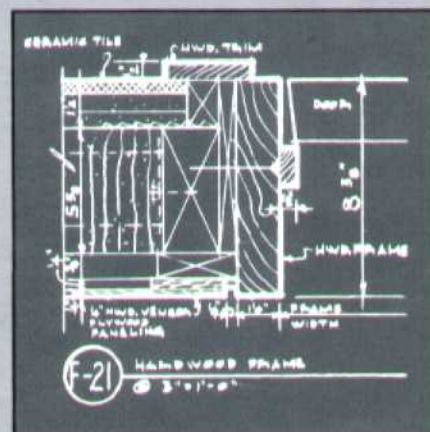
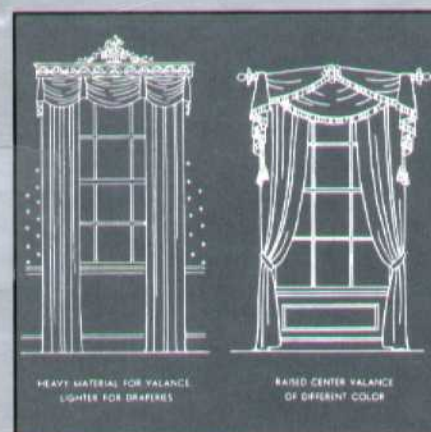
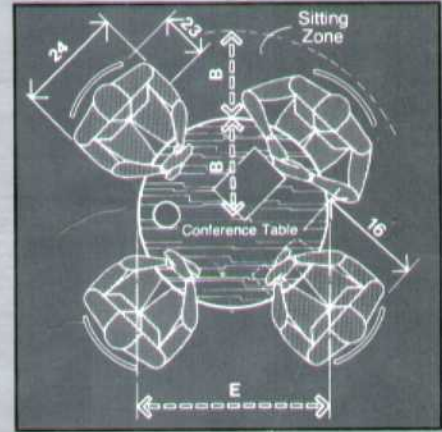
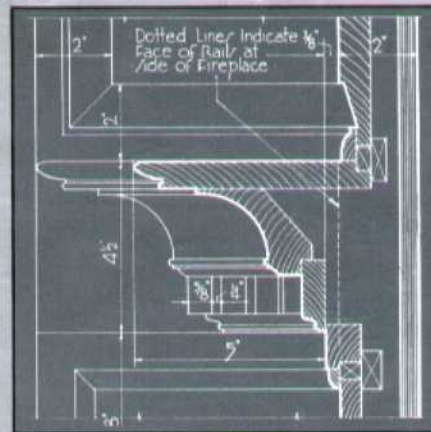
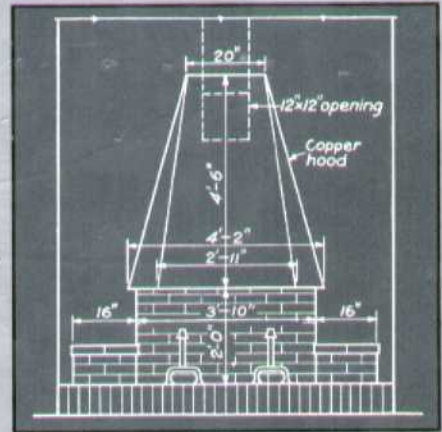
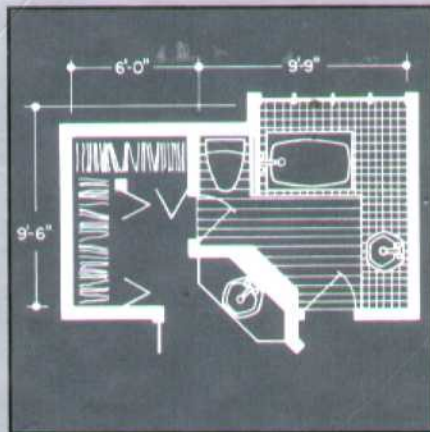
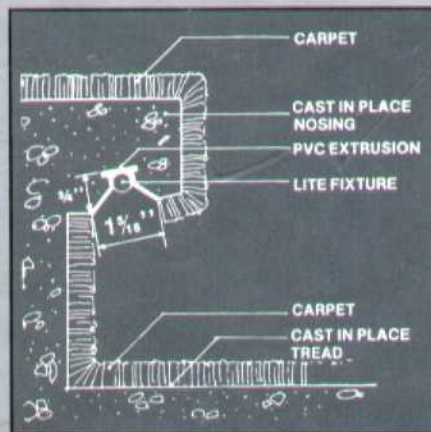


# TIME-SAVER STANDARDS FOR INTERIOR DESIGN AND SPACE PLANNING

JOSEPH De CHIARA JULIUS PANERO MARTIN ZELNIK



# **Time-Saver Standards for Interior Design and Space Planning**

**Joseph De Chiara  
Julius Panero  
Martin Zelnik**

**McGraw-Hill, Inc.**

**New York St. Louis San Francisco Auckland Bogotá  
Caracas Hamburg Lisbon London Madrid Mexico  
Milan Montreal New Delhi Paris San Juan  
São Paulo Singapore Sydney Tokyo Toronto**



# Contents

Contributors	vii
Organizations	ix
Foreword	xi
Preface	xiii
<b>1. Planning and Design of Interior Spaces</b>	<b>1</b>
<b>Residential Spaces</b>	<b>3</b>
Period furniture	5
Furniture dimensions	44
Living rooms	61
Dining rooms	80
Bedrooms	87
Bathrooms	100
Kitchens	149
Library/study	190
Family/recreation rooms	196
Laundry/sewing rooms	200
Closets/storage areas	206
<b>Office Spaces</b>	<b>221</b>
General offices and multiple workstations	223
Private offices	231
Electronic workstations	241
Conference rooms	249
Reception areas	260
Furniture, furnishings, and equipment	278
<b>Hospitality Spaces</b>	<b>305</b>
Restaurants	307
Bars	346
Hotels	374
<b>Retail Spaces</b>	<b>385</b>
Shops	387
Banks	396
Department stores	401
<b>Public Restrooms, Toilets, and Coatrooms</b>	<b>423</b>
Restrooms and toilets	425
Coatrooms	460

<b>2. Construction Details and Finishes</b>	<b>467</b>
Partitions and wall finishes	469
Floors and floor finishes	516
Doors	566
Ceilings	641
Stairs	660
Fireplaces	724
Lighting	743
<b>3. Architectural Woodwork</b>	<b>779</b>
Standard joinery and casework details	781
Woodwork details	804
Cornices and mouldings	866
Furniture hardware	887
<b>4. Specialties</b>	<b>903</b>
Landscape architecture	906
Signage and graphics	931
Audio-visual systems	949
Auditorium seating	961
Security	977
Color theory	998
Window treatments	1015
Elevators	1060
Indoor recreation	1069
Accessories	1075
<b>5. General Reference Data</b>	<b>1103</b>
Space planning	1106
Human factors	1110
Floor and wall covering	1122
Fabric	1130
Electrical	1132
Columns, capitals, and entablatures	1135
Nails, screws, and bolts	1136
Mathematical data and formulas	1139
Credits	1145
Index	1151



# Contributors

- Marvin Alfrime  
Andrew Alpern, AIA  
Amon & Graecen *Architects*  
David Appel, DLF, IALD  
Bertram L. Bassuk *Architect*  
Anthony Beaumont *Architect*  
Jeannie Bochette *Steelcase*  
Louis Bowman *Architect*  
Scott Bromley *Architect*  
Bromley Jacobsen *Architecture and Design*  
Jerry Caldari *Architect*  
Toni Chi/Albert Chen Associates  
Will Ching *Planning and Design*  
Barbara Cianci, IALD  
Cameron Clark *Architect*  
Davis, Brody & Wisniewski *Architects*  
Majorie Earthlife  
Brad Elias, ASID  
David Engel *Landscape Architect*  
Engel/GGP *Landscape Architects*  
Paul Eshelman, IDEC  
Evans, Moore, Peterson & Woodbridge *Architects*  
Charles D. Flayhan Associates, Inc.  
Frank J. Forster *Architect*  
Ulrich Franzen *Architect*  
Gensler Associates  
Franklin H. Gottschall  
Adrienne Grad  
Julius Gregory *Architect*  
Albert Halse  
Hochheiser Elias Design Group, Inc.  
Caleb Hornbolstel *Architect*  
Lees Horton  
ISD Incorporated  
Lawrence Israel, FAIA *Architect*  
Francis Joannes *Architect*  
Ely Jacques Kahn *Architect*  
Mary Jean Kamin, ASID  
William H. Kapple, AIA  
Joseph Kleiman  
Dorothy Lee  
Sammy Lee *Architect*  
Lori Lennon, ASID
- Howard Litton, ASID  
Steve Louie  
Ronald Lubman *Architect*  
Harry Lunstead Design, Inc.  
Michael Lynn *Architect*  
Michael Lynn & Associates  
Nathan Jerry Maltz, AIA *Architect*  
William M. Manley, FASID  
Mays, Simpson & Hunsicker *Architects*  
Merrill, Humble, and Taylor *Architects*  
Montgomery Winecoff & Associates, Inc.  
William Morgan, FAIA  
Bernhardt E. Muller *Architect*  
Richard J. Neutra *Architect*  
Julius Panero *Architect*  
Panero Zelnik Associates  
Parish Hadley Associates, Inc.  
Perkins & Will *Architects*  
Dennis Piermont, ASLA  
Nicholas Politis *Professor, Fashion Institute of Technology*  
John Russel Pope *Architect*  
William Pulgram *Architect*  
Ramey, Himes & Buchner *Architects*  
Antonin Raymond *Architect*  
Frank Rispoli  
Saarinen, Swanson & Saarinen *Architects*  
Jacqueline Siles  
The Space Design Group  
Richard Stonis  
William Tarr  
Andrew J. Thomas *Architect*  
Thompson, Robinson, Toraby, Inc.  
Darius Toraby *Architect*  
Michael Trencher *Professor, Pratt Institute*  
Verna, Cook, Salomosky *Architects*  
Walker & Gillette *Architects*  
Walker Group/CNI  
Leroy P. Ward *Architect*  
Edgar I. Williams *Architect*  
Charlie Wing  
Martin Zelnik *Architect*  
Simon B. Zelnik, FAIA *Architect*

# Organizations

A & J Washroom Accessories  
Access America  
Alvarado Manufacturing Co., Inc.  
American Olean Tile Company  
American Parquet Association  
American Sanitary Partition Corporation  
American Specialties, Inc.  
American Standard, Inc.  
Architectural Paneling, Inc.  
Architectural Woodwork Institute  
Armor Elevator Company  
Ascente  
Bauman  
Brown Manufacturing Co.  
Buckingham-Virginia Slate Co.  
Camden Window and Millwork  
Clairson International  
Closet Maid Systems  
Conde Nast Publications, Inc.  
Culter Manufacturing Corp.  
Curvoflite  
Designers Sign Company  
Dover Elevator Systems  
Eggers Industries  
Eljer Plumbingware Division of Wallace-Murray Corporation  
Euroflair  
Focal Point, Inc.  
Formica Corporation  
Franciscan Tile Company  
General Electric Lighting  
General Services Administration  
Glencoe Publishing Co.  
Habitat  
Hafele  
Hartco Flooring/Tibbals Flooring Co.  
Haws  
Herman Miller, Inc.  
Hollow Metal Manufacturers Association  
Horton Lees Lighting Designs, Inc.  
Howe Furniture Company  
Hussey Seating Company  
Illinois Agricultural Experiment Station  
Ilftala, Inc.  
Indiana Limestone Institute of America  
Insulated Steel Door Systems Institute  
Intergraph Corporation  
Interkal, Inc.  
JG Furniture Systems, Inc.  
Just Bulbs Ltd.  
Kinney Shoe Corporation  
Kirsch Division of Cooper Industries, Inc.  
Kohler  
Lapeyre Stair Co.  
Lehigh Furniture Corporation  
Library Bureau, Inc.  
Maclevy Health and Fitness Products  
Manville  
Marble Institute of America, Inc.  
Marvin Windows  
McGraw-Hill, Inc.  
McKinney/Parker  
Merillat  
Midwest Plan Service  
Modernfold  
National Association of Architectural Metal Manufacturers  
National Association of Ornamental Metal Manufacturers  
National Cathode Corp.  
National Retail Merchants Association  
National Terrazzo and Mosaic Association, Inc.  
Nesson Lamps, Inc.  
New York City Housing Authority  
Nichols Publishing  
Niland Company  
Osram Corporation  
PAM International  
Parker/Nutone  
Philips Lighting Co.  
Phillips & Brooks, Inc.  
Pittcon Softforms  
Pittsburg Corning Corp.



Putnam Rolling Ladder Co., Inc.  
Railex Corporation  
Roberts Step-Lite Systems  
Roppe Rubber Corporation  
St. Charles Kitchens  
Schlage Lock Company  
Schulte  
Selby Furniture Hardware Co., Inc.  
Simon and Schuster  
Sister Kenny Institute  
Steel Door Institute  
Steelcase  
Sweet's Division of McGraw-Hill, Inc.

Tarkett  
Tile Council of America, Inc.  
Triangle Pacific Corp.  
Western Wood Products Association  
Whirlpool  
White Consolidated Industries, Inc.  
Winebarger Church Furniture  
Woodwork Institute of California  
United States Dept. of Agriculture  
United States Dept. of Commerce  
United States Dept. of Housing and Urban Development  
United States Dept. of the Interior  
United States Dept. of Transportation

# Foreword

A resource of incredible range and detail, this volume was compiled by three remarkably inspired designers and educators. Because of their great knowledge of interior design and their sensitivity to the subject matter, they have created the most comprehensive source book for the field ever.

The editors spent three years bringing this volume to fruition, culling the best project drawings by outstanding designers to illustrate much of the subject matter and tapping their own anthropometric expertise to address space planning and special function areas. They also address the importance of historic influence on present-day design with an impressive review of period furniture and interior details. All of these things have produced a reference work of such scope and inclusiveness that the reader will be relieved of many hours in the pursuit of details and information, time saved that can be used for more innovation and creativity in developing solutions for client needs.

The authority and abundance of this book are a testimony to the maturation of this profession of ours and to the editors' appreciation and understanding of its importance.

*Jack Lowery, FASID, IDEC*

My pleasure in being invited to write part of the Foreword swiftly changed to respect and, in turn, awe at the scope and depth of this book.

To say that it is an encyclopedic compilation and mass of information is obvious. But it is especially and uniquely user-friendly. It presents the written and illustrative data without a trace of pedantry; it meets a real need in our interior designer professional resources. The editors' effort, dedication, and patience, sustained during a period of over three years, are truly heroic. An astonishing number of hours of input have produced a reference of incalculable value.

I offer the same cautionary advice mentioned in the Preface: If the book is a wonderfully comprehensive reference and support for interior design standards, historical material, suggested plan and design criteria, and regulatory limitations, it is not—it will never be—a substitute for the inspired, creative design act, for imaginative solutions are always driven by new cultural conditions, programs, and functional requirements.

So to all you designers: Continue to spin your dreams, but do not stray far from this great resource.

*Lawrence J. Israel, AIA, FISP*



# Preface

*Time-Saver Standards for Interior Design and Space Planning* is a professional handbook dealing with the planning, design, and detailing of interior spaces. Its primary goal is to provide, within a single reference, information that typically is found dispersed throughout a multitude of sources, including manufacturers' catalogs, technical literature, books dealing with historic styles, and documents and drawings from various projects.

This handbook can be used by the small and medium-size interior design or architectural firm to establish an instant reference library of design data and details by providing a broad selection of detail types and techniques. In addition, the large firm will be able to substantially augment and modify an existing library of details.

Perhaps the most unique feature of this handbook is the vast array of construction and woodwork details reproduced directly from actual working drawings contributed by some of the nation's leading interior design and architectural firms. It is this that makes the handbook particularly useful to the interior designer, architect, and student alike.

This book consists of five sections. The first, entitled Planning and Design of Interior Spaces, deals with residential, office, hospitality, and retail spaces in terms of the relevant planning, design, and detailing data specifically associated with each. The second section, entitled Construction Details and Finishes, deals with various basic interior construction components associated with most interior spaces. These components include partitions, wall openings, wall finishes, floors and floor finishes, doors, ceilings, stairs, fireplaces, and lighting. Details relevant to each component have been contributed by practicing interior designers and architects as well as manufacturers.

The third section, entitled Architectural Woodwork, deals with standard joinery and casework details, customized woodwork details, cornices and mouldings, and furniture hardware. The fourth section, entitled Specialties, deals with various specialized areas of equipment, systems, furnishings, and decoration, including signage and graphics, audio-visual systems, window treatments, and accessories. Information for these subject areas is drawn from manufacturers, suppliers, and designers.

The fifth section, entitled General Reference Data, provides the most comprehensive set of time-saving reference materials found in handbooks of this type, including tables, charts, formulas, and planning guidelines. Of particular interest to the architect, interior designer, and facility manager are tables that can be easily used to determine carpet and wall covering yardage. Charts and drawings relative to human factors and planning standards are also provided.

It should be noted that since the details and other information pre-

sented in this book have been compiled from so many different sources, it is difficult to ensure that all the data are entirely accurate or appropriate; for example, in some instances planning guidelines may reflect minimum acceptable standards and not necessarily ideal or preferred standards. In other instances the details indicated may have been perfectly adequate in the context of the total building design of which they were a part, but they may well require modification to reflect design conditions and the reader's intended use. It should also be noted that building codes, fire safety regulations, barrier-free standards, and many other laws governing the design and construction of buildings vary from state to state. Accordingly, the reader should consult all applicable local, state, and federal codes for conformance prior to applying any of the information contained in this book. Moreover, the reader is cautioned that the dimensional information provided in connection with furniture, equipment, appliances, accessories, etc., has been obtained from manufacturers and technical literature and thus varies from supplier to supplier and from source to source. Certain items may have been discontinued, others modified, and still others replaced. Although every effort has been made to ensure the reasonableness of the information, the reader is cautioned to consult the manufacturer of the item specified for current dimensional data.

The reader is also advised that most drawings and other illustrative material have been enlarged or reduced for reasons of page layout and page size. The reader is cautioned, therefore, to disregard any scale designations and not to scale the drawings in order to determine any additional dimensional information.

Finally, as mentioned before, the plans and details contained in this book were extracted from complete sets of actual working drawings prepared by many different contributors. They were selected both because they were representative of typical situations faced by the designer of interior spaces and because they were particularly informative. The authors would like to underscore the fact that these plans and details, as well as all the other material presented in this book, are intended to serve only as a helpful point of departure in connection with the design process, and not as a substitute for original thinking and creativity.

Although every effort has been made to present reasonably accurate information, the editors and publisher assume no liability or responsibility for damage to persons or property alleged to have occurred as a direct or indirect consequence of the use and application of any of the contents of this book. The reader is advised to view the subject matter primarily as guidelines for preliminary planning and detailing, and to properly review, modify, and process it to ensure conformance with local codes and practices and appropriateness of applicability.

*Joseph De Chiara  
Julius Panero  
Martin Zelnik*



# 1

## Planning and Design of Interior Spaces



# Residential Spaces

Period furniture	5
Furniture dimensions	44
Living rooms	61
Dining rooms	80
Bedrooms	87
Bathrooms	100
Kitchens	149
Library/study	190
Family/recreation rooms	196
Laundry/sewing rooms	200
Closets/storage areas	206



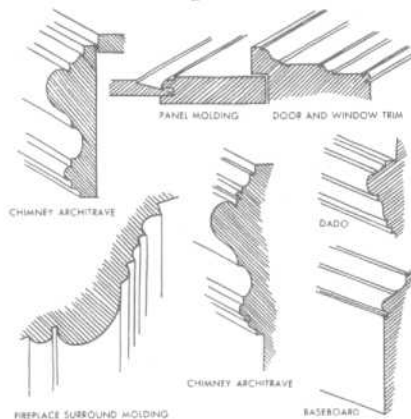


THE EXTERIOR

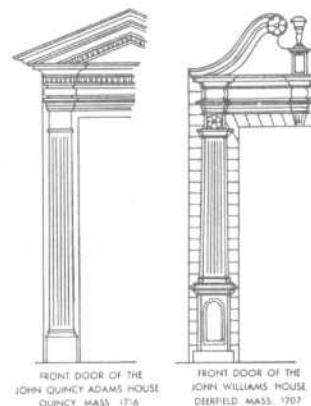


THE 17th Century immigrants brought to America the building traditions of their native lands. The Parson Capen house (1683) at Topsfield, Mass., for example, closely resembles English houses of the same period. But the clapboards are typically American. In the panels at right are close-up details of the Early Colonial background.

Moldings and trim



Doorway surrounds



THE LIVING ROOM



THIS living room is typical of those in the more elaborate Early Colonial homes. The crewel-embroidered curtains are blue-green with touches of red. This is taken up by the upholstery—blue-green damask for the sofas, red tapestry for the chairs. The Oriental rug and the portrait above the fireplace are both in tones of red, brown and yellow, with red dominant.

An alternative color scheme would have blue and yellow upholstery (needlework for the chairs, satin for the sofas). The walls would be pine-paneled, adorned with silver sconces, the curtains a bright cotton print in red, yellow, blue and white.

Living-room fabrics



PETIT-POINT ON SATIN



NEEDLEWORK PANEL



NEEDLEPOINT TAPESTRY

Wing chairs, sofas, armchairs, stools



Furniture made in America during the Early Colonial period (the seventeenth century and the first quarter of the eighteenth century) was necessarily, and possibly also by choice, of the simplest type. The early colonists, particularly those in New England, had not time or equipment to spare for any but the essentials of life.

Turning on the lathe was the simplest to achieve and thus the most common form of furniture decoration. It was also a process capable of infinite variations of design (some are shown in Fig. 1).

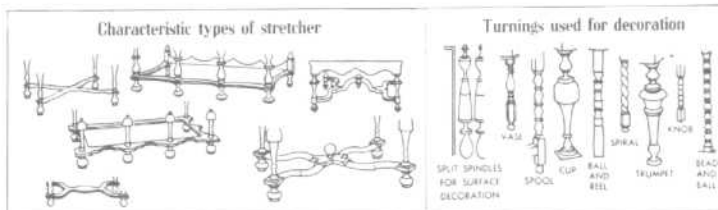
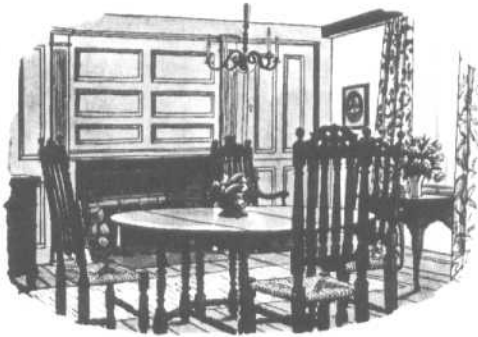


Fig. 1 Motifs characteristic of Early Colonial furniture.

PERIOD FURNITURE

17th Century American: Colonial

THE DINING ROOM



THE color scheme in this dining room is keyed to the low tones of the pine paneling and walnut furniture, the soft gleam of the smooth polished brass chandelier. The bannister back chairs have rush-bottom seats. Brilliant red and white printed cotton is used for the curtains. The hooked rug is in reds and greens.

Alternatively the curtains might be of red and yellow crewel embroidery, the upholstery of red brocade. In the panels at right are furniture and fabrics suited to an Early Colonial dining room.

Dining-room fabrics



NEEDLEPOINT TAPESTRY



CUT VELVET

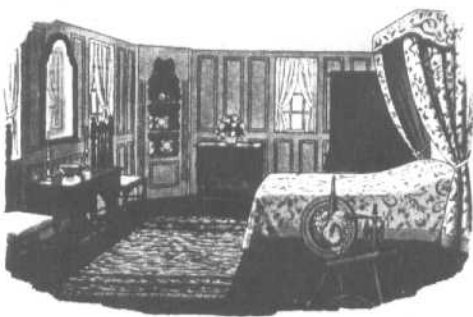


COTTON PRINT

Dining tables, table chairs



THE BEDROOM



THIS little bedroom with its pine paneling and low ceiling is typical of the Early Colonial period. The bed, decorated with hangings of crewel work in an Oriental design, is the most important feature of the room. The chairs are upholstered in yellow damask. The green printed cotton used for the little draped window curtains is echoed by the greens in the hooked rug on the floor.

Alternatively the walls might be painted a dark gray-blue, the curtain material being a red printed cotton on a gray ground. The furniture is of walnut and oak.

Bedroom fabrics



DAMASK



PRINTED CALICO



CREWEL EMBROIDERY BASED ON TREE OF LIFE DESIGN

Beds, daybed, cradle



Even the most costly furniture in this Early Colonial period was usually of solid wood unfinished except for stain or waxing. Veneering and shellacking, to gain carefully patterned graining and high finish, were still unexploited. The pine paneling on the walls might be left unfinished, waxed, or painted. Other woods near at hand in the forests and

so commonly used were oak, birch, maple, and walnut. Generally, American work is patterned upon English work of 10 or 20 years earlier. In Pennsylvania and Delaware, which were settled by colonists of Swedish and German descent (in addition to the English), much of the simple furniture was painted with its motifs transferred from Euro-

pean peasant art.

In the later years of the Early Colonial period, when New Englanders were already beginning to trade with the Orient, much Chinese porcelain was imported. The Oriental influence was strong in textiles; the Tree of Life pattern was very popular at this period. Native textiles copied the patterns

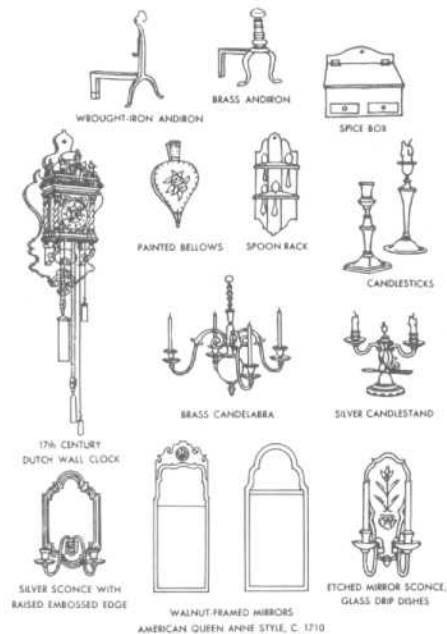
Armchair, side chairs



Sideboards, dressers, chests



Dining-room accessories



Chests, kas, highboy, chests of drawers



Desk, lowboys, night tables, stools



Bedroom accessories



and colors of India, Persia, and China. The originals, or good copies of them, were usually imported from England.

The colors in common use were of a piece with the solid, sturdy furniture. They seldom escaped from the conventional round of blue, red, gold, and natural gray. The only exceptions were imported fabrics and the occa-

sional hard brilliance of the Chinese porcelain found in the great houses of the day. Whatever luxury there was at this time expressed itself in textiles and silver rather than in furniture. Settlers in the South, many of them English aristocrats, maintained a higher standard of comfort than those in the North; they imported most of their furniture and fabrics

from England and continued to do so for a long time.

Early Colonial furniture taken as a whole is sturdy, but not subtle. Furniture patterns in this country changed slowly. Paneling relieved the larger flat areas such as cupboard doors and drawer fronts. The latter were further decorated by quite elaborate fretted

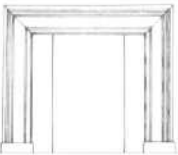
PERIOD FURNITURE

17th Century American: Colonial

Fireplace designs

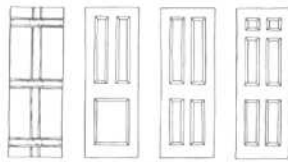


\* HORIZONTAL MOLDING ABOVE THE FIREPLACE OPENING IS A RUDIMENTARY VERSION OF THE MANTEL SHELF

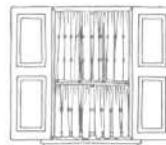


PLAIN MOLDED SURROUNDS WERE SOMETIMES MARBLEZED FOR VARIETY

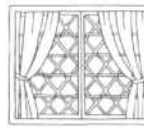
Eight typical paneled doors



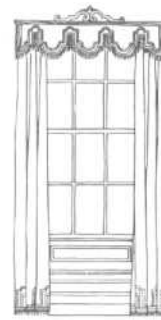
Drapery treatments for various window types



ON A 15-LIGHT WINDOW WITH INTERIOR SHUTTERS, TWO PAIRS OF GLASS CURTAINS



ON A PAIR OF LEADED CASEMENTS, SIMPLY DRAPED CURTAINS OF PRINTED COTTON



EMBROIDERY AT THE BOTTOM OF THE CURTAINS REPEATS THAT ON THE VALANCE



FOUR DIFFERENT TYPES OF VALANCE, USING FABRIC COVERED BOARDS, TAPE AND FRINGE

Corner cupboards, cabinets, secretaries, chest



Occasional tables, desk, lowboys, pedestals



Living-room accessories



brass and wrought-iron hardware (see Fig. 1). More carefully embellished than the earliest American furniture were the pieces imported by the colonists from their various homelands. These pieces, and the memories of others left behind, later served as models for American craftsmen. The dominant influence was Dutch, for the English had a Hollander, William of Orange, as king. He and his queen, Mary, gave their names to a style of which elaborate stretchers (particularly on highboys, lowboys, and occasional tables) and scrolled legs are among the most obvious characteristics.

Also from Dutch, Spanish, and Portuguese sources are derived most of the carved feet



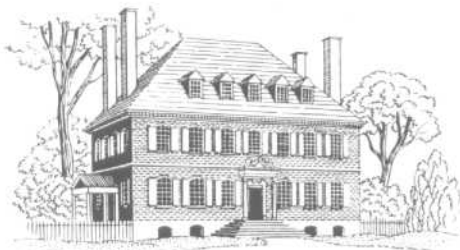
Fig. 1 (Continued)

which distinguish this Early Colonial furniture and often give clues to its date and place of origin.

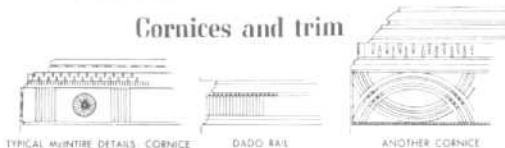
### THE EXTERIOR

The architectural details shown in the five panels at right are characteristic of the background for 18th Century Colonial decoration. As one of the finest houses of the period we have pictured (at right) "Westover" the great mansion erected by William Byrd in Charles City Co., Virginia. Typical of this period are the brick walls and chimneys, the stone or white painted brick trim. In the North wood was in more common use than brick for the exterior, and the interior wooden trim was finely detailed.

### Typical Colonial architecture

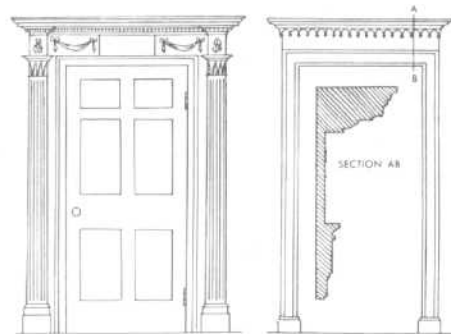


#### Cornices and trim



TYPICAL MOUNTING DETAILS: CORNICE DADO RAIL ANOTHER CORNICE

### Interior doorways



EARLY GEORGIAN CLASSIC MOTIF OF COLUMN AND SWAG. DOORWAY FROM KING'S CHAPEL, BOSTON

### THE LIVING ROOM

The furniture, fabrics and accessories shown in these panels are all suitable to the living room, and they are all typical of the 18th Century Colonial style.

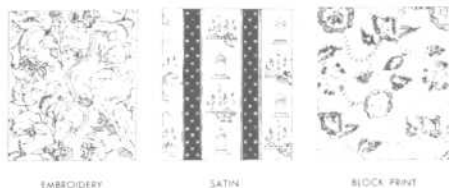
The interior pictured at right is a fine Colonial living room carefully restored to its 18th Century state. The walls are Naples yellow, the columns and fireplace white. Red and green are dominant in the Oriental rug, dark greens and browns in the portrait above the fireplace. So the sofa is upholstered in striped satin, the armchair in yellow Venetian brocade, the wing chair in a printed linen. The urns are of Chinese porcelain.

Another color scheme might be: pearly gray walls, oyster white columns and fireplace. Red would be dominant in the Oriental carpet, dark greens and red in the portrait. There would be red damask on the sofa, green rep on the wing chair, and gold damask for the armchair.

### Decorating a Colonial living room



#### Fabrics for curtains and upholstery



EMBROIDERY SATIN BLOCK PRINT

### Wing chairs, armchairs, sofas



CONNECTICUT WING CHAIR PHILADELPHIA VERSION OF HEFFLEWHITE MARtha WASHINGTON CHAIR  
CARRIAGE LEG SOFA 1760-1770 SETTEE CHIPPENDALE-INFLUENCE  
HEFFLEWHITE STYLE PHILADELPHIA TYPE DESK CHAIR CARRIAGE LEG PHILADELPHIA MAKE CHIPPENDALE STYLE  
PHILADELPHIA TYPE WING CHAIR CHIPPENDALE INFLUENCE MAHOAGANY CHIPPENDALE SOFA

Whereas furniture of the Early Colonial period was often so primitive as to be referred to as "kitchen Colonial," in this succeeding era dignity and luxury prevail in the centers of taste. The furnishings reflect the fashionable contemporary styles of England and stately country homes, whether on New England farms or Virginian and Carolina plantations, followed these styles. This gave rise to a number of notable architects, craftsmen, and workers in metal and wood.

The eighteenth century Colonial period was the first of the really great eras in American cabinetmaking.

The manufacture of wallpaper in this country was begun by 1763. Before this it was

from Europe. The "Pennsylvania fireplace" or "Franklin stove" was invented by Benjamin Franklin in 1742 and immediately became popular up and down the Atlantic seaboard. Philadelphia was a furniture style center, in fact the most active in the creation of taste, with Boston and Charleston following.

A number of artists and craftsmen of this period bear mentioning. Among the architects were Samuel McIntire, Charles Bulfinch, John James, Richard Mundy, Peter Harrison, John Kirk, and Isaac Royall. These men were greatly influenced by the English architects Isaac Ware, James Gibbs, Robert Morris, Abraham Swan, William Halfpenny,

Batty Langley, and William Pain, who in turn were in debt to the Italian masters Palladio and Giacomo Leoni. Among the cabinet-makers were Moses Dodge, Stephen Dwight, Henry Hardcastle, Gilbert Ash, Robert Wallace, Charles Shipman, John Brinner, John Tremain, Charles Warham, John Brown, Bemsley Wells, Thomas and Benjamin Laskey, Jonathan Goodhue, and Job Trask. Among the upholsterers were Stephen Callow, Richard Wenman, Joseph Cox, and John Taylor; among the metalworkers were William Coffin, Wilkins, Joseph Liddell, William Bradford, John Bassett, and Peter Harby; and among the painters were John Singleton Copley, Joseph Blackburn, John



## PERIOD FURNITURE

18th Century American: Colonial

## DINING ROOM

The furniture and fabrics shown in the five panels at right would look well in any dining room; but for your guidance in the selection of materials and colors we illustrate at right a fine Colonial dining room as it might have appeared in the 18th Century.

The pine-paneled walls are colored a light ocher, the niches Chinese red. Curtains are French blue. Blue, rust and beige predominate in the Oriental rug, dark green, blue and black in the portrait over the fireplace. Table and chairs are of walnut, the sideboard of mahogany.

An alternative color scheme would be light blue-gray walls with cream niches. Curtains would be oyster white silk, the Oriental rug having a greenish tan background.

## Decorating a Colonial dining room



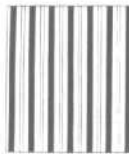
## Fabric for curtains and upholstery



BROCADE



PRINTED LINEN



STRIPED BROCADE

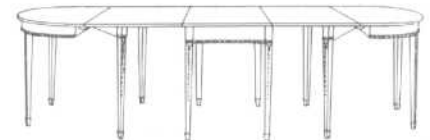
## Dining tables, consoles

MAHOGANY  
CONSOLE  
WITH MARBLE TOP  
AMER. CHIPPENDALE STYLE

CABRIOLE LEG, DROP LEAF DINING TABLE

PHILADELPHIA MAKE  
SHERATON INFLUENCEAMERICAN HEPPLEWHITE  
DINING TABLEAMERICAN  
HEPPLEWHITE

CONSOLE TABLE 1760-1770



EXTENSIBLE DINING TABLE 1770

## BEDROOM

In the bedroom at right, choice of color and textures was designed to achieve an impression of warmth and intimacy. The paneled walls are in two tones of gray-green, the ceiling ocher. Curtains are antique gray-green satin.

Furniture is walnut, except for the mahogany bed, which has a yellow taffeta spread. Fireside chairs are covered in crimson damask side chairs in turkey work.

An alternative color scheme would be: warm gray walls with oyster white moldings. The ceiling would be cream, the carpet solid taupe, and the curtains of blue damask. The bed would have a white moire spread and blue valance. The side chairs would be upholstered in yellow damask, the wing chair in turkey work.

## Decorating a Colonial bedroom



## Fabrics for curtains, upholstery, canopy



PRINTED LINEN



TOILE DE JOUY



DAMASK

## Four-poster beds



MAPLE LOW POSTER BED



FIELD BED AND TESTER



FIELD BED AND TESTER



LATE 18TH CENTURY TYPE

Ramage, James Peale, and Charles Wilson Peale. Important manufacturers were, of wallpaper, Jackson of Battersea (England) and, of window and bottle glass, Baron Stiegel and Caspar Wistar.

Fabrics most commonly used during the Colonial period were damask, camblet, Indian gimp and binding, moreen (woolen drapery cloth), harrateen cloth, block-printed

cotton and linen, cashmere, calico, dimity, durance, stout worsted cloth, turkey work (tufted "pilelike"), paduasoy (strong silk), soy, shalloon, watchet, linsey-woolsey, fustian, silk muslin, chintz, Indian calico, tabby, sarsenet, taffeta, horsehair, camak, bancours, and brocade.

Woods most commonly used were oak, ash, elm, red cedar, mahogany, walnut, ma-

ple, pine, and cherry.

The Chippendale style merges at one end with Queen Anne, at the other with Hepplewhite, Sheraton, and Duncan Phyfe. The Rococo mounts to its zenith and starts to decline within these years. Walnut has a new rival in mahogany. And American craftsmen produced pieces of a quality which compares favorably with English work.



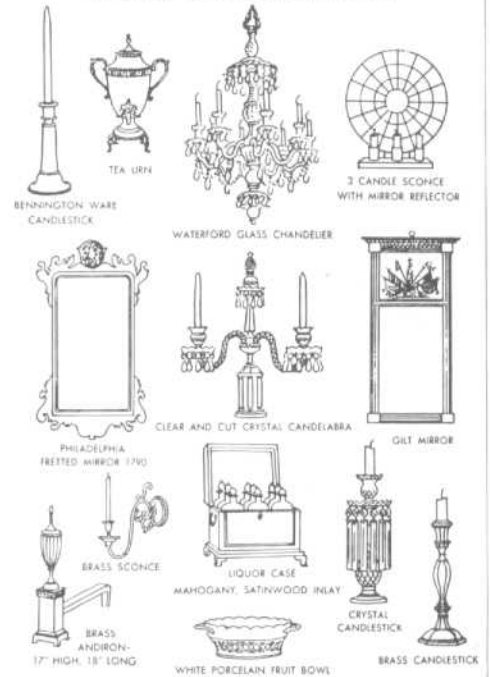
Armchairs, side chairs



Sideboards, lowboys, chests



Dining room accessories



Chests, kas, secretary



Wing chairs, armchairs, tables



Bedroom accessories



Marble was imported until after the Revolution when domestic marbles began to be used. Marble chimney pieces, window sash, lead roofing, and hardware were all imported from London. The size of glass window panes gradually increased as the century progressed.

An order of small pilasters or columns supporting the mantel in a chimney piece

was found only in imported work prior to the Revolution. Fireplace openings with neither cornice nor mantel shelf were long common. Ears on the architraves were almost universal, and a pediment (always broken) was very common. After 1760 the scroll pediment, or a similar treatment of the architrave, occurs.

PERIOD FURNITURE

18th Century American: Colonial

Fireplace designs

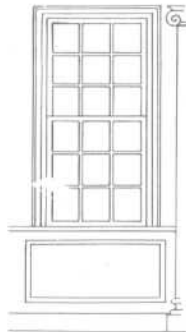


FINE COLONIAL CHIMNEY PIECE  
SHELF 7-11" WIDE, 3-11" HIGH  
WOOD OPENING 3-4" WIDE,  
3-8" HIGH  
WIDTH MIDWAY 6-11"  
3" PROJECTION

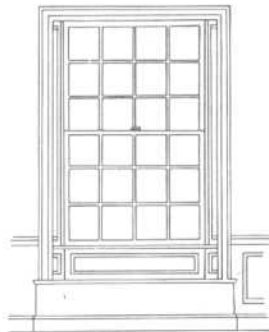
CHIMNEY PIECE IN THE  
STYLE OF SAMUEL MCINTIRE  
SHELF 5-11/2" WIDE, 4-0" HIGH  
WOOD OPENING 3-8" WIDE,  
3-0" HIGH  
WIDTH MIDWAY 4-11"  
4" PROJECTION



Window details



SMALLER DOUBLE HUNG WINDOW  
PLACED ABOVE DADO, 6 PANE SASH



MORE ELABORATE RECESSED TYPE WITH  
WINDOW SEAT BELOW, 12 PANE SASH

Drapery treatments



CLASSIC TYPE OF DAMASK DRAPING USUALLY  
ORNAMENTED WITH AN ELABORATE FRINGE



TYPE OF DRAPERY USUALLY DONE IN  
TAFETTA AND LEFT PLAIN OR FRINGED

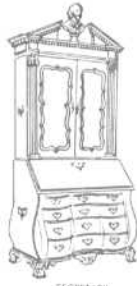
Secretaries, highboy, clocks



HIGHBOY  
CHIPPENDALE INFLUENCE



BRACKET CLOCK



SECRETARY  
WITH BOMBE BASE  
ROCOCO



CLOCK WITH  
PAINTED GLASS PANEL



MAHOGANY  
GRANDFATHER'S CLOCK



MAHOGANY BREAKFRONT  
CHIPPENDALE STYLE



GRANDFATHER'S CLOCK  
BY J. WILDER OF HINGHAM

Desks, tables, firescreen



LATE  
SOUTHERN COLONIAL  
1760



POLE FIRE SCREEN  
1775



MAHOGANY  
SIDE TABLE



WALL TABLE



LATE  
SOUTHERN COLONIAL  
CARD TABLE



SLANT TOP DESK  
1730



KNEEHOLE MAHOGANY DESK  
RHODE ISLAND BLOCKFRONT



TIP TOP TEA TABLE  
C. 1775



MAHOGANY CONSOLE TABLE

Living room accessories



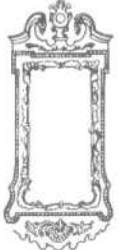
SANDWICH GLASS  
OIL LAMP



GLASS DOLPHIN  
CANDLESTICK



PEWTER  
SCONCE



COLONIAL  
IN FULL ROCOCO SPIRIT  
QUEEN ANNE INFLUENCE



MINIATURE FRAMED  
IN ROPE MOLDING



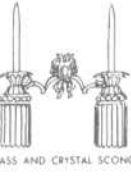
URN



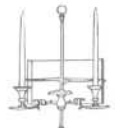
PAUL REVERE SILVER TEAPOT  
1789



PEWTER TEAPOT  
1775



BRASS AND CRYSTAL  
SCONCE



CANDELABRA  
USED BY  
GEORGE WASHINGTON



CARVED AND GILT MIRROR



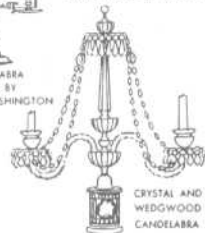
MAHOGANY  
BOX



CANDELABRA  
USED BY  
GEORGE WASHINGTON



BRASS ANDIRONS 21" HIGH 25" LONG



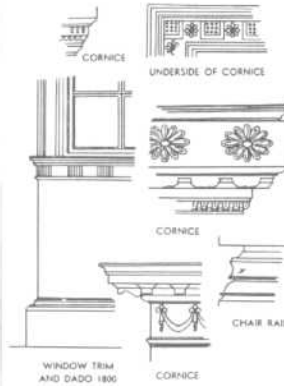
CRYSTAL AND  
WEDGWOOD  
CANDELABRA

THE EXTERIOR

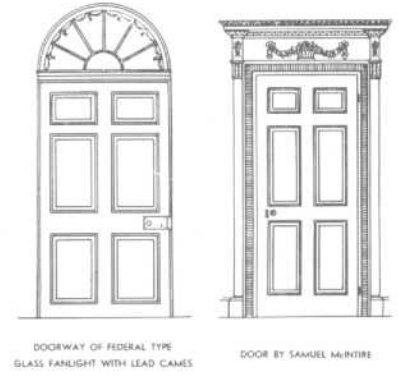


As a typical mansion of the Federal period we show Mappa Hall in Trenton, N.Y. It was started in the closing years of the 18th Century and completed in 1809. The portico and the simple pediment exemplify the prevailing Classic trend. In the panels to the right are some typical details from the Federal period background

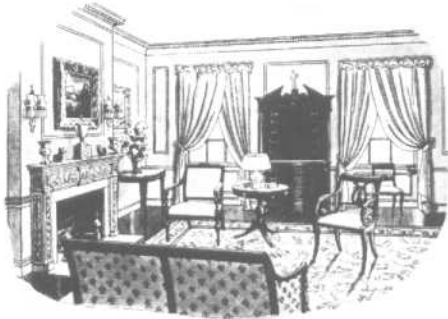
Cornices and trim



Doorways for the interior



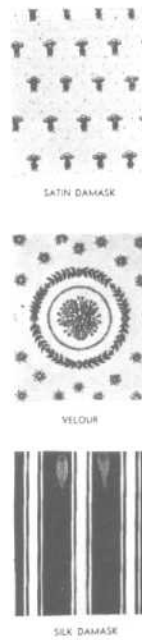
THE LIVING ROOM



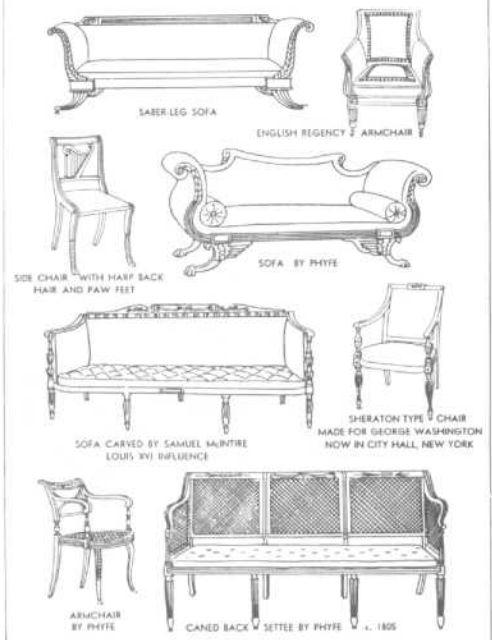
This is a fine Federal interior in its original condition. The walls and woodwork are painted pistachio green. The curtains are of beige damask, the sofa upholstered in red and gold damask. Gold damask is used for the armchairs, yellow damask for the side chairs. The Oriental rug is wine red in tone, the furniture, mahogany. The clock is of ox-blood marble.

An alternate scheme would have light gray-blue walls and woodwork. The draperies would be yellow damask, the chairs upholstered in green damask. The furniture and fabrics shown in panels at right would also be suitable for the Federal living room

Living room fabrics



Armchairs, side chair, sofas



The Federal style is at its most suave and elegant in the furniture of Duncan Phife, a Scotch cabinetmaker who arrived in New York about 1795. He did not originate a style; he translated prevailing fashions into fine craftsmanship. Thomas Sheraton, then the current English favorite, and the French Directoire cabinetmakers set the style. All these designers were profoundly influenced by a rediscovery of the classic splendors of Greece and Italy.

Reeding of table, chair, and sofa legs and other framing members gives elegance to Federal furniture. Contrasting color veneer is used to outline the edges of tables and desks and to lend interest to large plain surfaces.



Fig. 2 Motifs characteristic of Federal furniture.

PERIOD FURNITURE

18th Century American: Federal

THE DINING ROOM

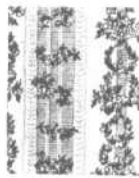


**I**N THE dining room shown above the walls are mist gray, the chimneypiece ochre and white marble. The drapery and upholstery are both cherry silk damask. The Oriental rug is in tones of brown, blue and beige. The furniture is mahogany.

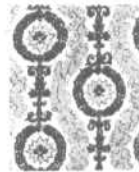
An alternate scheme would include: soft gray-green walls, beige silk damask curtains, red damask upholstery. The sconces, clock and picture frames would be gilt.

This original Federal period dining room will give you ideas for using the furniture and fabrics shown in the panels at right. Or reproductions of similar pieces are appropriate.

Dining room fabrics



SATIN



PRINTED SILK



BROCATELLE

Dining tables, side tables, console



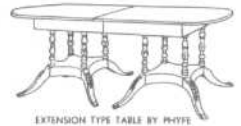
PEDESTAL DINING TABLE



LYRE END TABLE BY PHYFE



CONSOLE WITH EGYPTIAN CARYATIDS



EXTENSION TYPE TABLE BY PHYFE



PEDESTAL DINING TABLE



SOFA TABLE BY PHYFE

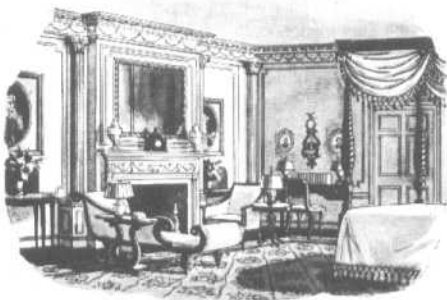


FOUR SOFA TABLES JOINED TO FORM A DINING TABLE



FOLDING TOP OCCASIONAL TABLE

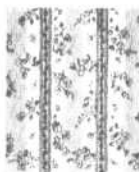
THE BEDROOM



**T**HIS bedroom shown above is typical of those found in fine houses during the Federal period. Walls, woodwork and chimneypiece are painted moss green. The upholstery is beige damask, except for yellow satin on the desk chair. The rug is in two tones of burgundy with a design of green, pink and white. On the walls are engravings in gilt frames.

An alternate color scheme would have walls and woodwork painted peach color. The rug would then be olive green with a design in yellow and pink. The upholstery would be blue, except for red satin on the seat of the desk chair. Other furniture and fabrics suitable for this room are shown at right.

Bedroom fabrics



SILK



SATIN

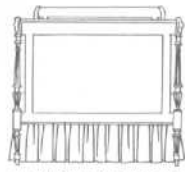


DAMASK

Four-poster and other types of bed



FOUR-POSTER BED BY PHYFE



BED BY PHYFE, LOUIS XVI AFFINITY



MAHOGANY BED ONE OF A PAIR BY PHYFE

BED BY PHYFE FRENCH INFLUENCE

Another characteristic subtlety is the raised hairline of wood, known as a cock beading, which is used to finish off the edges of drawers. Phife used white wood linings for the drawers in his furniture, instead of the pine linings universally employed by other American cabinetmakers of this period.

Brass ornaments (probably for the most part imported) are used extensively on

Federal pieces. They have brass feet and casters, ring handles, and other types of applied ornament. Toward the end of the period, about 1825, china and glass knobs began to supplant brass rings as drawer pulls.

The new United States was in its first throes of nationalism; consequently its emblem, the eagle, appears everywhere — on

transparencies in windows, painted on fans, inlaid in mirrors, desks, knife boxes, and brass work. The "Spread Eagle" became a favorite tavern sign. All kinds of historic scenes and patriotic emblems appear as decoration on clocks.

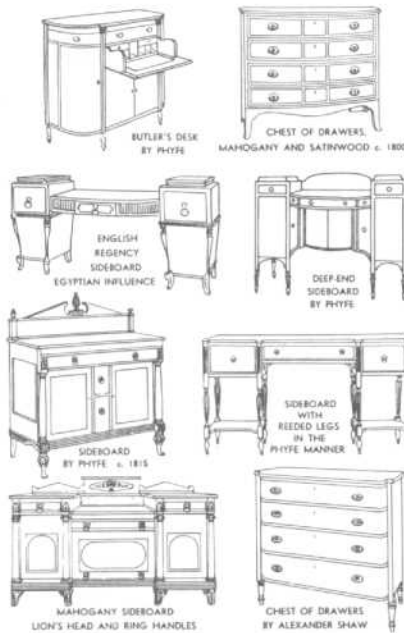
And yet, the Classic influence was even stronger than the patriotic. Earthenware and porcelain such as Crown-Derby, Worcester,

Armchairs, side chairs



TYPICAL CHAIRS OF AMERICAN FEDERAL DESIGN 1790-1830

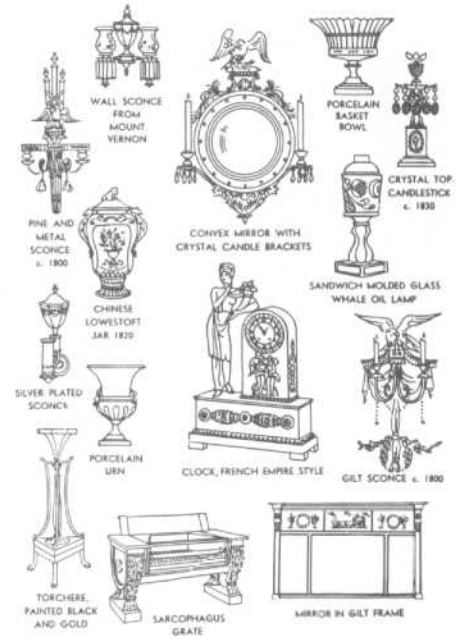
Sideboards, chests of drawers



MAHOGANY SIDEROARD LION'S HEAD AND RING HANDLES

CHEST OF DRAWERS BY ALEXANDER SHAW

Dining room accessories



CLOCK, FRENCH EMPIRE STYLE

Dressing tables, wardrobe, chests



CHEST OF DRAWERS BY JOHN SEYMOUR MAHOGANY AND MAPLE VENEER

MAHOGANY DRESSING TABLE

CHEST OF DRAWERS BY SAMUEL MONTRE

DRESSING TABLE BY PHYFE c. 1815

DRESSING TABLE MADE BY PHYFE FOR HIS DAUGHTER ELIZA

MAHOGANY BUREAU AND MIRROR BY WILLIAM HOOK

MAHOGANY WARDROBE

Chairs, stools, tables, desks



ARMCHAIRS BY PHYFE

UPHOLSTERED CHAIR BY PHYFE

FAUBOUR WORKTABLE

NIGHT TABLE

WORK TABLE

SHERATON TYPE WRITING TABLE

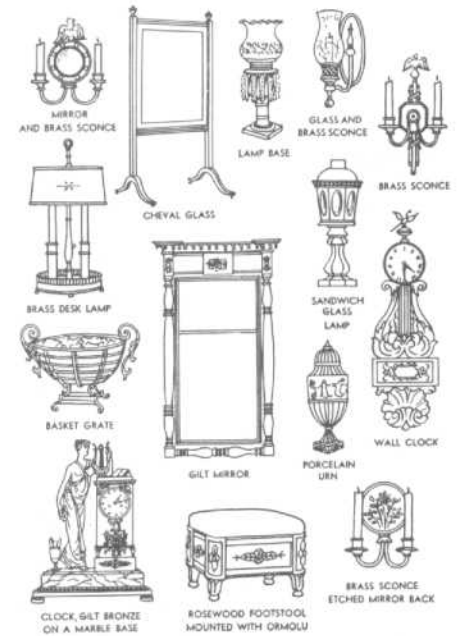
FIGURED MAHOGANY CABINET DESK

BLACK AND GILT PAINTED CURULE CHAIR

STOOL SHERATON AFFINITY

MAHOGANY WINDOW SEAT CANED SEAT, CABRIOLE LEGS

Bedroom accessories



MIRROR AND BRASS SCONCE

CHEVAL GLASS

LAMP BASE

GLASS AND BRASS SCONCE

BRASS DESK LAMP

BRASS SCONCE

BASKET GRATE

SANDWICH GLASS LAMP

WALL CLOCK

CLOCK, GILT BRONZE ON A MARBLE BASE

GILT MIRROR

PORCELAIN URN

ROSEWOOD FOOTSTOOL MOUNTED WITH ORMOLU

BRASS SCONCE ETCHED MIRROR BACK

and Wedgwood were molded in Classic forms and painted with delicate sepia figures in Classic robes. Silver and Sheffield plate (the latter replacing pewter) also followed Classic forms. Ireland sent Waterford glass.

Fabrics most used were damask, brocade, satin, taffeta, haircloth, toile de Jouy, printed cotton, and silk.

Woods most used were mahogany, cherry,

and maple; and fruit woods in less splendid furniture. Curly maple often replaced the satinwood used in European models. After 1800 rosewood was used for the more costly furniture.

The Federal motifs derive almost exclusively from classical sources. The acanthus leaf, the lyre, the saber leg, the lion's mask and paw, the bowknot, rosettes,

thunderbolts, trumpets, and drapery swags are all to be found on the list of standard Federal furniture motifs.

After the War of 1812, when the Federal era rose to its zenith of popularity, the laurel, cornucopia, and eagle motifs became especially popular. (See Fig. 2.)

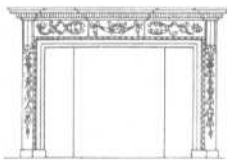
Phyfe's treatment of the acanthus leaf is so typical that many of his pieces depend upon



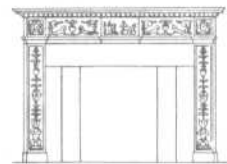
PERIOD FURNITURE

18th Century American: Federal

Fireplace designs

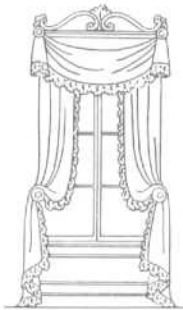


CHIMNEY PIECE FROM BEACON HILL, BOSTON



CHIMNEY PIECE DESIGNED BY CHARLES BULFINCH

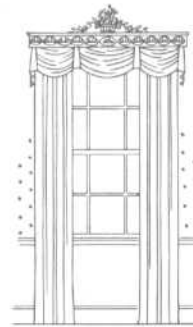
Drapery treatments for five different types of window



FEDERAL DRAPERIES THROWN OVER TIEBACKS



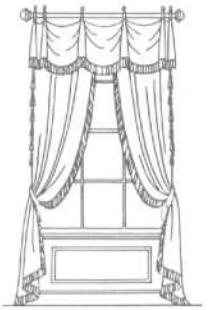
SINGLE PANEL CURTAIN BALANCED WITH OTHER WINDOW



HEAVY MATERIAL FOR VALANCE, LIGHTER FOR DRAPERIES



RAISED CENTER VALANCE OF DIFFERENT COLOR



TYPICAL HEAVY FRINGES, CONTRASTING COLOR LINING

Secretaries, bookcases, cabinet, chest



ROSEWOOD CABINET WITH GILT METAL GRILLES

TAMBOUR SECRETARY BY SAMUEL MINTRE, MAPLE, MAHOGANY, SATINWOOD

MAHOGANY SECRETARY c. 1800

FAWN-COLORED BOOKCASE WITH GOLD DECORATION

SATINWOOD SECRETARY, REGENCY TYPE

CHEST ON CHEST BY SAMUEL MINTRE

ROSEWOOD BOOKCASE MOUNTED WITH ORMOLU

Desks, tables, piano, music desk



MAHOGANY DROP-LEAF TABLE BY PHYFE

WALL TABLE BY PHYFE, CROSSED LYRES SUPPORT

LIBRARY TABLE BY PHYFE

FIVE LEGGED CARD TABLE, FOLDING TOP

BLACK AND GILT PAINTED WRITING TABLE

MAHOGANY MUSIC DESK c. 1800

OCCASIONAL TABLE c. 1800

DESK BY PHYFE

MAHOGANY MUSIC DESK c. 1800

OCCASIONAL TABLE c. 1800

WRITING DESK

MAHOGANY DESK c. 1800, SHERATON STYLE

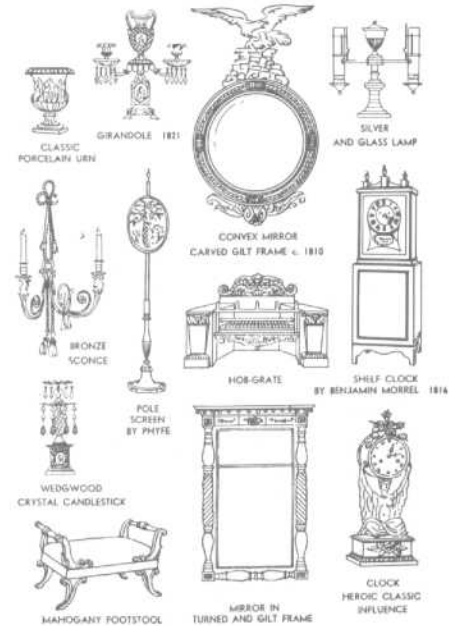
MAHOGANY DESK c. 1800, SHERATON STYLE

WRITING DESK

MAHOGANY DESK c. 1800, SHERATON STYLE

MAHOGANY DESK c. 1800, SHERATON STYLE

Living room accessories



CLASSIC PORCELAIN URN

GRANDIOLE 1821

CONVEX MIRROR, CARVED GILT FRAME c. 1810

SILVER AND GLASS LAMP

BRONZE SCONCE

POLE SCREEN BY PHYFE

HOB-GRATE

SHelf CLOCK BY BENJAMIN MORRELL 1814

WEDGWOOD CRYSTAL CANDLESTICK

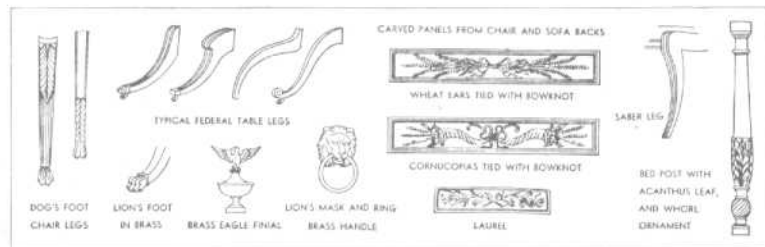
MAHOGANY FOOTSTOOL

MIRROR IN TURNED AND GILT FRAME

CLOCK, HEROIC CLASSIC INFLUENCE

this for their identification. It is simplified into a series of rounded grooves and ridges with a raised tapering ridge up the center.

The lyre was used to fill in the backs of chairs, to decorate the arms of sofas, and (split apart) to support mirrors on dressing tables. Two crossed lyres are used as support for a pedestal table.



DOG'S FOOT CHAIR LEGS

LION'S FOOT IN BRASS

BRASS EAGLE FINIAL

LION'S MASK AND RING

BRASS HANDLE

LAUREL

SABER LEG

BED POST WITH ACANTHUS LEAF AND WHORL ORNAMENT

CARVED PANELS FROM CHAIR AND SOFA BACKS

WHEAT EARS TIED WITH BOWKNOT

CORNUCOPIAS TIED WITH BOWKNOT

Fig. 2 (Continued)

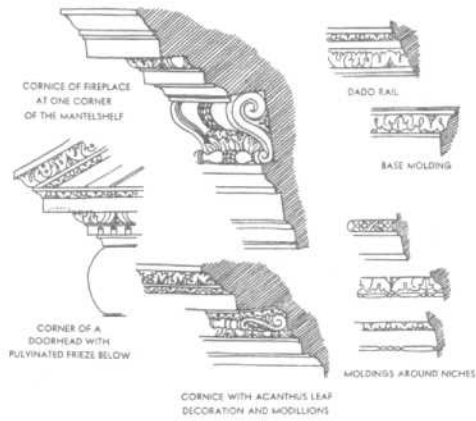


THE EXTERIOR



TYPICAL of the better country houses in the second half of the 18th Century, is this design from Abraham Swan's *British Architect*, one of the many handbooks of builders' designs, which at this period carried news of architectural fashions from England to America. At right are close-up details of the Georgian background

Moldings and trim

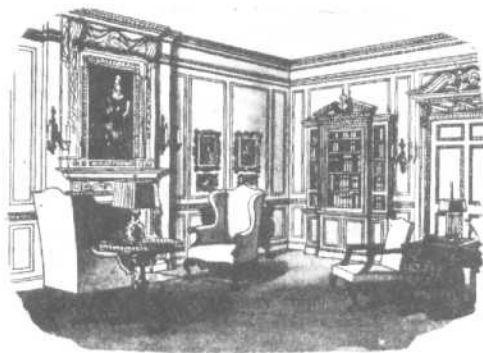


Interior doorway



CARVED PINE DECORATION COMBINES CLASSIC AND ORIENTAL MOTIFS

THE LIVING ROOM



THE pine-paneled walls in this characteristic Georgian living room are left unstained. The silk curtains are richly embroidered in many colors on a yellow ground which echoes the gilt frames used for pictures and mirrors. The crimson upholstery of the mahogany furniture is given added quality by the olive green carpet.

An alternative color scheme would be to have the walls painted dark gray-green with carving picked out in gold. The wall-to-wall carpet would be taupe, the upholstery of the wing chairs yellow Italian damask. In both color schemes needlepoint and natural leather would be used for upholstering other chairs in the room

Living-room fabrics



Armchairs, sofas, settees



Chippendale was a dominating factor in the history of Georgian furniture design and his name serves as a convenient tag for the period centering in the reign of the second of the three Georges who provide the period title. Yet this English cabinetmaker achieved eminence not so much by his own work as by that of his copyists.

They all used the designs in *The Gentleman and Cabinet-Makers' Director*, published by Chippendale in 1754. To fill this book Chippendale commandeered all the ideas he could lay his hands on and then embroidered them with his own fancy, adapted them to his own forms. He plundered the design manuals of China and the French rococo, of the ancient Gothic masters, and of his immediate predecessors in the English furniture trade.

From the craftsmen of the early eighteenth century Chippendale borrowed such tested forms as the cabriole leg, the claw-and-ball foot, and the typical acanthus leaf ornament. But to each of them he added a grace and

charm of which the earlier furniture makers had never been capable.

Thomas Chippendale was a typical product of that brilliant English society which flourished during the mid-eighteenth century. He

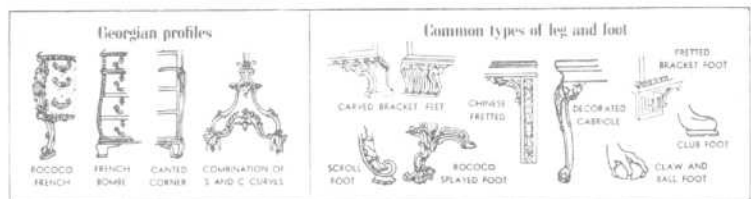


Fig. 3 Motifs characteristic of Georgian furniture.

PERIOD FURNITURE

18th Century English: Georgian

THE DINING ROOM



HERE the walls are pine-paneled, the wood being left its natural honey color. The consoles are also of pine. But brilliant against this pale background are the red damask curtains, and the mahogany furniture with its red and yellow striped silk upholstery.

Alternatively, the walls might be painted light blue as a background for yellow brocade curtains. The mahogany table and chairs stand on an Oriental rug which repeats colors found in the needlepoint upholstery. In the panels at right is furniture suitable for a room of this style

Dining-room fabrics



CUT VELVET



CHINTZ



SILK BROCADE

Armchairs, side chairs

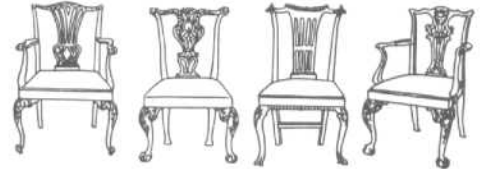


ELABORATED SHELL BACK

CHINESE INFLUENCE IN DECORATION OF BACK SLATS AND CARRIAGE LEGS

LADDER BACK

AMERICAN CHIPPENDALE SIMPLIFIED

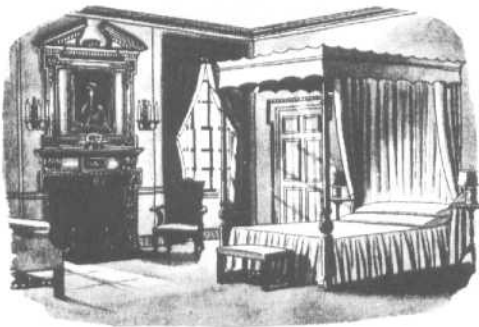


OTHER CHARACTERISTIC EARLY GEORGIAN DESIGNS



CHIPPENDALE WITH CHINESE ORNAMENT

THE BEDROOM



CHARACTERISTIC of the Georgian period are the richly embroidered Chinese silk draperies and the delicately fretted four-poster bed in this room. The dominant tone is yellow, against which is posed green upholstery, with a gun-metal carpet for base, putty walls for background.

Alternatively the walls could be pale green, the carpet brown, the upholstery blue-green and yellow, the ceiling pale apricot. In the panels at right are other pieces suitable for a room of this type. Modern reproductions of such authentic pieces are available in good furniture stores

Bedroom fabrics



CHINESE SILK BROCADE



PRINTED TAFFETA



PAINTED SATIN

Four-poster and canopy beds



CHIPPENDALE BED WITH PAINTED SILK HANGINGS

CHIPPENDALE FIELD BED WITH CANOPY



COUCH BED DESIGNED FOR AN ALCOVE



CHIPPENDALE IN ROCOCO MANNER

was a contemporary of Josiah Wedgwood, the potter, and of Edmund Burke, the orator. Boswell and Johnson, Benjamin Franklin, Garrick, Gibbon, and Goldsmith, all added their wit and intelligence to the creation of a sturdy culture.

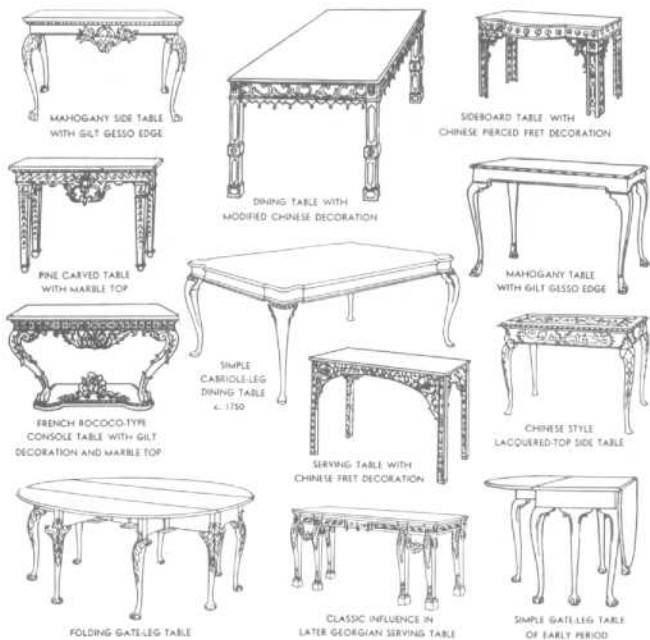
Thomas Chippendale served their changing taste and their fashionable whims. In his

later years he was engaged in making furniture of classic, elegant simplicity for the brothers Adam. His earlier work to his own designs, his love of gilt and gaudy color, his fascination with the exotic — all typical of the age in which he lived — suggest that he might have made a brilliant stage designer.

Chippendale is the first personality in the

history of furniture style. This was due less to his fine craftsmanship than to his ability as a publicist. He was the first cabinetmaker to publish a book of furniture designs. The influence of his *Director* was particularly strong in Philadelphia, but the American cabinetmakers usually simplified his exuberant ornament to suit their clients' taste and

Dining tables, side tables, console



Pedestals, wine coolers



Dining-room accessories



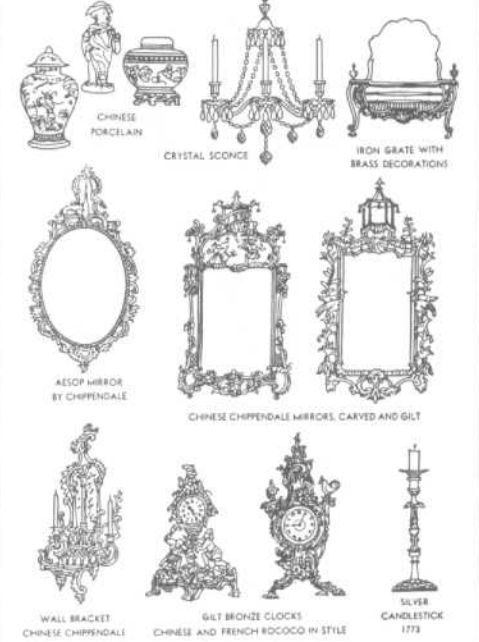
Chests of drawers, secretary, desk



Dressing tables, night stands, stools



Bedroom accessories



their workers' skill in carving. For it must be remembered that many of the published designs were too complex for reproduction in the solid, even by the most highly skilled English carvers. Such designs were intended for inspiration only.

The introduction of mahogany about 1725 was a fundamental influence on furniture

design. Rosewood was another material in favor. Pine was used for paneling and also for intricate carving as, for example, on mirror frames. In the latter case it was usually gilt. Amboyna was occasionally used, mostly for inlays. But the considerable use of inlay is not found until the late Georgian period.

From China come the rectangular leg and

an infinite variety of fretted ornament, as well as the more obviously Oriental pagoda forms. From the France of Louis XV come the elaborate combinations of foliated C and S scrolls so typical of the rococo style of ornament. These came to a lush flowering in furniture hardware and gilt mirror frames. Serpentine fronts and sides broke down

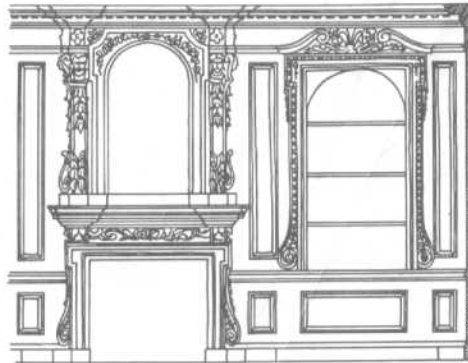
PERIOD FURNITURE

18th Century English: Georgian

Fireplaces and wall paneling

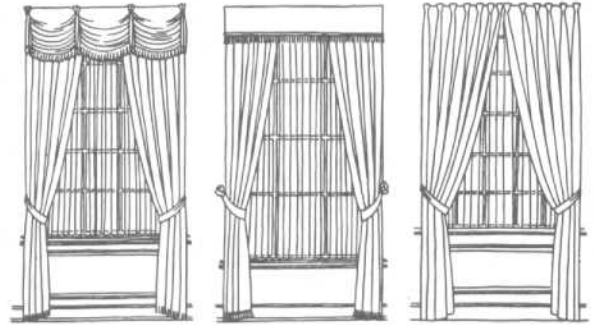


DESIGN BY THOMAS JOHNSON IN THE "GOTHICK" TASTE



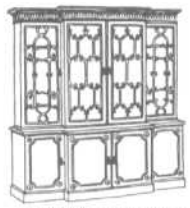
FIREPLACE WALL paneled in pine, with a niche above the mantel and a cupboard alongside. c. 1780

Drapery treatments for Georgian windows



THESE SIMPLE DRAPERIES SHOW UP THE FINE PROPORTIONS OF THE WINDOWS AND PANELING AGAINST WHICH THEY ARE SET. THEY WERE OFTEN OF VERY RICH, HEAVY MATERIALS.

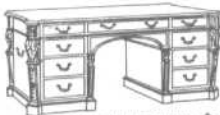
Secretaries, desks, bookcases



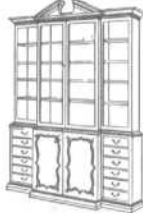
LIBRARY BOOKCASE BY CHIPPENDALE



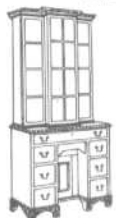
FRENCH-STYLE CHIPPENDALE DESK



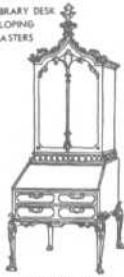
MAHOGANY LIBRARY DESK WITH OUT-SLOPING CORNER PILASTERS



MAHOGANY BREAKFRONT BY CHIPPENDALE c. 1780



KNEE-HOLE SECRETARY WITH GLASS-FRONTED BOOKSHELVES



SMALL SECRETARY IN "GOTHICK" STYLE c. 1780

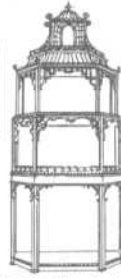


DROP-FRONT SECRETARY

Grandfather clocks, shelves, tables



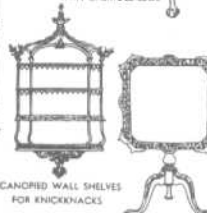
POLE SCREEN WITH PERCED TRIPOD BASE



PAGODA CHINA CABINET 1780



FOLDING-TOP CARD TABLE WITH CABRIOLE LEGS



CANOPIED WALL SHELVES FOR KNICKKNACKS



TILT-TOP TABLE WITH TRIPOD BASE



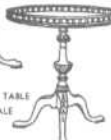
MAHOGANY BY CHIPPENDALE



INLAID WALNUT



LOUIS XV TYPE WITH BRASS MOUNTS



CHIPPENDALE TEA TABLE WITH GALLERY EDGE

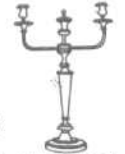
Living-room accessories



CHINESE PORCELAIN



CRYSTAL CANDELABRA



SILVER CANDLESTICK



BRASS FENDER



CHINESE TOLE TEA JAR



CARVED AND GILT CHIPPENDALE MIRROR



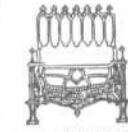
CRYSTAL CANDLESTICK



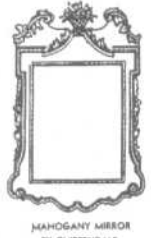
SILVER TEA URN



CLASSIC MOTIFS FOR A WALNUT MIRROR



GRATE IN "GOTHICK" STYLE



MAHOGANY MIRROR BY CHIPPENDALE

even the solid rectangular forms of such traditionally four-square pieces as chests of drawers and tables. (For typical profiles and decorative motifs see Fig. 3.)

Romance was sought in the past as well as the East; the pointed Gothic arch and burgeoning crockets turn up in all kinds of furniture and decoration.



Fig. 3 (Continued)

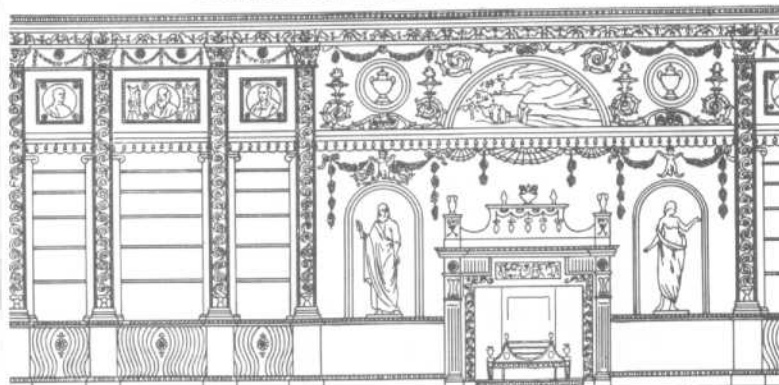


THE EXTERIOR



THE exterior of a later Georgian house, such as the one shown above, would have been finished in cream-painted stucco with stone trim. The Classic detail was in carved stone or molded stucco. At right are details of the architectural background at this period.

Wall paneling and painted decoration



FIREPLACE WALL IN THE LIBRARY OF SYON HOUSE, ISEWORTH, ENGLAND  
DESIGNED BY THE BROTHERS ADAM FOR THE DUKE OF NORTHUMBERLAND

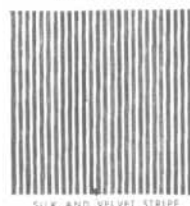
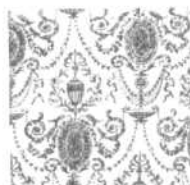
THE LIVING ROOM



GREEN brocade curtains, bound with gold, and green brocade upholstery on the sofa and adjacent chairs stand out brilliantly against the French white of these walls. A damask in tones of coffee and gold is used for the other chairs, a red moire for the other sofa. All these colors are repeated in the rug. The dark brown red of polished mahogany appears in the doors and furniture. Some of the smaller pieces are inlaid with satinwood.

Alternatively the walls might be pale pink with white moldings. Upholstery would be blue green except for the chairs by the fire in lemon yellow brocade and the sofa in gold satin.

Living-room fabrics



Armchairs, love-seats, sofas



Chippendale went for inspiration to Chinese and Gothic decoration. The great designers of the later Georgian period — the brothers Adam, George Hepplewhite, and Thomas Sheraton — were entranced by the recently discovered Classic glories of Pompeii and Herculaneum, and by the slim prettiness in vogue at the French court.

The motifs most characteristic of the later Georgian period (see Fig. 4) are all of Classic origin: acanthus leaf and honeysuckle, ram's head, winged griffin and lion, laurel, and garland.

Characteristic of this period is the perfect coordination between architects, painters, and furniture designers. The four Adam brothers — John, Robert, James, and William, who trademarked themselves the Adelphi (Greek for brothers) — were Scots by

birth, architects by profession. They did not consider their job at an end when they had designed the shell of a house. Every detail of furnishing, decoration, and lighting was especially designed by the Adams to give a rounded effect. Nothing was too small or

unimportant to deserve their attention. The best craftsmen would then be employed to carry out their designs. Chippendale and Hepplewhite, perhaps Sheraton also, made furniture for the Adams.

All these designers followed Chippen-



Fig. 4 Motifs characteristic of the later Georgian period.

PERIOD FURNITURE

18th Century English: Late Georgian

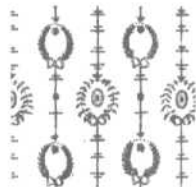
THE DINING ROOM



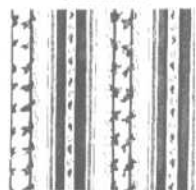
THESE pale blue-green walls are relieved by grisaille paintings in delicate Classic taste. Gold appears in the leather chair seats, in the mirror above the consoles and in the binding of the white curtains. Green and beige enliven the carpet and painted ceiling design.

Alternatively the wall paintings might be brighter and more varied in color, including Naples yellow, mauve and green. Curtains and chair seats would be cherry, the ceiling painting cinnamon brown and white.

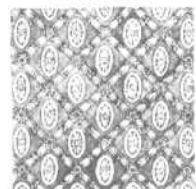
Dining-room fabrics



SILK DAMASK



PRINTED COTTON



BROCADELLE

Dining tables, consoles



MAHOAGANY DINING TABLES BY SHERATON



HEPPLEWHITE CONSOLES COMBINED TO FORM A DINING TABLE



ADAM CONSOLES DECORATED WITH REEDING



ADAM CONSOLE DECORATED WITH PAINTED PANELS



ONE OF THE SIMPLEST OF ADAM DINING TABLES

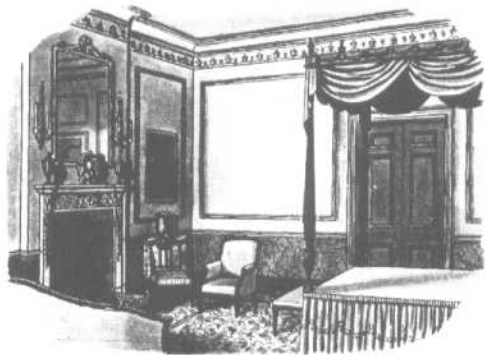


TWO ADAM CONSOLES COMBINED TO FORM A DINING TABLE



EXTENSIBLE DINING TABLE BY ADAM

THE BEDROOM



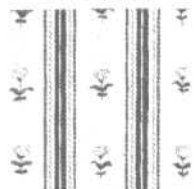
PALE colors are dominant here. The sofa, painted oyster white, is upholstered in apple green satin. The mahogany bed is covered in white taffeta trimmed with apple green, and the armchair upholstery is cinnamon and gold-striped damask. Curtains are white silk, gold-trimmed.

Alternatively the color scheme might be based on gold and white with blue green silk on the bed and yellow satin upholstery on the armchair for contrast. In the panels to the right are a number of authentic pieces which might be used in a Georgian bedroom such as this.

Bedroom fabrics



SATIN BROCADE

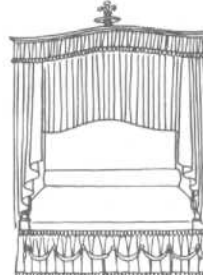


SATIN DAMASK



CHINTZ

Four-poster beds and canopies



DRAPED FOUR-POSTER BY ADAM



CANOPY BY SHERATON



CARVED MAHOAGANY BED BY SHERATON



SOFA BED WITH CUPOLA BY SHERATON



CANOPY BY ADAM

dale's lead by publishing design handbooks for the use of other less experienced and less imaginative craftsmen in this country and in the English provinces outside London. Here is seen the changing fashion: lowboys are being supplanted by dressing tables, highboys by wardrobes. Color and inlay become more popular than carving, with Sheraton as the champion of inlay against painting.

Hepplewhite's work is usually characterized by his affection for curves, Sheraton's by a preference for straight lines. This was probably because Hepplewhite was more strongly influenced than Sheraton by contemporary French work, which was enlivened by a profusion of delicate curves. Of particular interest in Sheraton's work are his designs for ingenious folding and multi-

purpose furniture such as folding beds, combined bookcases and washstand, and couches that folded up to become tables. These were designed for use in those bedrooms which were now doubling as parlors during the day.

This later Georgian period has often been labeled the Age of Satinwood. All the designers eagerly exploited the possibilities of ve-



Armchairs, side chairs



DESIGNED BY HEPPLEWHITE

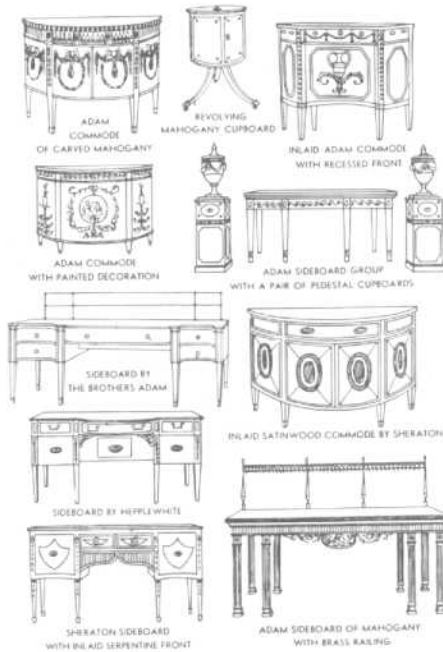


DESIGNED BY SHERATON

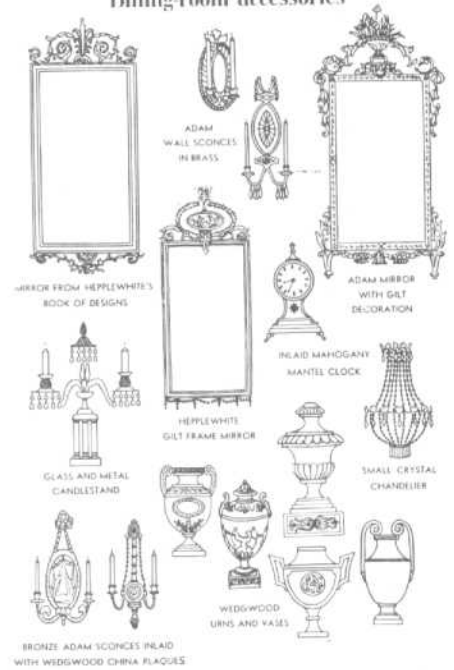


DESIGNED BY THE BROTHERS ADAM

Commodes, sideboards, cupboard



Dining-room accessories



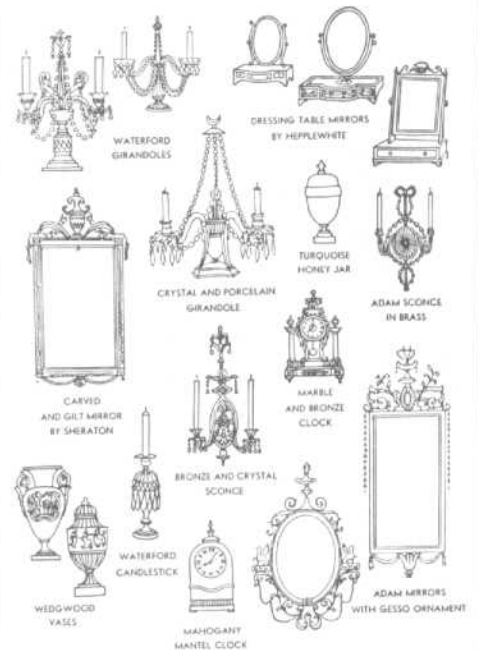
Chests of drawers, wardrobes, commodes



Dressing tables, secretaries, candlestands



Bedroom accessories



neering and inlay with woods such as satinwood and amboyna, ebony, sycamore, holly, kingwood, and lime. Ivory and brass inlay were often used to mark key plates.

Some of these motifs (the acanthus leaf, for example) had been in use by English designers for more than half a century. But now, reintroduced from Italy by means of measured drawings, they take on a fresh

elegance. Italian painters were brought in — Pergolesi, Zucchi, and Cipriani — to provide the background of decoration. Angelica Kaufmann, a Swiss, filled their wreathed panels with neo-Classical figures.

Yet the solid tradition of English craftsmanship remained intact beneath all these changing fashions. The basic proportions remain almost inviolate. Hepplewhite at-

tempted (in his own words) "to unite elegance with utility, and to blend the useful with the agreeable."

PERIOD FURNITURE

18th Century English: Late Georgian

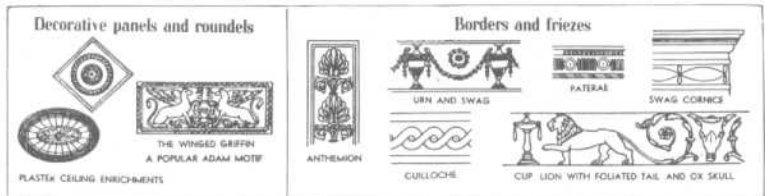
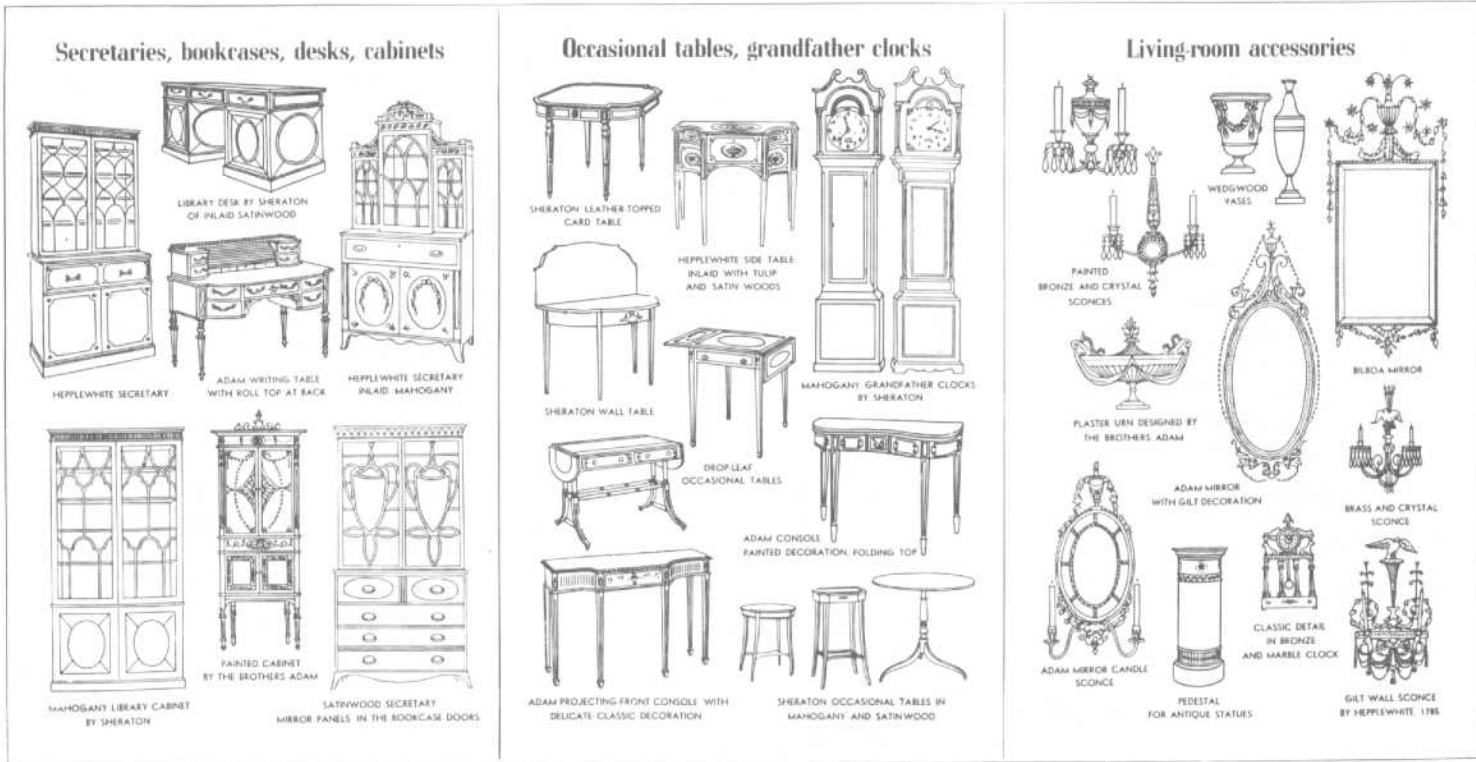
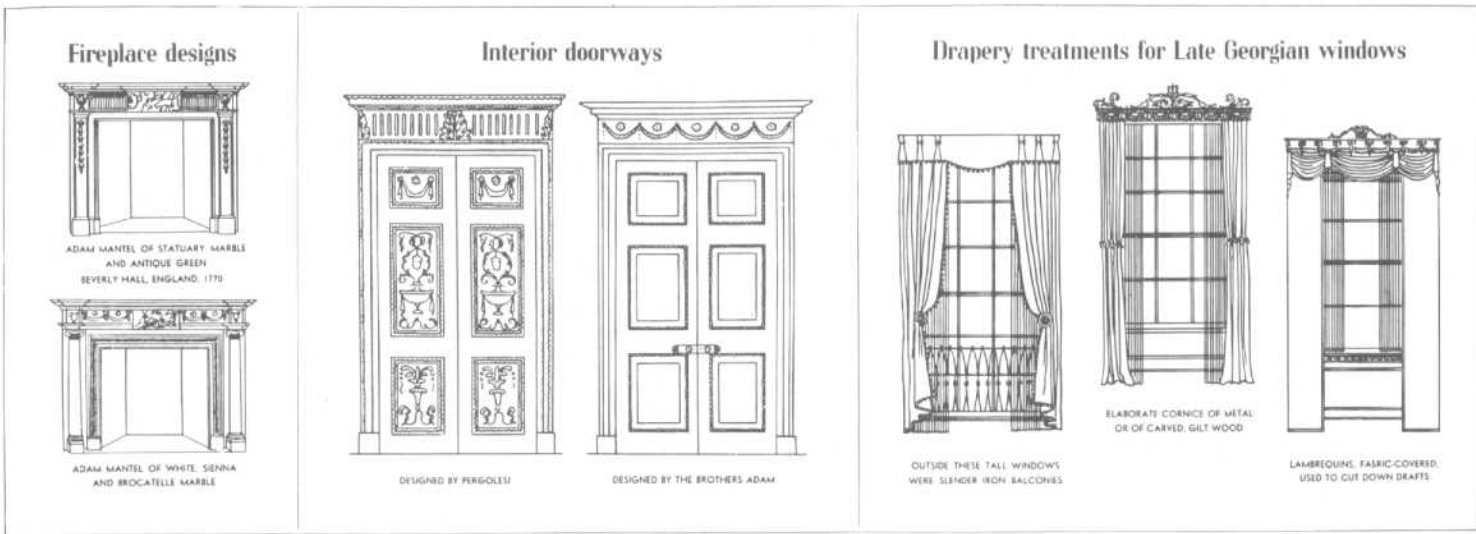


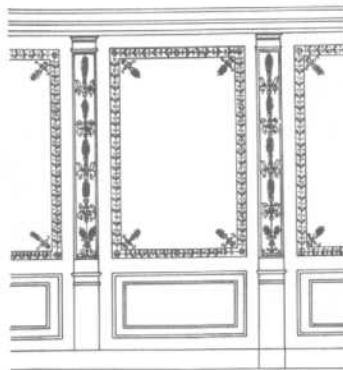
Fig. 4 (Continued)

THE EXTERIOR

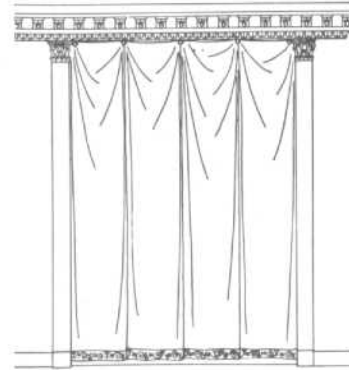


THE typical Directoire chateau shows French Renaissance tradition crossed with the newer Classic vogue. The center panel of this façade is of stone, the remainder in two shades of painted stucco, perhaps in such gay colors as salmon, tan and blue.

Typical Directoire wall treatments



VERY SIMPLE PANELING ELABORATELY PAINTED WITH MULTICOLOR DECORATION OF CLASSIC AND EGYPTIAN DERIVATION



PLAIN COLOR DRAPERY PINNED UP WITH METAL ROSETTES PLASTERS AND CORNICE GILT

THE LIVING ROOM



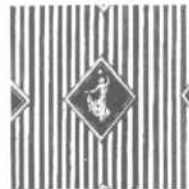
A CHARACTERISTICALLY pale range of colors keeps this room in period. The walls are a pinkish gray, the doors gray and gold. The curtains are oyster white bound in gray and the rug predominantly white except for green and gold in the center. Green recurs in the upholstery of the armchair, side chairs and sofa, and gold (satin) in the sofa and méridienne by the fireplace.

For added color the fireside pieces might be upholstered in red satin, the other furniture in gold and blue striped satin. In panels at right are other pieces suitable for such a room.

Living-room fabrics



DAMASK



SATIN STRIPED DAMASK



TAPESTRY

Settees, méridienne, sofas



MAHOGANY SOFA WITH BRASS MOUNTS LION FEET



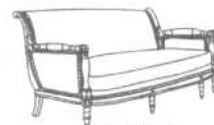
MÉRIDIENNE DESIGNED FOR THE EMPRESS JOSEPHINE



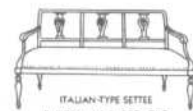
SETTEE OF ITALIAN TYPE WITH SWAN AND LYRE BACK



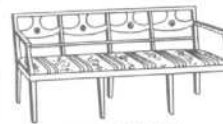
DULL BLACK LOVE-SEAT WITH TAN STRIPING AND MAROON ROSETTES



SOFA FROM THE GRAND TRIANON AT VERSAILLES



ITALIAN-TYPE SETTEE PAINTED AND PARCEL GILT



SIMPLE DIRECTOIRE SETTEE UPHOLSTERED IN STRIPED SATIN



GOLD AND WHITE PAINTED SOFA WITH GOLD SATIN UPHOLSTERY

The Directoire was France's recovery period after the shock of a six-year revolution. The Directoire, established in 1795, lasted only a brief four years; but this was long enough for the designers to sketch in the outlines of a new style. Those outlines were to be filled in later as Directoire merged into Empire; these are but two stages in a single style.

With the rise of Napoleon to absolute power, the delicate style of the Directoire was taken over and developed "for the good of the State." It was to be made into a French national style thoroughly imbued with the political principles which were to guide the new state.

Imperial Rome was found to provide the dignity and impressiveness required in the

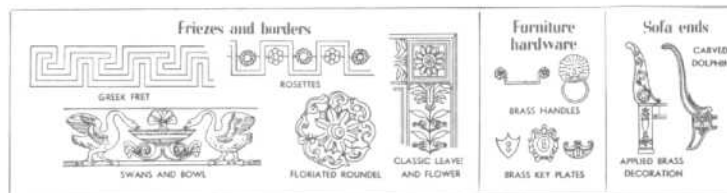


Fig. 5 Motifs characteristic of Directoire and Empire.

prototype, so all the Imperial symbols were converted to use. The symmetrical shapes of heavy proportion were taken over unchanged, copied in wood instead of being reproduced in stone or bronze.

Most pieces displayed large surfaces of

highly polished wood, usually mahogany. They were not, as a rule, decorated by molding or paneling, or even by carving. Ornamentation was almost always applied or inlaid. Most typically it took the form of gilded bas reliefs tacked to the smooth wood sur-

PERIOD FURNITURE

Late 18th–Early 19th Century French: Directoire and Empire

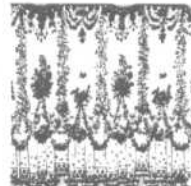
THE DINING ROOM



The rich brown of polished mahogany in this table is surrounded by chairs painted gold and white, upholstered in blue satin. The walls are painted oyster white picked out with yellow moldings. Above the doors are white Classic figure paintings with a blue background which is echoed in the blue taffeta curtains.

Alternatively the walls might be painted green with the cornice picked out in white and gold. The chairs would then be upholstered in red. Other pieces suitable for a room of this type are shown in the panels at right.

Dining-room fabrics



Side chairs, armchair



ARMCHAIR WITH LEATHER SEAT  
DESIGN INSPIRED BY  
ENGLISH PRECEDENT



FROM THE PALACE  
OF FONTAINEBLEAU

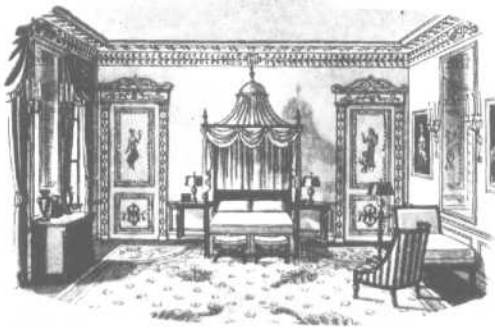


DESIGNED FOR NAPOLEON  
UPHOLSTERED WITH  
BEAUVAIS TAPESTRY



A GROUP OF MAHOGANY CHAIRS DESIGNED BY JACOB BROTHERS  
MANY WERE PAINTED WHITE. UPHOLSTERY WAS SATIN OR TAPESTRY

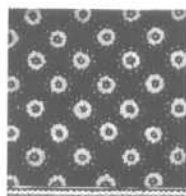
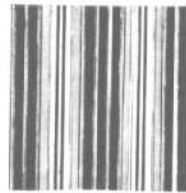
THE BEDROOM



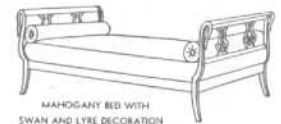
PINK WALLS decorated in white and gold provide a good background for this mahogany and rosewood furniture relieved with brass mounts. Fabrics are gayly colored here: blue taffeta for curtains and bed canopy, striped yellow and red satin for the chairs, and yellow satin for the two stools (which have white-painted frames).

An alternative color scheme would have dark beige walls, green taffeta for the curtains and bed canopy. Most of the furniture would be painted white and gold. At right are other pieces and fabrics suitable for this type of room.

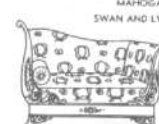
Bedroom fabrics



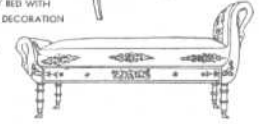
Beds, chaises longues, méridiennes



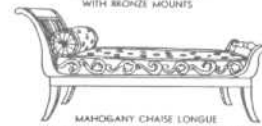
MAHOGANY BED WITH  
SWAN AND LYRE DECORATION



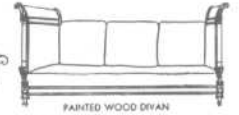
MÉRIDIENNE OF MAHOGANY  
WITH BRONZE MOUNTS



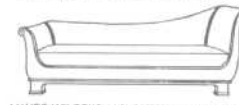
CHAISE LONGUE WITH SWAN'S NECK DECORATION



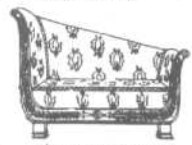
MAHOGANY CHAISE LONGUE  
WITH BOLDLY PATTERNED RED UPHOLSTERY



PAINTED WOOD DIVAN



MAHOGANY COUCH UPHOLSTERED IN YELLOW SATIN



MÉRIDIENNE WITH GOLD AND  
WHITE FRAME. GREEN UPHOLSTERY



MAHOGANY BEDS WITH UPHOLSTERED ENDS

faces. Painted decoration was more commonly used on walls and ceilings than for furniture.

The general color scheme is rich, dark, and somewhat heavy. Rich deep mahogany, French polished and often stained red, was the favorite material. Rosewood and ebony were also in favor. Where other woods were used, their nature was concealed by staining to imitate the more popular species.

Round tables were popular. They usually stood on a pedestal or tripod vase. The top was commonly of porphyry or marble. Beds developed into Classic ceremonial couches with scrolled ends. The popular craze for all things Roman extended to include women's dresses and Lucullan banquets.

In the early (Directoire) part of the period fabrics were quite delicately colored, the decorative motifs still possessed some Gre-

cian delicacy of form, and much of the furniture was painted and gilt. Later, under Napoleon's fist, fabrics were usually in deep primary colors, the motifs of Imperial Roman heaviness, the furniture of dark red polished mahogany.

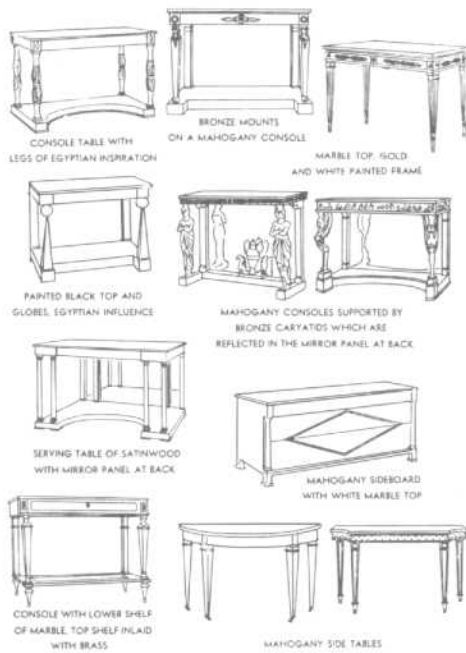
From each of his campaigns he brought home some new decorative motif which he would turn over to his craftsmen for use in the net batch of furniture made to his order.

Pedestals



THESE STANDS OF MAHOGANY AND BRONZE, WITH BRASS MOUNTS, WERE USED FOR DISPLAYING PLANTS AND STATUARY

Wall tables, sideboards, consoles



CONSOLE TABLE WITH LEGS OF EGYPTIAN INSPIRATION

BRONZE MOUNTS ON A MAHOGANY CONSOLE

MARBLE TOP, GOLD AND WHITE PAINTED FRAME

PAINTED BLACK TOP AND GLOBE, EGYPTIAN INFLUENCE

MAHOGANY CONSOLES SUPPORTED BY BRONZE CARYATIDS WHICH ARE REFLECTED IN THE MIRROR PANEL AT BACK

SERVING TABLE OF SATINWOOD WITH MIRROR PANEL AT BACK

MAHOGANY SIDEBOARD WITH WHITE MARBLE TOP

CONSOLE WITH LOWER SHELF OF MARBLE, TOP SHELF INLAID WITH BRASS

MAHOGANY SIDE TABLES

Dining tables



MAHOGANY TOP TABLE, METAL LEGS

INLAID MARBLE TOP, LION FEET

SIMPLE TABLE WITH FLUTED LEGS, ENGLISH PATTERN

MAHOGANY TABLE WITH LOTUS LEAF BASE FOR THE SUPPORTING COLUMNS

SATINWOOD TABLE SUPPORTED BY SPHINXES

Dining-room accessories



BRONZE JARDINIERS IN BLACK AND GOLD

BRONZE LAMPS

CHASED BRASS CANDLESTICK AND WALL SCIENCE

MARBLE URNS

BRASS READING LAMP WITH TOLL SHADE

BRASS ANDIRON

PORCELAIN TABLE CENTRE ORNAMENT

BRONZE CANDLESTICK

CRYSTAL AND BRONZE MIRROR BACK SCIENCE

PORCELAIN URNS

Cabinets, chests of drawers, secretaries, desk



OAK COMMODE WITH LION BRACKETS

BOULDER WRITING DESK

DROP-FRONT SECRETARY WITH BRASS MOUNTS

MAHOGANY CHEST OF DRAWERS WITH LION-ANDRING HANDLES, SHIELD KEY-PLATES

BRASS-MOUNTED CONSOLE CABINET

LOW DROP-FRONT MAHOGANY SECRETARY

MAHOGANY CHEST OF DRAWERS WITH BRONZE MOUNTS AND GALLERY

CABINET WITH MIRROR BACK PANEL AND CLASSIC PAINTED FIGURES ON DOORS

FRUITWOOD CHEST OF DRAWERS WITH BRASS MOUNTS

Dressing tables, stools, night tables, mirrors



DRESSING TABLE MIRROR WITH SPHINX HEAD SUPPORTS

WALNUT NIGHT TABLE

MAHOGANY NIGHT TABLE WITH PILLAR SUPPORTS

NIGHT TABLE WITH BRASS BUSTS, FEET AND KEY PLATE

ADJUSTABLE PIER GLASS IN MAHOGANY STAND

DRESSING TABLE WITH BRONZE MOUNTS FOR THE LEGS

CANDLESTAND

BEDSIDE CHAIR

BLACK PAINTED TABLE WITH GILT LINING

NIGHT TABLES WITH TAMBOUR DOORS

UPHOLSTERED PAINTED CHAIR

DRESSING STOOLS IN PAINTED MAHOGANY

FOOTSTOOLS WITH WHITE-PAINTED FRAMES UPHOLSTERED IN STRIPED SATIN AND TAPESTRY

Bedroom accessories



BRASS READING LAMP WITH TOLL SHADE

MARBLE BASE LAMP

BRONZE CANDLESTICKS

BRONZE HEAD ON MARBLE STAND

TOLL VASES

GOLD AND MARBLE MANTEL CLOCK

PORCELAIN URNS

SMALL BRONZE WALL LAMP WITH TOLL SHADE

The Egyptian campaign yielded an impressive collection of sphinxes, pyramids, obelisks, and lotus leaf capitals. From Italy came all the paraphernalia of Imperial Roman decoration, acanthus leaves, laurel wreaths, torches, winged victories, cornucopias, and the rest, including the famous wreath of bees Napoleon is usually accused of having appropriated from the arms of an old Italian family, the Barberini.

The early Empire pieces (Directoire) are simplified versions of the styles current under Louis XVI. These pieces have grace, simplicity, and charm. The hampering restrictions on foreign trade led to the use of native fruitwoods instead of mahogany.



PERIOD FURNITURE

Late 18th–Early 19th Century French: Directoire and Empire

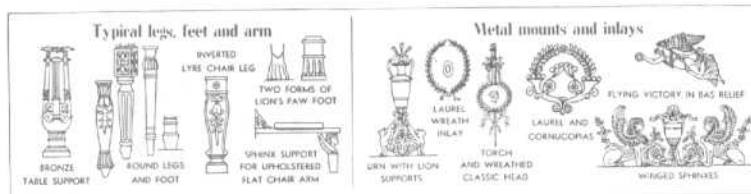
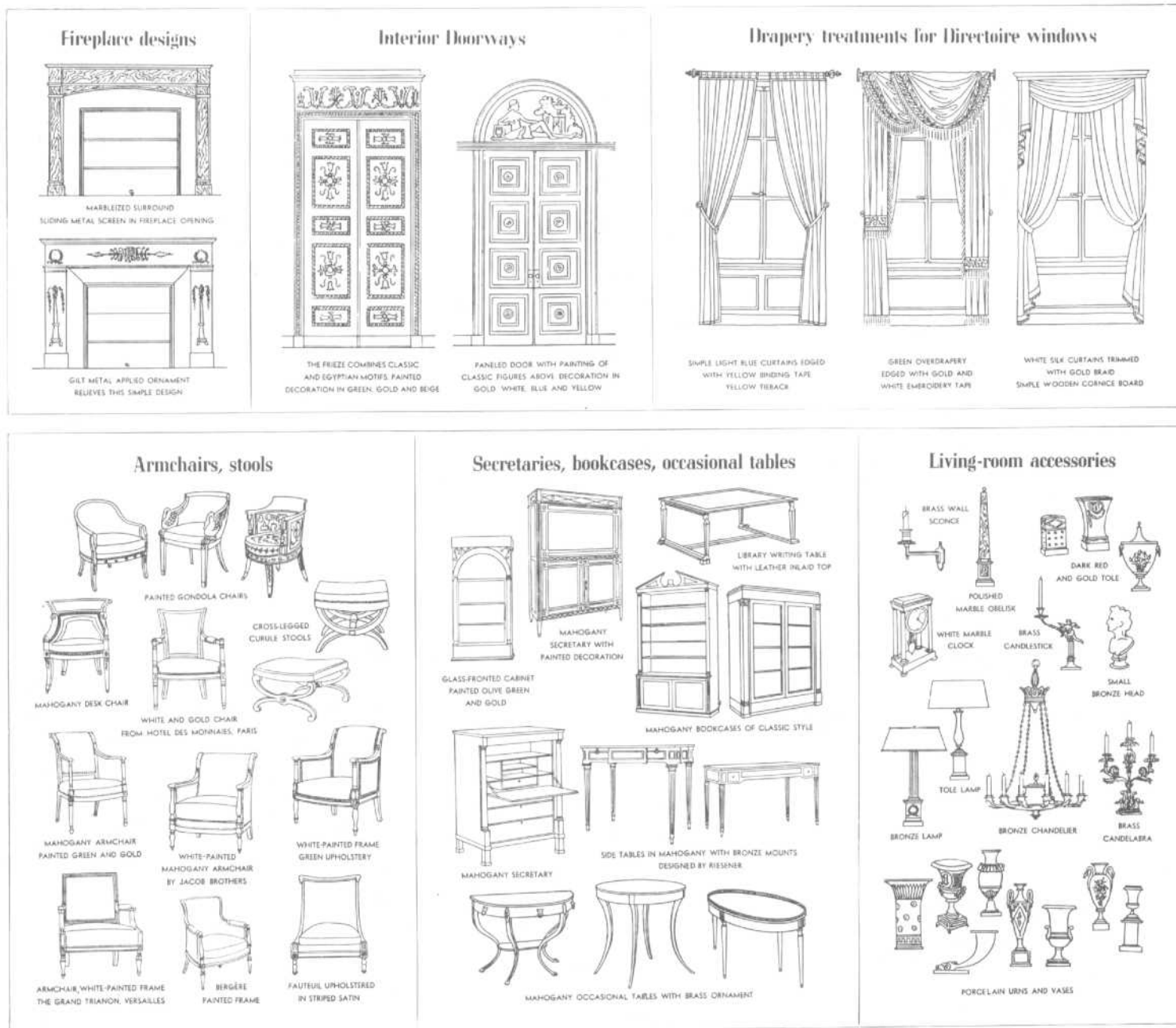
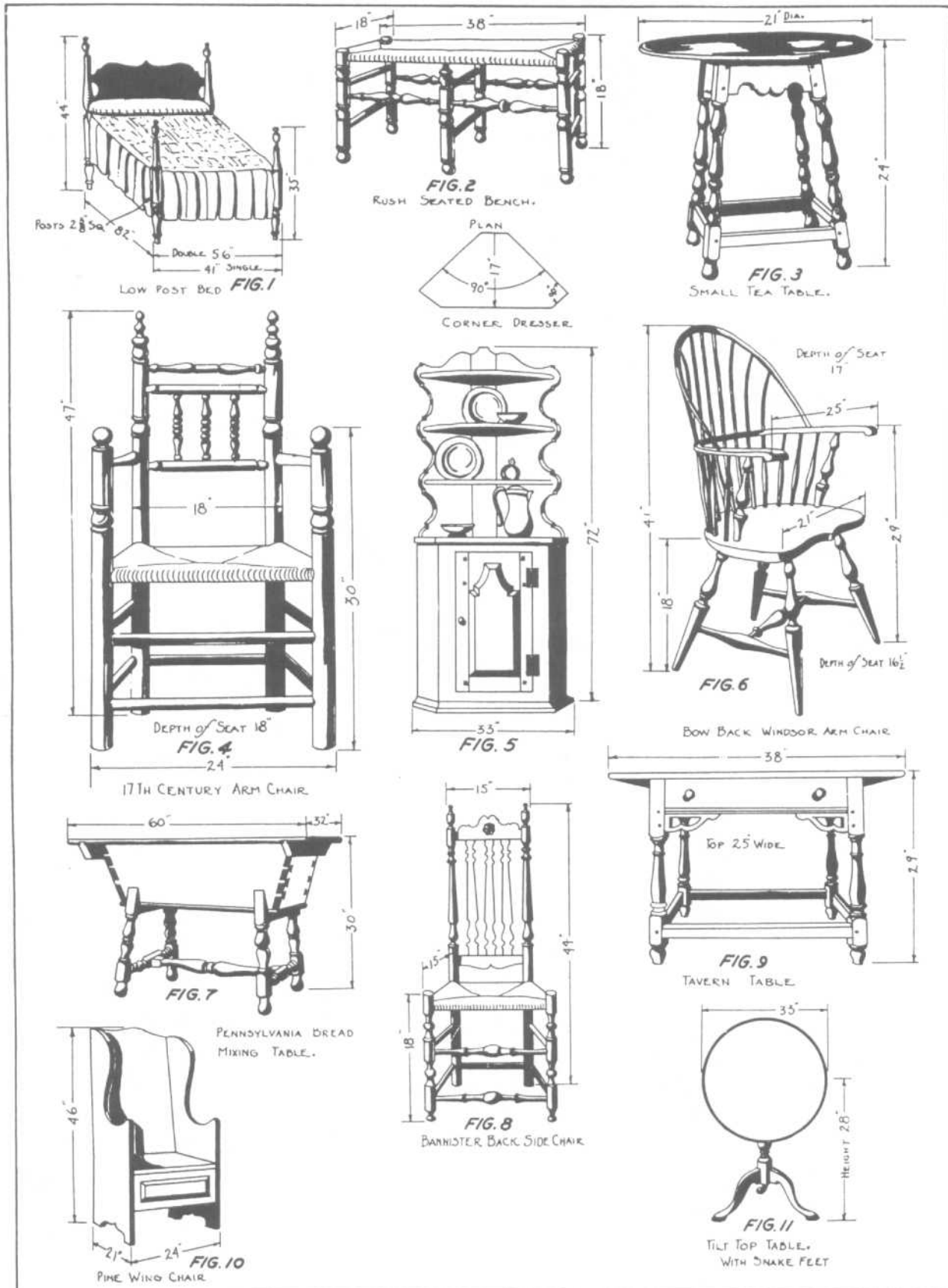


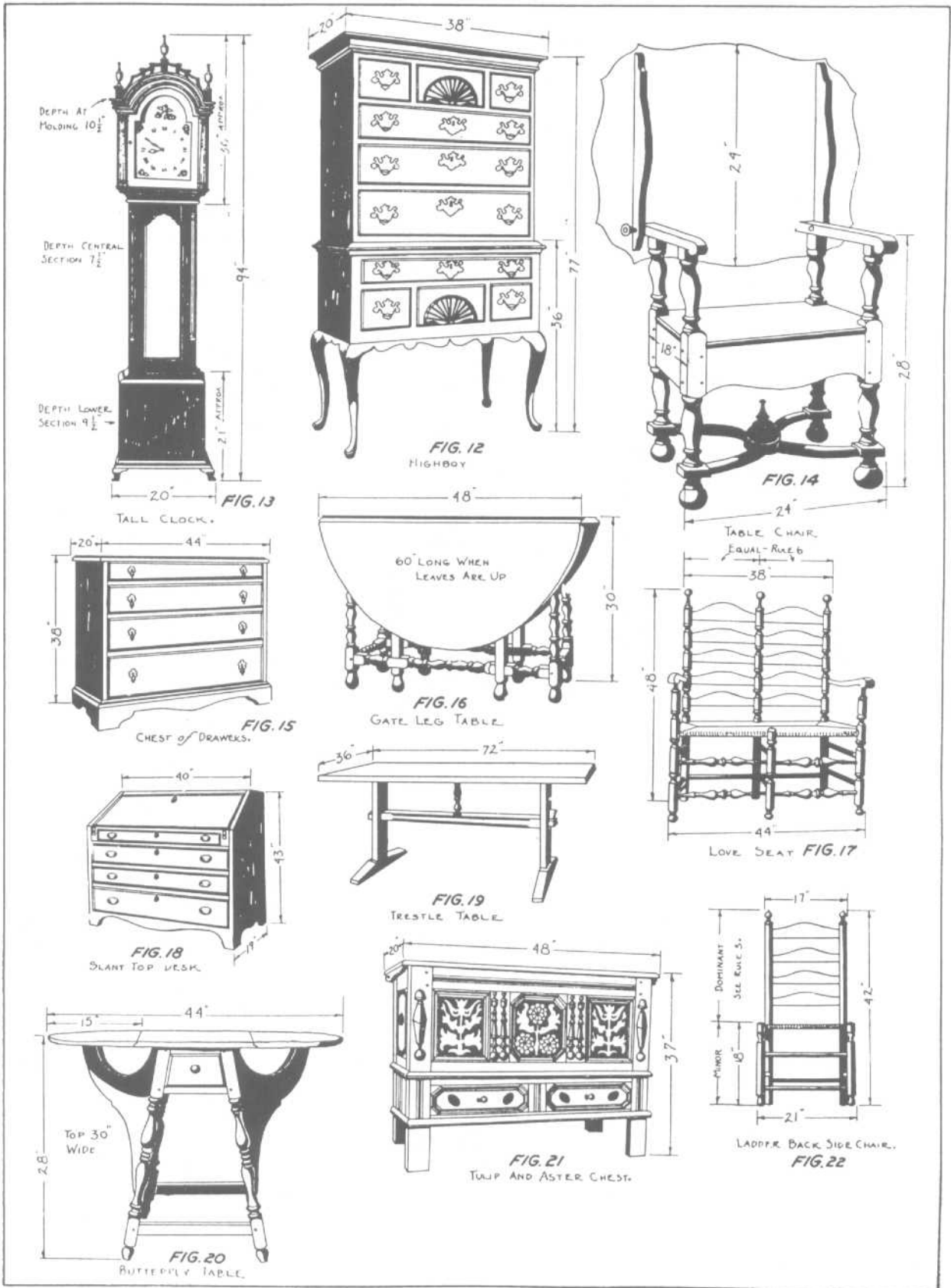
Fig. 5 (Continued)



Colonial style

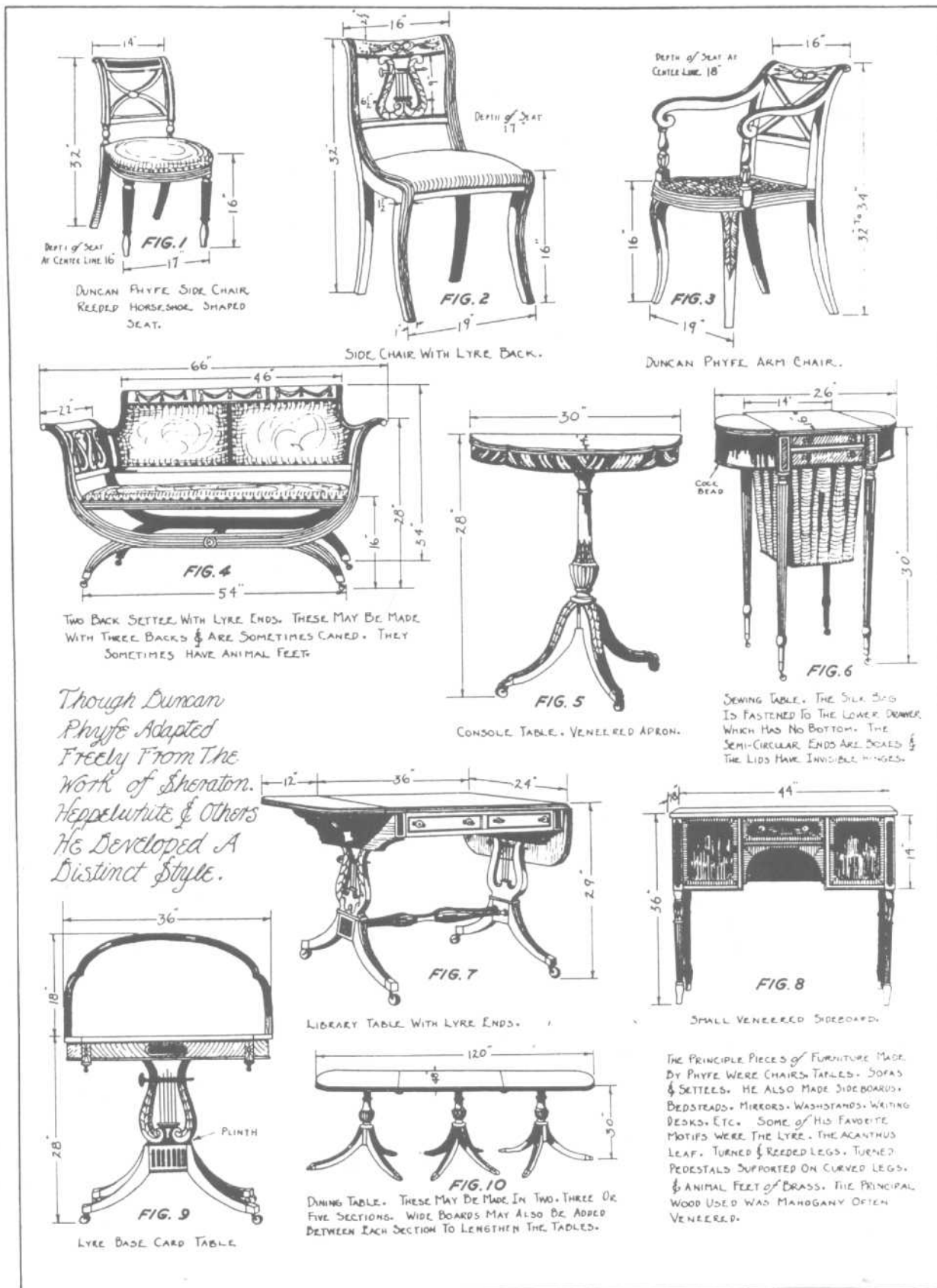
PERIOD FURNITURE

17th and 18th Century American; Colonial



Colonial style

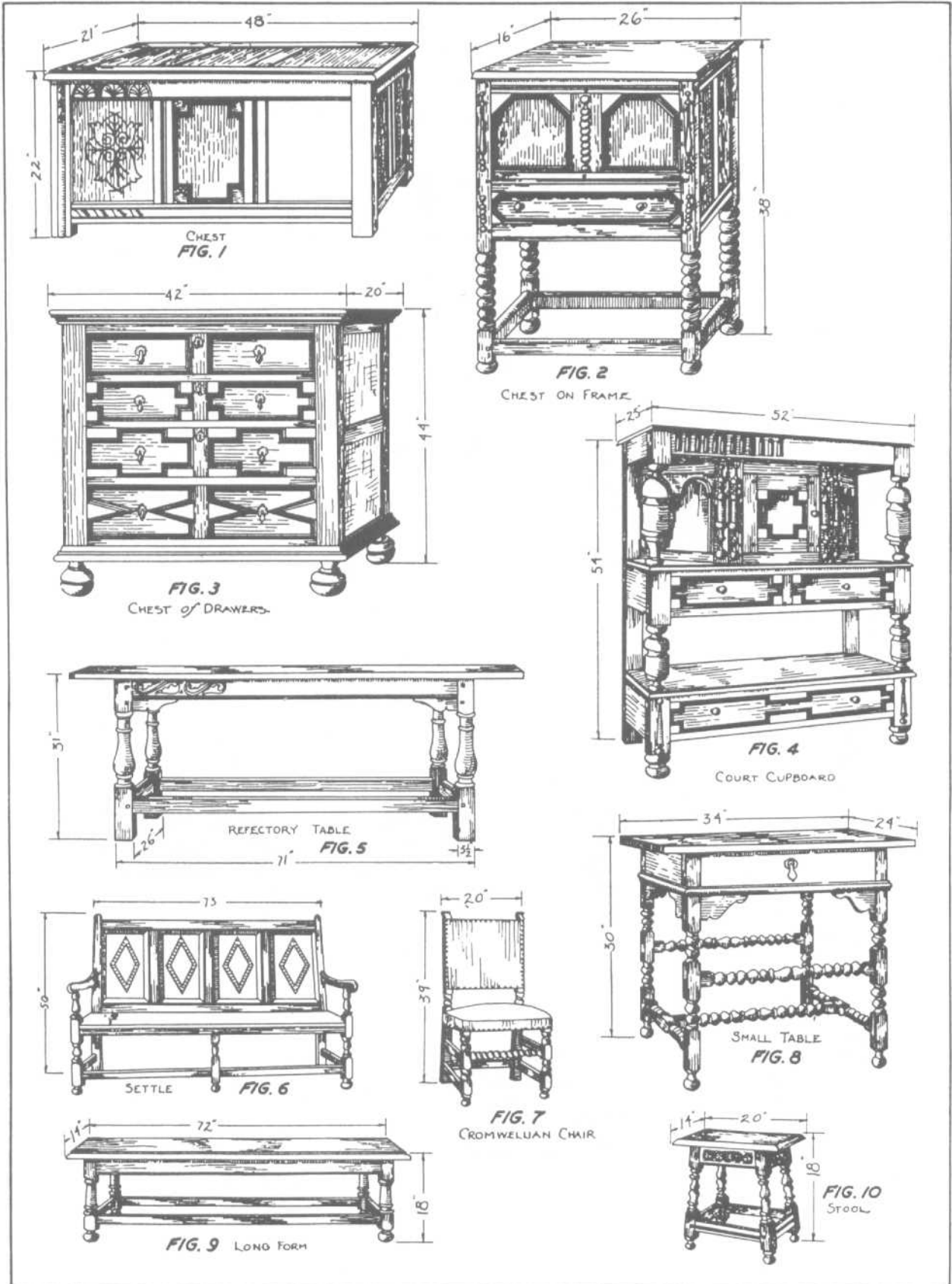




Duncan Phyfe style

PERIOD FURNITURE

16th Century English: Early Jacobean



Early Jacobean period

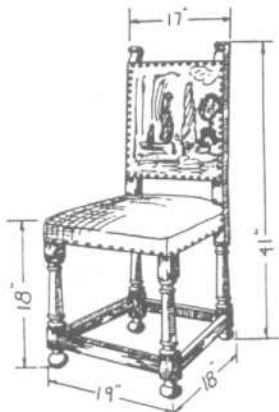


FIG. 12  
JACOBEOAN SIDE CHAIR

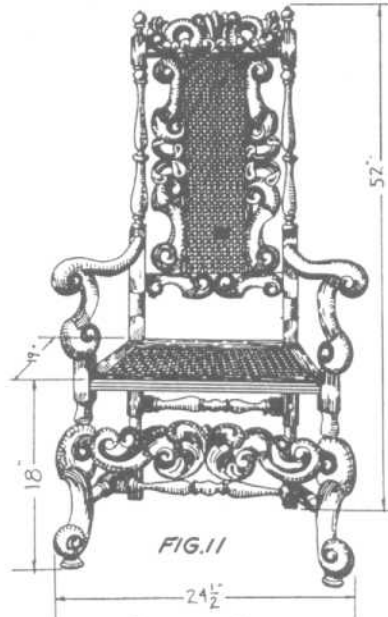


FIG. 11  
CAROLEAN CHAIR

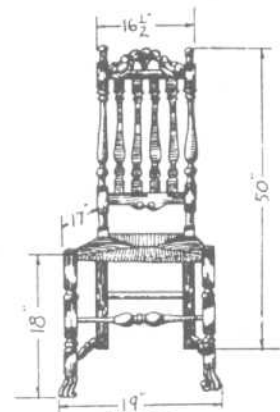


FIG. 13  
BANNISTER BACK CHAIR

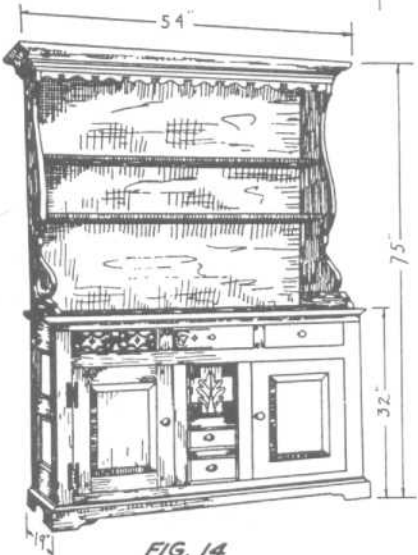


FIG. 14  
WELSH DRESSER

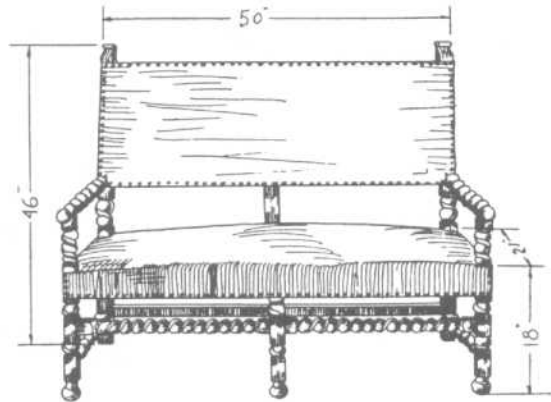


FIG. 15  
CROMWELLIAN SETTEE

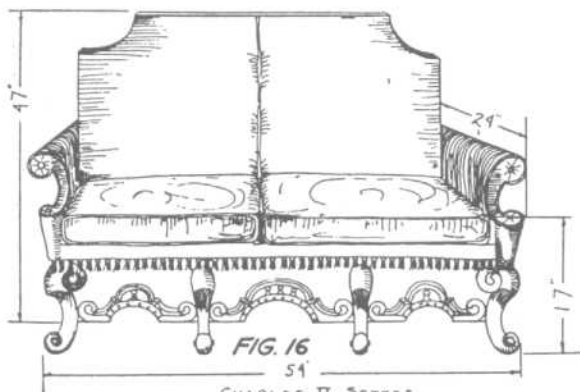


FIG. 16  
54  
CHARLES II SETTEE



FIG. 17  
MIRROR FRAME

PERIOD FURNITURE

17th Century English: William & Mary

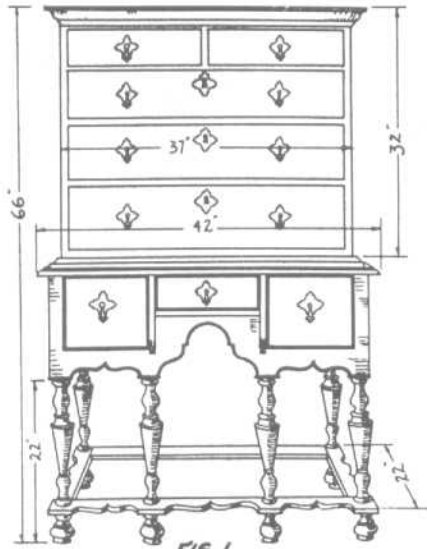


FIG. 1.  
WM. & MARY HIGHBOY WITH TRUMPET  
TURNED LEGS.

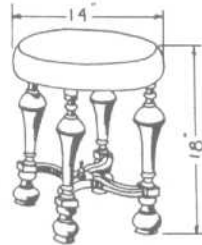


FIG. 2  
STOOL

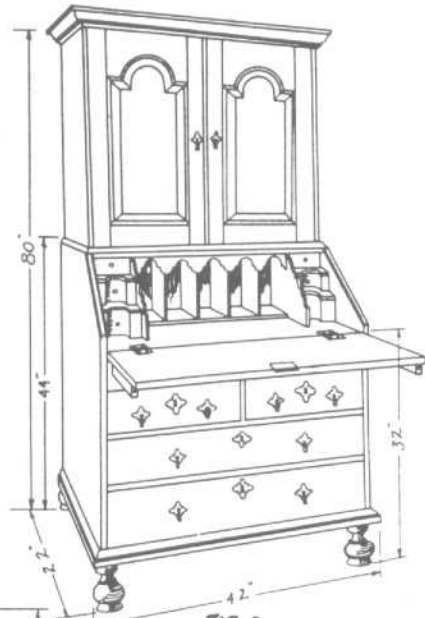


FIG. 3  
STRAIGHT TOP SECRETARY

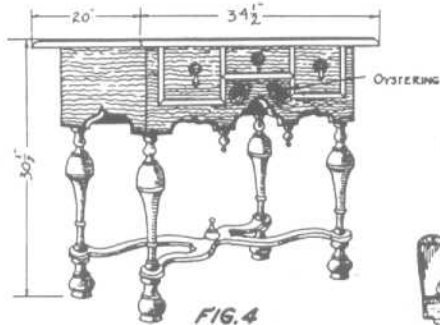


FIG. 4  
LOWBOY. THESE WERE  
THE DRESSING TABLES OF THE  
PERIOD.

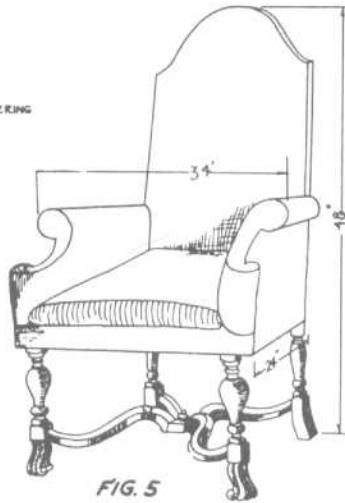


FIG. 5  
WM. & MARY ARM CHAIR

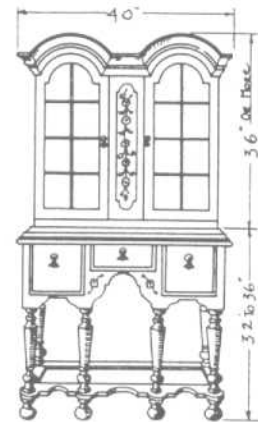


FIG. 6  
DOUBLE HOOD CHINA CABINET



FIG. 7  
LACQUERED CABINET



FIG. 8  
TALL CLOCK  
SEAWEED  
MARQUETRY



FIG. 9  
CARD TABLE.

PERIOD FURNITURE

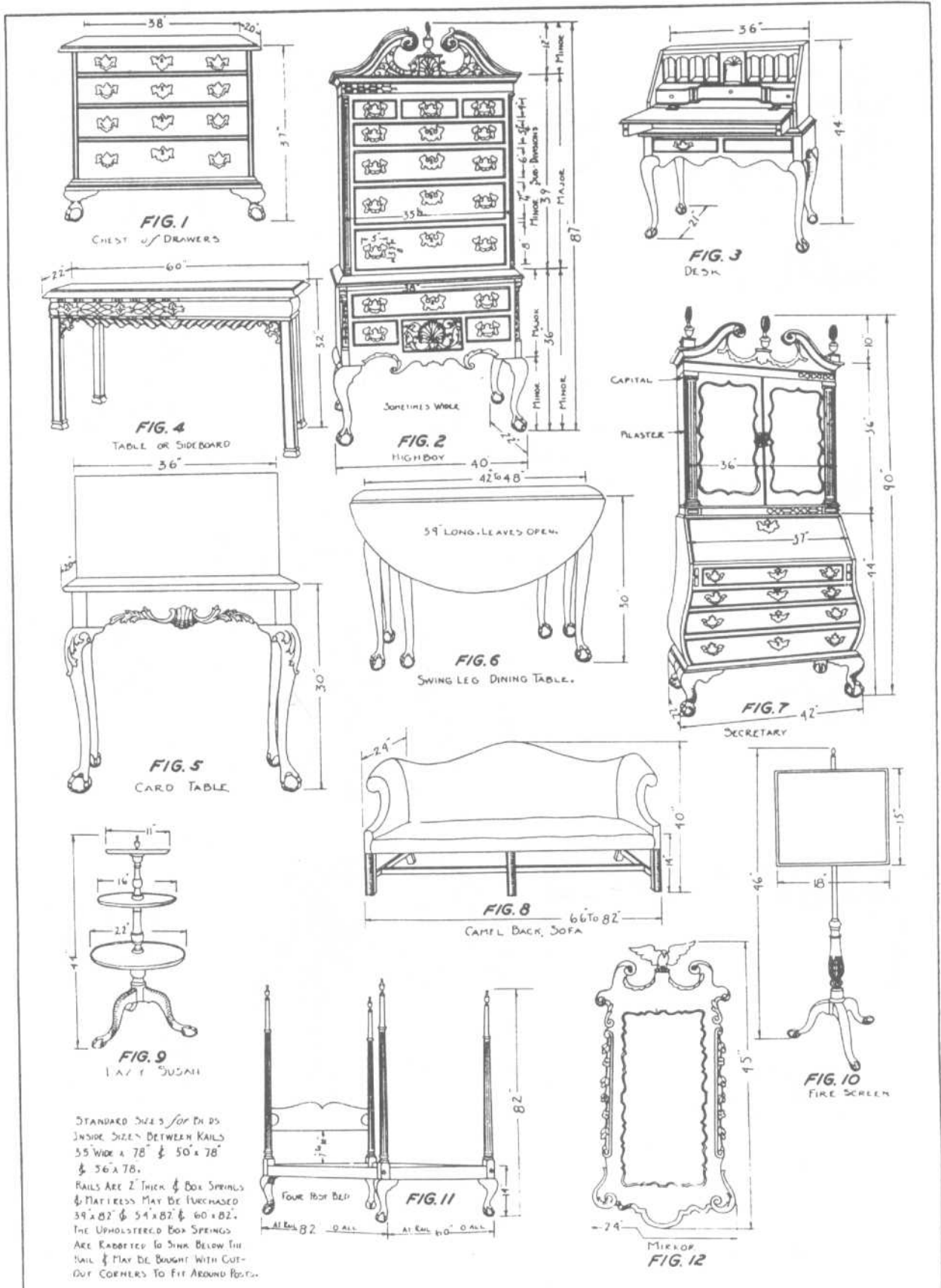
18th Century English: Queen Anne



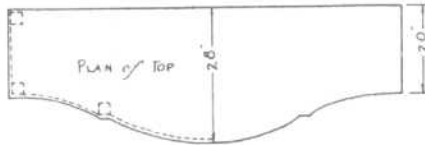
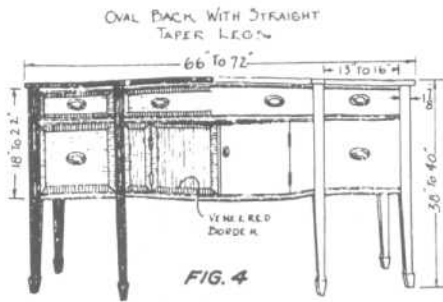
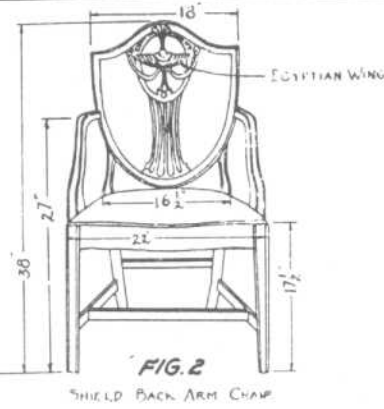
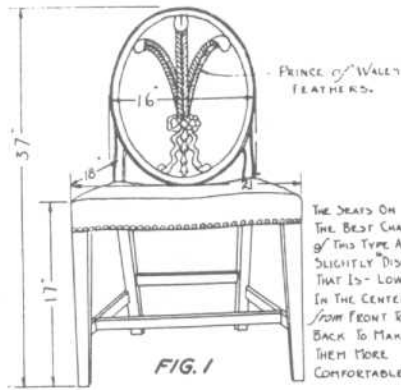
Queen Anne period

PERIOD FURNITURE

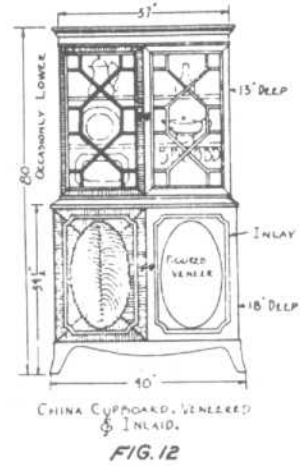
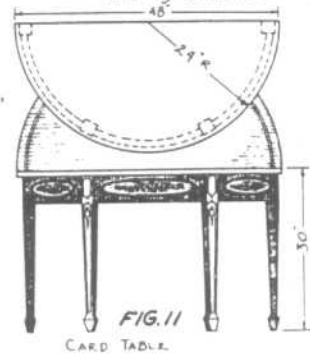
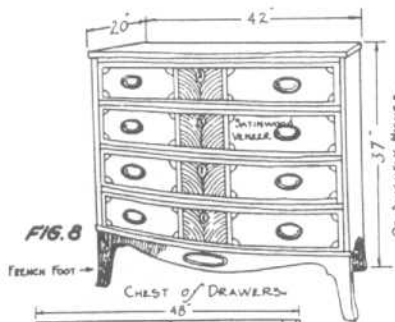
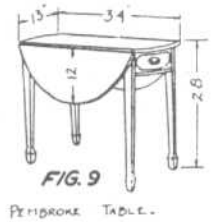
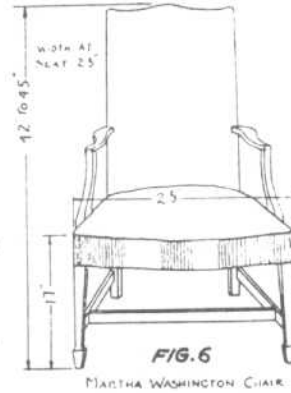
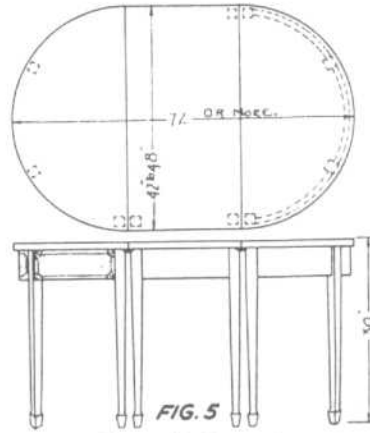
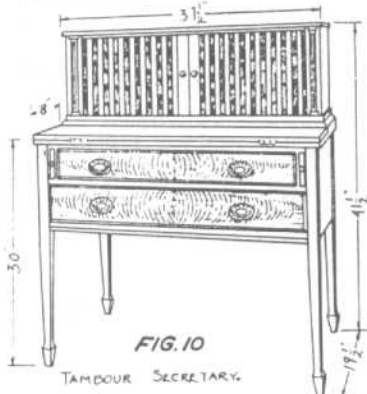
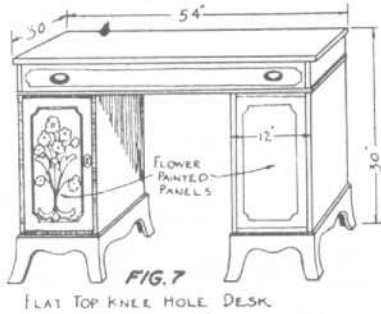
18th Century English: Georgian (Chippendale)



Chippendale style



HEPPLWHITE, SIDE BOARD WITH BORDER VENEERED DRAWERS & DOORS





PERIOD FURNITURE

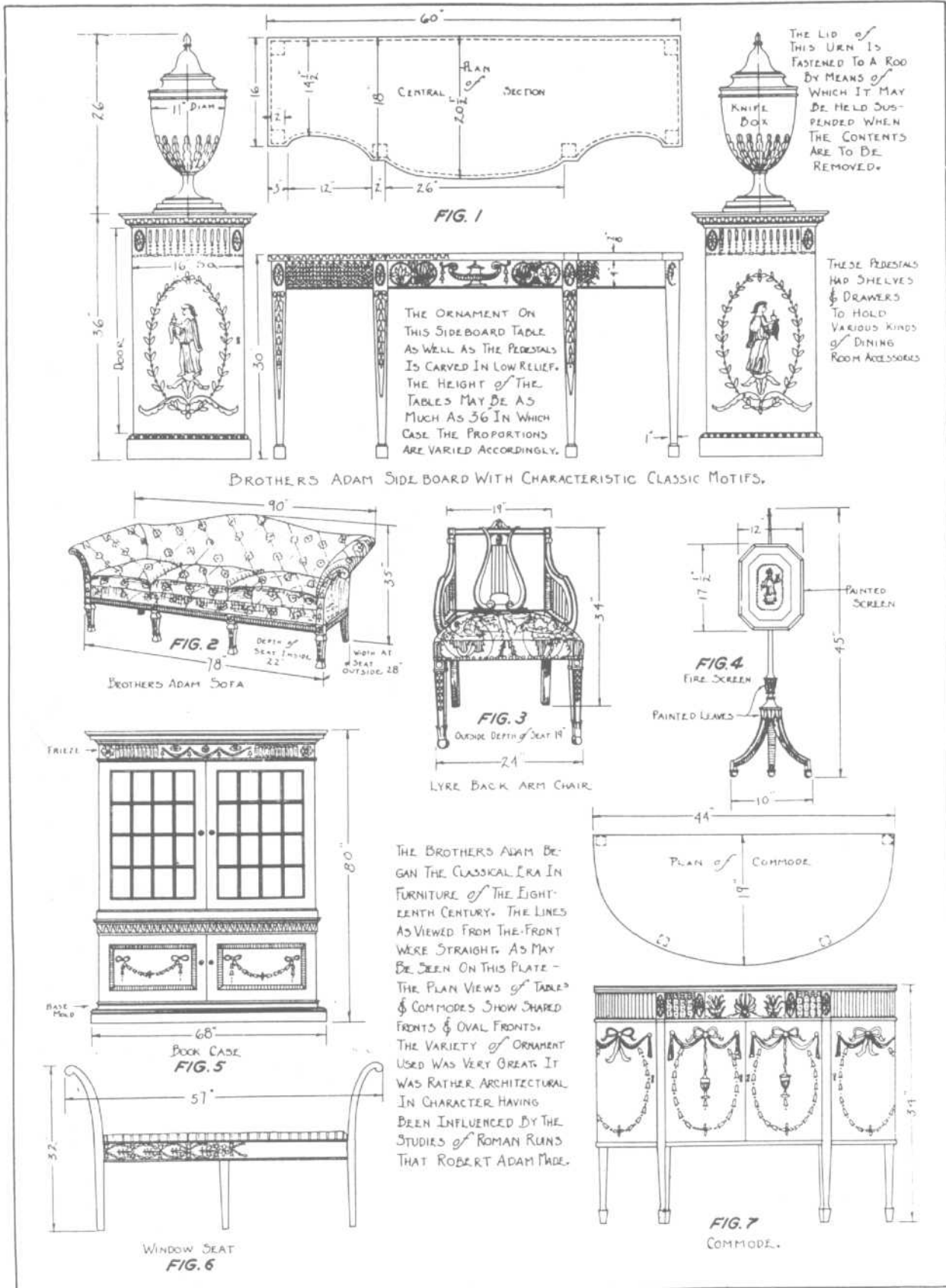
18th Century English: Late Georgian (Sheraton)



Sheraton style

PERIOD FURNITURE

18th Century English: Late Georgian (Brothers Adam)



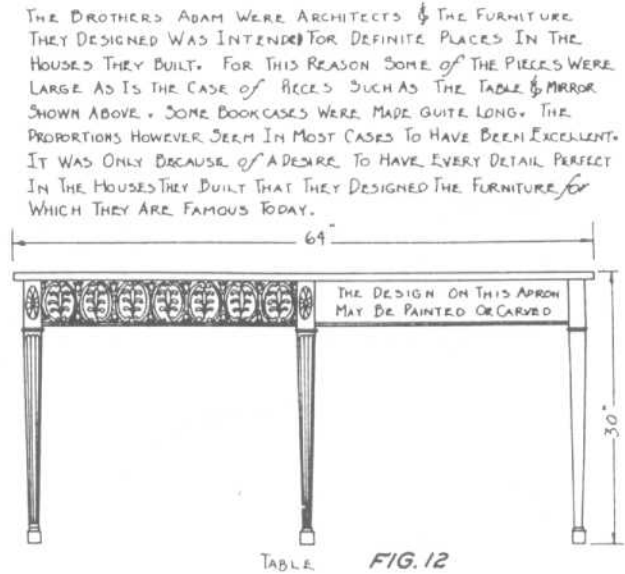
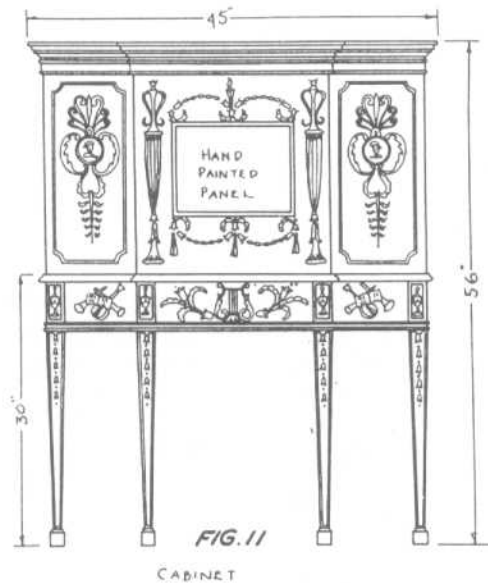
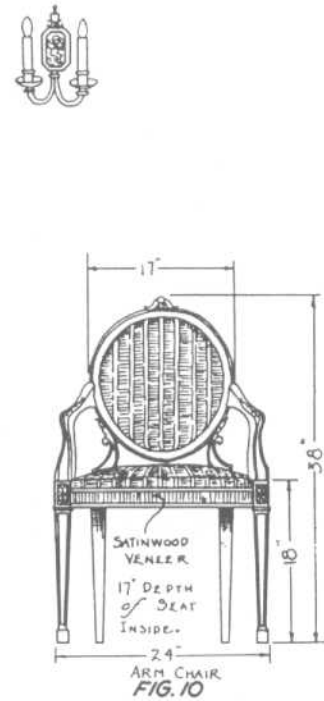
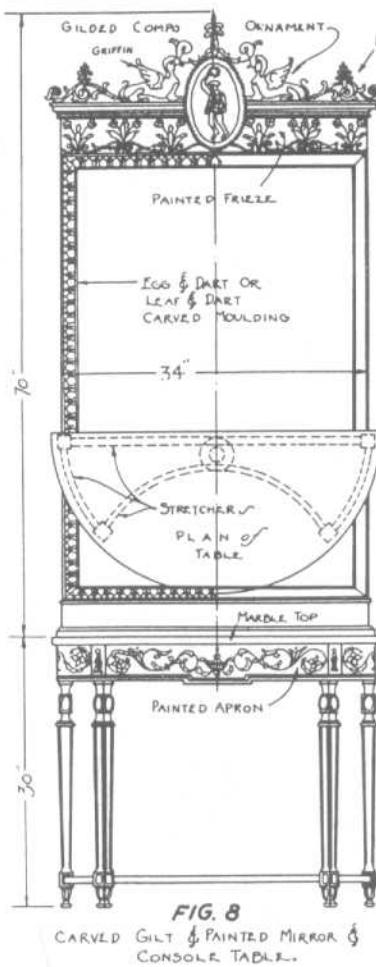
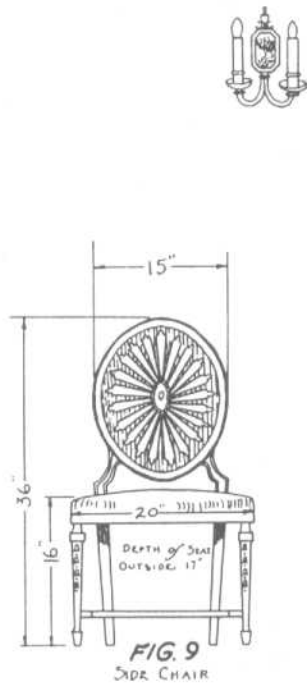
Brothers Adam

PERIOD FURNITURE

18th Century English: Late Georgian (Brothers Adam)

ALL THE FURNITURE DESIGNED BY THE BROTHERS ADAM WAS BUILT BY OTHERS. HEPPLEWHITE, CHIPPENDALE & OTHERS EXECUTED THE COMMISSIONS. MOST OF THESE MAKERS WITH THE POSSIBLE EXCEPTION OF CHIPPENDALE WERE INFLUENCED BY THE WORK OF THESE ARTISTS.

WHILE THE FURNITURE IS VERY FORMAL IN CHARACTER IT IS ALSO VERY BEAUTIFUL & TASTEFUL. NO DETAIL WAS TOO SMALL TO RECEIVE THEIR ATTENTION. BESIDES THE ORDINARY PIECES THEY DESIGNED LIGHTING FIXTURES, UPHOLSTERY, & NUMEROUS ACCESSORIES.



THE DOORS OF THESE CABINETS WERE OCCASIONALLY ON THE ENDS. THE HAND PAINTED PANEL WAS THE WORK OF A FAMOUS ARTIST.

THE BROTHERS ADAM WERE ARCHITECTS & THE FURNITURE THEY DESIGNED WAS INTENDED FOR DEFINITE PLACES IN THE HOUSES THEY BUILT. FOR THIS REASON SOME OF THE PIECES WERE LARGE AS IS THE CASE OF PIECES SUCH AS THE TABLE & MIRROR SHOWN ABOVE. SOME BOOKCASES WERE MADE QUITE LONG. THE PROPORTIONS HOWEVER SEEM IN MOST CASES TO HAVE BEEN EXCELLENT. IT WAS ONLY BECAUSE OF A DESIRE TO HAVE EVERY DETAIL PERFECT IN THE HOUSES THEY BUILT THAT THEY DESIGNED THE FURNITURE FOR WHICH THEY ARE FAMOUS TODAY.

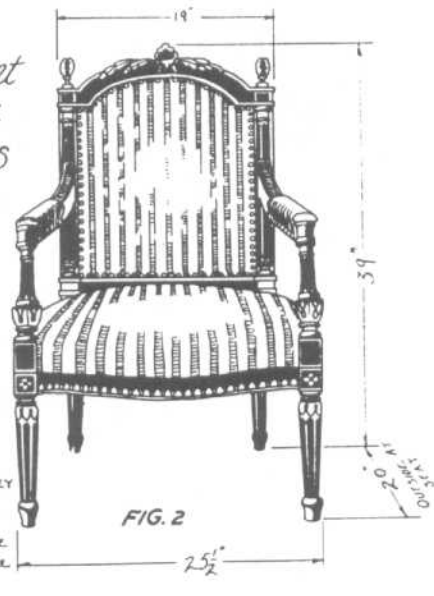
PERIOD FURNITURE

17th and 18th Century French: Louis XIV, XV, and XVI



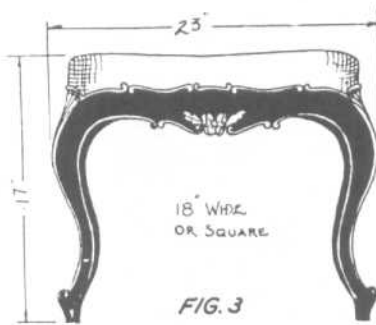
LOUIS XIV ARM CHAIR

*The Important  
Periods in the  
French Styles  
Were Louis  
XIV. XV.  
& XVI.*

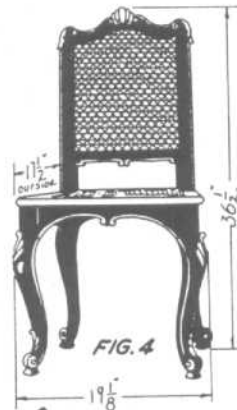


LOUIS XVI ARM CHAIR

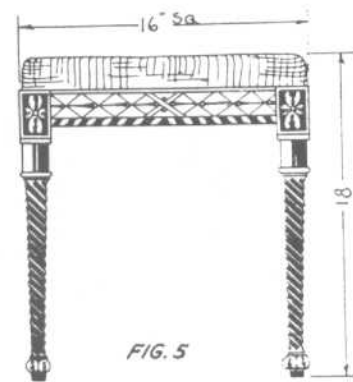
LOUIS XVI CHAIR  
BACKS SOMETIMES  
TAPERED TOWARD THE  
FLOOR - THAT IS THEY  
WERE WIDER AT THE  
TOP THAN AT THE  
FLOOR. IN THIS CASE  
THE BACK LEGS WERE  
SQUARE BELOW THE  
SEAT.



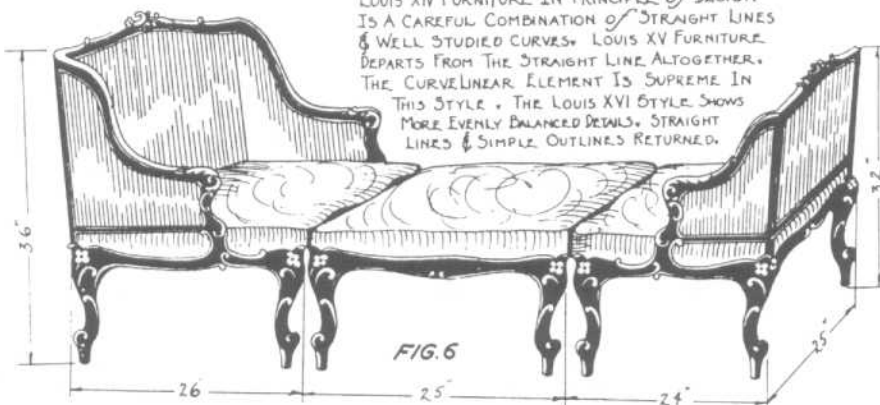
LOUIS XV SEAT



LOUIS XIV SIDE CHAIR



LOUIS XVI SEAT



LOUIS XV CHAISE LONGUE  
FORMED BY COMBINING  
THREE PIECES OF FURNITURE

LOUIS XIV FURNITURE IN PRINCIPLE OF DESIGN IS A CAREFUL COMBINATION OF STRAIGHT LINES & WELL STUDIED CURVES. LOUIS XV FURNITURE DEPARTS FROM THE STRAIGHT LINE ALTOGETHER. THE CURVE LINEAR ELEMENT IS SUPREME IN THIS STYLE. THE LOUIS XVI STYLE SHOWS MORE EVENLY BALANCED DETAILS. STRAIGHT LINES & SIMPLE OUTLINES RETURNED.

THE FABRICS USED TO UPHOLSTER LOUIS XIV FURNITURE WERE TAPESTRIES, DAMASKS, CLOTH OF GOLD & SATINS. IN TAPESTRIES PICTORIAL & RICH COLORED EFFECTS WERE USUAL. LOUIS XV PIECES WERE UPHOLSTERED WITH THE SAME MATERIALS AS GIVEN ABOVE. DECORATIVE MOTIFS DIFFERED SOMEWHAT. THE PICTORIAL ELEMENT GAVE WAY TO THE HIGHLY DECORATIVE SHELL & LEAF MOTIFS. IN LOUIS XVI PIECES THE FABRICS WERE DECORATED WITH FORMAL FLOWER BOUQUETS, RIBBONS, GARLANDS OF PAINTY FLOWERS, CUPIDS, ETC. SOFT COLORS PREDOMINATE IN THIS STYLE.

PERIOD FURNITURE

16th and 17th Century Spanish

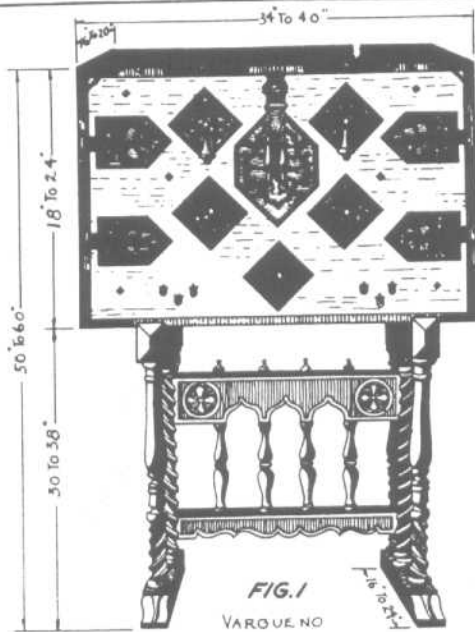


FIG. 1  
VARQUE NO

THESE CABINETS ORIGINATED IN SPAIN DURING THE 16TH CENTURY. THEY WERE OFTEN USED AS A DESK & ARE EASILY THE MOST IMPORTANT CONTRIBUTION OF SPAIN TO THE FURNITURE WORLD.

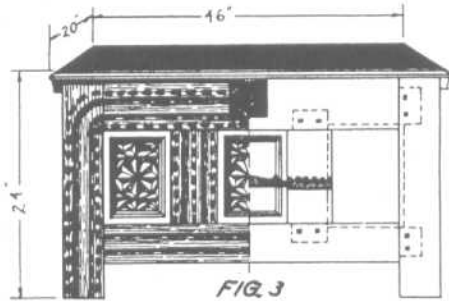


FIG. 3

17TH CENTURY CHEST WITH CHIP CARVED PANELS LAID OUT IN GEOMETRIC DESIGNS. INTERRUPTED CHANNEL GROOVES ON LEGS. RAILS & STILES. SPANISH CHESTS VARY GREATLY IN CHARACTER. SOME ARE DESIGNED WITH ROUND LIDS. SOME ARE FASTENED TO TURNED LEGGED FRAMES. OTHERS ARE COVERED WITH TOOLED LEATHER OR CARVED IN GOTHIC MOTIFS, ETC.

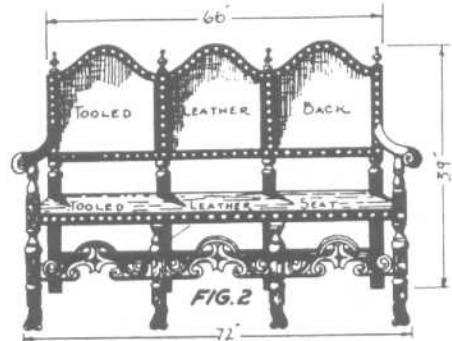
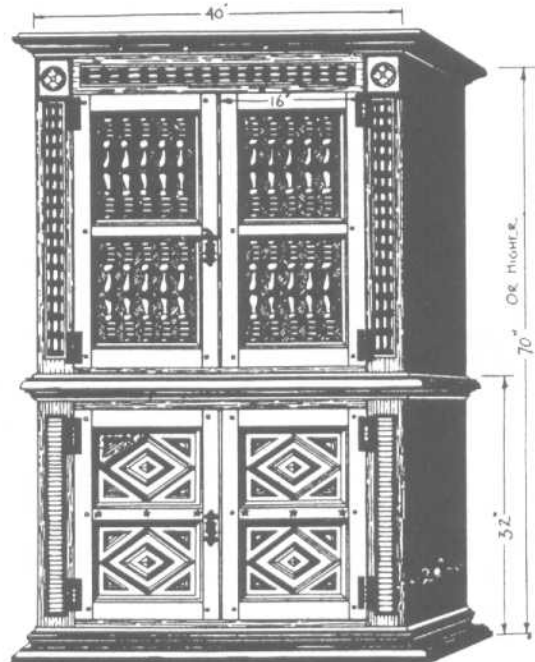


FIG. 2  
THREE BACK SETTEE WITH TOOLED LEATHER BACK & SEAT FASTENED WITH LARGE HEADED BRASS NAILS CIRCA. 1700



CUPBOARD OF THE 16TH CENTURY. RENAISSANCE PERIOD. THESE CUPBOARDS WERE USED TO HOLD FOOD SUCH AS BREAD & CHEESE & WINE. FIG. 4

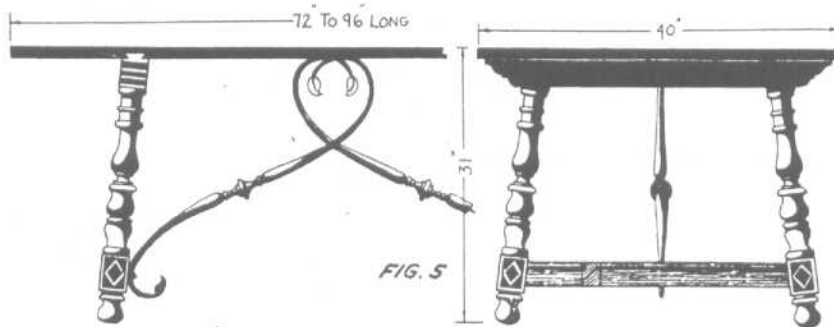


FIG. 5

FRONT & END VIEWS OF TURNED LEGGED TABLE WITH WROUGHT IRON BRACES

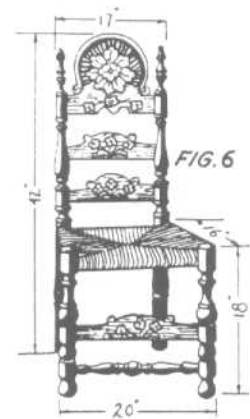


FIG. 6

18TH CENTURY SPANISH SIDE CHAIR.

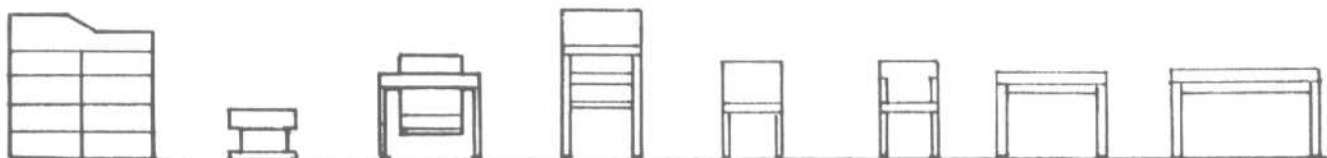
TABLE 1 Period Style and Finishes

Period style	Associated styles	Walls and ceilings	Floors	Floor coverings
Early English Tudor Jacobean Charles II	Italian Renaissance Spanish Renaissance William & Mary Larger pieces of Queen Anne	Oak panels Rough plaster with oak trim Parquetry ceilings	Hardwood stained, dark strips and planks on flooring Stone Tiles	Oriental and large- patterned domestic rugs Plain rugs
Anglo-Dutch William & Mary Queen Anne	Chippendale Early Georgian Louis XVI Smaller pieces of Jacobean, such as gate-leg table or Windsor chair	Papered Painted (in light tones) Hung with fabrics Paneled	Hardwood flooring Parquetry	Oriental and large- patterned domestic rugs Plain rugs
Early Georgian Chippendale	Chippendale Early Georgian Louis XVI Smaller pieces of Jacobean, such as gate-leg table or Windsor chair	Painted dado Painted Paneled Papered upper section	Hardwood flooring Parquetry	Plain or small-patterned rugs or carpets Oriental rugs
Late Georgian Adam Hepplewhite Sheraton Empire Federal	Chinese Chippendale Louis XVI Duncan Phyfe Directoire	Plain plaster Painted Papered Large wood panels painted Gesso ceilings	Hardwood flooring Parquetry	Plain or small-patterned rugs or carpets Oriental rugs
Louis XIV, XV, and XVI	All late Georgian styles 1 or 2 pieces of Directoire	Large wood panels painted and decorated Wallpaper in Chinese motifs	Hardwood flooring Parquetry	Plain or small-patterned rugs or carpets Oriental rugs
Spanish Renaissance	Italian Renaissance Early English Louis XIV	Rough plaster painted Ceilings same or beamed	Hardwood flooring Tiles Vinyls in tile pattern	Spanish or Oriental rugs
Early Colonial	All Early English styles William & Mary Queen Anne wing chair	Oak panels Rough plaster with oak Parquetry ceilings	Hardwood flooring or planks Vinyls in jaspe pattern	Braided or hooked rugs
Early American	Late Georgian Chippendale Queen Anne Duncan Phyfe French Provincial	Smooth plaster, light trim Wallpaper, scenic and Chinese designs Paneling Ceiling plaster	Dark hardwood flooring Vinyls in plain or jaspe patterns	Hooked, braided, Oriental, or domestic rugs Carpet, plain, two-toned patterned
Modern	Swedish Modern Chinese Chippendale	Painted solid colors, striped, figured Plain papers Combinations of above	Hardwood flooring Parquetry Vinyls in modern pattern	Carpet Rugs in solid colors, geometric patterns
French Provincial	18th-century American Colonial Federal	Smooth plaster Wallpaper in scenic or geometric designs	Hardwood flooring Parquetry	Aubussons Homespun carpet, small- patterned Oriental rugs
Victorian	Colonial William & Mary Queen Anne	Large-patterned paper	Hardwood flooring	Carpet in large patterns Oriental rugs

FURNITURE DIMENSIONS

Children's Furniture and Tables

CHILDREN'S FURNITURE



DIAPER CHANGER  
H: 36" - 42"  
W: 32" - 42"  
D: 21" - 24"

POTTY CHAIR  
H: 12" - 13"  
W: 16" - 17"  
D: 14" - 16"

FEEDING UNIT  
H: 24" - 26"  
W: 24" - 28"  
D: 24" - 25"

HIGH CHAIR  
H: 36" - 40"  
W: 18" - 22"  
D: 18" - 20"

SIDE CHAIR  
H: 24" - 26"  
W: 14" - 16"  
D: 15" - 17"

ARM CHAIR  
H: 23" - 25"  
W: 14" - 16"  
D: 16" - 17"

TABLE for 2  
H: 20" - 22"  
W: 24" - 30"  
D: 24" - 25"

TABLE for 4  
H: 20" - 22"  
W: 36" - 42"  
D: 36" - 42"

TABLES



END/SIDE  
H: 20"  
W: 36"  
D: 20"



END/SIDE  
H: 18"  
W: 20"  
D: 20"



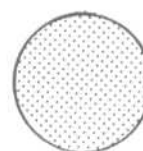
END/SIDE  
H: 18"  
Diam. 18"



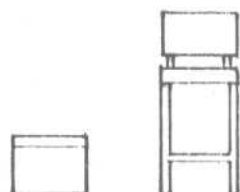
LOW/COFFEE  
H: 18"  
W: 36"  
D: 24"



LOW/COFFEE  
H: 18"  
W: 36"  
D: 36"



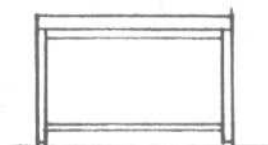
LOW/COFFEE  
H: 18"  
Diam. 36"



STOOLS  
H: 18"  
W: 18"  
D: 18"



STOOLS  
H: 38"  
W: 18"  
D: 20"



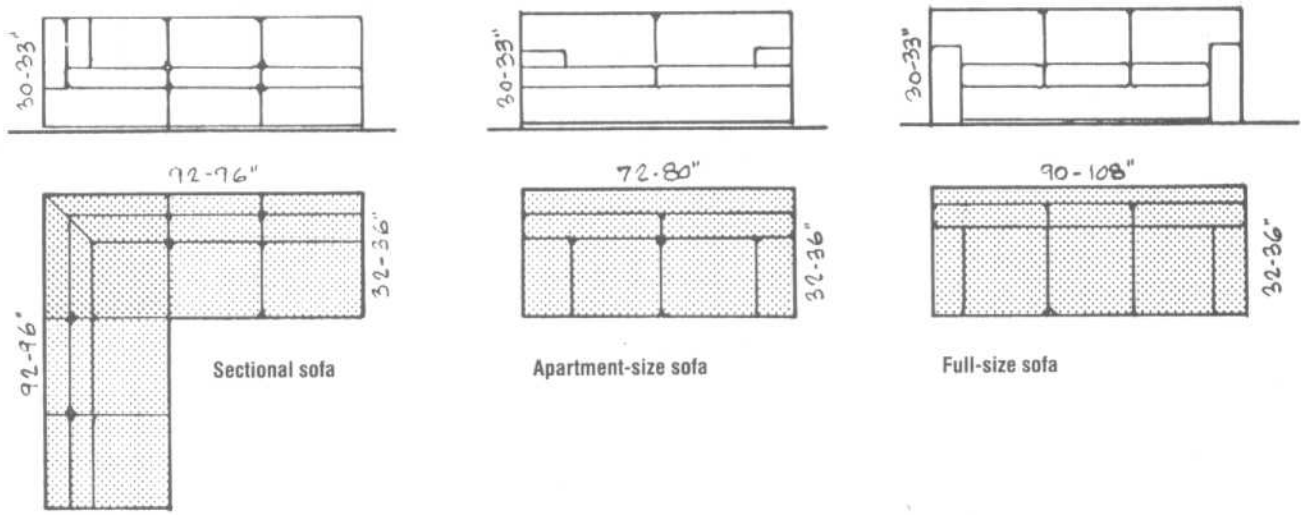
ENTRY/HALLWAY  
H: 33"  
W: 48"  
D: 20"



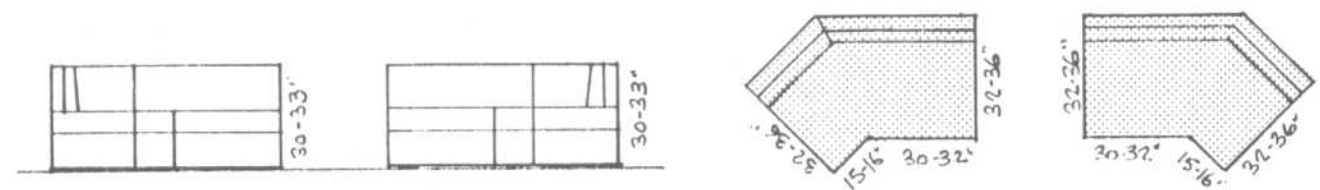
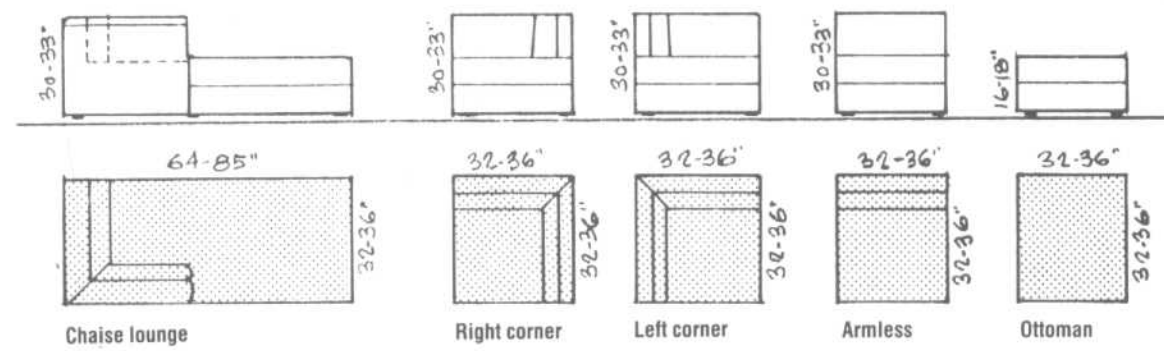
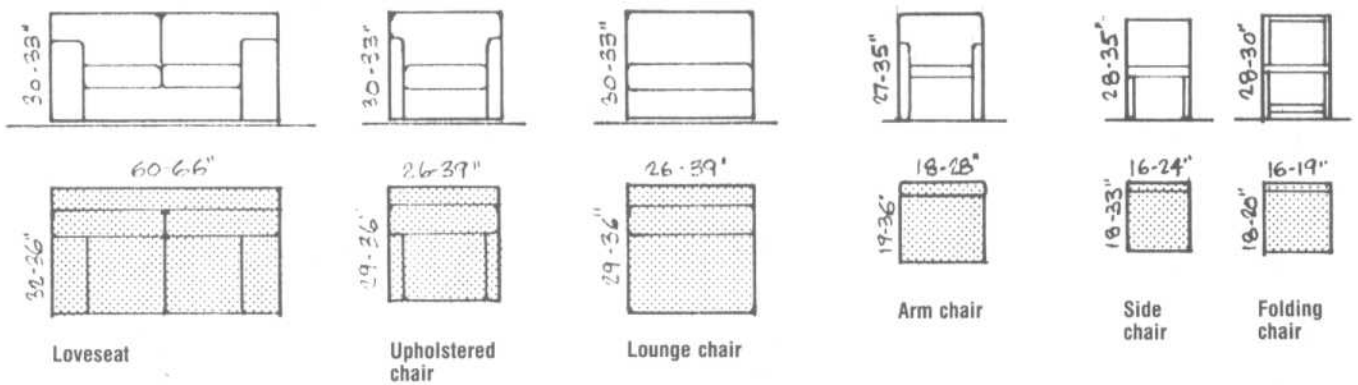
FURNITURE DIMENSIONS

Sofas, Loveseats, Lounge Chairs, and Arm Chairs

SOFAS



LOVESEATS, LOUNGE CHAIRS, AND ARM CHAIRS



Angled sectionals

## FURNITURE DIMENSIONS

## Bed/Mattress Types and Sizes

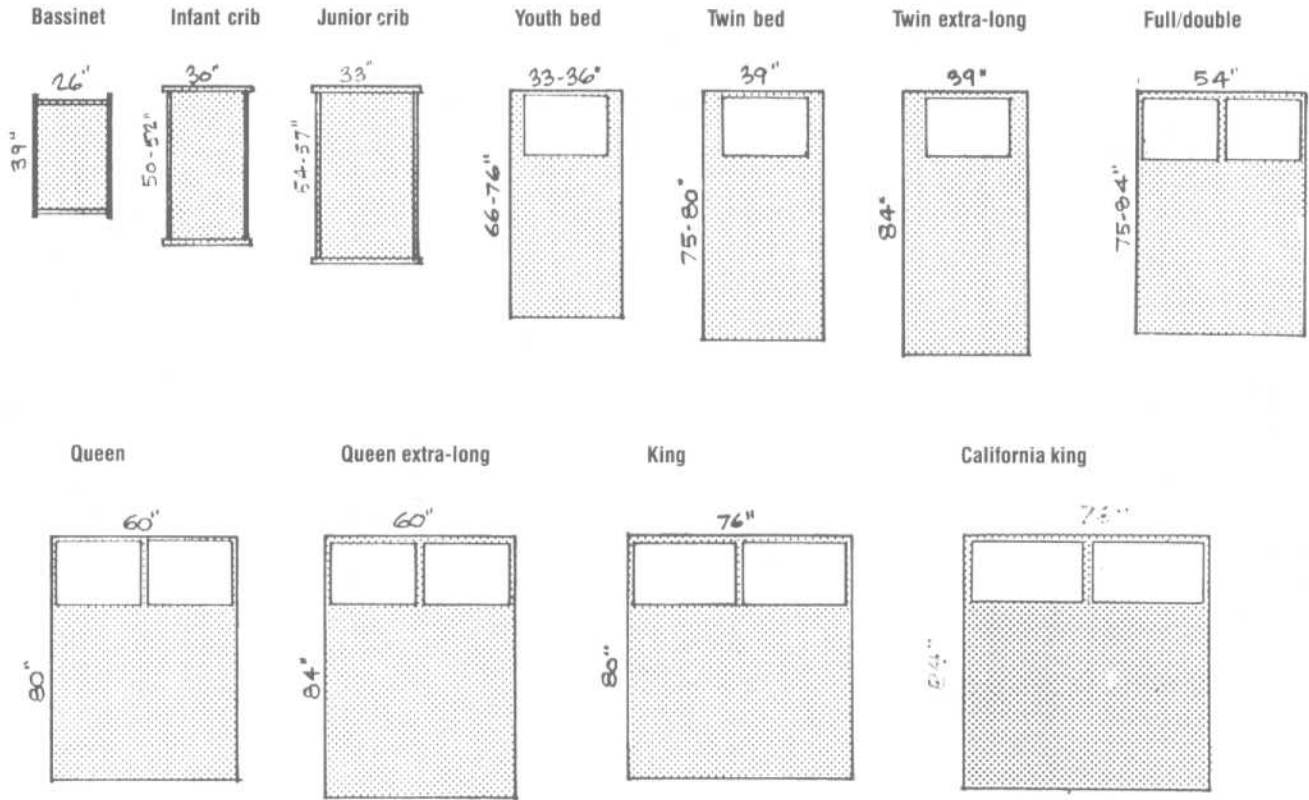


Fig. 1

Figure 1 provides the designer with an array of typical bed and mattress sizes with which rooms can be planned. Tables 1 and 2, however, suggest that within the bedding and mattress industries there exists a wide range of sizes from which to select. Many manufacturers use bed/mattress terminology that reflects different dimensional standards than that of other manufacturers. Ultimately, the designer, in consultation with the client, must verify exact measurements. Be sure to take your clients to see and test the bed or mattress selected. After all, they are the ones who will have to sleep on it.

TABLE 1 Juvenile, Youth, and Adult Mattress Types and Sizes

Mattress type	Width (in)		Length (in)	
	Min	Max	Min	Max
Bassinet	17	23	36	40
Portable crib	22	26	45	52
Junior crib	24	32½	46	58
Youth bed	33	36	66	76
Bunk bed	30	33	75	76
Dorm bed	32	36	75	80
Hospital bed	36	36	75	80
Narrow twin	36	36	74	75
Twin bed	39	39	75	80, 84
Full-size or double bed	54	54	74	75
Queen-size bed	60	60	80	84
King-size bed	76	78	80	84
Extra-long double	54	54	80	80
Super twin	45	45	75	80

TABLE 2 Pillow Types and Sizes

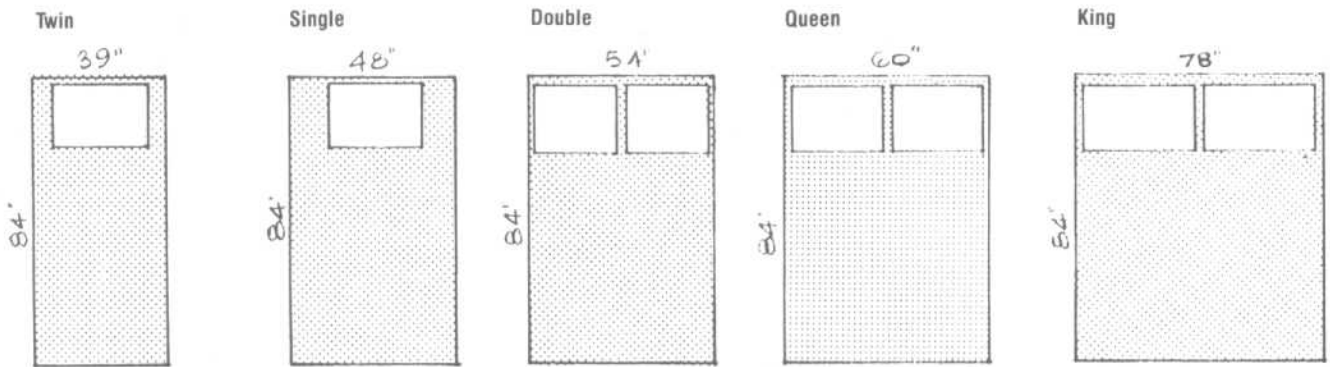
Pillow type	Width (in)		Length (in)	
	Min	Max	Min	Max
Standard	18	20	26	27
Queen	19	21	29	30
King	20	22	35	36

Note: Many manufacturers also make and sell undersized pillows for cribs and youth beds as well as oversized pillows for the larger beds.

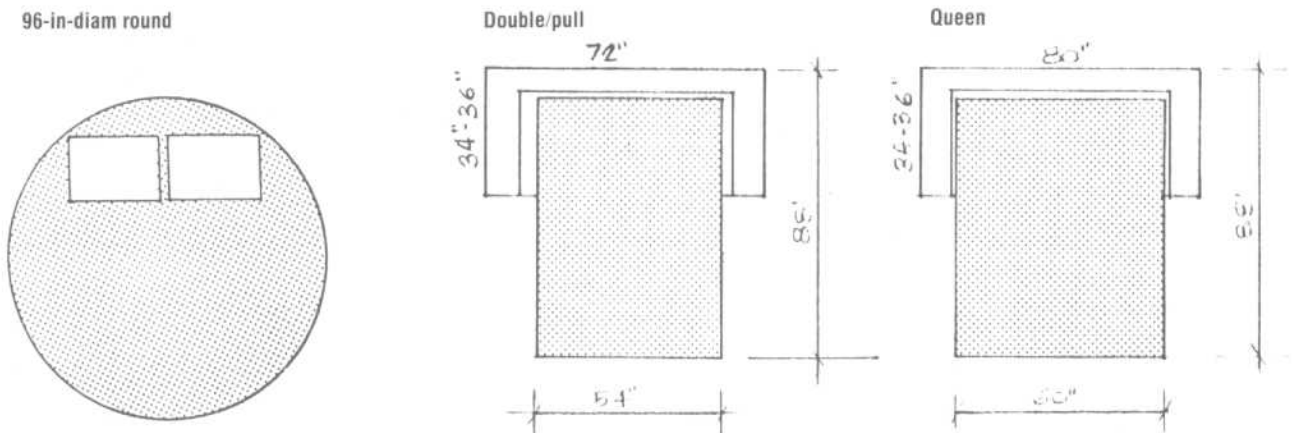
FURNITURE DIMENSIONS

Waterbeds, Sofa Beds/Convertible Sofas, and Wall Beds

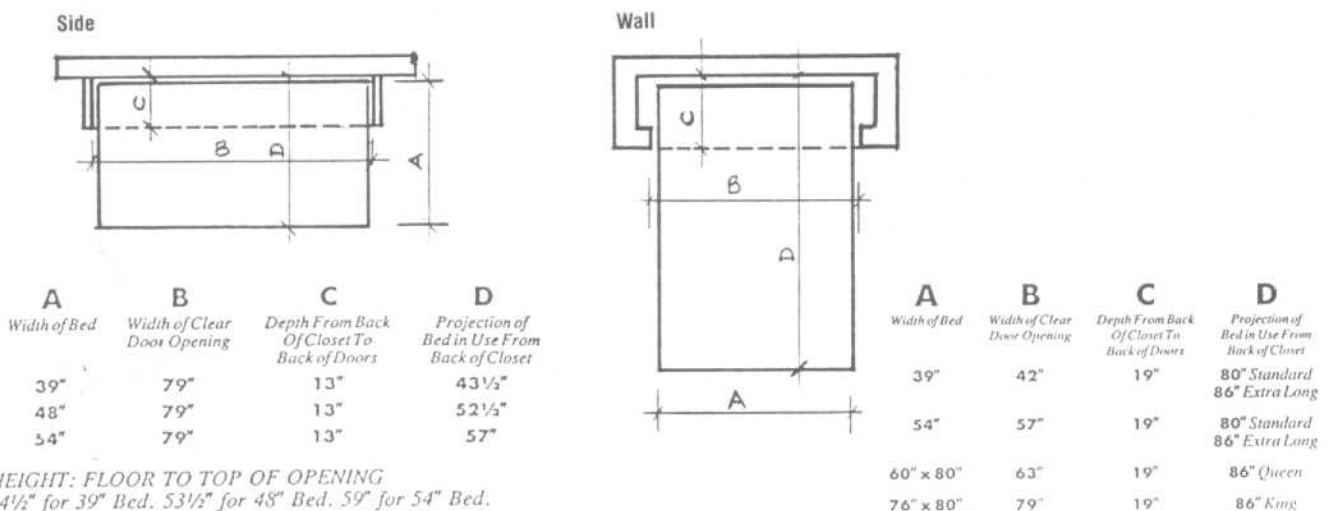
WATERBEDS



SOFA BEDS/CONVERTIBLE SOFAS



WALL AND SIDE BEDS

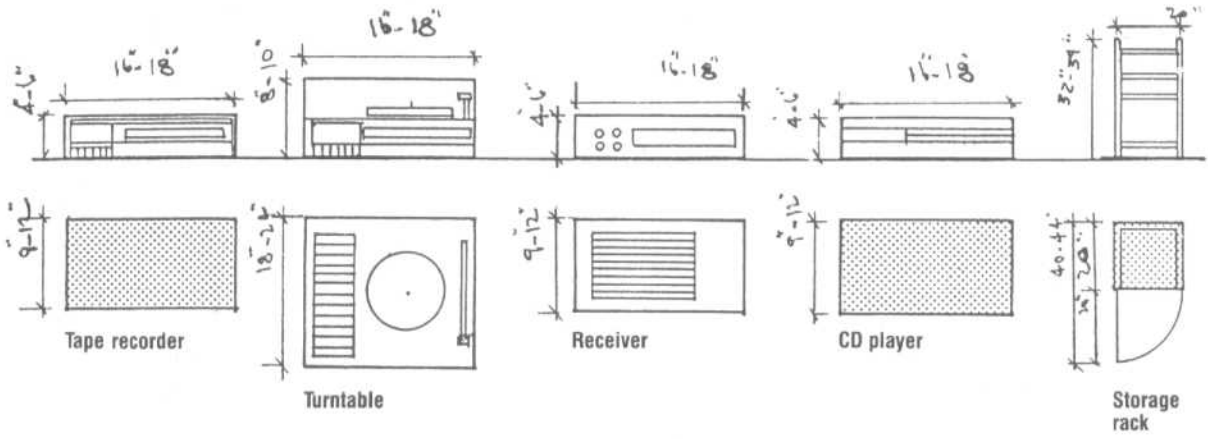
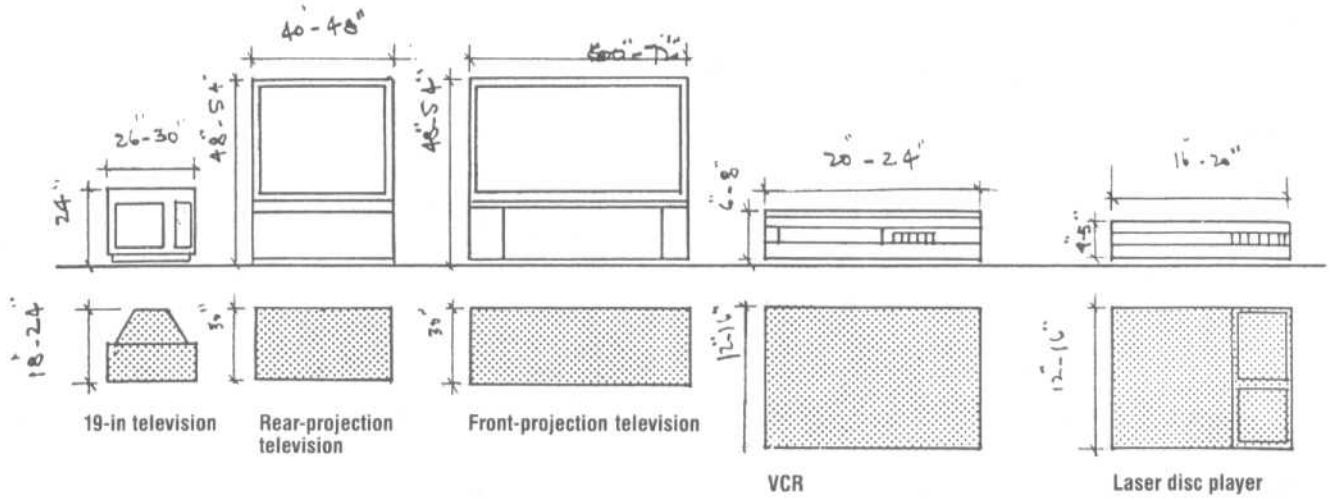


HEIGHT: FLOOR TO TOP OF OPENING  
 44 1/2" for 39" Bed, 53 1/2" for 48" Bed, 59" for 54" Bed.

HEIGHT: FLOOR TO TOP OF OPENING  
 80" - For 39" and 54" Beds of Standard 75" Length  
 86" - For Queen, King and Extra Long Beds 80" in Length

FURNITURE DIMENSIONS

Audio-Visual Equipment



The shape of the viewing area is approximately as shown in Fig. 2. Its size is always based on the size of the image to be viewed. The human eye comprehends detail only within a limited cone angle (about  $2\frac{1}{2}$  minutes of arc), and the length of chord subtending this arc, i.e., the image of width, varies with its distance from the observer. Thus an object 20 feet away and 6 feet long appears the same as a similar object 10 feet away and 3 feet long. The size of the viewing area is determined by three dimensions:

- the minimum distance (1), which is the distance from the nearest part of the image to the eye of the closest viewer

- the maximum distance (2), which is the distance from the furthestmost part of the image to the most distant viewer

- the maximum viewing angle (3), which is the angle between the projection axis and the line of sight of a person located as far from this axis as can be and still see all image detail in proper brilliance

Practical minimum and maximum distances are both expressed as multiples of the image width ( $W$ ). They vary both with the medium being used and with the type and quality of material being projected, and may be affected also, in some degree, by personal preferences. They have not yet been precisely determined by scientific methods, and it's doubtful that such data would have much practical value anyway. The generally accepted values, resulting from numerous studies, are these:

	Film, slides, and projected TV	TV receivers
Minimum distance	$2W$	$4W$
Maximum distance	$6W$ to $10W$	$12W$

Size of TV tube	Minimum viewing distance $4W$	Maximum viewing distance $12W$
17 in	4 ft 11 in	14 ft 9 in
19 in	5 ft 1 in	15 ft 2 in
21 in	6 ft 4 in	19 ft 0 in
23 in	6 ft 6 in	19 ft 4 in
24 in	7 ft 5 in	21 ft 5 in
27 in	9 ft 8 in	24 ft 5 in

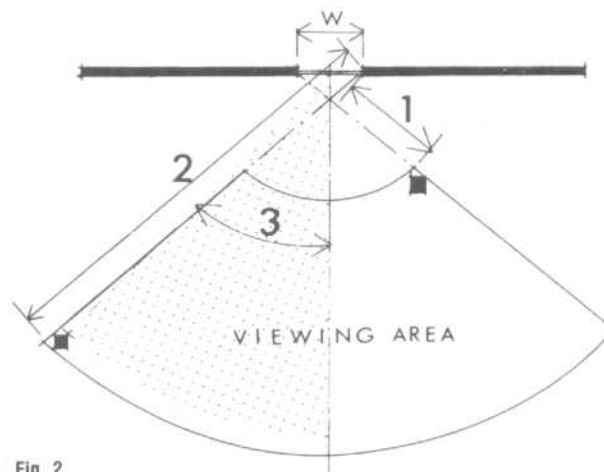
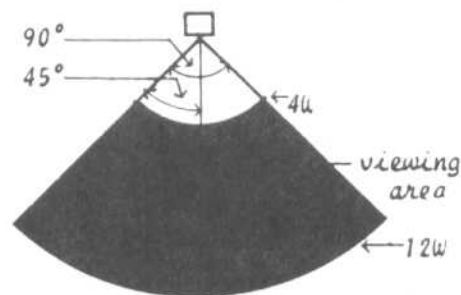


Fig. 2



FURNITURE DIMENSIONS

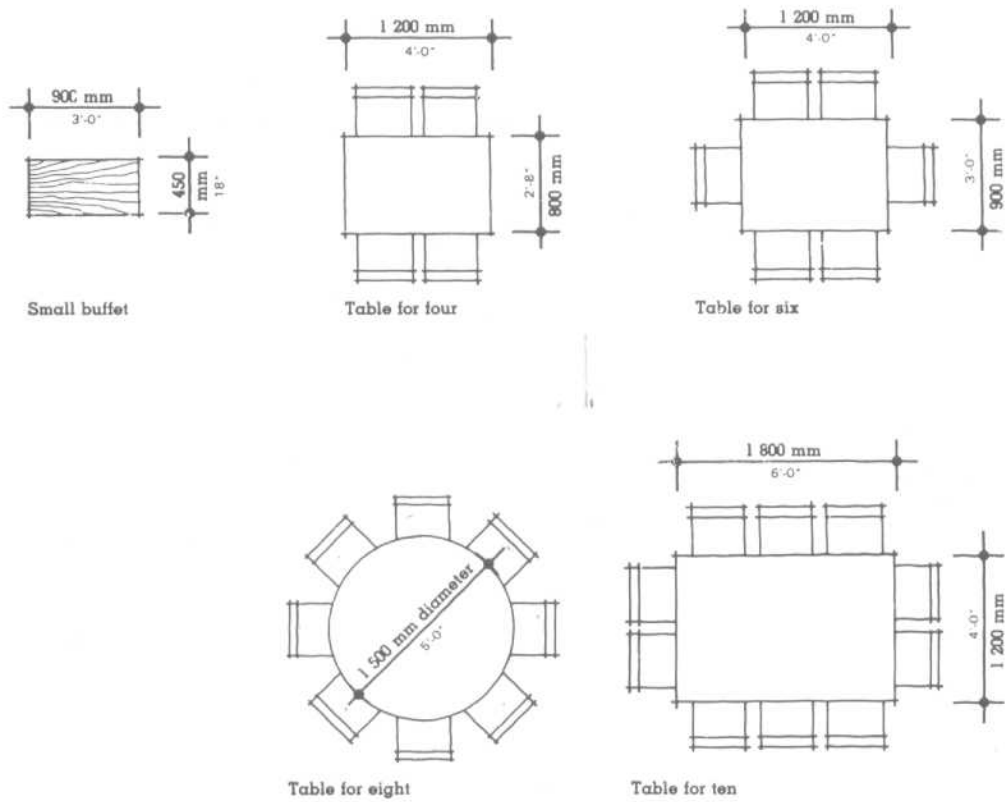


Fig. 3 Typical dining room furniture.

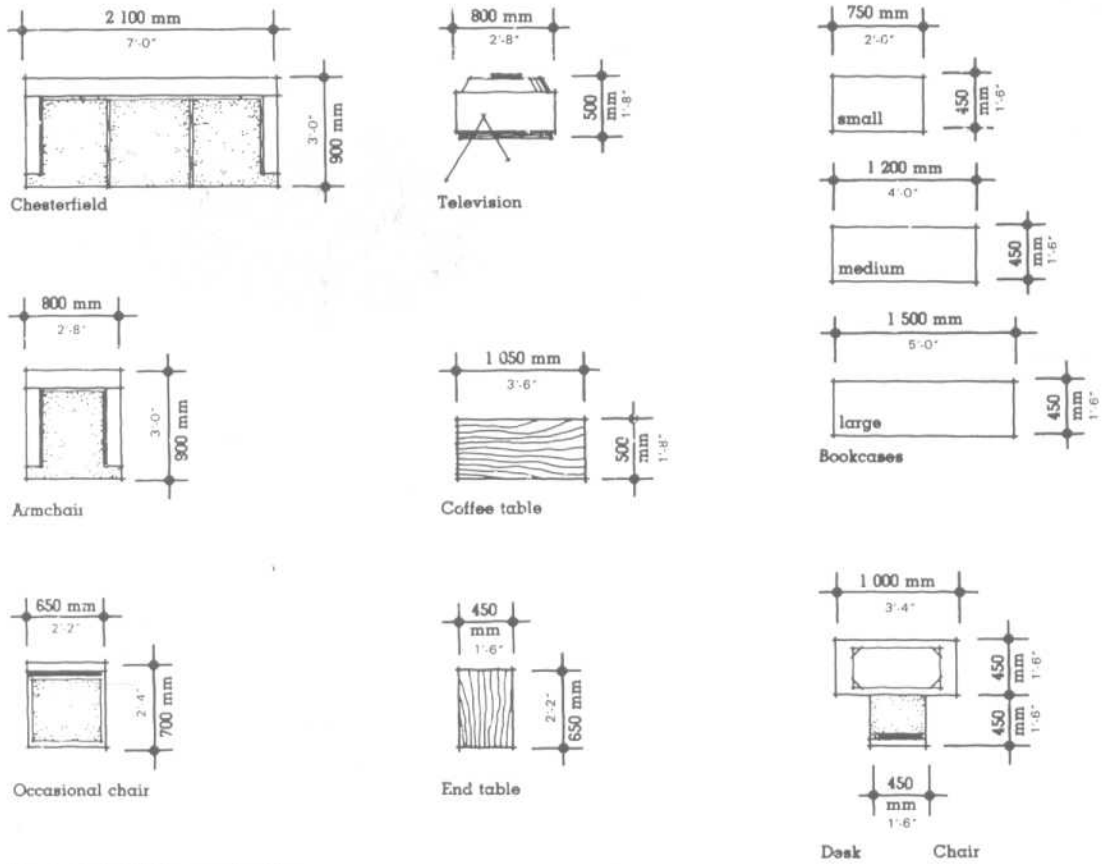
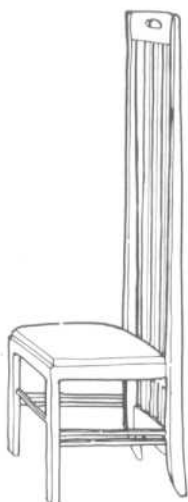


Fig. 4 Typical living room furniture.

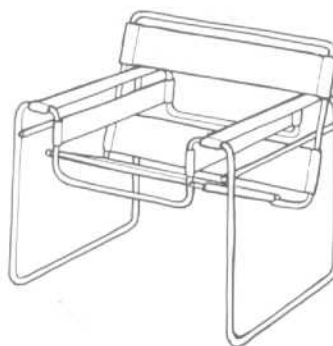


## FURNITURE DIMENSIONS

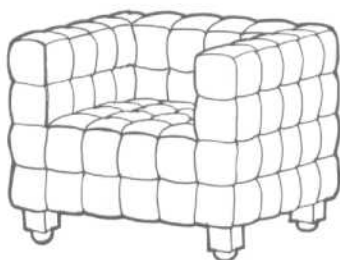
20th Century Classic Chairs

**INGRAM HIGH CHAIR**

DESIGNER:  
Charles R. Macintosh  
YEAR: 1900  
MANUFACTURER:  
Atelier International  
DIMENSIONS:  
18½"W x 17½"D x 59¼"H

**WASSILY CHAIR**

DESIGNER:  
Marcel Breuer  
YEAR: 1925  
MANUFACTURER:  
Knoll International  
DIMENSIONS:  
30¾"W x 29"D x 28½"H

**KUBUS CHAIR**

DESIGNER:  
Joseph Hoffman  
YEAR: 1910  
DIMENSIONS:  
36"W x 30½"D x 28½"H

**MR. CHAIR**

DESIGNER:  
Mies Van Der Rohe  
YEAR: 1927  
MANUFACTURER:  
Stendig  
DIMENSIONS:  
21¼"W x 32¼"D x 32¼"H

**HAU KOLLER CHAIR**

DESIGNER:  
Joseph Hoffman  
YEAR: 1911  
DIMENSIONS:  
35½"W x 32"D x 37"H

**LC1 SLING CHAIR**

DESIGNER:  
Le Corbusier  
YEAR: 1928  
MANUFACTURER:  
Atelier International  
DIMENSIONS:  
23⅞"W x 25⅞"D x 25¼"H

**MIDWAY CHAIR**

DESIGNER:  
Frank Lloyd Wright  
YEAR: 1914  
MANUFACTURER:  
Atelier International  
DIMENSIONS:  
16"W x 13"D x 35"H

**LC9 LOUNGE CHAIR**

DESIGNER:  
Le Corbusier  
YEAR: 1928  
MANUFACTURER:  
Atelier International  
DIMENSIONS:  
22"W x 63"D

FURNITURE DIMENSIONS

20th Century Classic Chairs



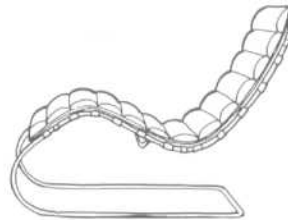
**CESCA ARMCHAIR**  
DESIGNER:  
Marcel Breuer  
YEAR: 1928  
MANUFACTURER:  
Knoll International  
DIMENSIONS:  
22 $\frac{5}{8}$ "W x 21 $\frac{5}{8}$ "D x 31 $\frac{3}{4}$ "H



**BARCELONA STOOL**  
DESIGNER:  
Mies Van Der Rohe  
YEAR: 1929  
MANUFACTURER:  
Knoll International  
DIMENSIONS:  
23"W x 22"D x 14 $\frac{1}{2}$ "H



**BRNO ARMCHAIR**  
DESIGNER:  
Mies Van Der Rohe  
YEAR: 1929  
MANUFACTURER:  
Stendig  
DIMENSIONS:  
18"W x 23"D x 31 $\frac{1}{2}$ "H



**CHAISE LOUNGE**  
DESIGNER:  
Mies Van Der Rohe  
YEAR: 1931  
MANUFACTURER:  
Knoll International  
DIMENSIONS:  
23 $\frac{3}{4}$ "W x 47 $\frac{1}{2}$ "D x 37 $\frac{1}{2}$ "H



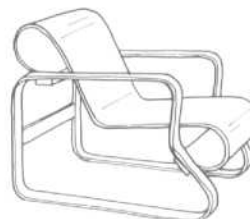
**LC2 ARMCHAIR**  
DESIGNER:  
Le Corbusier  
YEAR: 1929  
MANUFACTURER:  
Atelier International  
DIMENSIONS:  
30"W x 27 $\frac{1}{2}$ "D x 26 $\frac{1}{2}$ "H



**ZIG-ZAG CHAIR**  
DESIGNER:  
Gerrit Rietveld  
YEAR: 1934  
MANUFACTURER:  
Atelier International  
DIMENSIONS:  
14 $\frac{1}{2}$ "W x 17"D x 29"H



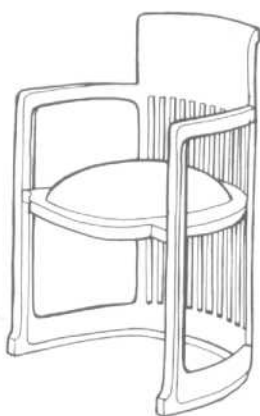
**BARCELONA CHAIR**  
DESIGNER:  
Mies Van Der Rohe  
YEAR: 1929  
MANUFACTURER:  
Knoll International  
DIMENSIONS:  
30"W x 30"D x 30"H



**PAIMO CHAIR**  
DESIGNER:  
Alvar Aalto  
YEAR: 1935  
MANUFACTURER:  
Palazetti  
DIMENSIONS:  
23 $\frac{1}{2}$ "W x 31 $\frac{1}{2}$ "D x 25"H

## FURNITURE DIMENSIONS

20th Century Classic Chairs

**BARREL CHAIR**

DESIGNER:  
Frank Lloyd Wright  
YEAR: 1937  
MANUFACTURER:  
Atelier International  
DIMENSIONS:  
21½"W x 22"D x 32"H

**MOLDED FIBERGLAS CHAIR**

DESIGNER:  
Charles Eames  
YEAR: 1949  
MANUFACTURER:  
Herman Miller  
DIMENSIONS:  
25"W x 25½"D x 31"H

**BUTTERFLY CHAIR**

DESIGNER:  
Harday, Boner & Kurchan  
YEAR: 1938  
DIMENSIONS:  
28"W x 27½"D x 35½"H

**DIAMOND CHAIR**

DESIGNER:  
Harry Bertoia  
YEAR: 1952  
MANUFACTURER:  
Knoll International  
DIMENSIONS:  
33¾"W x 28"D x 30½"H

**MOLDED PLYWOOD CHAIR**

DESIGNER:  
Charles Eames  
YEAR: 1946  
MANUFACTURER:  
Herman Miller  
DIMENSIONS:  
21½"W x 19¼"D x 29¾"H

**LOUNGE CHAIR**

DESIGNER:  
Charles Eames  
YEAR: 1956  
MANUFACTURER:  
Herman Miller  
DIMENSIONS:  
32½"W x 32¾"D x 33½"H

**WOMB CHAIR**

DESIGNER:  
Eero Saarinen  
YEAR: 1948  
MANUFACTURER:  
Knoll International  
DIMENSIONS:  
40"W x 39"D x 35½"H

**OTTOMAN**

DESIGNER:  
Charles Eames  
YEAR: 1956  
MANUFACTURER:  
Herman Miller  
DIMENSIONS:  
26"W x 21"D x 15"H

FURNITURE DIMENSIONS

20th Century Classic Chairs



**ALUMINUM GROUP CHAIR**

DESIGNER:  
Charles Eames  
YEAR: 1958  
MANUFACTURER:  
Herman Miller  
DIMENSIONS:  
28½"W x 24¾"D x 33¾"H



**LOUNGE CHAIR**

DESIGNER:  
Richard Schultz  
YEAR: 1966  
MANUFACTURER:  
Knoll International  
DIMENSIONS:  
26"W x 28¼"D x 26½"H



**SHERRIFF CHAIR**

DESIGNER:  
Sergio Rodriguez  
YEAR: 1958  
MANUFACTURER:  
OCA



**TUBO CHAIR**

DESIGNER:  
John Mascheroni  
YEAR: 1968  
MANUFACTURER:  
Vecta  
DIMENSIONS:  
32"W x 32"D x 32"H



**HAND CHAIR**

DESIGNER:  
Pedro Freidberg  
YEAR: 1963  
MANUFACTURER:  
Hand Crafted



**SAPPER COLLECTION**

DESIGNER:  
Richard Sapper  
YEAR: 1977  
MANUFACTURER:  
Knoll International  
DIMENSIONS:  
28¾"W x 27½"D x 38½-41¾"H



**PLATNER CHAIR**

DESIGNER:  
Warren Platner  
YEAR: 1966  
MANUFACTURER:  
Knoll International  
DIMENSIONS:  
36½"W x 25½"D x 30½"H

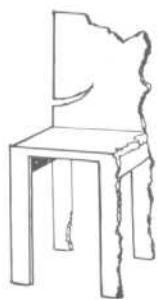


**BASIC OPERATIONAL**

DESIGNER:  
Niels Diffrient  
YEAR: 1979  
MANUFACTURER:  
Knoll International  
DIMENSIONS:  
25½"W x 21"D x 32½-36½"H

**FURNITURE DIMENSIONS**

20th Century Classic Chairs



**NOTHING CONTINUES TO HAPPEN CHAIR**

DESIGNER:  
Howard Meisler  
YEAR: 1981  
MANUFACTURER:  
Art et Industrie  
DIMENSIONS:  
17"W x 16"D x 37"H



**OTTOMAN**

DESIGNER:  
Niels Diffrient  
YEAR: 1986  
MANUFACTURER:  
Sunar/Hauserman  
DIMENSIONS:  
25"W x 24"D x 17½"H



**LOUNGE CHAIR**

DESIGNER:  
Michael Graves  
YEAR: 1982  
MANUFACTURER:  
Sunar/Hauserman  
DIMENSIONS:  
32"W x 29"D x 29"H



**ED ARCHER CHAIR**

DESIGNER:  
Philippe Starck  
YEAR: 1987  
MANUFACTURER:  
Diade Italy  
DIMENSIONS:  
18½"W x 21½"D x 38½"H



**QUEENE ANNE CHAIR**

DESIGNER:  
Robert Venturi  
YEAR: 1984  
MANUFACTURER:  
Knoll International  
DIMENSIONS:  
26½"W x 23½"D x 38½"H



**STONE CHAIR**

DESIGNER:  
James Kutasi  
YEAR: 1988  
MANUFACTURER:  
James Kutasi Australia  
DIMENSIONS:  
19½"W x 19½"D x 35½"H



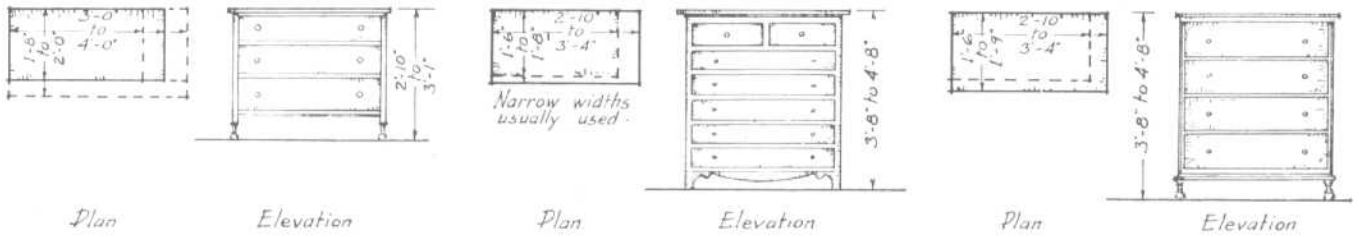
**JEFFERSON CHAIR**

DESIGNER:  
Niels Diffrient  
YEAR: 1986  
MANUFACTURER:  
Sunar/Hauserman  
DIMENSIONS:  
32¾"W x 34"D x 43½"H

**FURNITURE DIMENSIONS**

Traditional Bedroom and Dining Room Furniture

**BEDROOM FURNITURE**



*Narrow widths usually used.*

Plan

Elevation

Plan

Elevation

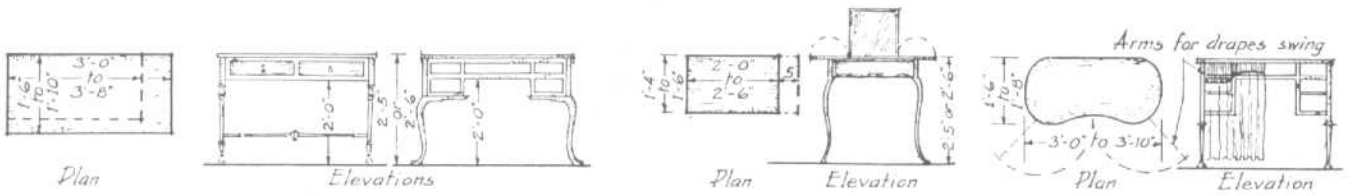
Plan

Elevation

**Bureau**

**Chiffonier**

**Chest of drawers**



Plan

Elevations

Plan

Elevation

Plan

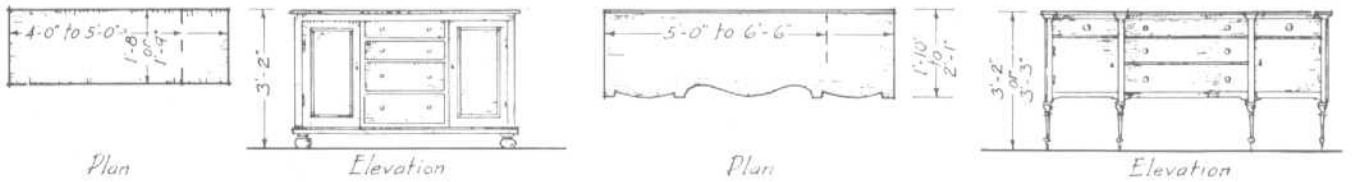
Elevation

**Dressing table**

**Makeup or powder table**

*Arms for drapes swing*

**DINING ROOM FURNITURE**



Plan

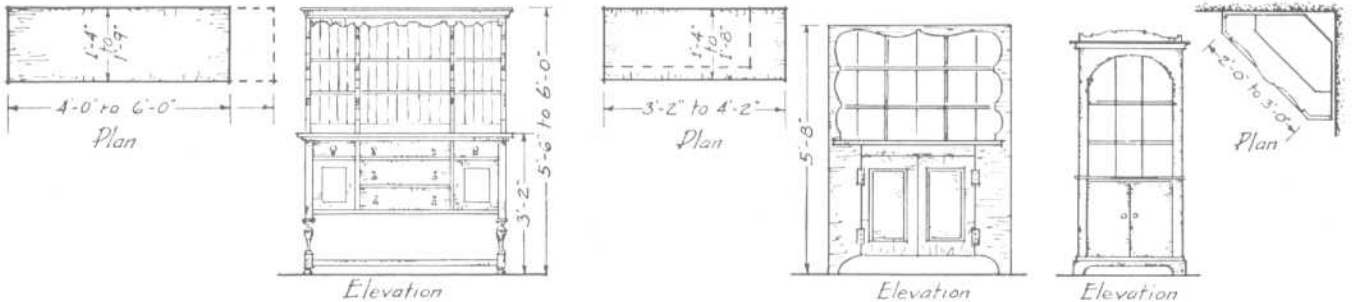
Elevation

Plan

Elevation

**Sideboard**

**Buffet**



Plan

Elevation

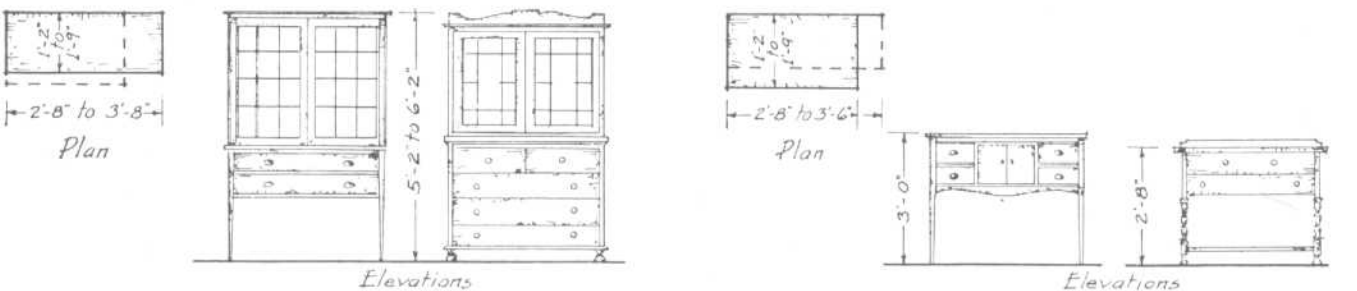
Plan

Elevation

Elevation

**Dresser**

**Cupboards**



Plan

Elevations

Plan

Elevations

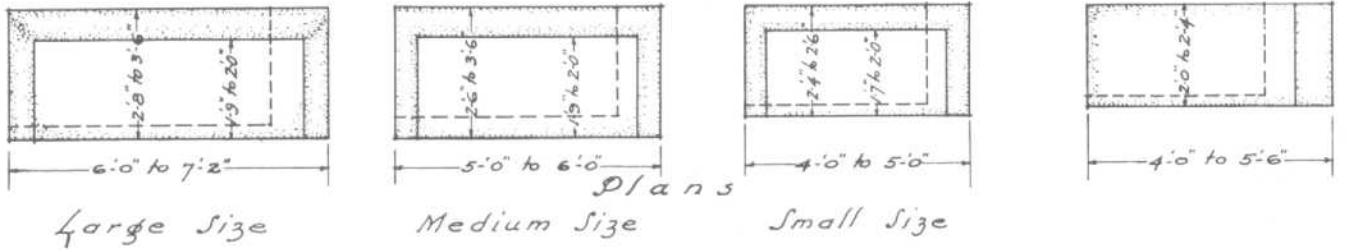
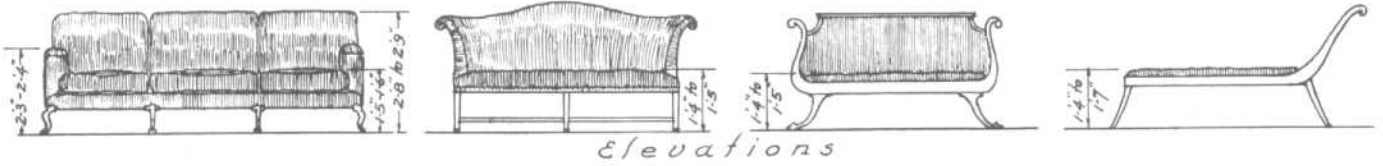
**China cabinets**

**Servers**

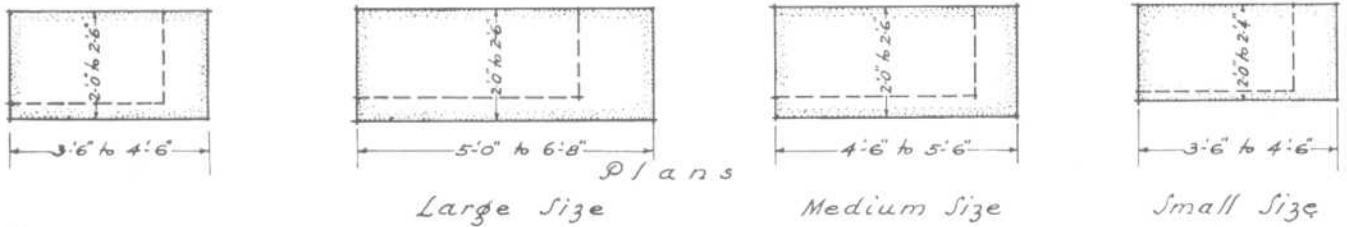
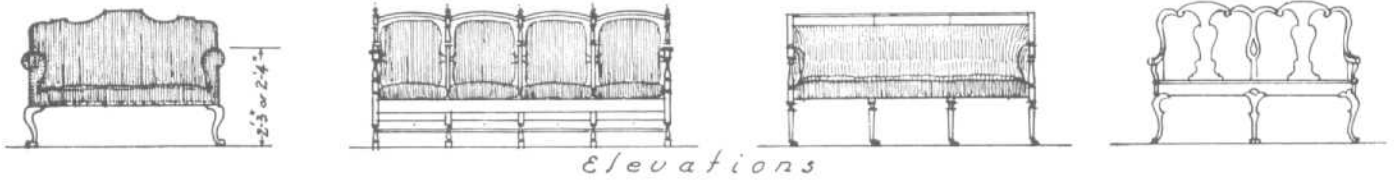


FURNITURE DIMENSIONS

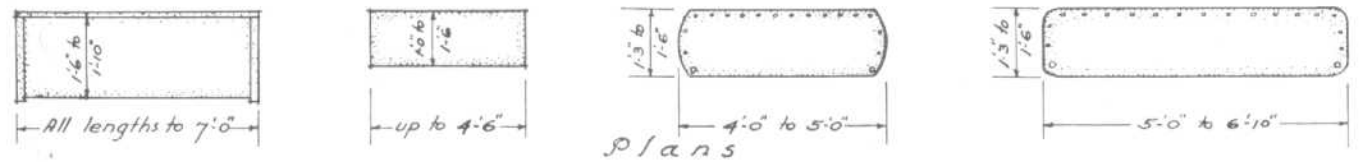
Traditional Sofas, Settees, and Benches



Sofas, couches, davenports, divans, lounges



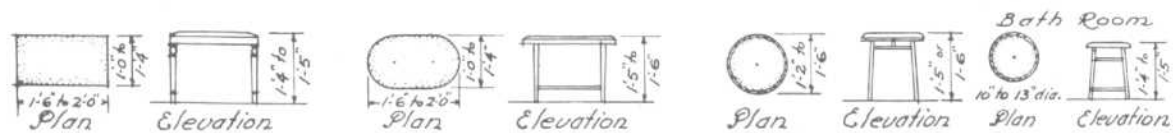
Settees



Settle

Bench

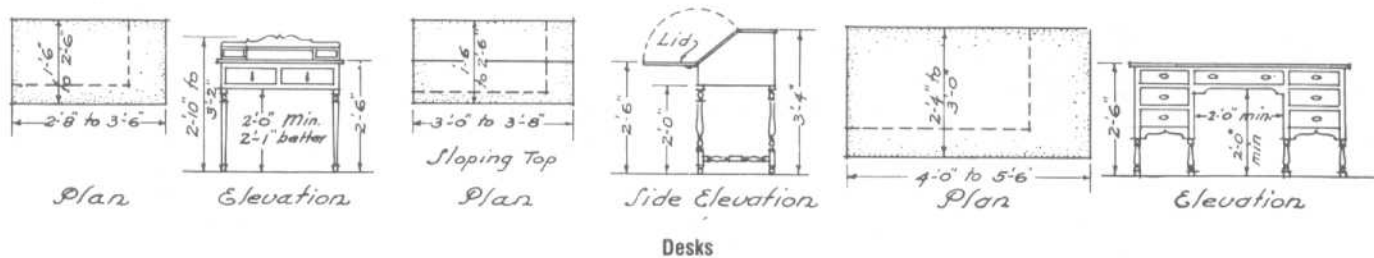
Seats (Windsor)



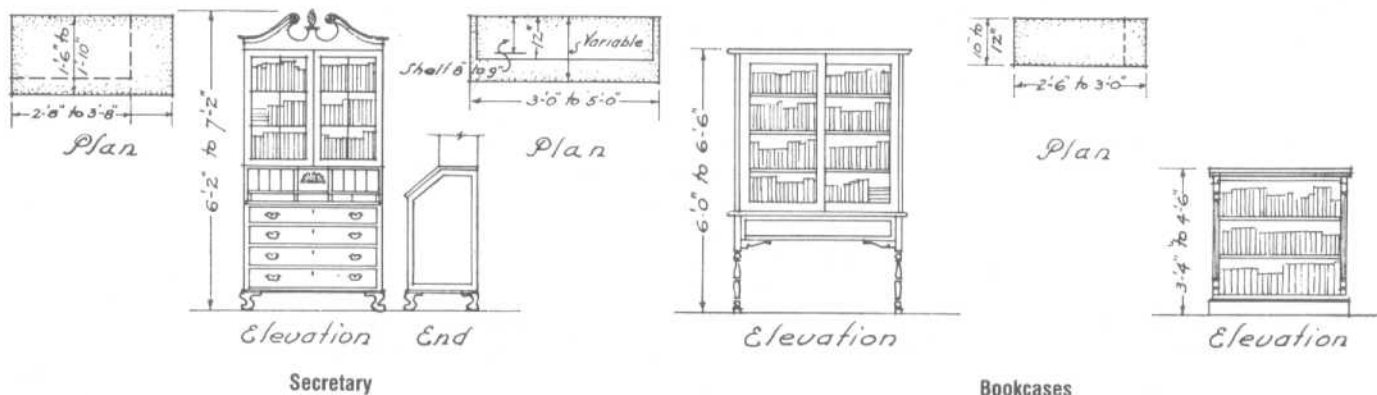
Dressing stools and benches

FURNITURE DIMENSIONS

Traditional Desks, Bookcases, and Chests

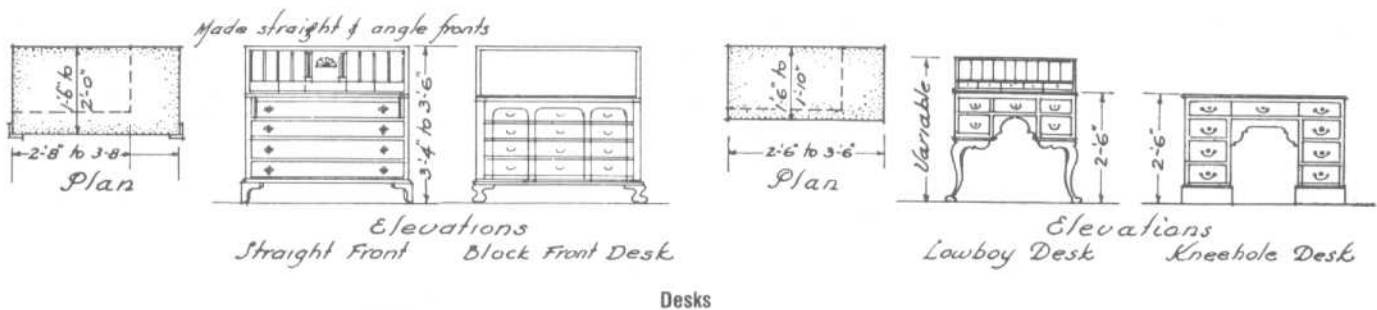


Desks

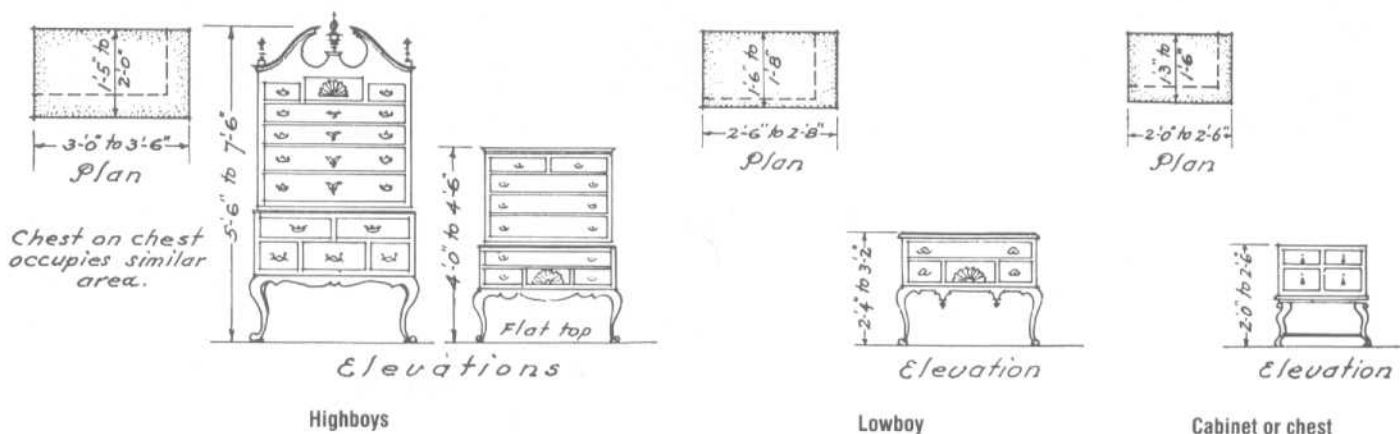


Secretary

Bookcases



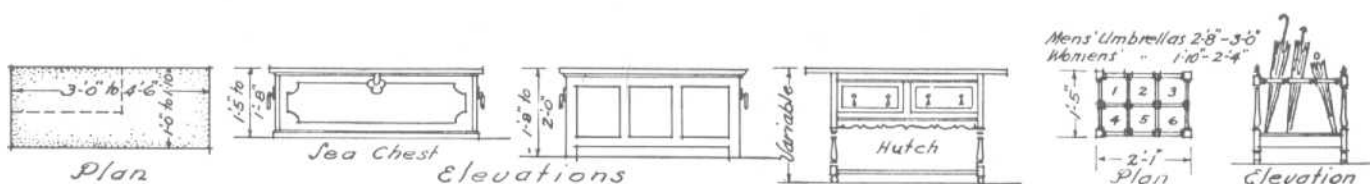
Desks



Highboys

Lowboy

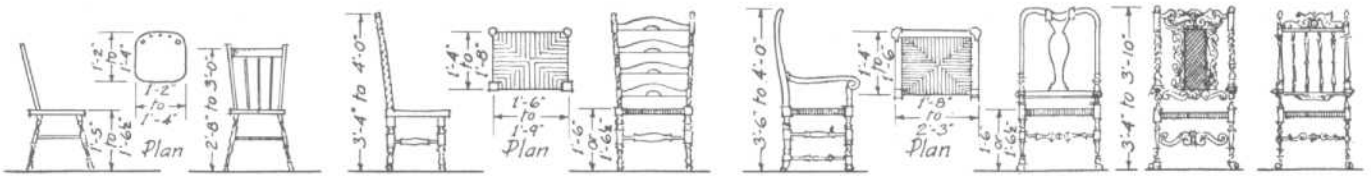
Cabinet or chest



Chests

Umbrella stand

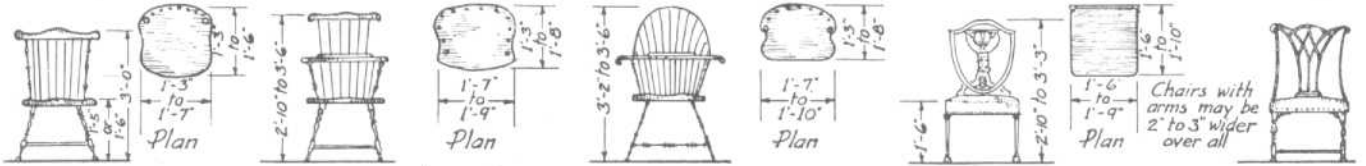
UNUPHOLSTERED CHAIRS



Kitchen chair

Side chair

Arm chairs

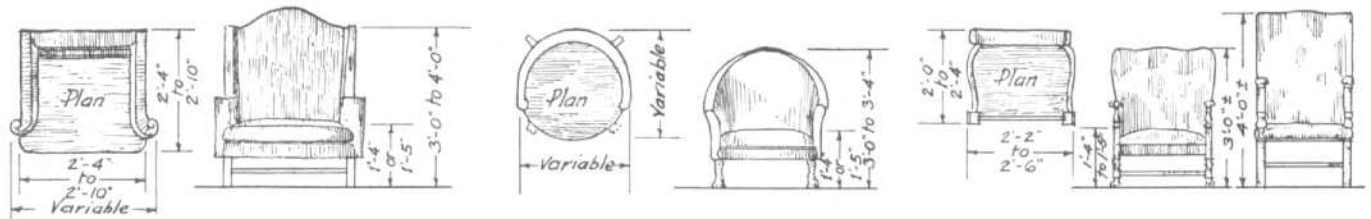


Arm chairs

Windsor chairs

Dining room chairs

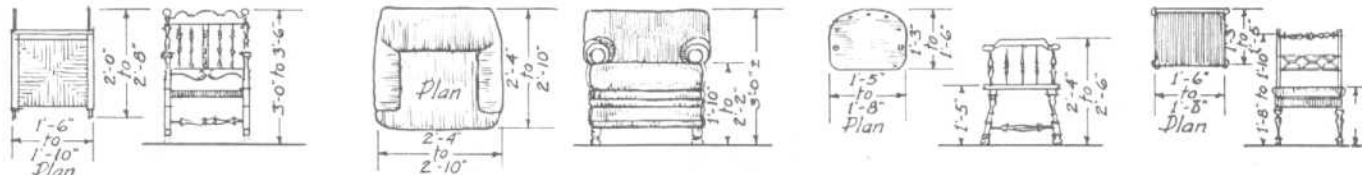
UPHOLSTERED CHAIRS



Wing chair

Barrel chair

Arm chairs

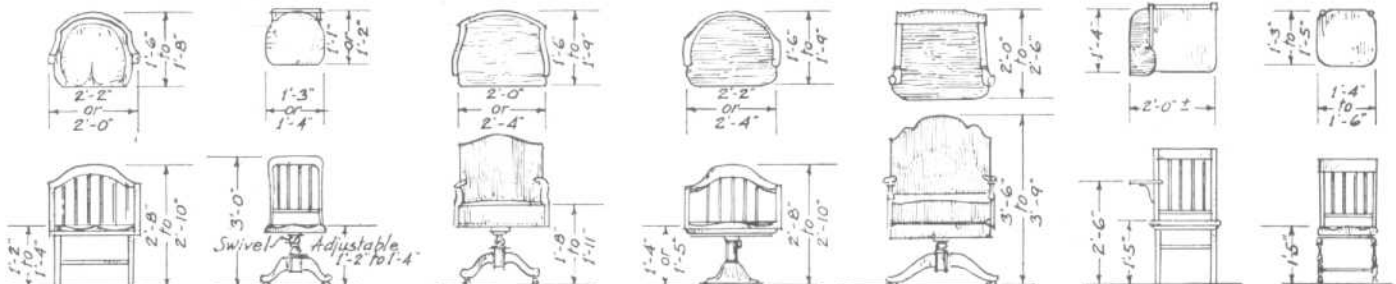


Rocking chair

Club chair

Tavern chair

Side chair

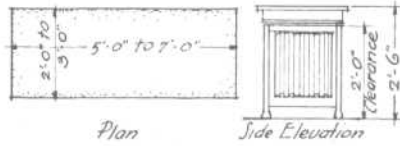


Office chairs

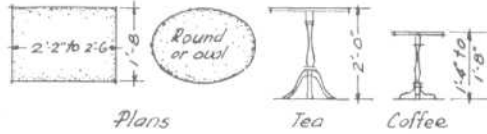
Special chairs

FURNITURE DIMENSIONS

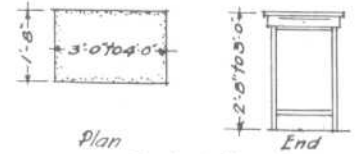
Traditional Tables



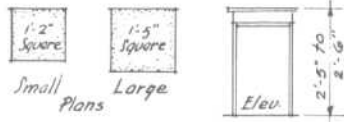
Library table



Tea and coffee tables



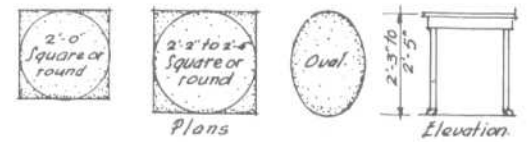
Serving table



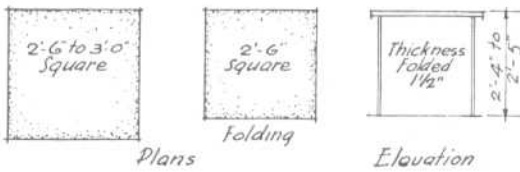
Night table



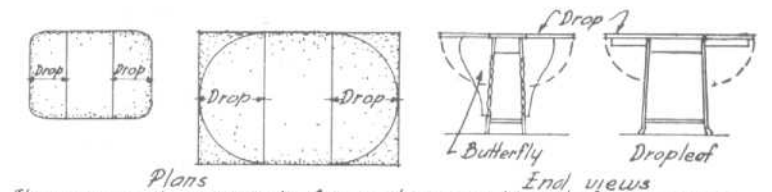
Dressing table



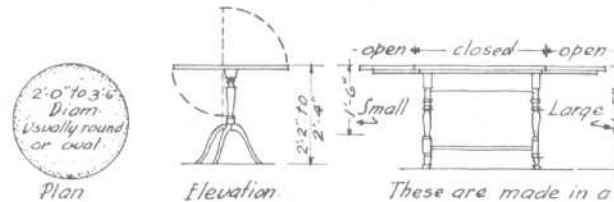
Occasional table



Card tables



Drop leaf and butterfly tables

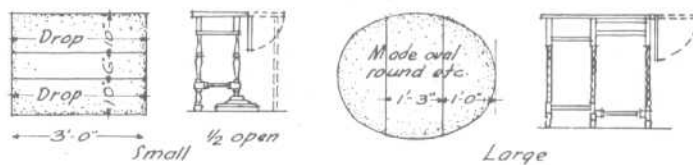


Tilt table

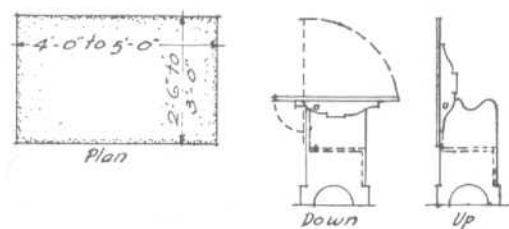


Draw top tables

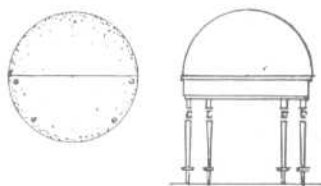
Candle stand



Gate leg tables



Hutch table



Console table



Stands

The size of living rooms and the furniture arrangements contained within such spaces vary dramatically, depending on the size of the dwelling, the economic status and lifestyle of the user, and the relationship of the room to other areas of the dwelling. With regard to the luxury end of the scale, there are few limitations and no attempt has been made to identify the endless planning options possible. There are, however, minimum requirements and basic planning considerations that are applicable whatever the size of the space.

### Minimum Requirements

A living room for a three- or four-bedroom dwelling unit requires more space for its occupants than one for a one- or two-bedroom dwelling unit. Luxury units will necessarily need more space to accommodate more furnishings. In any case, the minimum living room with no dining facilities should be approximately 180 ft<sup>2</sup> but preferably around 200 ft<sup>2</sup>. Figures 1 and 2 show two living rooms with typical furniture groupings (no dining facilities).

Figure 3 shows a living room with one end used for dining. This area often is arranged in an "L" shape to achieve greater definition or privacy from the living activities. Dwelling units with three or more bedrooms should have separate dining rooms or clearly defined dining areas.

The minimum width of a living room should be 11–12 ft. This is extremely tight, however, and if at all possible the width should be at least 14 ft.

### Planning Considerations

Planning considerations should include adequate floor and wall space for furniture groupings, separation of trafficways from centers of activity, and ease of access to furniture and windows.

Circulation within the living room should be as direct as possible and yet not interfere with furniture placement. Ideally, there should be no through traffic. If such traffic is necessary, it should be at one end, with the remaining portion of the room a "dead-end" space.

During social activities, people tend to gather or congregate in relatively small groups. Desirable conversation distance is also relatively small, approximately 10 ft in diameter.

When the living room is combined with the dining area, the dining area should be offset into an alcove or be clearly identified as an entity in itself.

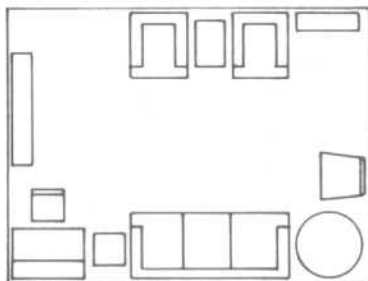


Fig. 1 Typical furniture arrangement for a one- or two-bedroom apartment (12.5 ft x 16 ft, 200 ft<sup>2</sup>).

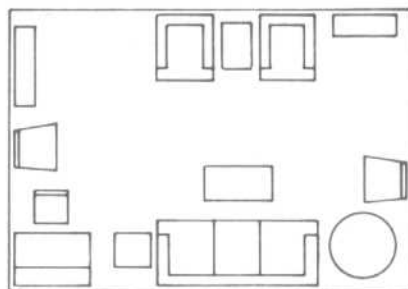


Fig. 2 Typical furniture arrangement for a three-bedroom apartment (12.5 ft x 20 ft, 250 ft<sup>2</sup>).

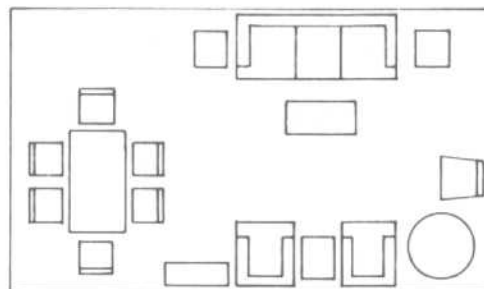
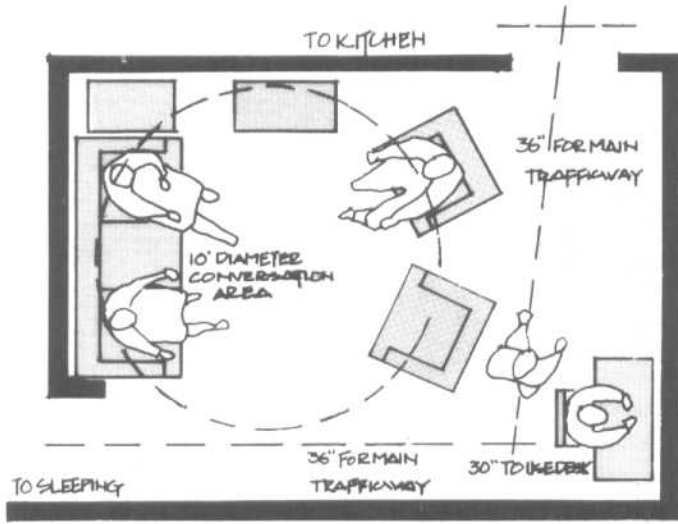


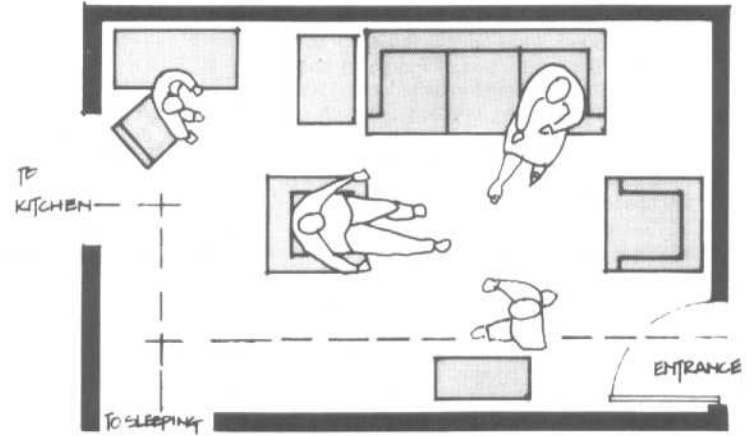
Fig. 3 Another typical furniture arrangement for a three-bedroom apartment (12.5 ft x 22 ft, 275 ft<sup>2</sup>).

LIVING ROOMS

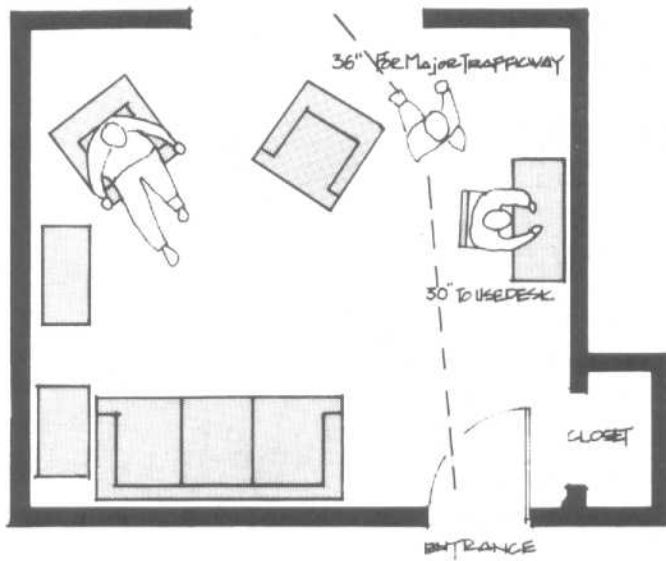
Circulation



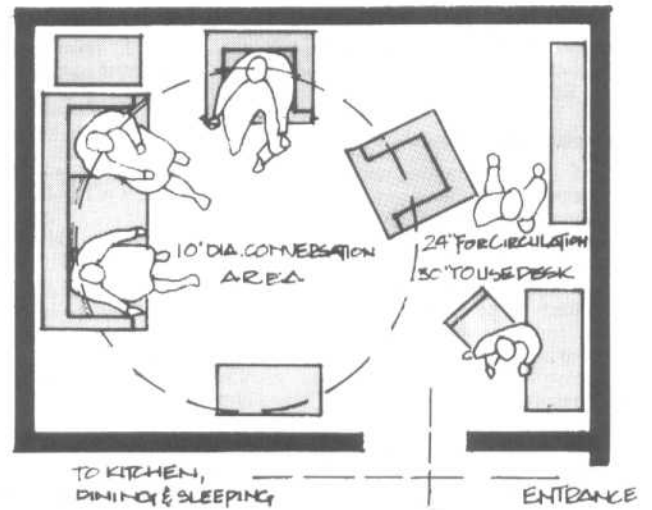
(a)



(b)



(c)



(d)

Fig. 4 When through traffic is unavoidable, pathways should skirt conversational or activity centers, as illustrated in (a), (b), and (c). (d) illustrates a more ideal layout in which the entire room is bypassed.



LIVING ROOMS

Furniture Clearances

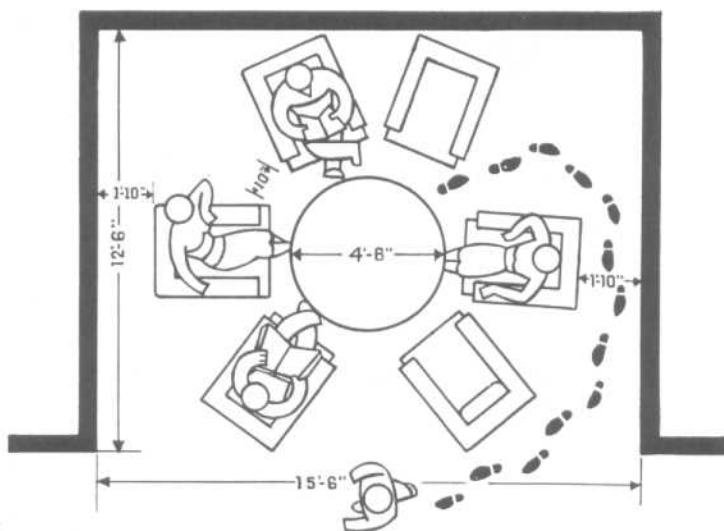


Fig. 5

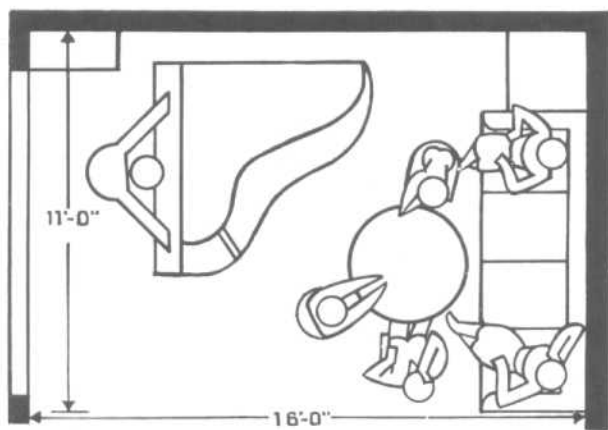


Fig. 6

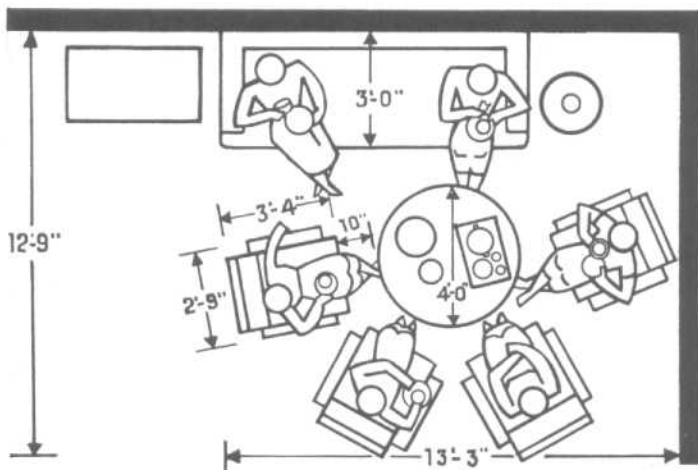


Fig. 7

Figures 5 to 10 show various groupings and related clearances. Figure 5 shows that a space 12'6" x 15'6" should be provided in order to accommodate seating for five around a 56-in-diameter cocktail table. The piano, sofa, and cocktail table arrangement shown in Fig. 6 requires a space at least 11'0" x 16'0". Figure 7 suggests that a space at least 12'9" x 13'3" is required to accommodate a grouping to seat 6 or 7 persons, while Fig. 8 indicates that a corner arrangement for two requires a space at least 6'3" x 6'6".

When planning furniture arrangements, allowances for clearances should take into account the human dimension as well, as illustrated in Figs. 9 and 10.

It should be noted that these diagrams are not intended as models for complete living room layouts. They are intended only as guidelines to illustrate minimum clearances for preliminary planning purposes.

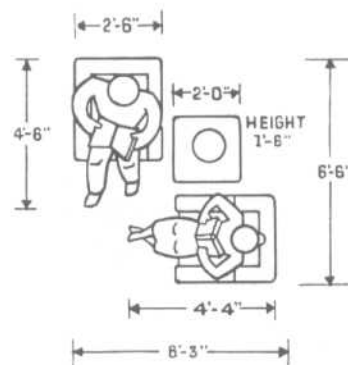


Fig. 8

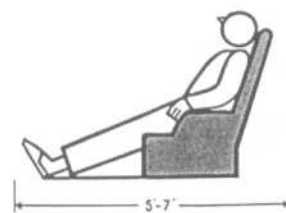


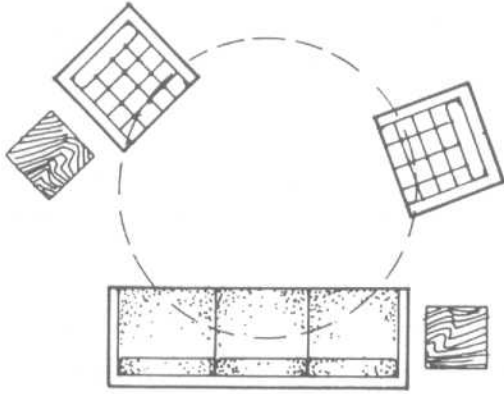
Fig. 9



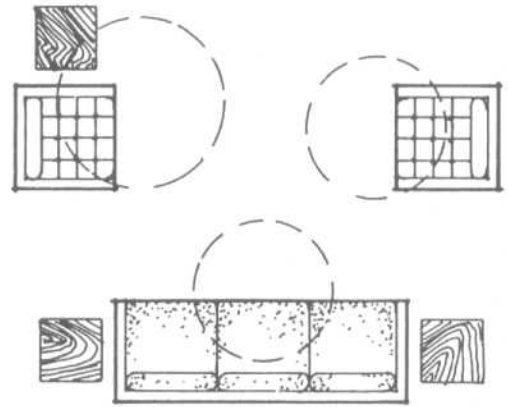
Fig. 10

LIVING ROOMS

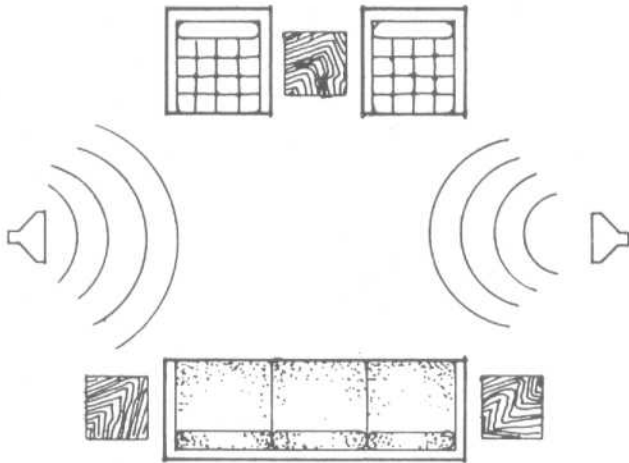
Living Room Activities



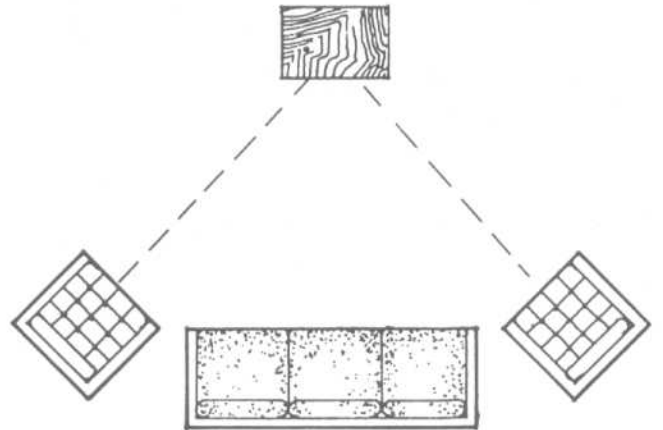
CONVERSATION



UNRELATED ACTIVITIES



LISTENING TO MUSIC



WATCHING TELEVISION

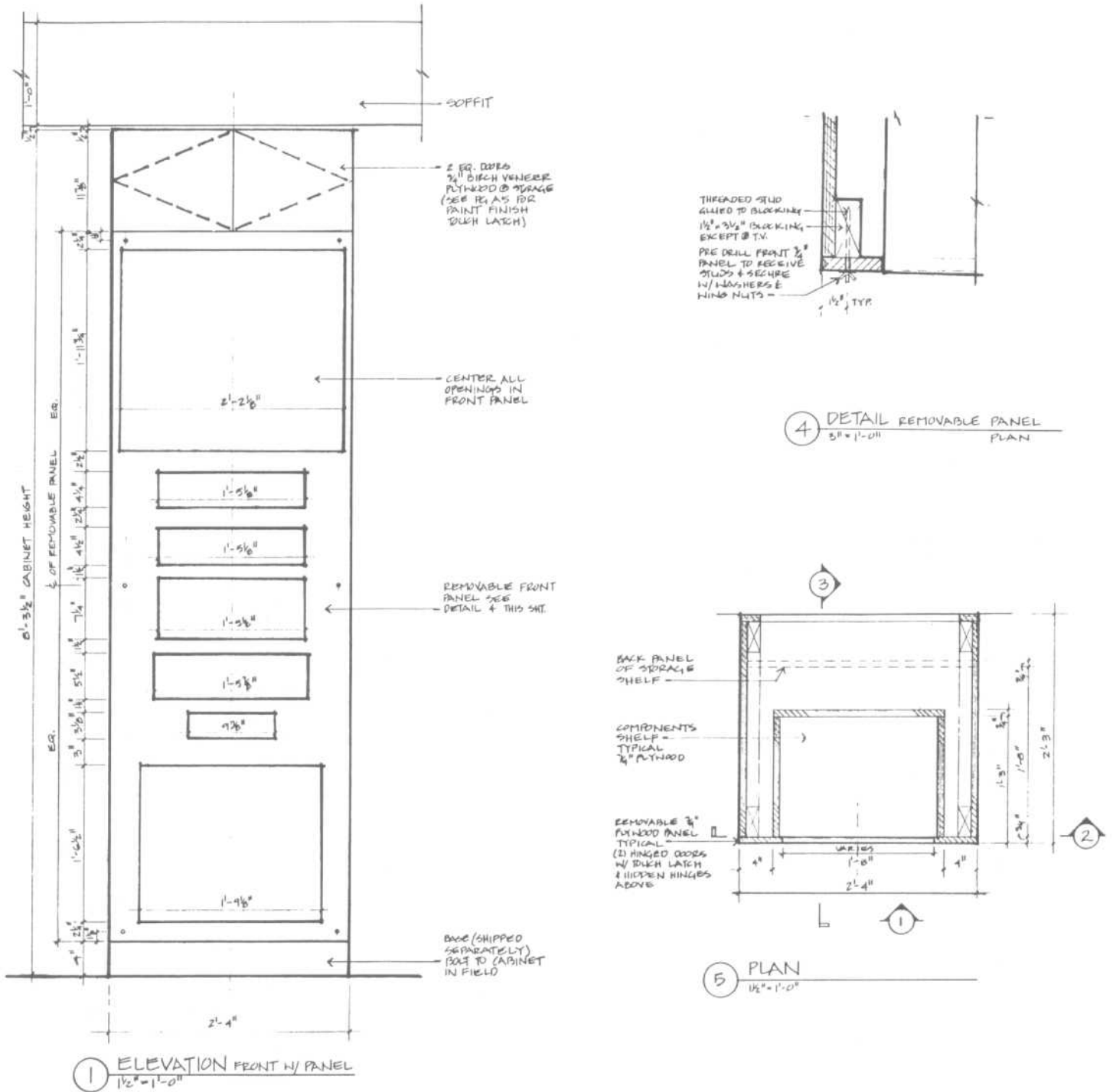


Fig. 11 Working drawings of a media cabinet, including plans, elevations, and sections of the installation. The design of the cabinet should take into account the actual electronic and other equipment to be housed and the clearances involved for operation. Power outlets should be coordinated and located so as to conceal unsightly wires and cables.

LIVING ROOMS

Media Cabinet Details

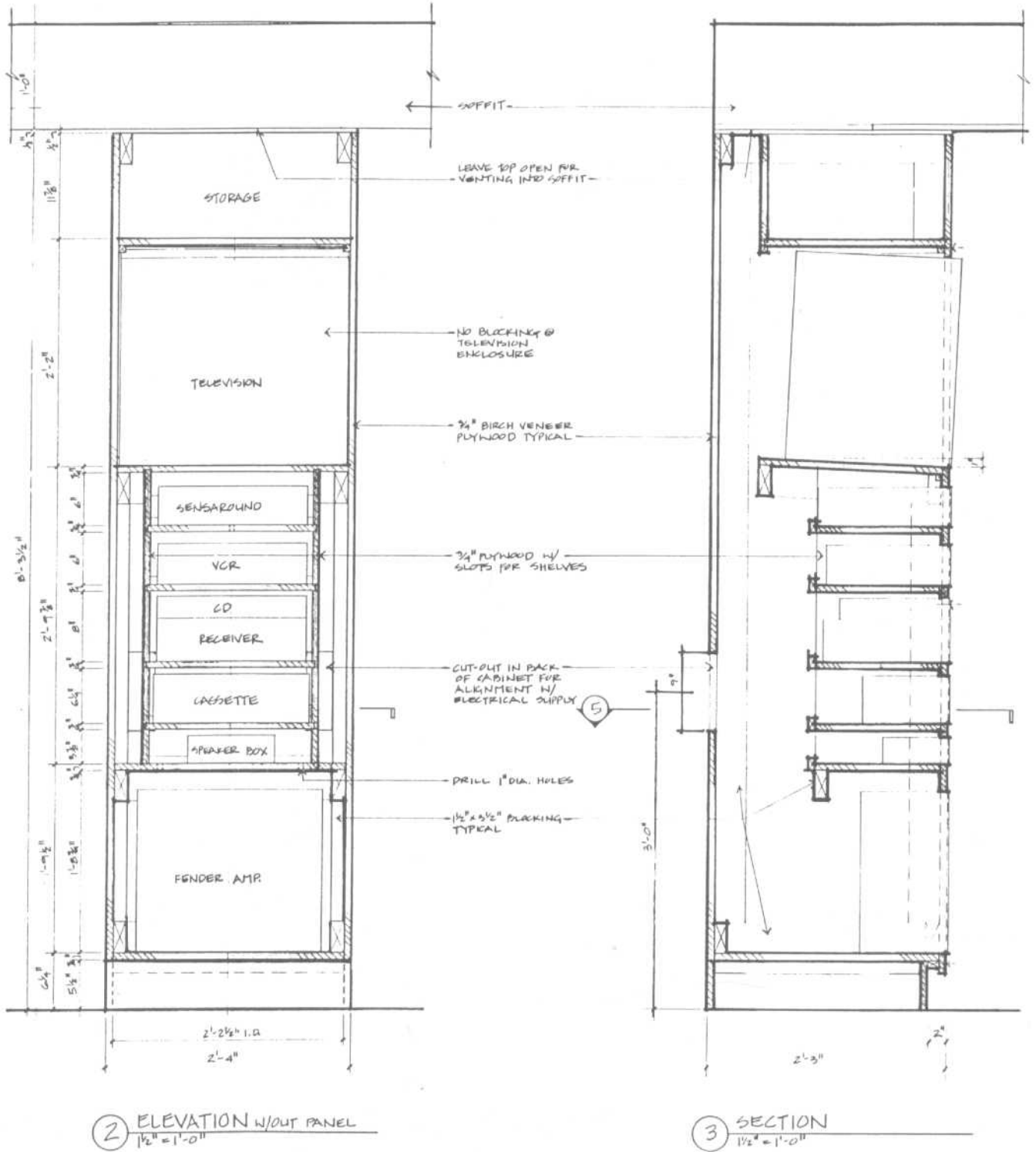
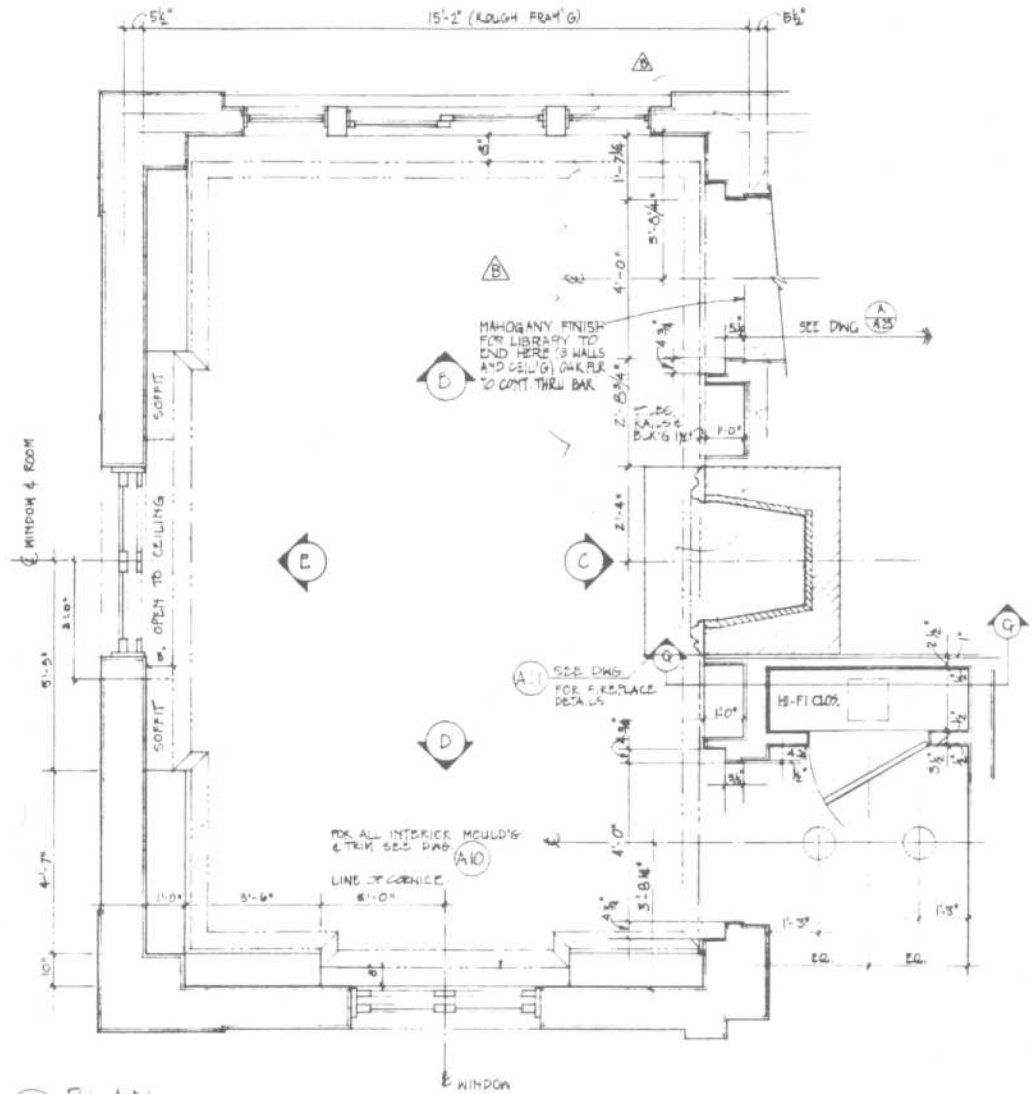
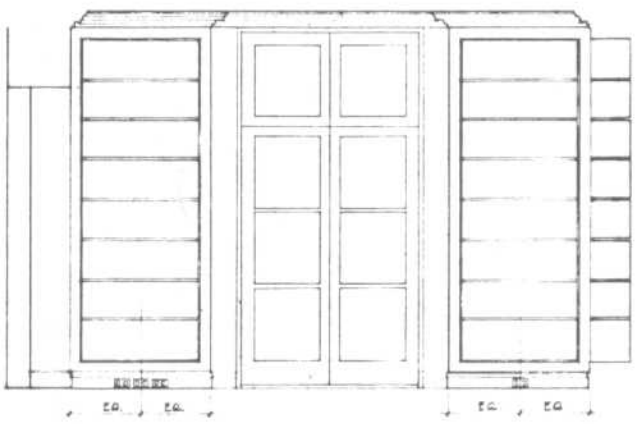


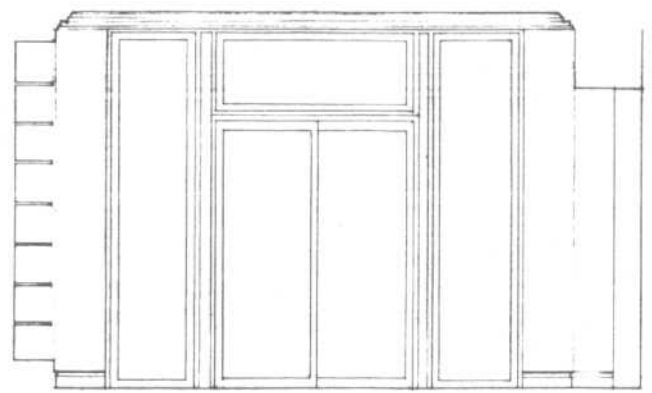
Fig. 11 (Continued)



A PLAN  
A-21 SCALE: 1/2" = 1'-0"



D NORTH ELEVATION  
A-21 SCALE: 1/2" = 1'-0"



D SOUTH ELEVATION  
A-21 SCALE: 1/2" = 1'-0"

Fig. 12 Working drawings of a library/living room, including a plan of the space, wall elevations, and some of the many details involved.

LIVING ROOMS

Plans, Elevations, and Details

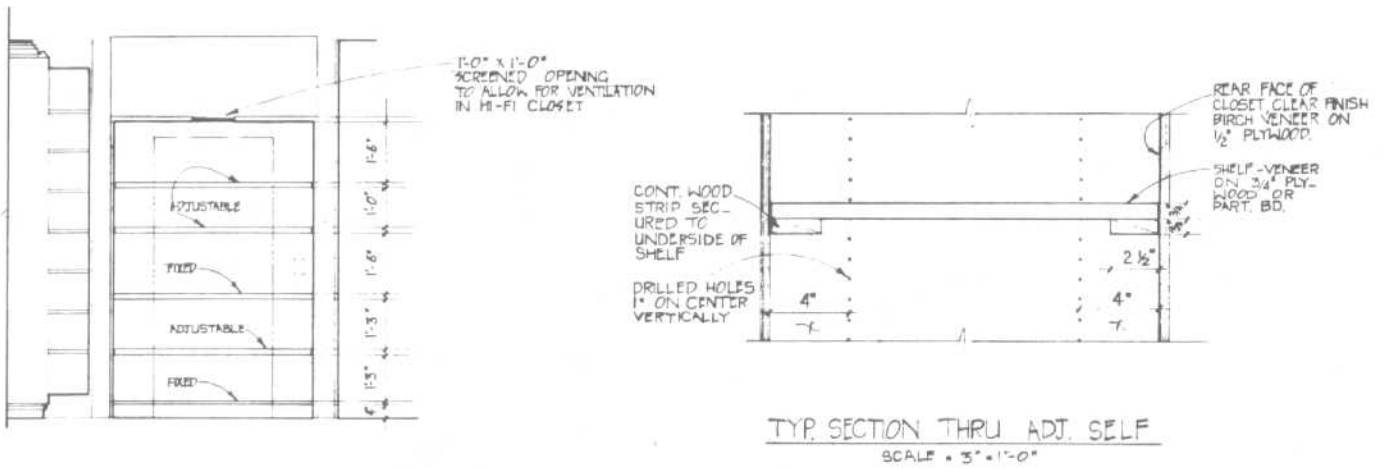
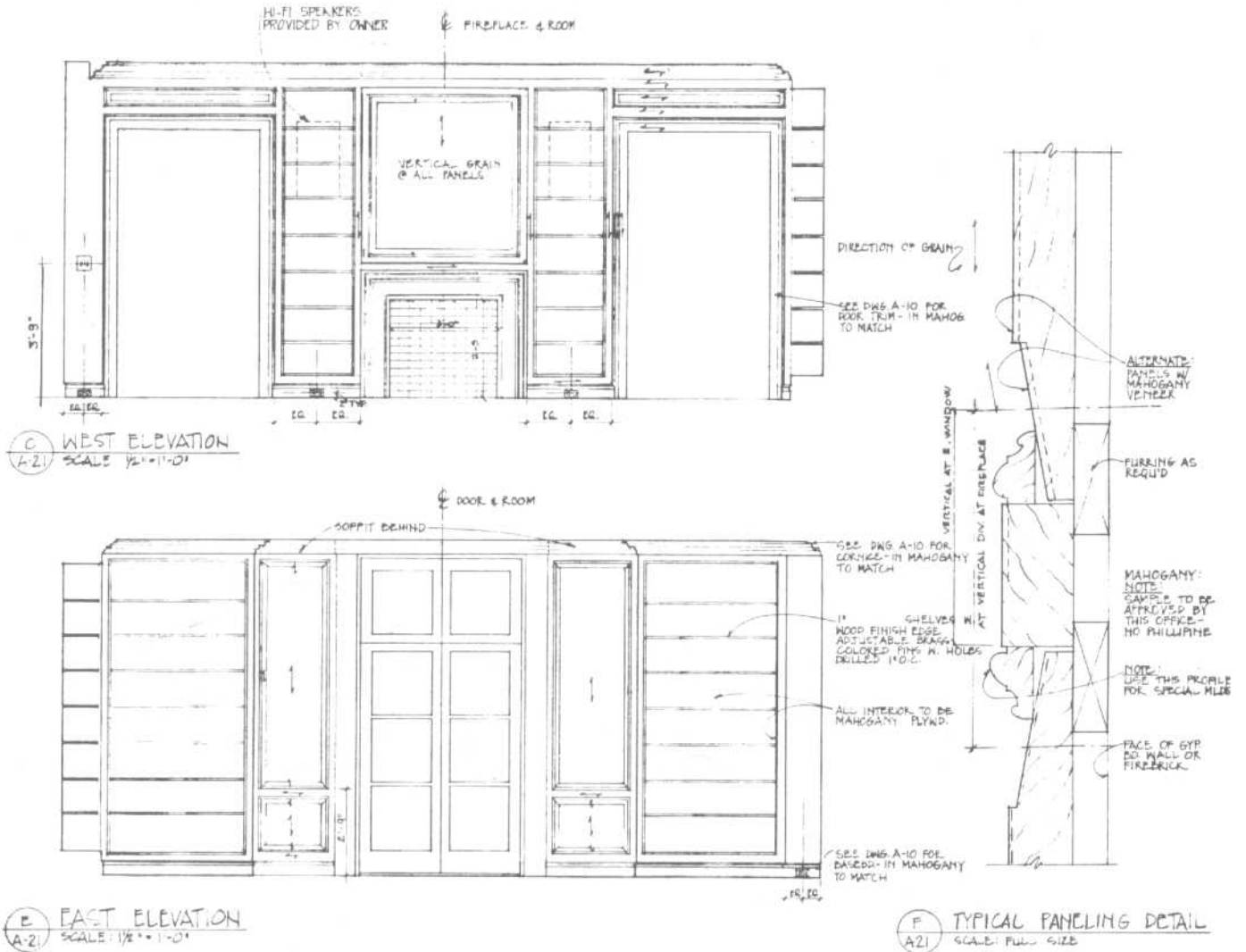
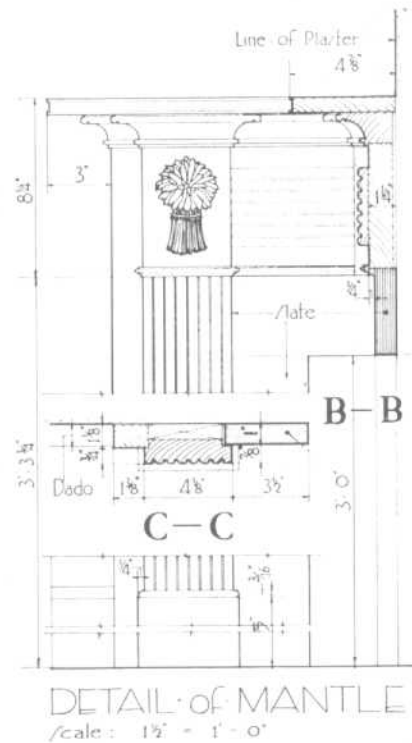
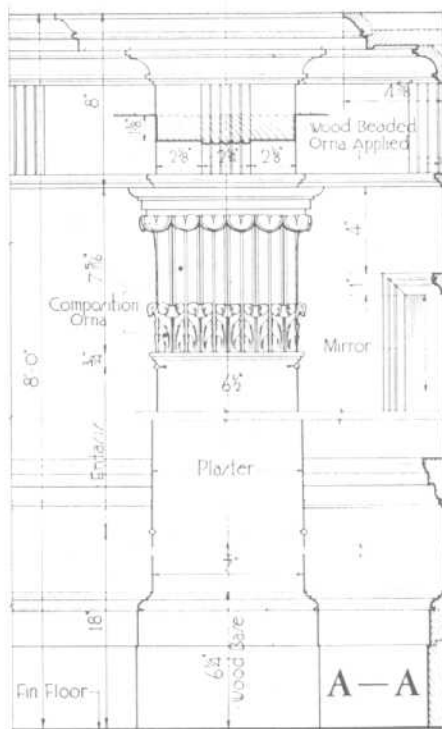
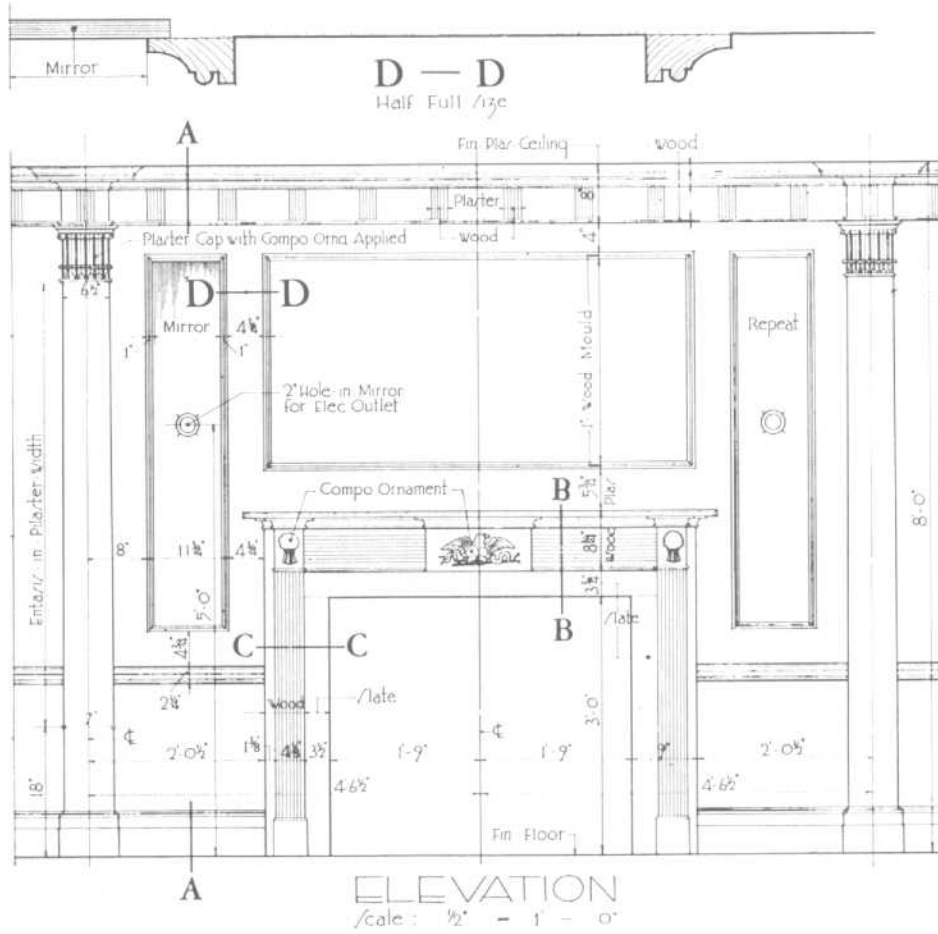


Fig. 12 (Continued)





1 1/2" /cale: DETAIL OF PILLAR & CORNICE

LIVING ROOMS

Fireplace Wall Sections and Details

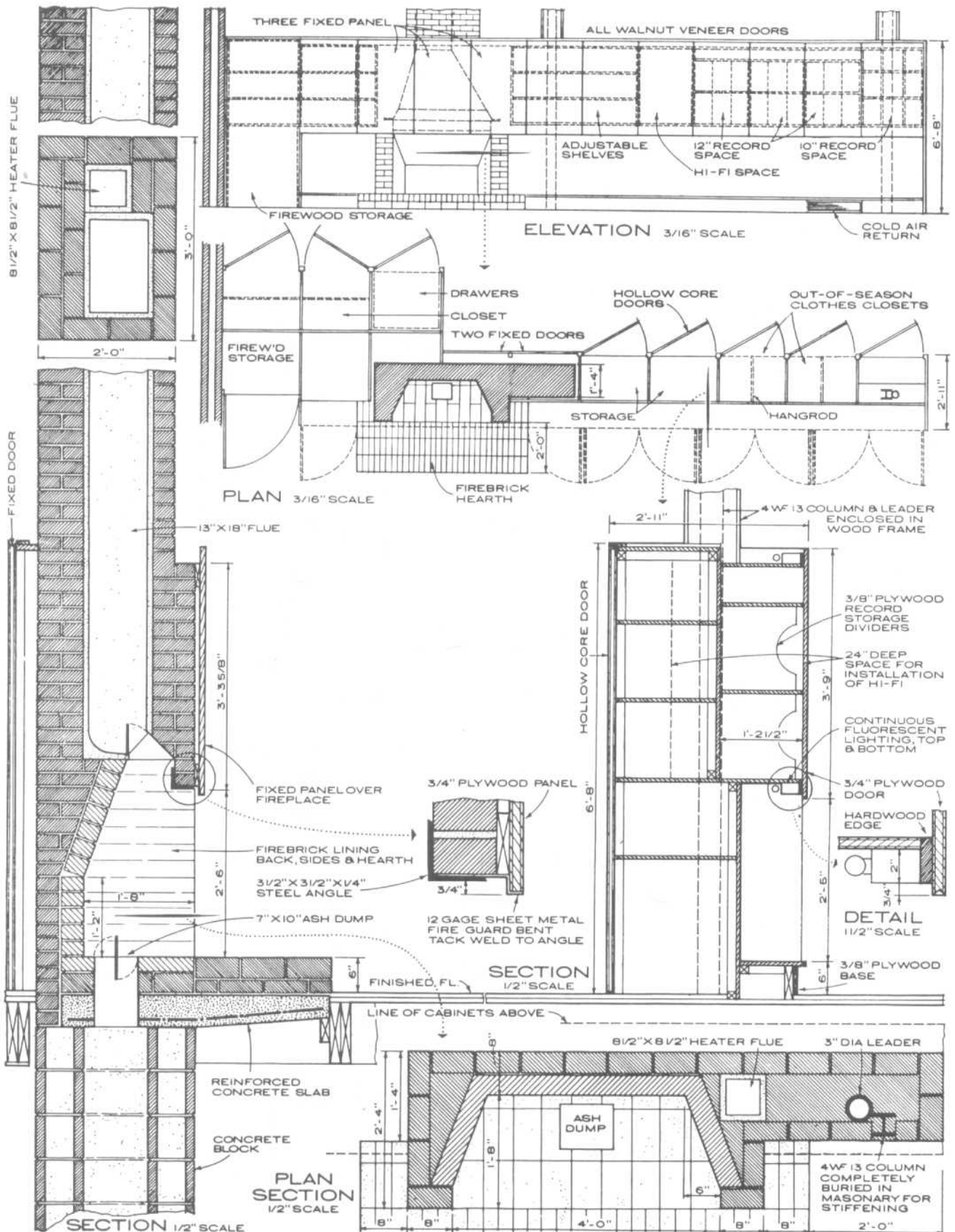


Figure 13 shows a plan and elevations of modifications to an existing fireplace. Based on these drawings and inspection and measurement of existing conditions, the contractor prepares and submits shop drawings for the designer's approval. Since at least two trades are involved, coordination of the trades by the contractor and a thorough

review of the shop drawings by both contractor and designer are essential. It is important, also, that modifications conform with all applicable codes. The extent of hearth extension, the materials used, and the distance of combustible materials from the fire box are among the numerous items governed by codes.

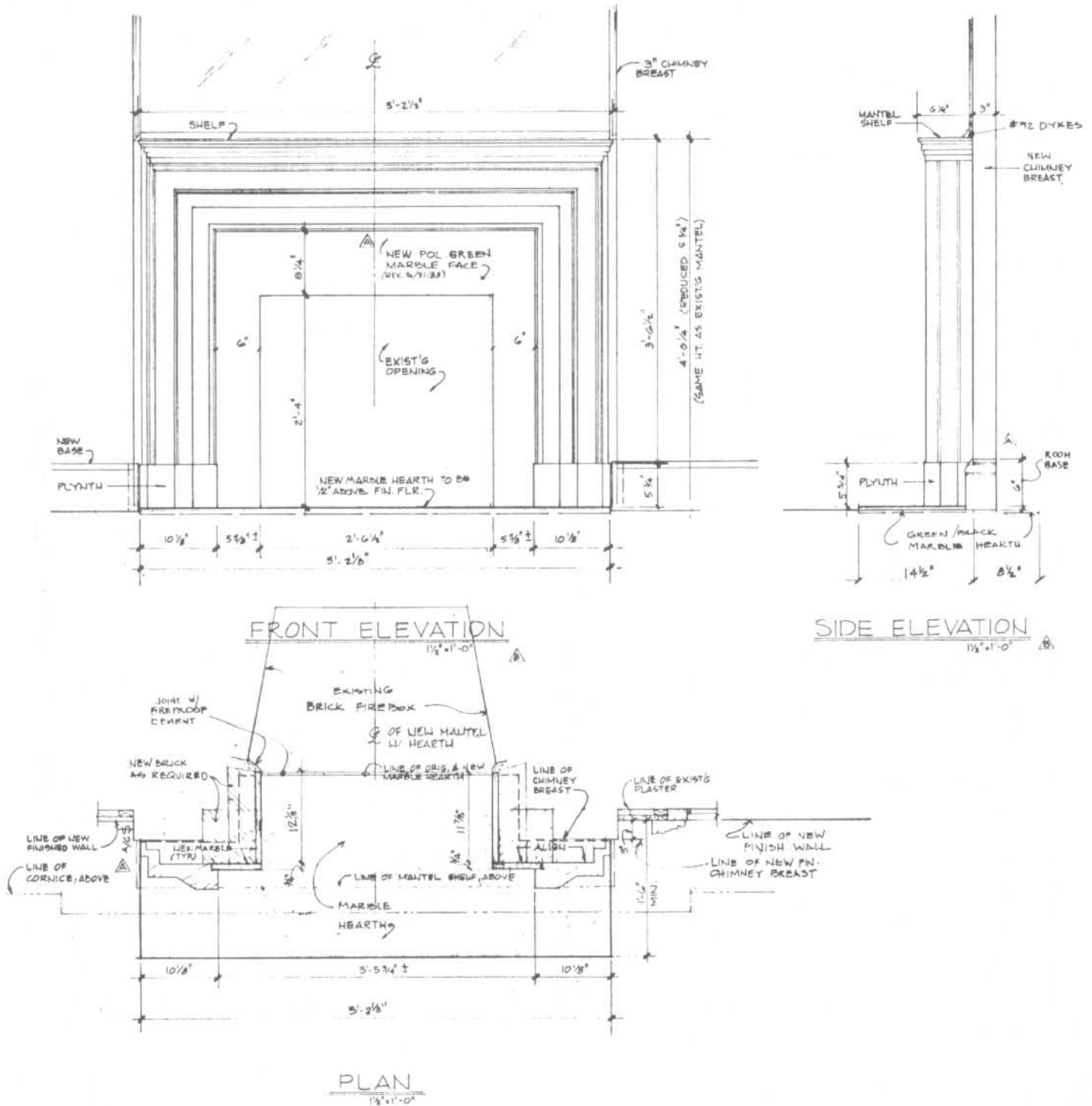
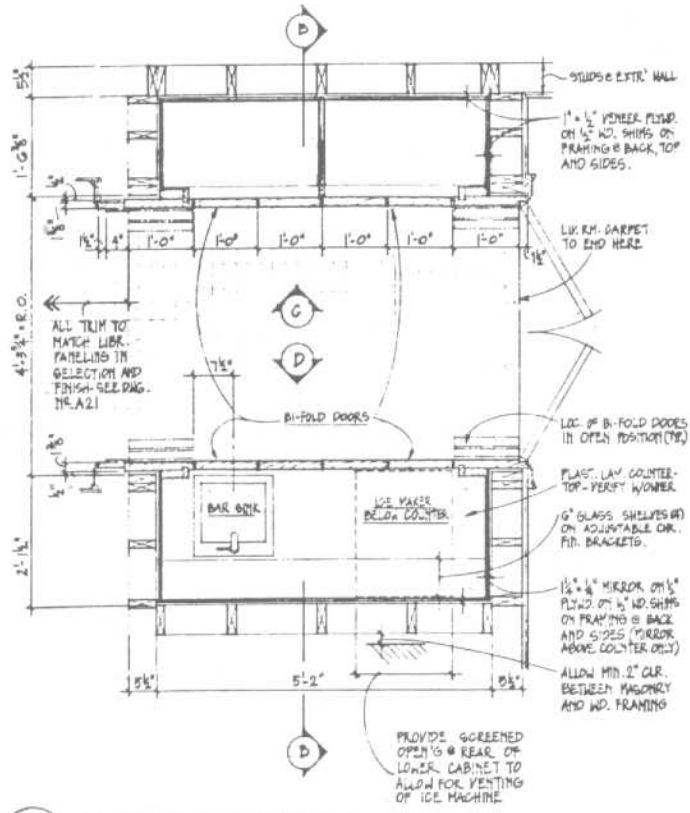


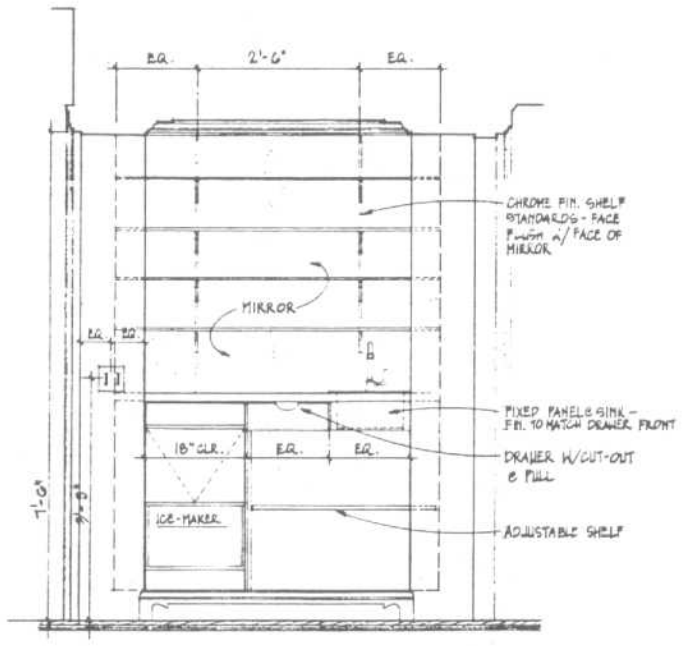
Fig. 13

LIVING ROOMS

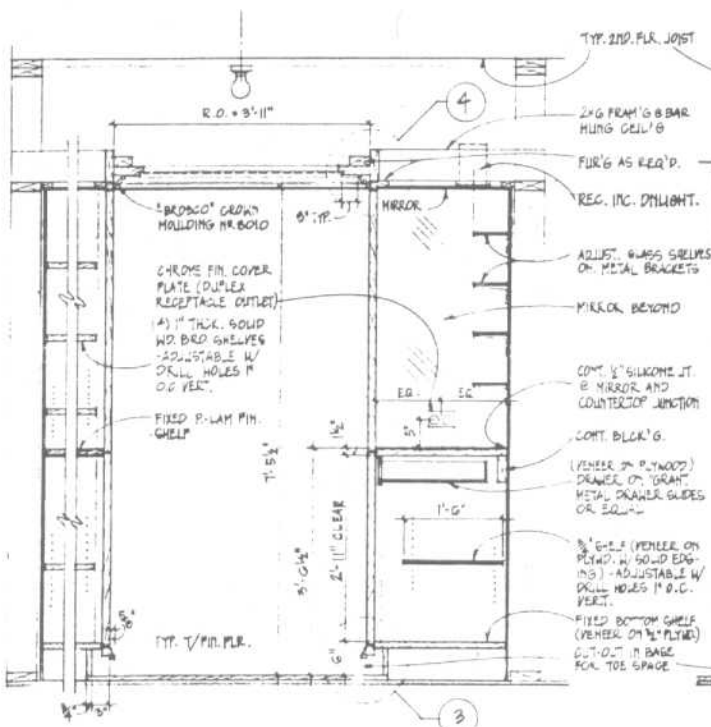
Bar Details



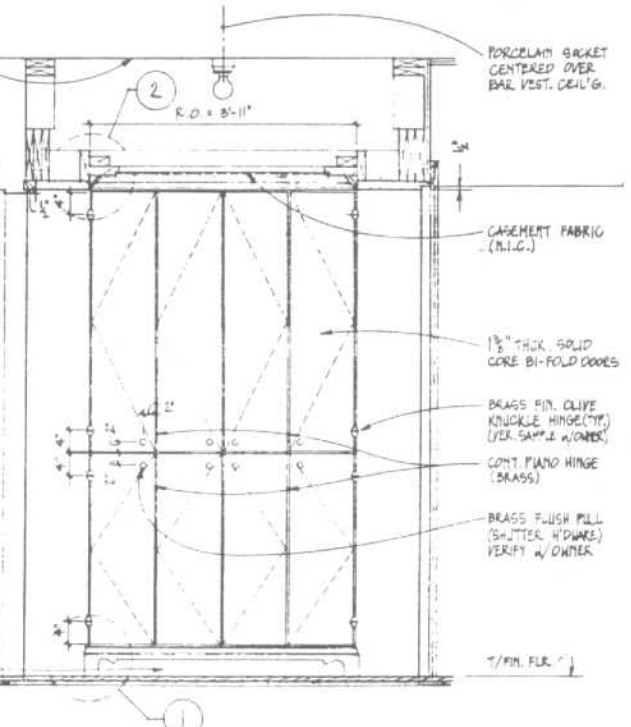
**A** PLAN OF BAR VESTIBULE  
A-25 SCALE: 3/4" = 1'-0"



**D** SECTION LKG. NORTH (SHOWN W/OUT DOORS)  
A-25 3/4" = 1'-0"



**B** SECTION LOOKING TOWARDS LIVRM.  
A-25 3/4" = 1'-0"



**C** SECTION LOOKING SOUTH  
A-25 3/4" = 1'-0"

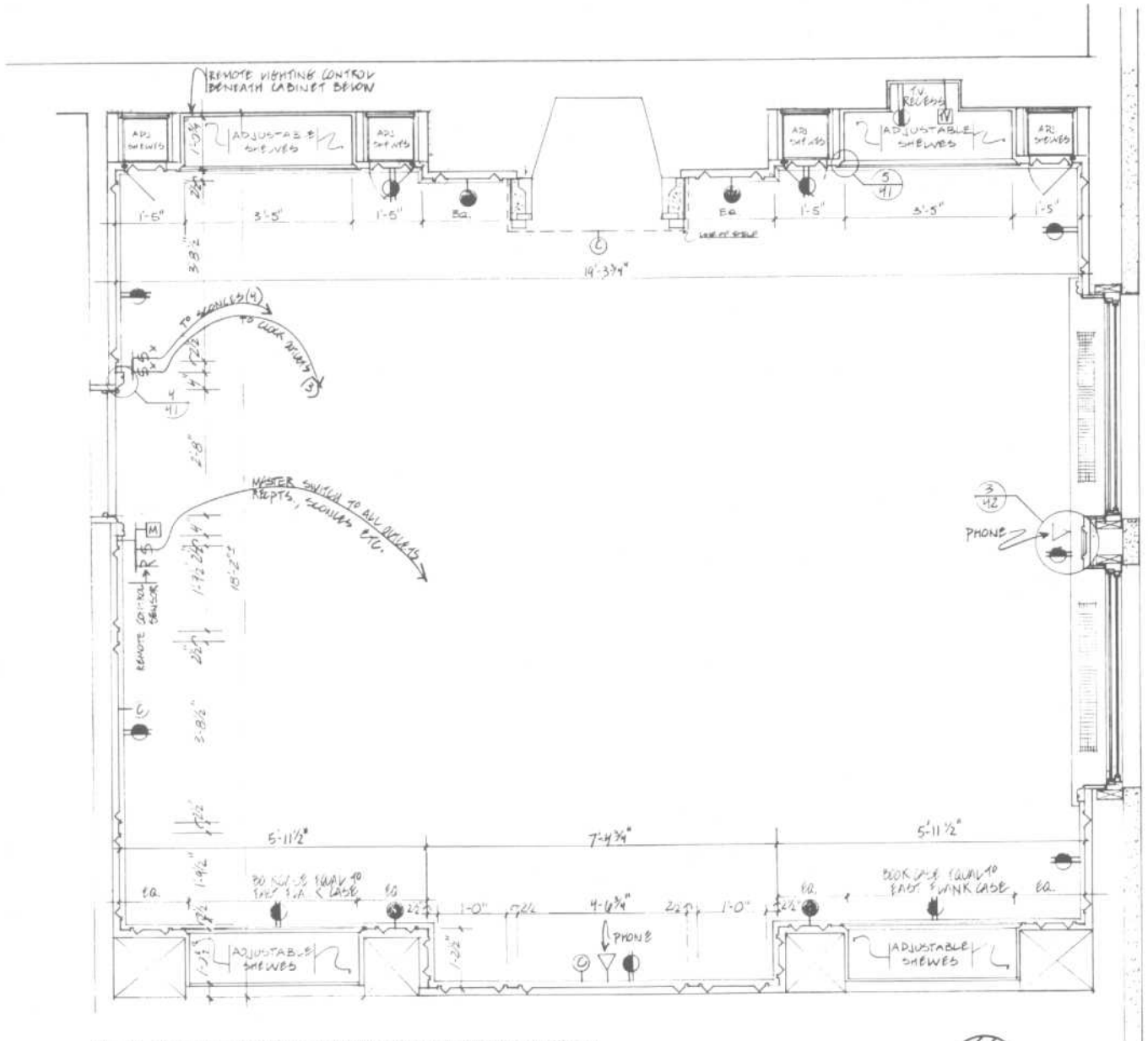
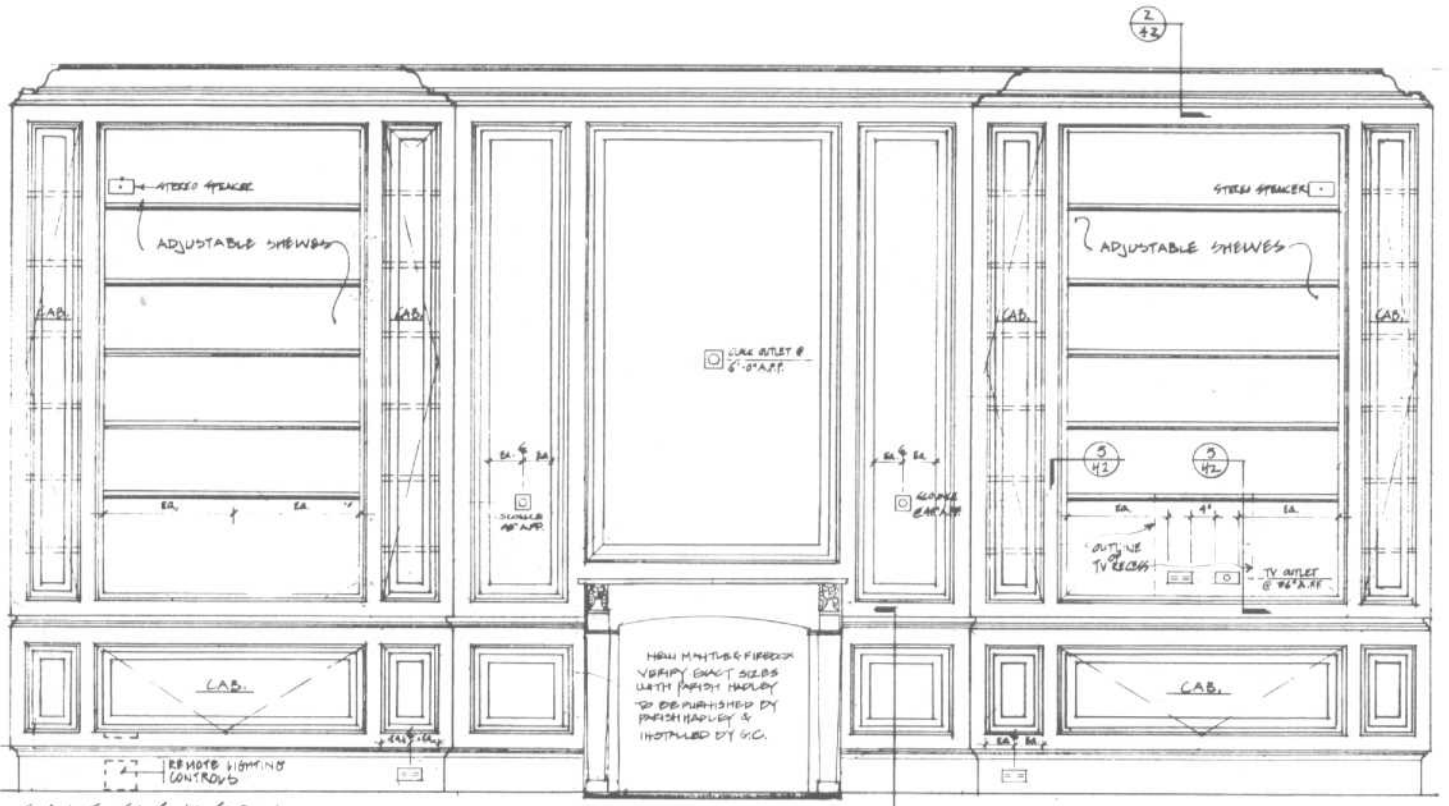


Fig. 14 Floor plan, elevations, and details of paneled living room/library.



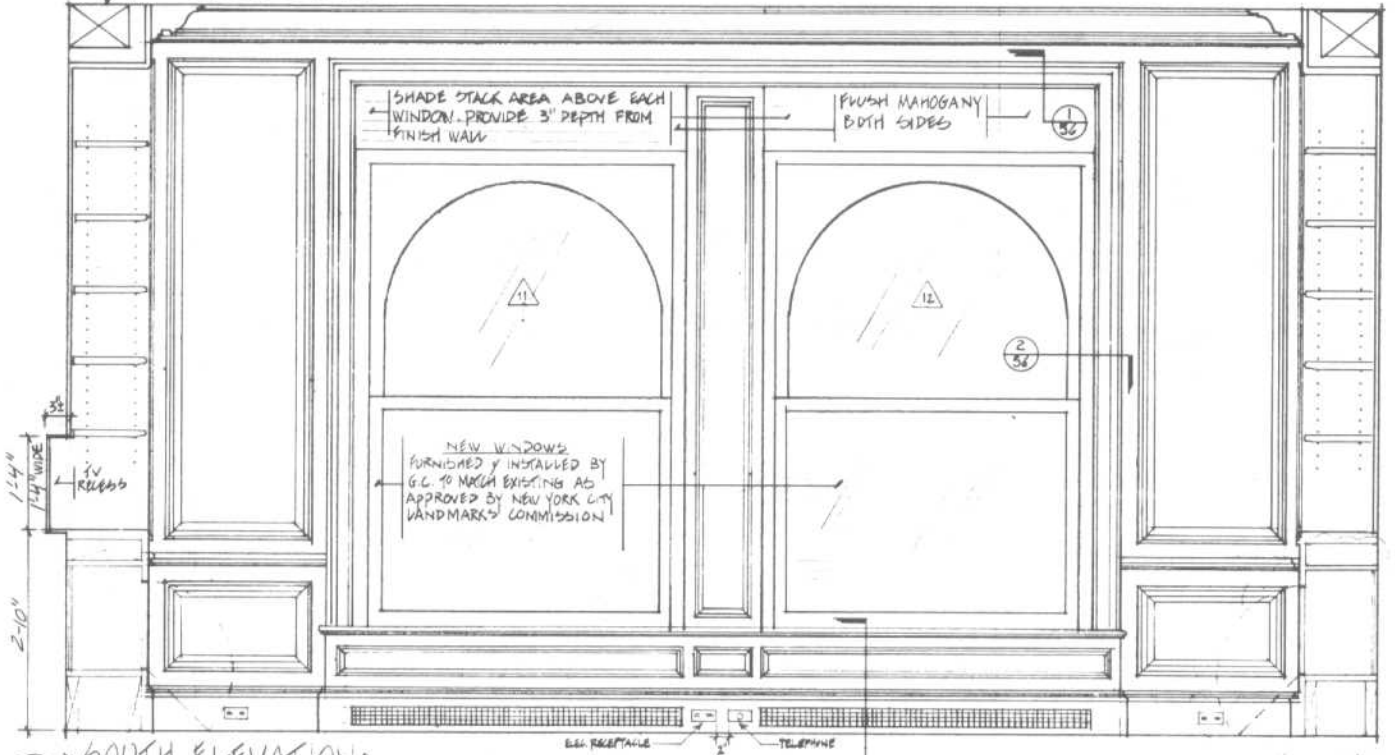
LIVING ROOMS



EAST ELEVATION

NOTE:  
 PROVIDE PUSH ACCESS PANEL INSIDE CABINET  
 TO REMOTE LIGHTING CONTROLS

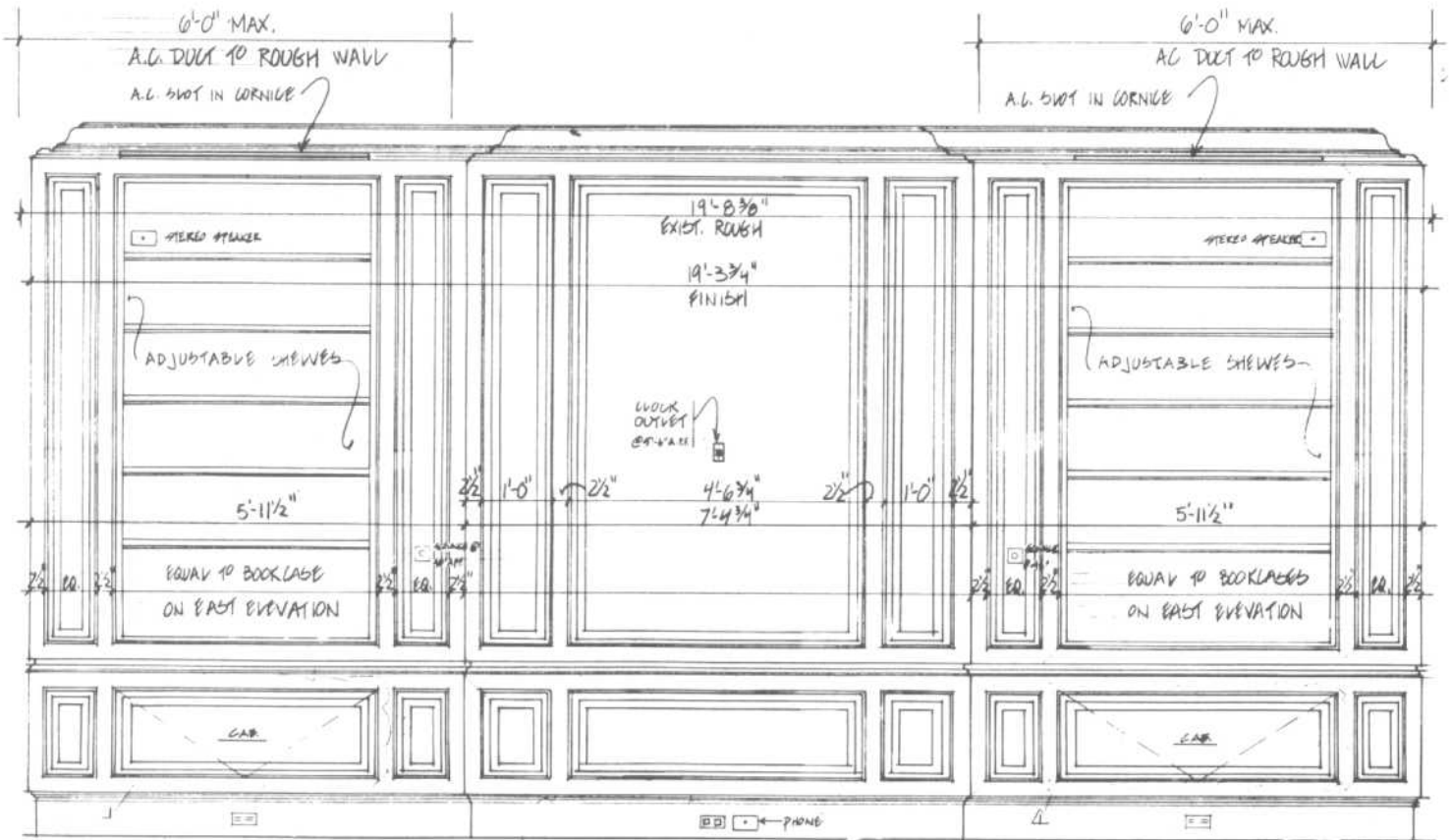
10" x 7" AIR CONDITIONING DUCT  
 BY GENERAL CONTRACTOR



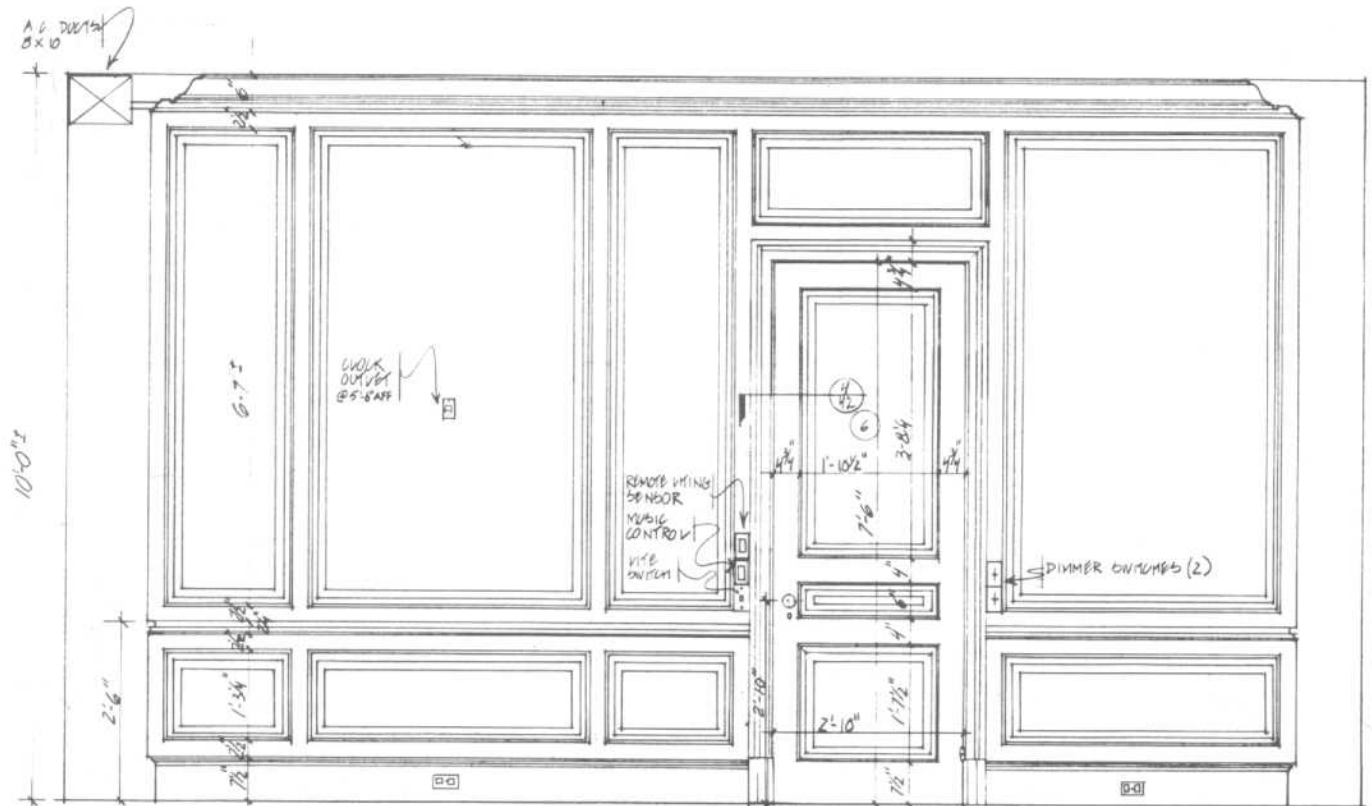
SOUTH ELEVATION

Fig. 14 (Continued)





WEST ELEVATION

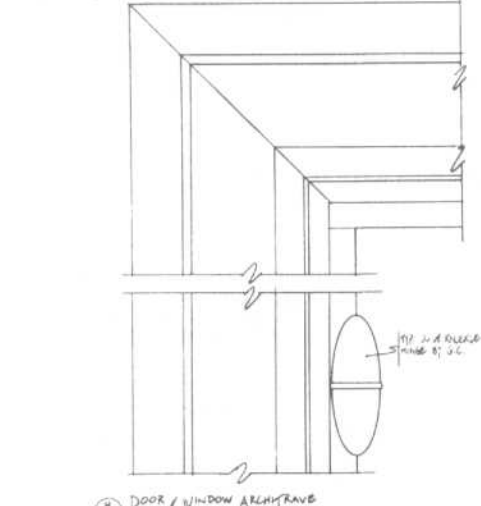
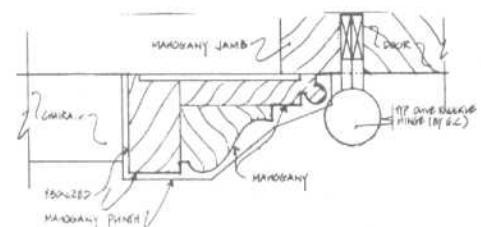
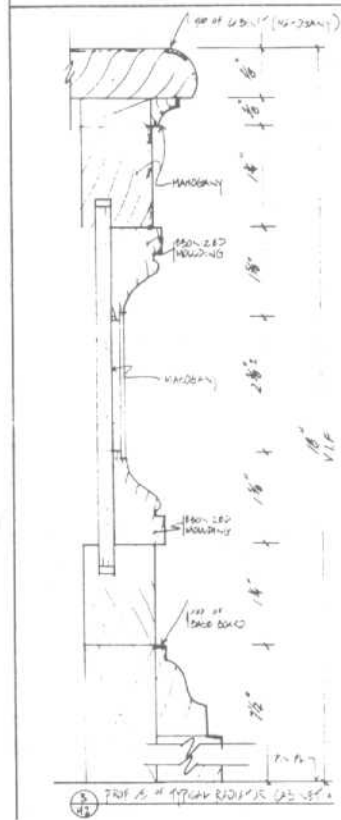
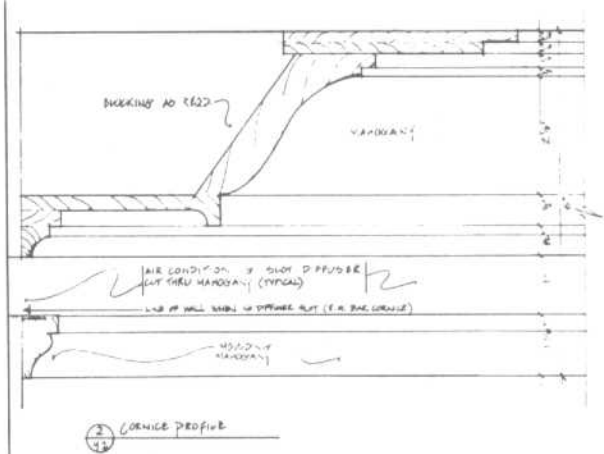
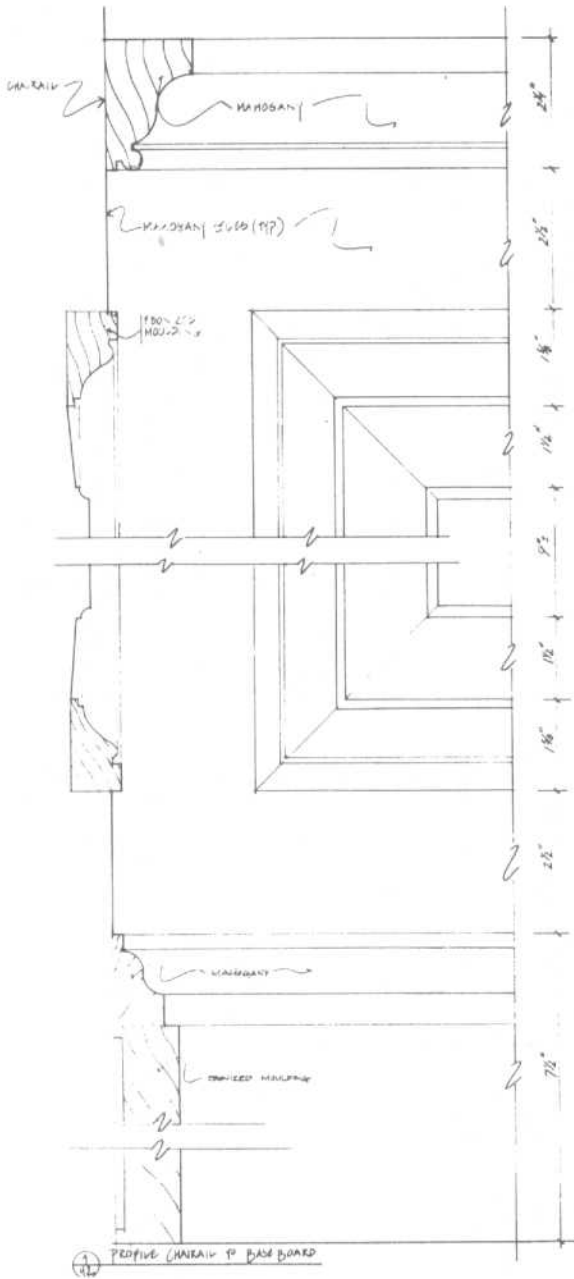


NORTH ELEVATION

- NOTE:
- DOOR PANEL PROFILES TO MATCH WALL PANELS
  - DOOR & JAMB TO BE FURNISHED & INSTALLED BY GENERAL CONTRACTOR

Fig. 14 (Continued)

LIVING ROOMS



- NOTE:
- RADIATOR CABINET PLANE IN DOWN GRADE IN
- BASE & TO BE SET TO BE SUPPORTED BY
- GENERAL CONTRACTOR & NOTED BY
- CONTRACTOR OF OTHER JOBS.
- GRANITE TO BE REFINISHED & OF 1/2" THICK.
- USE OF POLY TO BE REFINISHED FROM
- TABLE / REMOVE / OF RADIATOR
- AND PANELS TO BE SET FOR SET OF
- FINISHED WALL BETWEEN & TO BE ADJ. TO
- TO BE SET IN / TO BE ADJ. TO ALL ADJ. TO
- TO BE SET IN / TO BE ADJ. TO ALL ADJ. TO
- TO BE SET IN / TO BE ADJ. TO ALL ADJ. TO

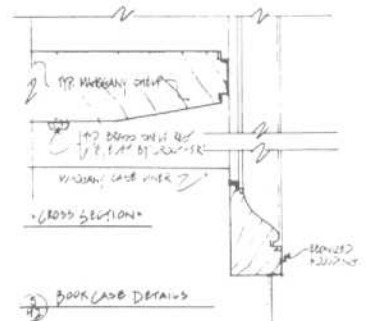
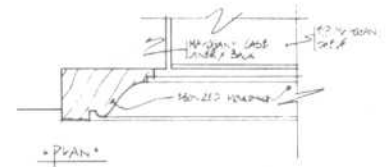


Fig. 14 (Continued)



Traditional: roll arms, loose-cushion back, kidney shape, solid base



Traditional: roll arms, one-piece back, solid base



Traditional: roll arms



Traditional: roll arms, fixed-cushion back, tailored skirt



Traditional: roll arms, loose-pillow back, shirred base



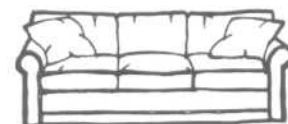
Contemporary: shaped sofa, shaped base



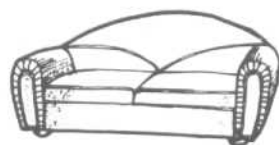
Contemporary: curved arms, fixed-cushion back, solid base



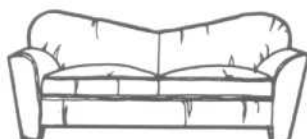
Contemporary: curved arms, fixed-cushion back, solid base



Traditional: roll arms, fixed-cushion back, solid base



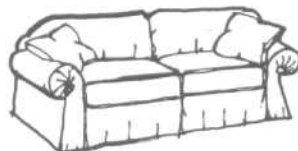
Contemporary: dome arms, solid back, solid base



Contemporary: shaped sofa, shaped front view



Contemporary: square arms, loose-cushion back, solid base



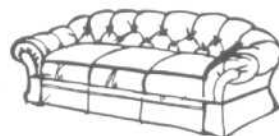
Traditional: roll arms, fixed-cushion back, tailored skirt



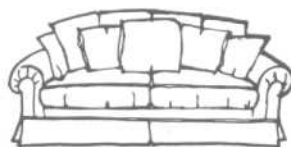
Traditional: roll arms



Contemporary: miscellaneous slanted arms



Traditional: roll arms, tufted



Traditional: roll arms, loose-pillow back, tailored skirt



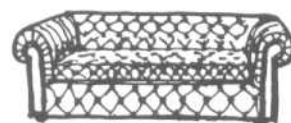
Traditional: roll arms, fixed-cushion back, shirred skirt



Traditional: roll arms, one-piece back, skirted base



Traditional: roll arms



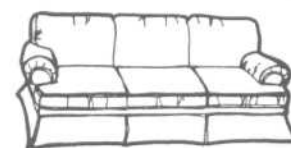
Traditional: roll arms, tufted



Contemporary: slanted cushion arms, fixed-cushion back, solid base



Traditional: roll arms, loose-cushion back, kidney shape, pleated skirt, ruffled skirt



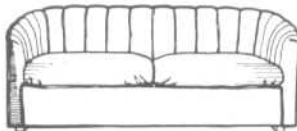
Traditional: roll arms, fixed-cushion back, tailored skirt

LIVING ROOMS

Planning Data: Sofas



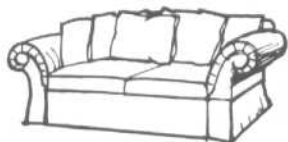
Contemporary: straight arms, one-piece back, open base



Contemporary: curved arms, fixed-cushion back, solid base



Contemporary: dome arms, loose-cushion back, solid base



Traditional: roll arms, loose-pillow back, full skirt



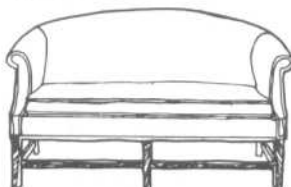
Contemporary: square arms, loose-cushion back, solid base



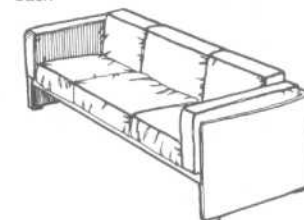
Traditional: roll arms, fixed-cushion back



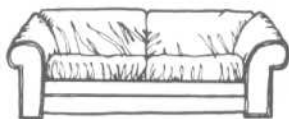
Contemporary: shaped sofa, shaped plan



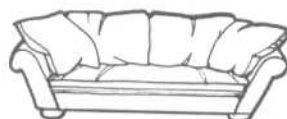
Contemporary: straight arms, one-piece back, open base



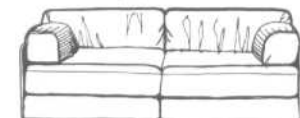
Contemporary: square arms, fixed-cushion back, open base



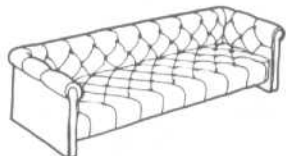
Contemporary: roll arms, fixed-cushion back, solid base



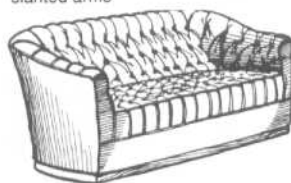
Contemporary: miscellaneous slanted arms



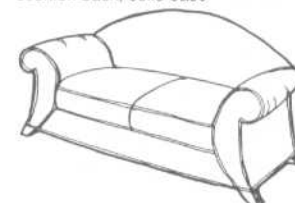
Contemporary: curved arms, fixed-cushion back, solid base



Traditional: roll arms, tufted



Contemporary: dome arms, one-piece tufted back, solid base



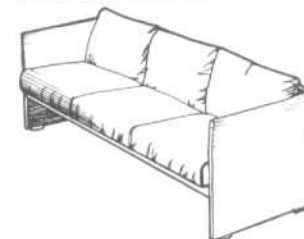
Contemporary: roll arms, fixed-cushion back, solid base



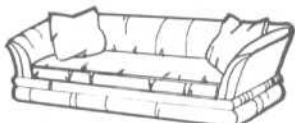
Contemporary: miscellaneous slanted arms



Contemporary: roll arms, loose-cushion back, solid base



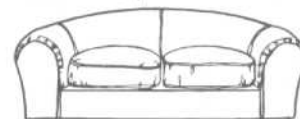
Contemporary: square arms, fixed-cushion back, open base



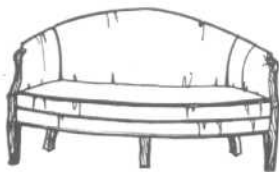
Contemporary: shaped sofa, partitioned back



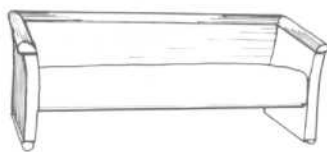
Contemporary: square arms, fixed-cushion back, open base



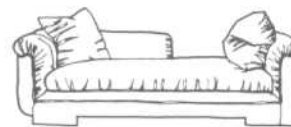
Contemporary: dome arms, solid back, solid base



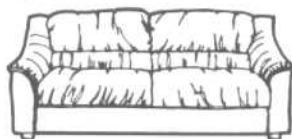
Contemporary: wood frame arms and legs, one-piece curved back, open base



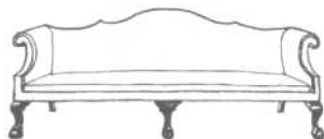
Contemporary: square arms, fixed-cushion back, wood trim, open base



Contemporary: sofa/daybed



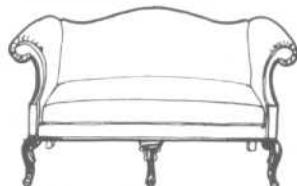
Contemporary: curved arms, fixed-cushion back, solid base



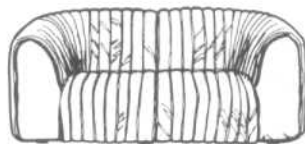
Traditional: roll arms, one-piece back, open base



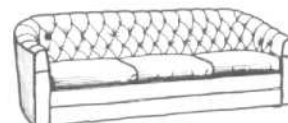
Contemporary: slanted cushion arms, fixed-cushion back, solid base



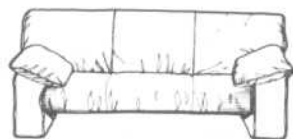
Traditional: roll arms, one-piece back, open base



Contemporary: dome arms, channel quilted back, seat, and arms, solid base



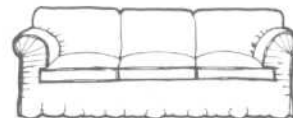
Contemporary: dome arms, one-piece tufted back and seat, solid base



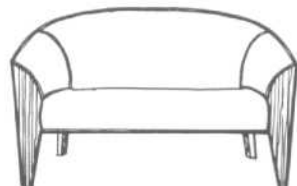
Contemporary: slanted cushion arms, fixed-cushion back, open base



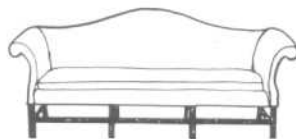
Contemporary: curved arms, fixed-cushion back, solid base



Contemporary: roll arms, fixed-cushion back, soft skirt



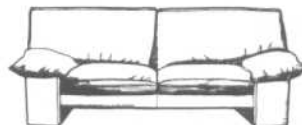
Contemporary: one-piece curved back and arms, wood legs, open base



Traditional: roll arms, one-piece back, open base



Contemporary: shaped sofa, partitioned back



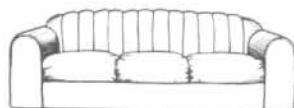
Contemporary: slanted cushion arms, fixed-cushion back, open base



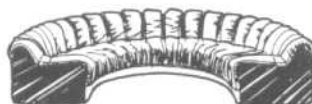
Contemporary: curved arms, fixed-cushion back, solid base



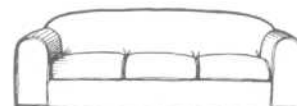
Contemporary: curved arms, fixed-cushion back, solid base



Contemporary: dome arms, solid back



Contemporary: modular



Contemporary: dome arms, solid back

**DINING ROOMS**

Furniture Clearances

**SPATIAL CHARACTERISTICS AND ARRANGEMENT**

**Requirement**

Each living unit should contain space for the purpose of dining. This area may be combined with the living room or kitchen, or may be a separate room.

**Criterion**

The amount of space allocated to dining should be based on the number of persons to be served and the proper circulation space. Appropriate space should be provided for the storage of china and large dining articles either in the dining area itself or in the adjacent kitchen.

Space for accommodating the following sizes of tables and chairs in the dining area should be provided, according to the intended occupancy, as shown:

- 1 or 2 persons: 2 ft 6 in by 2 ft 6 in
  - 4 persons: 2 ft 6 in by 3 ft 2 in
  - 6 persons: 3 ft 4 in by 4 ft 0 in or 4 ft 0 in round
  - 8 persons: 3 ft 4 in by 6 ft 0 in or 4 ft 0 in by 4 ft 0 in
  - 10 persons: 3 ft 4 in by 8 ft 0 in or 4 ft 0 in by 6 ft 0 in
  - 12 persons: 4 ft 0 in by 8 ft 0 in
  - Dining chairs: 1 ft 6 in by 1 ft 6 in
  - Buffet or storage unit: 1 ft 6 in by 3 ft 6 in
- Figures 1 to 6 show the minimum requirements of the U.S. Department of Housing and Urban Development.

**Commentary**

Size of the individual eating space on the table should be based upon a frontage of 24 in and an area of approximately 2 ft<sup>2</sup>. In addition, table space should be large enough to accommodate serving dishes.

Desirable room for seating is a clear 42 in all around the dining table. The following minimum clearances from the edge of the table should be provided: 32 in for chairs plus access thereto, 38 in for chairs plus access and passage, 42 in for serving from behind chair, 24 in for passage only, 48 in from table to base cabinet (in kitchen).

In sizing the separate dining room, provision should be made for circulation through the room in addition to space for dining.

The location of the dining area in the kitchen is desirable for small houses and small apartments. This preference appears to stem from two needs: (1) housekeeping advantages; (2) the dining table in the kitchen provides a meeting place for the entire family. Where only one dining location is feasible, locating the dining table in the living room is not recommended.

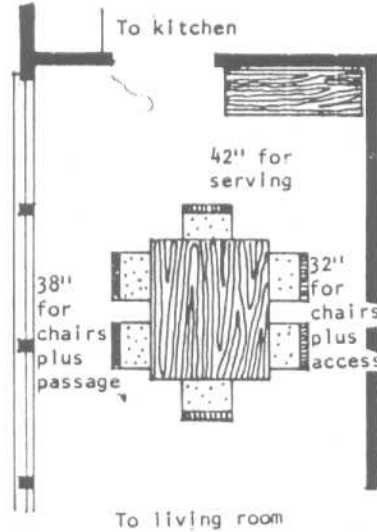


Fig. 1 Dining room for 6-person, 3-bedroom living unit.

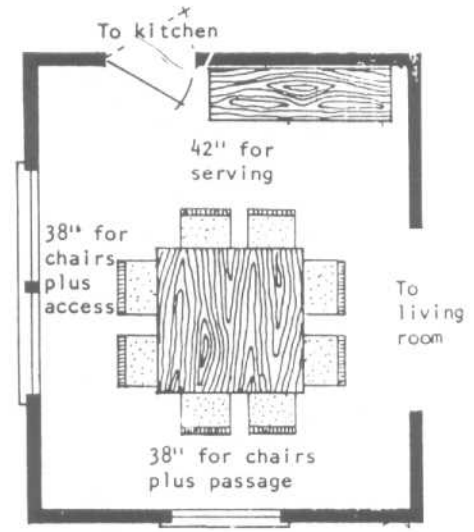


Fig. 2 Dining room for 8-person, 4-bedroom living unit.

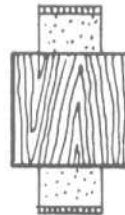


Fig. 3 Table for 2, 2'6" x 2'6".

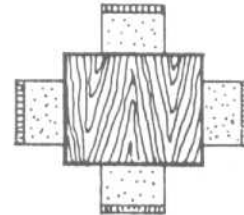


Fig. 4 Table for 4, 2'6" x 3'2".

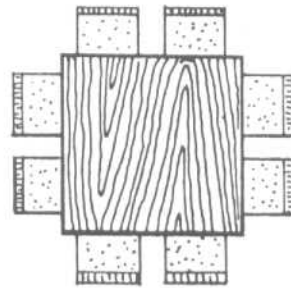


Fig. 5 Table for 8, 4'0" x 4'0".

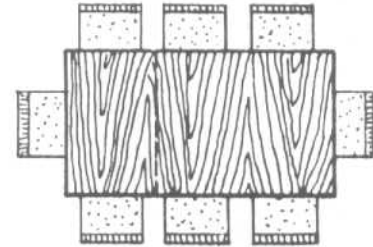


Fig. 6 Table for 8, 3'4" x 6'0".

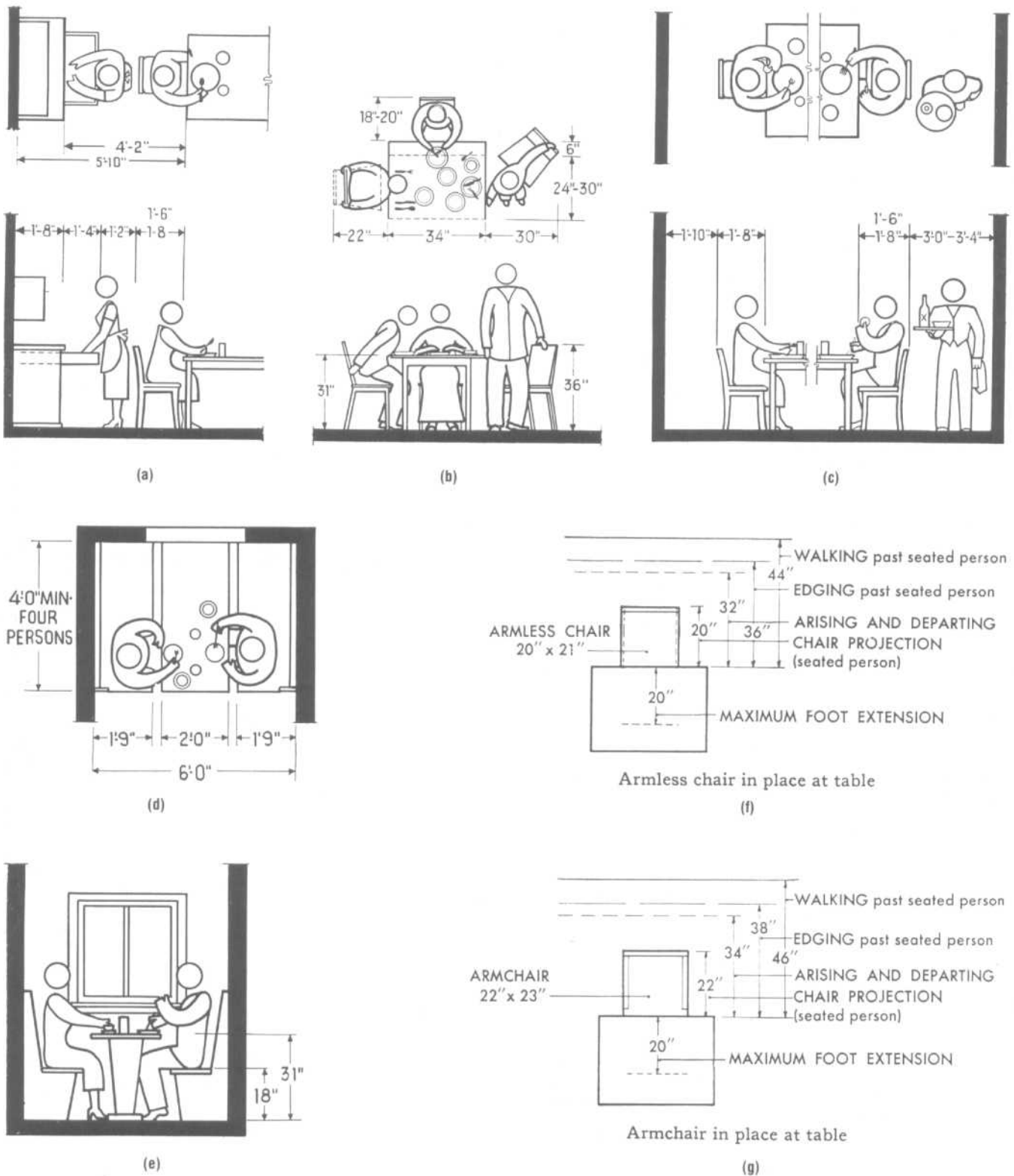
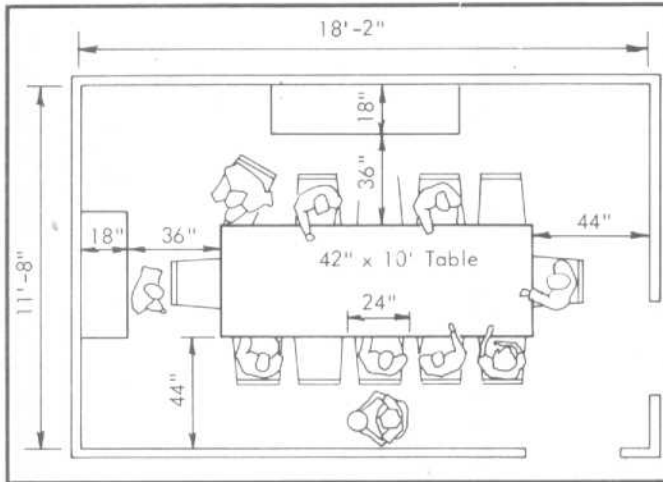


Fig. 7 (a) to (e) illustrate, in plan and elevation, seating requirements and clearances for various dining table arrangements. (f) and (g) illustrate clearance guidelines for a typical armless dining chair and a dining chair with arms, respectively. It should be noted that the clearances indicated relate to chairs with depth dimensions of 20" and 22"; clearances should be adjusted depending on the chair size finally selected.



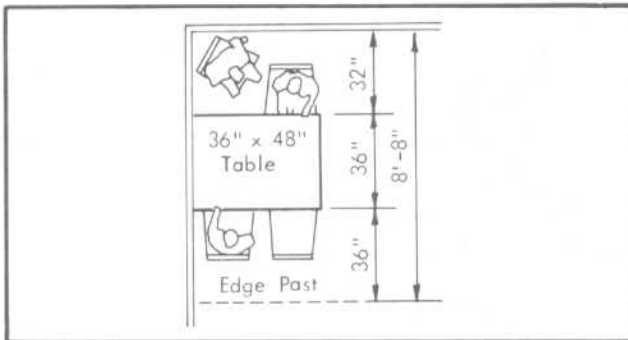
**DINING ROOMS**

Furniture Clearances



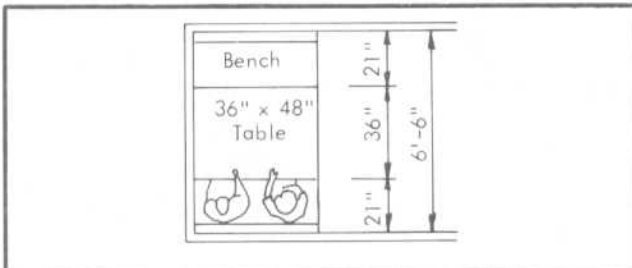
**A dining room for 12.**

A hutch or buffet is typically about 18" deep. A 42" wide table is common. There is space behind the chairs to edge past one side and one end, and to walk past on the other side and end. Table space is 24" per person, the minimum place setting zone. With arm chairs at the ends, allow an extra 2" for each; add 4" to the room length.



**Minimum width for table and chairs.**

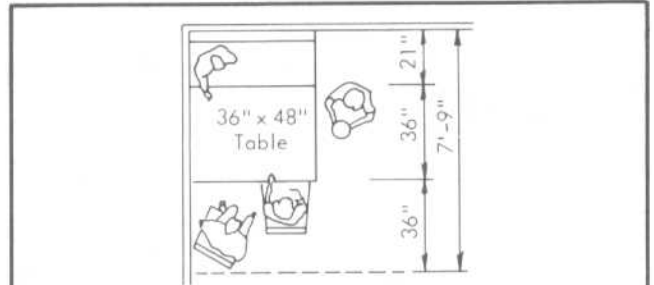
8'-8" for 36" wide table, 32" on one side to rise from the table and 36" on the other side to edge past. A 48" long table seats 4 and requires 34.6 ft<sup>2</sup>.



**Dining space with benches.**

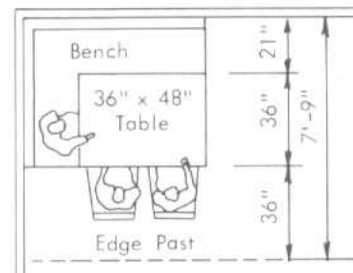
6'-6" for benches on both sides of a 36" table. A 48" long table seats 4 and requires 26 ft<sup>2</sup>.

Fig. 8



**Bench on one side.**

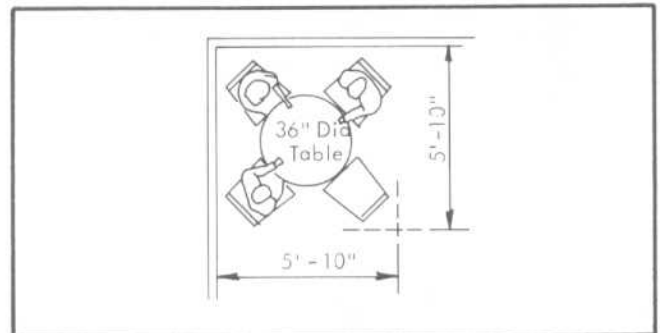
7'-9" for a bench on one side and chairs on the other. Seating for four requires 31 ft<sup>2</sup>.



**Corner bench.**

Benches on one side and one end, and two chairs on the other side, seat five at a 3' x 4' table in 44.5 ft<sup>2</sup>.

**Bench and chair dining.**



**Round tables.**

A 36" round table with four swivel chairs fit in a 5'-10"x5'-10" or 34 ft<sup>2</sup> corner space.

Figures 8 and 9 show clearances and room sizes for various dining arrangements. Since these data come from two sources, there may be slight disparities in suggested dimensions for similar conditions. Since these illustrations are intended only as guidelines for preliminary planning purposes, either set of any differing dimensions can be used.

DINING ROOMS

Furniture Clearances and Room Sizes

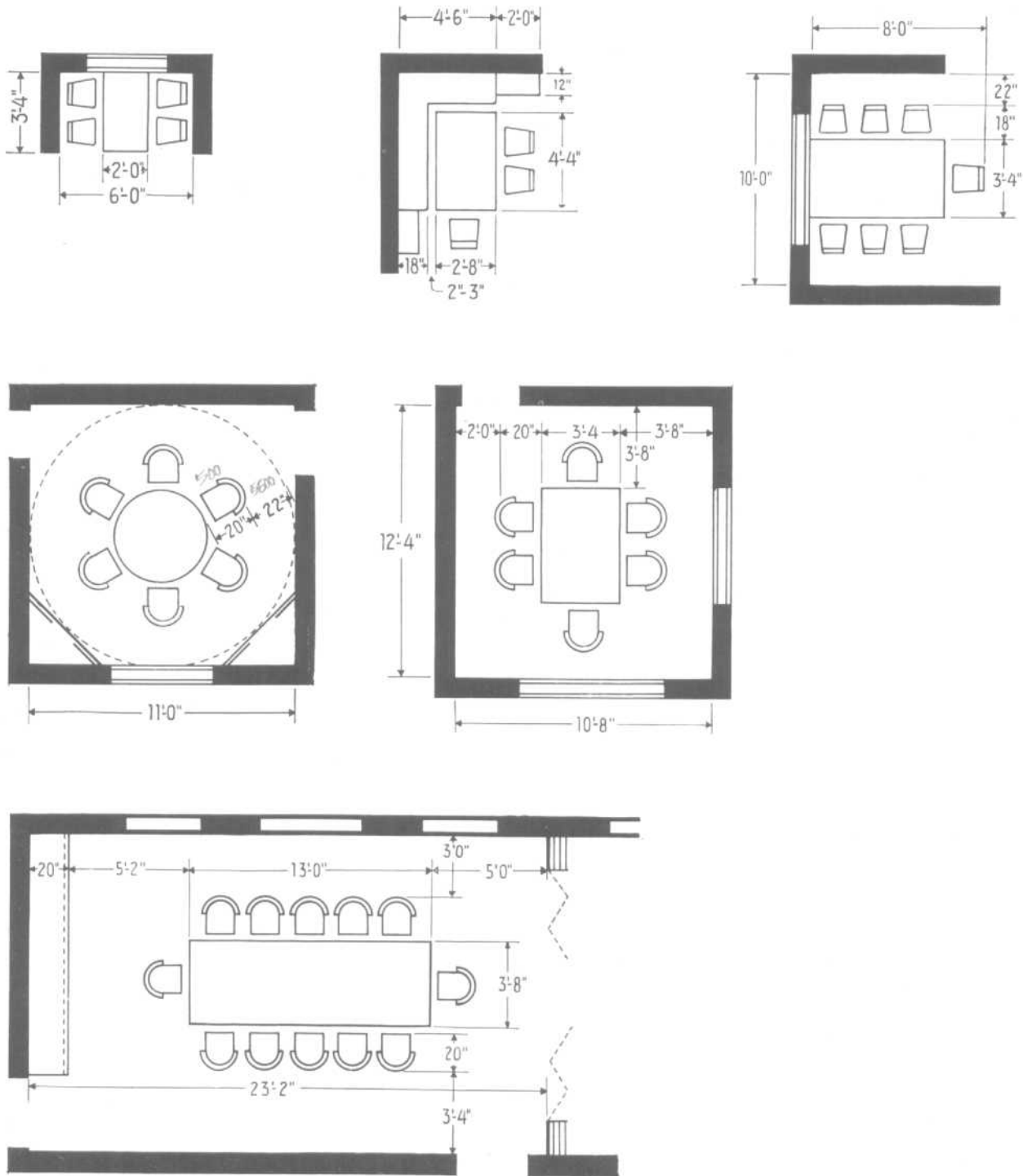


Fig. 9

DINING ROOMS

Furniture Clearances

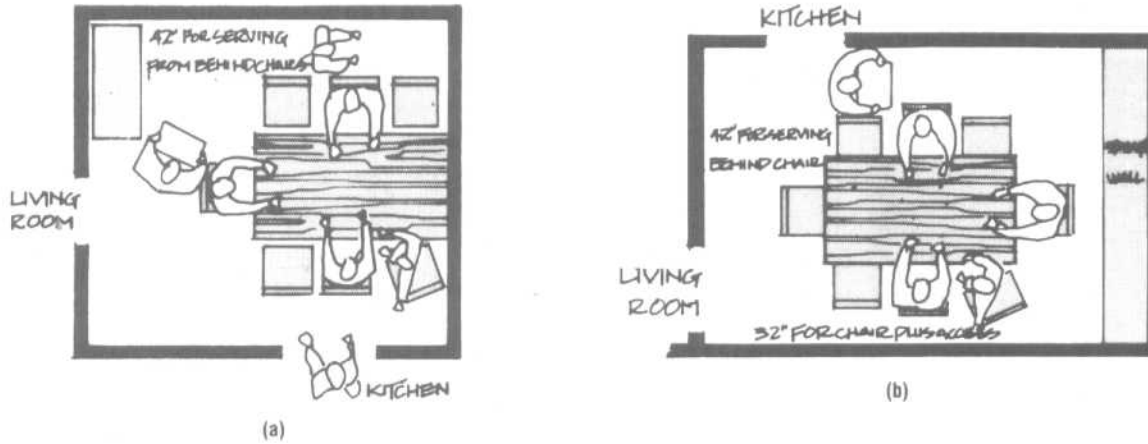
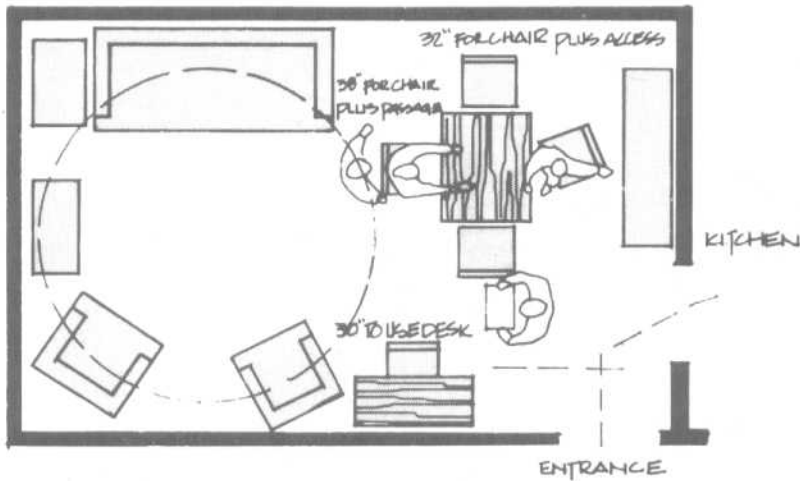


Fig. 10 Minimum clearances for dining areas. (a) One end of table against wall. (b) Serving from one end and one side of table.



To assure adequate space for convenient use of the dining area, not less than the following clearances from the edge of the dining table should be observed:

- 32 in for chair plus access thereto
- 38 in for chairs plus access and passage
- 42 in for serving from behind chair
- 24 in for passage only
- 48 in from table to base cabinet (in dining-kitchen)

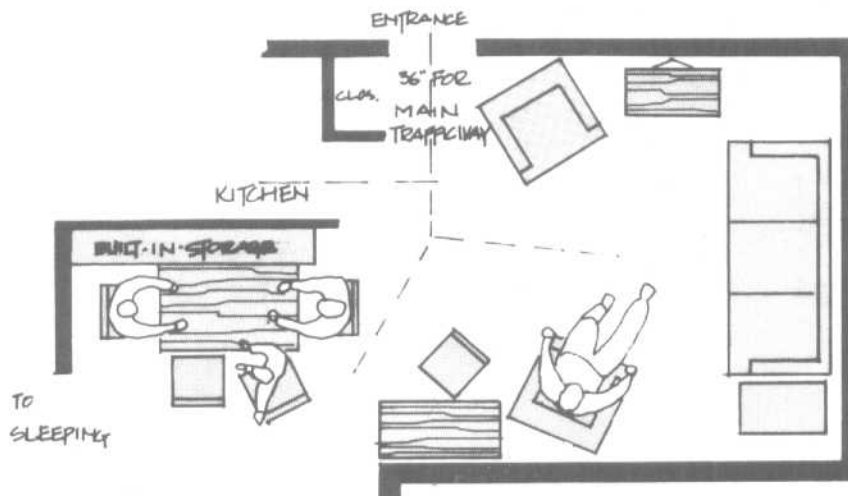
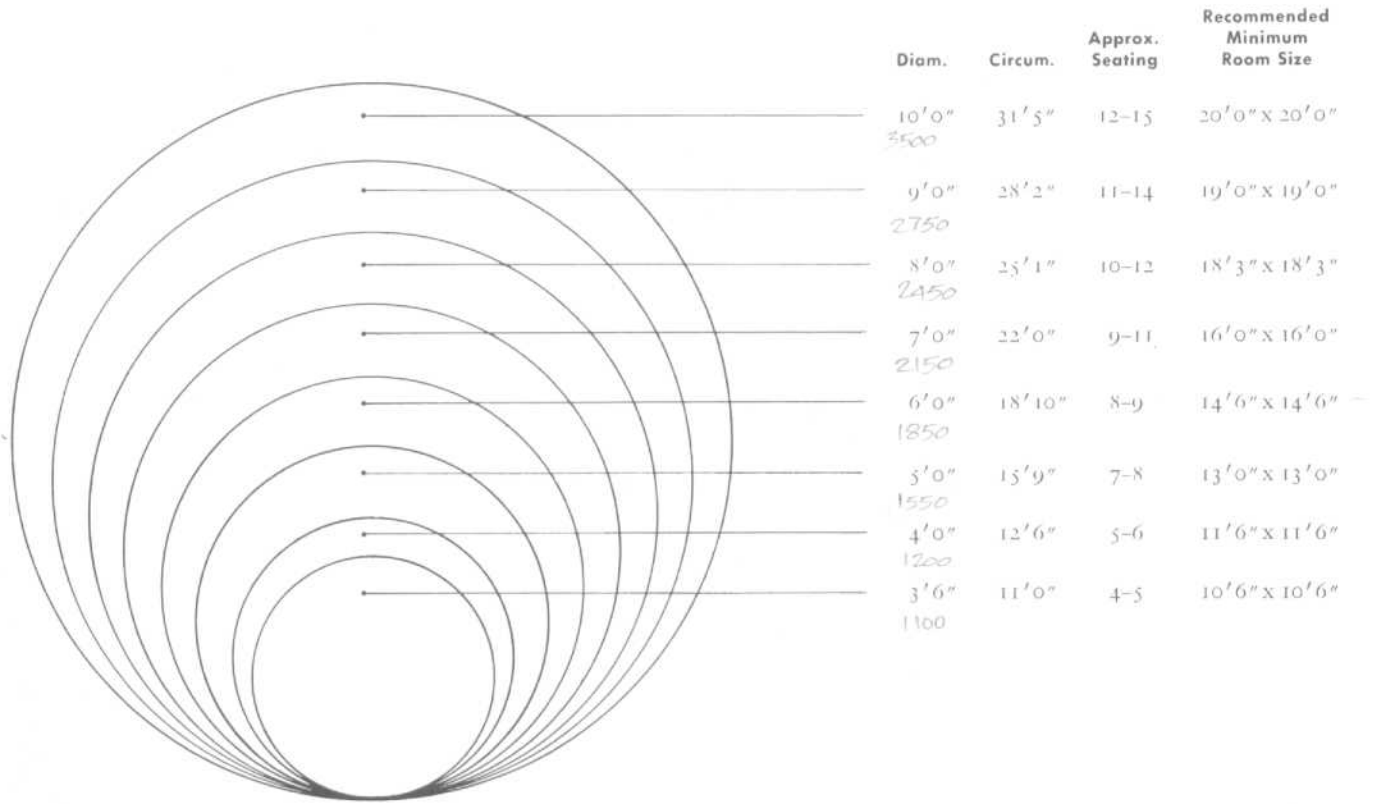


Fig. 11 Minimum clearances and circulation for combined living-dining areas.

**DINING ROOMS**

Dining Tables and Room Sizes

**ROUND TABLES**



**SQUARE TABLES**

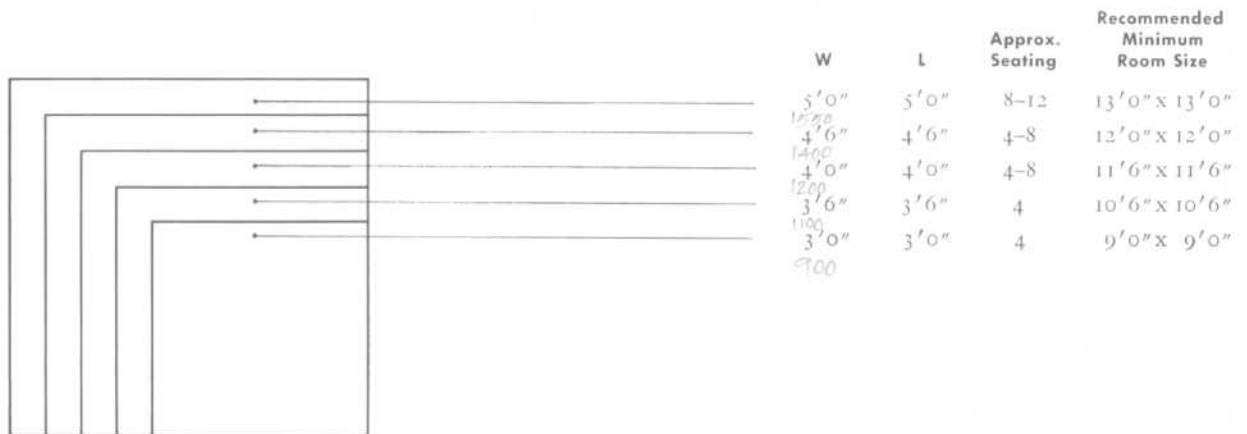


Fig. 12 Seating capacities for round, square, rectangular, and boat-shaped tables of various sizes and the recommended minimum room sizes to accommodate each.

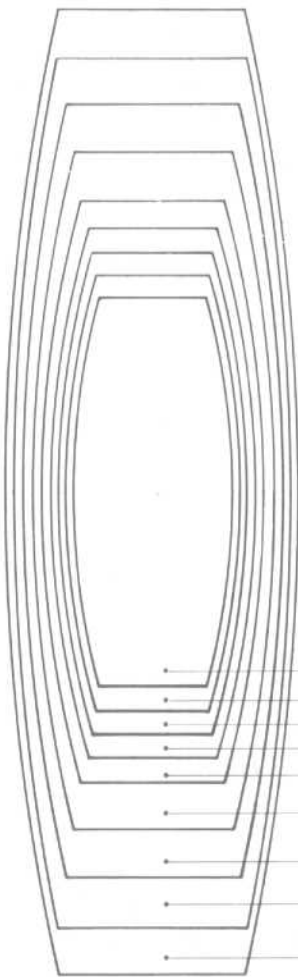
**DINING ROOMS**

Dining Tables and Room Sizes

**RECTANGULAR TABLES**

W	L	Approx. Seating	Recommended Minimum Room Size
6'0"	28'0"	28-30	18'0" x 40'0"
6'0"	26'0"	26-28	18'0" x 38'0"
6'0"	24'0"	24-26	18'0" x 36'0"
5'0"	22'0"	22-24	15'0" x 32'0"
5'0"	20'0"	20-22	15'0" x 30'0"
4'6"	18'0"	18-20	13'6" x 27'0"
4'6"	16'0"	16-18	13'6" x 25'0"
4'6"	14'0"	14-16	13'6" x 23'0"
4'0"	13'0"	12-14	12'0" x 21'0"
4'0"	12'0"	12-14	12'0" x 20'0"
4'0"	11'0"	10-12	12'0" x 19'0"
4'0"	10'0"	10-12	12'0" x 17'0"
4'0"	9'6"	8-10	12'0" x 16'6"
3'6"	9'0"	8-10	10'6" x 16'0"
3'6"	8'6"	8-10	10'6" x 15'6"
3'6"	8'0"	8-10	10'6" x 15'0"
3'6"	7'6"	6-8	10'6" x 14'6"
3'6"	7'0"	6-8	10'6" x 14'0"
3'0"	6'6"	6-8	10'0" x 13'6"
3'0"	6'0"	6-8	10'0" x 13'0"
2'6"	5'0"	4-6	9'0" x 12'6"
2'6"	5'0"	4-6	9'0" x 12'0"

**BOAT SHAPED TABLES**



3'5"	8'0"	8-10	10'0" x 13'0"
3'8"	9'0"	8-10	11'0" x 16'0"
3'11"	10'0"	10-12	12'0" x 17'0"
4'3"	11'0"	10-12	13'0" x 19'0"
4'7"	12'0"	12-14	14'0" x 21'0"
4'11"	14'0"	14-16	15'0" x 23'0"
5'3"	16'0"	16-18	16'0" x 26'0"
5'7"	18'0"	20-22	17'0" x 29'0"
6'0"	20'0"	20-24	18'0" x 32'0"

Fig. 12 (Continued)

## BEDROOMS

## Furniture Clearances and Arrangements

Most of the clearances and bedroom sizes shown here are minimum and intended primarily for preliminary planning purposes. Some building codes permit rooms of even smaller sizes, while rooms in many private homes and luxury apartments are much larger. Moreover, in the final analysis lifestyle, the size and scale of furniture, the activities to be accommodated, and barrier-free design are all factors that should be taken into account during the design process.

Ideally, the recommended minimum bedroom size should be 10'0" x 12'0" exclusive of closets, while the recommended minimum size for a larger bedroom or master bedroom should be 12'0" x 16'0" exclusive of closets.

A larger proportion of the bedroom floor area is occupied by furniture than is the case with any other room; windows and doors account for a large percentage of the wall and partition space. These two factors complicate the planning of bedrooms, especially when the rooms are small.

Because of the room layout, some bedrooms with smaller areas better meet the needs than larger ones. The location of doors, windows, and closets must be properly planned to allow the best placement of the bed and other furniture.

Privacy, both visual and sound, are desir-

able for the bedroom. Children's bedrooms should be located away from the living room, because conversation in the living room prevents the children from sleeping. Closets should be used between all bedrooms whenever possible.

Each child needs a space that is his or her own to develop a sense of responsibility and a respect for the property rights of others. The ideal plan would provide a bedroom for each child, but since this is not always possible, there should be a bed for each.

The minimum room width shall be determined by the space required for the bed, activity space, and any furniture facing the bed. Widths less than 9'0" will usually require extra area to accommodate comparable furniture.

Aside from sleeping, the bedroom is the center of dressing and undressing activities. An interrelationship exists between dressing, storage of clothes, and the bedroom.

Inevitably, in a small apartment, it is not only economical but necessary to plan the use of the bedroom for more than one activity. It is essential to incorporate in the bedroom other functions such as relaxation, work, or entertainment.

A master bedroom should accommodate at least one double bed 4'6" x 6'6" or two

single beds 3'3" x 6'6" each, one crib 2'4" x 1'5" if necessary, one dresser 3'6" x 1'10", one chest of drawers 2'6" x 1'10", one or two chairs 1'6" x 1'6" each, two night tables, and possibly a small desk or table 1'6" x 3'0". Figures 1 to 3 illustrate three configurations and the furniture clearances and room sizes required.

Ample storage is essential. Each bedroom requires at least one clothes closet. For master bedrooms, at least five linear feet of closet length is needed. For secondary bedrooms, at least three linear feet is needed. Clothes closets require a clear depth of two feet.

Each bedroom shall have at least one closet that meets or exceeds the following standards:

1. Depth: 2 feet clear
2. Length (for primary bedroom): 5 linear feet clear
3. Height:
  - a. At least 5'4" clear hanging space
  - b. Lowest shelf shall not be over 6'2" above the floor of room
4. One shelf and rod with at least 12 inches clear space above shelf
5. At least one-half the closet floor shall be level and not more than 12 inches above floor of adjacent room

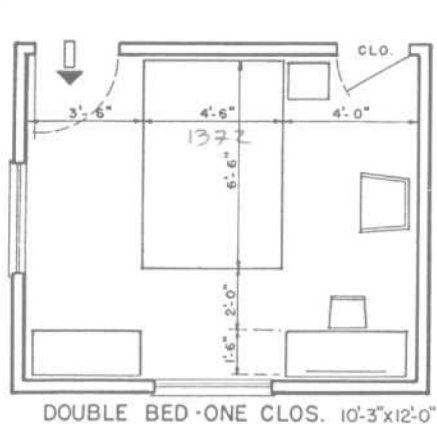


Fig. 1

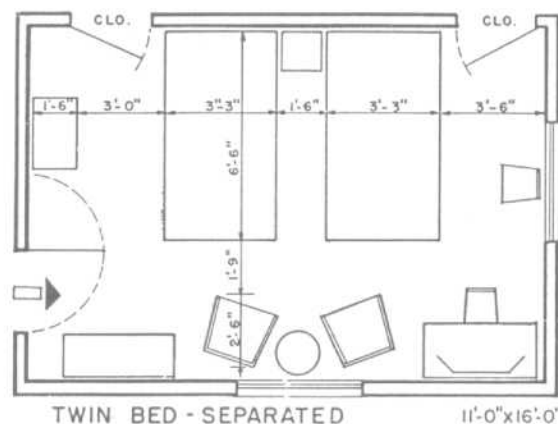


Fig. 2

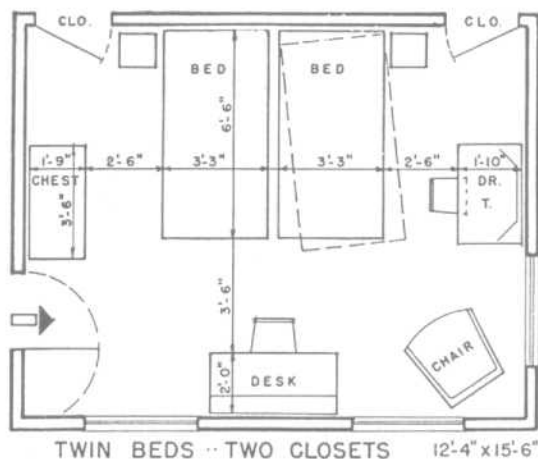


Fig. 3

**BEDROOMS**

Furniture Clearances and Arrangements

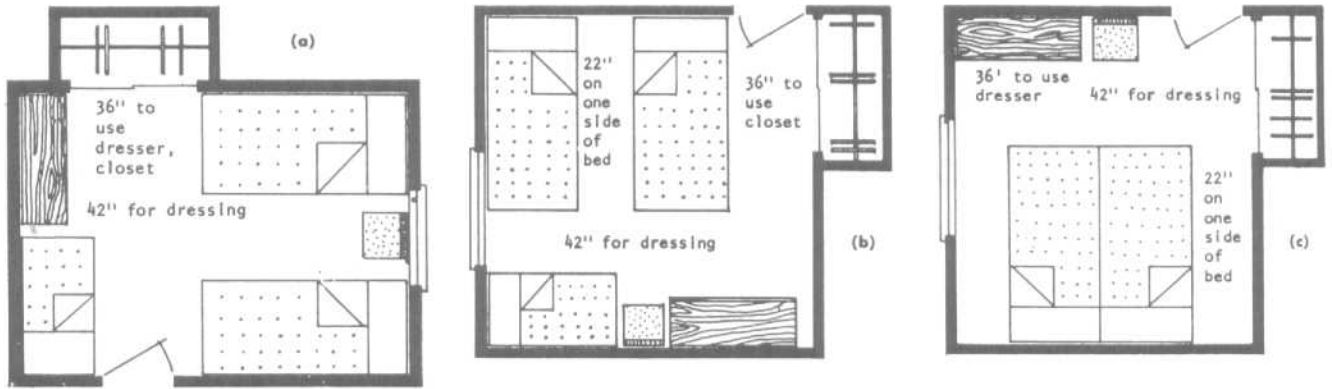


Fig. 4 (a), (b) Primary bedroom; (c) primary bedroom without crib.

**FURNITURE CLEARANCES**

To assure adequate space for convenient use of furniture in the bedroom, not less than the following clearances should be observed (Figs. 4 and 5):

- 42 in at one side or foot of bed for dressing
- 6 in between side of bed and side of dresser or chest

**FURNITURE ARRANGEMENTS**

The location of doors and windows should permit alternate furniture arrangements.

- 36 inches in front of dresser, closet, and chest of drawers
  - 24 in for major circulation path (door to closet, etc.)
  - 22 in on one side of bed for circulation
  - 12 in on least used side of double bed.
- The least-used side of a single or twin bed can be placed against the wall except in bedrooms for the elderly.

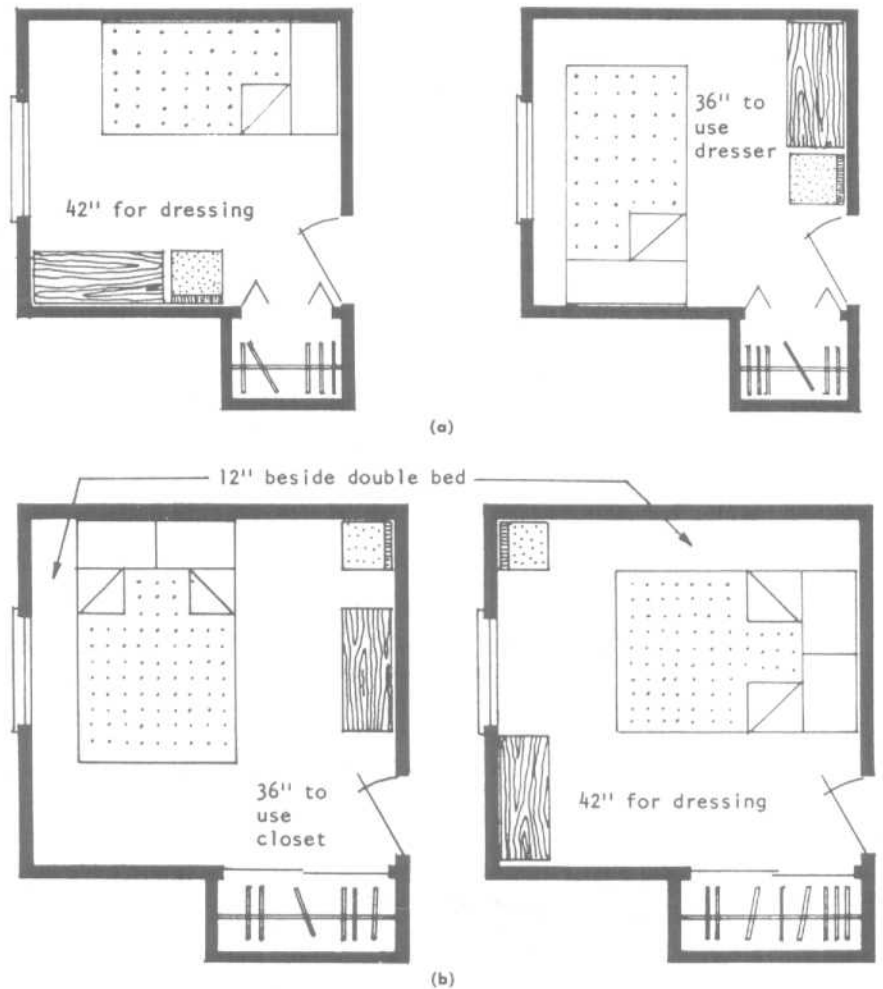


Fig. 5 (a) Single-occupancy bedroom; (b) double-occupancy bedroom.



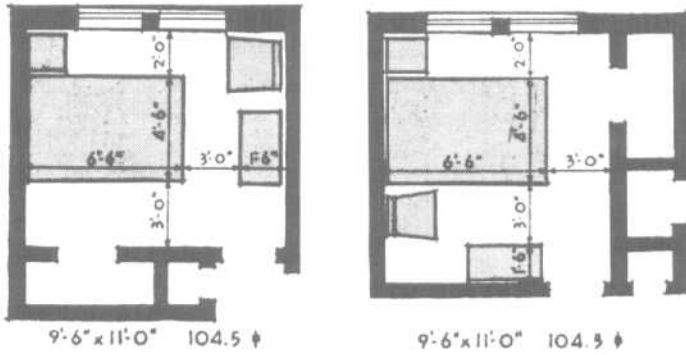


Fig. 6 Although the recommended minimum size for a secondary bedroom is 10' 0" x 12' 0", these diagrams indicate how a double bed, night table, chair, and dresser can be accommodated in a room only 9' 6" x 11' 0".

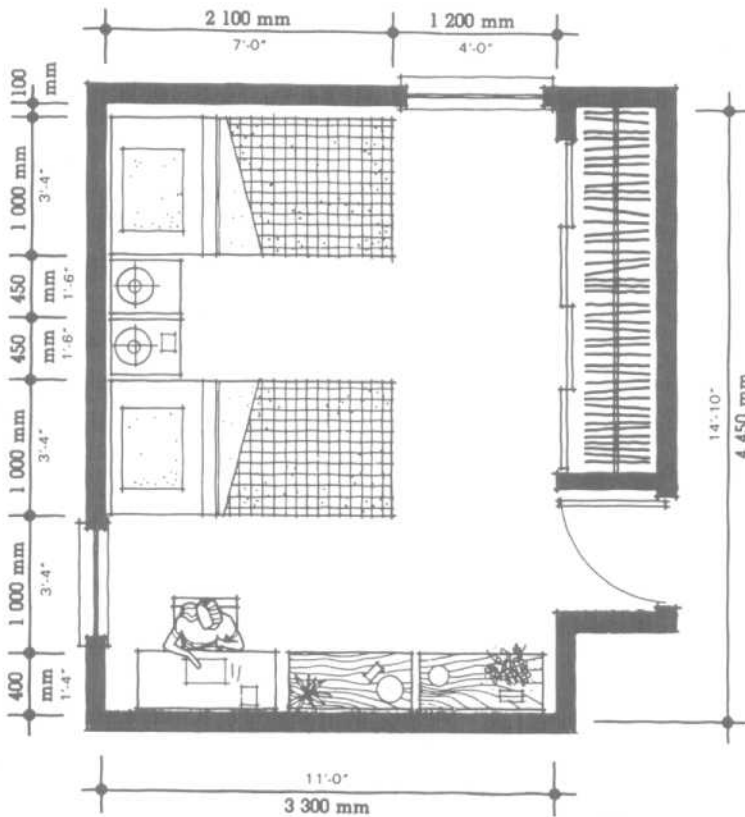


Fig. 7 Double occupancy bedroom. Net area: 14.7 m<sup>2</sup> (160 ft<sup>2</sup>). The most likely occupants of this type of bedroom are adults, school-age children of the same sex, children of different sexes who are less than 9 years old, and preschoolers.

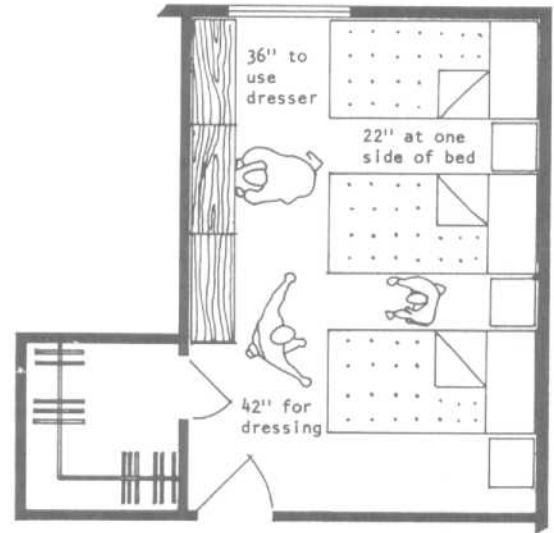
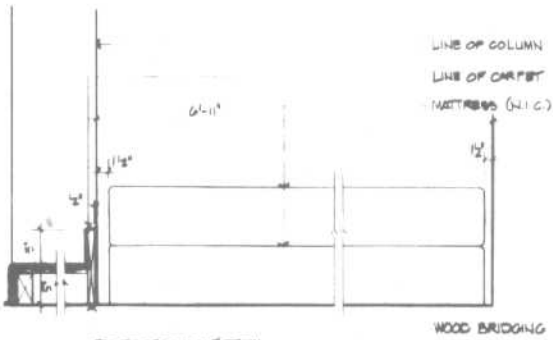


Fig. 8 Occupancy of a bedroom by more than two persons is not recommended. In cases where budgetary and/or space limitations offer no alternative, however, a dormitory arrangement may be necessary. The U.S. Department of Housing and Urban Development recommends the arrangement illustrated in this diagram.

BEDROOMS

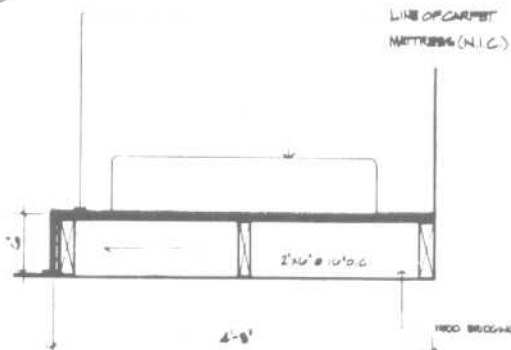
Built-In Storage Details



PROVIDE OPENING IN PLATFORM FOR 60\"/>

WOOD BRIDGING

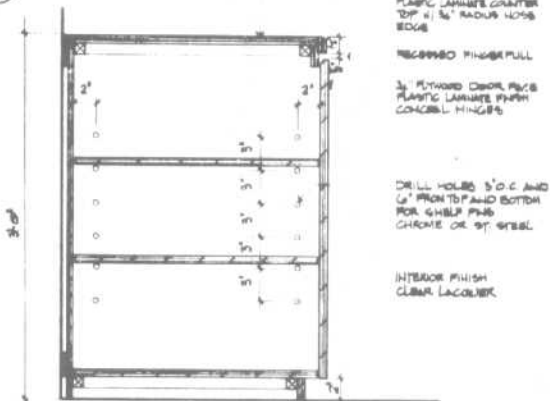
1  
A12  
DETAIL: PLATFORM @ BEDROOM #5  
1'-1'-0"



LINE OF CARPET  
MATTRESS (N.I.C.)

WOOD BRIDGING

2  
A12  
DETAIL: PLATFORM @ BEDROOM #2  
1'-7'-0"



PLASTIC LAMINATE COUNTER TOP w/ 3/4\"/>

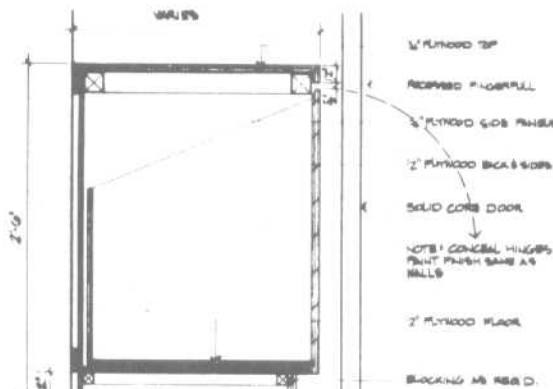
RECESSED FINGERPULL

3/4\"/>

DRILL HOLES 5\"/>

INTERIOR FINISH  
CLEAR LACQUER

3  
A12  
SECTION THRU COUNTER @ LAUNDRY ROOM  
1'-0'-0"



1/2\"/>

RECESSED FINGERPULL

3/4\"/>

2\"/>

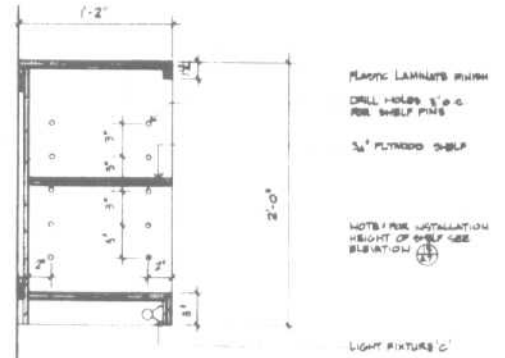
SOLID CORE DOOR

NOTE: CONCEAL HINGERS  
PUSH PUSH SAME AS  
HALLS

2\"/>

BLOCKING AS REQ'D.

4  
A12  
SECTION THRU HAMPER @ BEDROOMS #1 & 5  
1'-0'-0"



PLASTIC LAMINATE FINISH  
DRILL HOLES 5\"/>

3/4\"/>

NOTE: FOR INSTALLATION  
HEIGHT OF SHELF SEE  
ELEVATION (A1)

LIGHT FIXTURE 'C'

PLASTIC LAMINATE COUNTER  
w/ 3/4\"/>

RECESSED FINGERPULL (TYP)

3 BALL DRAWERS w/  
GRANT EXTENSION SLIDES

3/4\"/>

3/4\"/>

5  
A12  
SECTION THRU CABINET & SHELF @ BEDROOM #2  
1'-2'-0"



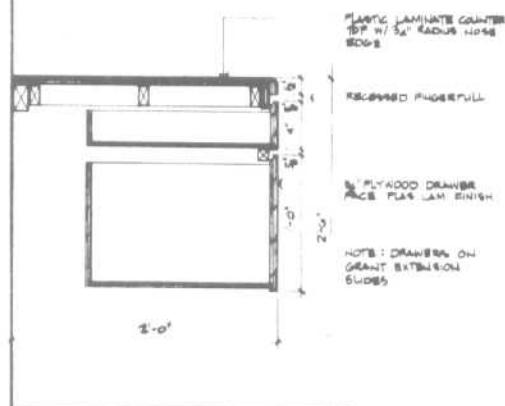
DRILL HOLES 5\"/>

1/2\"/>

PLASTIC LAMINATE FINISH

LIGHT FIXTURE

6  
A12  
SECTION THRU SHELF @ STUDY BEDROOM #4 & #5  
1'-0'-0"



PLASTIC LAMINATE COUNTER  
TOP w/ 3/4\"/>

RECESSED FINGERPULL

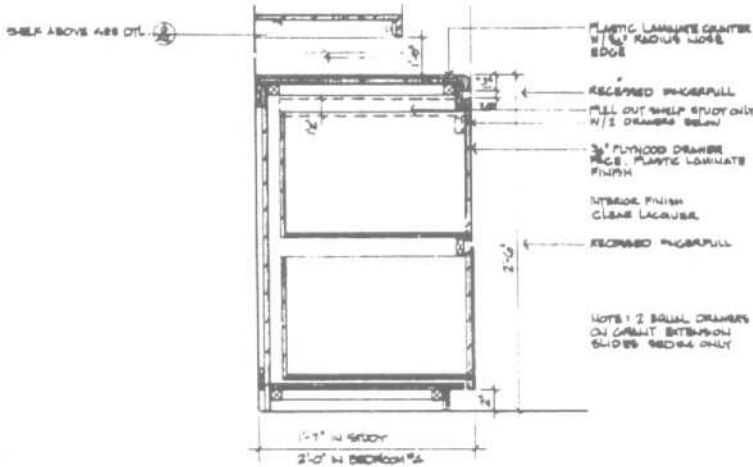
3/4\"/>

NOTE: DRAWERS ON  
GRANT EXTENSION  
SLIDES

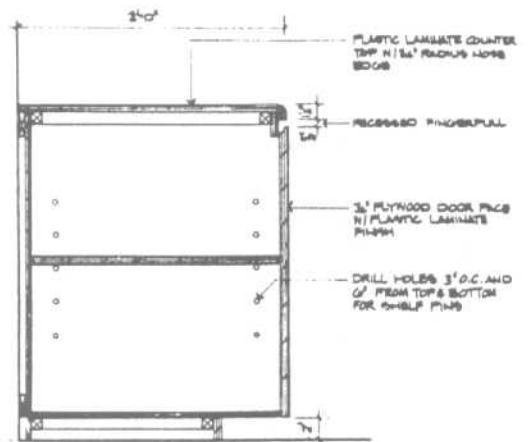
7  
A12  
SECTION THRU DESK @ BEDROOM #5  
1'-0'-0"

BEDROOMS

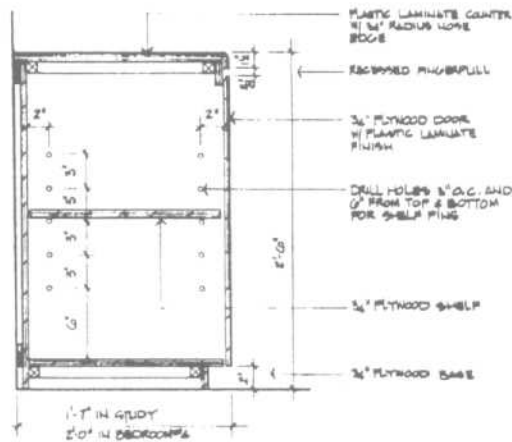
Built-In Furniture



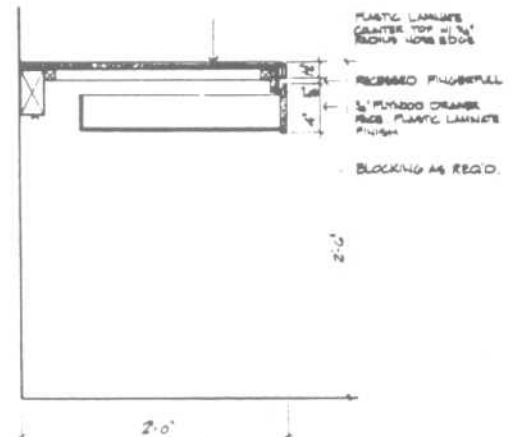
8 SECTION THRU FILE DRAWERS @ STUDY & BEDROOM #4  
A12 12' x 1'-0"



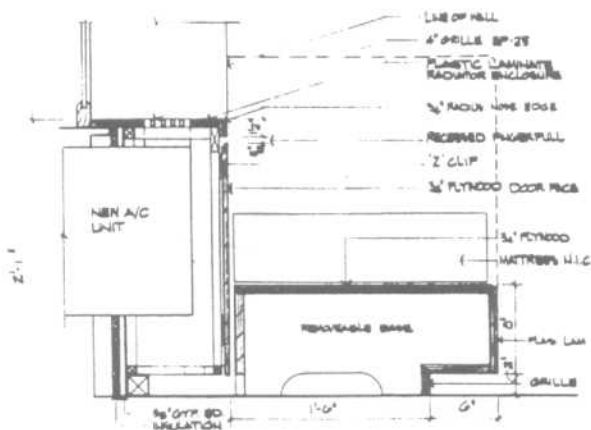
11 SECTION THRU CABINET @ BEDROOM #4  
A12 12' x 1'-0"



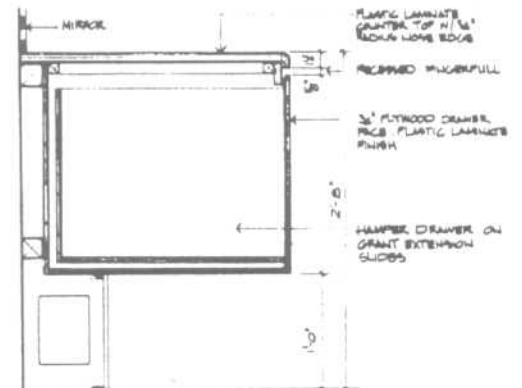
9 SECTION THRU STORAGE CABINET @ STUDY & BEDROOM #4  
A12 12' x 1'-0"



12 SECTION THRU DESK DRAWER @ BEDROOM #4  
A12 19\"/>



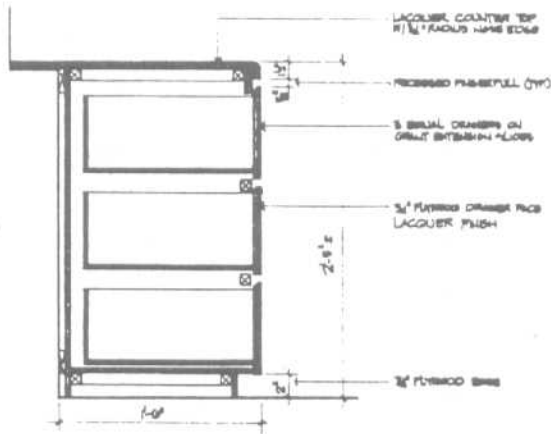
10 SECTION THRU BANGQUETTE @ BEDROOM #4  
A12 12' x 1'-0"



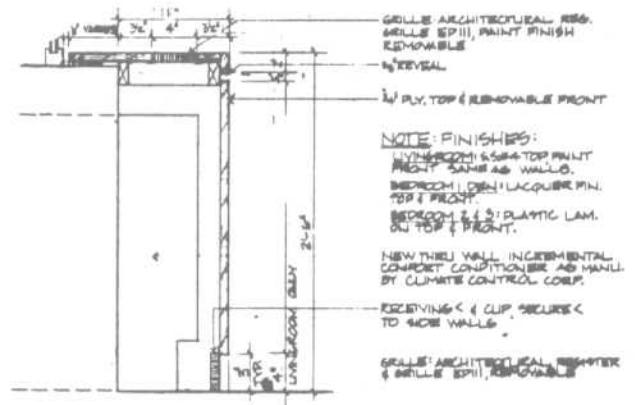
13 SECTION THRU LAV. CAB. HAMPER @ BATH #23 SH. #4  
A12 12' x 1'-0"

BEDROOMS

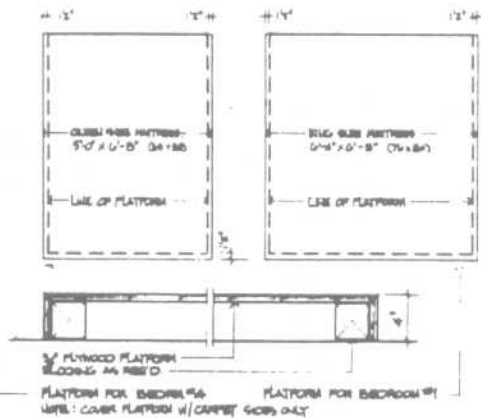
Built-In Furniture



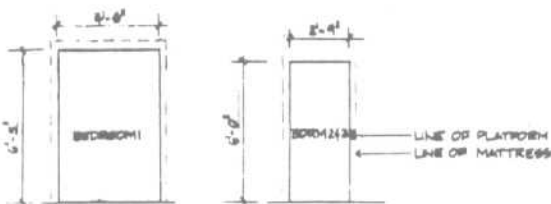
14 SECTION THRU CABINET @ BEDROOM 1  
1 1/2' x 1'-0"



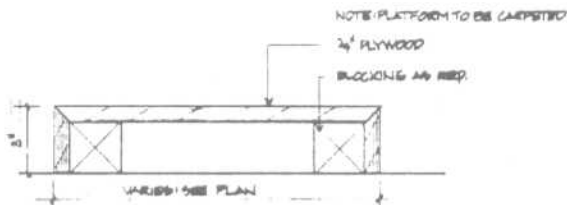
3 SECTION THRU RADIATOR COVER, TYP.  
1 1/2' x 1'-0"



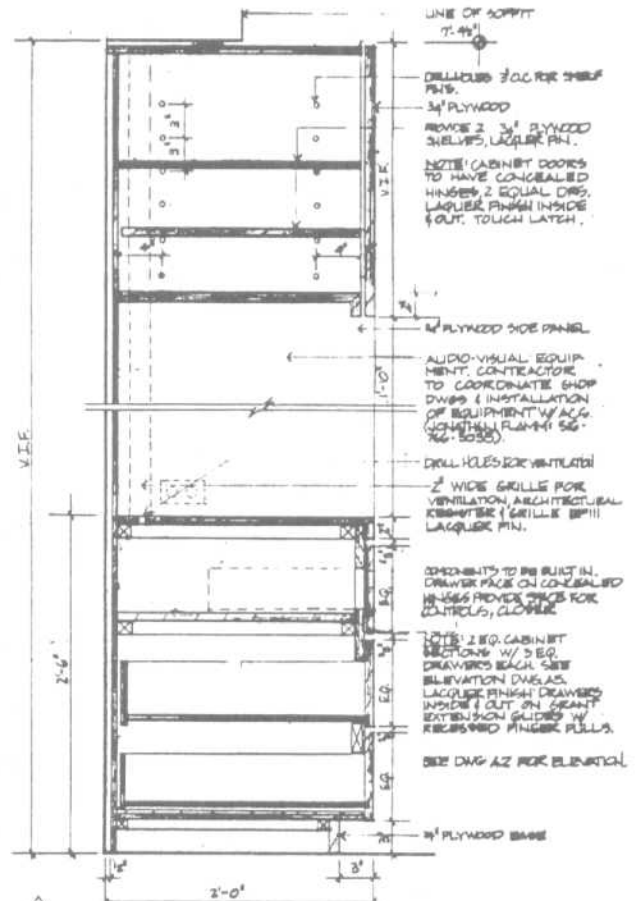
15 PLAN & ELEVATION OF PLATFORMS @ BED 1 & 2  
1 1/2' x 7'-0"



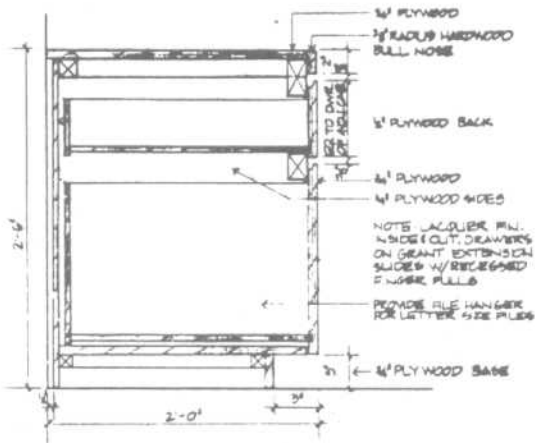
1 PLAN: PLATFORMS FOR BEDS  
1 1/2' x 1'-0"



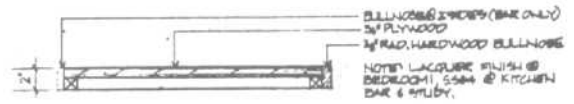
2 SECTION THRU PLATFORM  
1 1/2' x 1'-0"



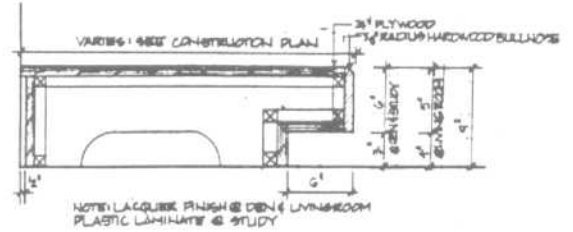
4 SECTION: ARMORE BEDROOM 1  
1 1/2' x 1'-0"



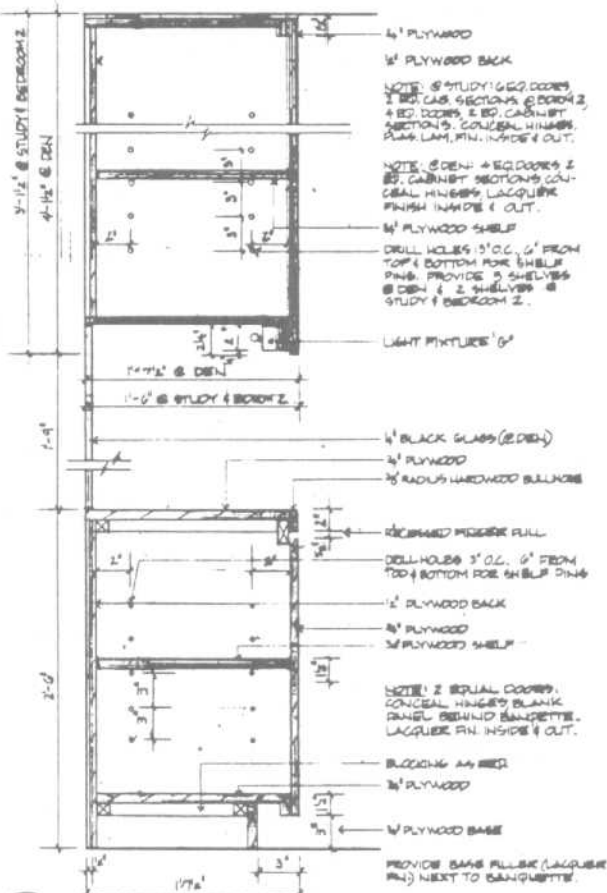
5 SECTION THRU FILE CAB @ BEDROOM  
A6 1/2" x 1'-0"



7 SECTION THRU DESK TOP - BORMI, BAR, STUDY  
A7 1/2" x 1'-0"



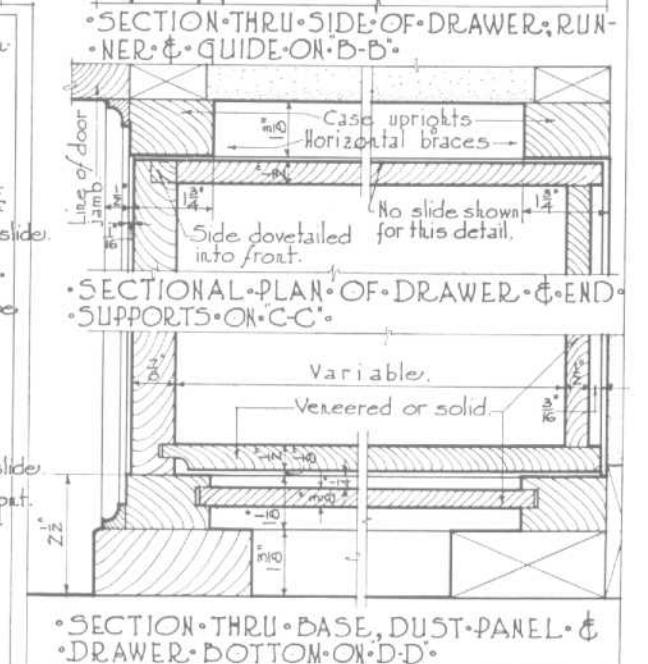
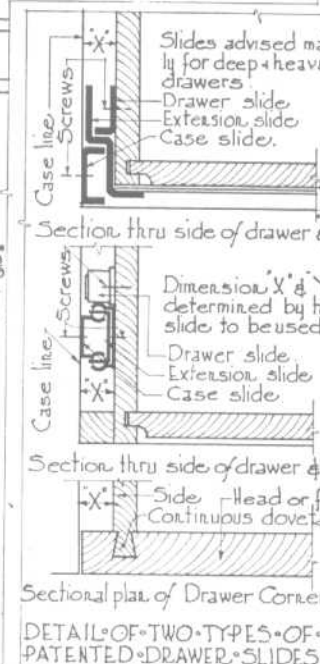
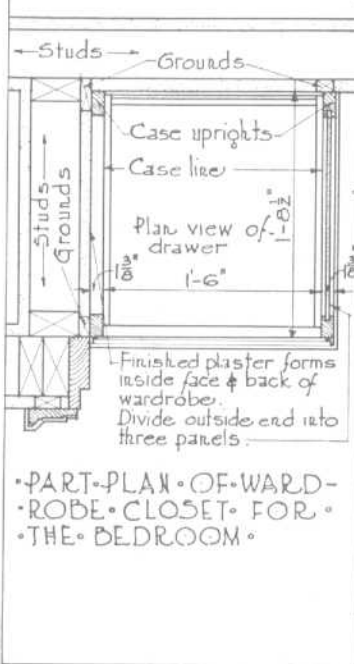
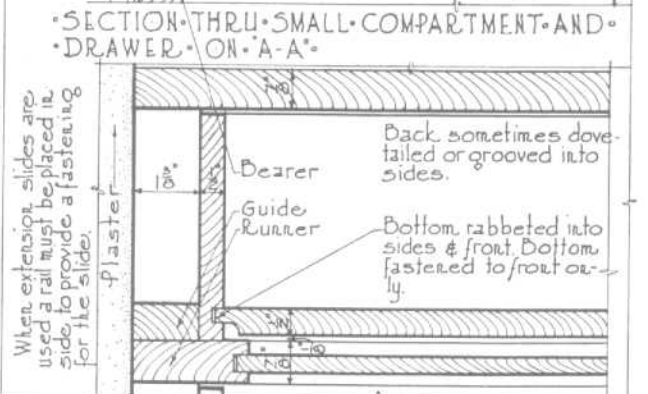
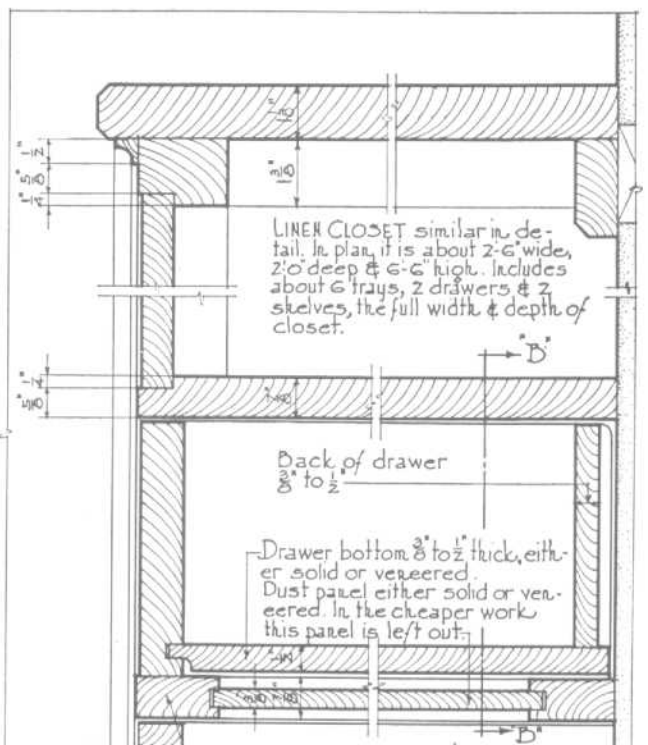
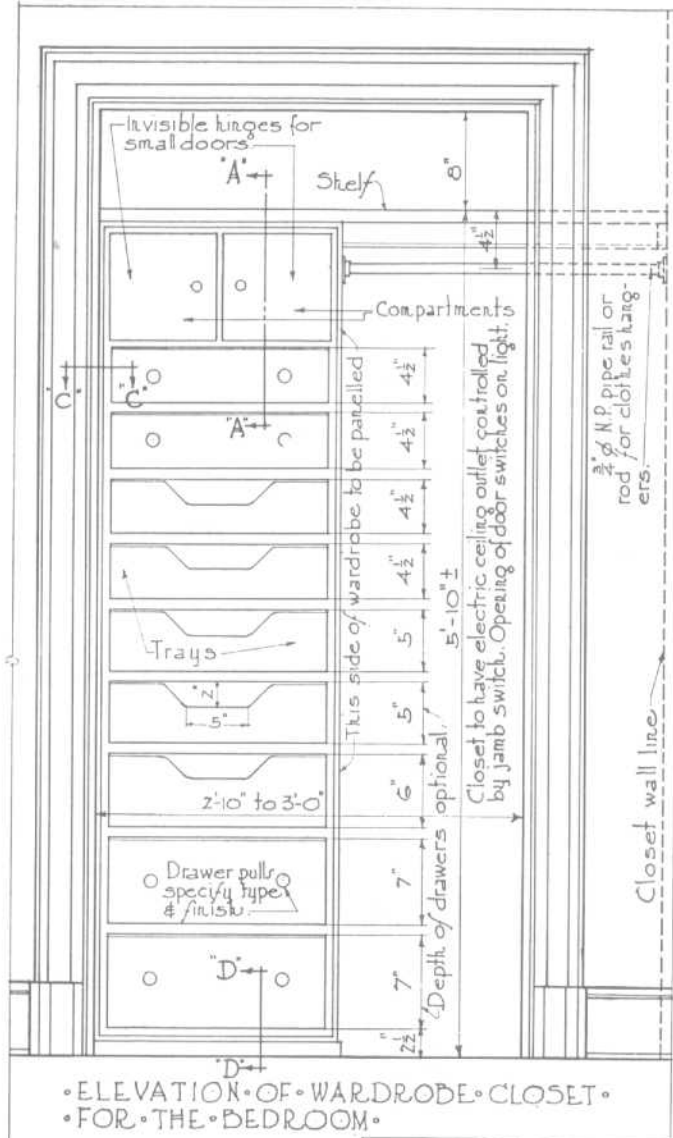
8 SECTION THRU BANQUETTE - TYPICAL  
A7 1/2" x 1'-0"

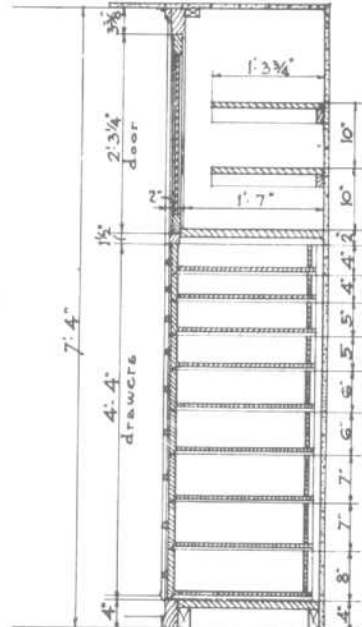
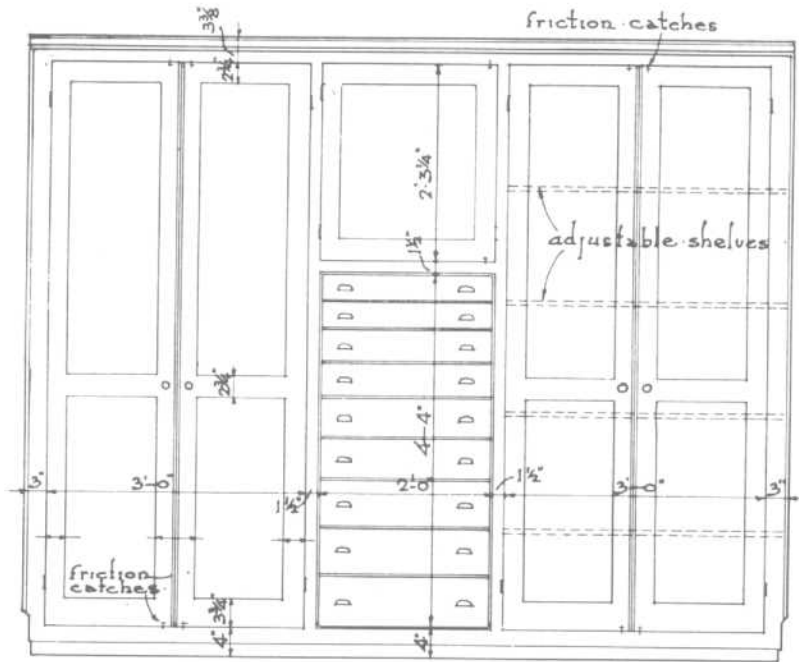


6 SECTION THRU CAB @ DEN WALL @ DEN, STUDY, BORMI  
A7 1/2" x 1'-0"

**BEDROOMS**

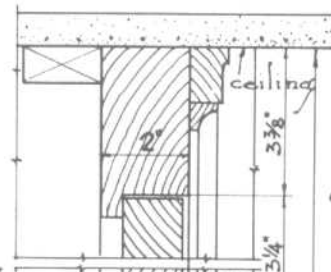
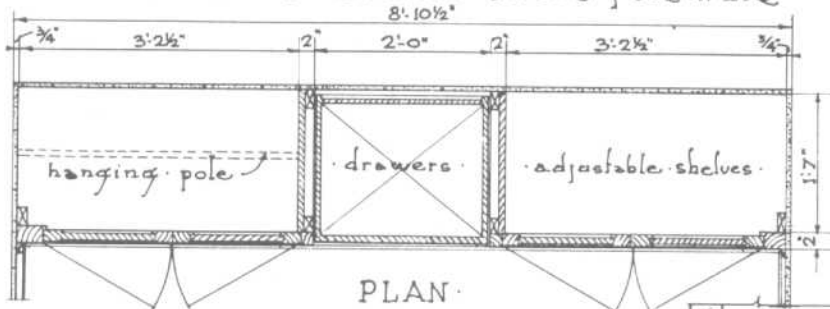
Built-In Wardrobe Details



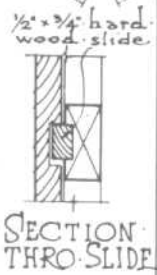
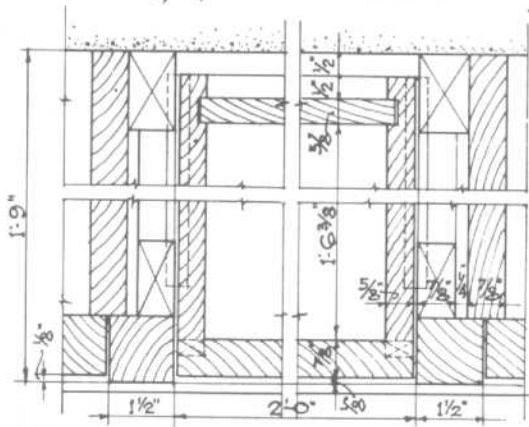


ELEVATION OF CLOSET DOORS & DRAWERS

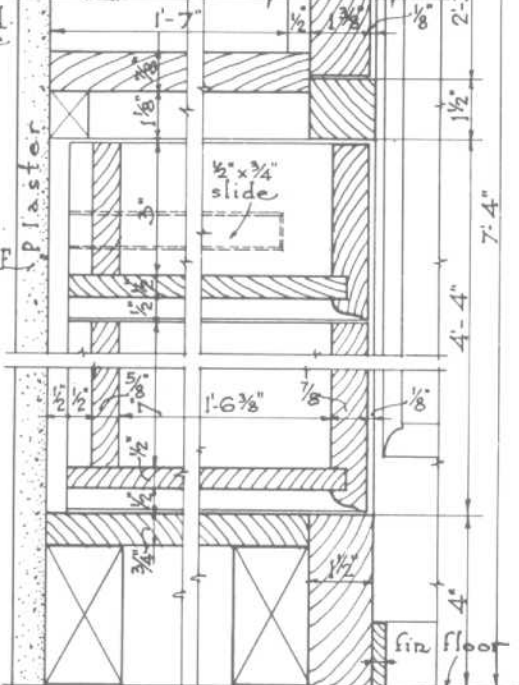
SECTION THRO DRAWERS



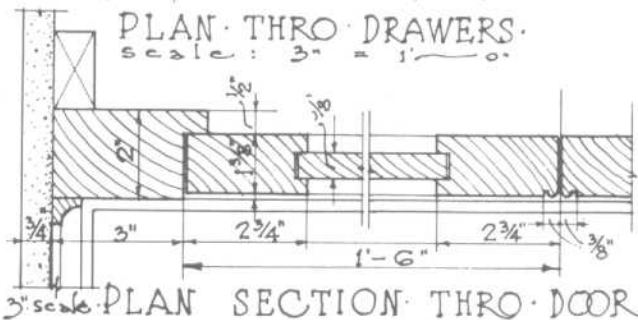
PLAN



SECTION THRO SLIDE



3\"/>

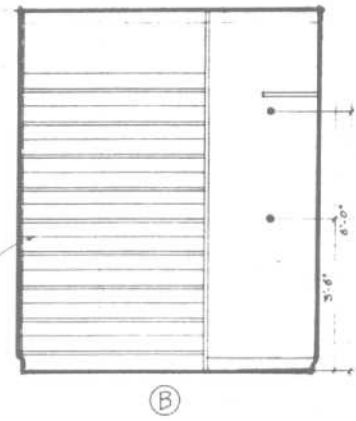
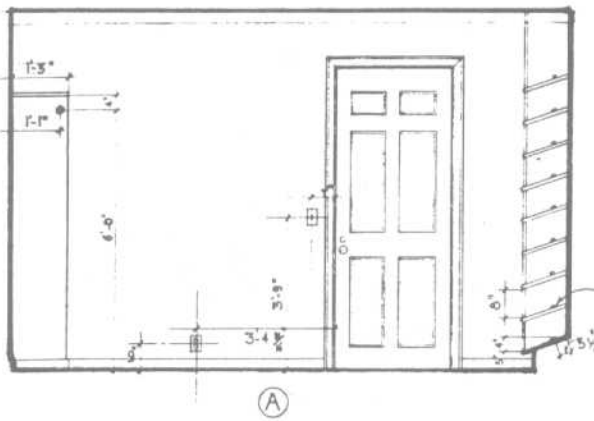
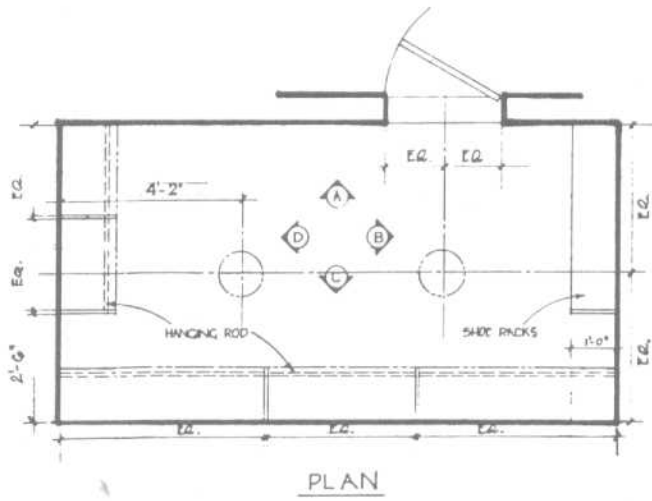


3\"/>

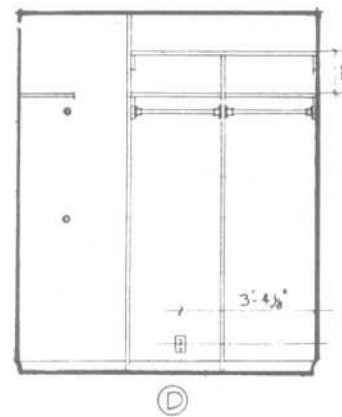
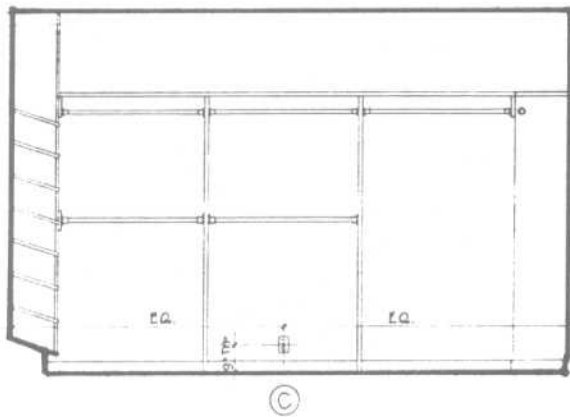


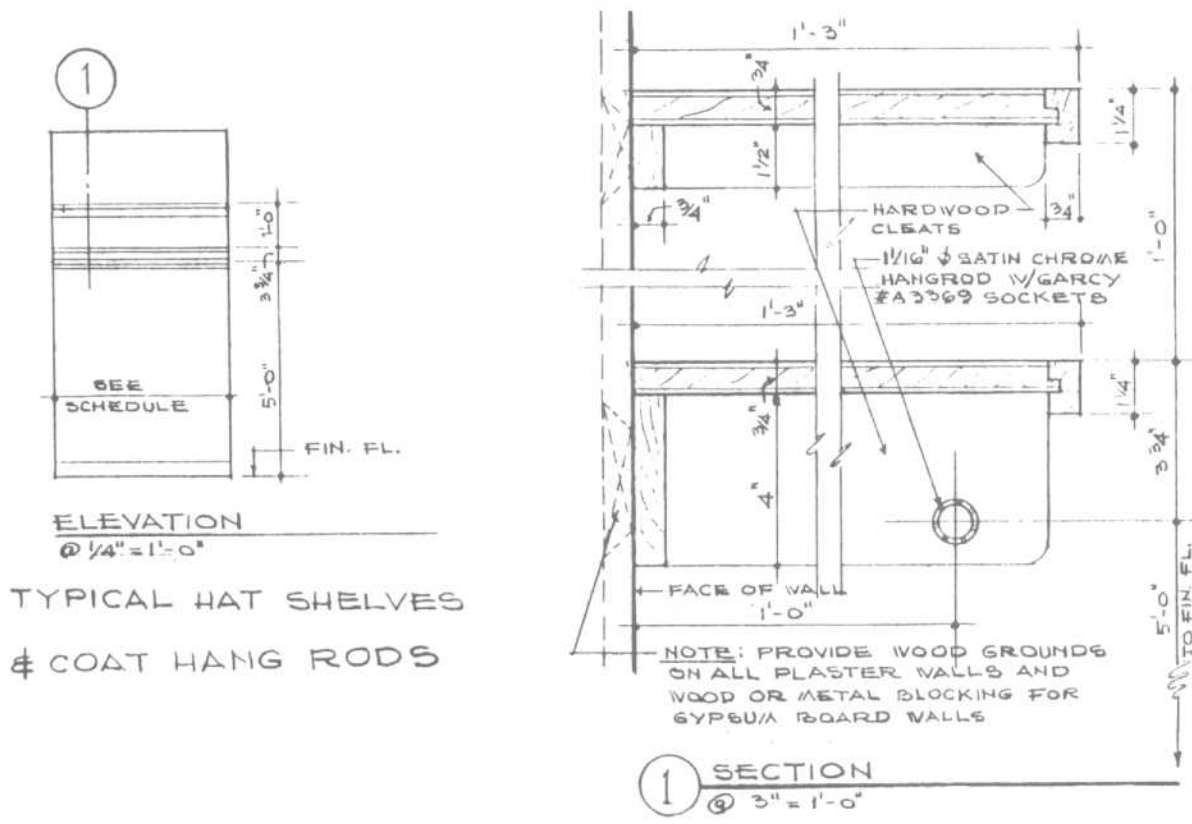
BEDROOMS

Plan and Elevation of Walk-In Closet

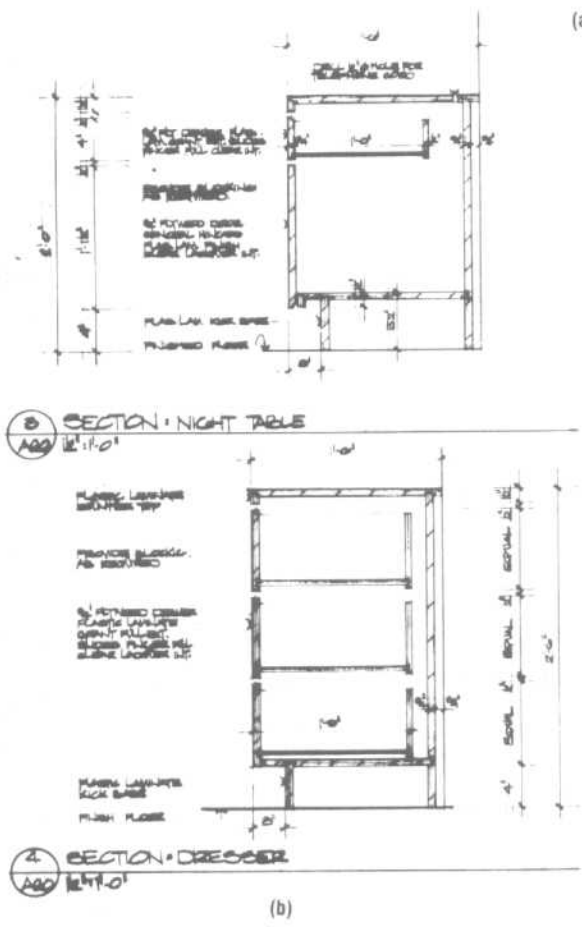


NOTE: ALL HANG'G RODS  
TO BE METAL

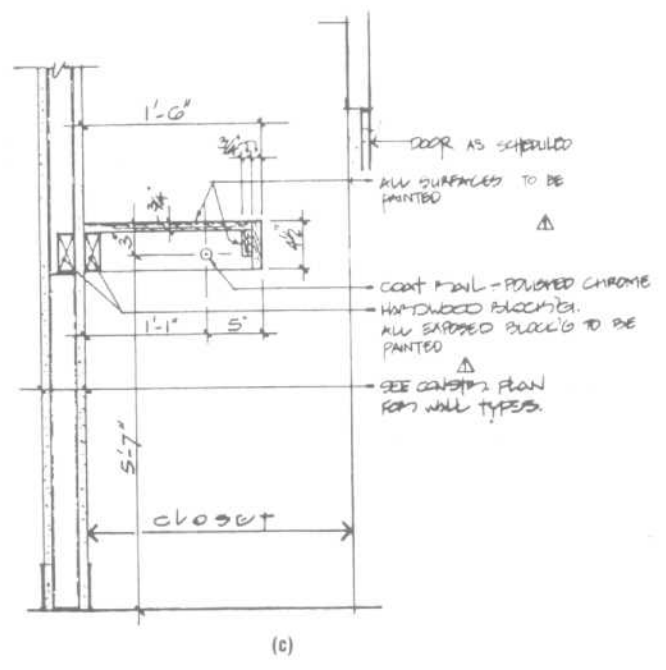




(a)



(b)



(c)

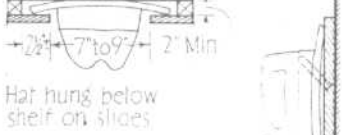
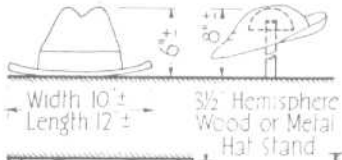
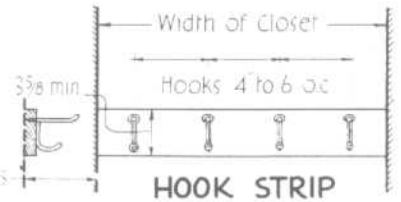
Fig. 9 (a) illustrates a typical hat shelf and coat rod, while (b) shows relatively typical sections through a night table and a dresser. (c) illustrates a typical closet.

**BEDROOMS**

**Closets**

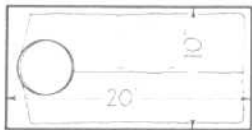


Additional Clearance necessary for garments on hook strips parallel to hanging pole



Peg Rack - may be set at angle to wall if desired

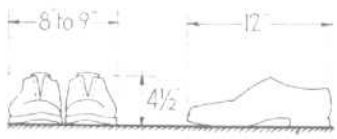
**HATS**



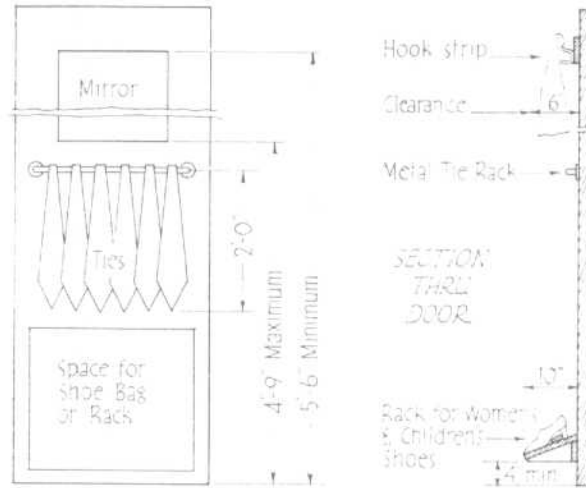
Interior or clear dimensions of Drawer determined by Dress Shirt, either 10" or 20" Side may be front.



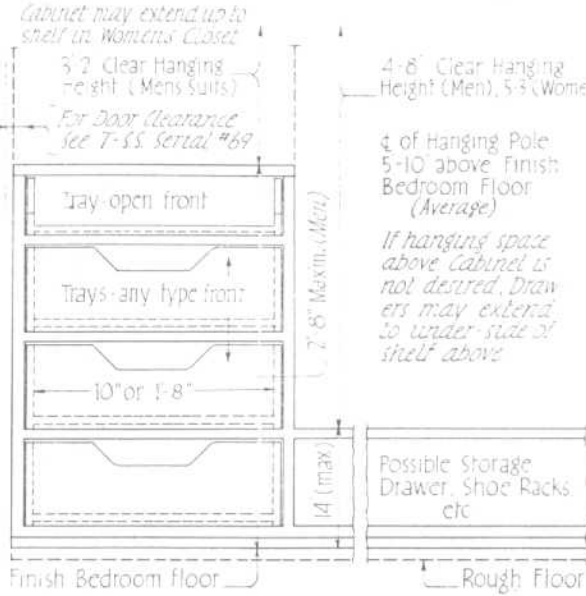
**DRAWER OR TRAY DIMENSIONS**



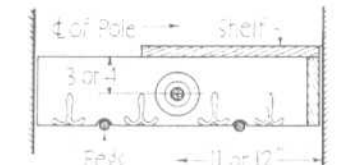
**CLEARANCES - VARIOUS ARTICLES OF CLOTHING**



**UTILIZING BACK OF CLOSET DOOR**



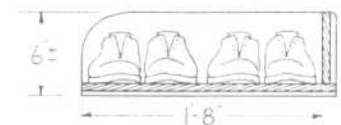
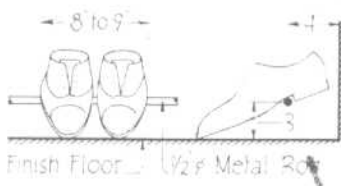
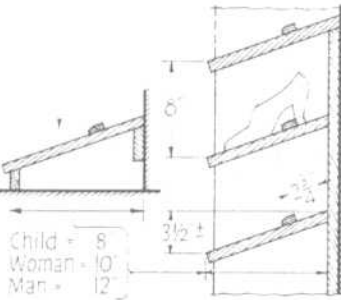
**CABINET FOR BEDROOM CLOSET**



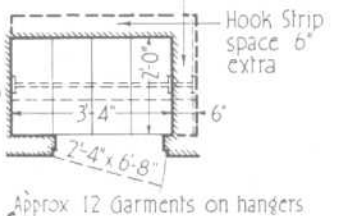
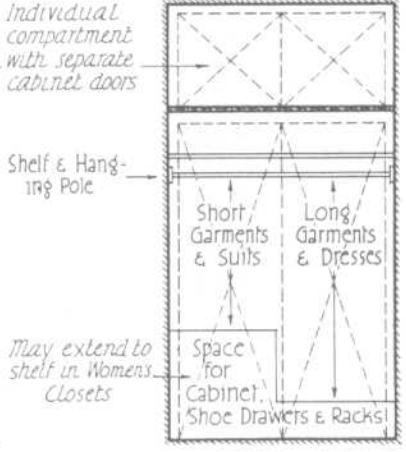
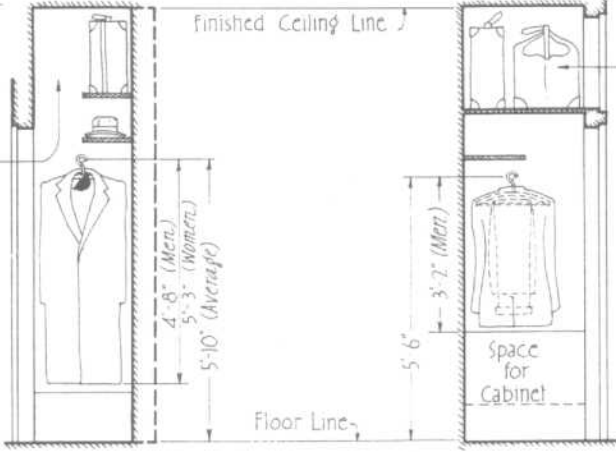
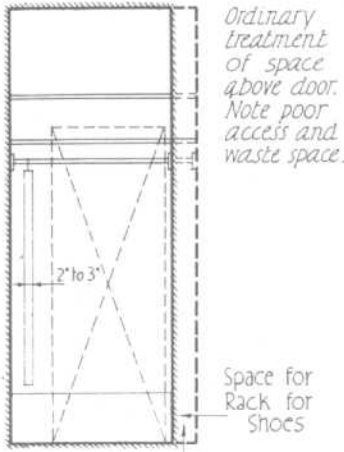
Hanging Pole - Wood 1" dia, Metal 3/4" dia. When length of Pole exceeds 4' additional support is required

**SHELF & HANGING POLE**

BASIC TYPE may be built back to back, or in tiers as shown



**SHOE RACKS & TRAY**



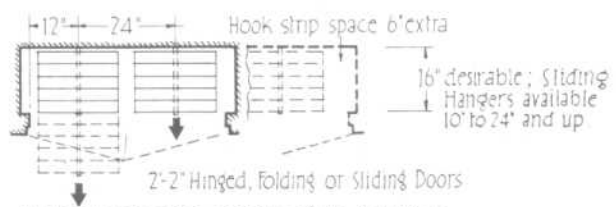
Approx. 12 Garments on hangers

**MINIMUM CLOSET**

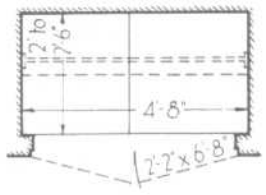
Hook strips for Childrens closets may be provided on rear of door or side walls & may be adjustable in height. (See Details)

**SHALLOW CLOSETS**

As much as possible of front walls should be doors to make entire length of shallow closets accessible.

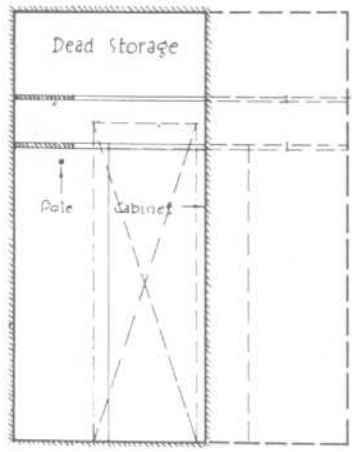


Sliding hanger-rods accommodate maximum number of garments without crushing.



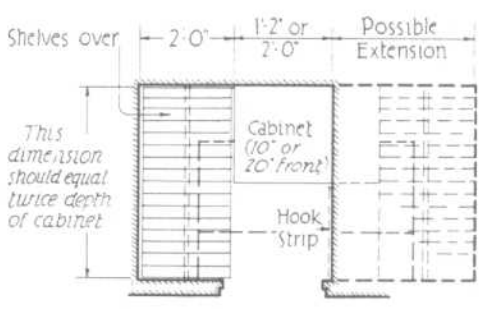
Approx. 18 Garments on hangers

**FITTED CLOSET**

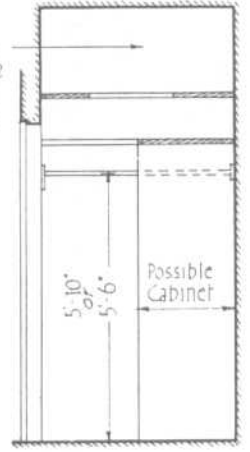


Provide 2" Clearance for drawers at door jamb unless depth of closet permits complete removal.

**EXTREMELY SHALLOW**



cupboard above is impractical because depth is extreme. One or two shelves may be provided



**DEEP CLOSETS**

Closet floors should be flush with top of the door saddle. Closet lights desirable; controlled preferably by door switch.

**BATHROOMS**

Planning Data and Fixture Arrangements

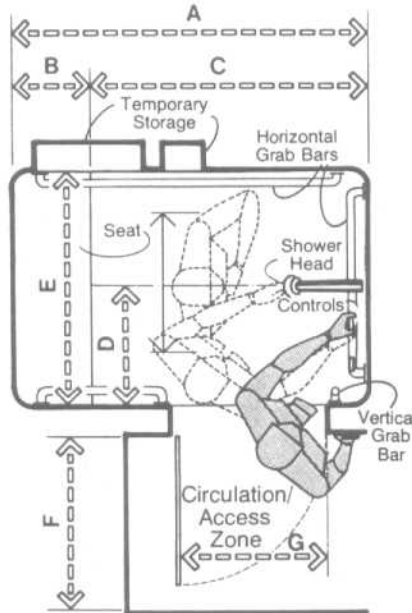
A bathroom should have enough area to accommodate a lavatory, a water closet, and a bathtub or shower. Arrangement for fixtures should provide for comfortable use of each fixture and permit at least 90° door swing unless sliding doors are used.

The bathroom should be convenient to the bedroom zone, and accessible from the living and work areas. Linen storage should be accessible from the bathroom, but not necessarily located within the bathroom.

Each complete bathroom should be provided with the following:

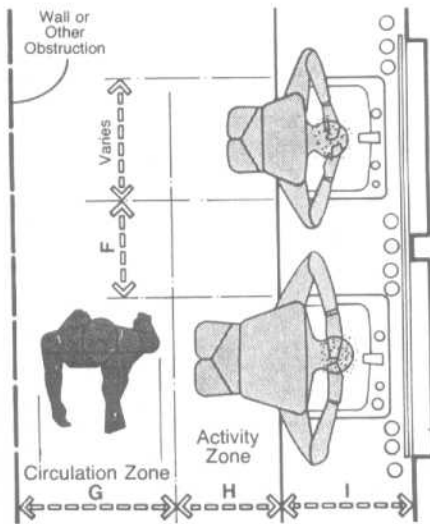
1. Grab-bar and soap dish at bathtub
2. Toilet paper holder at water closet
3. Soap dish at lavatory (may be integral with lavatory)
4. Towel bar
5. Mirror and medicine cabinet or equivalent enclosed shelf space
6. In all cases where shower head is installed, provide a shower rod or shower door

Each half-bath should be provided with items 2 to 6 listed above.



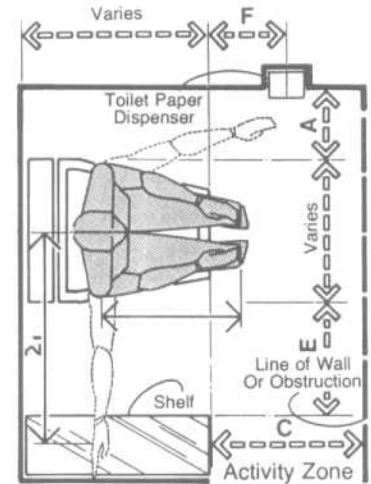
**MINIMUM SHOWER CLEARANCES**

	in	cm
A	54	137.2
B	12	30.5
C	42 min.	106.7 min.
D	18	45.7
E	36 min.	91.4 min.
F	30	76.2
G	24	61.0
H	12 min.	30.5 min.
I	15	38.1
J	40-48	101.6-121.9
K	40-50	101.6-127.0
L	72 min.	182.9 min.

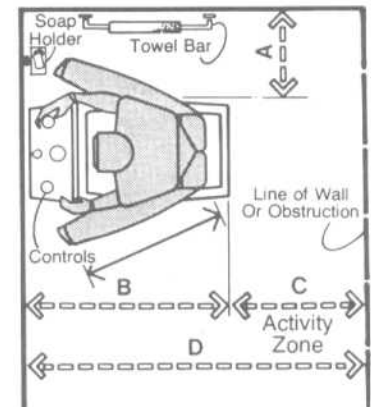


**DOUBLE LAVATORY CLEARANCES**

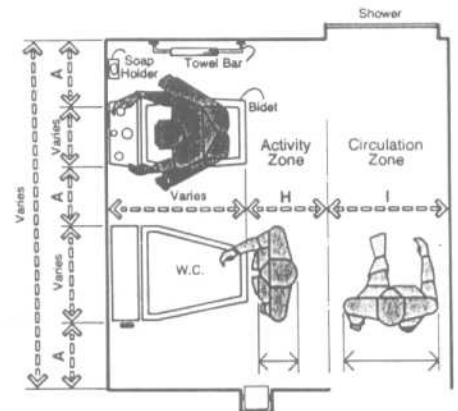
	in	cm
A	15-18	38.1-45.7
B	28-30	71.1-76.2
C	37-43	94.0-109.2
D	32-36	81.3-91.4
E	26-32	66.0-81.3
F	14-16	35.6-40.6
G	30	76.2
H	18	45.7
I	21-26	53.3-66.0



**WATER CLOSET**



**BIDET**



**BIDET AND WATER CLOSET**

	in	cm
A	12 min.	30.5 min.
B	28 min.	71.1 min.
C	24 min.	61.0 min.
D	52 min.	132.1 min.
E	12-18	30.5-45.7
F	12	30.5
G	40	101.6
H	18	45.7
I	30	76.2

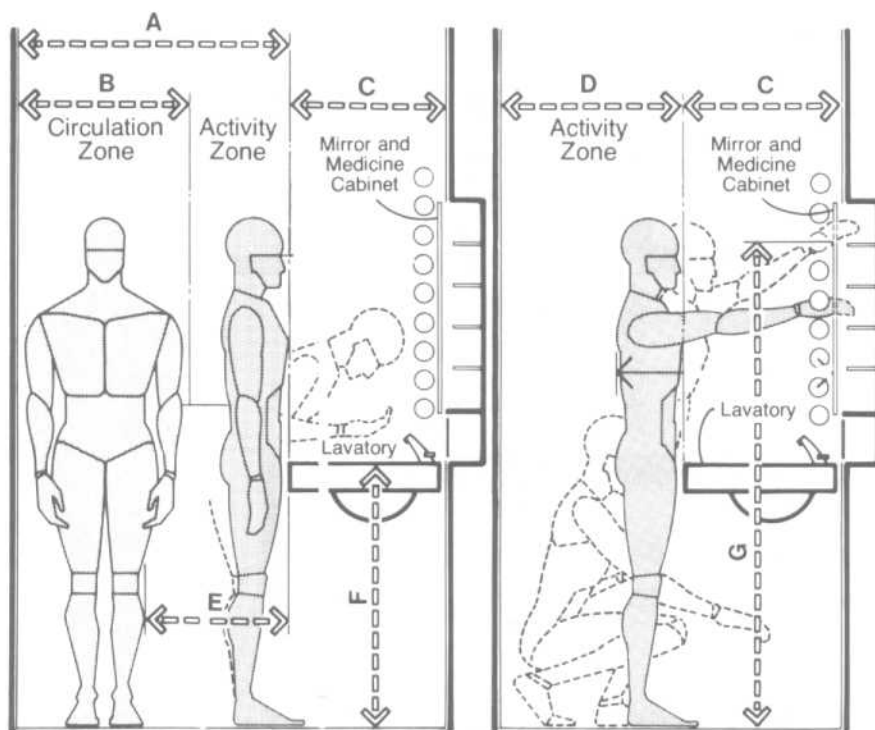


Fig. 1 Lavatory: male anthropometric considerations.

Figure 1 deals primarily with some of the more critical male anthropometric considerations. A lavatory height above the floor of 37 to 43 in, or 94 to 109.2 cm, is suggested to accommodate the majority of users. It should be noted, however, that common practice is to locate the lavatory in the neighborhood of 31 in above the floor. In order to establish the location of mirrors above the lavatory, eye height should be taken into consideration.

Figure 2 explores, in much the same manner, the anthropometric considerations related to women and children. Given the great variability in body sizes to be accommodated within a single family, a strong case can be presented for the development of a height adjustment capability for the lavatory. Until that is developed, there is no reason, on custom installations, why the architect or interior designer cannot take anthropometric measurements of the client to ensure proper interface between the user and the lavatory.

	in	cm
A	48	121.9
B	30	76.2
C	19–24	48.3–61.0
D	27 min.	68.6 min.
E	18	45.7
F	37–43	94.0–109.2
G	72 max.	182.9 max.
H	32–36	81.3–91.4
I	69 max.	175.3 max.
J	16–18	40.6–45.7
K	26–32	66.0–81.3
L	32	81.3
M	20–24	50.8–61.0

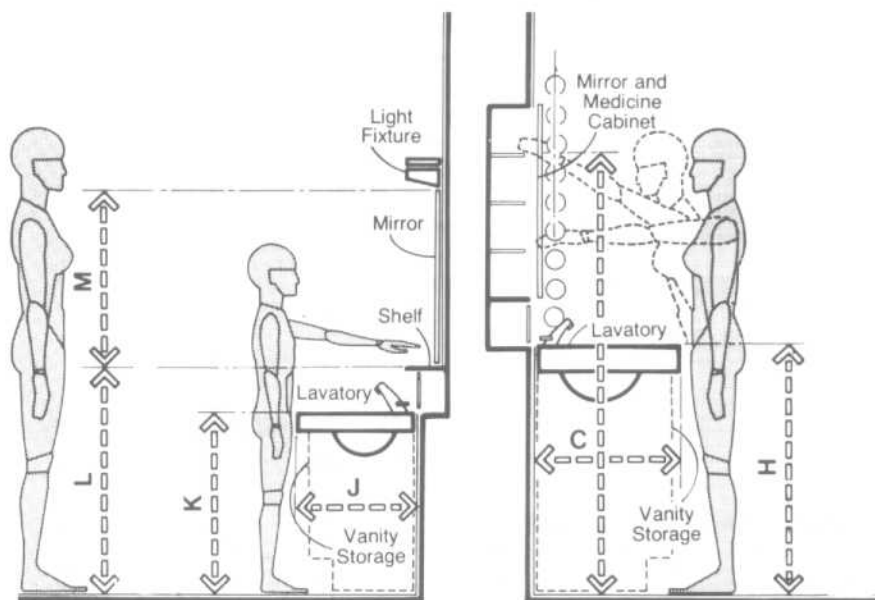


Fig. 2 Lavatory: female and child anthropometric considerations.

BATHROOMS

Typical Plans and Fixture Arrangements

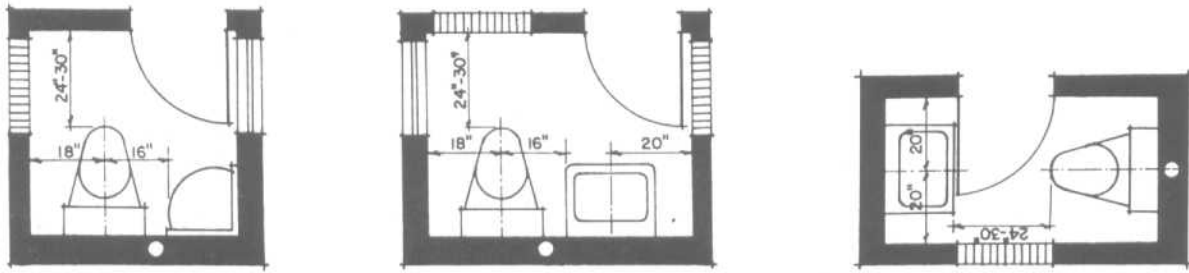


Fig. 3 Two-fixture plans: water closet and washbasin.

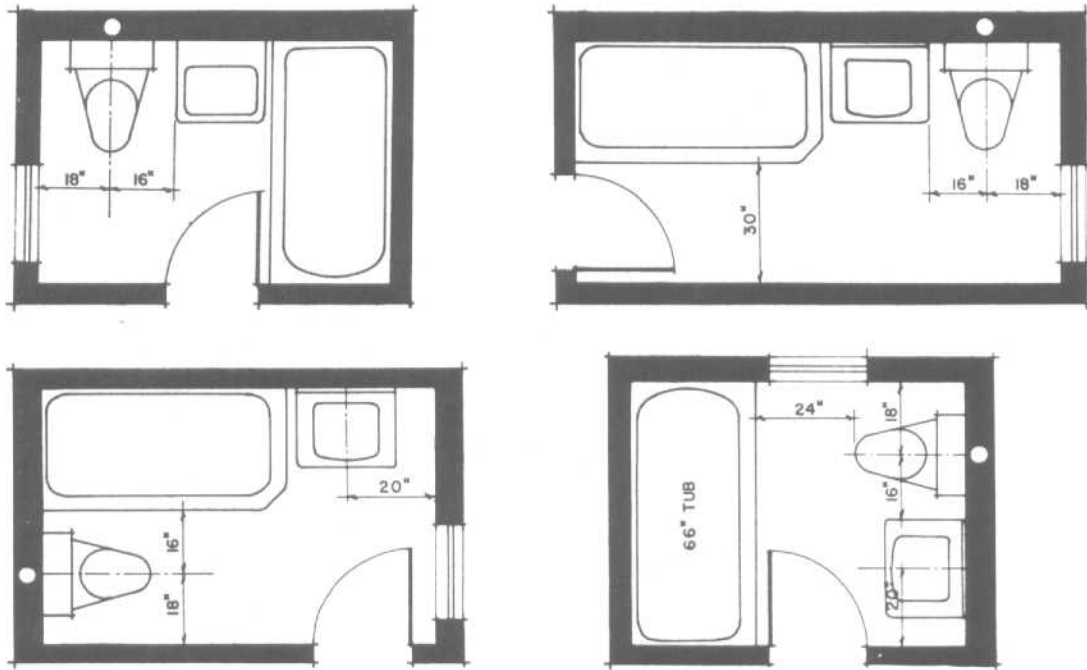


Fig. 4 Three-fixture plans: water closet, washbasin and tub.

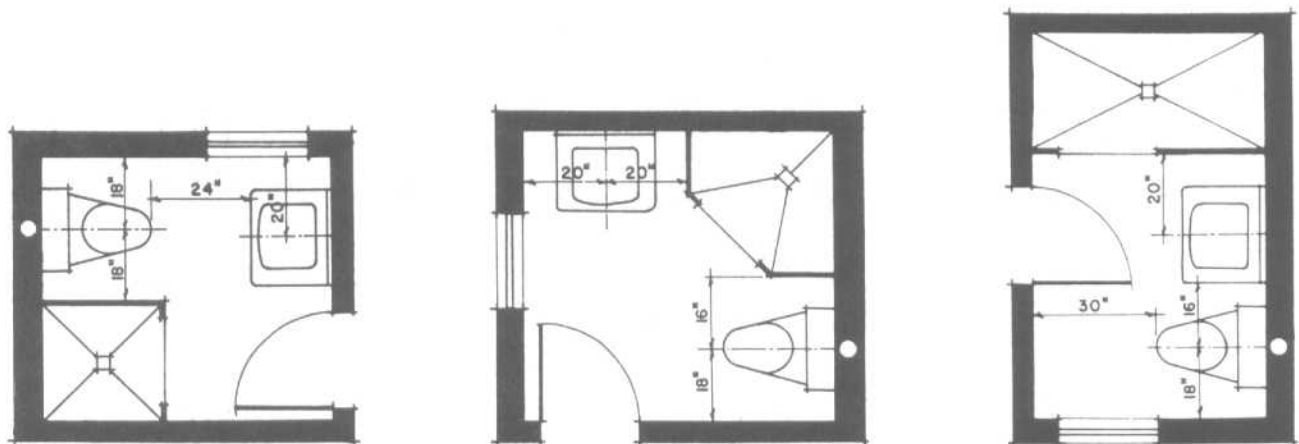


Fig. 5 Two- and three-fixture noncompartmented plans: water closet, washbasin, and shower.



**BATHROOMS**

Typical Plans and Fixture Arrangements

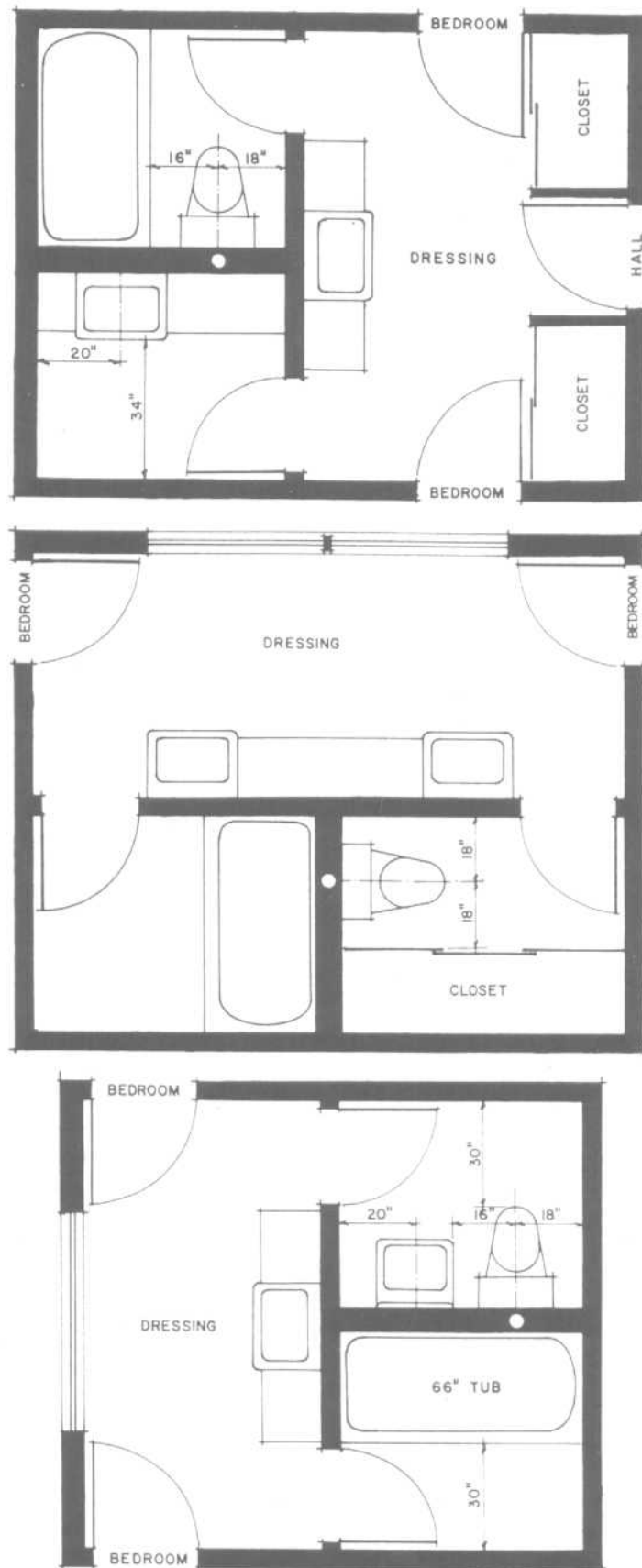
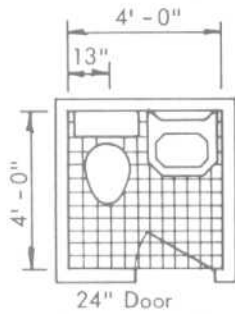


Fig. 6 Four-fixture compartmented plans: water closet, tub, and two washbasins.

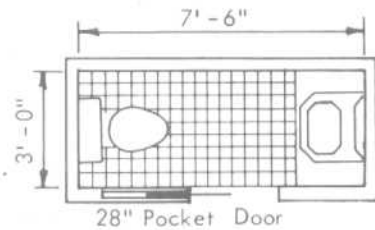
**BATHROOMS**

Typical Plans and Fixture Arrangements



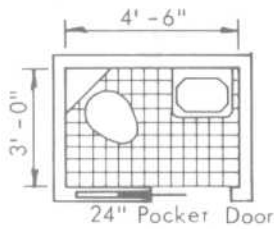
**Minimum half-bath.**

16 ft<sup>2</sup> is about minimum for standard fixtures; 4'-6" x 4'-6" gives a more spacious feeling.



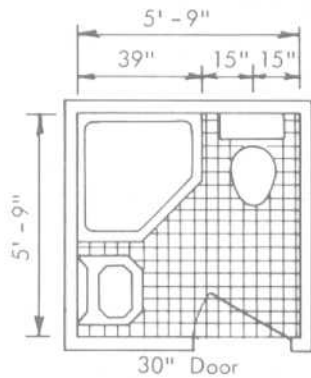
**Generous half-bath.**

22.5 ft<sup>2</sup> is a generous half-bath. A wall-hung lavatory instead of a vanity squeezes into 2'-6" width and 16.3 ft<sup>2</sup>.



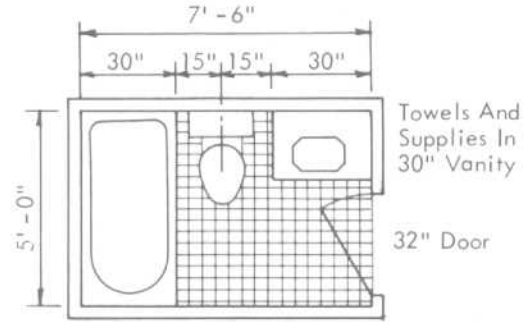
**Corner toilet in a half-bath.**

A corner toilet and a small lavatory fit 13.5 ft<sup>2</sup>. Consider this idea for installing a half-bath in a closet or under a stairway.



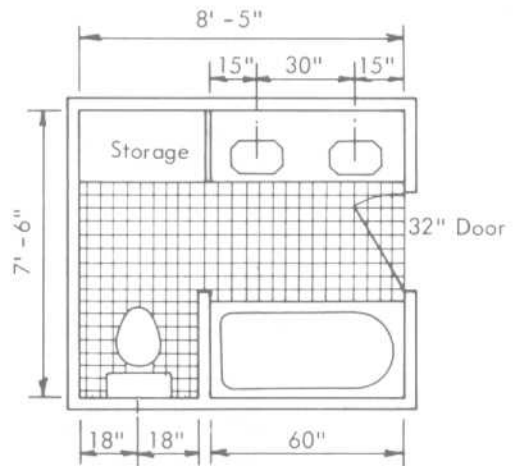
**Corner shower.**

A corner shower, toilet, and lavatory fit in 33 ft<sup>2</sup>. Very little storage space available.



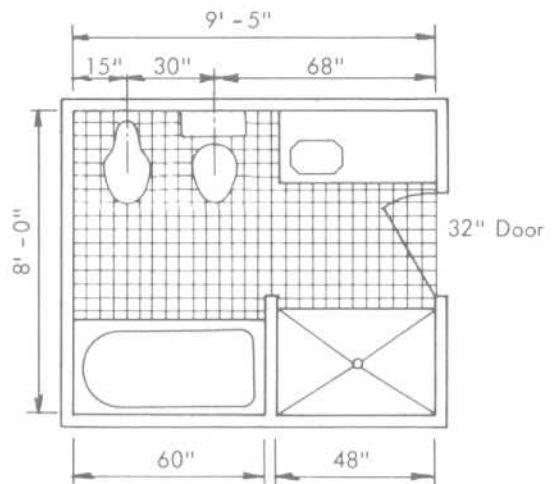
**Small, 3-fixture bathroom.**

A small 3-fixture bathroom with limited storage in a built-in vanity meets basic bathroom requirements in a space 37.5 ft<sup>2</sup>. The door is 32" wide for a person with a cane or crutches. This bathroom is too small for a wheelchair.



**Two-lavatory bathroom.**

A 2-lavatory bathroom with adequate room at the toilet and each lavatory. Note storage space under the lavatories and in a floor-to-ceiling unit. Area: 63 ft<sup>2</sup>.



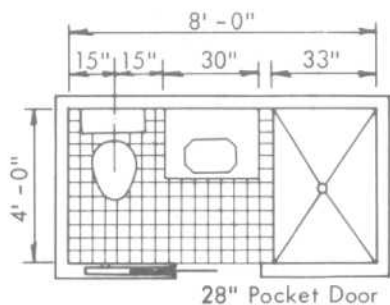
**Separate tub and shower.**

This plan also includes a bidet. Storage is in the 48" long vanity. Area: 75.3 ft<sup>2</sup>.

Fig. 7 A wide array of two-, three-, four-, and five-fixture toilet plans.

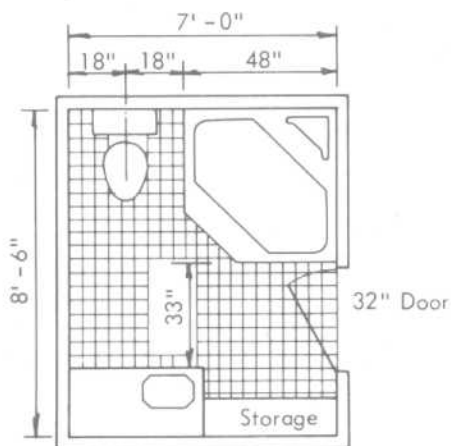
**BATHROOMS**

Typical Plans and Fixture Arrangements



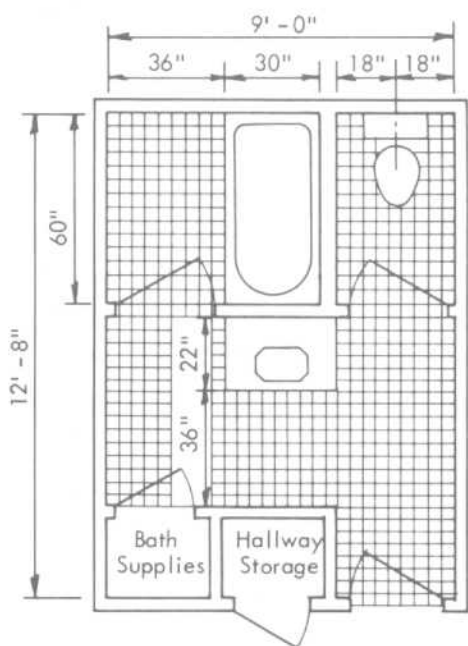
**Large shower.**

A generous 33"x48" shower is featured in this 32 ft<sup>2</sup> bathroom. Storage is under the 30" vanity and on shelves over the toilet.



**Corner square tub.**

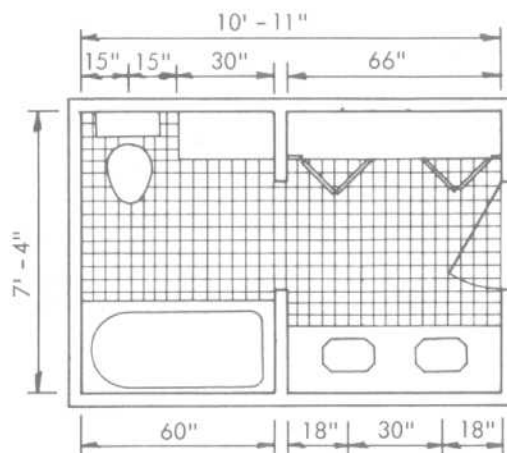
Although not usually a space saver, a square tub fits some situations better than a rectangular one. This 3-fixture bathroom has excellent storage but is only 59.5 ft<sup>2</sup>.



**Large 3-fixture bathroom.**

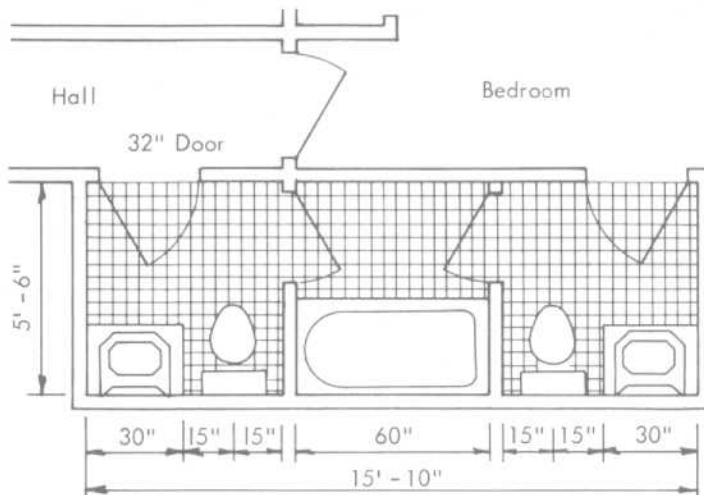
With fixtures in separate compartments, this layout can replace a second bath by accommodating more than one person at a time. It is as large as two bathrooms but costs less because of fewer fixtures and less plumbing. Area: 106 ft<sup>2</sup> plus hallway storage.

Fig. 7 (Continued)



**Four-fixture, two compartments.**

Three people can use this bathroom at the same time. Consider a pocket door between the compartments. Even with generous storage space it takes only the same space as many non-compartmented bathrooms, about 80.5 ft<sup>2</sup>.



**Five fixtures, three compartments.**

This bathroom serves as two full bathrooms in 87 ft<sup>2</sup>. Two doors to each compartment are undesirable. Limited storage space available.

BATHROOMS

Custom Designs



Fig. 8 A variety of design possibilities for the more customized bathroom.

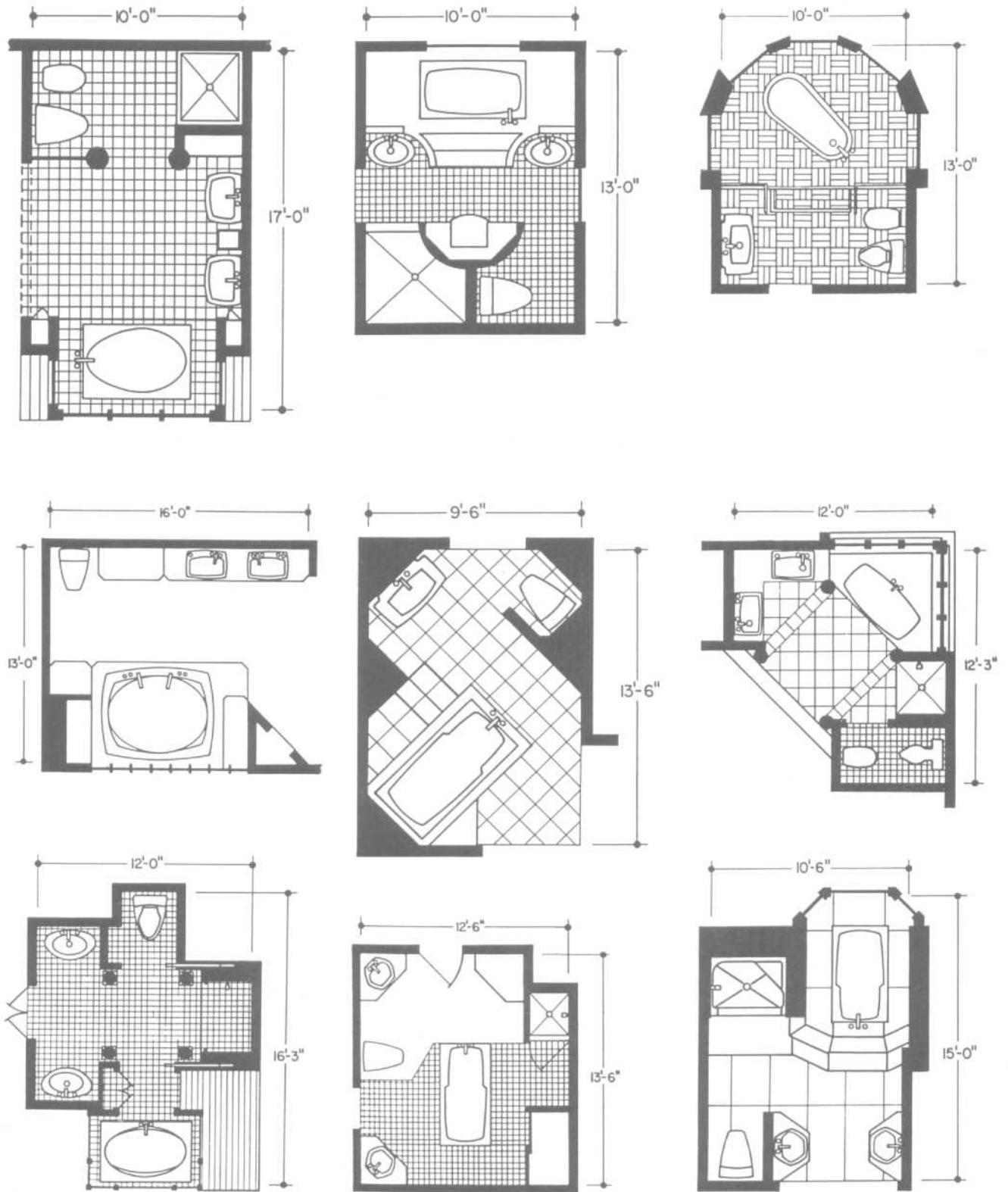


Fig. 8 (Continued)

BATHROOMS

Custom Designs

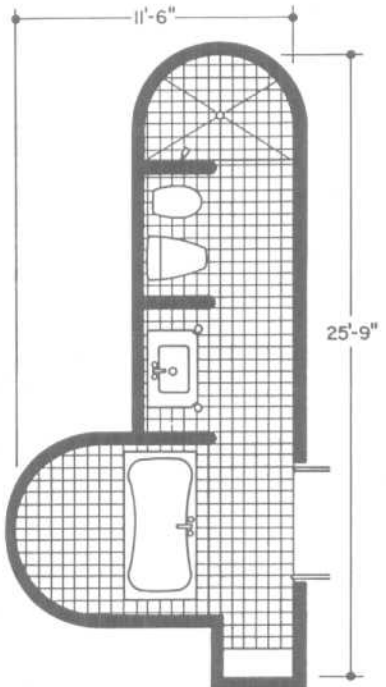
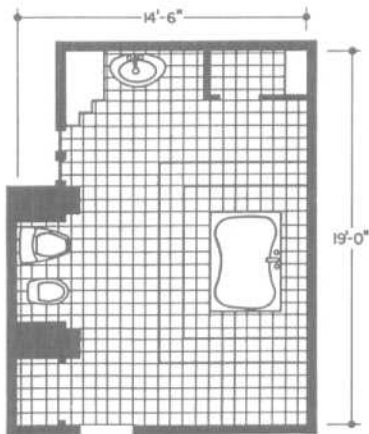
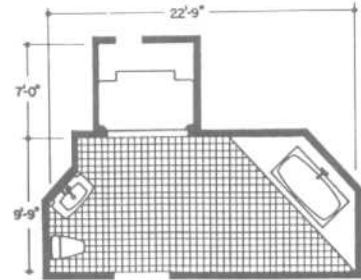
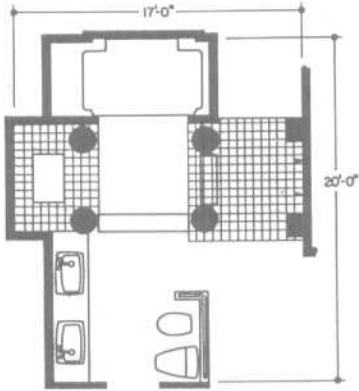
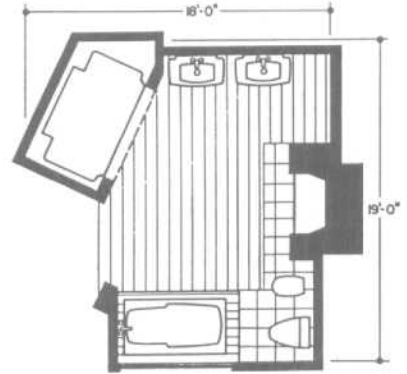
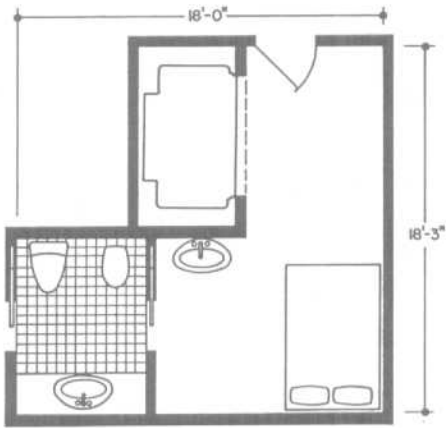


Fig. 8 (Continued)

BATHROOMS

Lavatory Types and Dimensions

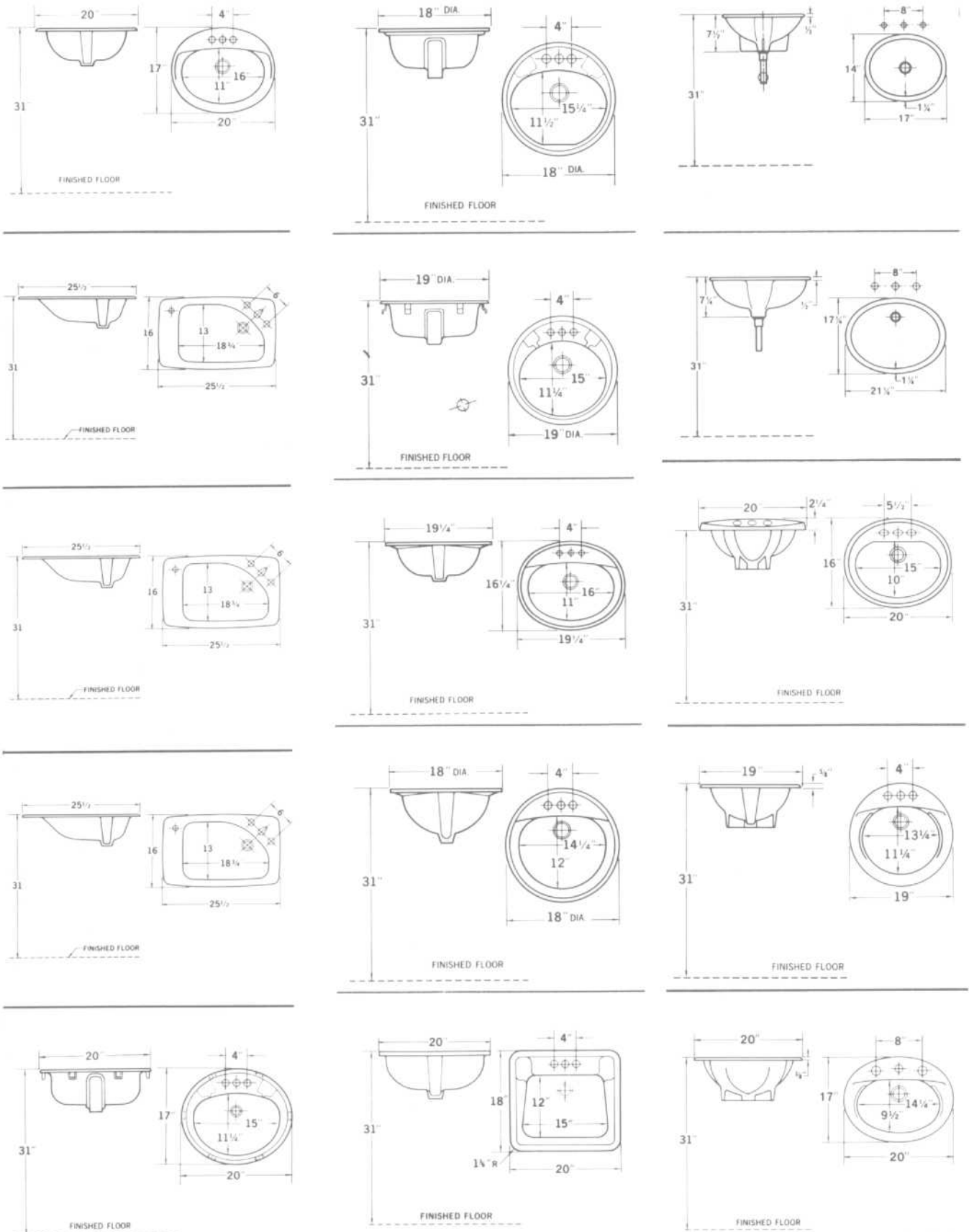
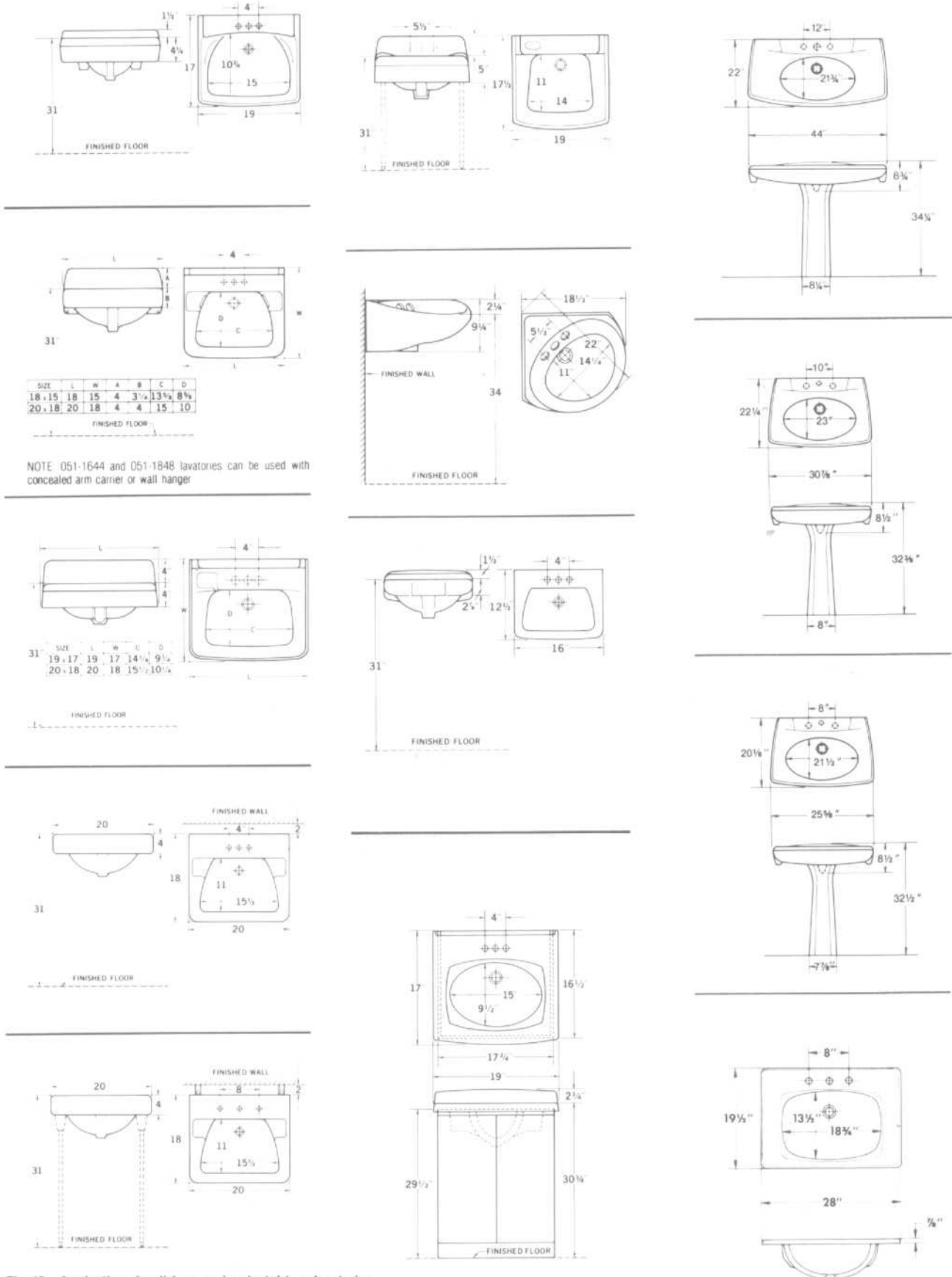


Fig. 9 A selection of countertop lavatories.



**BATHROOMS**

Lavatory Types and Dimensions



NOTE: 051-1644 and 051-1848 lavatories can be used with concealed arm carrier or wall hanger

Fig. 10 A selection of wall-hung and pedestal-type lavatories.

BATHROOMS

Lavatory Types and Dimensions

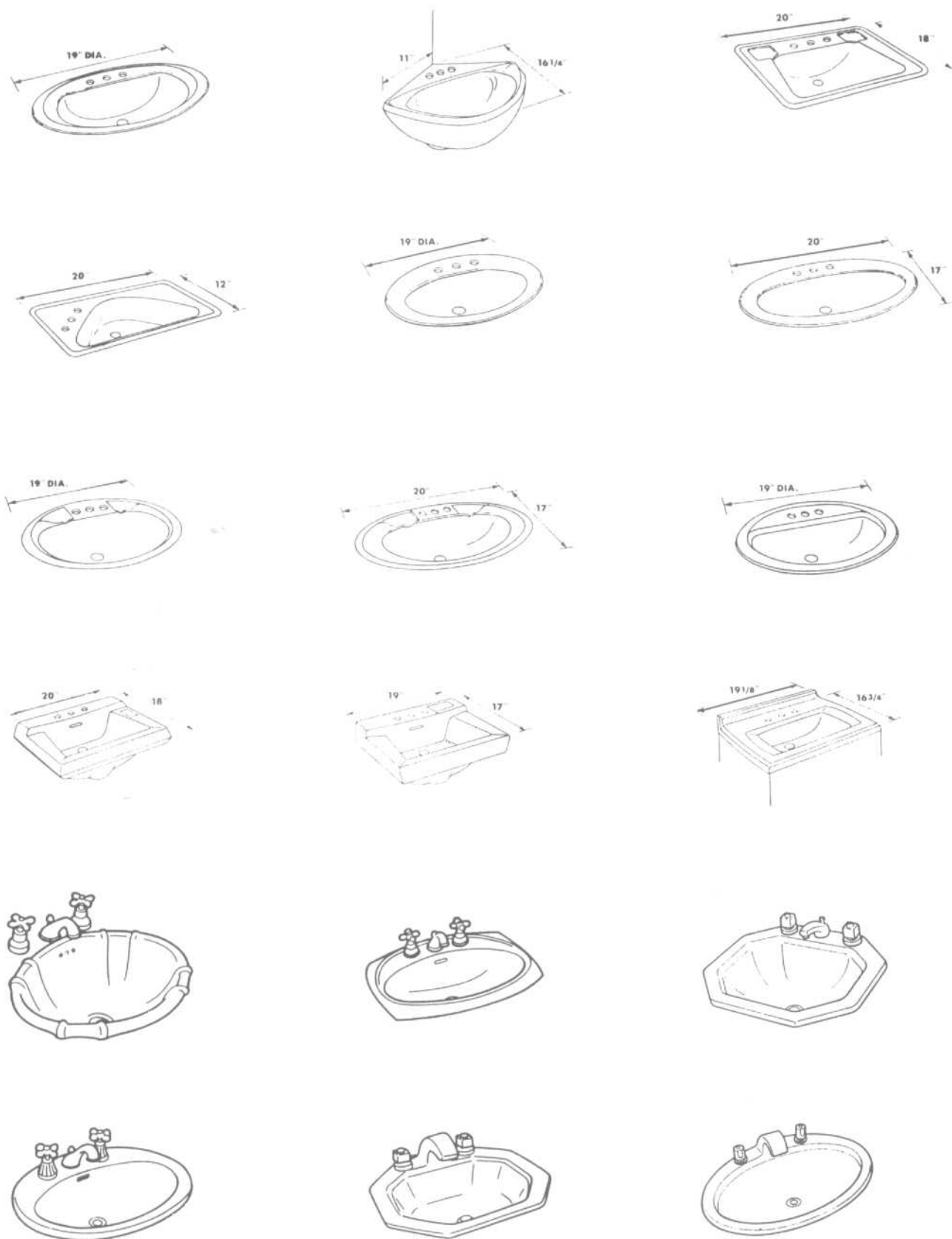


Fig. 11 Another selection of lavatories.

BATHROOMS

Lavatory Types and Dimensions

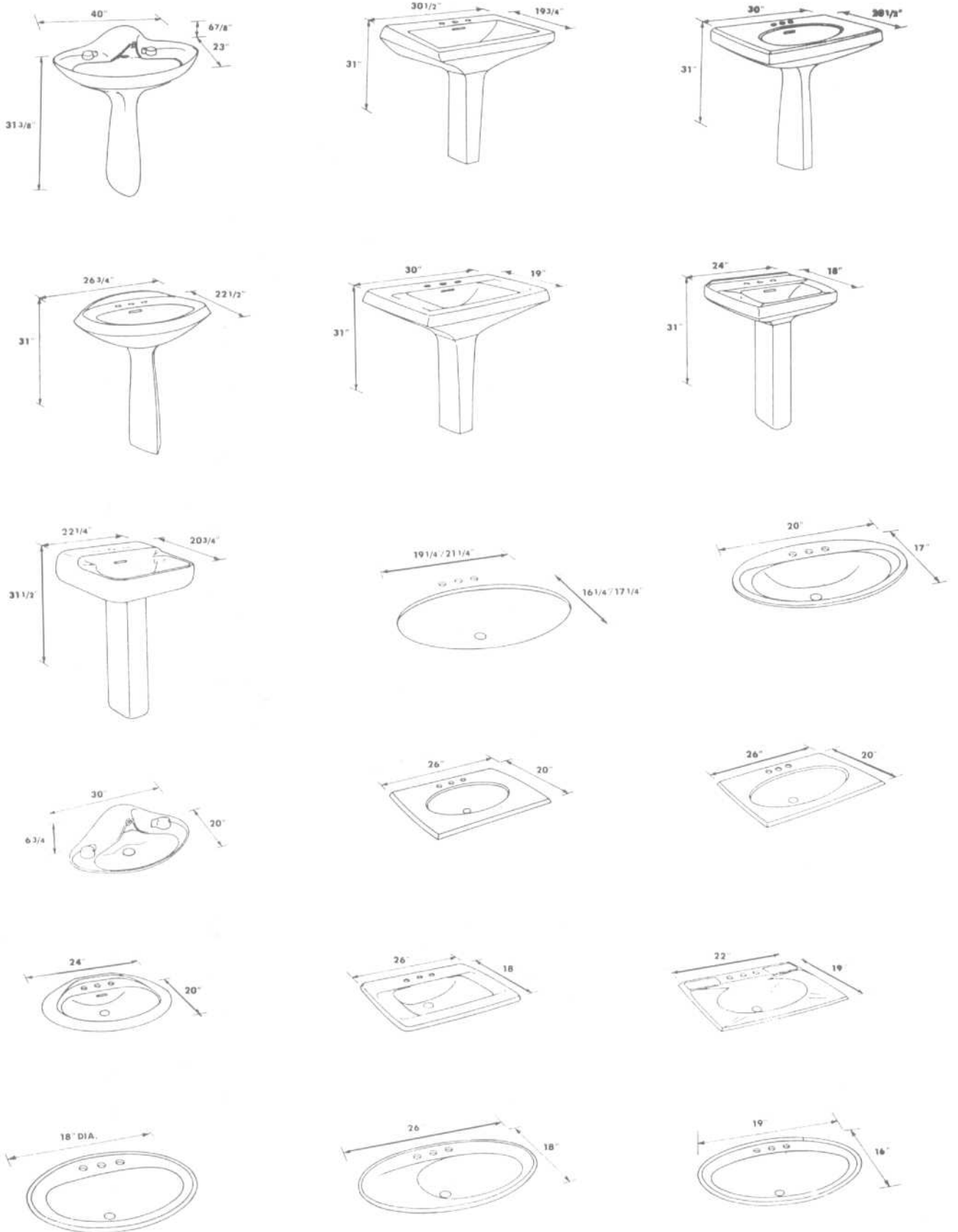


Fig. 11 (Continued)

BATHROOMS

Whirlpool Types and Dimensions

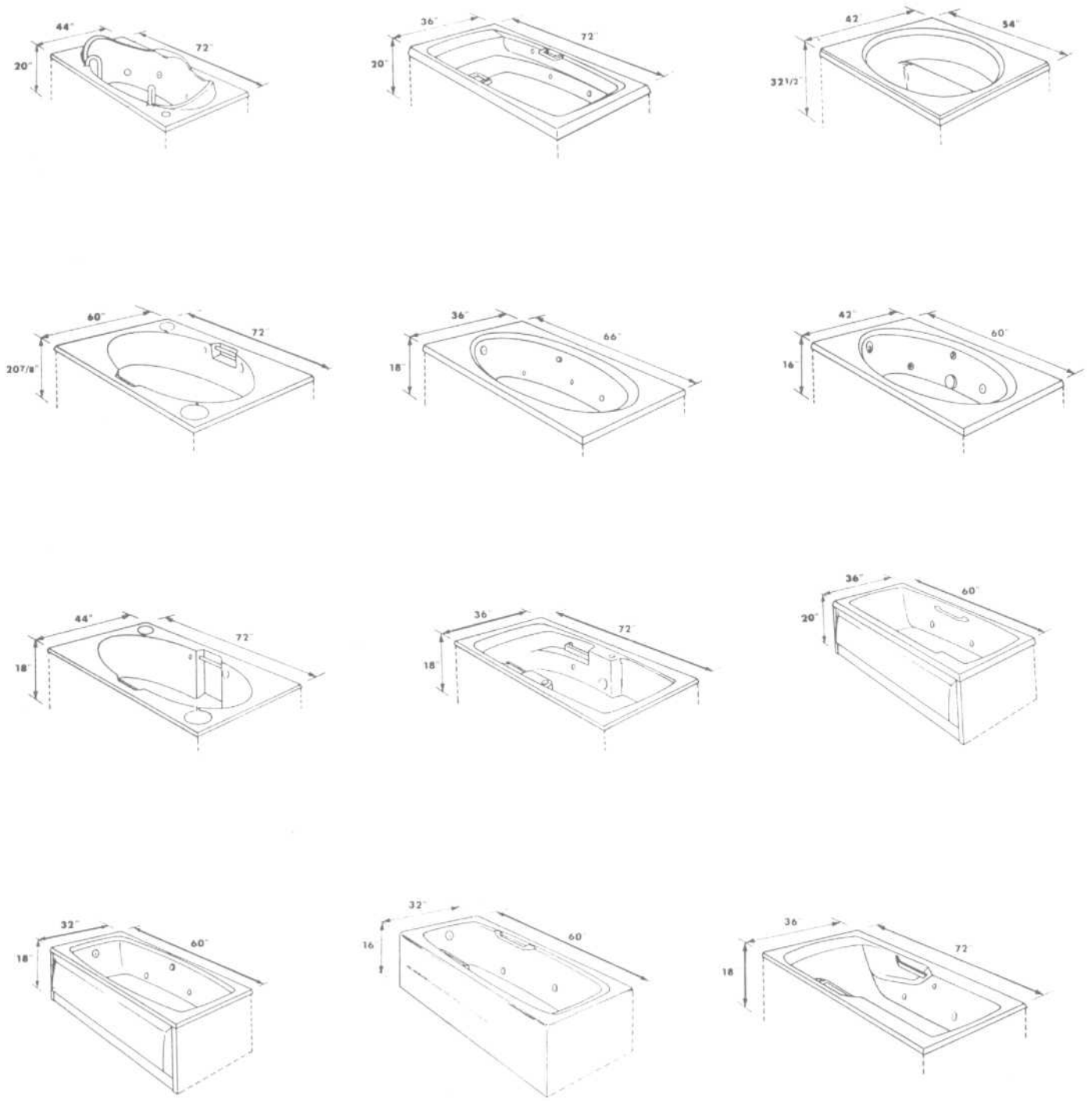
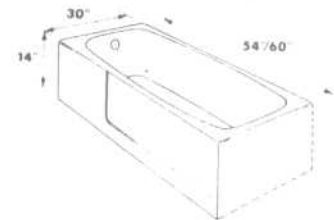
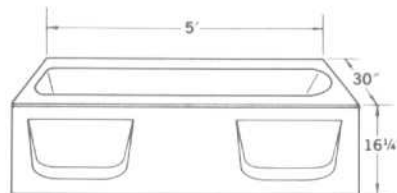
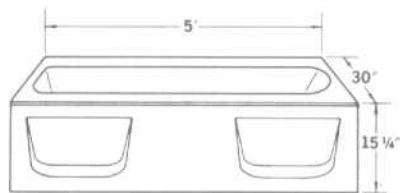
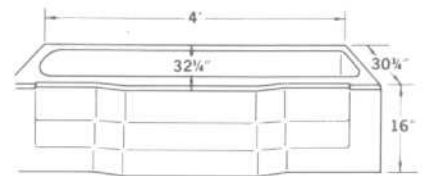
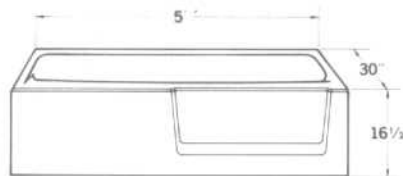
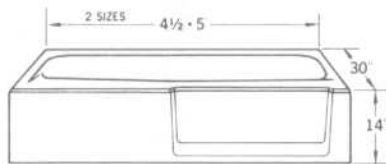
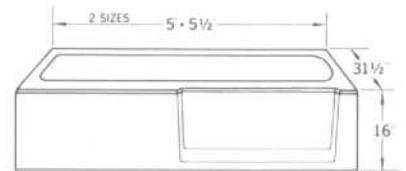
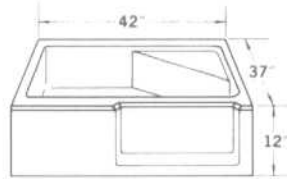
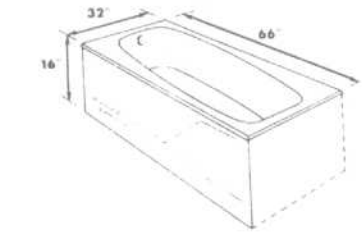


Fig. 12 A selection of whirlpool baths.

BATHROOMS

Bathtub Types and Dimensions



Dimensions: 42" x 37" x 12"



Dimensions: 60" x 31 1/2" x 16"



Dimensions: 60" x 31 1/2" x 16"

Fig. 13 A selection of standard baths.

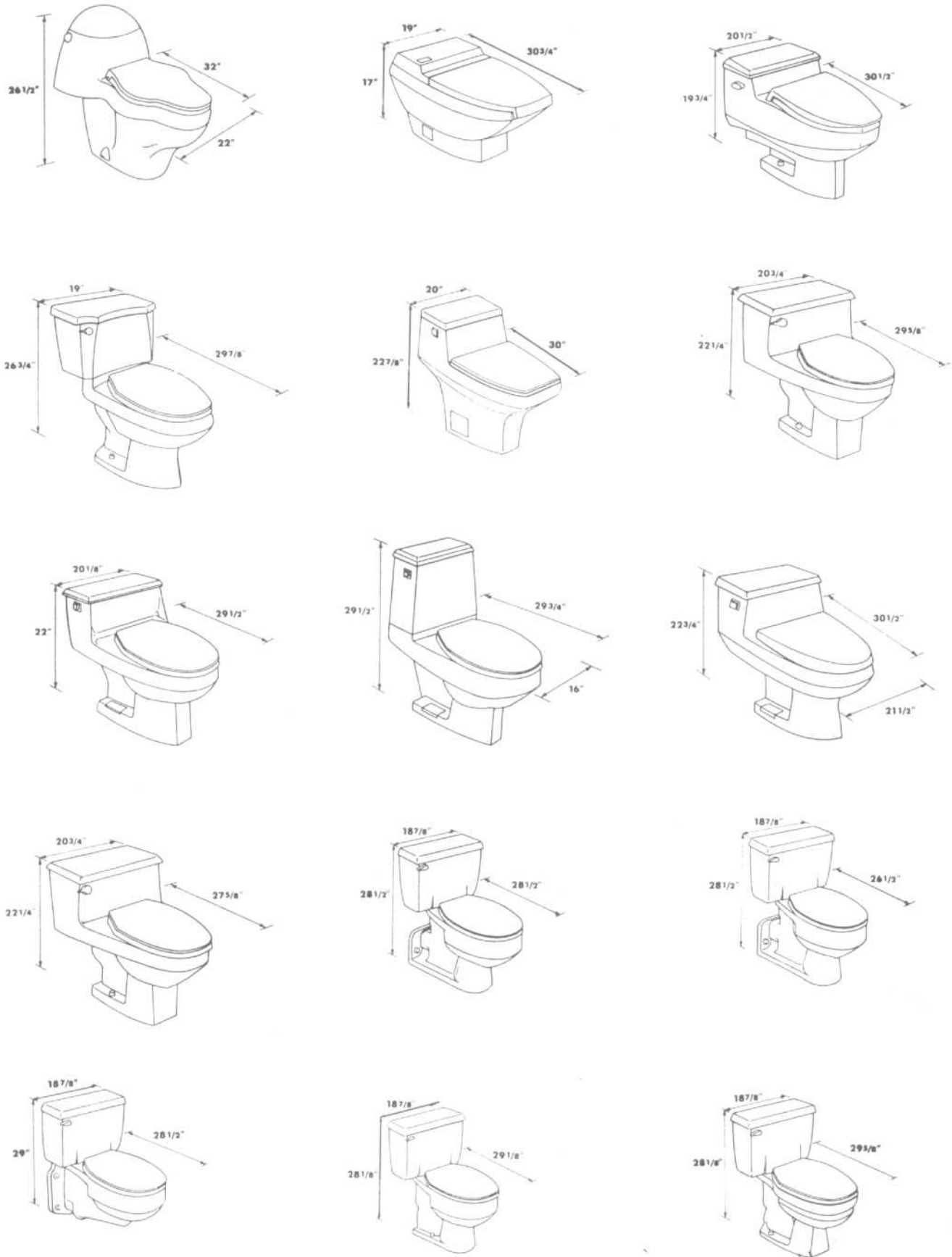


Fig. 14 A selection of waterclosets.

**BATHROOMS**

Bidet Types and Dimensions

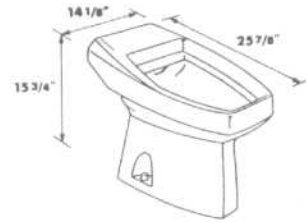
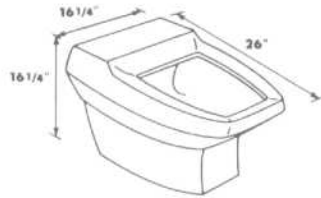
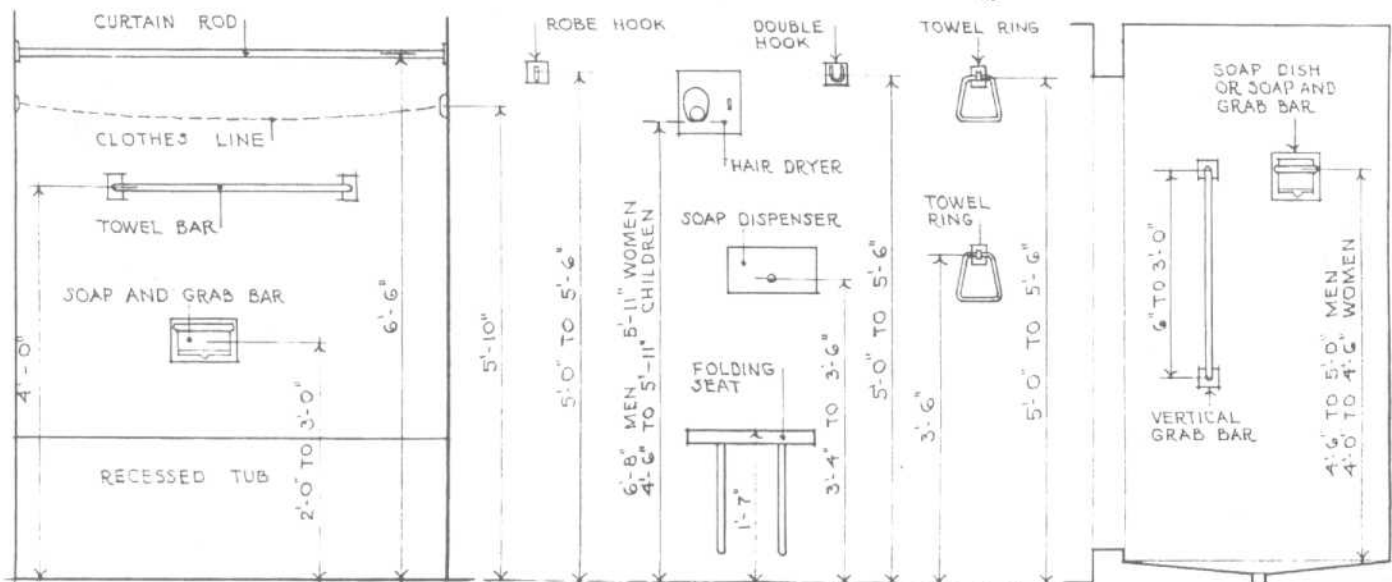
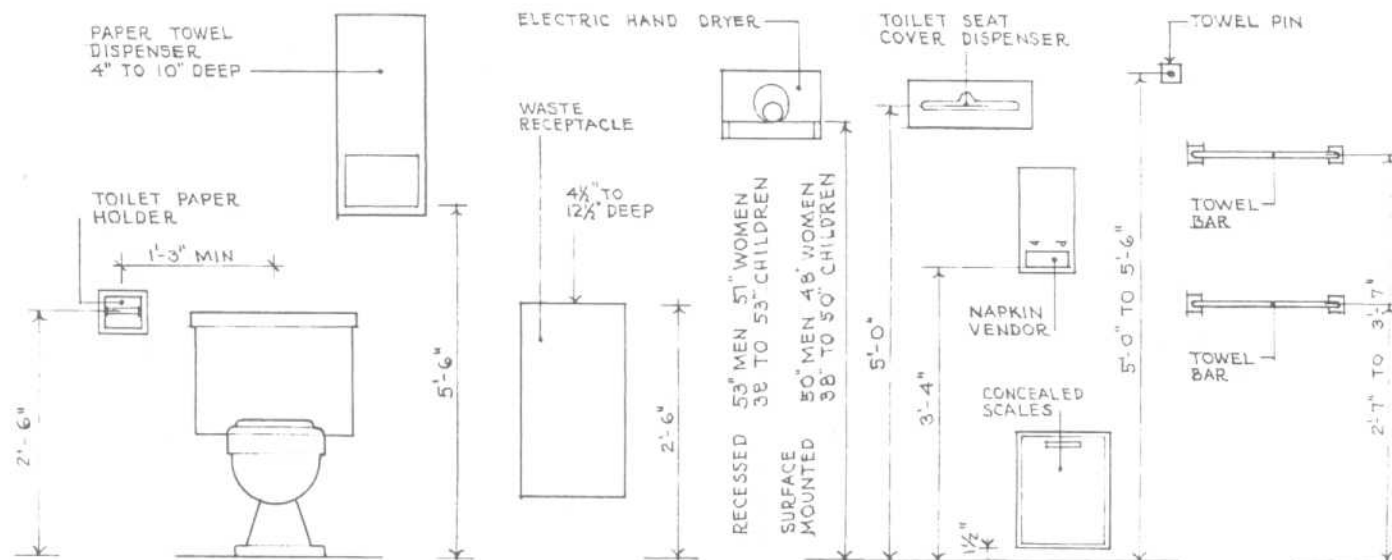
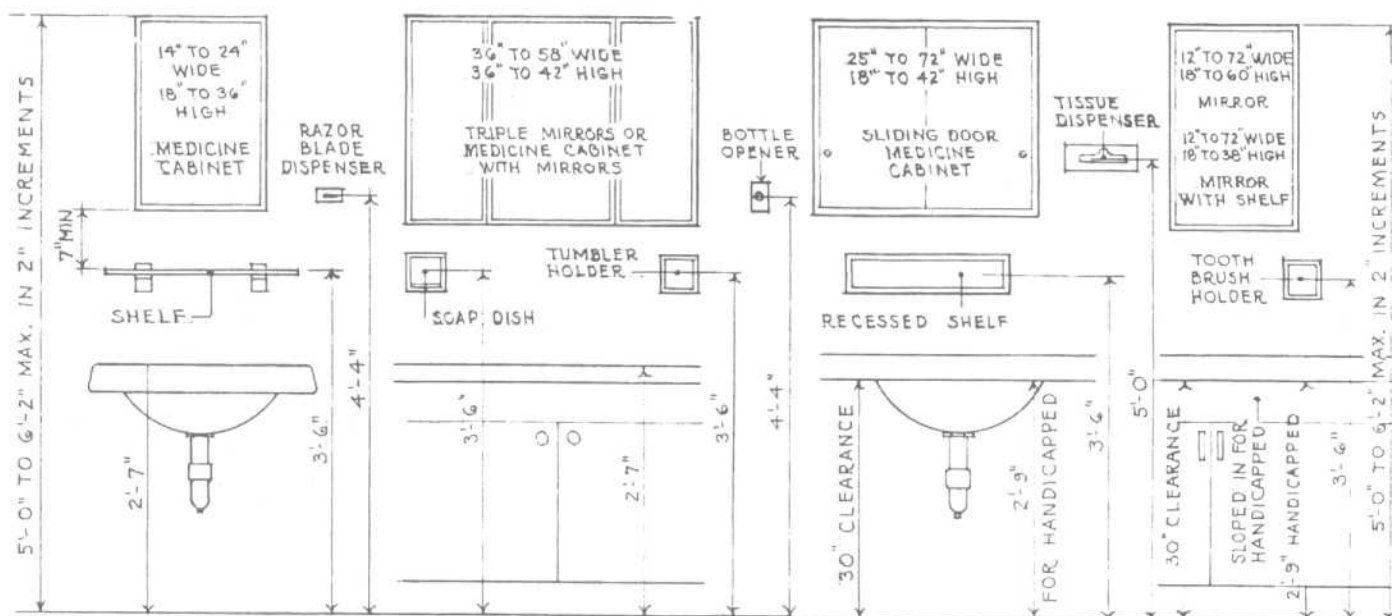


Fig. 15 A selection of bidets.



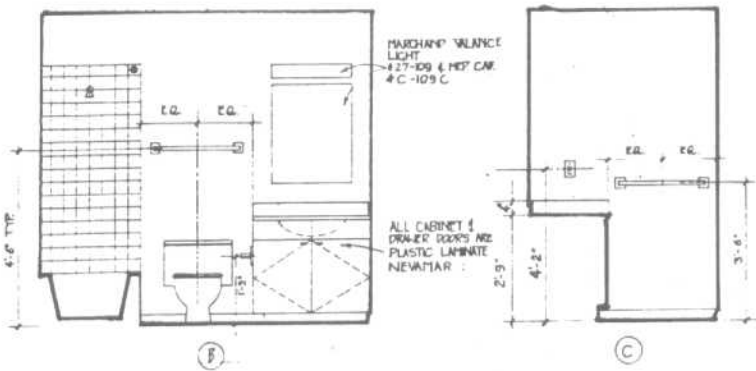
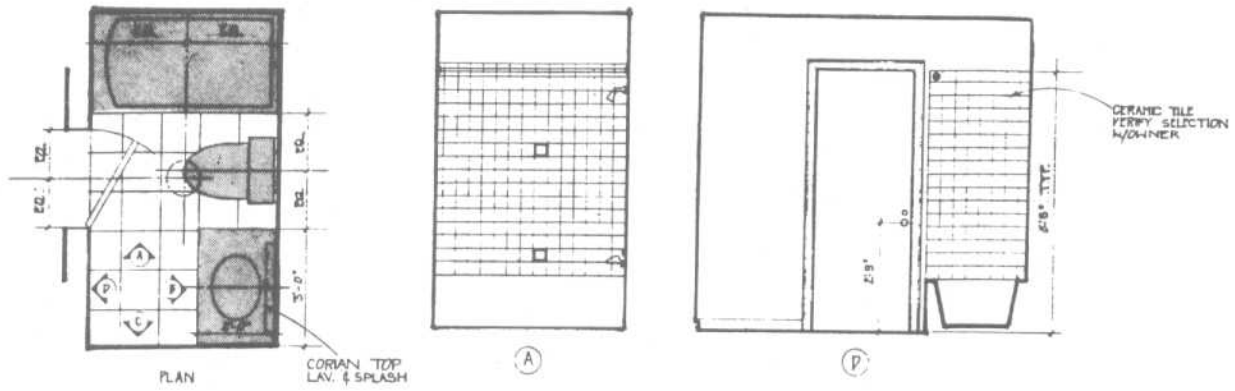
**BATHROOMS**

Accessories

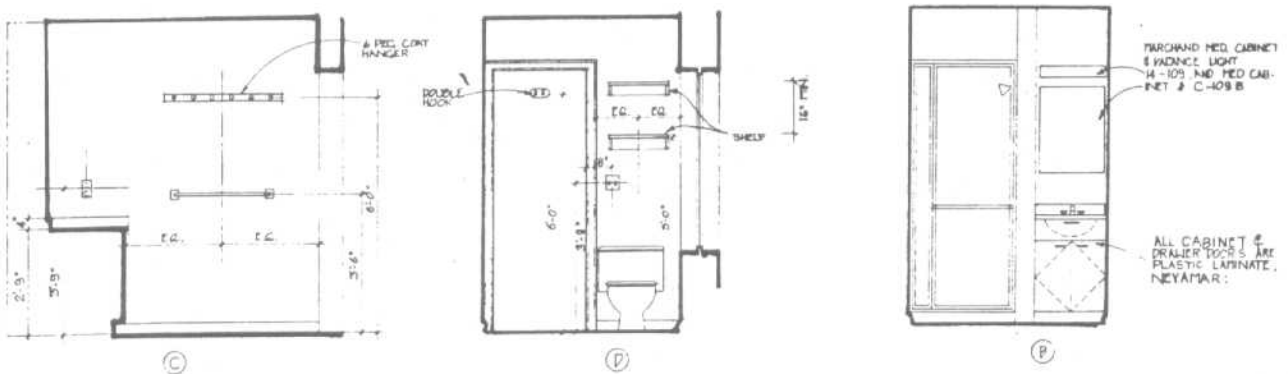
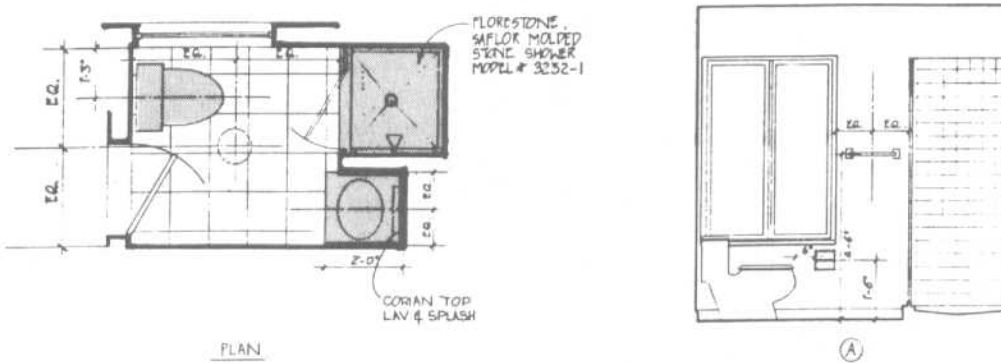


BATHROOMS

Plans, Elevations, and Details



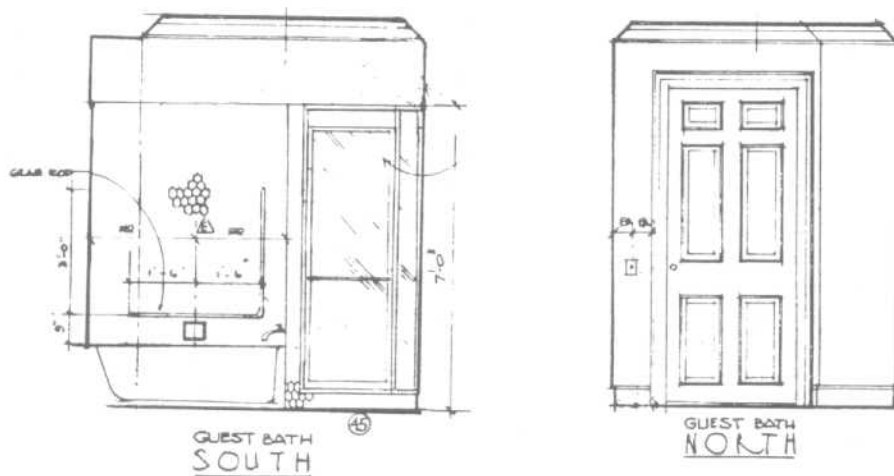
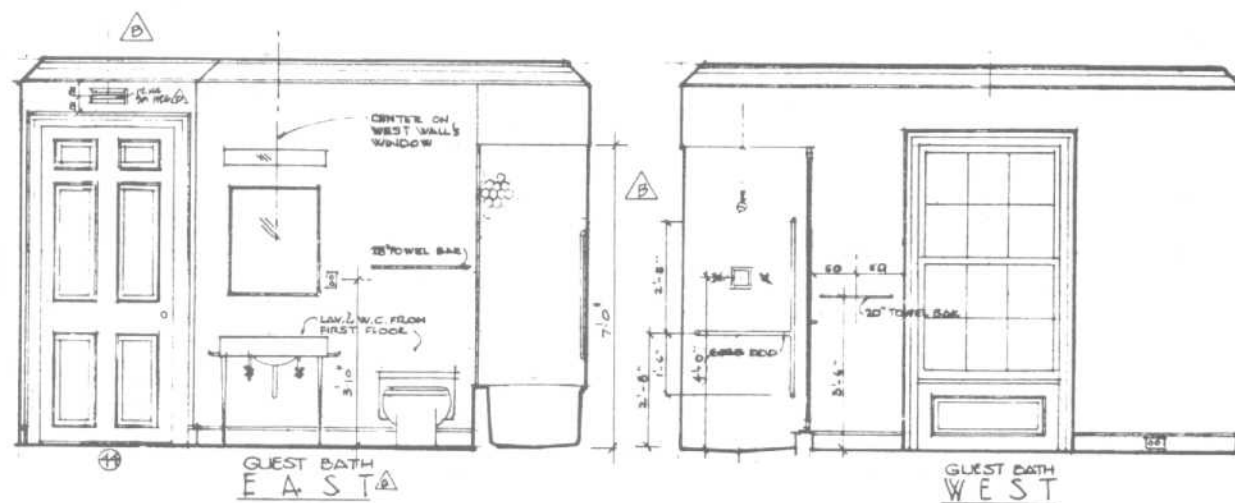
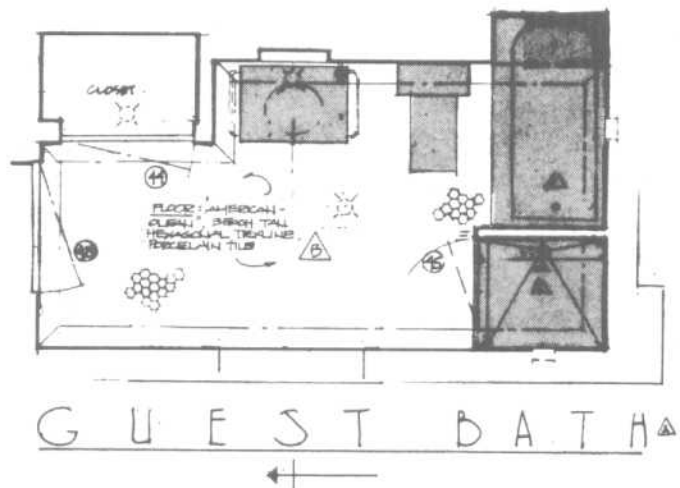
Three-fixture bathroom with tub



Three-fixture bathroom with shower

BATHROOMS

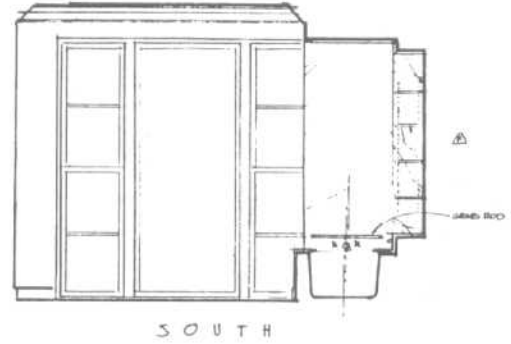
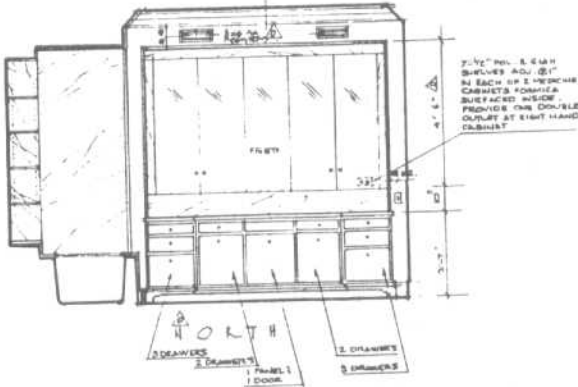
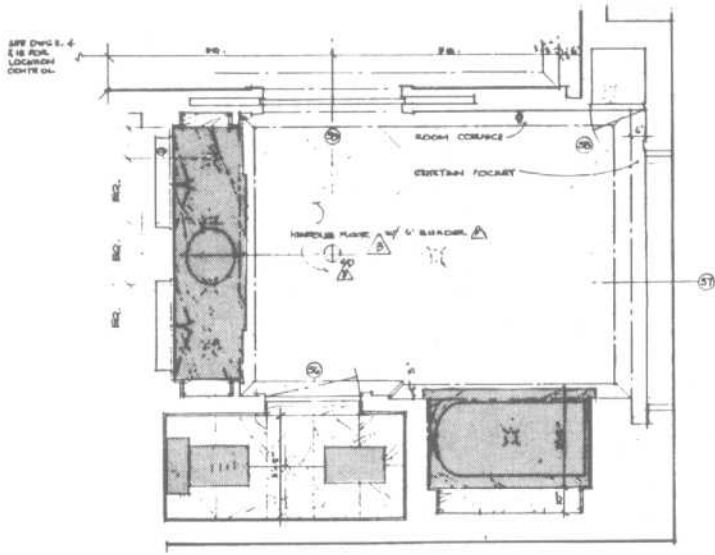
Plans, Elevations, and Details



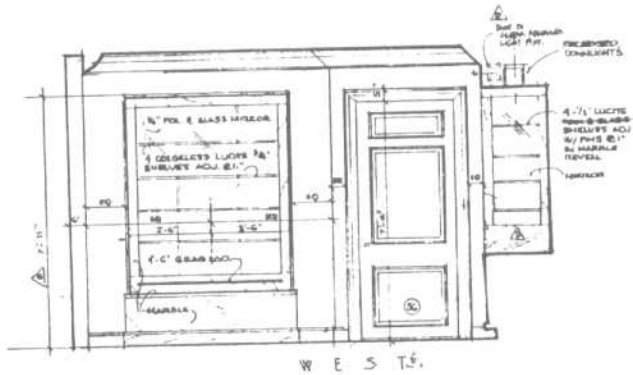
Four-fixture bathroom with tub and shower

**BATHROOMS**

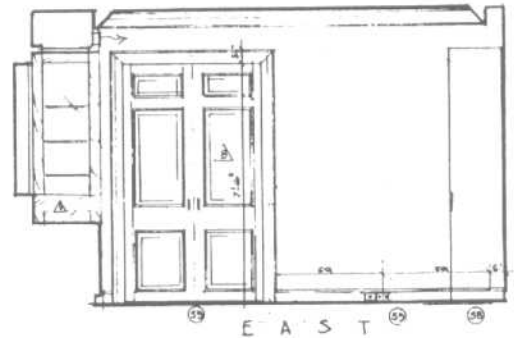
Plans, Elevations, and Details



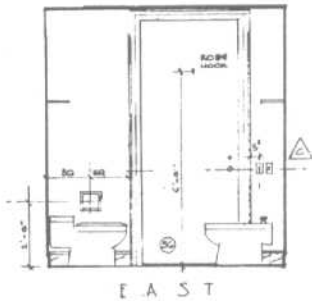
SOUTH



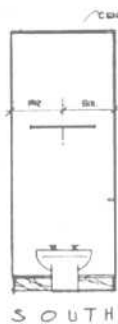
WEST



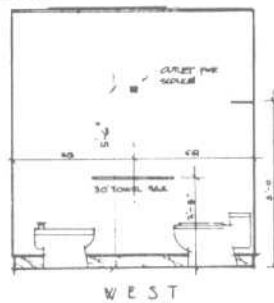
EAST



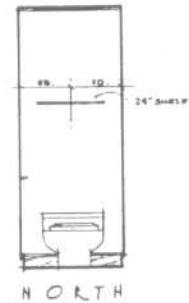
EAST



SOUTH

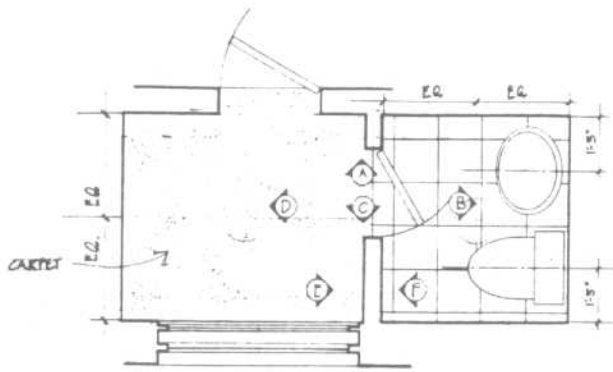


WEST

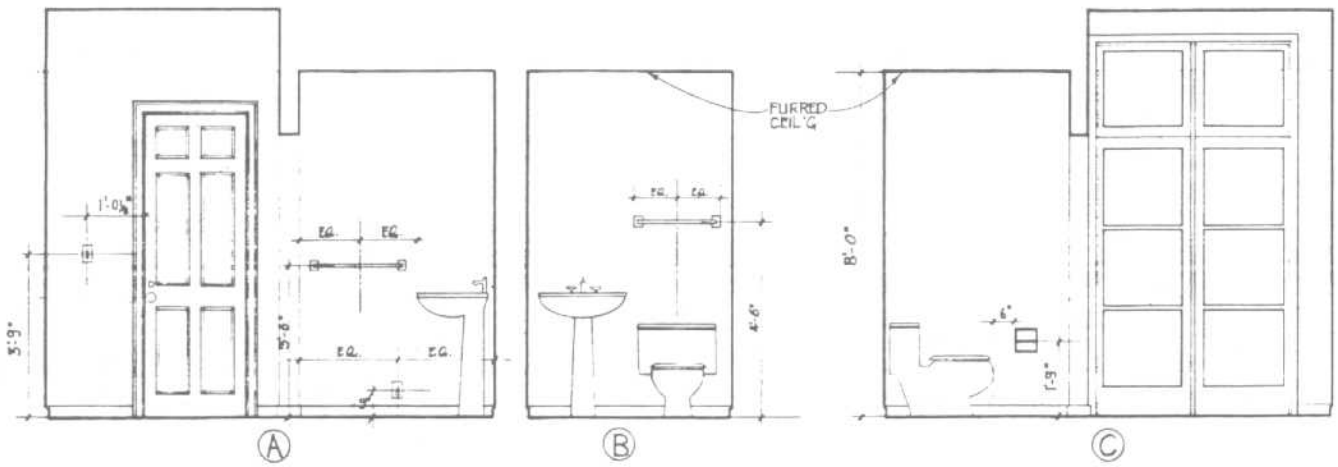


NORTH

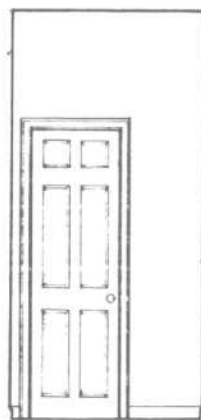
Four-fixture bathroom with bidet and tub



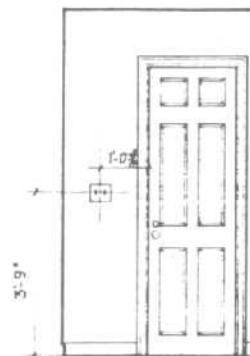
PLAN



D



E

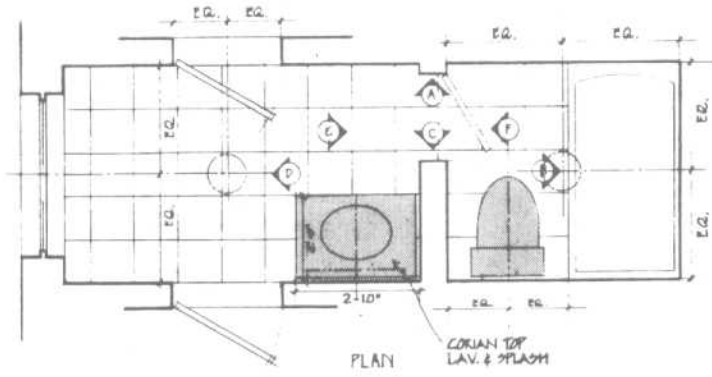


F

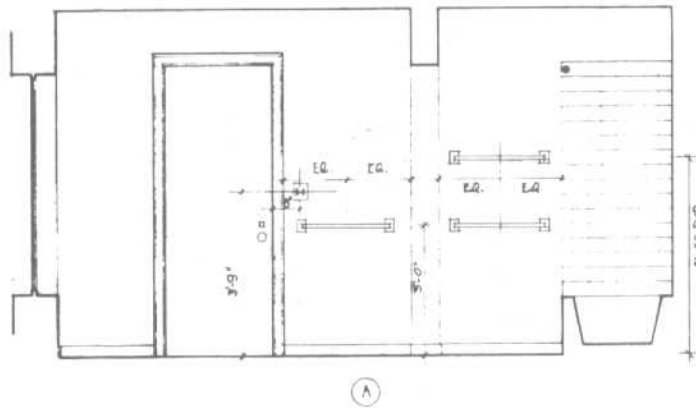
Powder room

**BATHROOMS**

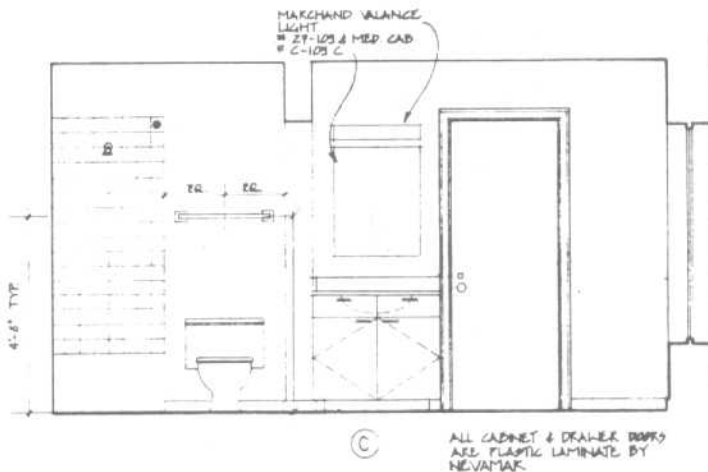
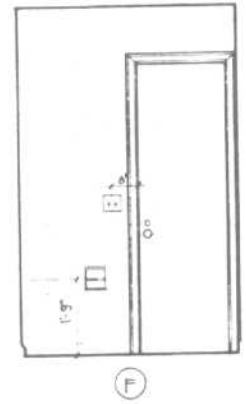
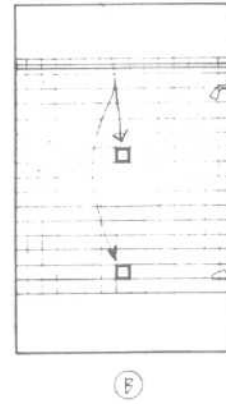
Plans, Elevations, and Details



BATHROOM

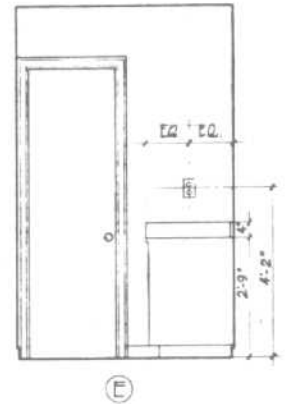
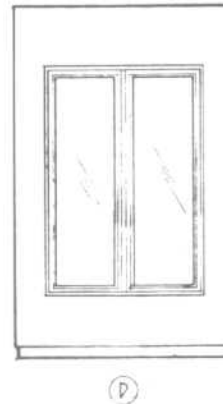


CERAMIC SOAP DISH  
 12" MATCH TILE  
 (CONSULT OWNER)



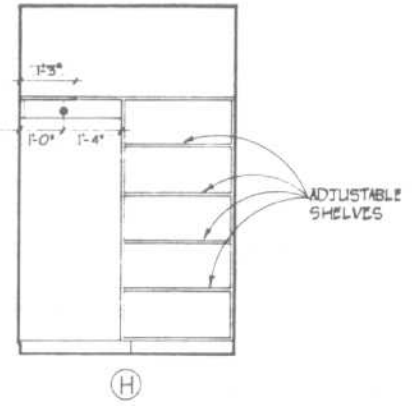
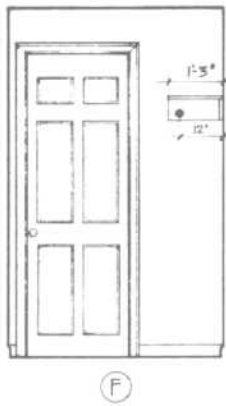
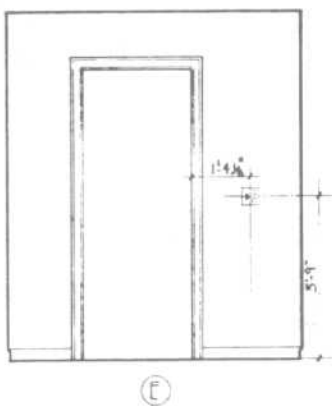
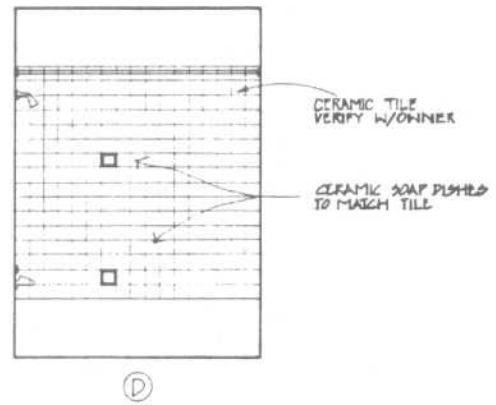
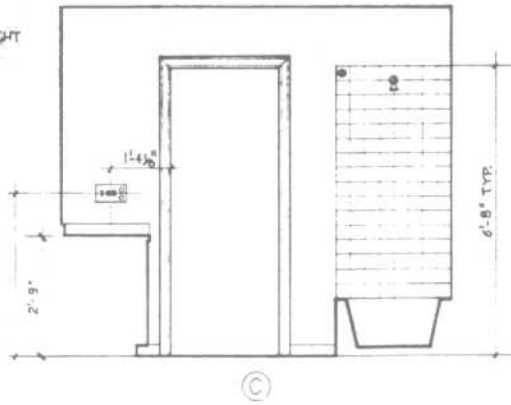
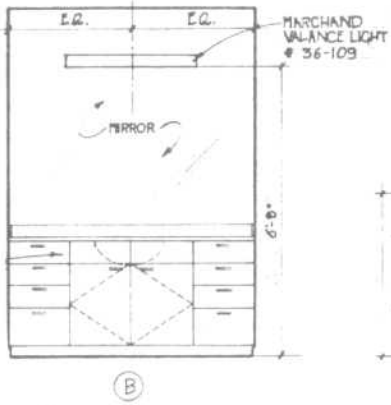
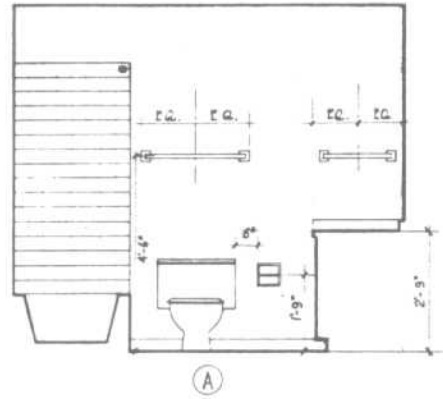
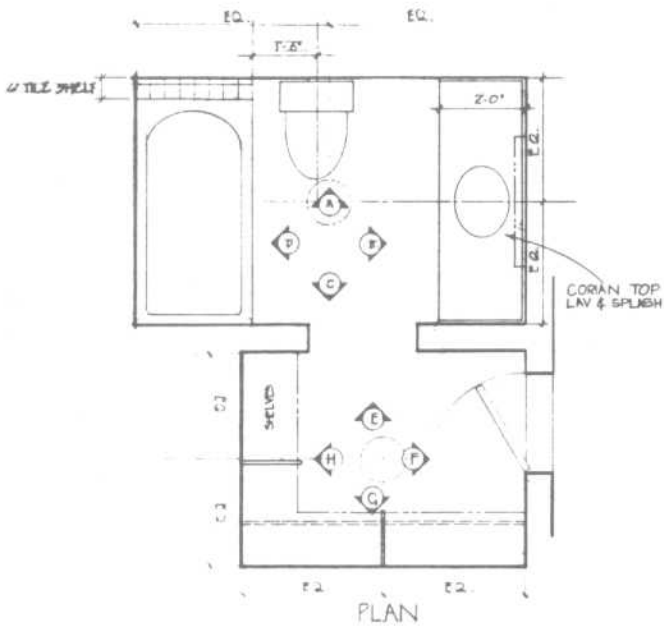
MARKET VALANCE  
 LIGHT  
 # 27-105 & MED CAB  
 # C-105 C

ALL CABINET & DRAWER DOORS  
 ARE PLASTIC LAMINATE BY  
 NEVAMAR



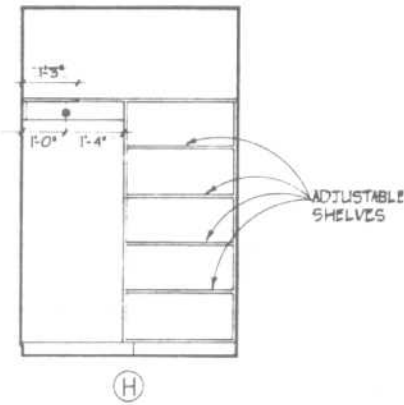
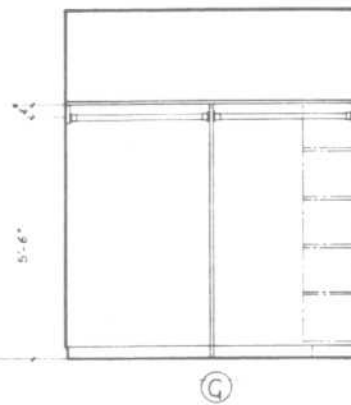
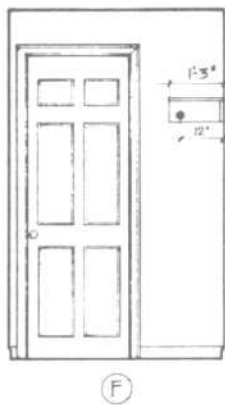
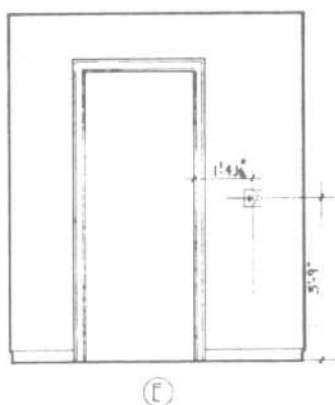
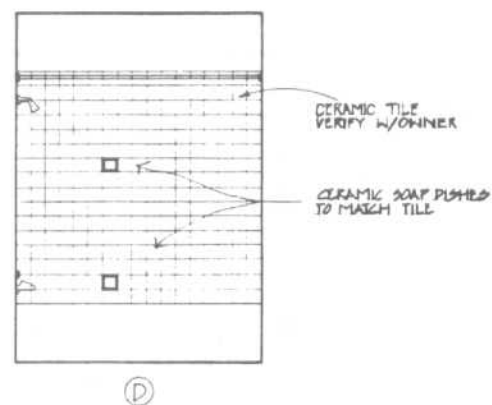
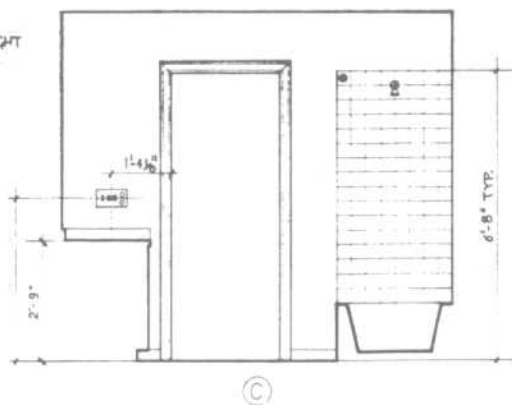
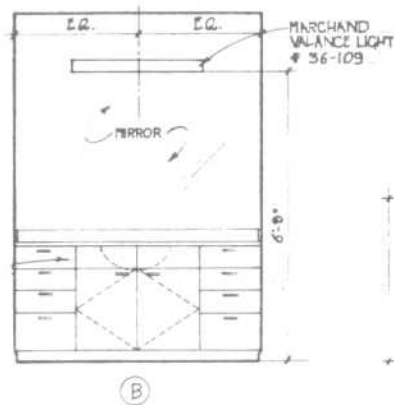
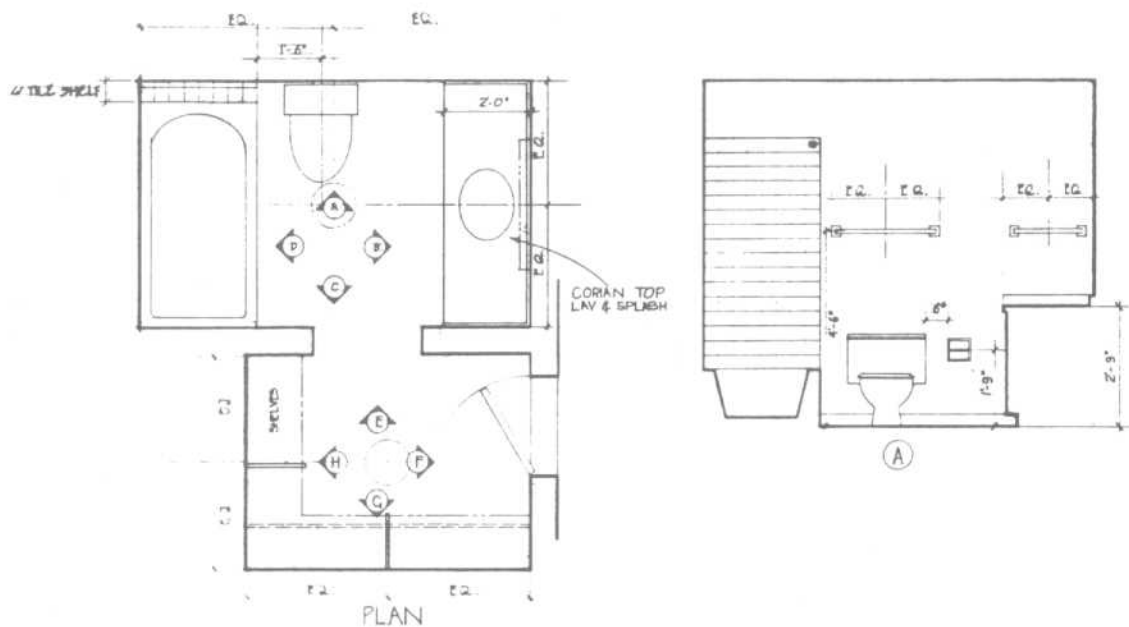
**BATHROOMS**

Plans, Elevations, and Details



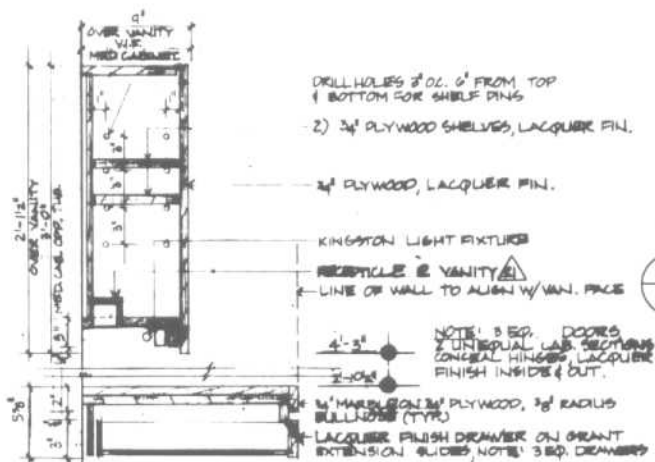
BATHROOMS

Plans, Elevations, and Details

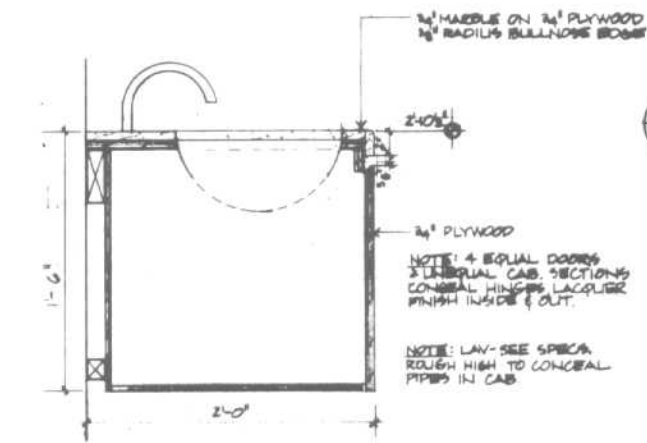


Her bathroom

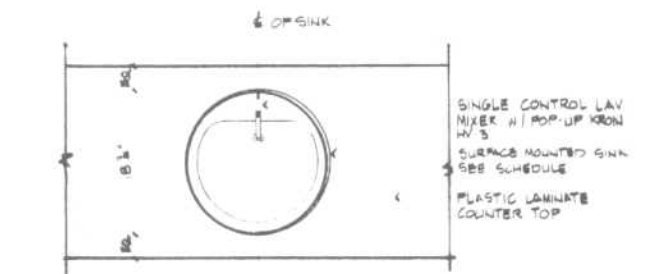




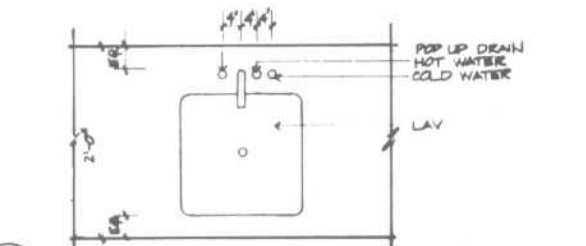
18 MAKE UP VANITY & CAB ABOVE/MEDICINE CAB. BATH I  
A6 12'-0" x 1'-0"



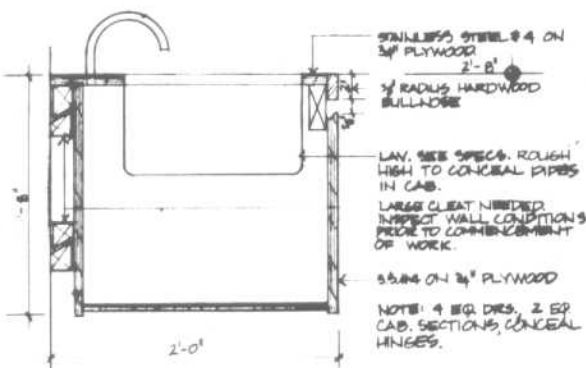
19 LAV. VANITY, BATH I  
A6 12'-0" x 1'-0"



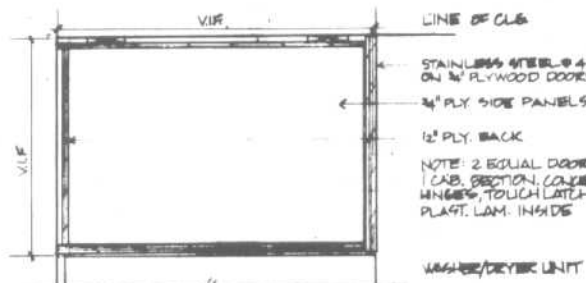
12 TYPICAL LAVATORY FITTINGS ARRANGEMENT  
A11 1'-0" x 1'-0"



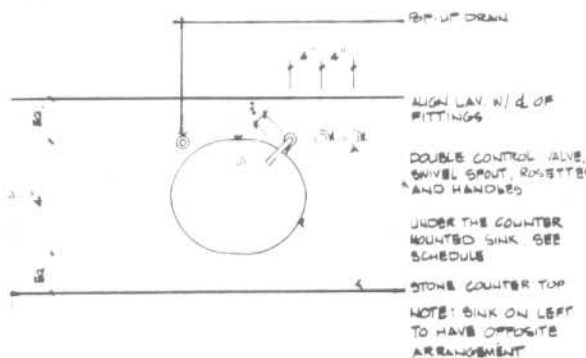
22 PLAN FITTINGS ARRANGEMENT @ LAV. BATH 2  
A6 1'-0" x 1'-0"



23 LAV. VANITY, BATH 2  
A6 12'-0" x 1'-0"



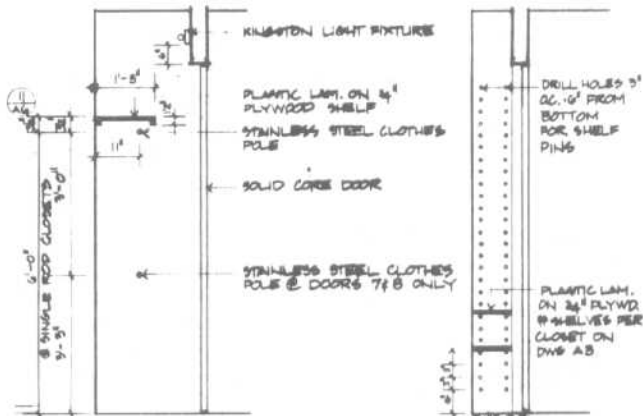
24 SECTION THRU CAB. OVER WASHER/DRYER UNIT  
A6 12'-0" x 1'-0"



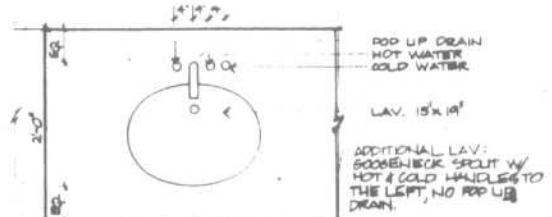
17 LAVATORY FITTING ARRANGEMENT @ BATH #1  
A11 1'-0" x 1'-0" (SIMILAR BATH #5)

BATHROOMS

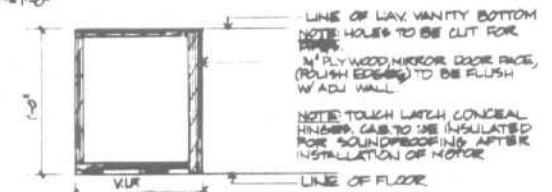
Vanities



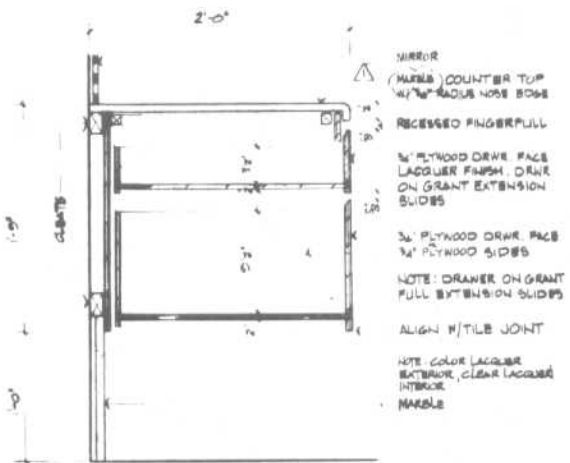
17 TYPICAL CLOSET/SHELF CLOSET  
A6



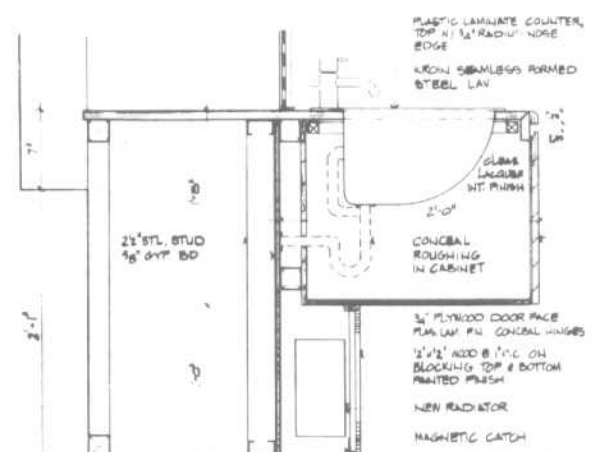
20 PLAN FITTINGS ARRANGEMENT @ LAV. BATH  
A6



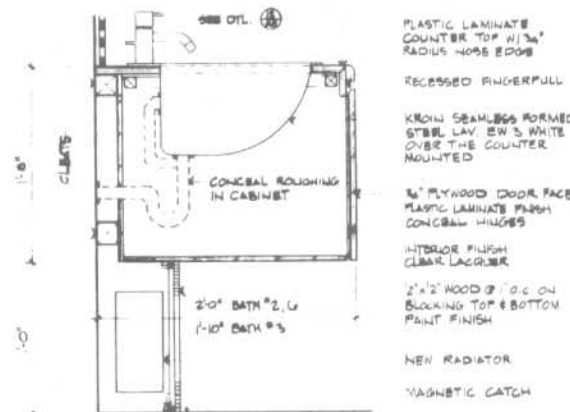
21 WHIRLPOOL MOTOR CAB.  
A6



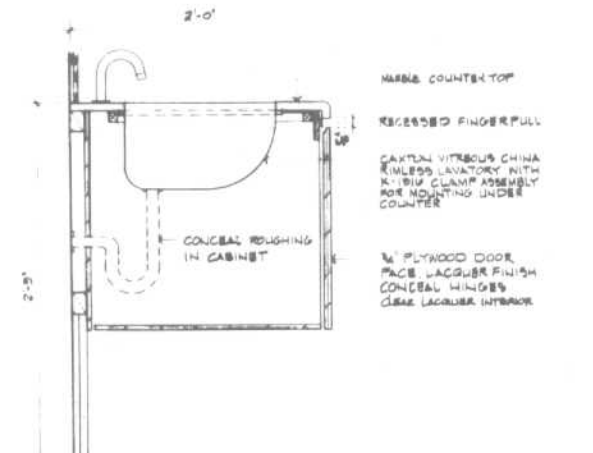
1 SECTION THRU LAV. CAB. @ BATH #1  
A11 15x11-0"



3 SECTION THRU LAV. CAB. @ BATH #4  
A11 15x11-0"



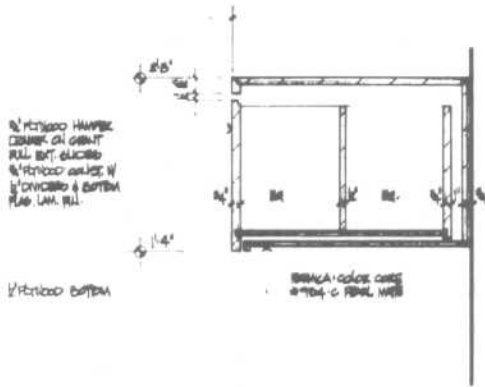
2 SECTION THRU LAV. CAB. @ BATH #2 & BATH #3, (6 SIMILAR)  
A11 12x11-0"



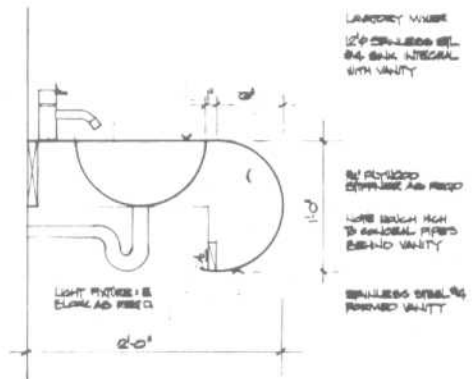
5 SECTION THRU LAV. CAB. @ BATH #1  
A11 15x11-0"

BATHROOMS

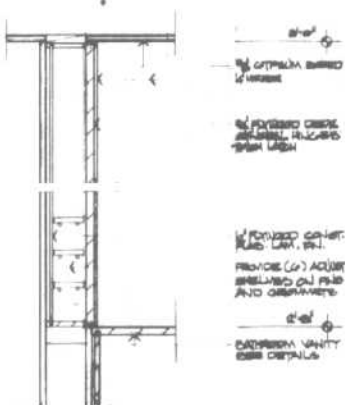
Vanities



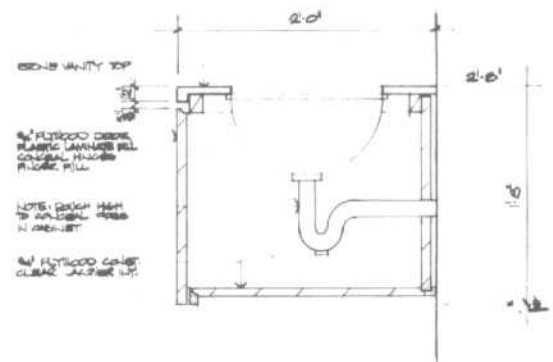
5 DETAIL: VANITY HAMPER  
A17 1/2" x 1'-0"



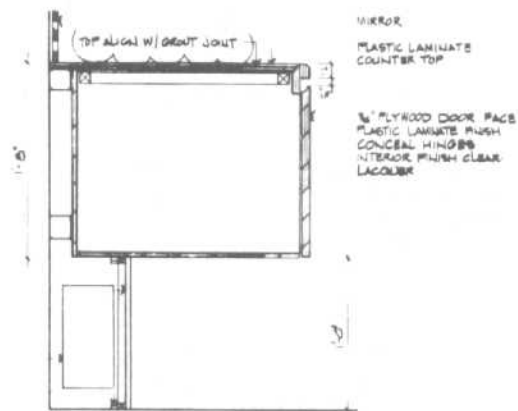
7 SECTION: POWDER RM. VANITY  
A17 1/2" x 1'-0"



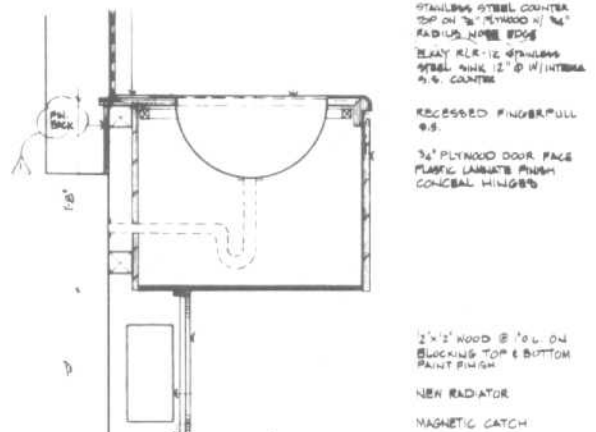
6 DETAIL: MEDICINE CAB.  
A17 1/2" x 1'-0"



8 DETAIL: VANITY MASTER BATHROOM  
A17 1/2" x 1'-0"



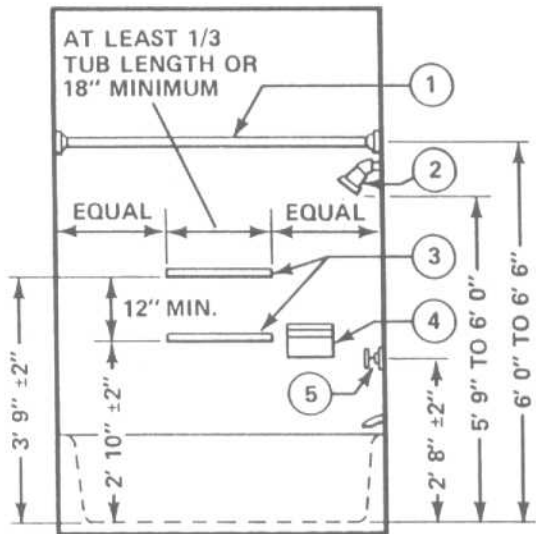
6 SECTION THRU LAV. CAB. @ BATH #2 & BATH #3 (SIMILAR)  
A11



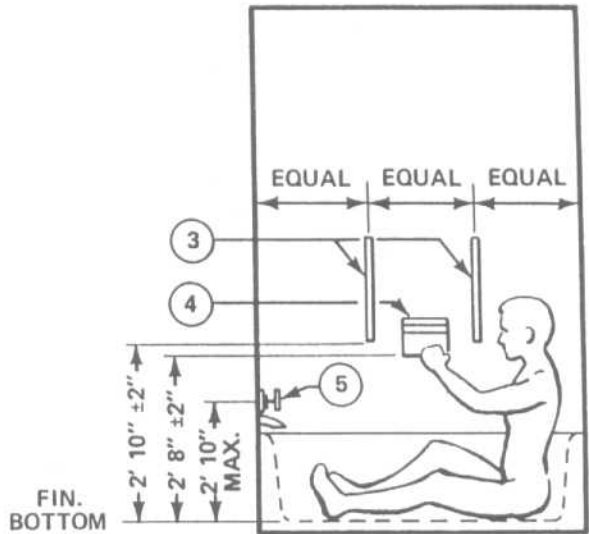
7 SECTION THRU LAV. CAB. @ BATH #5  
A11 1/2" x 1'-0"

**BATHROOMS**

Accessory and Control Placement

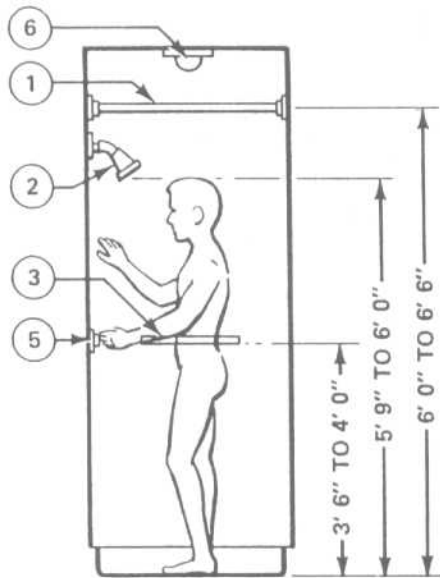


ELEVATION OF TUB W/SHOWER

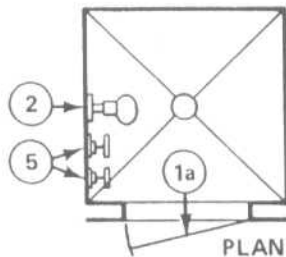


FIN. BOTTOM OF TUB

ELEVATION OF TUB W/O SHOWER



SECTION AT SHOWER

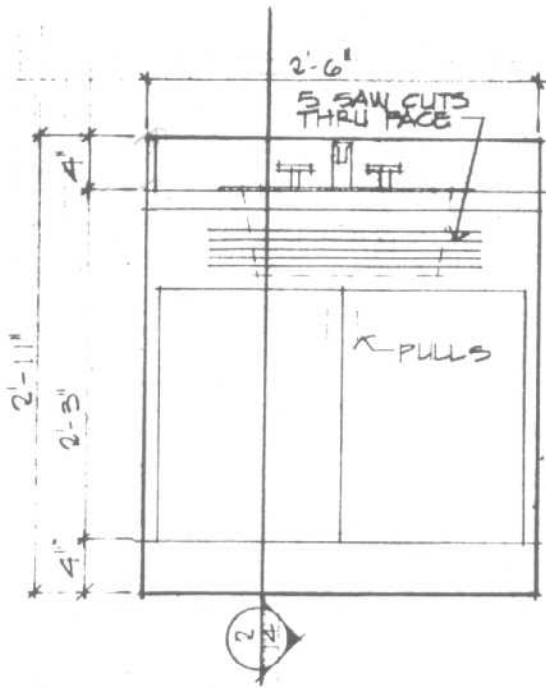


PLAN

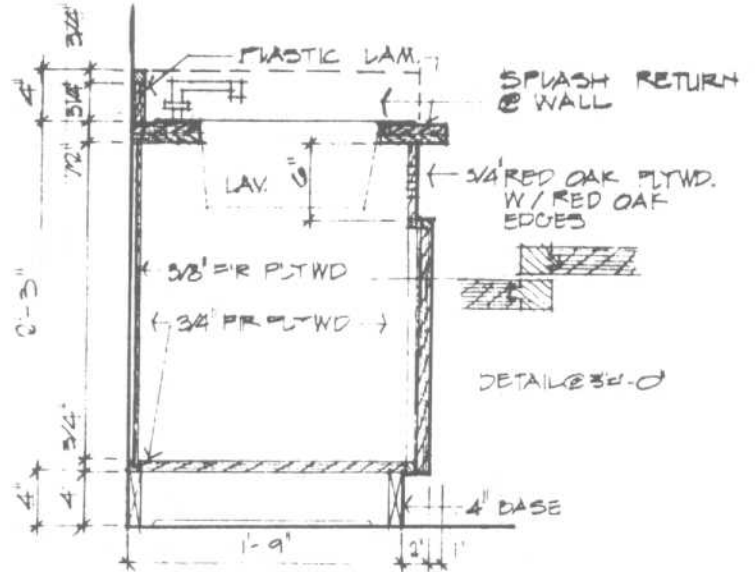
- ①. SHOWER CURTAIN ROD: KEEP WITHIN INSIDE OF TUB OR SHOWER.
  - 1a. ENCLOSURE DOORS: IF SWINGING DOORS ARE USED, PLACE HINGES ON THE SIDE OPPOSITE CONTROL VALVES.
- ②. SHOWER HEAD: SEE ELEVATION OF TUB AND SHOWER STALL FOR RECOMMENDED HEIGHTS.
- ③. GRAB BARS SHALL BE MANUFACTURED OF SHATTER-RESISTANT MATERIAL, FREE FROM BURRS, SHARP EDGES AND PINCH POINTS. KNURLING OR SLIP-RESISTANT SURFACE IS DESIRABLE.
- ④. RECESSED SOAP DISH SHALL BE FREE FROM BURRS AND SHARP EDGES. WHERE GRAB BAR IS AN INTEGRAL PART OF THE SOAP DISH, IT MAY HAVE A MINIMUM LENGTH OF 6 INCHES.
- ⑤. FAUCET SHALL BE MANUFACTURED OF SHATTER-RESISTANT MATERIAL, FREE FROM BURRS AND SHARP EDGES. ALL FAUCET SETS IN SHOWERS, TUBS AND LAVATORIES SHALL BE EQUIPPED WITH A WATER-MIXING VALVE DELIVERING A MAXIMUM WATER TEMPERATURE OF 110° ±5°F.
- ⑥. SHOWER STALL LIGHT: SHALL BE OF A VAPOR-PROOF FIXTURE WITH THE ELECTRICAL LIGHT SWITCH A MINIMUM OF 72 INCHES AWAY FROM SHOWER STALL.

BATHROOMS

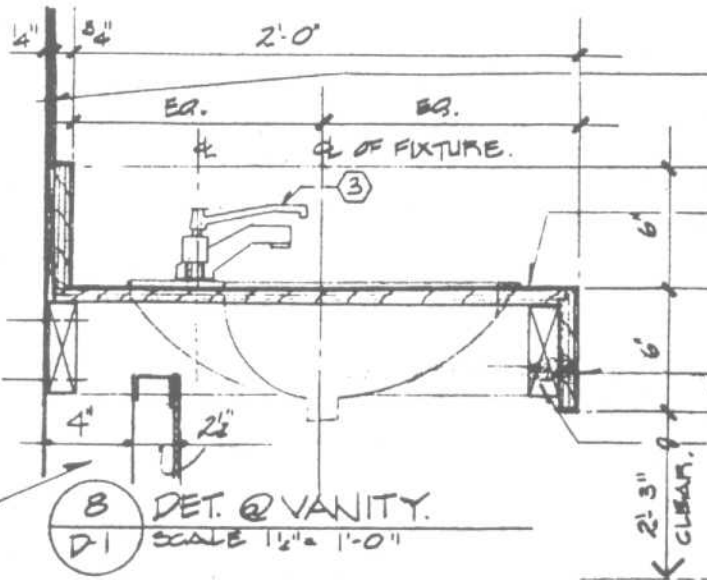
Vanities; Lavatory Counters



1  
14 TOILET ROOM CAB. ELEV.



2  
14 TOILET ROOM CAB. SECT.



8  
D1 DET. @ VANITY. SCALE 1/2" = 1'-0"

PROVIDE PIPE CHASE BELOW VANITY. FC. TO COORDINATE W/ PLUMBER. FOR EXACT PIPE LOCATIONS.

1/4" PLATE GLASS MIRROR W/ 3/8" STL. FRAME. FULL HEIGHT FROM BACKSPASH TO UNDERSIDE OF CLG.

PLASTIC LAM. FINISH.  
BY: WILSONART  
COLOR: KAHKI BROWN @ LADIES RM. D-60-15  
BY: NEVAMAP  
COLOR: BLACK PEARL S-6-14 T.

3/4" PLYWOOD.  
(TYP.)

WD. BLOCKING.

FIN. FLOOR.

NOTE:  
ALL WOODWORK SHALL BE FIRE RETARDANT.

BATHROOMS

Lavatory Counters

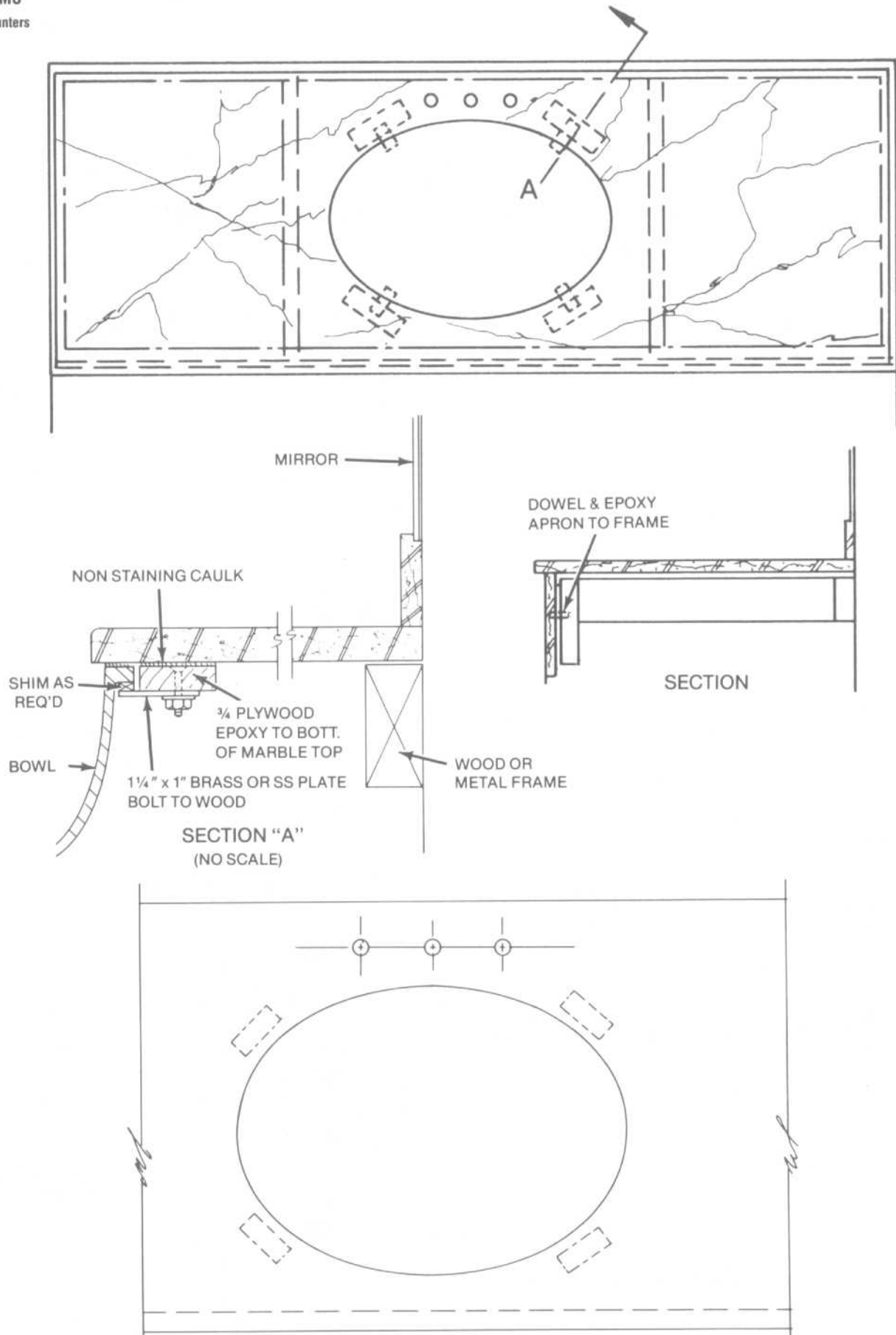
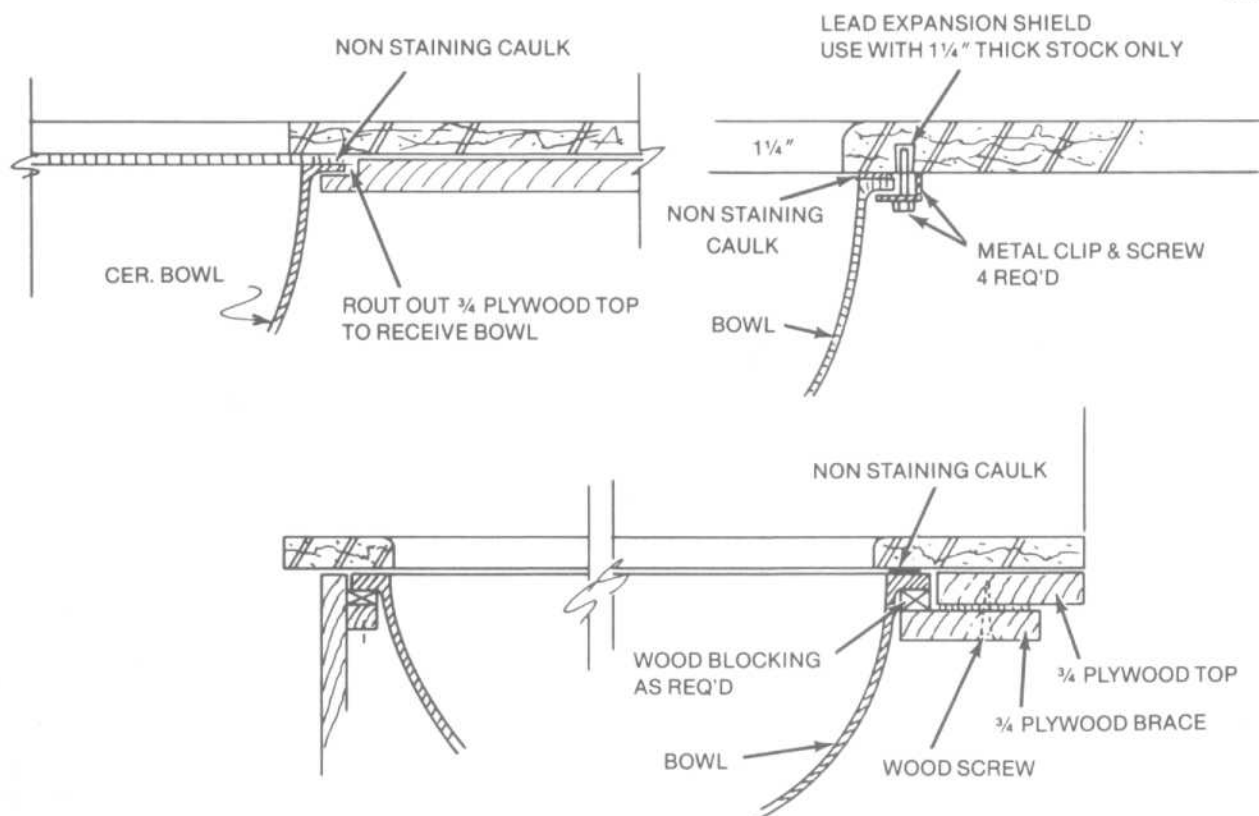


Fig. 16 Typical details of a marble vanity-top installation.



TYPICAL SECTIONS BOWL CARRIER

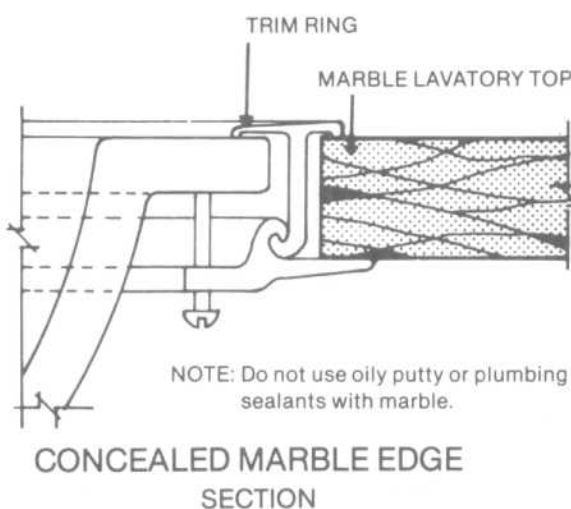
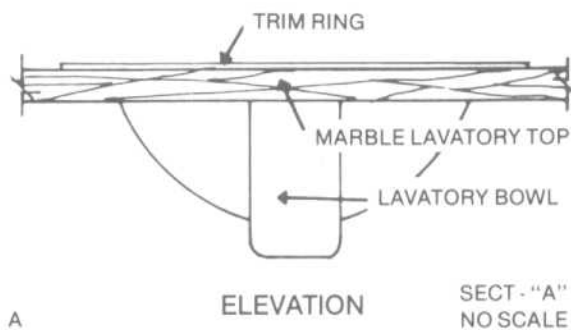
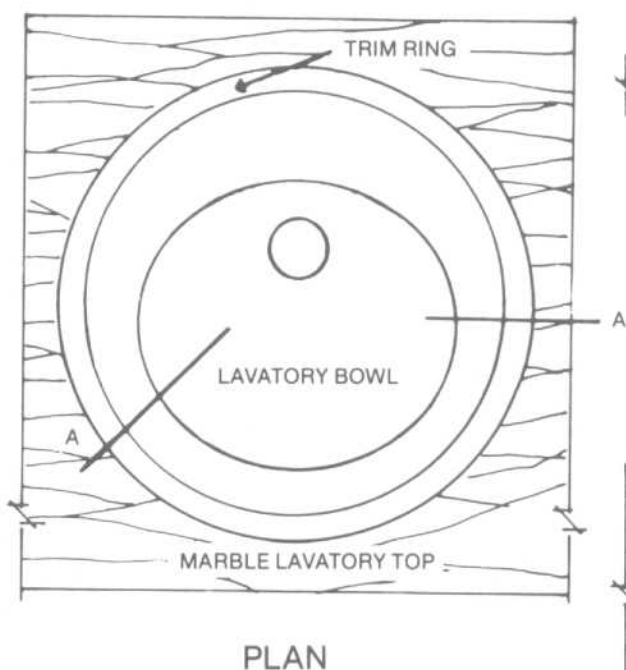


Fig. 16 (Continued)

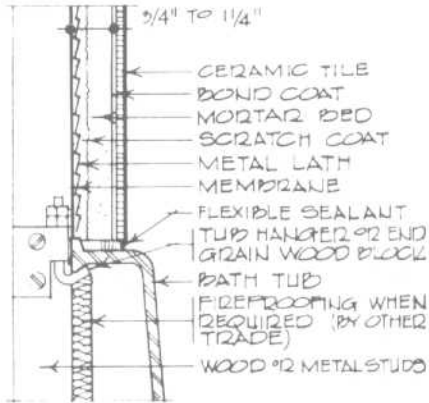
**BATHROOMS**

Bathtub and Shower Details

**BATHTUB WALLS**

**Wood or Metal Studs**

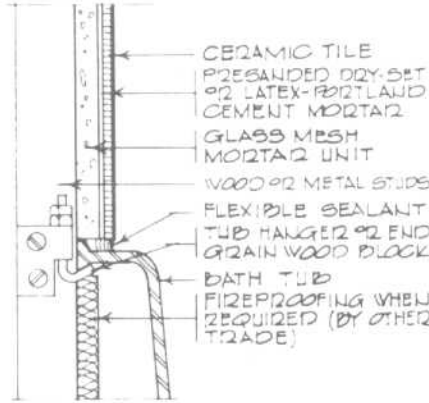
**Cement Mortar**



**Recommended uses**

- over dry, well-braced wood studs, furring, or metal studs
- preferred method of installation over wood studs for bathtubs

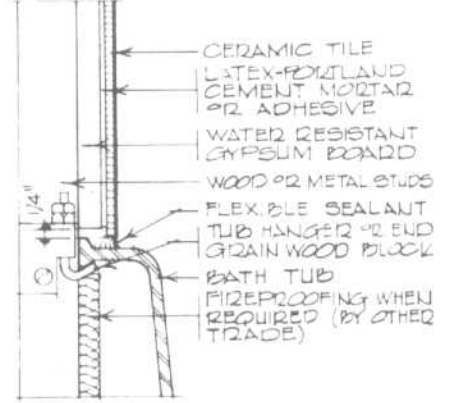
**Glass Mesh Mortar Units**



**Recommended use**

- in tub enclosures and tub showers over dry, well-braced wood studs, furring, or metal studs

**Gypsum Board**



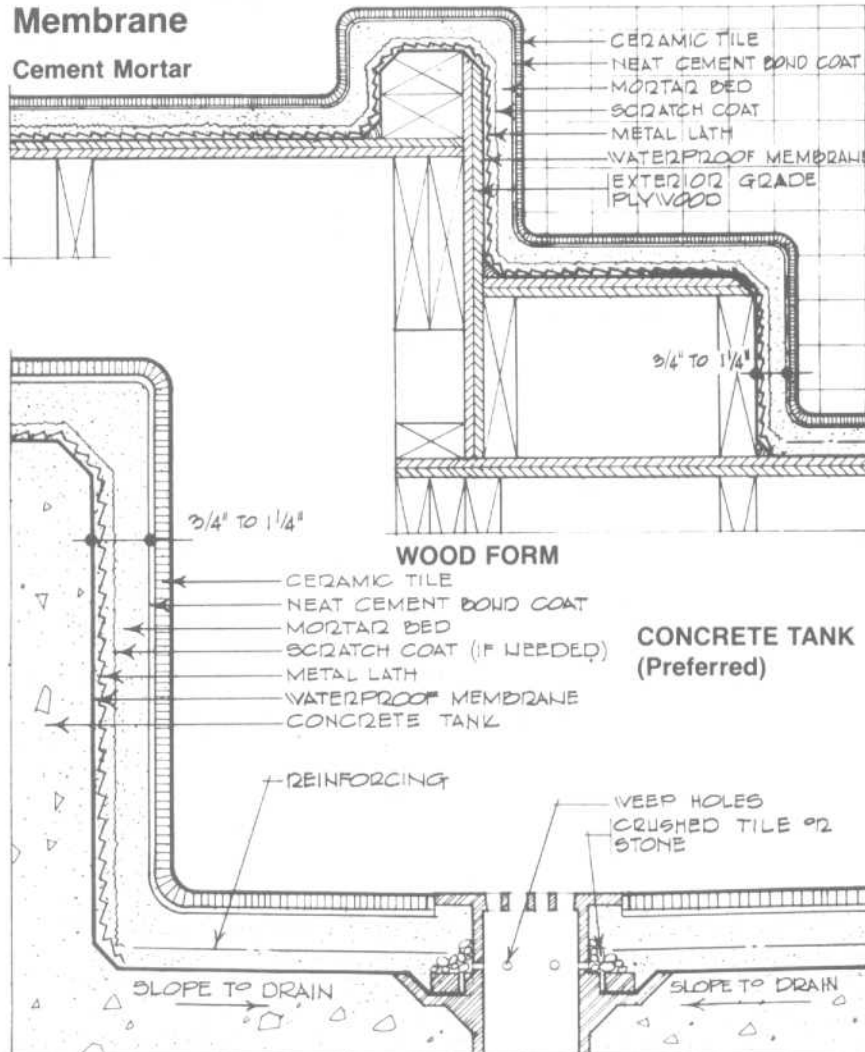
**Recommended use**

- in tub enclosures and tub showers over water-resistant gypsum backing board on wood or metal studs

**TILE TUBS AND FOUNTAINS**

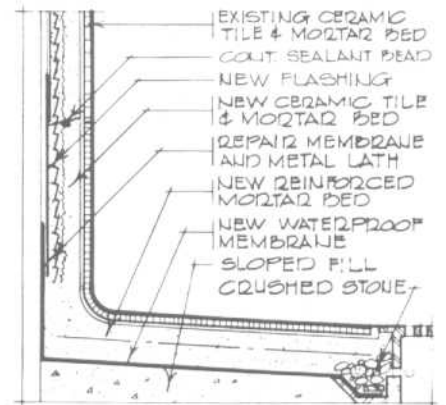
**Membrane**

**Cement Mortar**



**SHOWER RECEPTOR RENOVATION**

**Cement Mortar**



**Recommended use**

- over wood or concrete subfloors; where old shower pan has failed

**Requirements**

- waterproof membrane required except in slab-on-grade installations where membrane may be omitted
- slope tank so that membrane will slope to the drain
- flange drain with weep holes required
- wood framing, if used, should be pressure treated and designed to resist deflection and movement

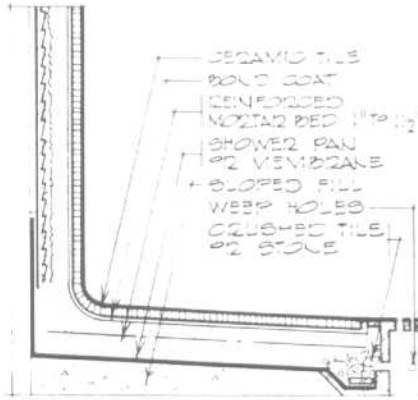
Fig. 17 Typical installation details for bathtub walls, tile tubs, and shower receptors.



## SHOWER RECEPTORS, WALLS

## Wood or Metal Studs

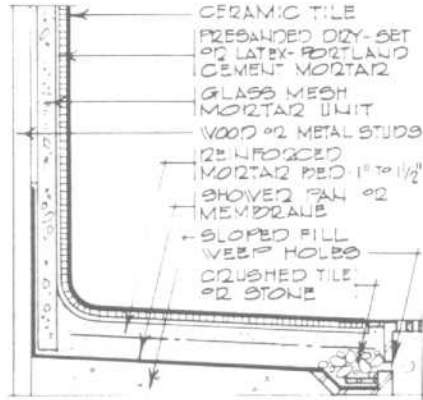
## Cement Mortar



## Recommended use

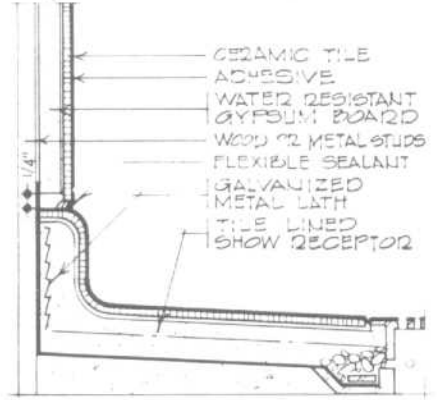
- over wood or concrete subfloors

## Glass Mesh Mortar Units



## Recommended use

- in showers over dry, well-braced wood studs, furring, or metal studs

Gypsum Board  
Organic Adhesive

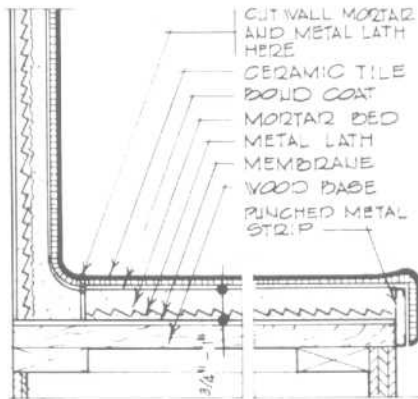
## Recommended use

- in showers over water-resistant gypsum backing board on wood or metal studs

## COUNTERTOPS

## Wood Base

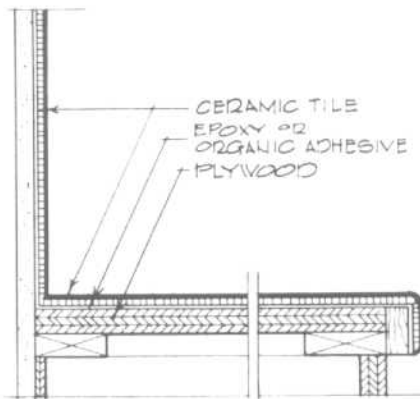
## Cement Mortar



## Recommended uses

- on countertops, drainboards, lavatory tops, etc.
- preferred method where sink or lavatory is to be recessed

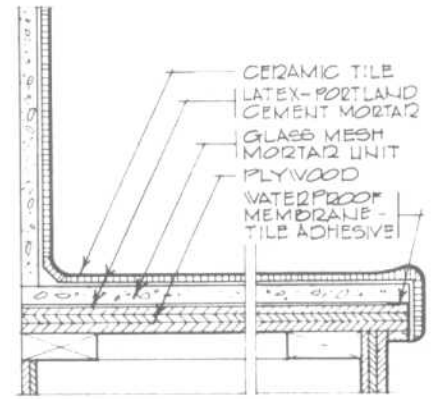
## Thin-Bed



## Recommended use

- on countertops where thin-set method is desired

## Glass Mesh Mortar Unit



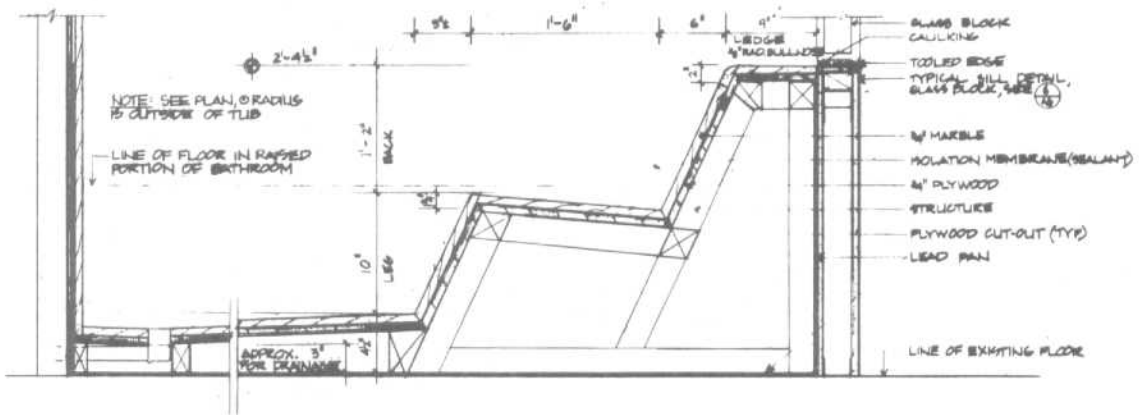
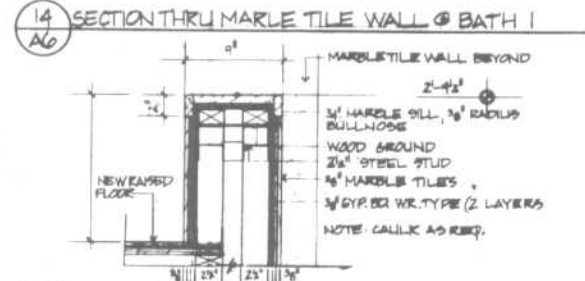
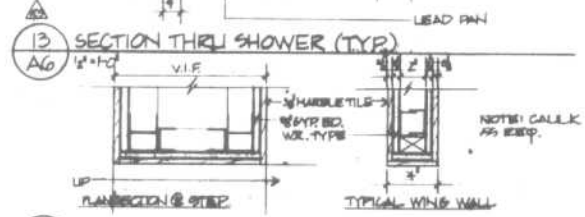
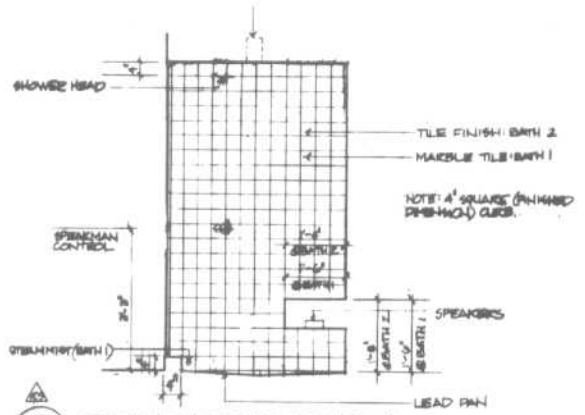
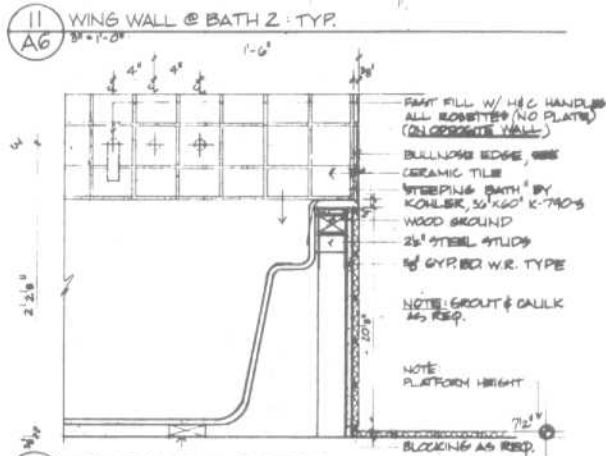
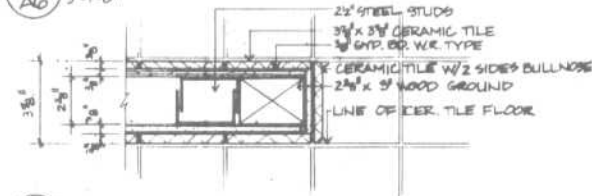
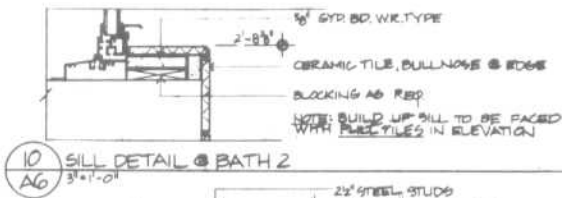
## Recommended uses

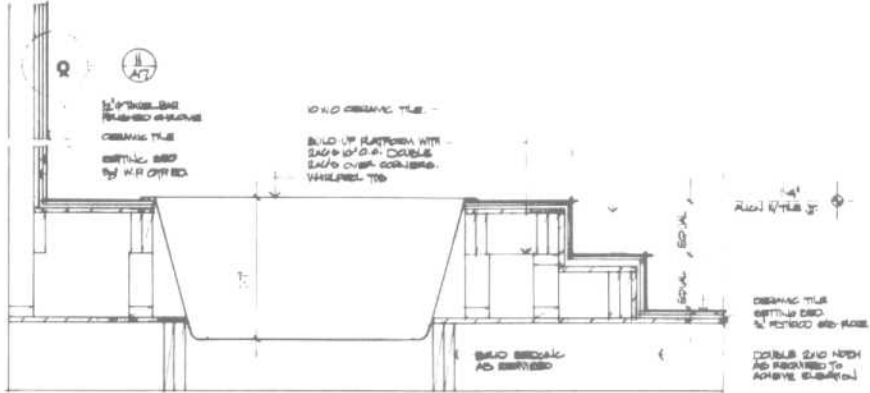
- preferred thin-set mortar method on countertops, drainboards, lavatory tops, and similar uses
- preferred method where self-rimming sinks and lavatories are desired

Fig. 18 Typical installation details for shower receptors, walls, and countertops.

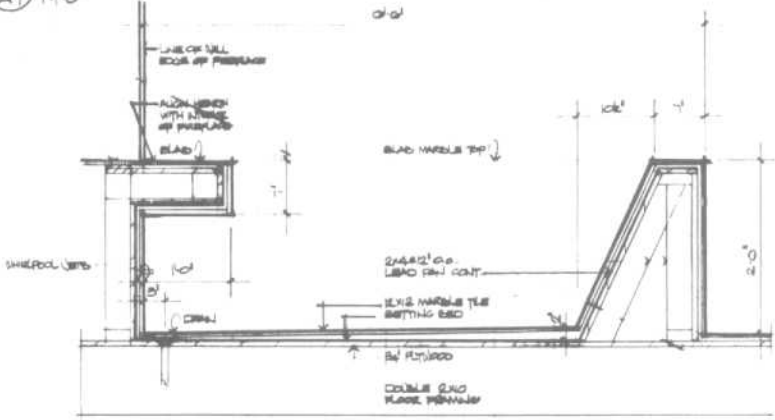
BATHROOMS

Bathtub and Shower Details

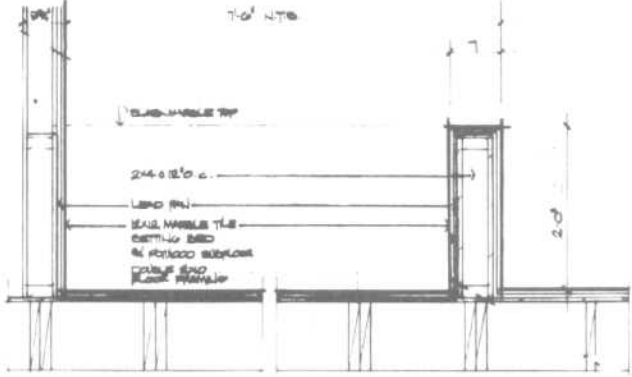




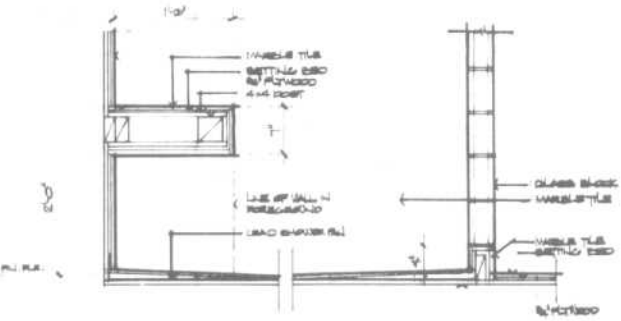
12 SECTION: WHIRLPOOL BATH #1  
A7 1/4"=1'-0"



13 SECTION: WHIRLPOOL TUB, MASTER BATH  
A7 1/4"=1'-0"



14 SECTION: WHIRLPOOL TUB, MASTER BATH  
A7 1/4"=1'-0"



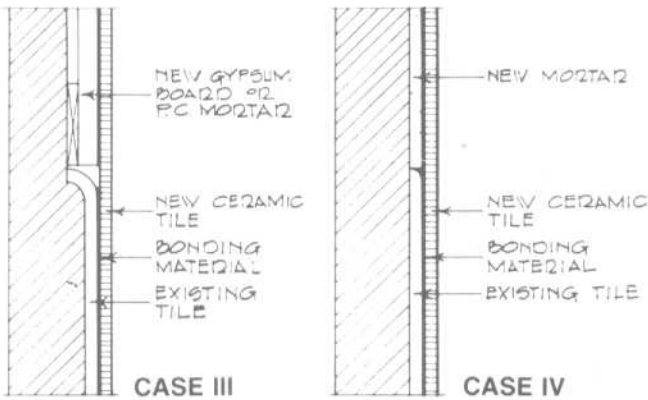
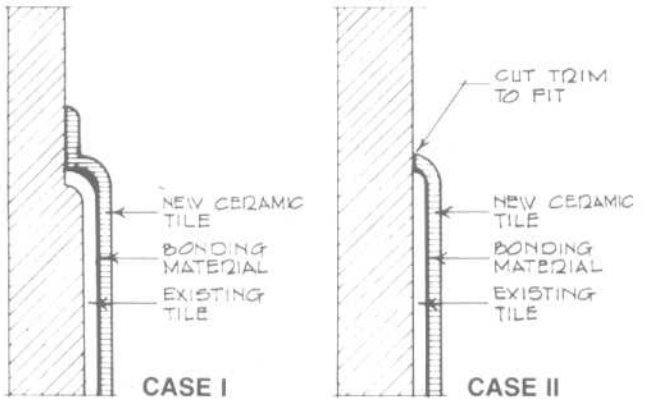
15 SECTION: M. BATH SHOWER  
A7 1/4"=1'-0"

**BATHROOMS**

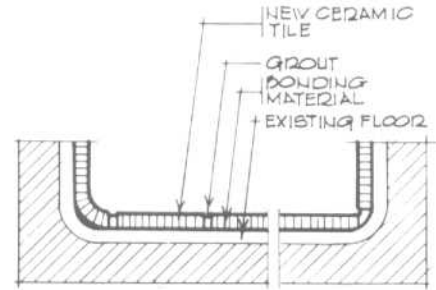
Ceramic Tile Details

**TILE OVER TILE**

**Interior Walls**



**Interior Floors**



**Recommended uses**

- for alteration of ceramic-tiled areas where modernization or a change of design is desired in residences, motels and hotels, restaurants, public rest rooms, etc.
- also applicable to smooth floors of terrazzo, stone, slate, etc.

**Recommended uses**

- for alteration of ceramic-tiled areas where modernization or a change of design is desired in residences, motels and hotels, restaurants, public rest rooms, etc.
- also applicable to smooth walls of marble, stone, slate, etc.

**Requirements**

- existing installation must be sound, well bonded, and without major structural cracks

**Materials, grouting, expansion joints, installation specifications**

- for organic adhesive installation see Method W223
- for Dry-Set or latex-portland cement mortar installation see Method W202
- for epoxy adhesive installation refer to manufacturer's literature

Fig. 19 Typical installation details for tile over tile.

**BATHROOMS**

Adaptable Bathrooms

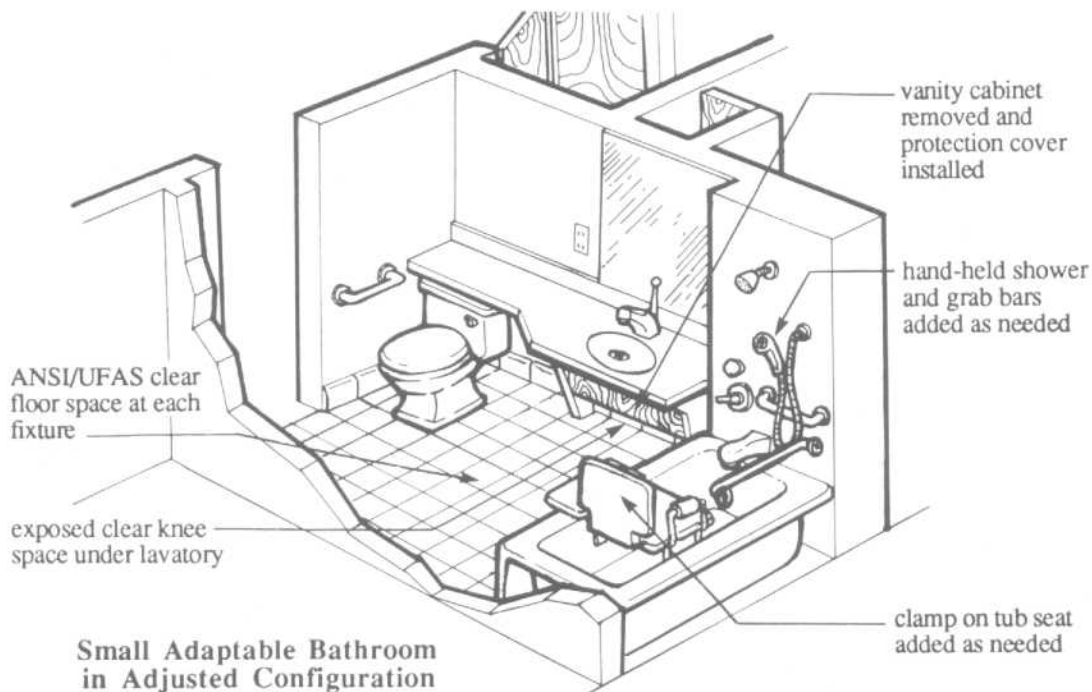
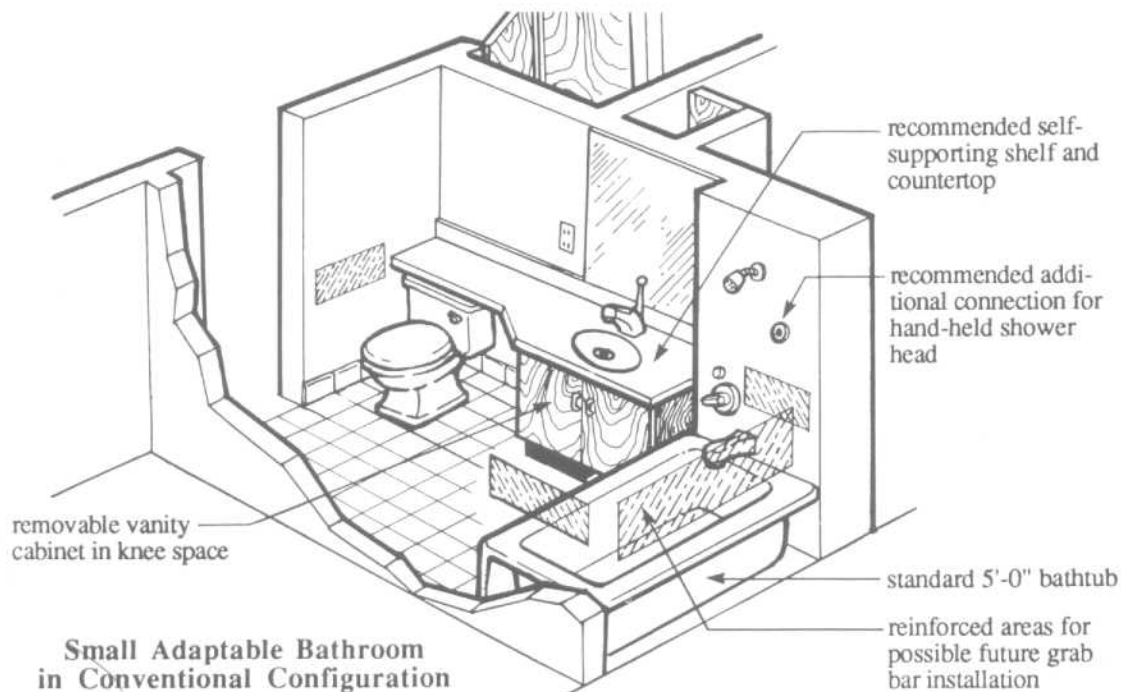
**ACCESSIBILITY**

It is essential that the design of interior spaces, as well as exterior spaces, be responsive to the needs of those having physical disabilities. There is a proliferation of state and local legislation in this regard, and, more recently, federal legislation (Americans with Disabilities Act of 1990), that provides design guidelines and requirements. The

designer should become familiar with those codes and other requirements in her or his area prior to initiation of design and, where possible, go beyond the very minimum standards.

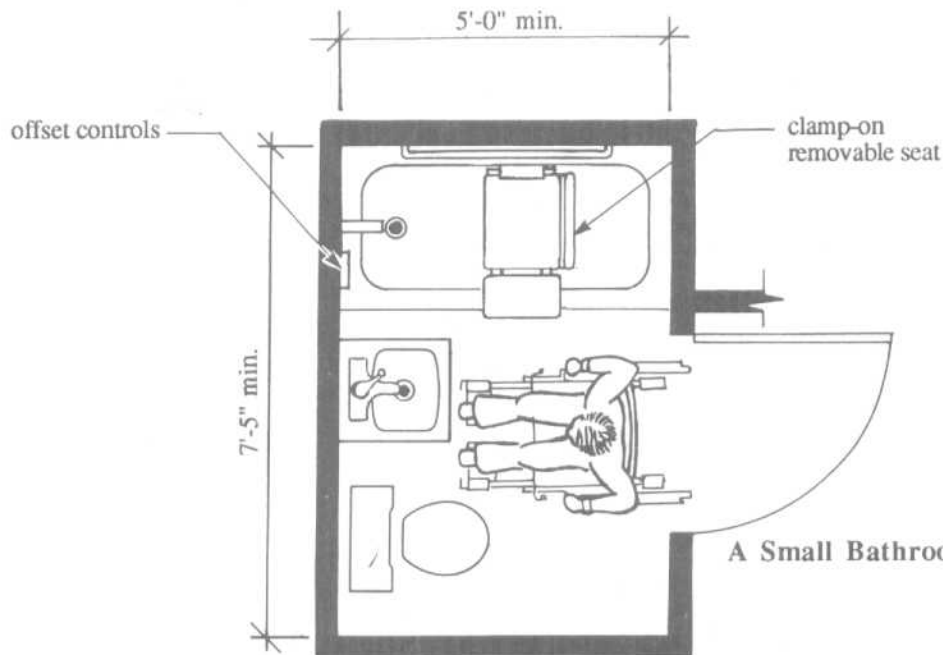
The design of the bathroom is perhaps one of those areas where the interface between the physically disabled and the interior space

is the most critical. Accordingly, on this page and the following pages are design guidelines prepared by the Veterans Administration and the U.S. Department of Housing and Urban Development.



**BATHROOMS**

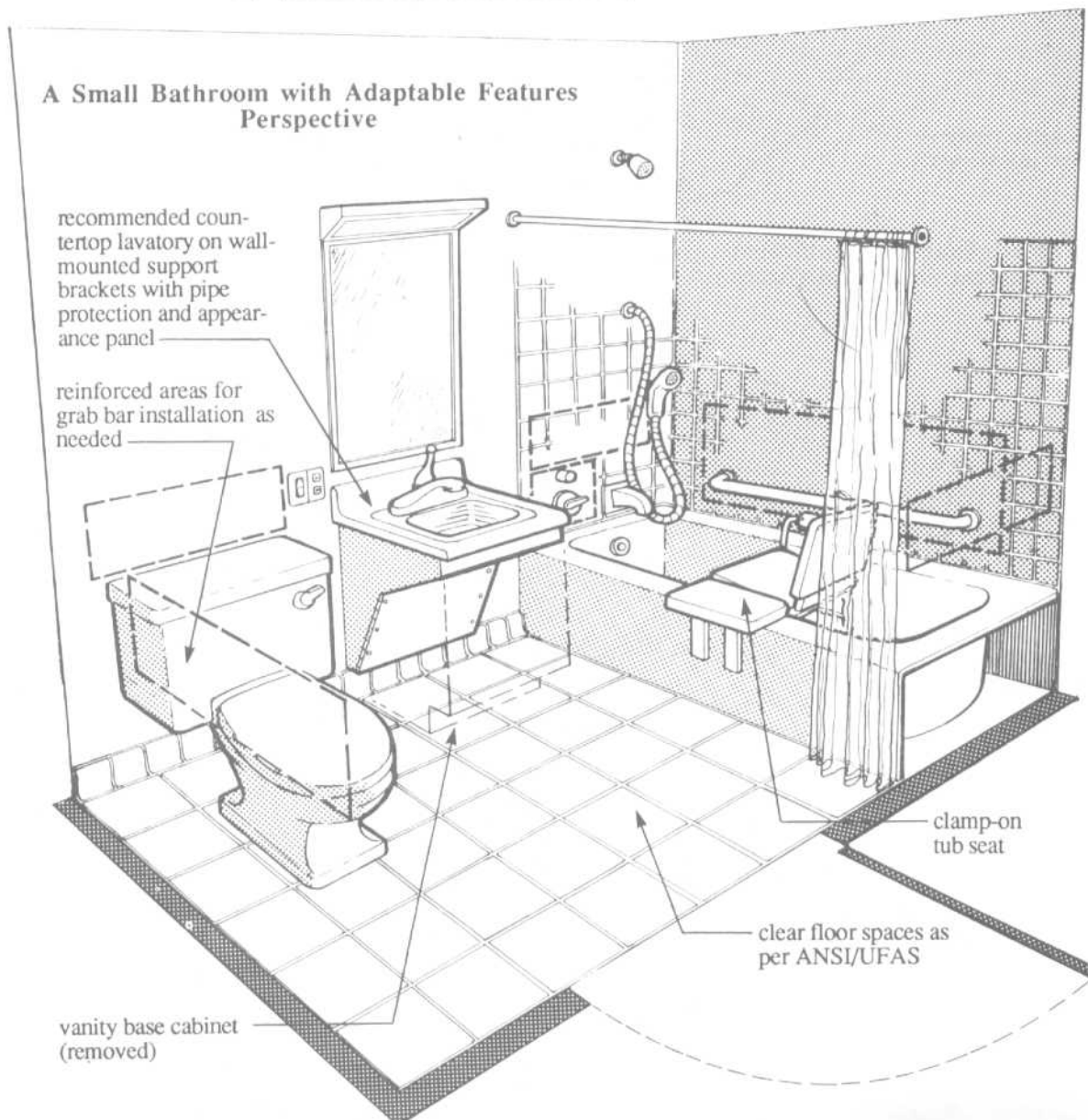
Adaptable Bathrooms

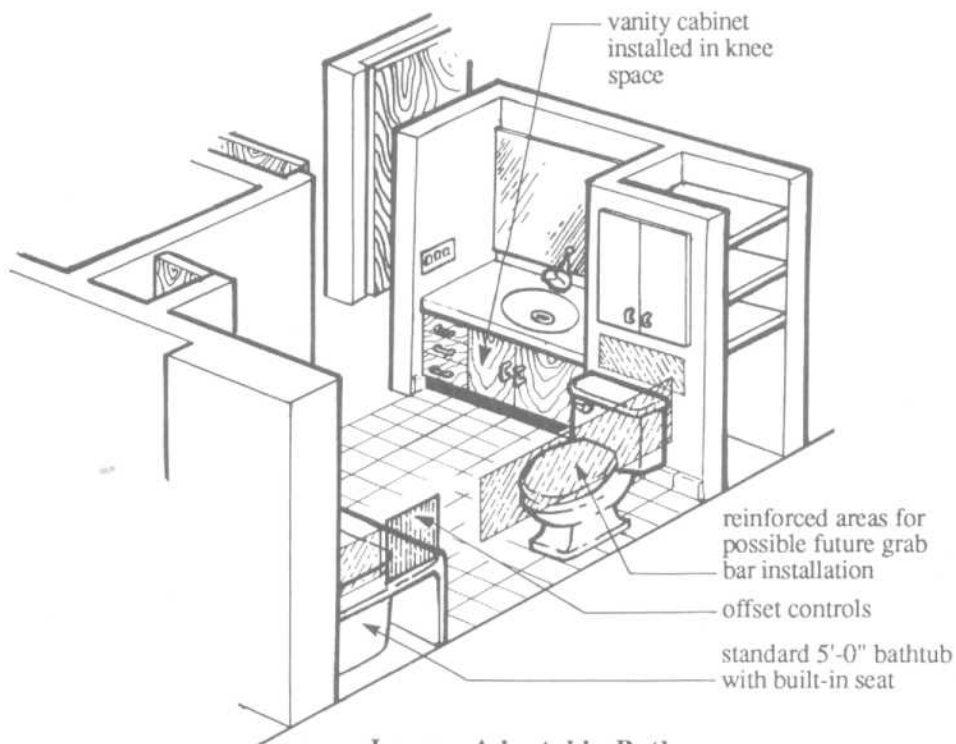


This sample bathroom meets the minimum space requirements of both ANSI and UFAS; note, however, that the space is very small and many wheelchair users will have difficulty using such a bathroom. More space should be allocated when possible.

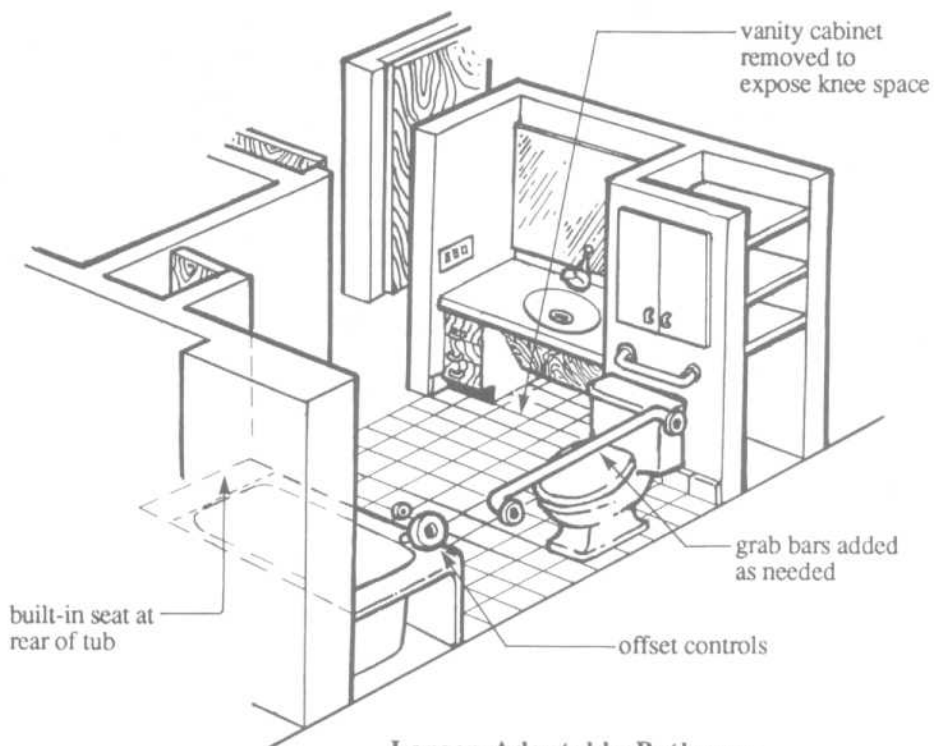
**A Small Bathroom with Adaptable Features Plan**

**A Small Bathroom with Adaptable Features Perspective**





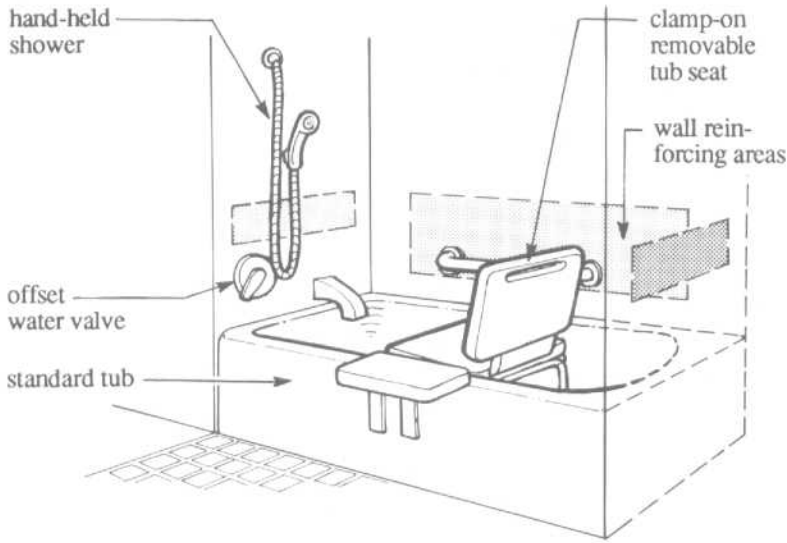
**Larger Adaptable Bathroom  
in Conventional Configuration**



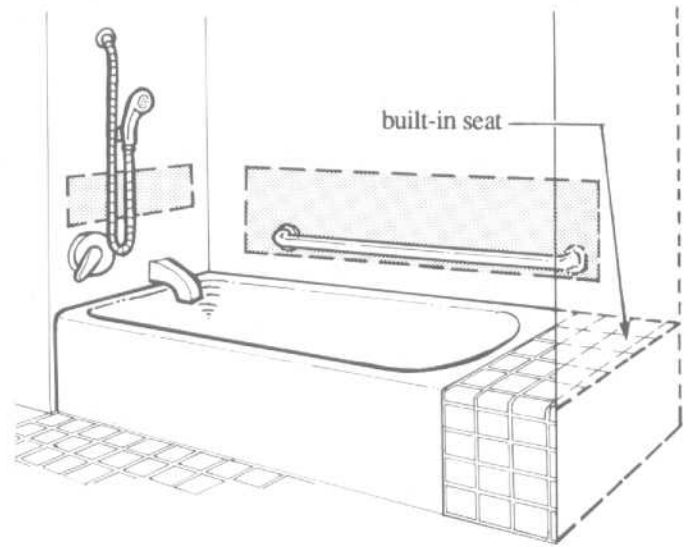
**Larger Adaptable Bathroom  
in Adjusted Configuration**

**BATHROOMS**

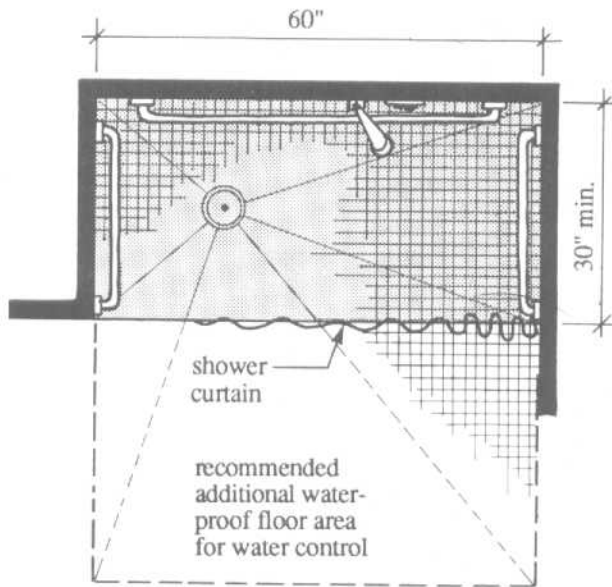
Adaptable Bathrooms



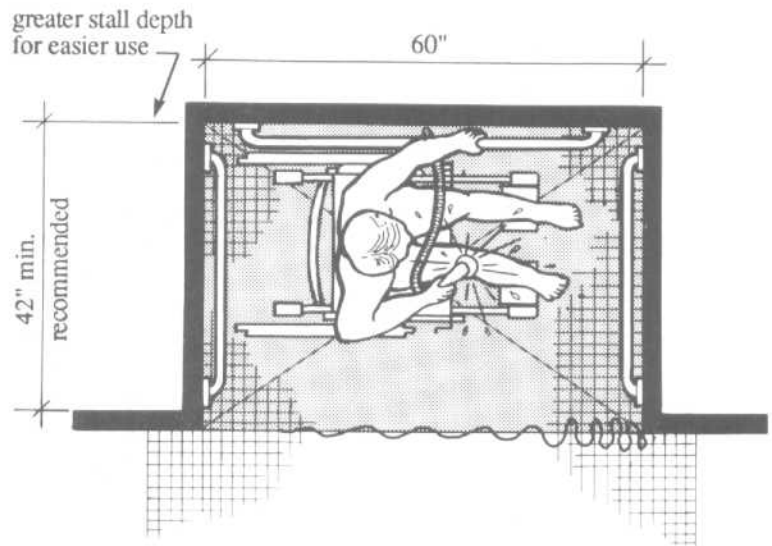
**Standard Bathtub with Removable Seat**



**Standard Bathtub with Built-in Seat**



**ANSI Minimum Roll-in Shower**

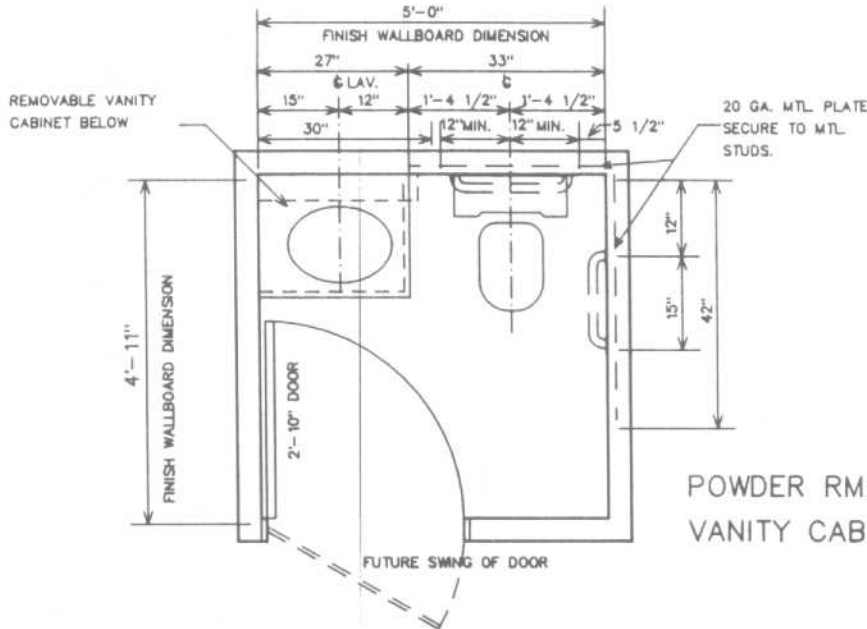


**Preferred Deeper Roll-in Shower**

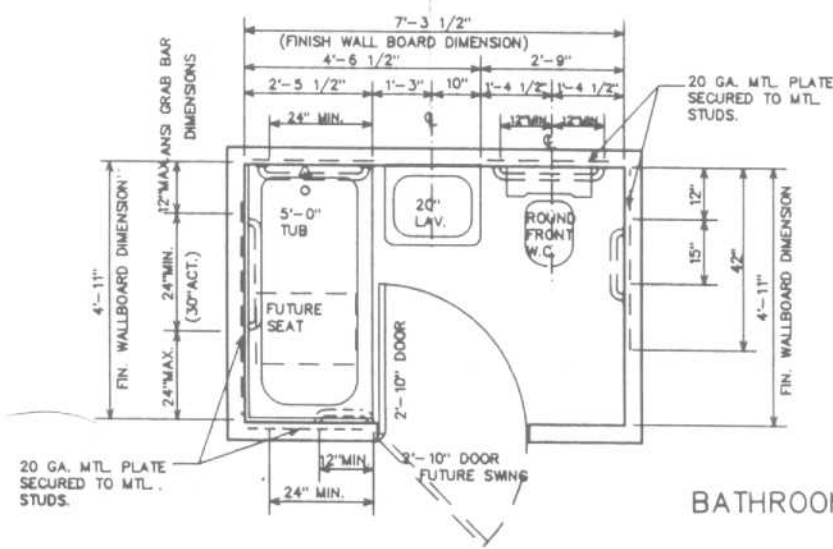


BATHROOMS

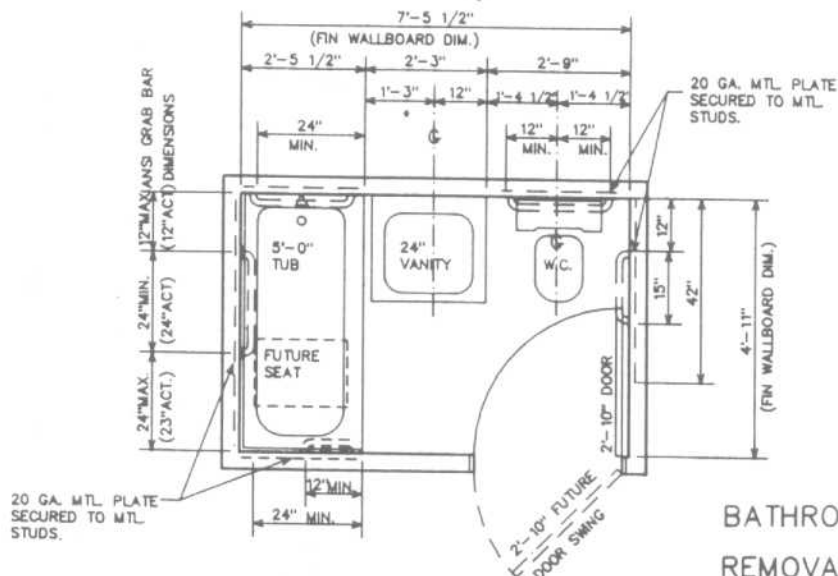
Adaptable Bathrooms



POWDER RM. PLAN WITH 27" REMOVABLE VANITY CABINET



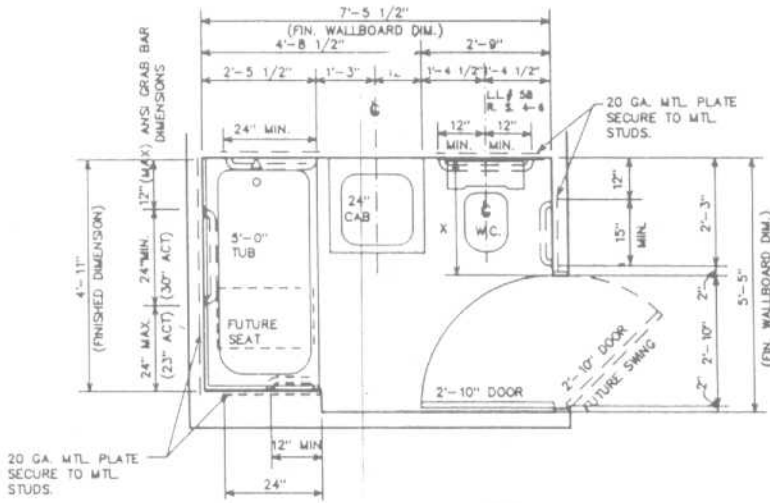
BATHROOM PLAN W/20" LAVATORY



BATHROOM TYPE WITH 24" REMOVABLE VANITY CABINET

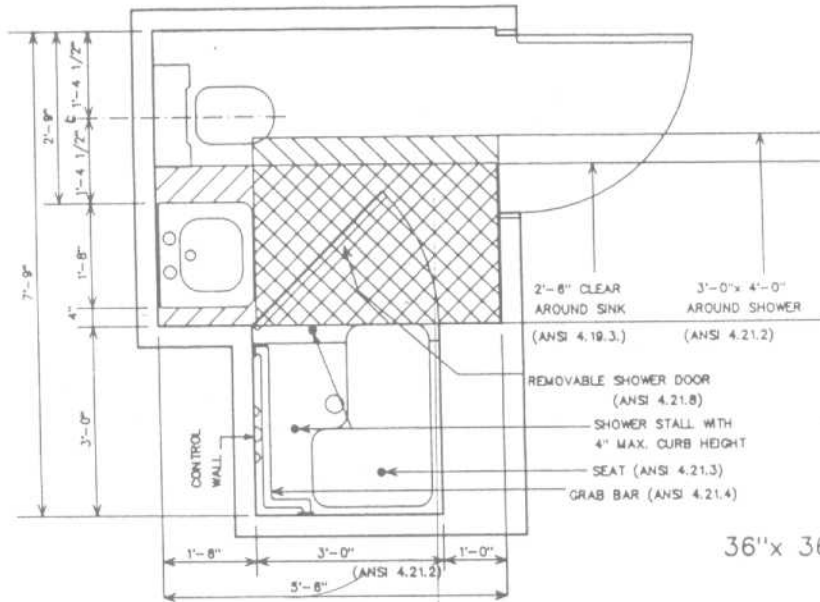
BATHROOMS

Adaptable Bathrooms

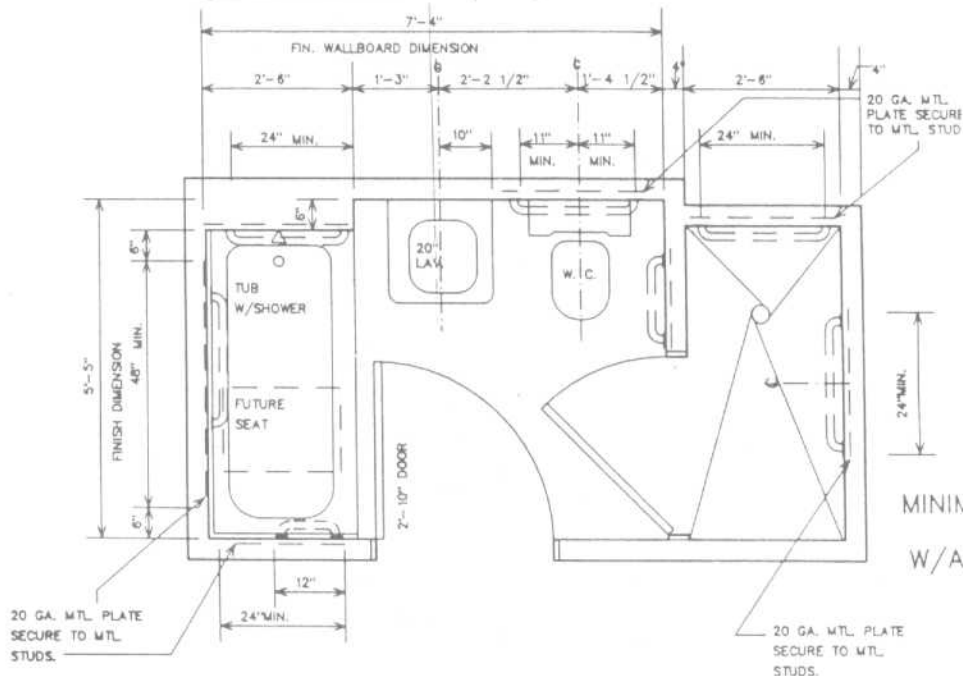


BATHROOM PLAN WITH 24" REMOVABLE VANITY CABINET

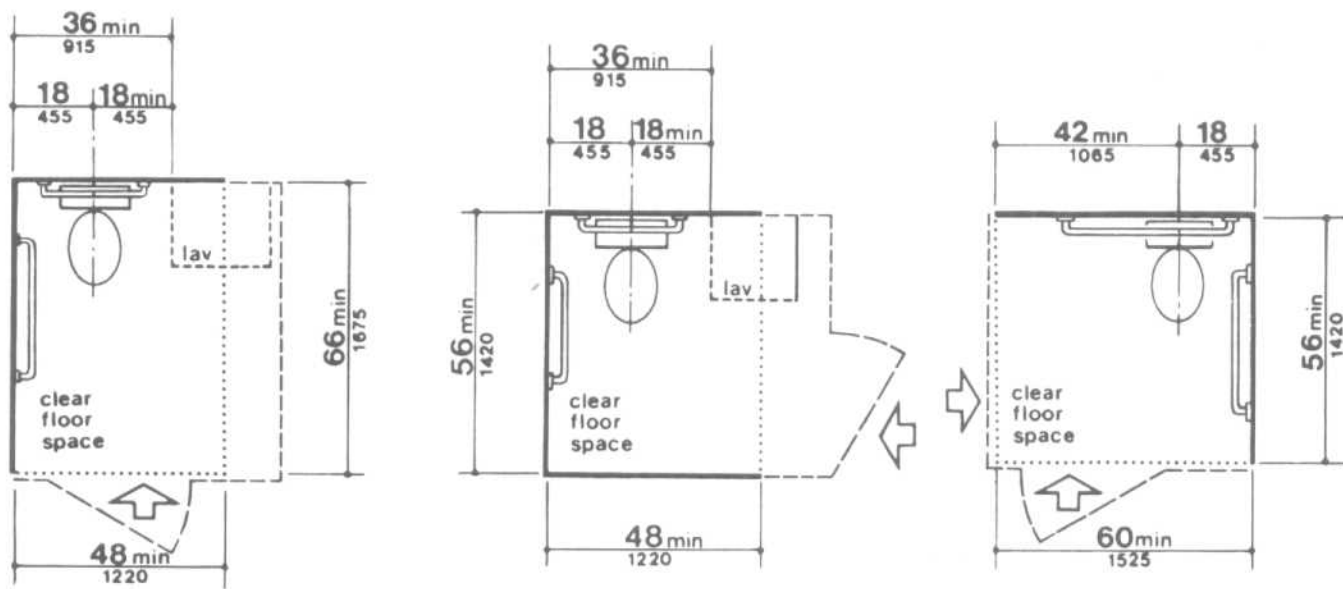
X = THE OUTER EDGE OF THE WATER CLOSET WILL NOT EXTEND INTO THE CLEAR SPACE REQUIRED FROM THE DOOR OPENING.



36"x 36" ADAPTABLE SHOWER STALL

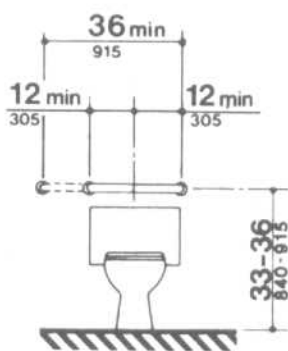


MINIMUM BATHROOM REQUIRED W/ADDITIONAL SHOWER

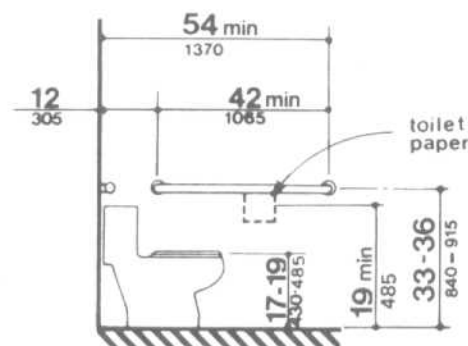


Possible wall locations -----

Clear Floor Space at Water Closets

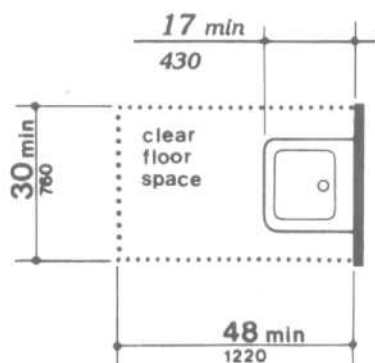


(a) Back Wall

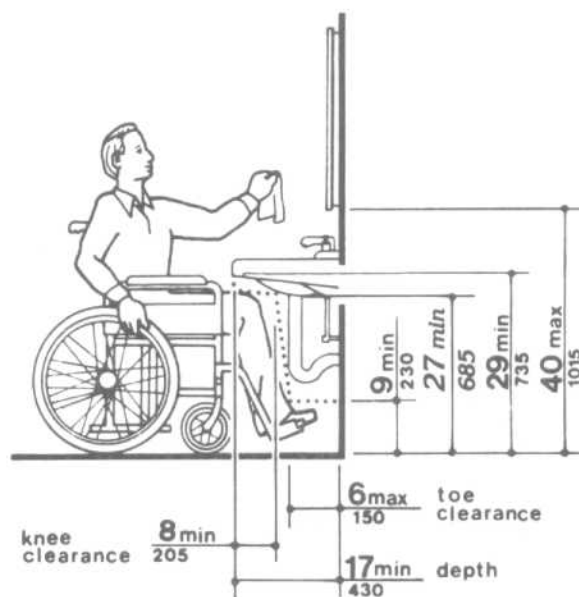


(b) Side Wall

Grab Bars at Water Closets



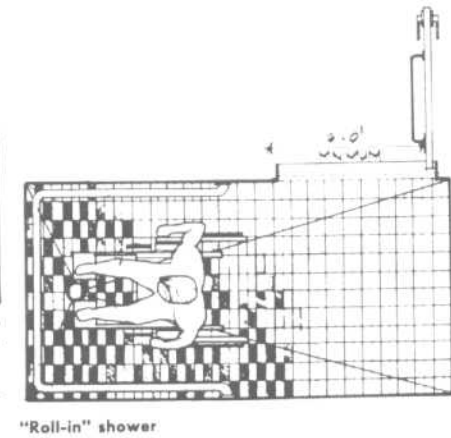
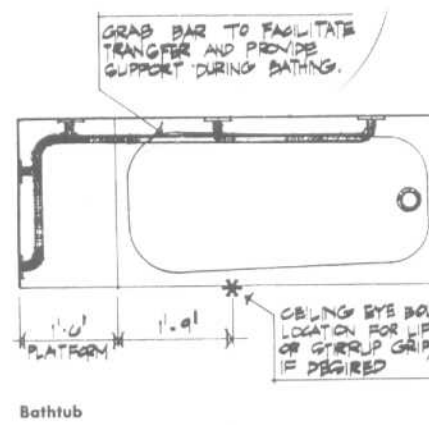
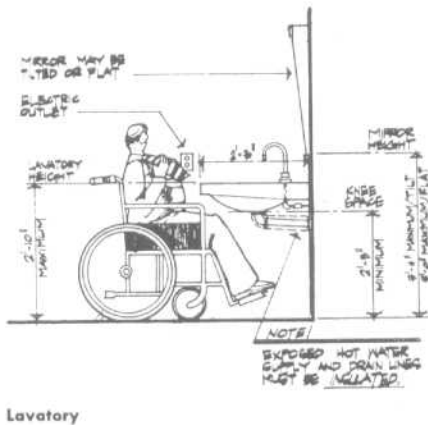
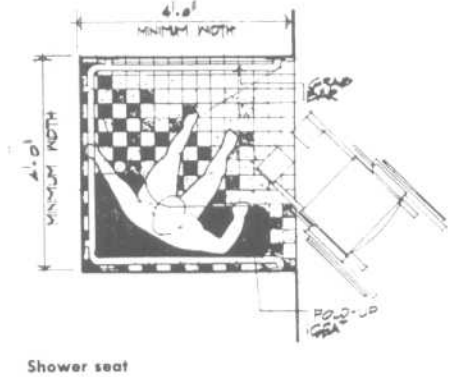
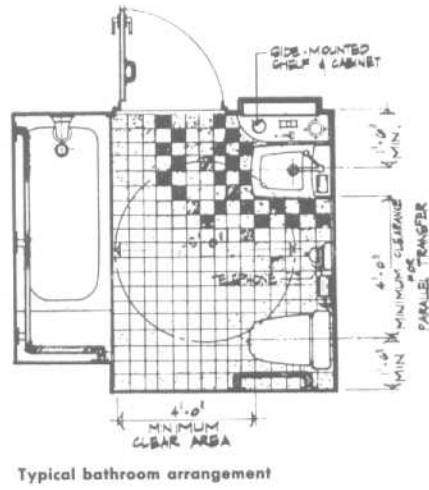
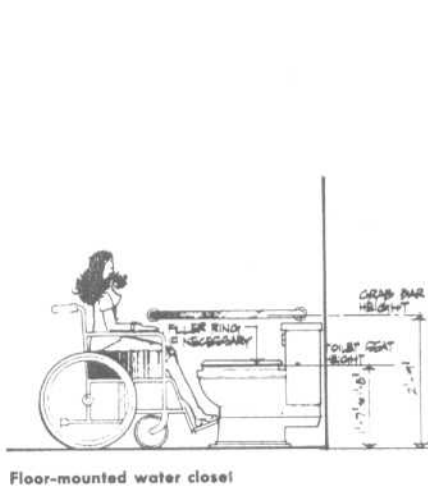
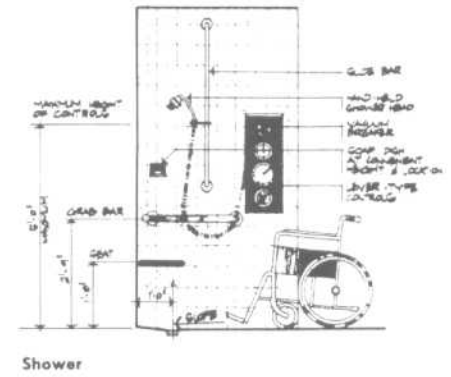
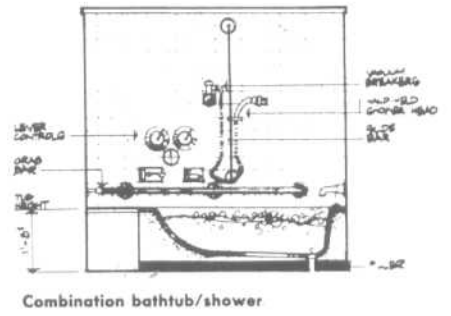
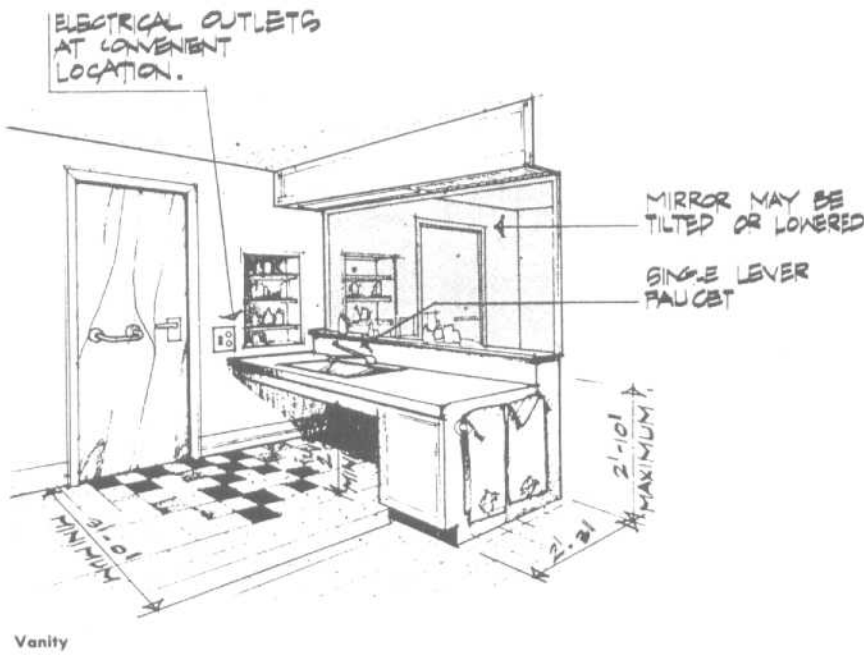
Clear Floor Space at Lavatories



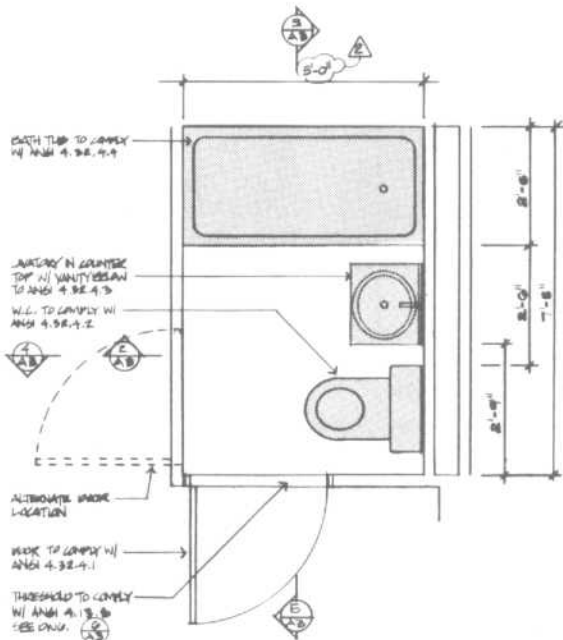
Lavatory Clearances

BATHROOMS

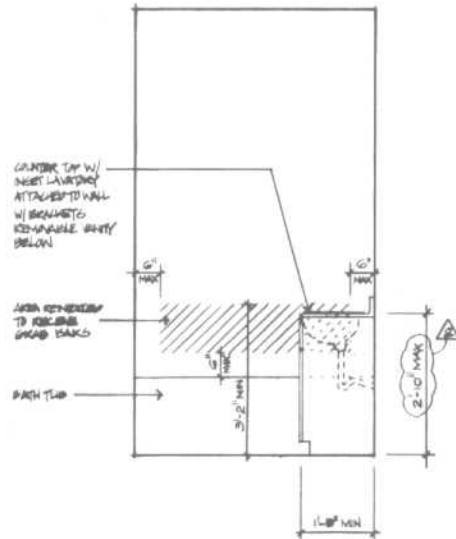
Wheelchair Accessible Clearances



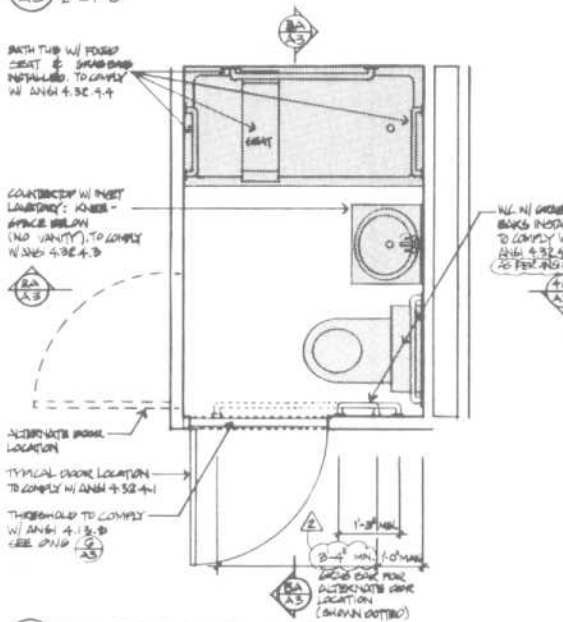
**BATHROOMS**  
Wheelchair Accessible Design



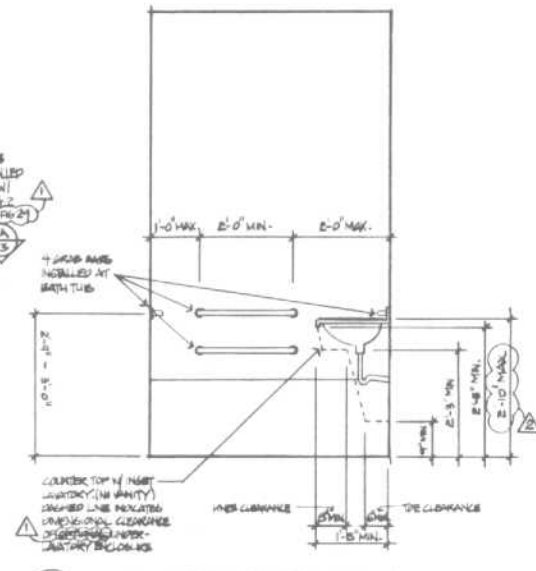
1 PLAN: TYPICAL ADAPTABLE BATHROOM  
1/2" = 1'-0"



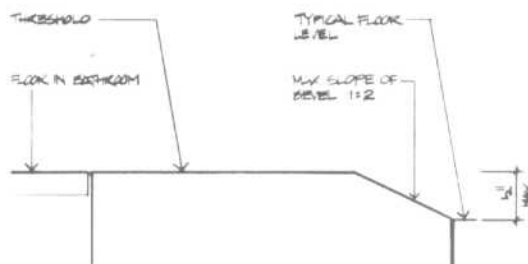
2 ELEVATION: TYPICAL ADAPTABLE BATHROOM  
1/2" = 1'-0"



1A PLAN: TYPICAL ADAPTED BATHROOM  
1/2" = 1'-0"



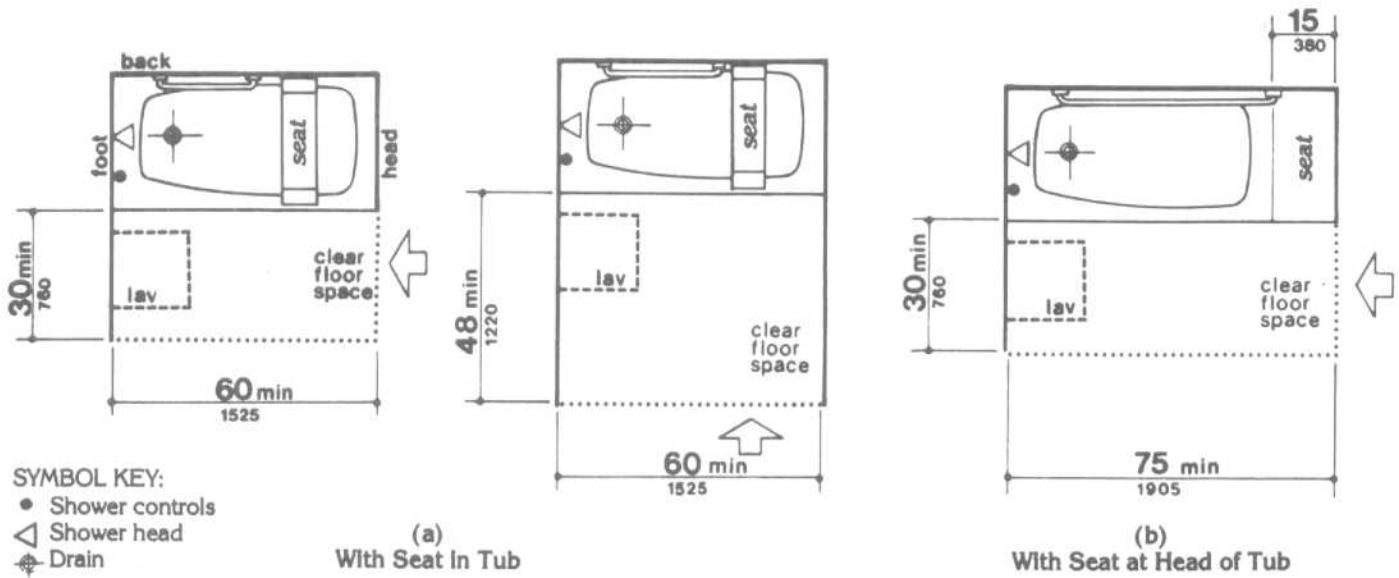
2A ELEVATION: TYPICAL ADAPTED BATHROOM  
1/2" = 1'-0"



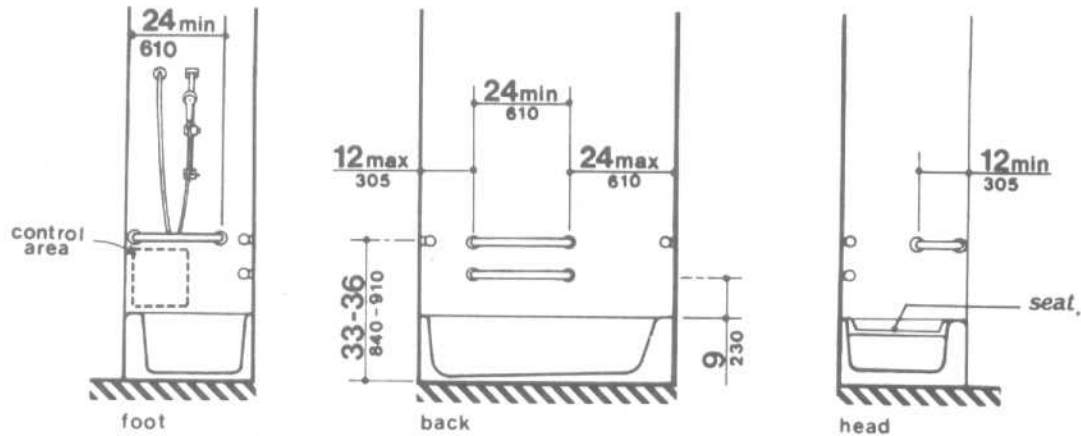
6 SECTION THRU THRESHOLD: TO COMPLY WITH ANCH 4.13.8 FULL SIZE

**BATHROOMS**

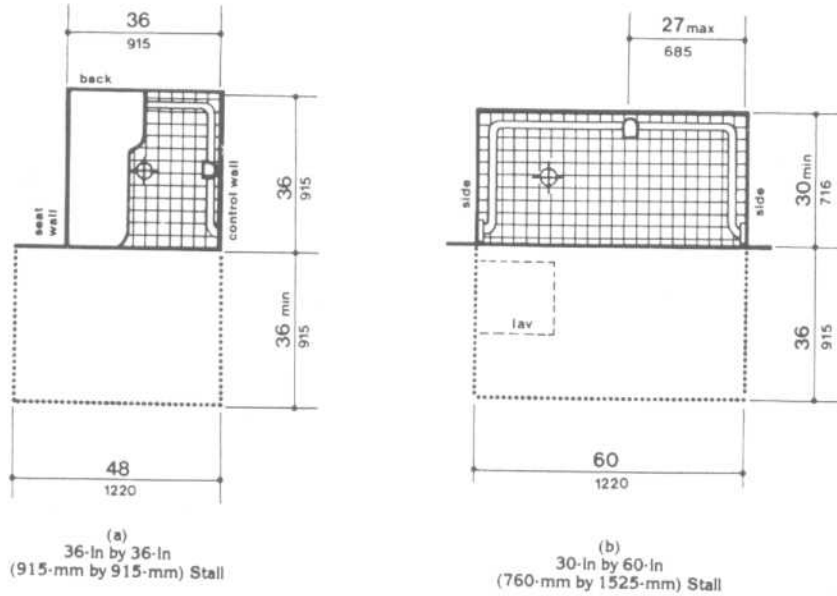
Wheelchair Accessible Clearances



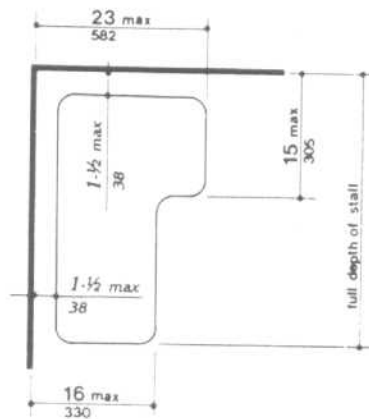
**Clear Floor Space at Bathtubs**



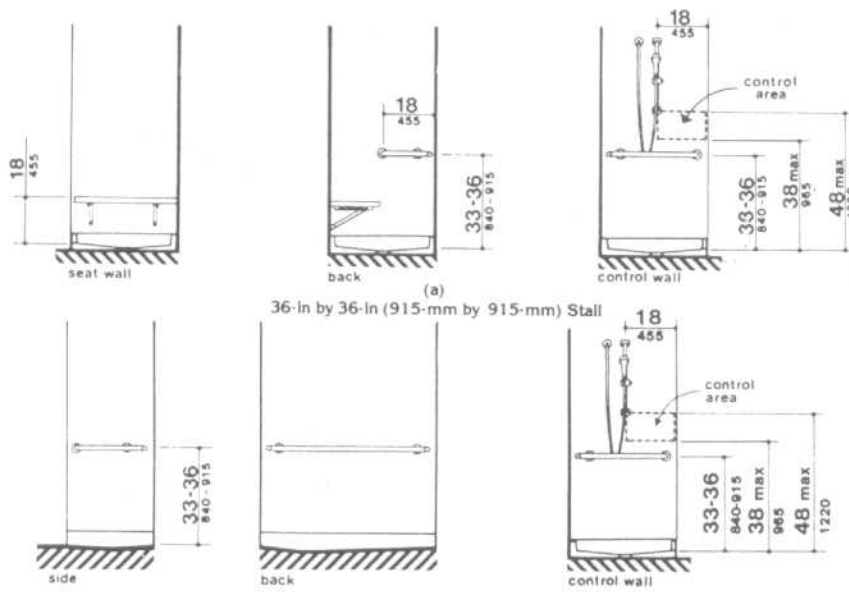
**Grab Bars at Bathtubs**



Shower Size and Clearances



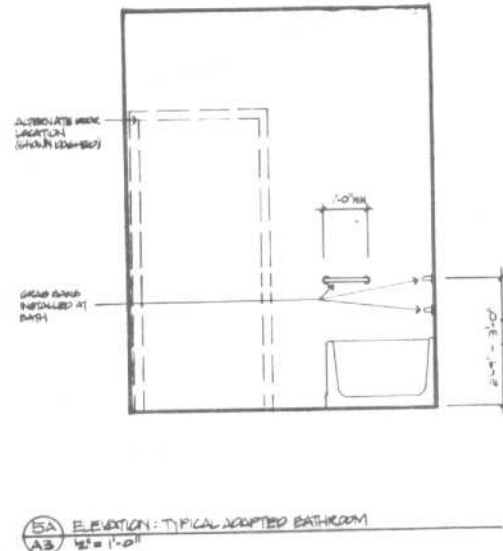
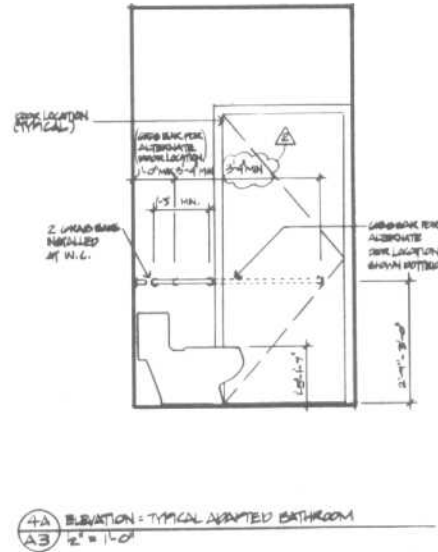
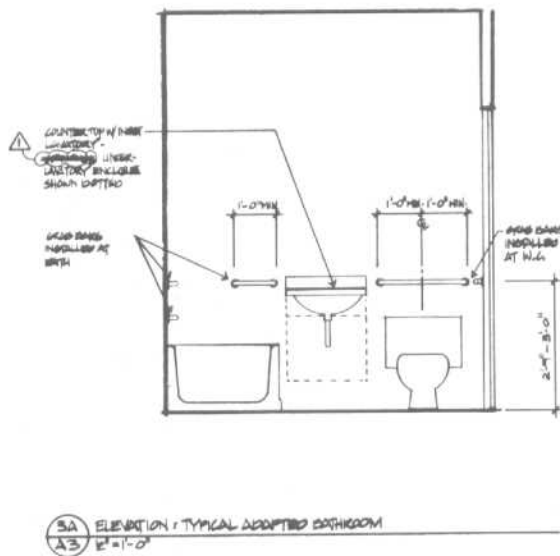
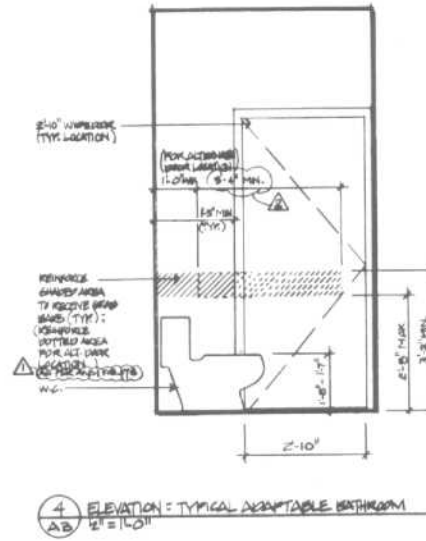
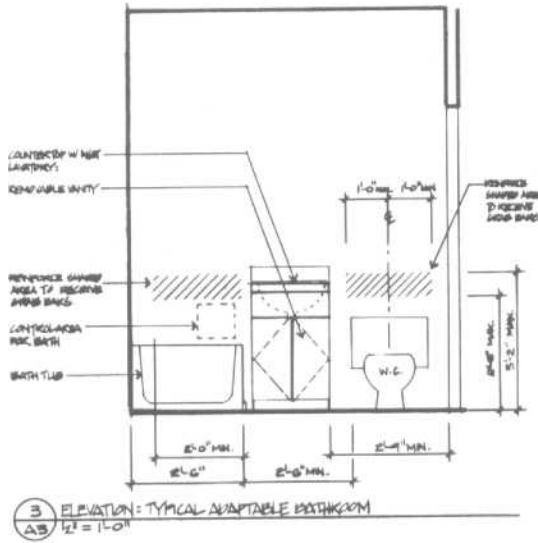
Shower Seat Design



Grab Bars at Shower Stalls

BATHROOMS

Wheelchair Accessible Design





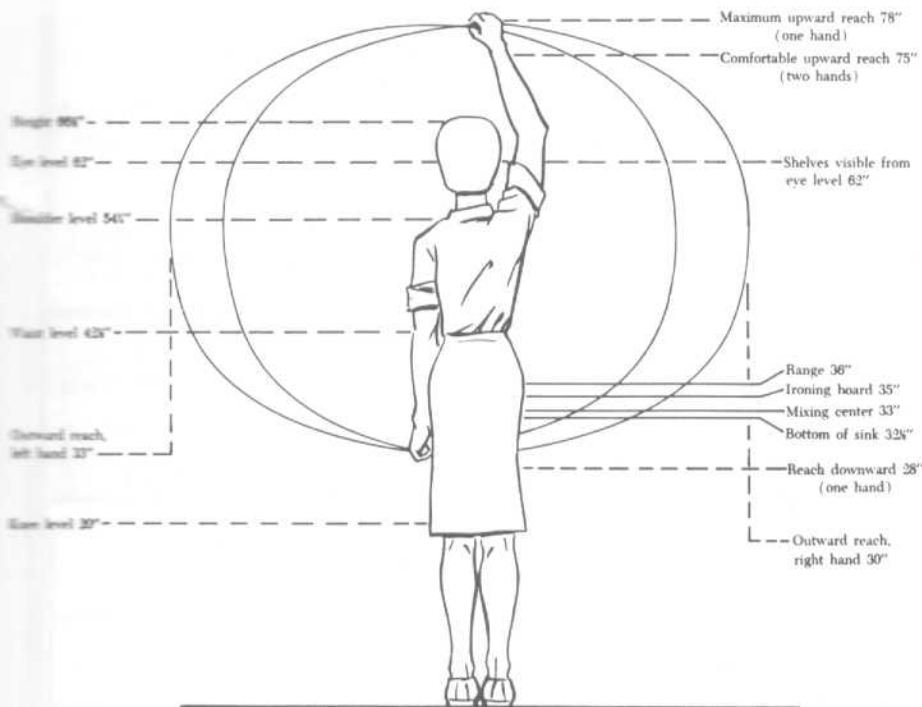
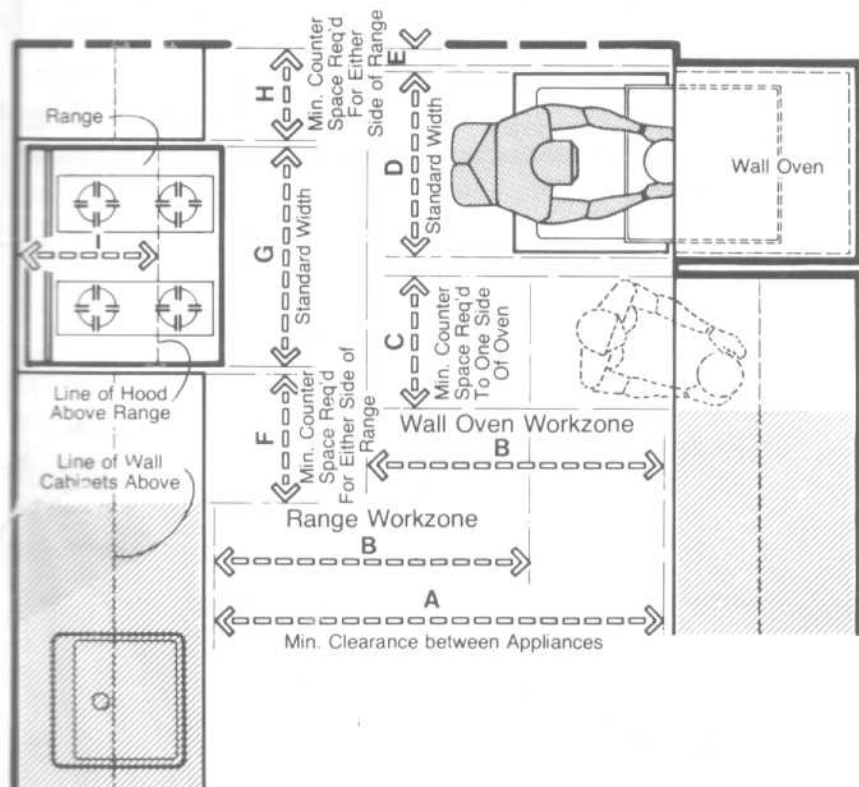


Fig. 1

The height of a kitchen workcounter, the proper clearance between cabinets or appliances for circulation, the accessibility to overhead or undercounter storage, and proper visibility are among the primary considerations in the design of cooking spaces. All must be responsive to human dimension and body size if the quality of interface between the user and the components of the interior space are to be adequate. In establishing clearances between counters, the maximum body breadth and depth of the user of larger body size must be taken into account as well as the projections of the appliances. Refrigerator doors, cabinet drawers, dishwashing machine doors, and cabinet doors all project to some degree in their open position into the space within which the user must circulate and must be accommodated.

Standard kitchen counter heights manufactured are all about 36 in, or 91.4 cm. But such a height does not necessarily accommodate the body dimension of all users for all tasks. Certain cooking activities, for example, may be more efficiently performed from a standing position, but with a counter height less than 36 in. In overhead cabinets the upper shelves are usually inaccessible to the smaller person, while the lower shelves are usually inaccessible to most without bending or kneeling. The logical answer is the development of kitchen cabinet systems capable of total adjustability to accommodate the human dimension of the individual user. Such a system could accommodate not only those of smaller and larger body size, but also elderly and disabled people.

Figure 1 provides some general anthropometric data for establishing basic heights of cabinetry and appliances above the floor. Figures 2 and 3 show in more detail the interface of the human body and the kitchen environment.



RANGE CENTER

Fig. 2

	in	cm
A	48 min.	121.9 min.
B	40	101.6
C	15	38.1 min.
D	21-30	53.3-76.2
E	1-3	2.5-7.6
F	15 min.	38.1 min.
G	19.5-46	49.5-116.8
H	12 min.	30.5 min.
I	17.5 max.	44.5 max
J	96-101.5	243.8-257.8
K	24-27.5	61.0-69.9
L	24-26	61.0-66.0
M	30	76.2
N	60 min.	152.4 min.
O	35-36.25	88.9-92.1
P	24 min.	61.0 min.
Q	35 max.	88.9 max.

## KITCHENS

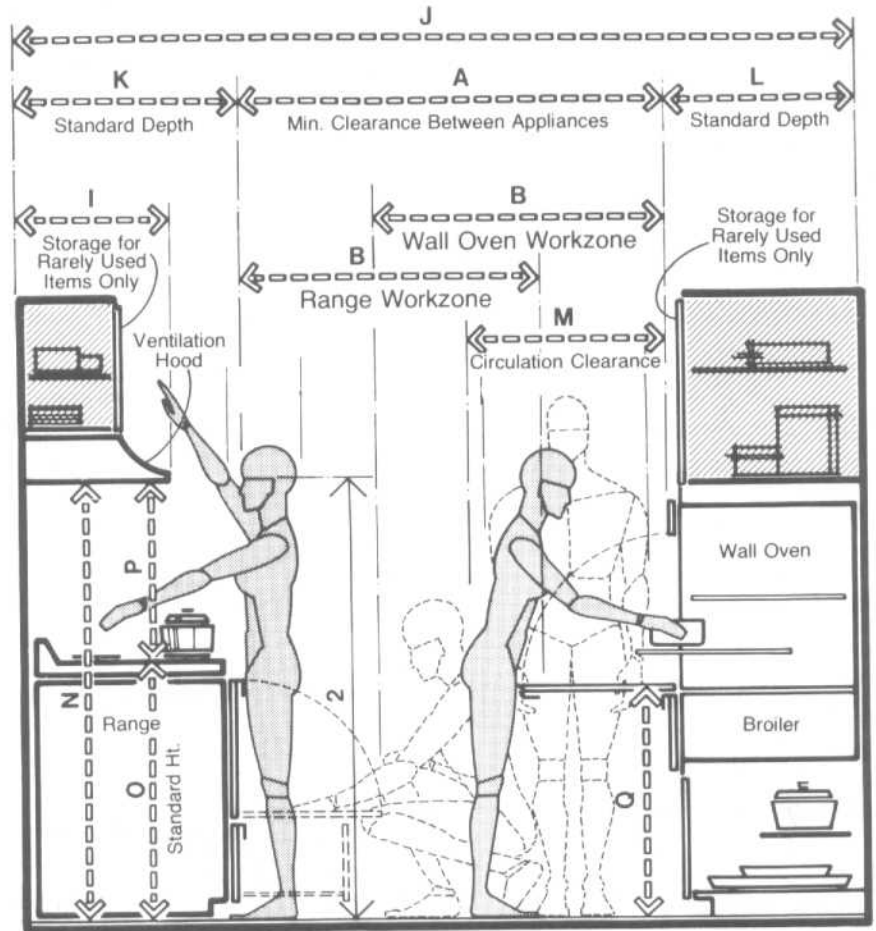
## Anthropometric Data

Figures 2 and 3 illustrate the clearances related to range centers. Figure 2 indicates a minimum clearance between appliances of 48 in, or 121.9 cm. The anthropometric basis for the clearances are amplified in Fig. 3.

The 40-in, or 101.6-cm, wall oven workzone clearance is adequate to accommodate the projected wall oven door, in addition to the maximum body depth dimension of the user. The standing figure shown in broken line, however, indicates both dimensionally and graphically that the 40-in clearance will not permit comfortable circulation when appliances on both sides are in operation at the same time. The range workzone clearance, also 40 in, is adequate to accommodate the open range door and the body size of the kneeling user.

An extremely important, but frequently overlooked, anthropometric consideration in kitchen design is eye height. In this regard, the distance from the top of the range to the underside of the hood should allow the rear burners to be visible to the user.

	in	cm
A	48 min.	121.9 min.
B	40	101.6
C	15	38.1 min.
D	21-30	53.3-76.2
E	1-3	2.5-7.6
F	15 min.	38.1 min.
G	19.5-46	49.5-116.8
H	12 min.	30.5 min.
I	17.5 max.	44.5 max
J	96-101.5	243.8-257.8
K	24-27.5	61.0-69.9
L	24-26	61.0-66.0
M	30	76.2
N	60 min.	152.4 min.
O	35-36.25	88.9-92.1
P	24 min.	61.0 min.
Q	35 max.	88.9 max.



## RANGE CENTER

Fig. 3



Fig. 4 U-shaped plans. If dishwasher is desired, it should be located at sink center.

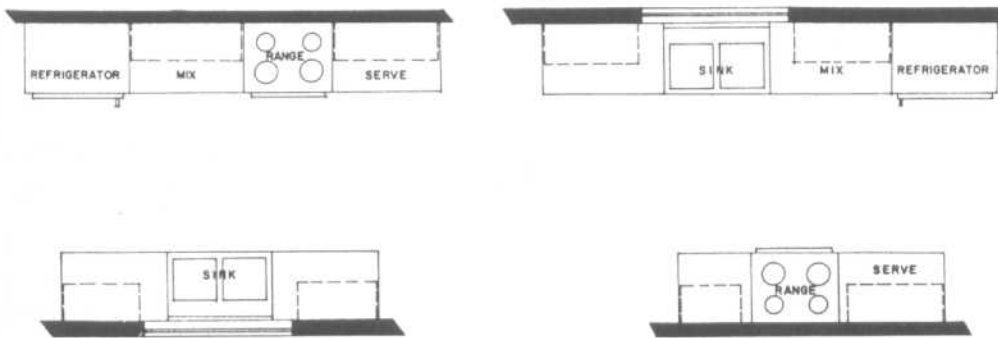


Fig. 5 Corridor plans. If dishwasher is desired, it should be located at sink center.

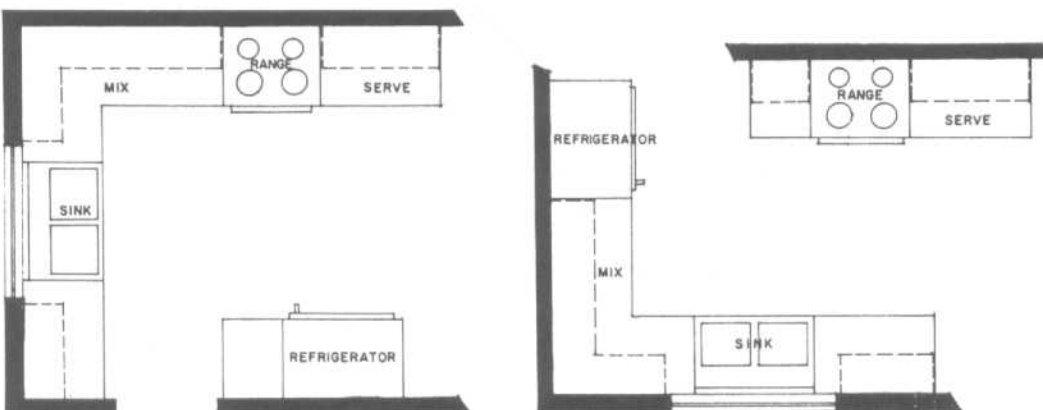


Fig. 6 Broken U-shaped plans. If dishwasher is desired, it should be located at sink center.

The U-shaped plan is the most efficient. When not broken, it provides the opportunity and floor space for several simultaneous activities. The corridor or gallery kitchen is typically accessible from both ends, often converting it from a work space to a corridor. It sometimes is closed off on one end, thereby creating a variation of the U-plan, which although small can produce a fairly comfortable kitchen.

The broken U-shaped plan often results from the necessity of locating a door along one or two of the three walls of a typical U-shaped scheme. The resulting through traffic reduces the compactness and efficiency of the plan.

The typical L-shaped kitchen allows for the location of a small breakfast area in the opposite corner.

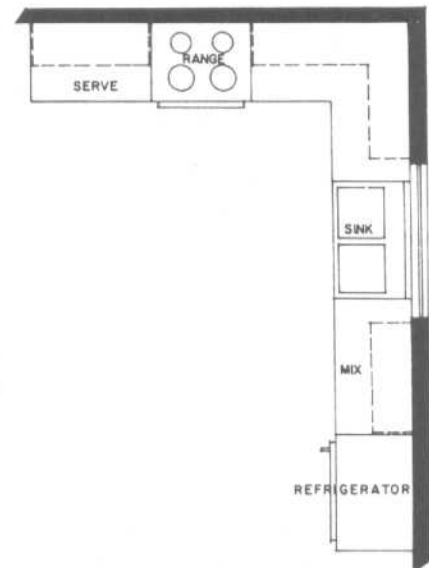


Fig. 7 L-shaped plan. If dishwasher is desired, it should be located at sink center.

KITCHENS

Typical Layouts

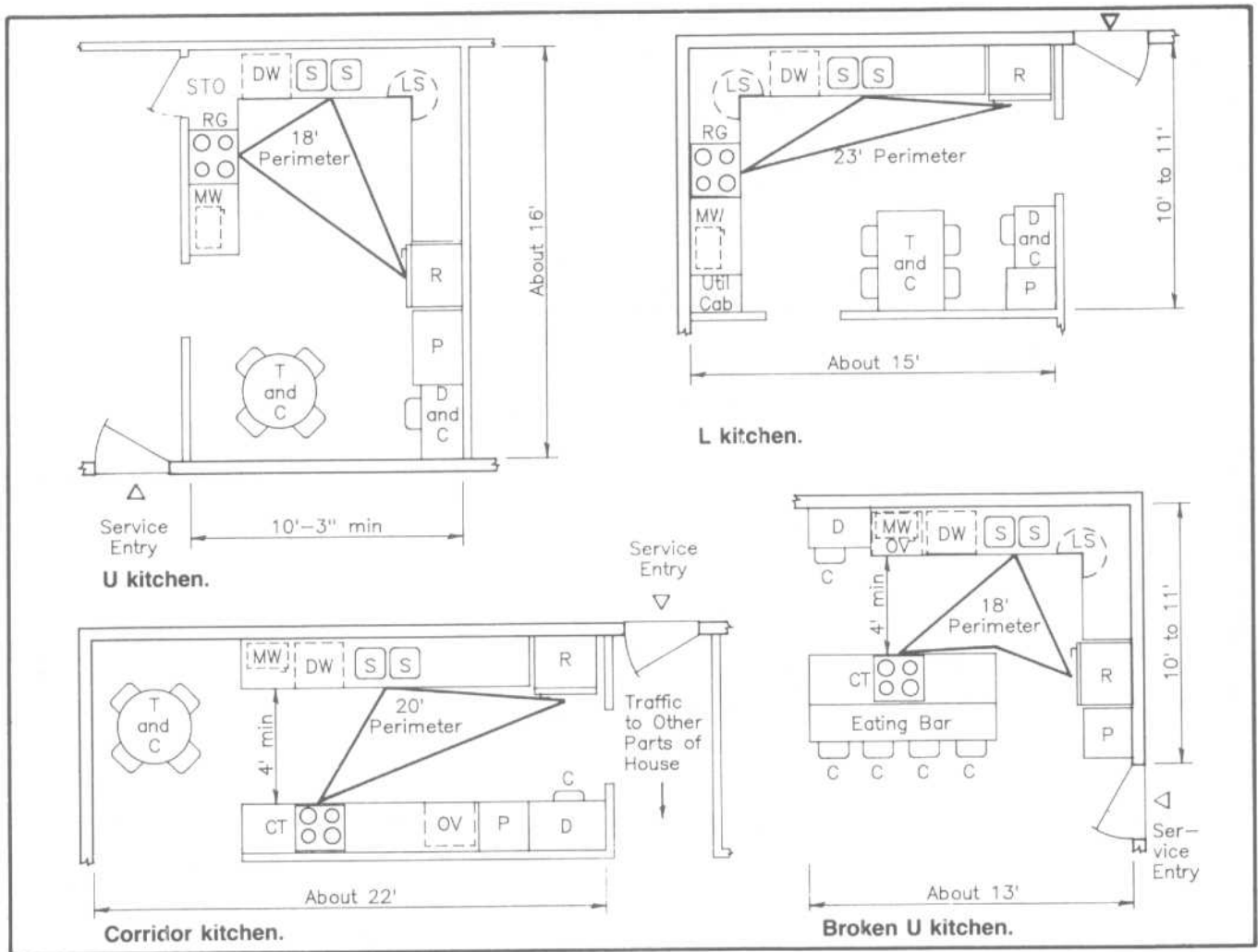
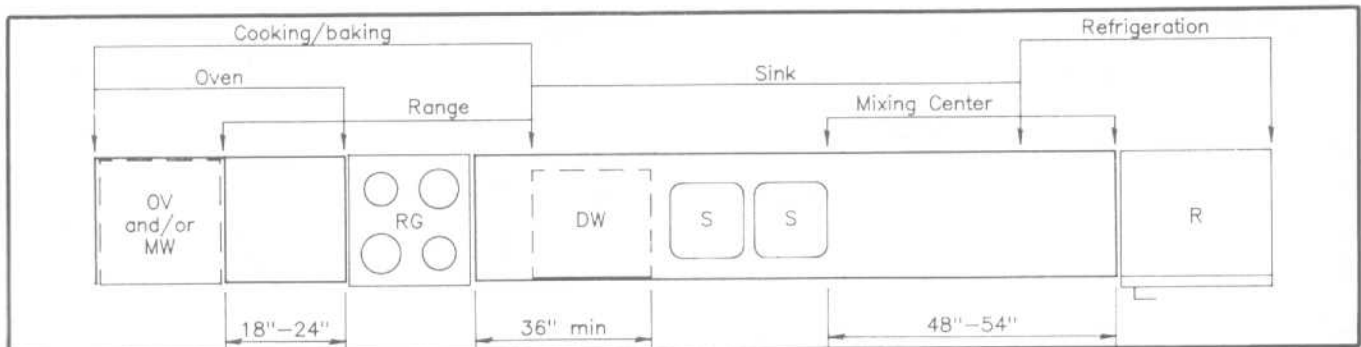


Fig. 8 These diagrams illustrate further variations of the typical plans shown in Figs. 4 to 7. A triangle perimeter of 23'0" or less is usually indicative of a relatively efficient kitchen layout.



Minimum counter frontage.  
For combined work centers.

KITCHENS

Clearances

**Space Criterion**

The size of the kitchen should be determined by the number of bedrooms provided in the living unit. Work centers for the following equipment, cabinets, and space for their use should be provided:

1. Range space with base and wall cabinet at one side for serving and storage of utensils and staples.
2. Sink and base cabinet with counter space on each side for cleanup. Wall cabinets for storage of dinnerware.
3. Refrigerator space with counter space at latch side of the refrigerator door.

4. Mixing counter and base cabinet for electrical appliances and utensil storage. Wall cabinet for staple storage.

**Recommended minimum edge distance**  
Equipment should be placed to allow for efficient operating room between it and any adjacent corner cabinet. At least 9 in from the edge of the sink and range and 16 in at the side of the refrigerator is recommended.

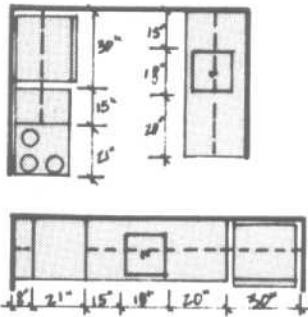
**Circulation space** A minimum of 40 in should be provided between base cabinets or appliances opposite each other. This same minimum clearance applies when a wall,

storage wall, or work table is opposite a base cabinet.

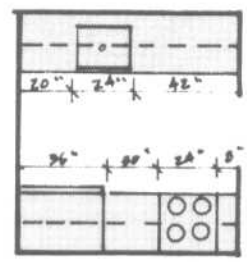
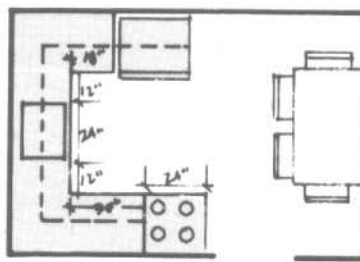
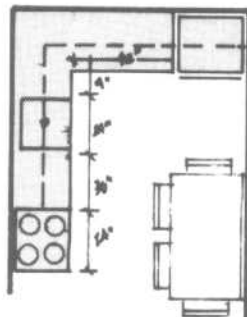
**Traffic** Traffic in the kitchen should be limited to kitchen work only. Serving circulation to the dining area should be without any cross traffic.

**Height of shelving and counter tops**

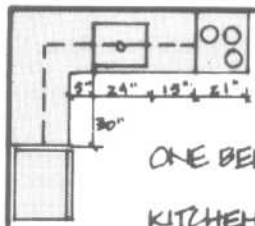
1. Maximum height of wall shelving 74 in. Height of counter tops should be 36 in.
2. Minimum clearance height between sink and wall cabinet 24 in; between base and wall cabinets 15-in clearance.



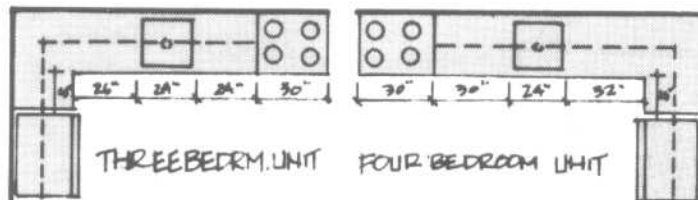
ZERO BEDRM.  
KITCHENETTE



TWO BEDROOM  
LIVING UNIT KITCHENS

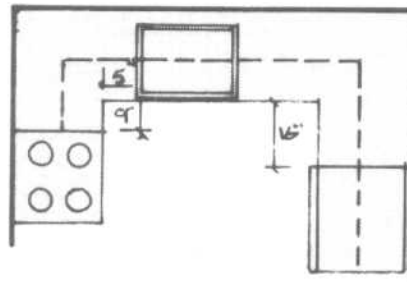


ONE BEDROOM  
KITCHENETTE



THREE BEDRM. UNIT    FOUR BEDROOM UNIT

MIN. FRONTAGES FOR VARIOUS KITCHENS



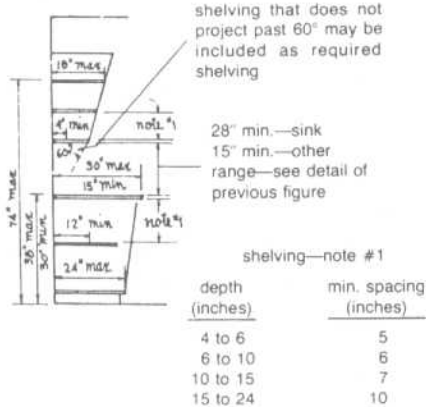
MIN. EDGE DISTANCES

KITCHENS

Storage and Cabinets

KITCHEN STORAGE

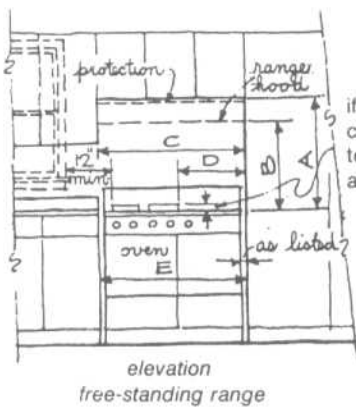
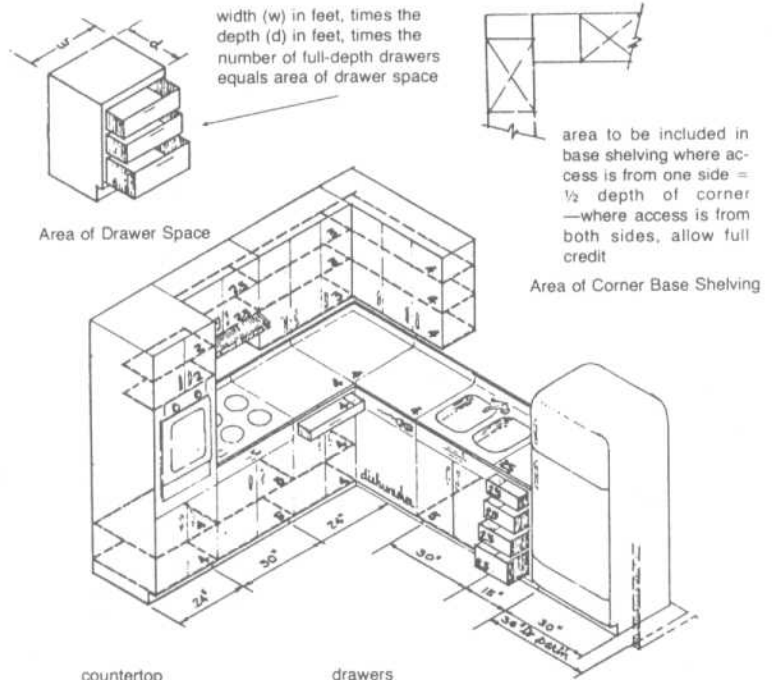
Each kitchen or kitchenette should have (1) accessible storage space for food and utensils, (2) sufficient space for the average kitchen accessories, (3) sufficient storage space for those items of household equipment normally used and for which storage is not elsewhere provided.



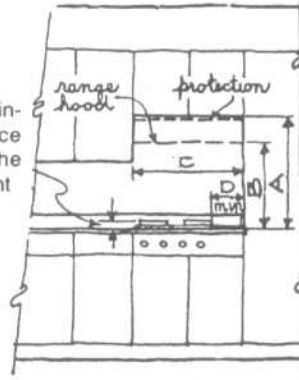
Height, Depth, and Spacing of Shelving and Countertop

wall shelving	base shelving	countertop	drawers
2 s. ft. x 2 = 4 s. ft.	4 s. ft. x 4 = 16 s. ft.	4 s. ft. x 3 = 12 s. ft.	4 s. ft. x 1 = 4 s. ft.
2.5 x 2 = 5	5 x 3 = 15	2.5 x 1 = 2.5	2.5 x 4 = 10
3 x 3 = 9	2 x 2 = 4	total 14.5 s. ft.	total 14 s. ft.
4 x 3 = 12	total 35 s. ft.		
total 30 s. ft.			

Fig. 9 Example: measurement of shelf and countertop areas.



if more than 3/4" increase clearance to cabinet by the additional amount



CLEARANCES OVER COOKING RANGES

In Fig. 10, dimension A: 2 ft 6 in minimum clearance between the top of the range and the bottom of an unprotected wood or metal cabinet, or 2 ft 0 in minimum when the bottom of a wood or metal cabinet is protected.

Dimension B: 2 ft 0 in minimum when hood projection X is 18 in or more, or 1 ft 10 in min. when hood projection X is less than 18 in.

Dimension C: not less than width of range or cooking unit.

Dimension D: 10 in minimum when vertical side surface extends above countertops.

Dimension E: when range is not provided by builder, 40 in minimum.

Dimension F: Minimum clearance should be not less than 3 in.

Cabinet protection should be at least 1/4 in asbestos millboard covered with not less than 28-gauge sheet metal (0.015 stainless steel, 0.024 aluminum, or 0.020 copper).

Clearance for D, E, or F should be not less than listed UL or AGA clearances.

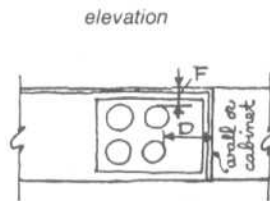
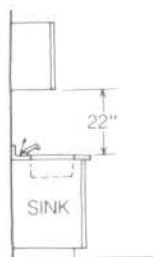
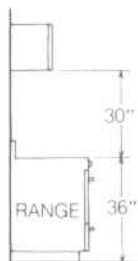


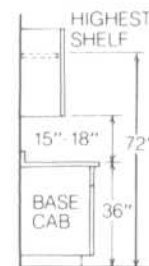
Fig. 10



ABOVE SINK



ABOVE RANGE



ABOVE BASE CAB

Above a sink, plan for a minimum of 22 in. to the bottom of a wall cabinet. Since the wall behind a sink often holds a window, measurement for a cabinet is academic. But if wall space is minimal, a cabinet over the sink makes good sense.

The use of large pans, pancake flips and similar cooking maneuvers dictate a distance of 30 in. between rangetop and wall cabinet bottom. A fan mounted in the wall is the means here to exhaust cooking fumes to the outside.

A range of 15 in. to 18 in. is the proper span between standard base and wall cabinets. Opt for the 15 in. distance if you are 5 ft. 4 in. or less; a wider span if you're taller. The highest shelf: 6 ft. from the floor, is a reachable distance.

Kitchen activities become tiresome in poor light. A single fixture, centered on the ceiling is insufficient. Your need for light is greatest over the work centers. A good light there reduces the danger of cutting yourself; eases the task of monitoring color changes during a mix, and so on. The best place to install fixtures for this purpose is beneath the wall cabinets (with a shield to prevent glare when you're seated in the kitchen). A workable alternative is found in fixtures installed in an extended soffit. Plan for light above a rangetop and over the sink, as well. Choose incandescent, deluxe warm white or deluxe cool white lamps for the fixtures to avoid poor color rendition.



KITCHEN LIGHTING

#### Utensil and General Storage

Space for utensils includes storage for dishes, pots and pans, utensils, and appliances. With the increased use of such electrical appliances, their storage becomes a significant problem. General storage requires space for linens, towels, and kitchen supplies. Included in this category are brooms, mops, and other cleaning equipment and supplies.

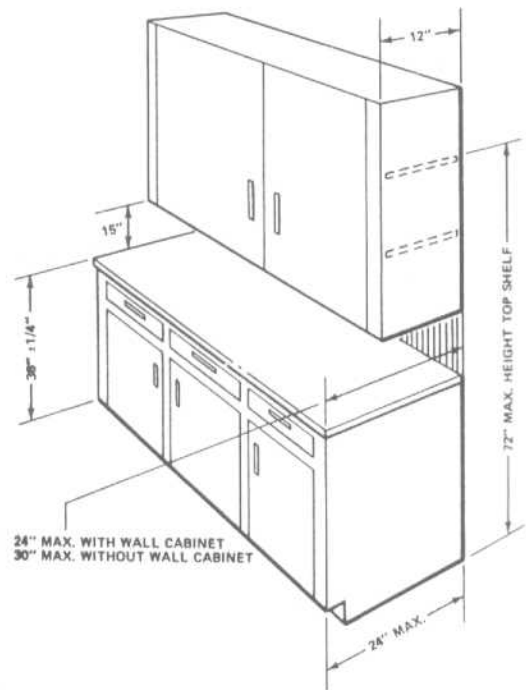
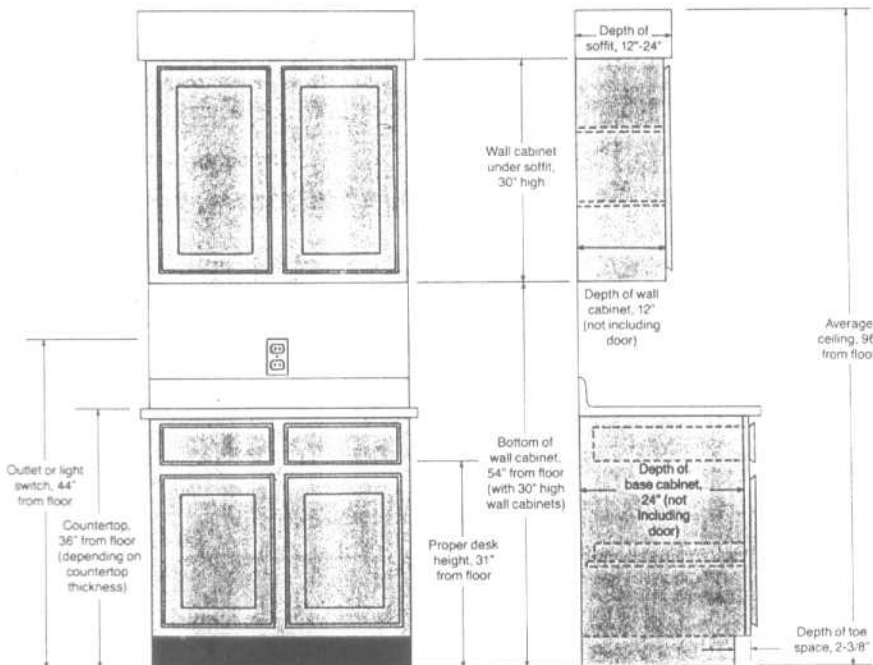
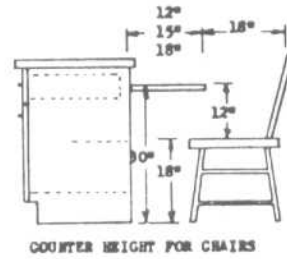
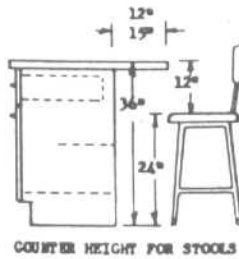
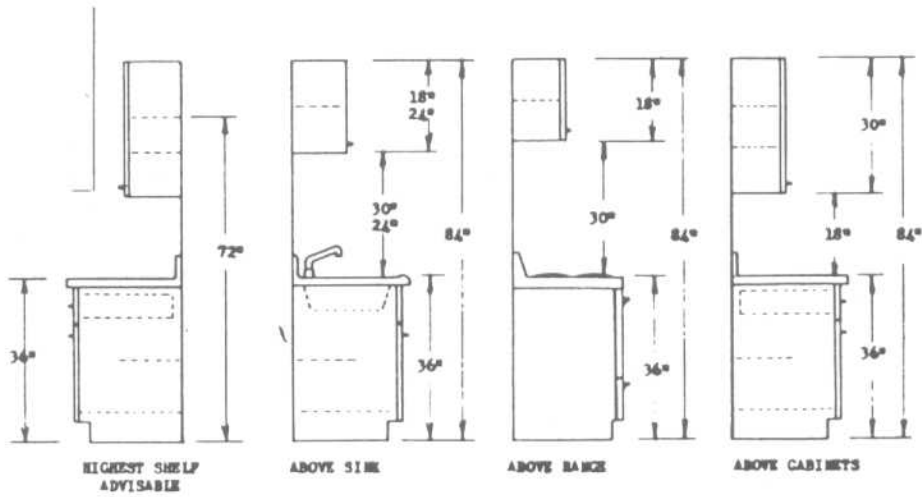
TABLE 1 Minimum Kitchen Storage Required

Item	40 to 60 ft <sup>2</sup> Area — Kitchenette	
	0-bedroom living unit,* ft <sup>2</sup>	1-bedroom living unit,* ft <sup>2</sup>
Total shelving in wall and base cabinets	24	30
Shelving in either wall or base cabinets	10	12
Drawer area	4	5
Countertop area	5	6
Item	60 ft <sup>2</sup> Area and Over — Kitchen	
	1- and 2-bedroom living units, ft <sup>2</sup>	3- and 4-bedroom living units, ft <sup>2</sup>
Total shelving in wall and base cabinets	48	54
Shelving in either wall or base cabinets	18	20
Drawer area	8	10
Countertop area	10	12

\*Kitchen unit assemblies serving the kitchen function and occupying less than 40 ft<sup>2</sup> area in 0-BR living units shall not be less than 5 ft in length and shall provide at least 12 ft<sup>2</sup> of total shelving in wall and base cabinets. Drawer and countertop space shall also be provided. No room count is allowable for this type facility.

KITCHENS

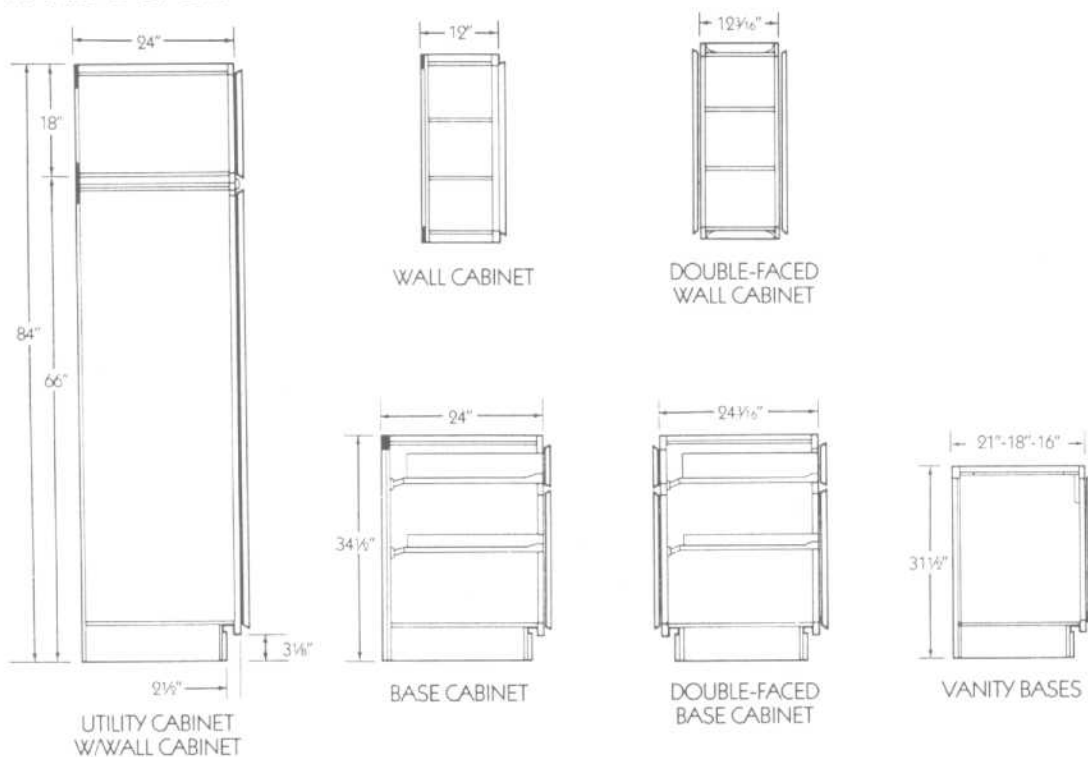
Cabinet Dimensions



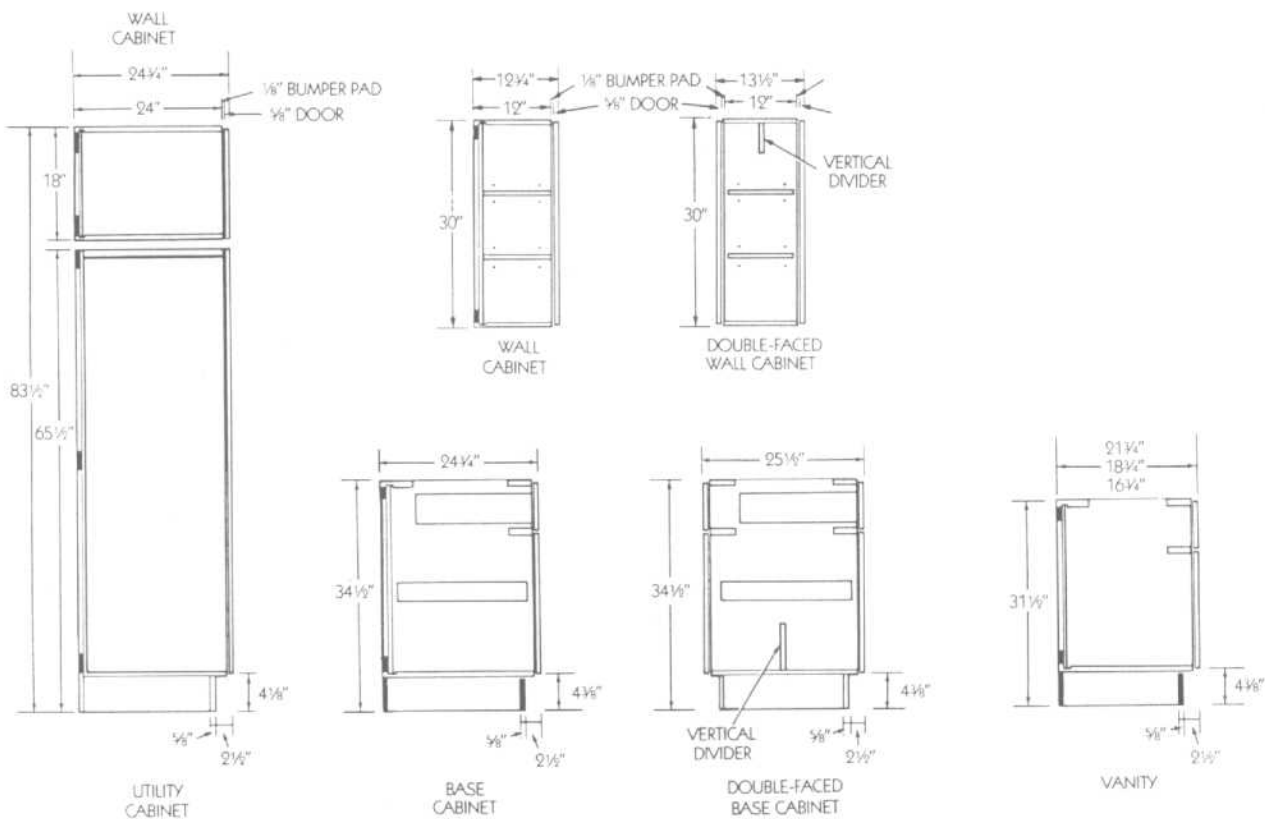
Example of the proper dimensional limits and relative placement of kitchen base cabinets and wall cabinets



FRAMED CABINETRY



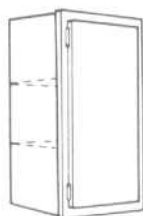
FRAMELESS CABINETRY



KITCHENS

Cabinet Sizes

FRAMED



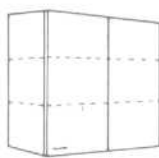
FRAMELESS



WALL CABINETS

Wall cabinets are available in heights of 42", 30", 24", 18", 15", and 12". Most cabinets are available in widths ranging from 9" to 48", in 3" increments. Framed wall cabinets are 12"

deep, not including doors. Frameless wall cabinets are 12 $\frac{3}{4}$ " deep, including doors.

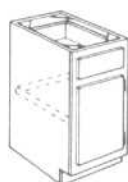


WALL BLIND CORNER CABINETS

Wall blind corner cabinets are available in heights of 42", 30" and 24". Most wall blind corner cabinets are available in widths of 24", 27", 30", 33", 36", 42", and 48".

DOUBLE-FACE WALL CABINETS

Double-face wall cabinets are available in heights of 30", 24" and 18". Most are available in widths of 18", 24", 30", 36", 42" and 48". Framed cabinets are 13 $\frac{1}{16}$ " deep with doors. Frameless are 13 $\frac{1}{8}$ " deep with doors.



BASE CABINETS

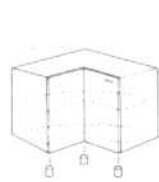
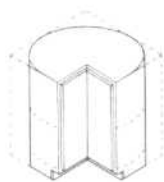
All base cabinets are 34 $\frac{1}{2}$ " tall. Most are available in widths ranging from 9" to 48", in 3" increments. Framed base cabinets are 24" deep, not including doors. Frameless base cabinets are 24 $\frac{3}{4}$ " deep, including doors.

Four-drawer base cabinets are available in widths ranging from 12" to 24", in 3" increments. Frameless base cabinets are also available in a three-drawer style in widths of 30" and 36".



BASE BLIND CORNER CABINETS

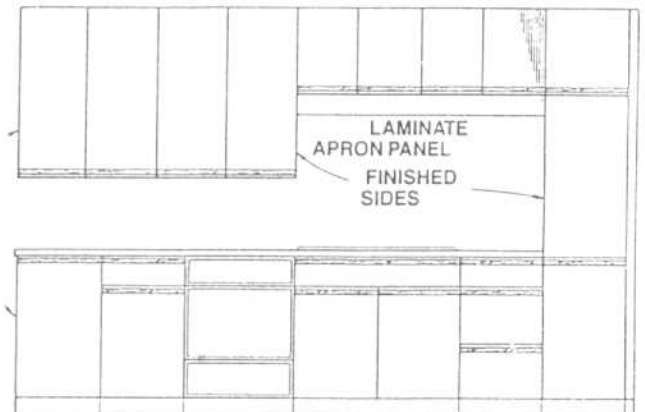
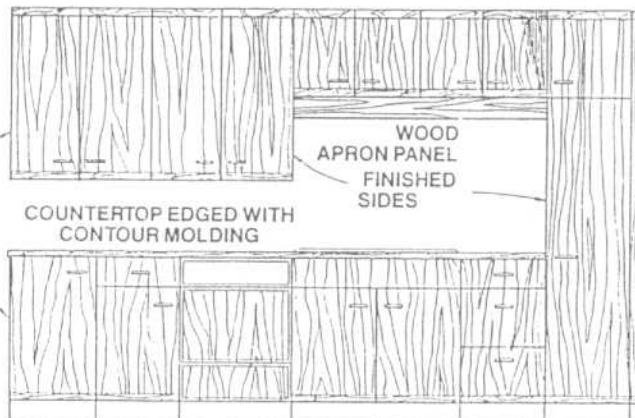
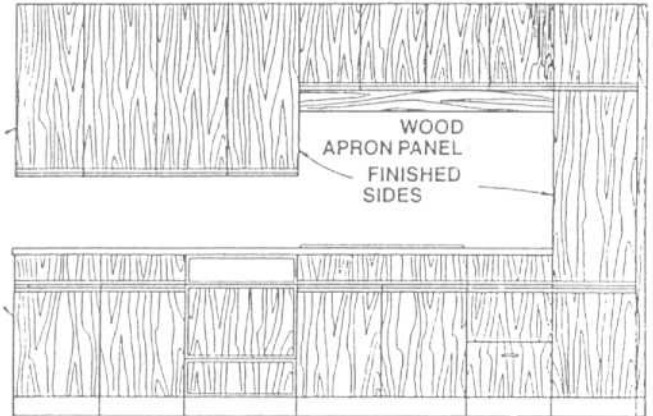
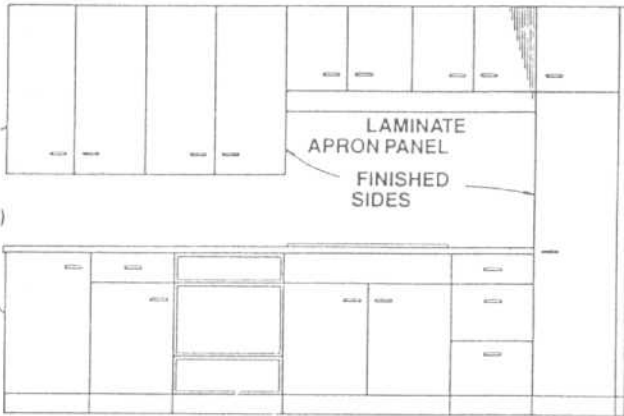
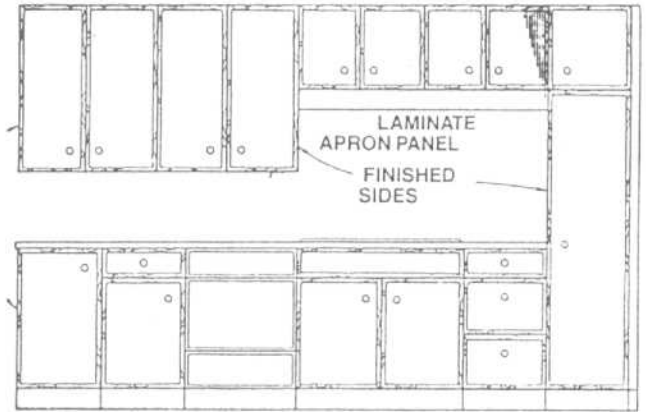
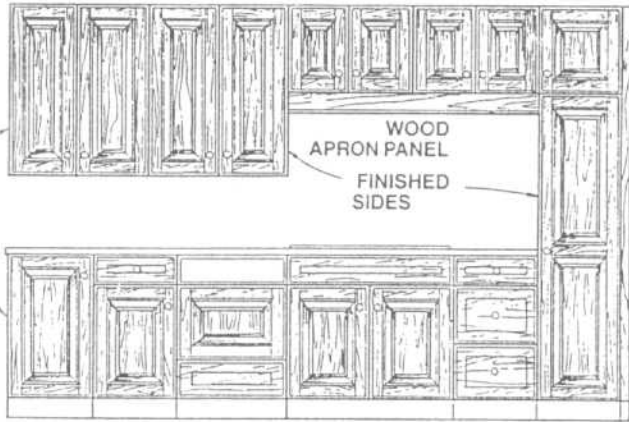
All base blind corner cabinets are 34 $\frac{1}{2}$ " high. Most are available in widths of 24", 30", 36", 39", 42", and 48".



SPECIALTY CABINETS

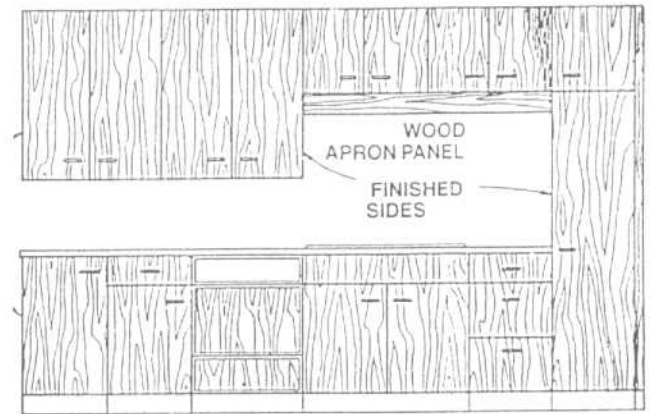
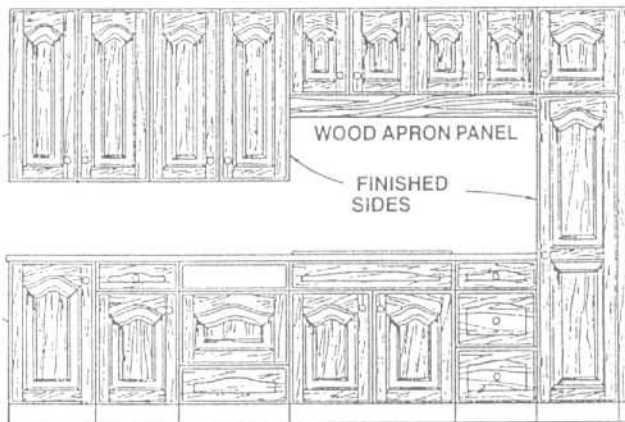
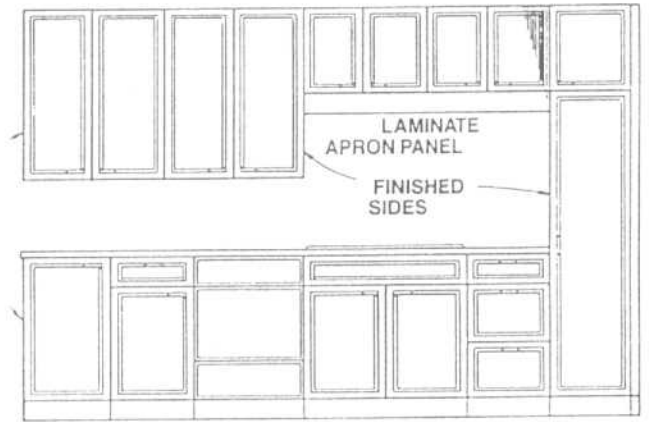
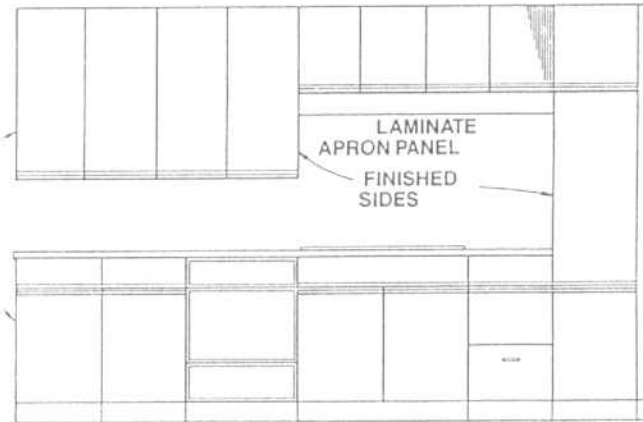
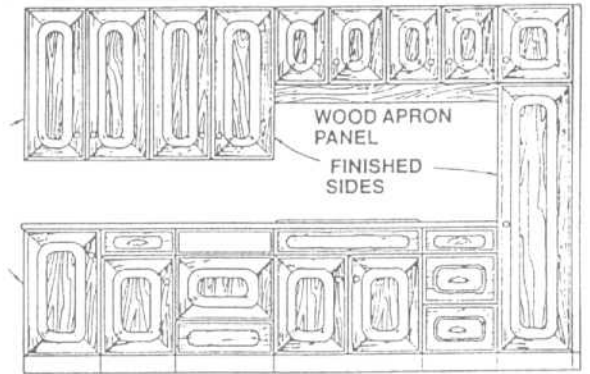
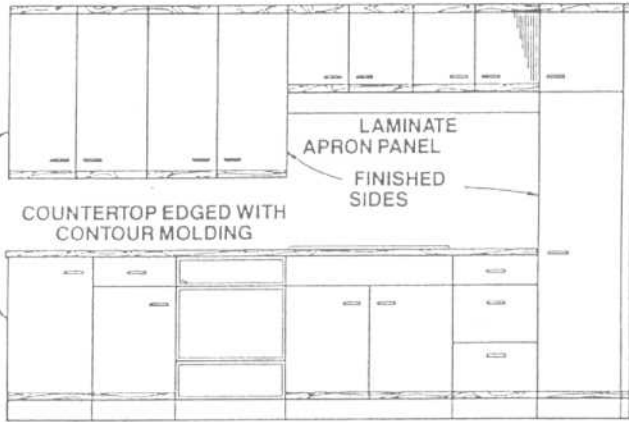
- Lazy Susans:  
36"-Wide
- Range Hoods: (framed only)  
36" & 30"-Wide
- Wall What-Not Shelves: (framed only)  
30"-High
- Base Open Shelves: (framed only)  
34 $\frac{1}{2}$ "-High
- Pantries: (framed only)  
36" x 66"
- Utility Cabinets: (framed)  
24" x 66"  
18" x 66"  
In 12" and 24" Depths
- Utility Cabinets: (frameless)  
24" x 65 $\frac{1}{2}$ "  
18" x 65 $\frac{1}{2}$ "  
In 12 $\frac{3}{4}$ " and 24 $\frac{3}{4}$ " Depths

- Tilt-Out Range Hoods: (frameless only)  
30" x 24"
- Glass Door Wall Cabinets: (frameless only)  
30" & 36"-Wide
- Microwave Cabinets: (framed only)  
30" x 21"
- Microwave Shelves:  
30" x 22 $\frac{1}{2}$ " (framed)  
30" x 18" (frameless)
- Oven Cabinets: (framed)  
27" x 66"  
30" x 66"  
33" x 66"
- Oven Cabinets: (frameless)  
27" x 65 $\frac{1}{2}$ "  
30" x 65 $\frac{1}{2}$ "  
33" x 65 $\frac{1}{2}$ "
- Up to six 6" drawers can be added to frameless oven cabinets.



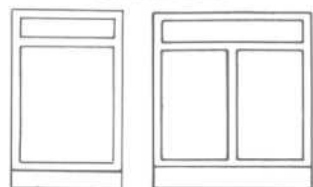
KITCHENS

Cabinet Types and Dimensions



## Sink Cabinets & Fronts

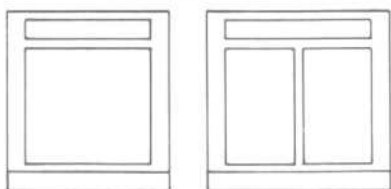
### SINK BASES



SB24 L or R  
SF24 L or R  
(Non-Trimable)

SB27 SB36  
SB30 SB42  
SB33 SB48

### SINK FRONTS

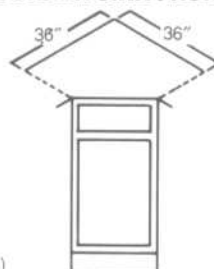


- SF30 L or R

+ SF30 SF42  
SF36 SF48

+ SF30 (Without L or R Available in Nordic™- Not Shown)  
(Trimable 3" per side Except Nordic™ Non-Trimable)

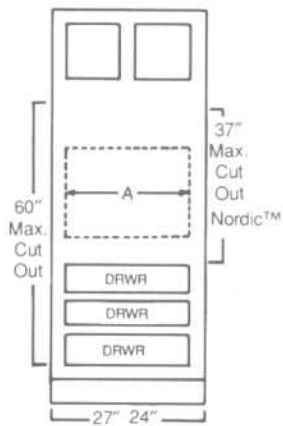
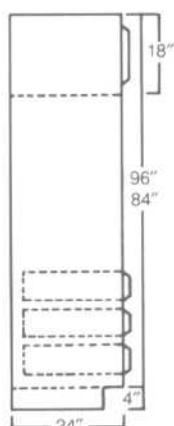
### CORNER SINK FRONT



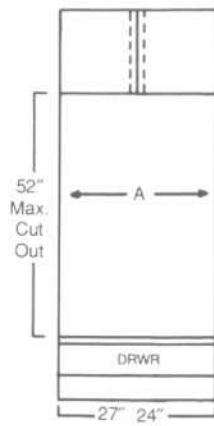
\* CSF36 L or R

## Oven Cabinets & Drop-In Range Fronts

### OVEN CABINETS

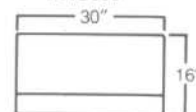


\* OV24Dx96  
\* OV27Dx96  
OV24D  
OV27D



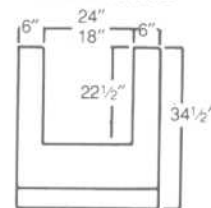
\* OV24Sx96  
\* OV27Sx96  
+ OV24S  
+ OV27S

### DROP-IN RANGE FRONT



\* DORF30  
(Trimable Height & Width)

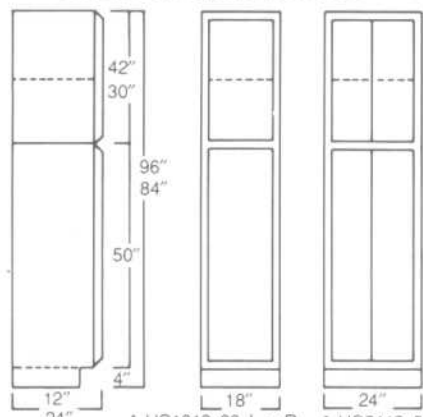
### UNIVERSAL DROP-IN RANGE FRONTS



\* UDRF30  
\* UDRF36  
(Trimable Cut-Out)

## Utility Cabinets/Fronts & Pantry Cabinet

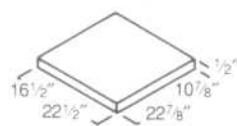
### UTILITY CABINETS/FRONTS



\* UC1812x96 L or R  
\* UC1824x96 L or R  
- UCF1896 L or R  
UC1812 L or R  
UC1824 L or R  
- UCF18 L or R

\* UC2412x96  
\* UC2424x96  
- UCF24x96  
\* UC2412  
\* UC2424  
- UCF24

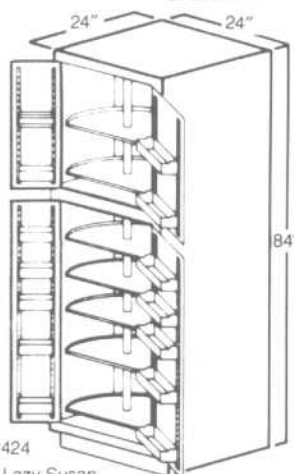
### UTILITY CABINET SHELVES



(width) UCS1812 (depth)  
UCS1824  
UCS2412  
UCS2424  
(Shipped 1 Shelf with 4 Shelf Supports)

(Utility Fronts are Non-Trimable)

### PANTRY CABINET

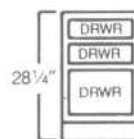


\* PC2424

(Includes - Lazy Susan Shelves & Racks.) Available in Oak Lines, Except Oakcrest,™ Euro,™ X-Line,™ & Spartan™

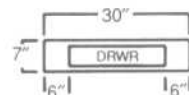
## Desk Cabinets

### DESK UNIT



\* KDB15

### KNEE HOLE DRAWER



\* KD30

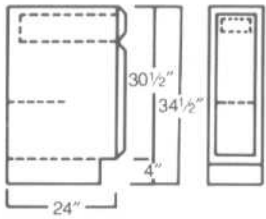
(Trimable 3" per side)

### DESK END PANEL

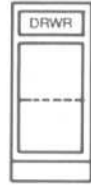
**KITCHENS**

Cabinet Types and Dimensions

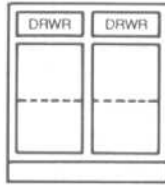
**BASE CABINETS**



▲ B9 L or R  
(Concealed Drawer)



B12 L or R  
B15 L or R  
B18 L or R  
B21 L or R  
B24 L or R



B27 B36  
B30 B42  
B33 B48

**DRAWER BASE CABINETS**



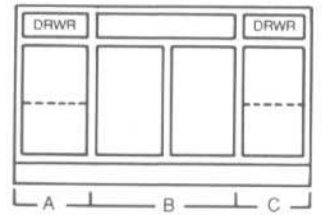
DB12  
DB15  
DB18  
DB21  
DB24

**SPECIAL DRAWER BASE CABINET**



- DB18CB  
(Includes — Cutting Board, Cutlery Divider & Metal Bread Box.)

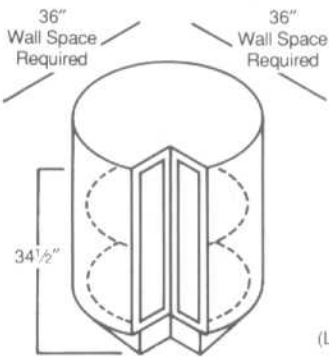
**COMBINATION SINK BASE CABINETS**



	A	B	C
* SB60	15"	30"	15"
* SB66	15"	36"	15"
* SB72	18"	36"	18"

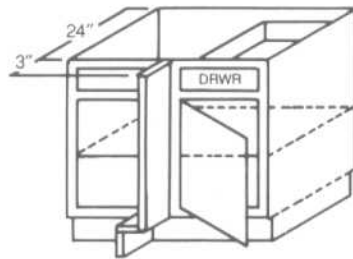
▲ No Arched Door.  
■ No Center Medallion. (Saxony)

**ROTATING CORNER BASE CABINET**



■ CAR36

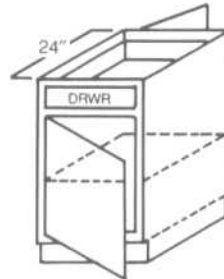
**BLIND CORNER BASE CABINETS**



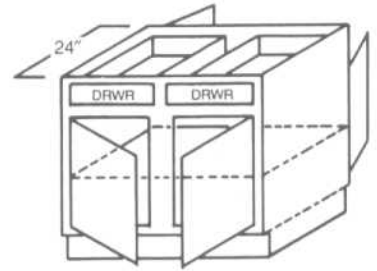
(L-Shown, 3" Filler included, must use to allow doors to clear.)

BLB39 L or R (Pullable 6")  
BLB42 L or R (Pullable 6")  
\* BLB48 L or R (Pullable 4")

**PENINSULA BASE CABINETS**



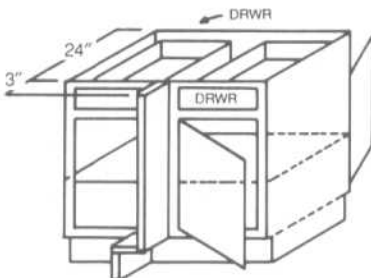
\* PB24



\* PB30  
\* PB36

(Drawers open on one side only in Peninsula Cabinet.)

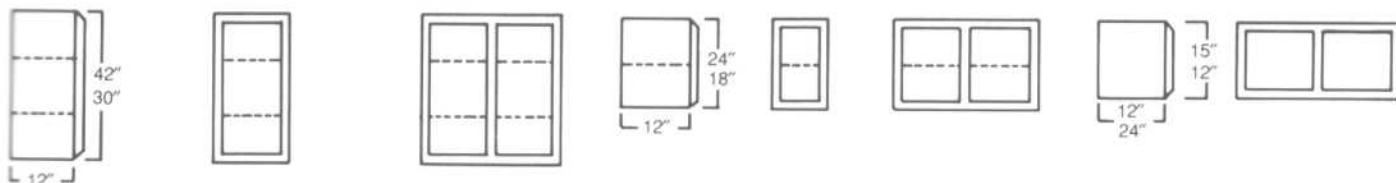
**BLIND PENINSULA BASE CABINETS**



(L-Shown, 3" Filler included, must use to allow doors to clear.)

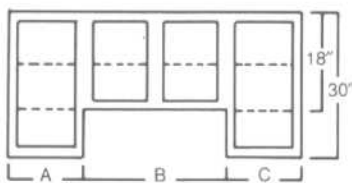
\* BLPB42 L or R (Pullable 6")  
\* BLPB48 L or R (Pullable 6")

**WALL CABINETS**



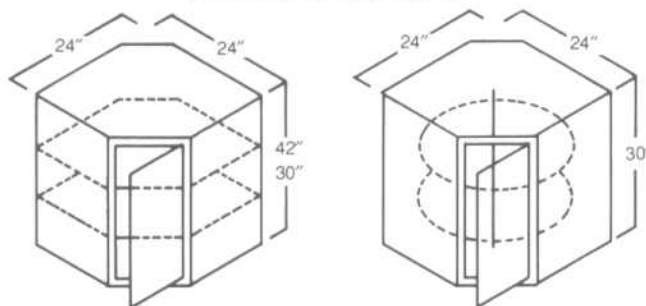
- \* W1242 L or R    \* W1224 L or R    W3024    W2418
  - \* W1542 L or R    \* W1524 L or R    \* W3624    W3018
  - \* W1842 L or R    \* W1824 L or R    \* W4224    W3318
  - \* W2142 L or R    \* W2124 L or R    \* W4824    W3618
  - \* W2442 L or R    \* W2424 L or R               W4218
- ▲ \* W930 L or R    \* W2742    W2730
  - W1230 L or R    \* W3042    W3030
  - W1530 L or R    \* W3342    W3330
  - W1830 L or R    \* W3642    W3630
  - W2130 L or R    \* W4242    W4230
  - W2430 L or R    \* W4842    W4830
- W3015    \* W3015x24    ■ W3012
  - W3315    \* W3315x24    ■ W3612
  - W3615    \* W3615x24

**COMBINATION WALL CABINETS**



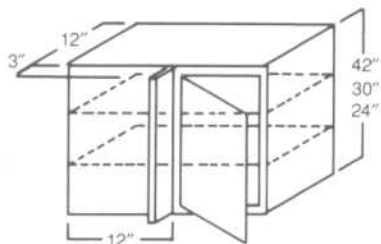
- |         |     |     |     |
|---------|-----|-----|-----|
|         | A   | B   | C   |
| - CWC60 | 15" | 30" | 15" |
| - CWC66 | 18" | 30" | 18" |
| - CWC72 | 21" | 30" | 21" |
- (Fixed Shelves)

**CORNER WALL CABINET**



- \* CW2442 L or R    CWS2430 L or R
- CW2430 L or R    (2 Adjustable
- (Fixed Shelves)    Rotary Shelves)

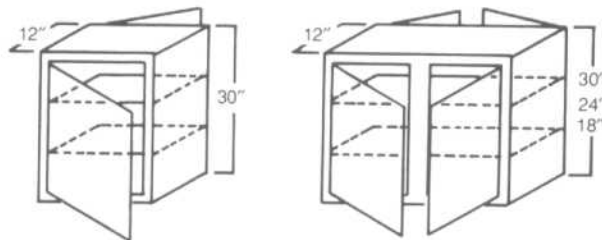
**BLIND CORNER WALL CABINETS**



(L-Shown, 3" Filler included, must use to allow doors to clear.)

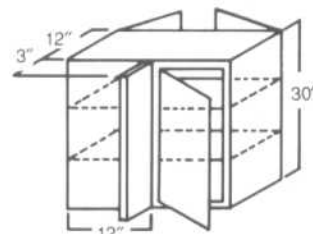
- \* BLW2742 L or R    BLW2730 L or R    \* BLW2724 L or R
- \* BLW3042 L or R    BLW3030 L or R    \* BLW3624 L or R
- \* BLW3642 L or R    BLW3630 L or R
- \* BLW4242 (2 Doors) L or R    BLW4230 (2 Doors) L or R
- \* BLW4842 (2 Doors) L or R    \* BLW4830 (2 Doors) L or R

**PENINSULA WALL CABINETS**



- \* PW2430    \* PW3030    \* PW3024    \* PW3018
- \* PW3630    \* PW3624    \* PW3618    \* PW4218

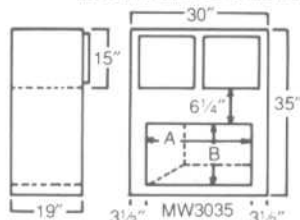
**BLIND PENINSULA CORNER WALL CABINET**



(L-Shown, 3" Filler included, must use to allow doors to clear.)

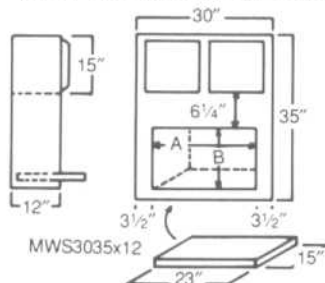
- \* BLPW2730 L or R

**MICROWAVE CABINET**



- A: 22" Minimum    B: 13 3/4" Minimum
- 28" Maximum    19 1/8" Maximum

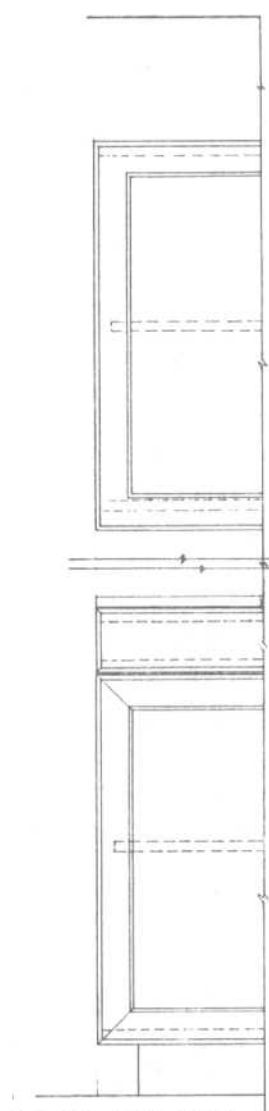
**MICROWAVE CABINET W/SHELF**



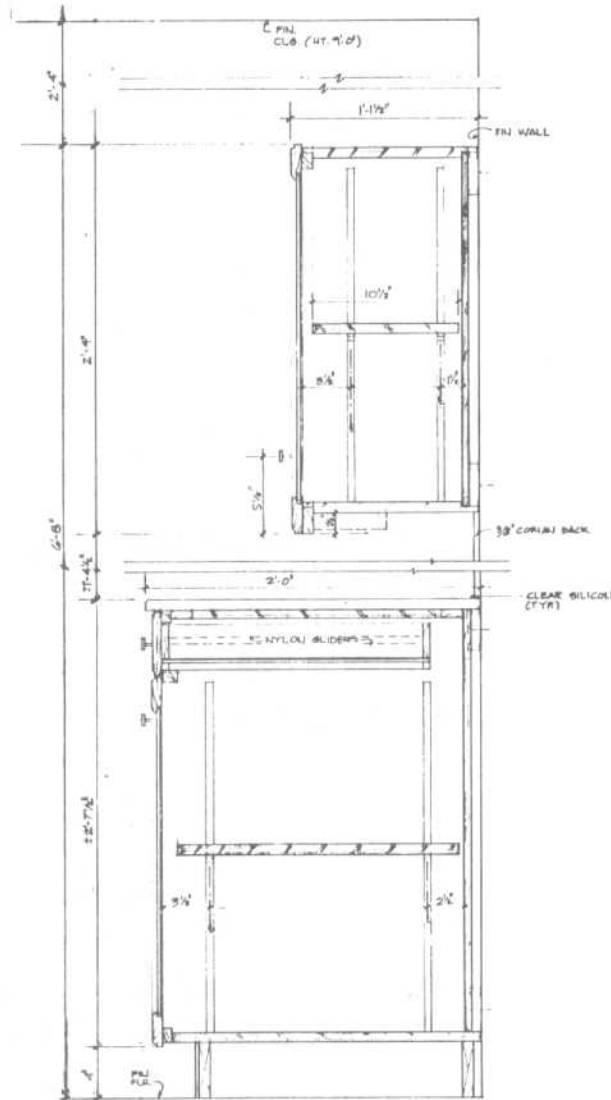
- MWS3035x12

KITCHENS

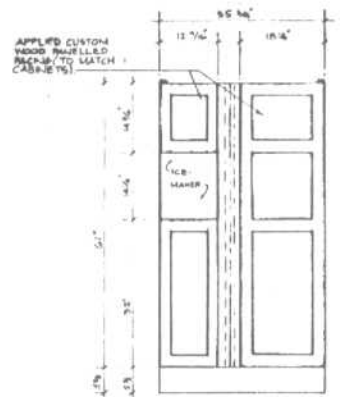
Cabinet Types and Dimensions



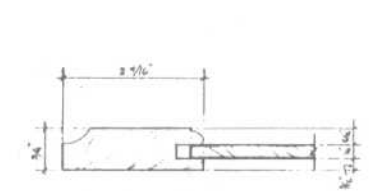
PARTIAL ELEVATION  
SCALE: 3/4"=1'-0"



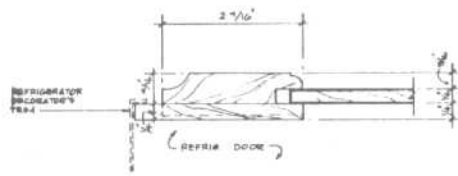
SECTION A  
SCALE: 3/4"=1'-0"



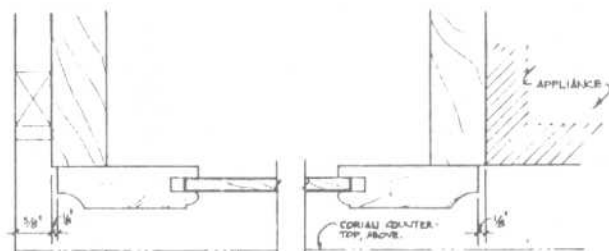
REFRIGERATOR ELEVATION  
SCALE: 1/2"=1'-0"



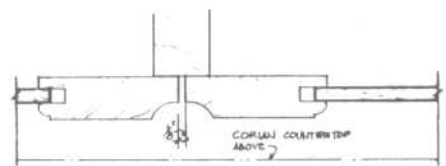
SECTION OF WOOD PANEL FACING  
SCALE: FULL SIZE



SECTION  
SCALE: F.S.

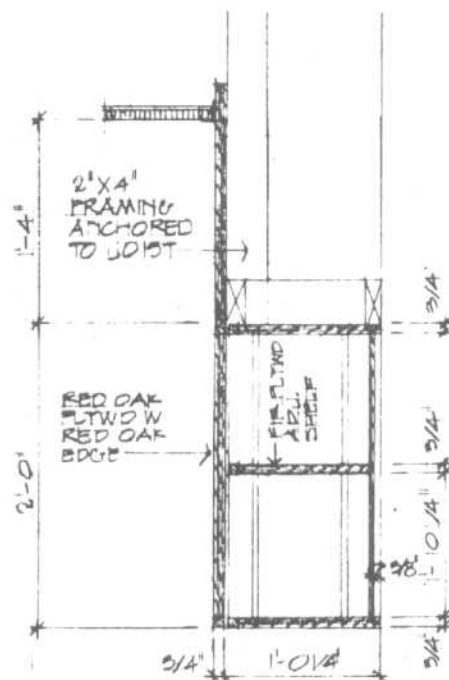


SECTION  
SCALE: F.S.

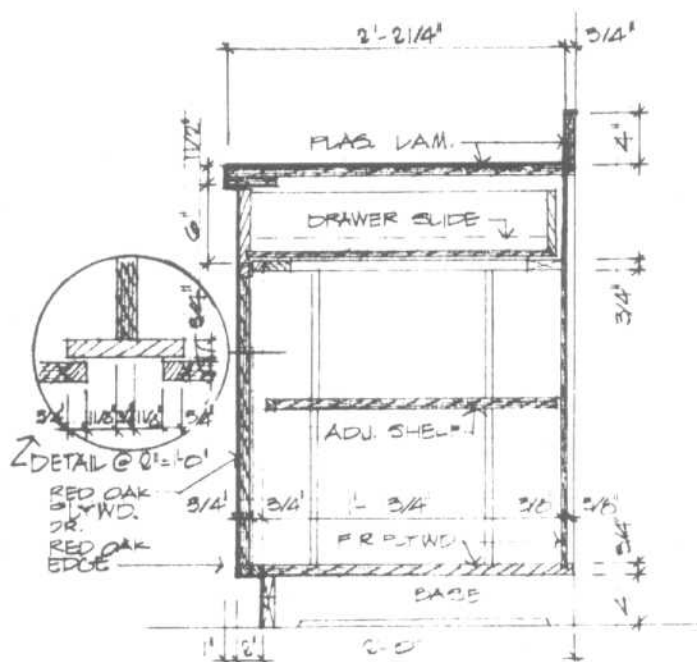


SECTION  
SCALE: F.S.





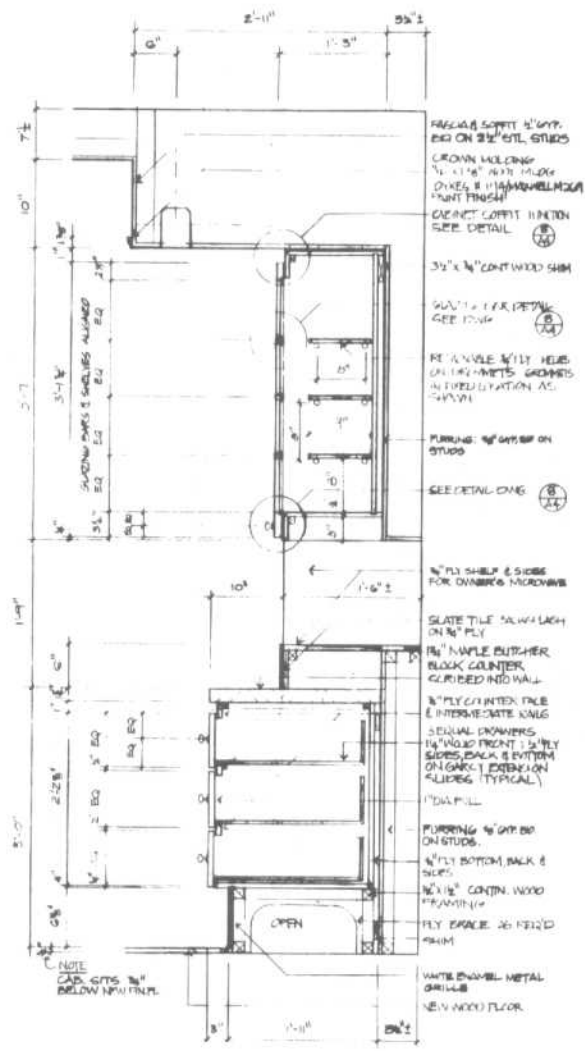
WALL CABINET



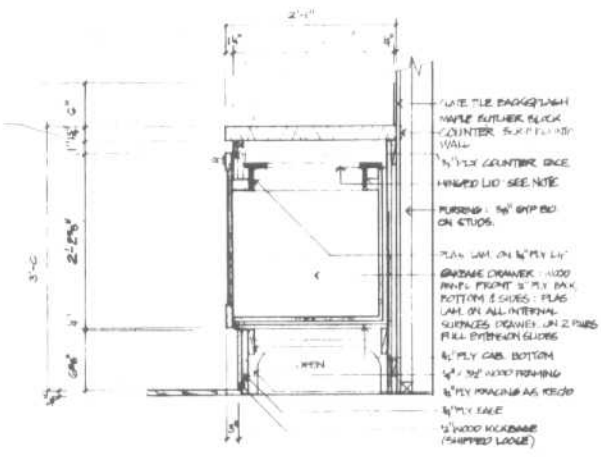
BASE CABINET

KITCHENS

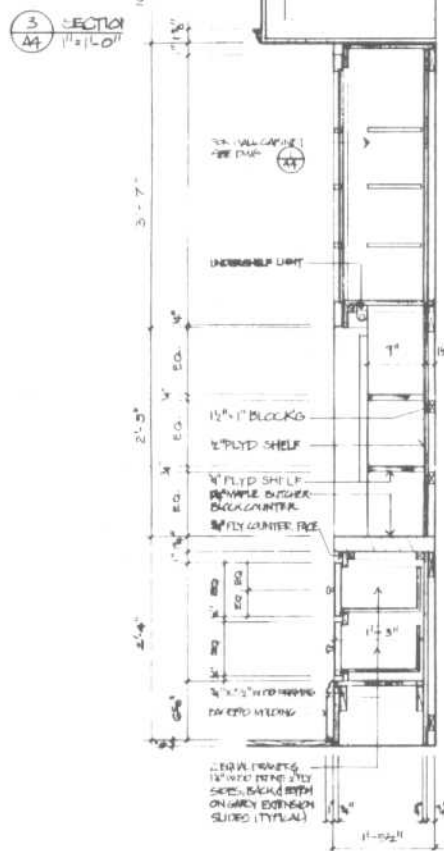
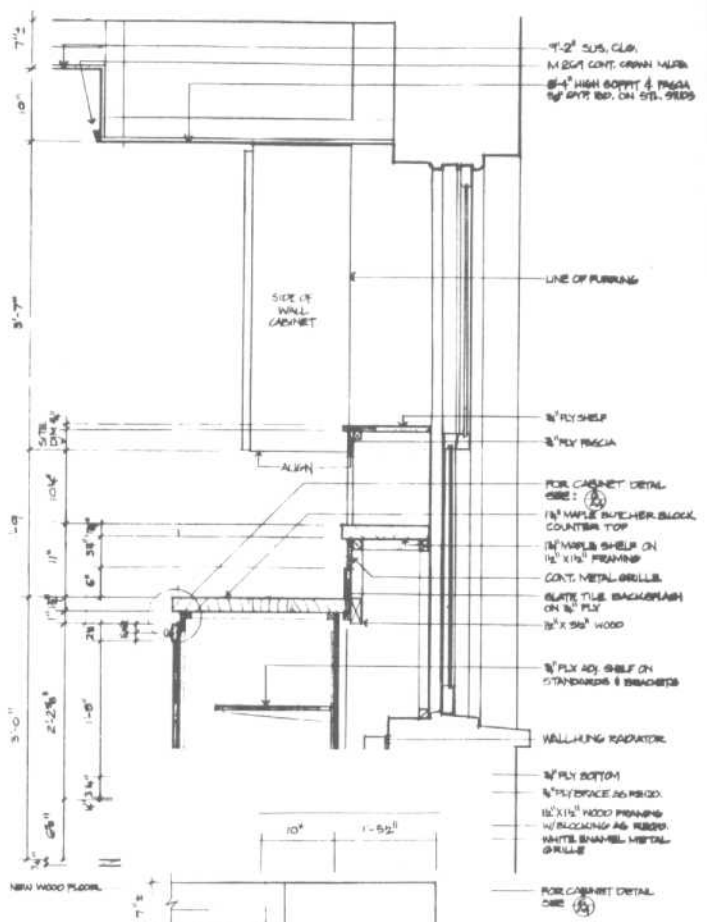
Cabinet Details



1 SECTION: TYPICAL KITCHEN CABINET @ DRAWERS  
1" = 1'-0"

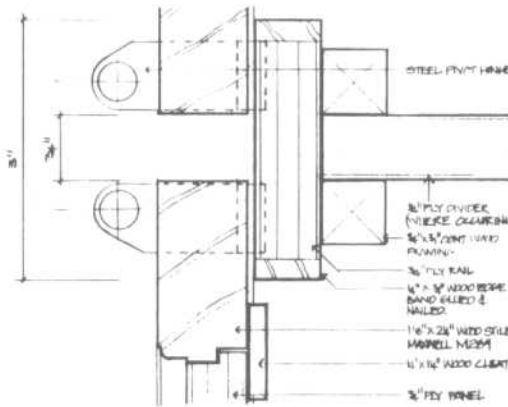


2 SECTION: KITCHEN CABINET @ GARBAGE DRAWER  
1" = 1'-0"

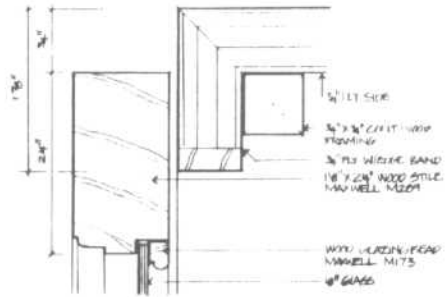


4 SECTION @ NEW WOOD DESK  
1" = 1'-0"

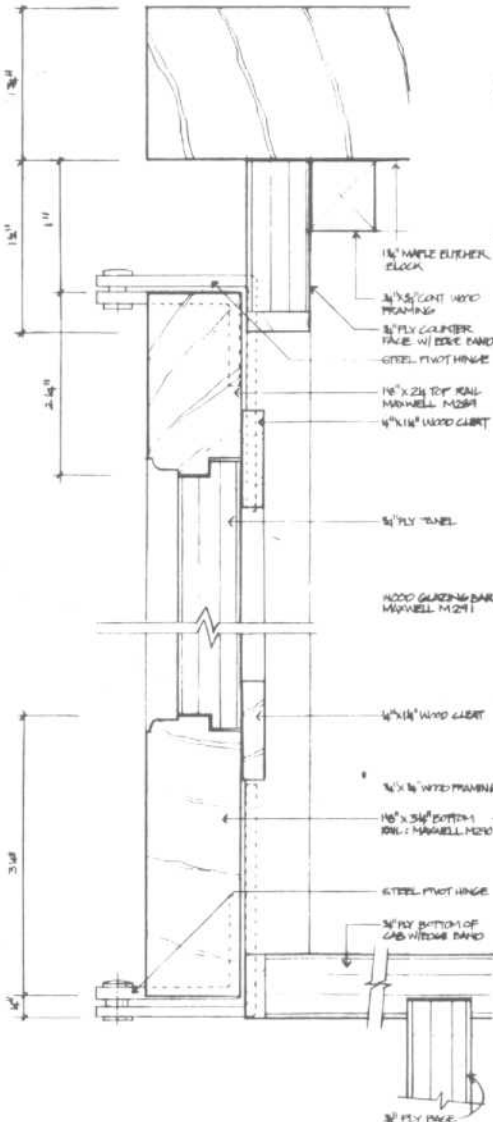
**KITCHENS**  
Cabinet Details



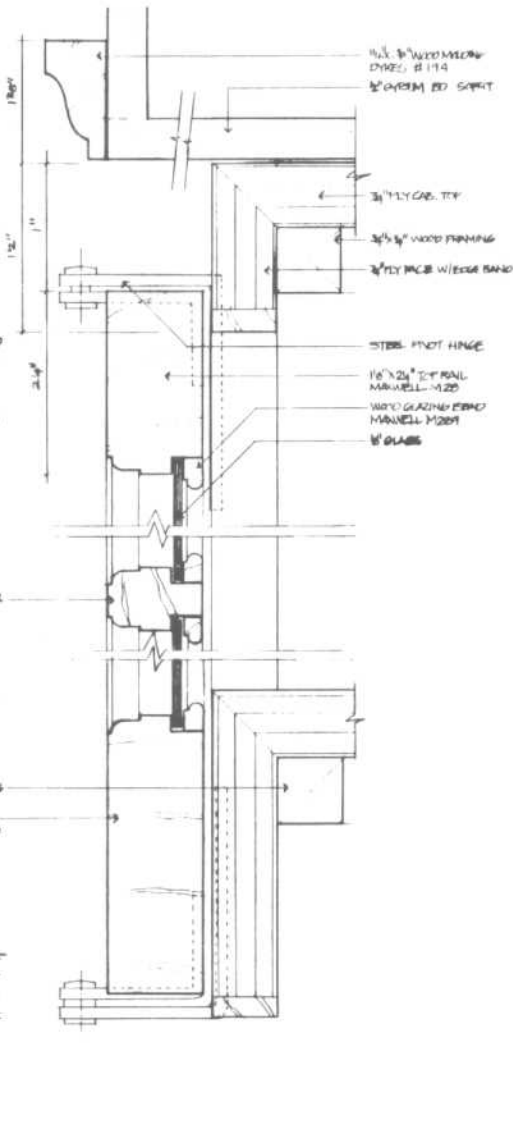
5 KITCHEN CABINET PLAN @ JAMB (TYPICAL)  
A4 FULL SIZE



7 KITCHEN CABINET PLAN @ CORNER JAMB (TYPICAL)  
A4 FULL SIZE



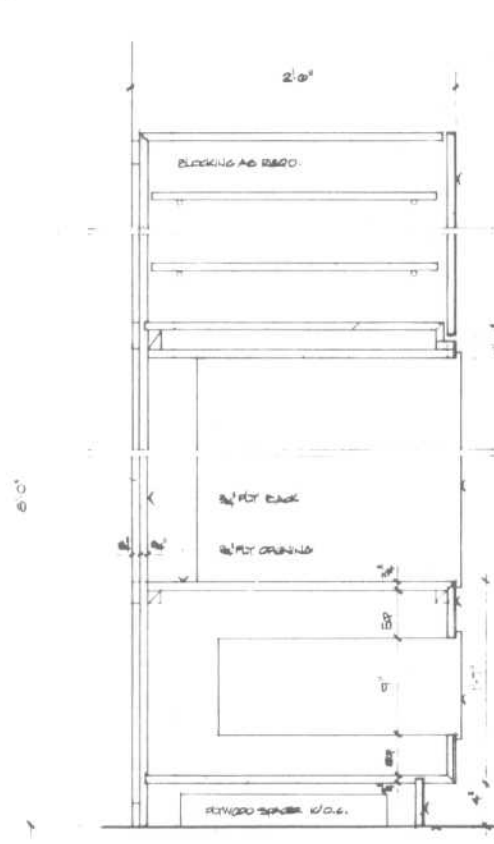
6 KITCHEN EDGE CABINET @ DOOR - TYPICAL SECTION  
A4 FULL SIZE



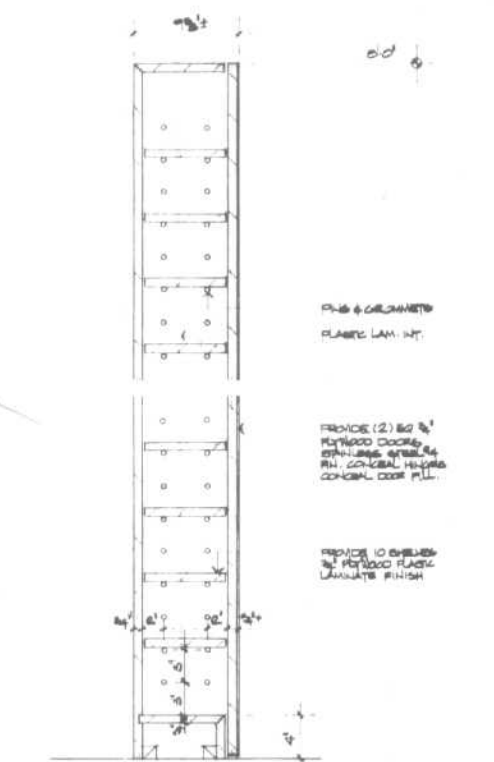
8 WALL CABINET - TYPICAL SECTION  
A4 FULL SIZE

KITCHENS

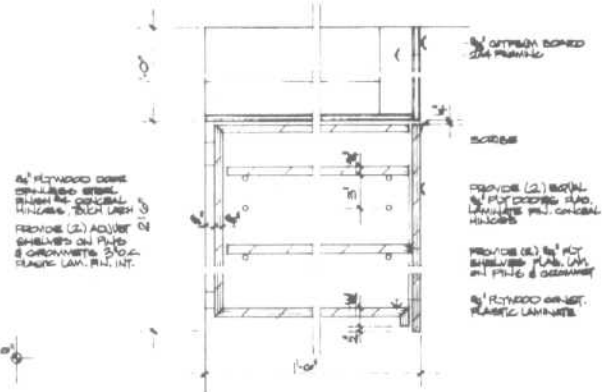
Cabinet Details



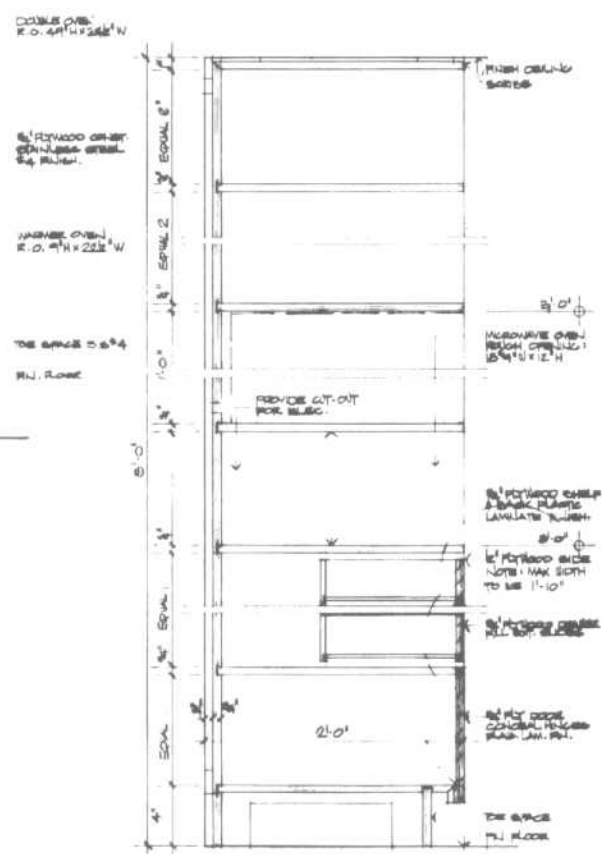
6 SECTION: DOUBLE OVEN  
A/B 12'-11'-0"



7 SECTION: PANTRY & KITCHEN  
A/B 12'-1'-0"

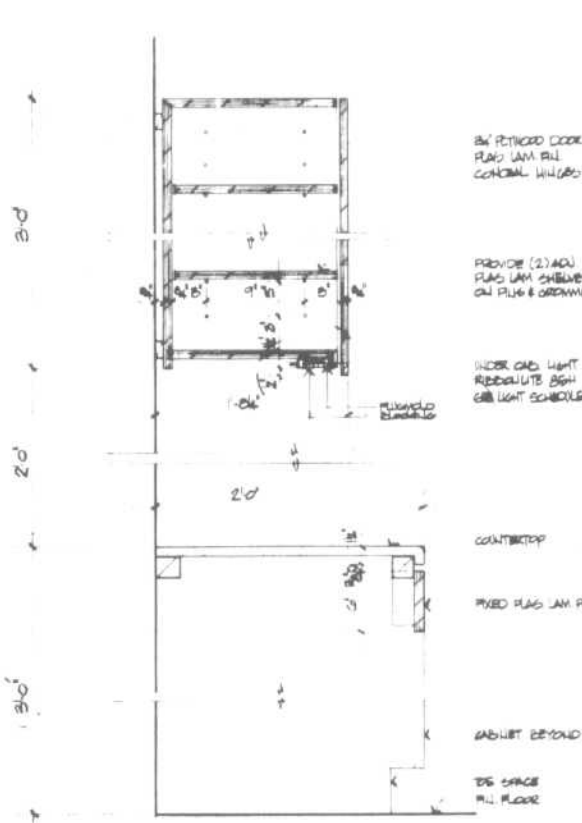


8 SECTION: PANTRY  
A/B 12'-11'-0"



9 SECTION: SHELVES AT PANTRY  
A/B 12'-1'-0"

**KITCHENS**  
Cabinet Details



5/8" PLYWOOD DOOR  
PLAS LAM PULL  
CONCEAL HILIGES

PROVIDE (2) 1/4" O.D.  
PLAS LAM SHELVES  
ON PULL & DRAWNET

UNDER CAB LIGHT  
RECORDS 1/2" BSH  
CAB LIGHT SCHEDULE

COUNTERTOP

FIXED PLAS LAM PULL

CABINET BEYOND

2 1/2" SPACE  
PULL FLOOR

1 1/2" WHITE CORNELL COGNATE  
BASE EDGE

5/8" PLY DRAWER  
PLAS LAM WITH  
BKT. FINISH PULL  
CABINET PULL BKT.  
SLIDERS. (T-PULL)

CLOCKING AS REQ'D

5/8" PLYWOOD  
PULL PLY

20" O.D. 1/4" VENT  
CLOUT TO ROOF  
VENT-PIPE

1/2" CLEAR DIST.  
BETW. CAB & 1/2" O.D.  
DUCT ABOVE

1/4" O.D. DUCT  
FOR POT EXHAUST  
PROVIDE TO HOODS

CUSTOM VENTLESS  
STAINLESS STEEL 1/2" VENT HOOD  
FRONT BLOCKING  
AS REQ'D

THERMOCOOL 1/2" O.D.  
HORIZONTAL EXHAUST DUCT

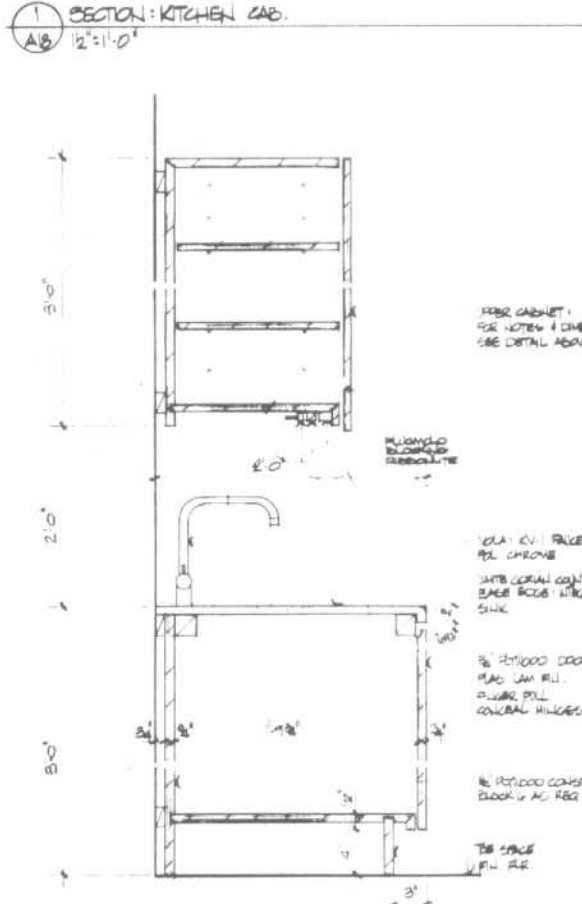
SPALLLESS STEEL  
BACKSPLASH  
SPALLLESS STEEL  
SHIELD

CALCULATED ELECTRIC  
DEPT. REVER

5/8" PLYWOOD PLY  
FRONT SPALLERS  
SHIELD AS

PROVIDE (2) EQUAL  
VERTICAL CLOUTS  
1/2" O.D. 1/4" VENT  
DIVIDERS

SPALLLESS STEEL  
2 1/2" SPACE



FIXED CABINET  
FOR NOTES & DIMS  
SEE DETAIL ABOVE

1/4" O.D. 1/4" VENT  
PULL CHROME

1 1/2" WHITE CORNELL COGNATE  
BASE EDGE - MINIMAL  
SHIM

5/8" PLYWOOD DOOR  
PLAS LAM PULL  
CONCEAL HILIGES

5/8" PLYWOOD CORNER  
BLOCKING AS REQ'D

2 1/2" SPACE  
PULL FLOOR

1 1/2" WHITE CORNELL COGNATE  
BASE EDGE

5/8" PLY DRAWER  
PLAS LAM WITH  
BKT. FINISH PULL  
CABINET PULL BKT.  
SLIDERS. (T-PULL)

CLOCKING AS REQ'D

5/8" PLYWOOD  
PULL PLY

20" O.D. 1/4" VENT  
CLOUT TO ROOF  
VENT-PIPE

1/2" CLEAR DIST.  
BETW. CAB & 1/2" O.D.  
DUCT ABOVE

1/4" O.D. DUCT  
FOR POT EXHAUST  
PROVIDE TO HOODS

CUSTOM VENTLESS  
STAINLESS STEEL 1/2" VENT HOOD  
FRONT BLOCKING  
AS REQ'D

THERMOCOOL 1/2" O.D.  
HORIZONTAL EXHAUST DUCT

SPALLLESS STEEL  
BACKSPLASH  
SPALLLESS STEEL  
SHIELD

CALCULATED ELECTRIC  
DEPT. REVER

5/8" PLYWOOD PLY  
FRONT SPALLERS  
SHIELD AS

PROVIDE (2) EQUAL  
VERTICAL CLOUTS  
1/2" O.D. 1/4" VENT  
DIVIDERS

SPALLLESS STEEL  
2 1/2" SPACE

**1 SECTION: KITCHEN CAB.**  
12" x 11'-0"

**2 SECTION: KITCHEN CAB.**  
12" x 11'-0"

**3 SECTION: KITCHEN DRAWERS**  
12" x 10"

**4 DETAIL: CAB ABOVE REFRIG.**  
12" x 10"

**1 SECTION: KITCHEN CAB.**  
12" x 11'-0"

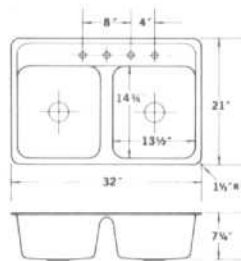
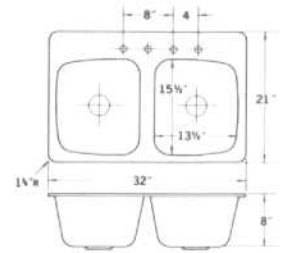
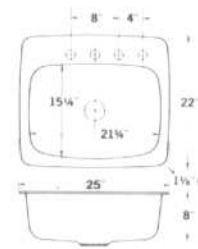
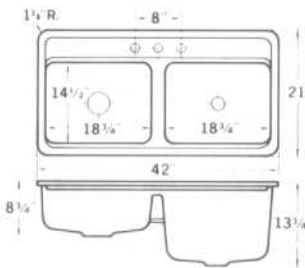
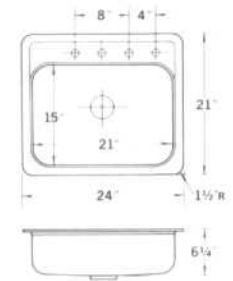
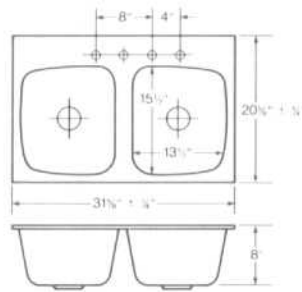
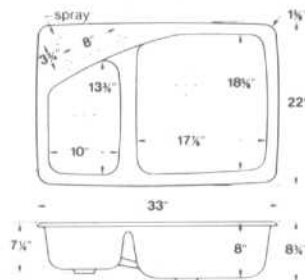
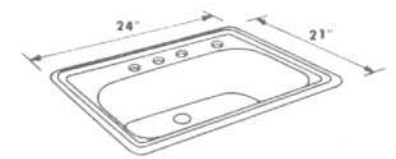
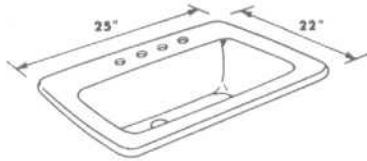
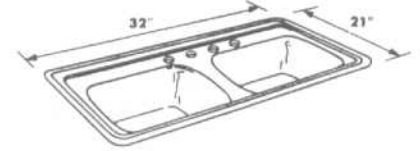
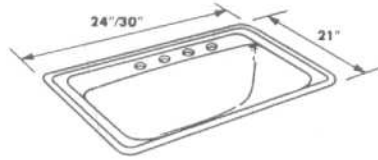
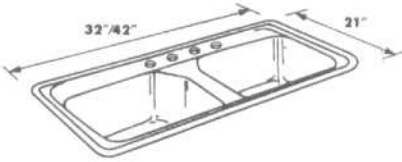
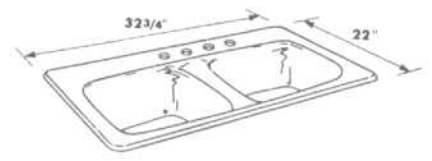
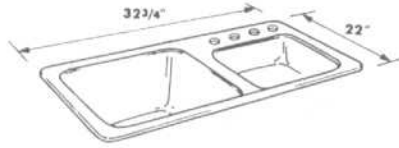
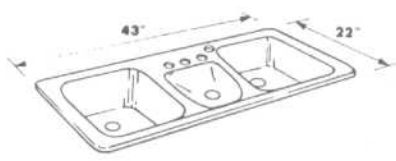
**2 SECTION: KITCHEN CAB.**  
12" x 11'-0"

**3 SECTION: KITCHEN DRAWERS**  
12" x 10"

**4 DETAIL: CAB ABOVE REFRIG.**  
12" x 10"

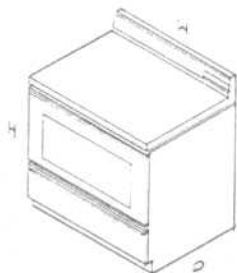
KITCHENS

Sink Types and Dimensions



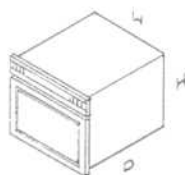
### Ranges and Built-In Ovens

Freestanding ranges and built-in ovens come in a variety of sizes and configurations. Some of the larger ranges consist of modular cooktops providing anywhere from two to seven heating elements as well as modular grills, griddles, and even downdraft built-in ventilators. Normally, a minimum clearance of 30" is required above any range or cooktop, but the designer is cautioned to carefully verify local code requirements. Manufacturers' specifications should be carefully reviewed for rough opening requirements and any venting requirements, particularly for self-cleaning ovens.



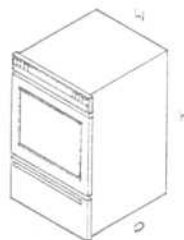
STANDARD FREESTANDING RANGE

W: 18" - 42"  
D: 24" - 27 1/2"  
H: 35" - 36"



BUILT-IN SINGLE OVEN

W: 20" - 24"  
D: 21" - 24"  
H: 22" - 28"



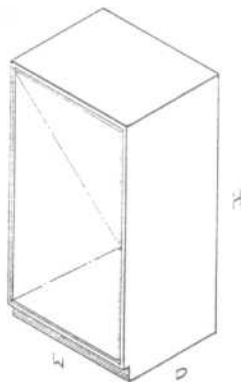
BUILT-IN OVEN/BROILER

W: 18" - 24"  
D: 21" - 24"  
H: 36" - 41"



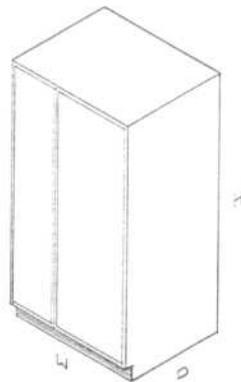
BUILT-IN DOUBLE OVEN

W: 18" - 24"  
D: 21" - 24"  
H: 38" - 51"



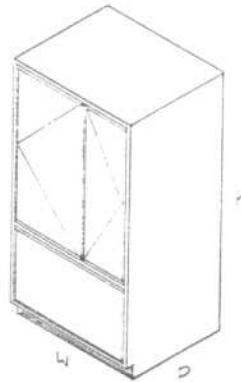
STANDARD REFRIGERATOR  
SINGLE DOOR

W: 18"  
D: 24"  
H: 68 1/2"



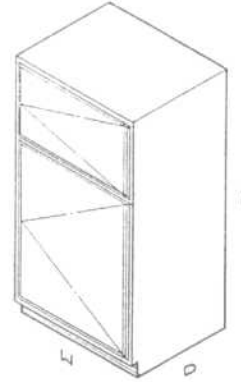
STANDARD REFRIGERATOR  
(SIDE BY SIDE)

W: 29 1/2" - 39 1/2"  
D: 29" - 33"  
H: 64" - 69 1/2"



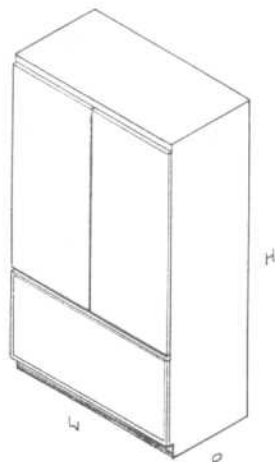
STANDARD REFRIGERATOR  
(BOTTOM FREEZER)

W: 24" - 33 1/2"  
D: 29" - 33"  
H: 64" - 69 1/2"



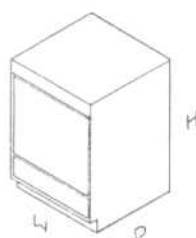
STANDARD REFRIGERATOR  
(FREEZER AT TOP)

W: 24" - 33"  
D: 27 3/4" - 32"  
H: 63 1/2" - 68 1/2"



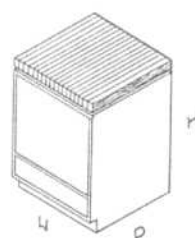
BUILT-IN/RECESSED REFRIGERATOR

W: 30" - 72"  
D: 23 1/2" - 24"  
H: 84"



UNDER COUNTER DISHWASHER

W: 23" - 24"  
D: 23 1/2" - 26 1/2"  
H: 33 1/2" - 34 1/2"



FREE STANDING DISHWASHER

W: 23" - 24"  
D: 23 1/2" - 26 1/2"  
H: 33 1/2" - 34 1/2"

### Dishwashers

Built-in, freestanding, and undersink dishwashers are fairly well standardized in terms of overall dimensions. Access to plumbing and waste lines is the major consideration, as is the method of securing the dishwasher in order to minimize vibration.

### Refrigerators

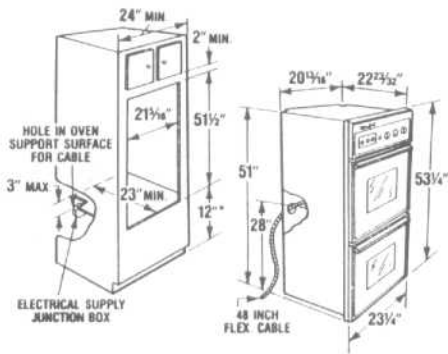
Refrigerator door swings and clearances are of critical importance. While a 90° door swing may provide sufficient room for a person to observe storage within a refrigerator or freezer, a 180° door swing may be required to clean a refrigerator and remove storage bins.

This is particularly true of the side-by-side door configuration. In addition, adequate clearance should be allowed between the sides and top of the refrigerator and any adjoining cabinetwork, especially if a built-in look is desired. The designer should check requirements with the manufacturer.

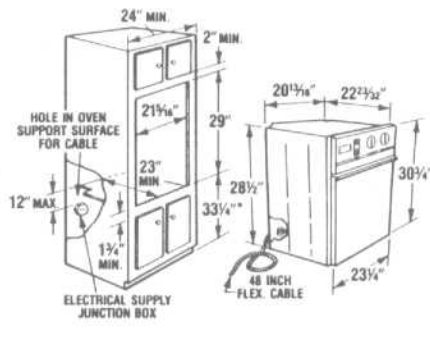
While these drawings can be used for preliminary planning, final dimensions and clearance must be verified with the manufacturer. Often overlooked are clearances for refrigerator handles or pulls as well as coils mounted at the rear of the refrigerator.

KITCHENS

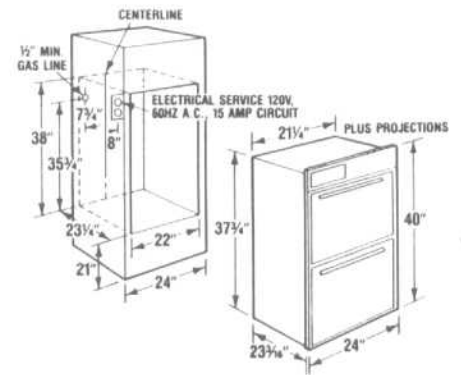
Appliances



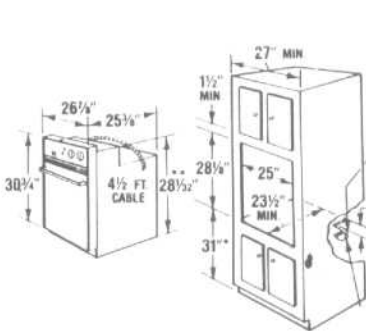
24" electric built-in double oven



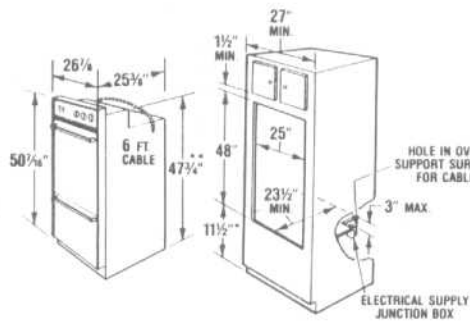
24" electric built-in single oven



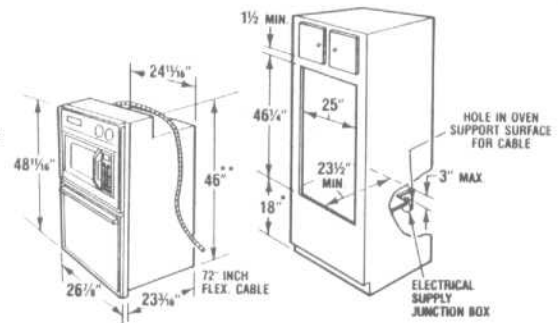
Gas built-in oven



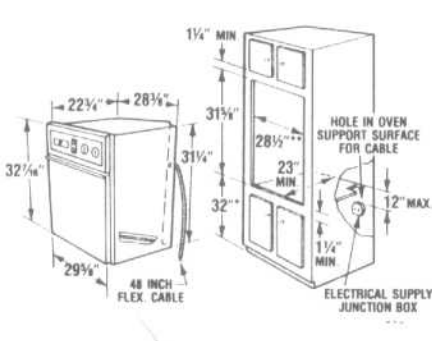
Electric built-in single oven



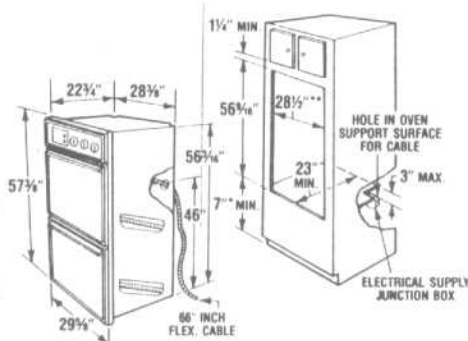
27" electric built-in double oven



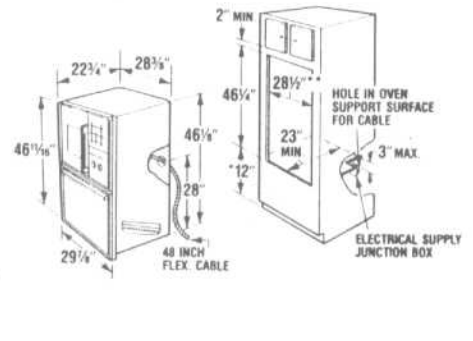
27" built-in microwave oven



30" electric built-in single oven



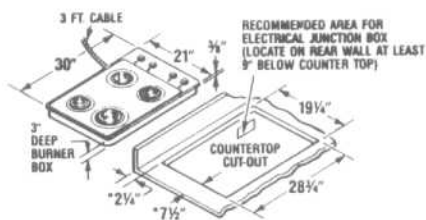
30" electric built-in double oven



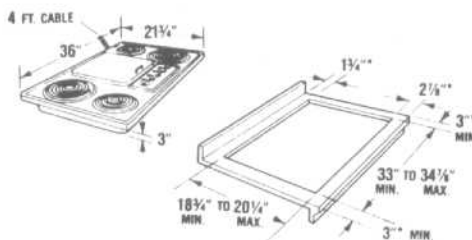
30" built-in microwave oven

Note: Dimensions shown are for planning purposes only.

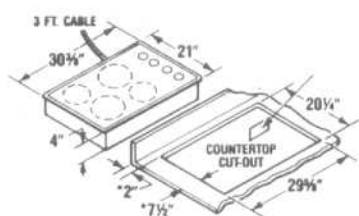




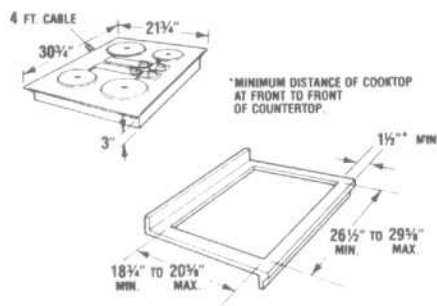
Conventional electric cooktop



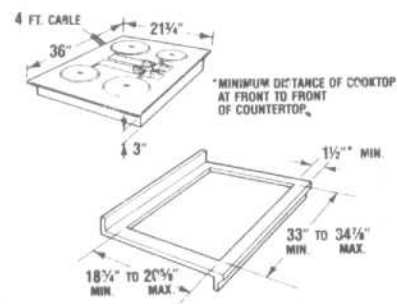
36" electric cooktop



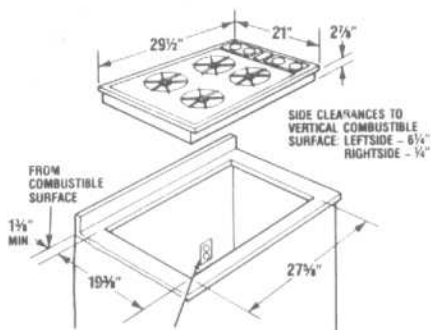
Glass cooktop



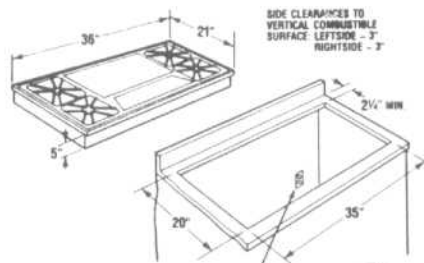
30" solid elements/glass cooktop



36" solid element/glass cooktop



30" gas cooktop



30" gas cooktop

Note: Dimensions shown are for planning purposes only.

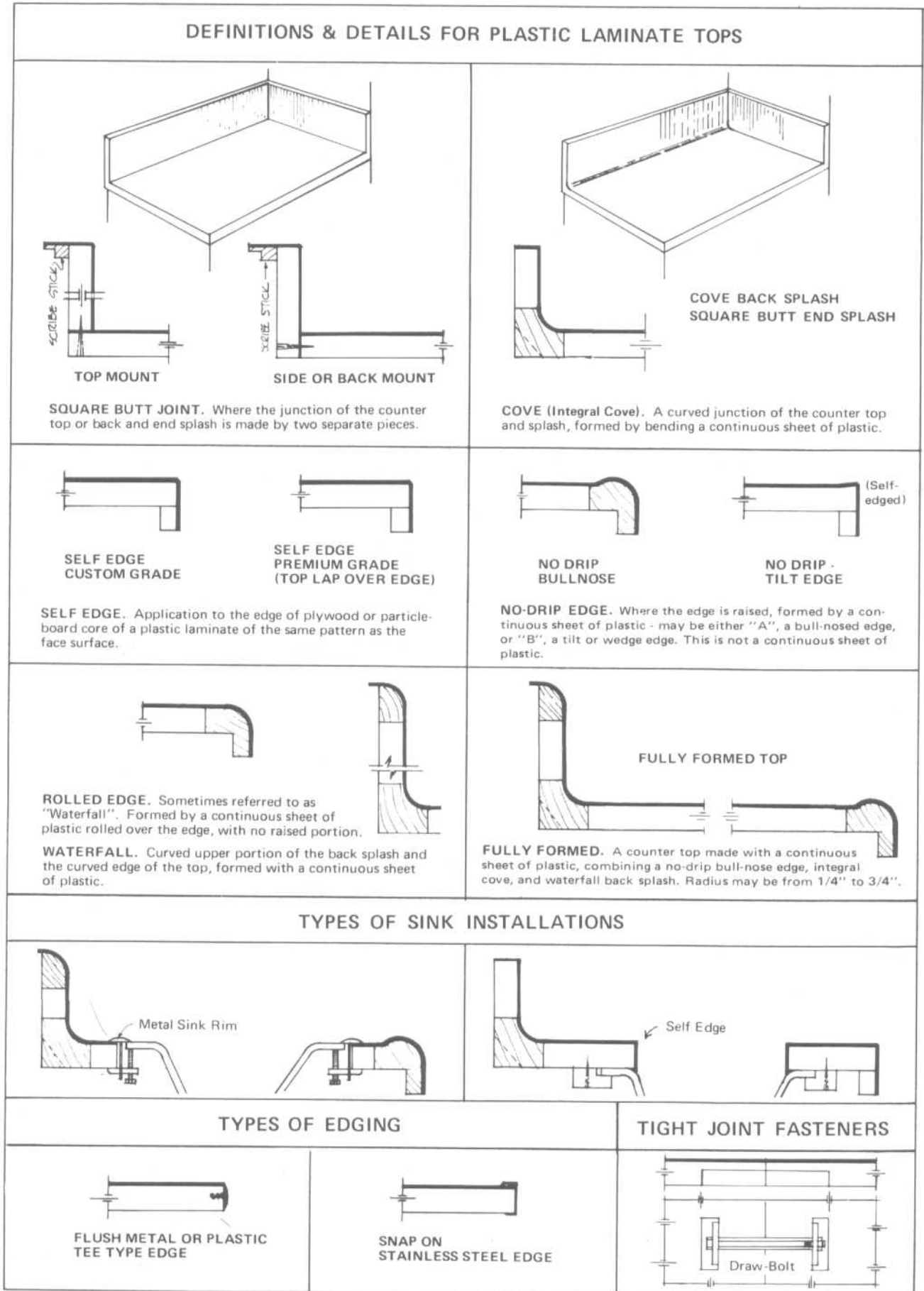


Fig. 11 Definitions and details for plastic laminate tops.

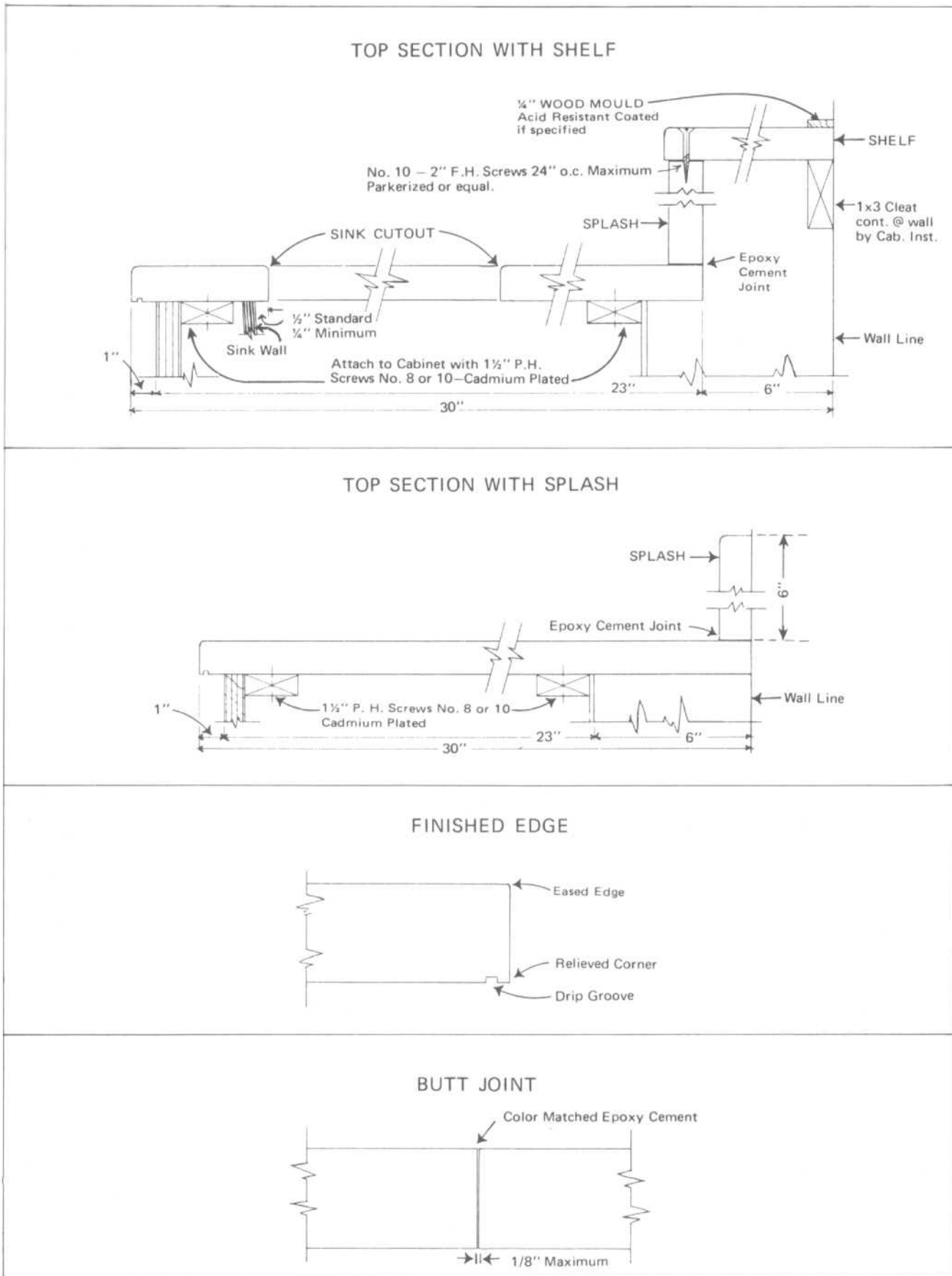
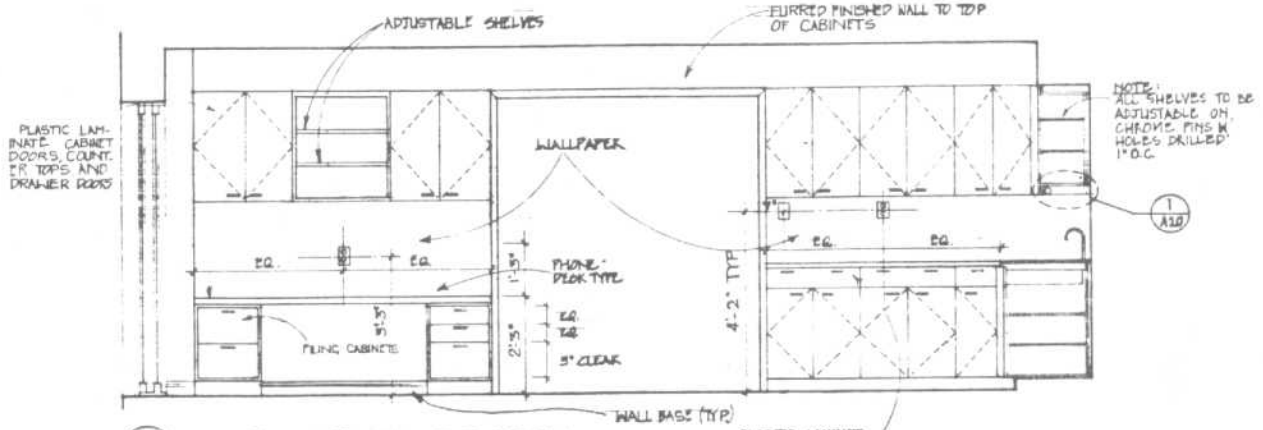
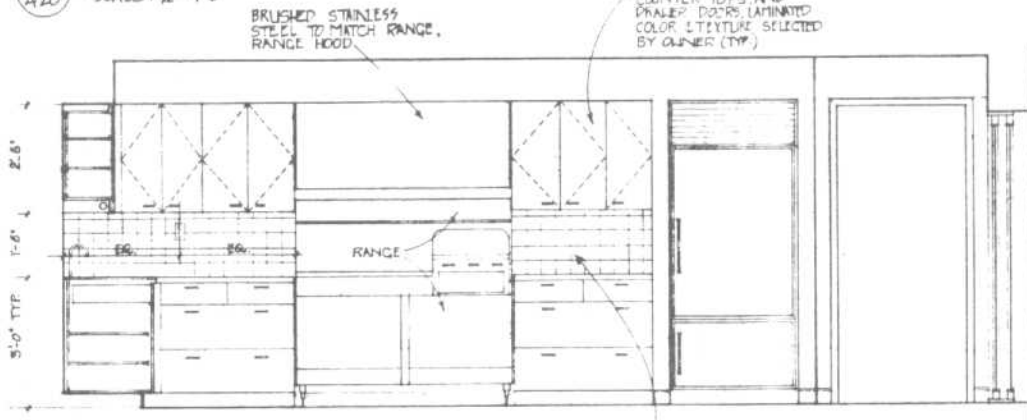


Fig. 12 Composition stone top and sink details.

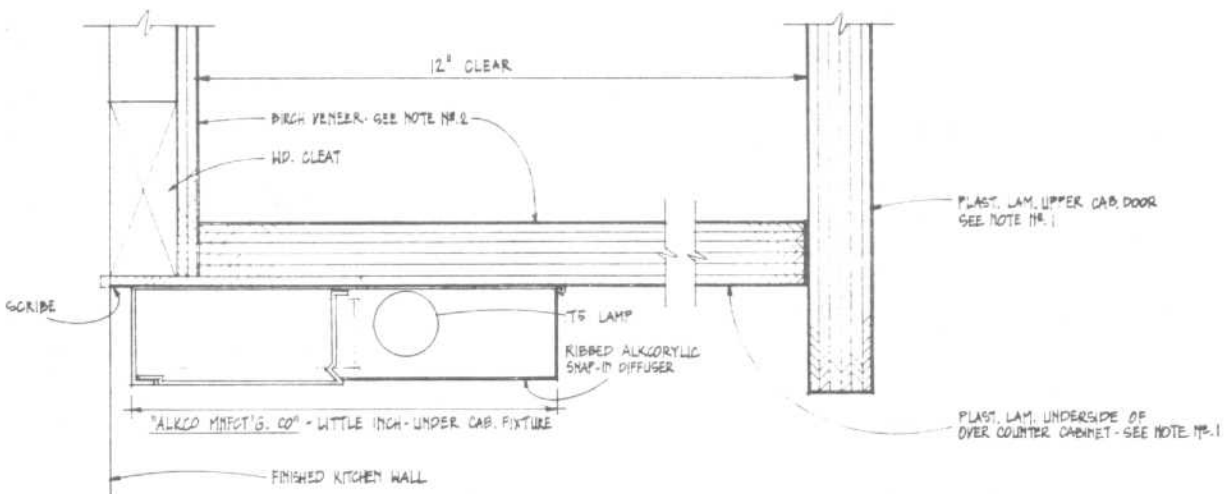




D SOUTH KITCHEN ELEVATION  
SCALE: 1/8" = 1'-0"



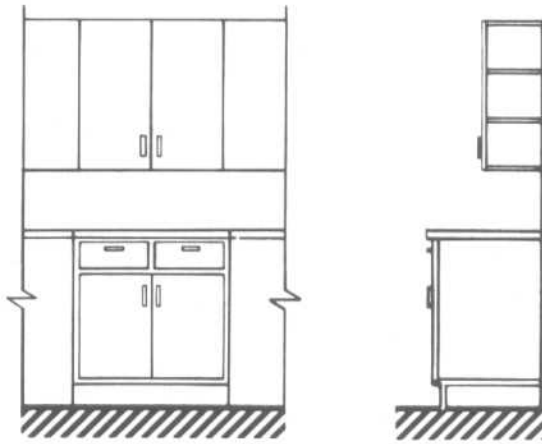
D NORTH KITCHEN ELEVATION  
SCALE: 1/8" = 1'-0"



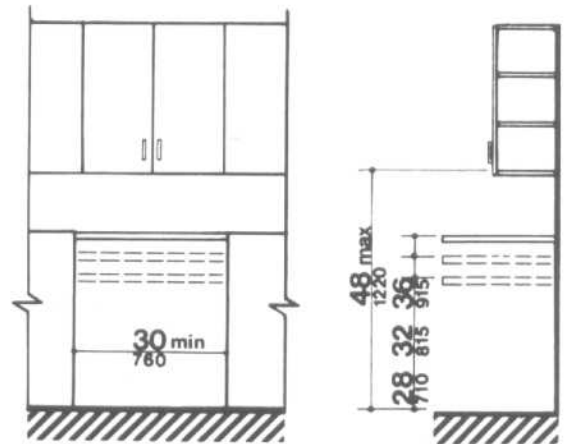
I SECTION DETAIL @ UPPER CABINET  
A20 FULL SIZE

**KITCHENS**

Wheelchair Accessible Design

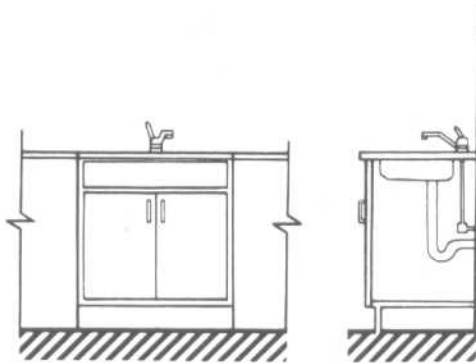


(a)  
Before Removal of Cabinets and Base

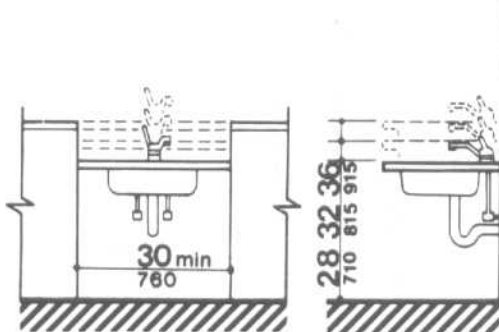


(b)  
Cabinets and Base Removed and Height Alternatives

**Counter Work Surface**

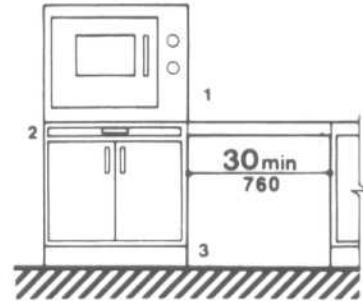


(a)  
Before Removal of Cabinets and Base

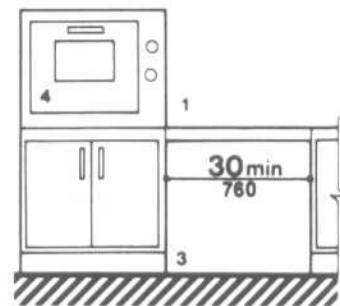


(b)  
Cabinets and Base Removed  
and Height Alternatives

**Kitchen Sink**



(a)  
Side-Hinged Door



(b)  
Bottom-Hinged Door

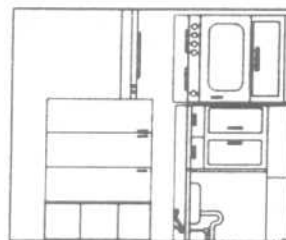
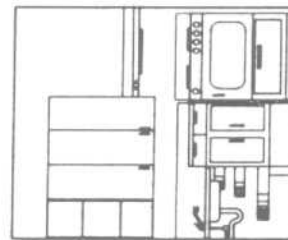
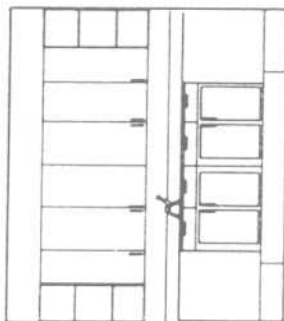
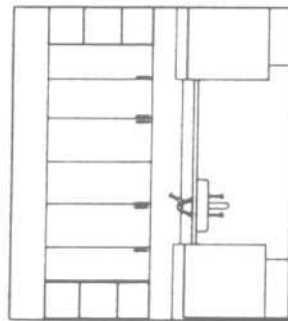
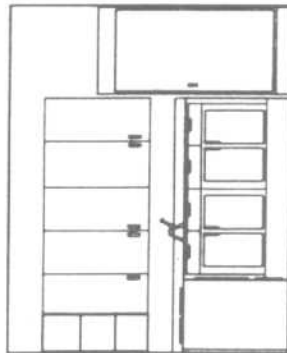
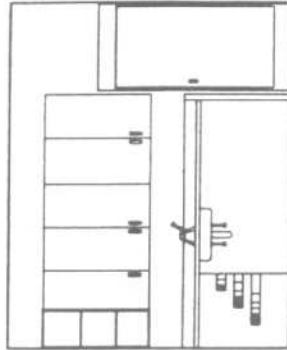
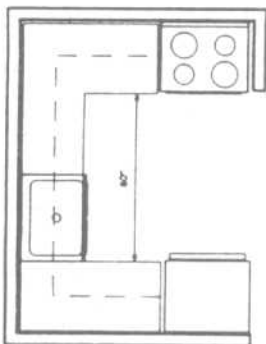
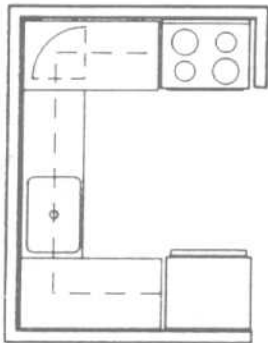
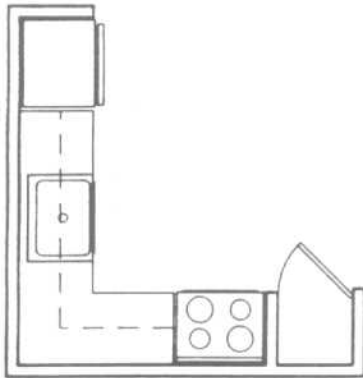
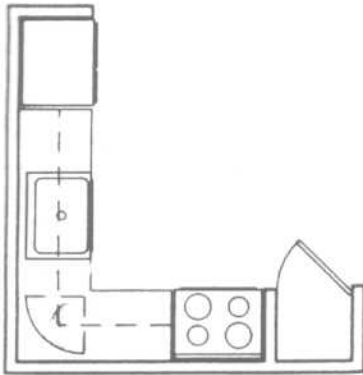
SYMBOL KEY:

- 1. Countertop or wall-mounted oven.
- 2. Pull-out board preferred with side-opening door.
- 3. Clear open space.
- 4. Bottom-hinged door.

**Ovens without Self-Cleaning Feature**

KITCHENS

Wheelchair Accessible Design



ACCESSIBLE; BEFORE REMOVAL OF CABINETS AND BASE. CABINETS AND BASE REMOVED, COUNTER HEIGHT LOWERED.

ACCESSIBLE; BEFORE REMOVAL OF CABINETS AND BASE. CABINETS AND BASE REMOVED, COUNTER HEIGHT LOWERED.

CABINETS AND BASE REMOVED, COUNTER HEIGHT LOWERED.

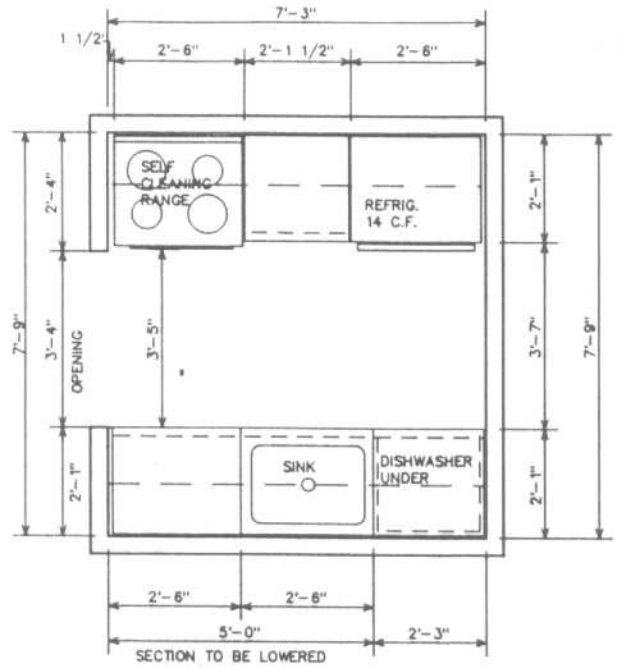
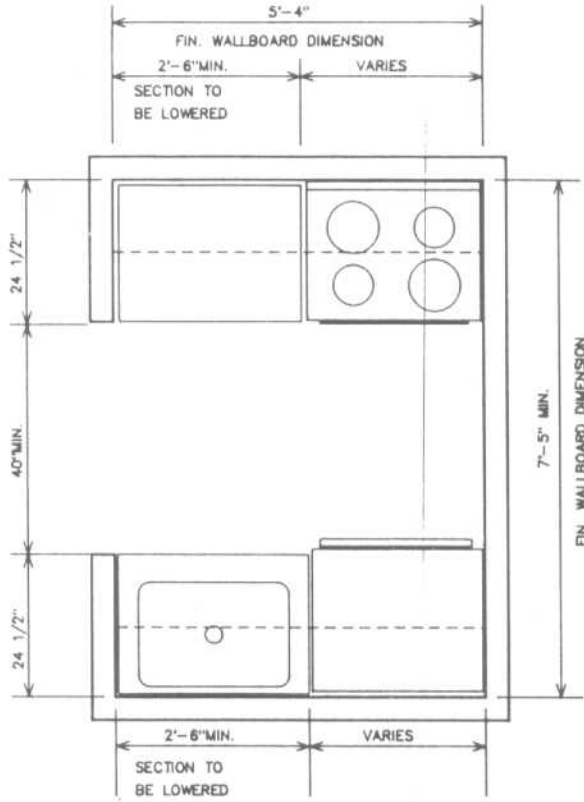
ACCESSIBLE; BEFORE REMOVAL OF CABINETS AND BASE.

EXAMPLE OF ADAPTABLE KITCHEN - L- SHAPED PLAN

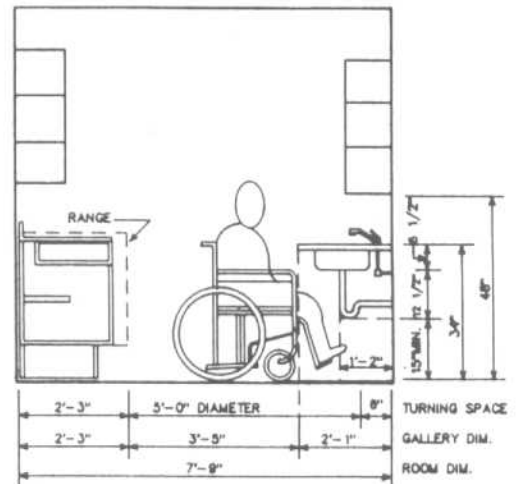
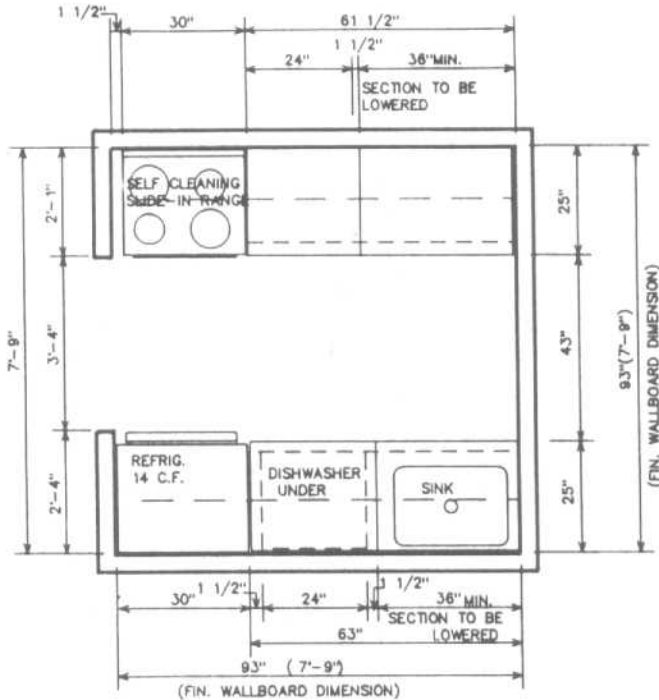
EXAMPLE OF ADAPTABLE KITCHEN - U- SHAPED PLAN

KITCHENS

Wheelchair Accessible Design



Minimum-sized adaptable kitchen or kitchenette



Kitchen clearance dimensions (not to scale)

Minimum-sized adaptable kitchen (galley type)



## KITCHENS

## Wheelchair Accessible Design

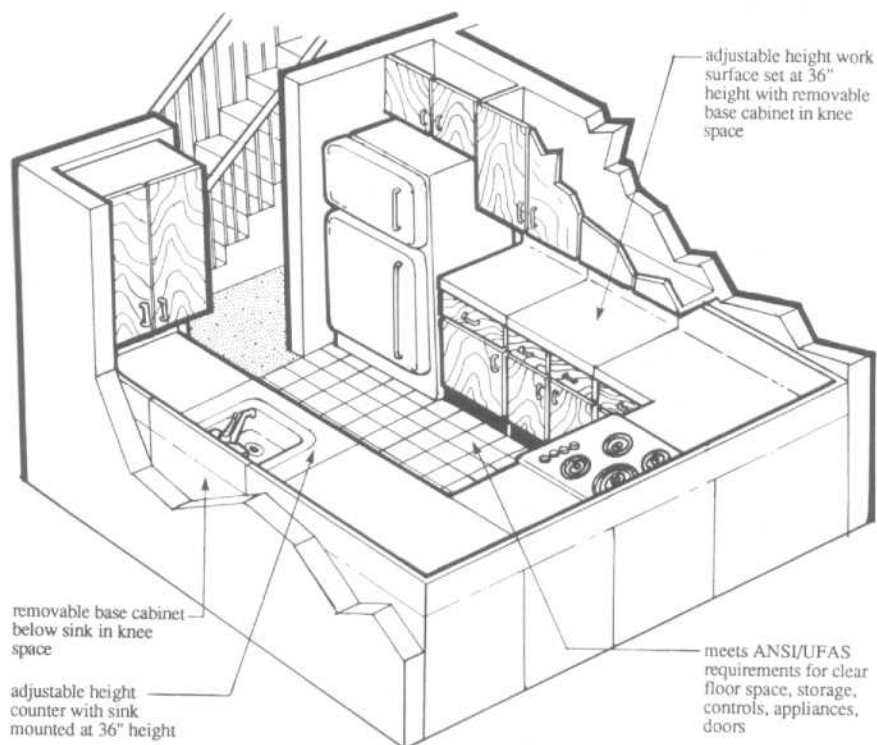


Fig. 13 An adaptable kitchen in conventional configuration.

## Requirements

The ANSI and UFAS standards require accessible and adaptable features which make the kitchen usable by most people. The fixed accessible features specified in ANSI 4.32.5 and UFAS 4.34.6 include requirements for doors, clearances, clear floor space, appliances, storage, controls, and knee space. The adaptable features are removable base cabinets at knee spaces and counters that can be adjusted in height or fixed at a lower than standard height.

The adaptable features for kitchens specified in the standards are shown in Figs. 13 and 14. In Fig. 13, the kitchen is shown in a standard configuration with the counter height at 36 inches and the knee spaces covered with base cabinets.

In Fig. 14, the kitchen has been adapted by exposing the knee spaces and lowering the work surface and sink counter segments.

Since removable base cabinets and adjustable height counters are not now products that are readily available for purchase, they are usually custom-made items.

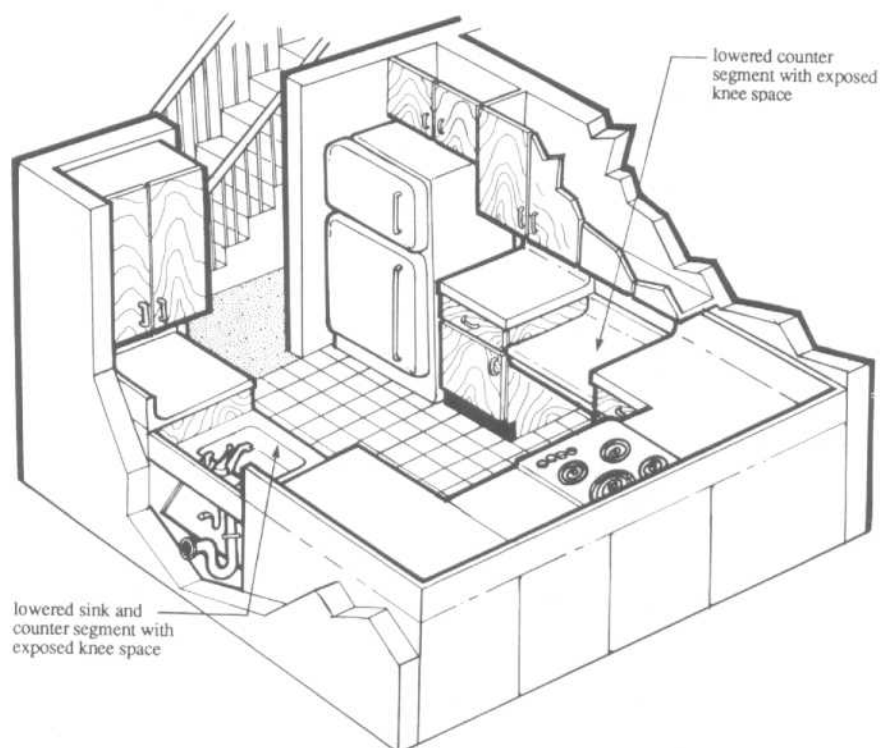


Fig. 14 An adaptable kitchen in the adjusted configuration.

KITCHENS

Wheelchair Accessible Design

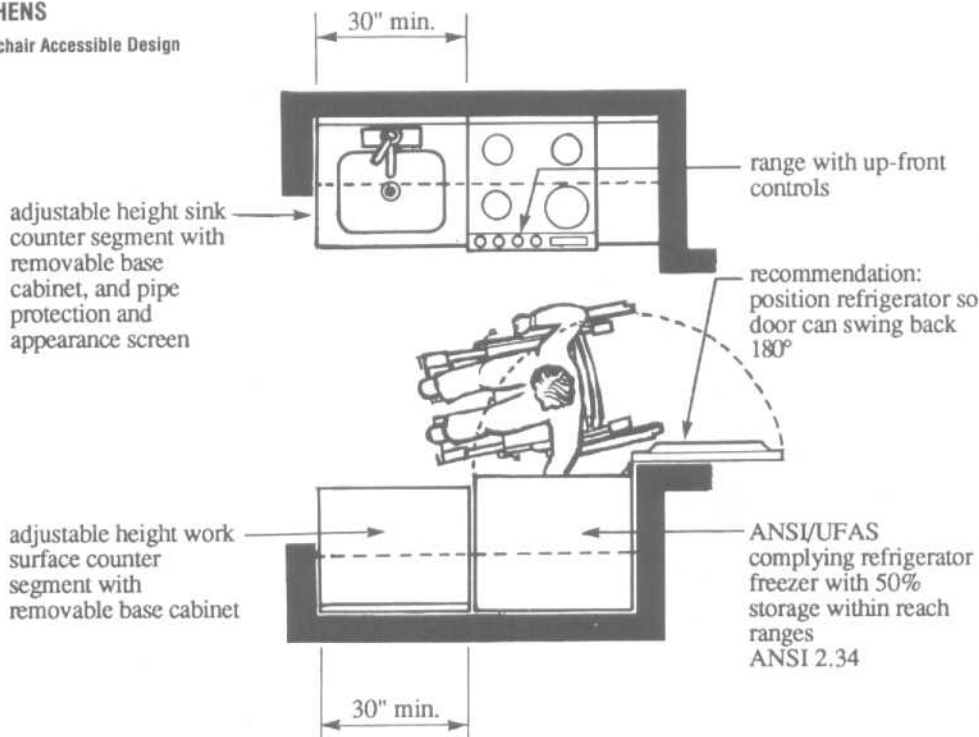


Fig. 15 A small kitchen with adaptable features: plan.

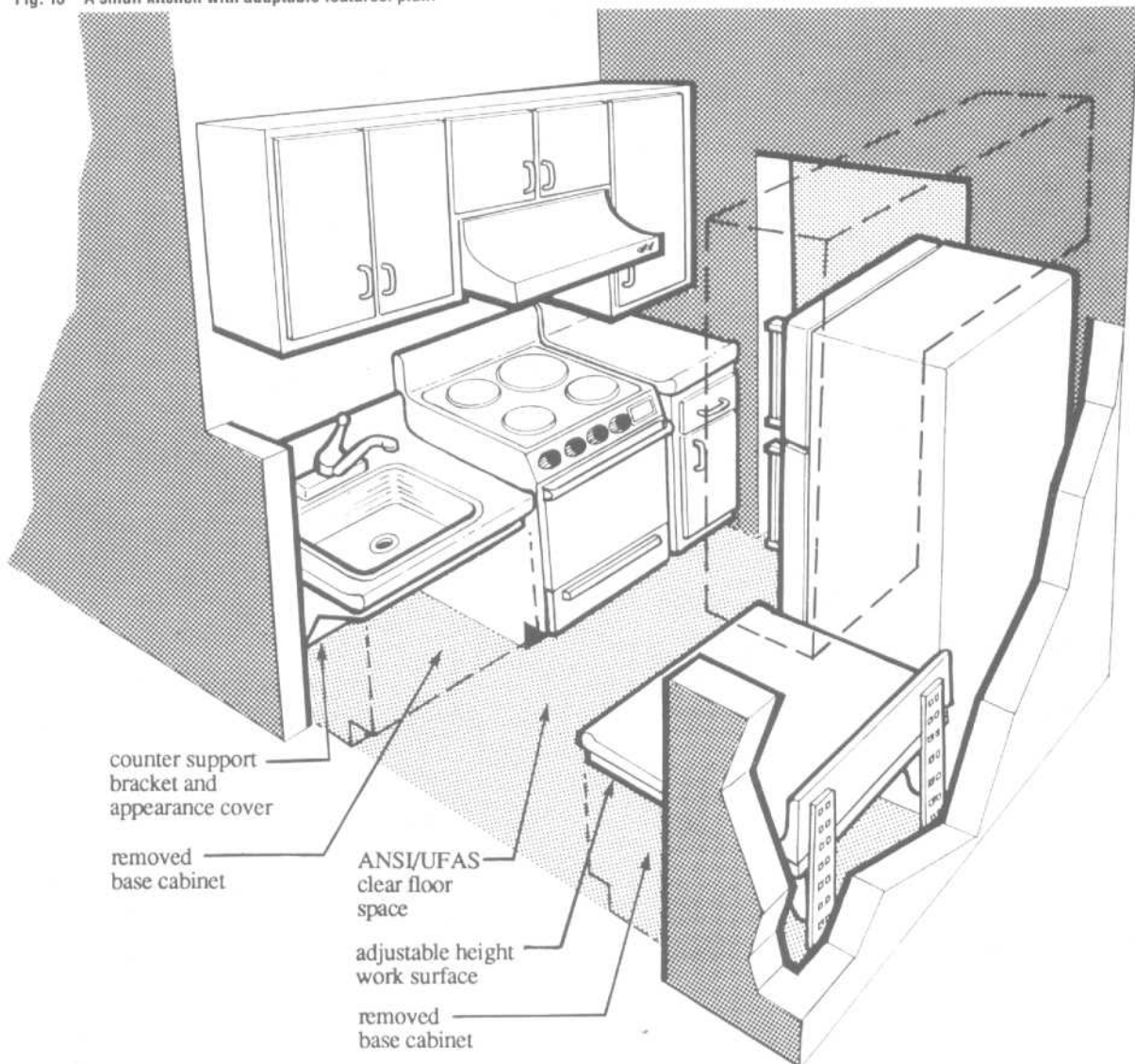
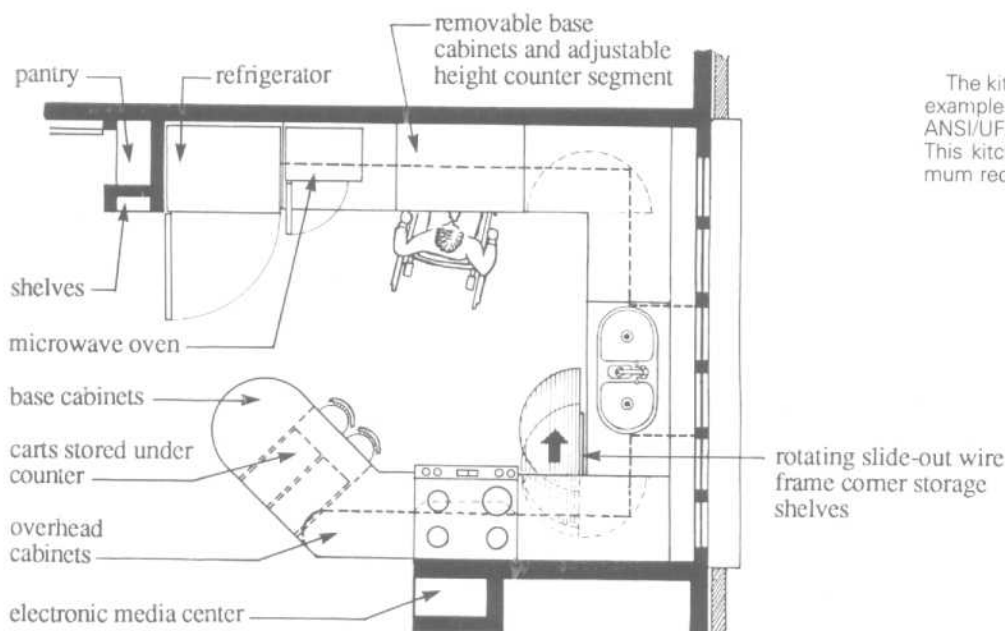


Fig. 16 A small kitchen with adaptable features: perspective.

KITCHENS

Wheelchair Accessible Design



The kitchen shown in Figs. 17 and 18 is an example of a more elaborate kitchen having ANSI/UFAS accessible/adaptable features. This kitchen exceeds the ANSI/UFAS minimum requirements.

Fig. 17 An elaborate kitchen with adaptable features: plan.

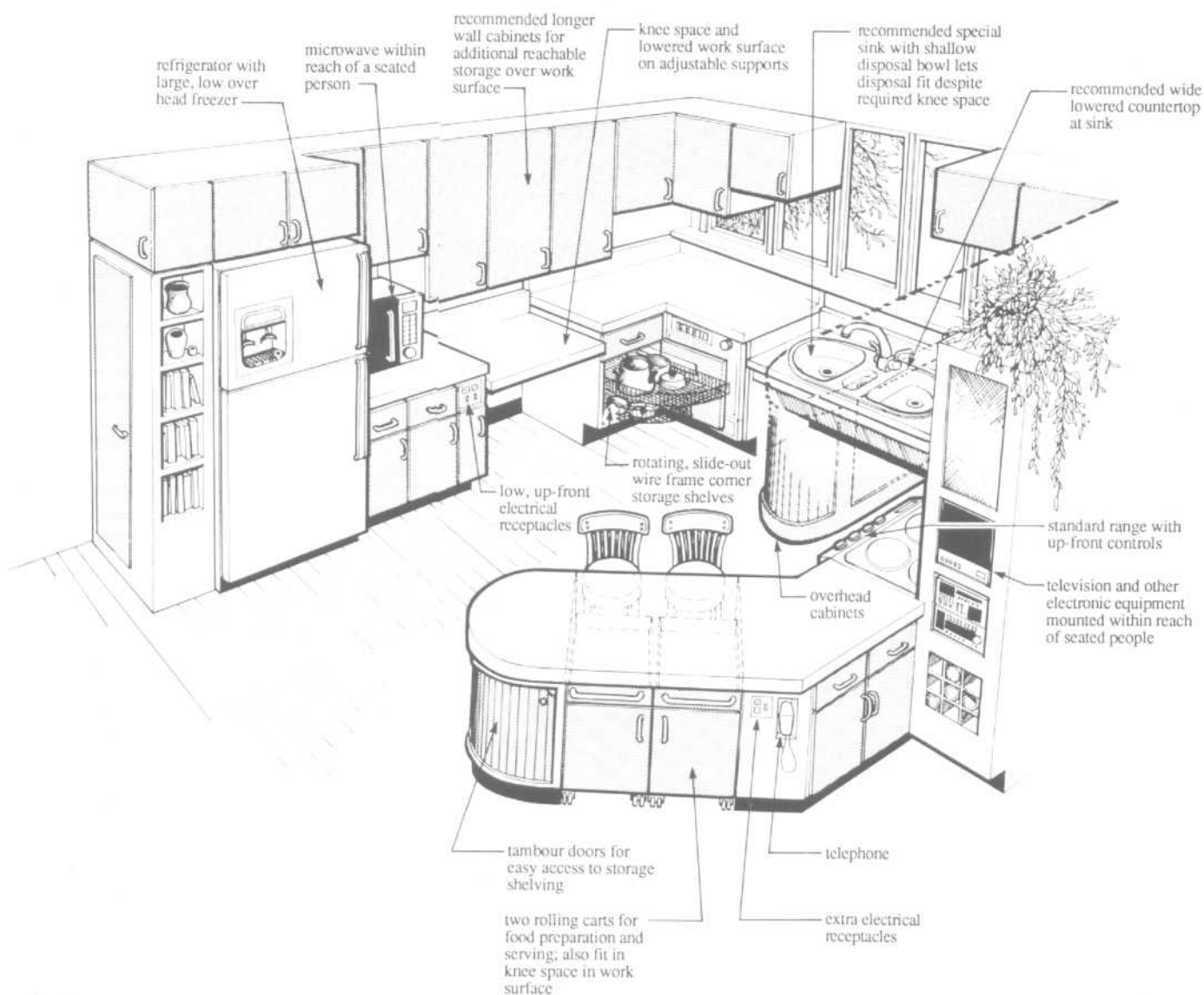


Fig. 18 An elaborate kitchen with adaptable features: perspective.

KITCHENS

Wheelchair Accessible Design

Work Surfaces

People who use wheelchairs and other people who must or wish to sit down while preparing food need at least one work surface lower than the usual 36-in-high counter (Fig. 19).

The standards (ANSI 4.32.5.4 and UFAS 4.34.6.4) require that at least one 30-in-wide, adjustable-height work surface be provided in an adaptable kitchen, although a wider size is preferred. The wider work surface provides space for pots, dishes, and other utensils as well as small appliances, and makes it easier to work on several things at once or to cook using many ingredients.

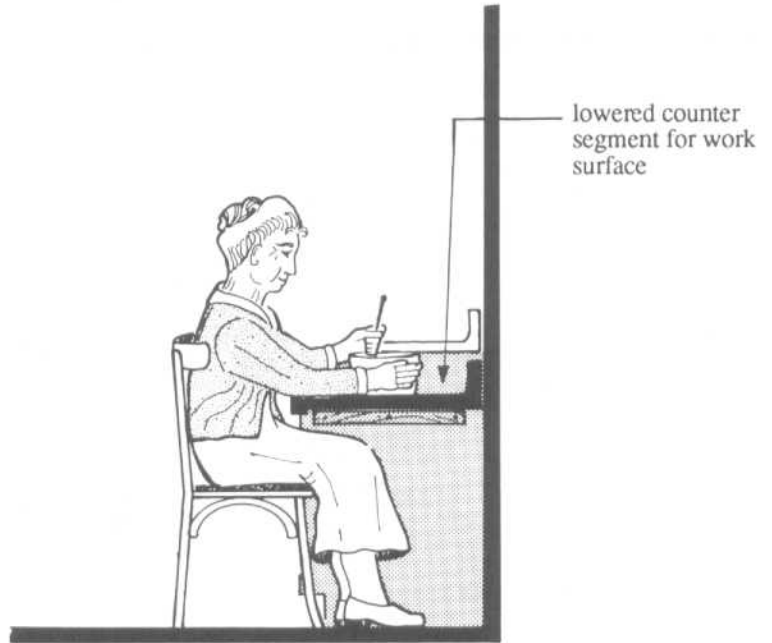


Fig. 19 Seated person at lowered work surface.

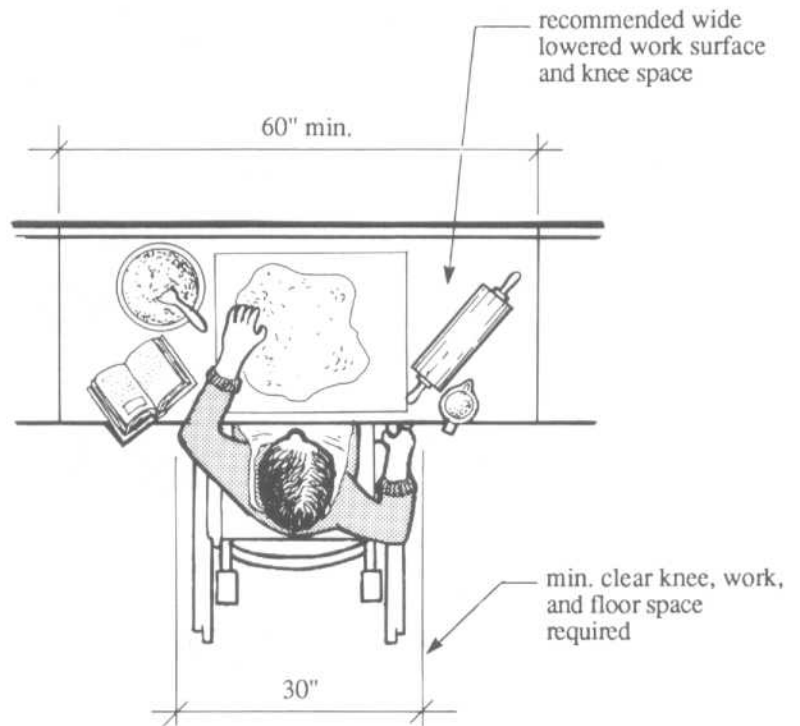


Fig. 20 Use of a wider, lowered work surface.

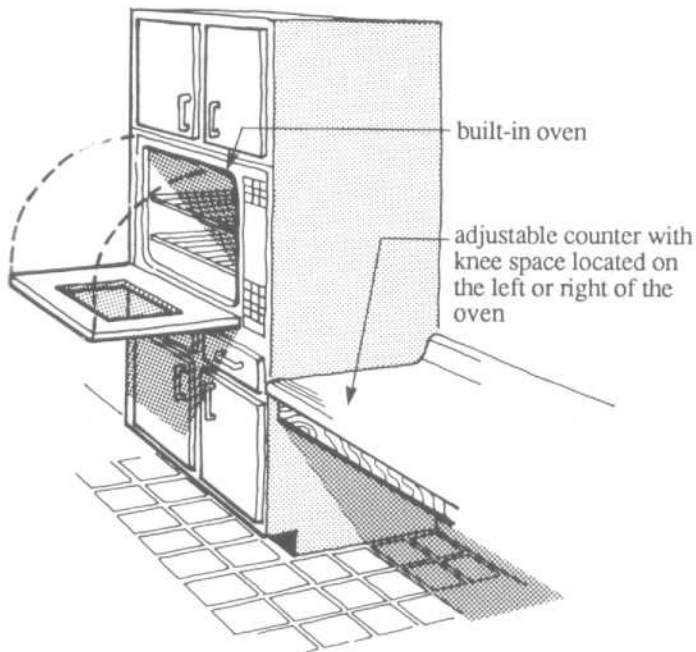


Fig. 21 Work surface at non-self-cleaning oven with drop-front door.

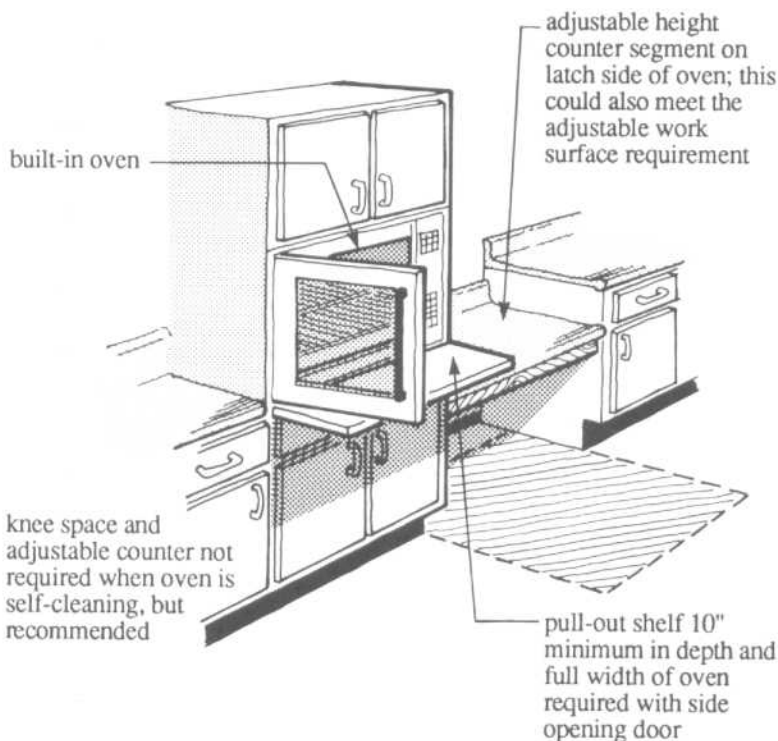


Fig. 23 Pull-out shelf at non-self-cleaning oven with side-opening door.

**Work surfaces at ovens** If a wall oven is installed, a lowered work surface with knee space should be installed next to the wall oven. The standards specify that when the wall oven is not self-cleaning, a knee space must be located next to the oven to permit a disabled person in a wheelchair to pull up close enough to clean the oven.

Even if a self-cleaning oven is installed, locating the knee space next to the oven makes it easier and safer for a disabled person to remove hot items from the oven.

When an oven with a side-opening door is used, a pull-out shelf located beneath the oven must be installed. The shelf is used as a transfer surface for dishes as they are placed into or taken out of the oven. When not needed, the shelf is pushed back into the oven cabinet (Fig. 23). When an oven with a drop-front door is used (Fig. 21), the pullout shelf is not needed because the door serves as a transfer shelf.

See ANSI 4.32.5.7 and UFAS 4.34.6.7 for dimensions and details of oven.

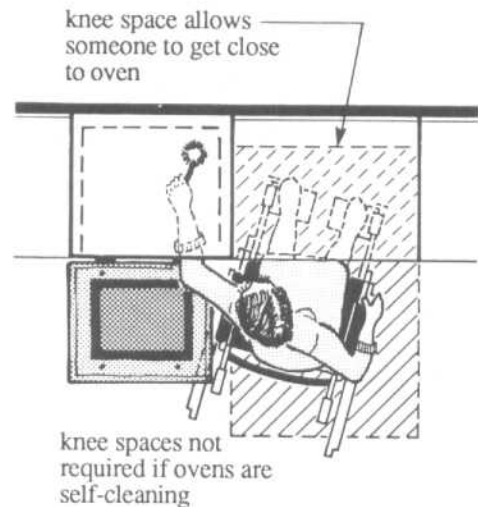


Fig. 22 Use of knee space next to oven.

KITCHENS

Wheelchair Accessible Design

Cooktops in Adjustable Height Counter Segments

ANSI 4.32.5.6 and UFAS 4.34.6.6 permit use of a standard range if the controls comply with ANSI 4.25 or UFAS 4.27. The controls must be placed along the front or the side of the range so that a seated person need not reach across a hot burner to adjust the controls (Fig. 24).

Some wheelchair users cannot use conventional ranges because the surface is too high and there is no knee space for maneuvering. Cooktops in lowered counter segments with knee space below allow some wheelchair users to get close enough to

operate the controls and move heavy pots and pans (Fig. 25).

Cooktops with smooth surfaces are preferred by people with limited hand and arm strength because they can slide pots of hot food on and off the cooktop rather than lifting them over raised burners and knobs.

When a cooktop is installed in a lowered counter, the width of the counter segment and knee space should be at least 30 inches and should provide space to the side of the cooktop for utensils and maneuvering. An additional 30 inches to the side is recom-

mended (Fig. 26).

When the knee space is under a cooktop, the standards require that the bottom of the cooktop be insulated to protect against accidental burns.

While this type of installation may be the only way that some people can cook, it does expose a person in a wheelchair to the hazard of spilling hot food in his/her lap. People who pull up beneath the cooktop must exercise extreme care and cool hot foods before moving them.

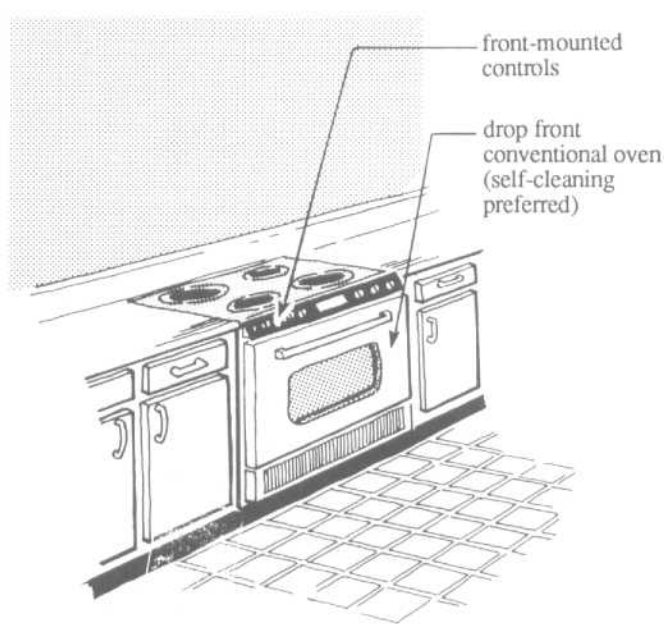


Fig. 24 Standard range.

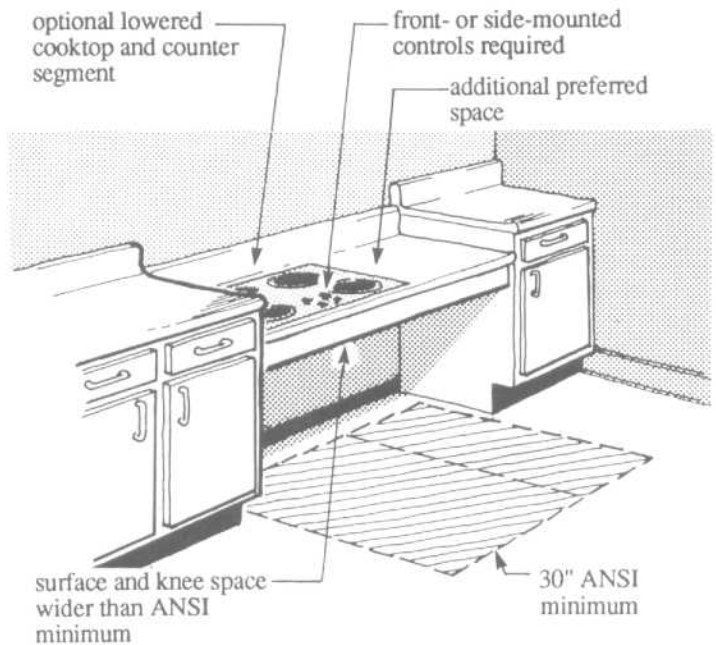


Fig. 26 Lowered cooktop with knee space and wide counter.

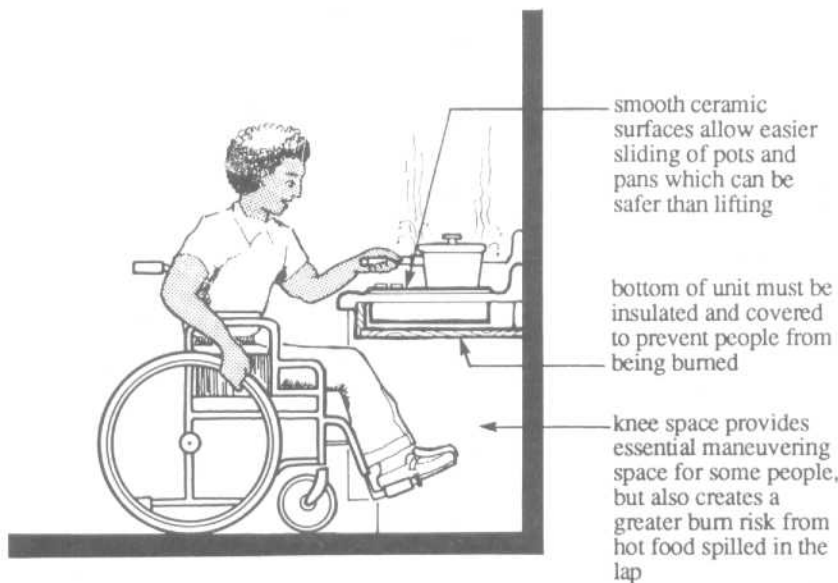
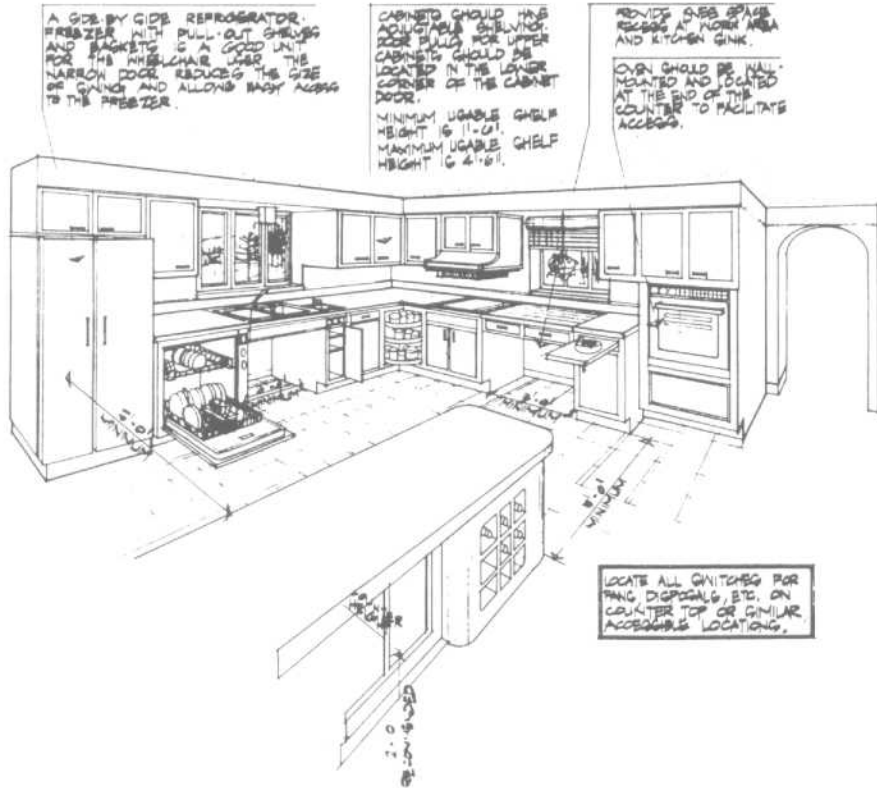
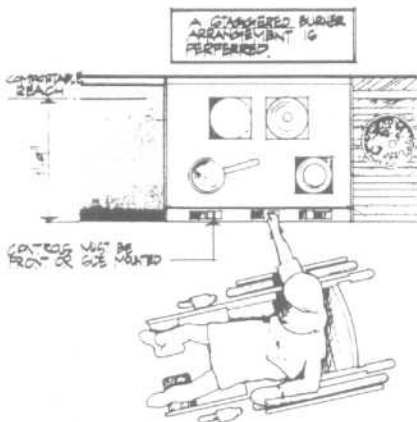


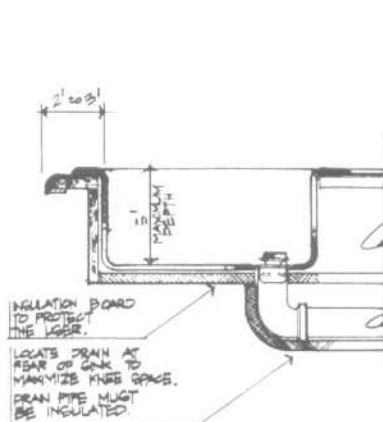
Fig. 25 Use of cooktop with knee space.



Kitchen arrangements



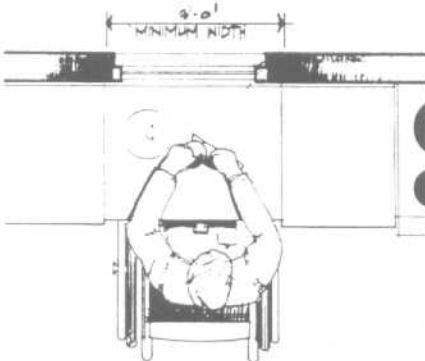
Counter-mounted cook top



Sink



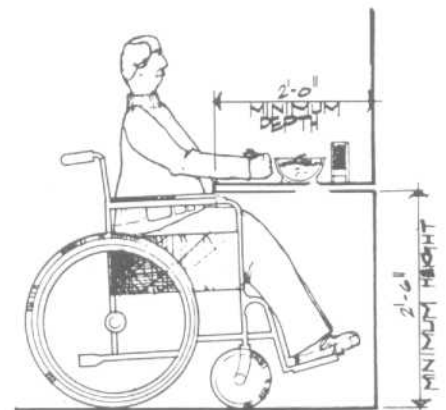
Knee-space clearance



Knee-recess work area



Disposal sink

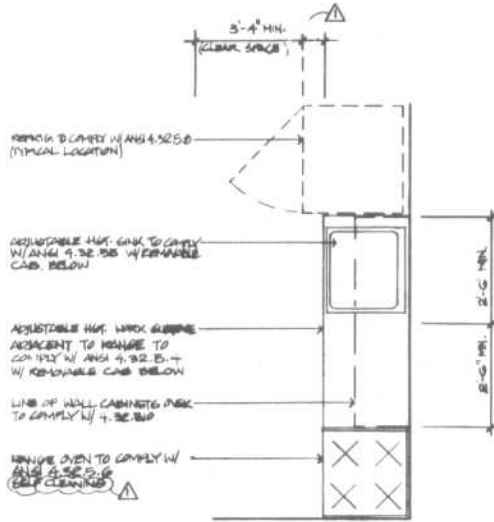


Armrest clearance

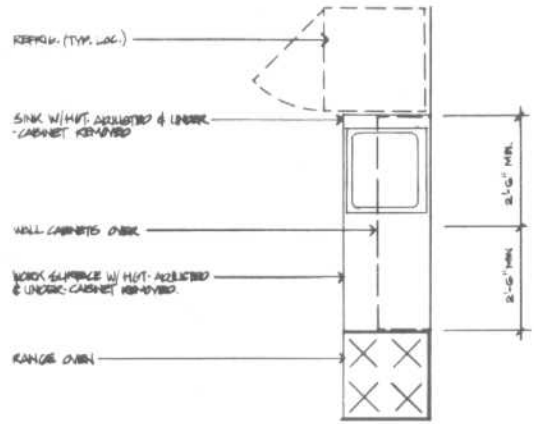


KITCHENS

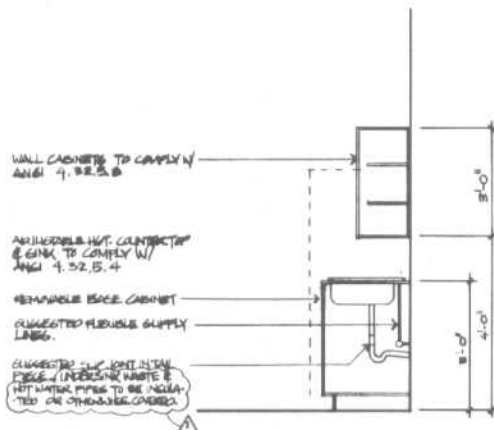
Wheelchair Accessible Design



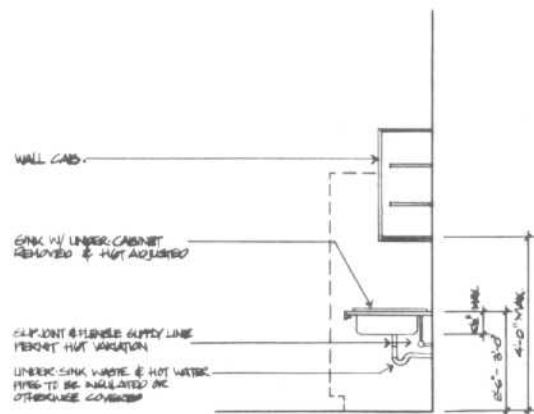
1 PLAN: TYPICAL ADAPTABLE KITCHEN: LINEAR  
1/2" = 1'-0"



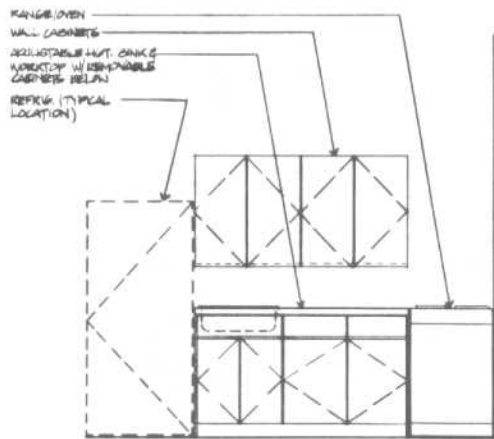
1A PLAN: TYPICAL ADAPTED KITCHEN: LINEAR  
1/2" = 1'-0"



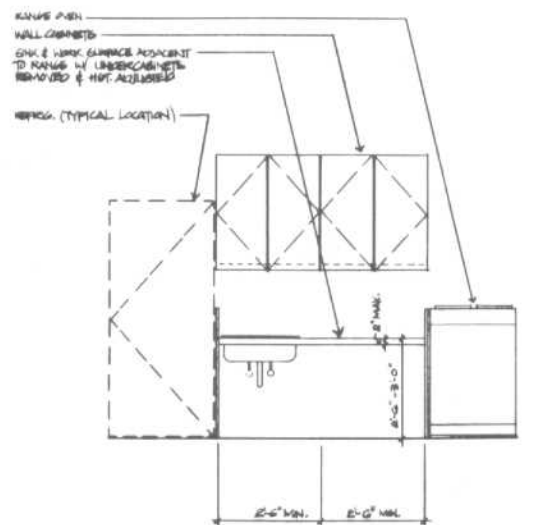
2 SECTION: TYPICAL ADAPTABLE KITCHEN: LINEAR  
1/2" = 1'-0"



2A SECTION: TYPICAL ADAPTED KITCHEN: LINEAR  
1/2" = 1'-0"



3 ELEVATION: TYPICAL ADAPTABLE KITCHEN: LINEAR  
1/2" = 1'-0"

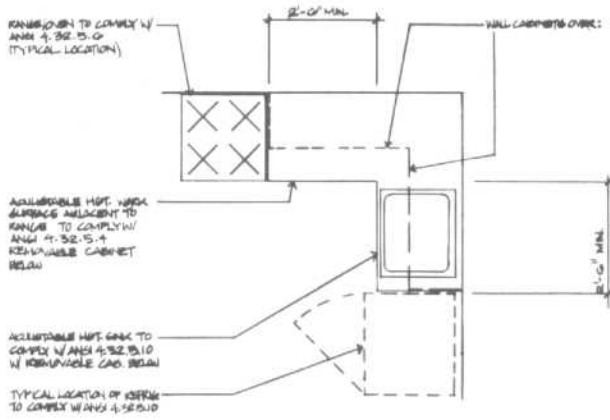


3A ELEVATION: TYPICAL ADAPTED KITCHEN: LINEAR  
1/2" = 1'-0"

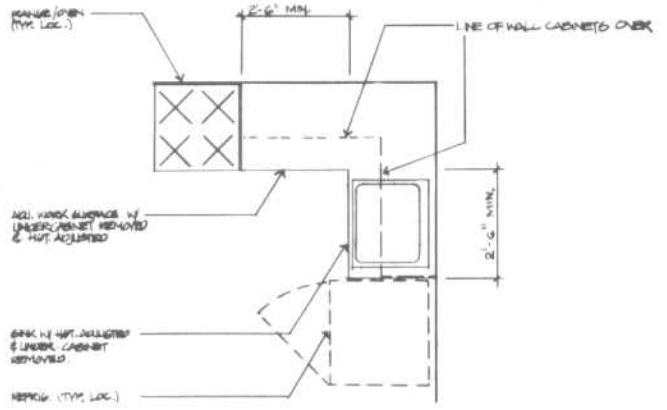


KITCHENS

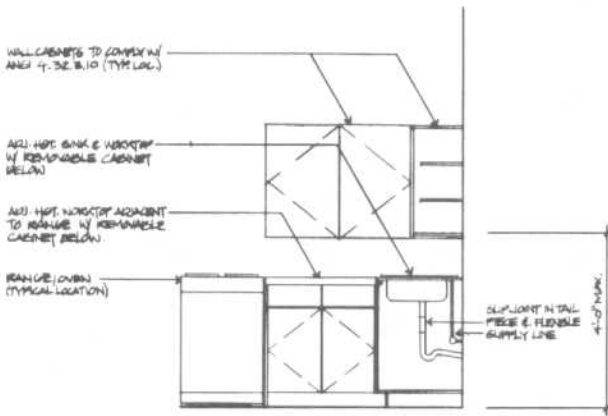
Wheelchair Accessible Design



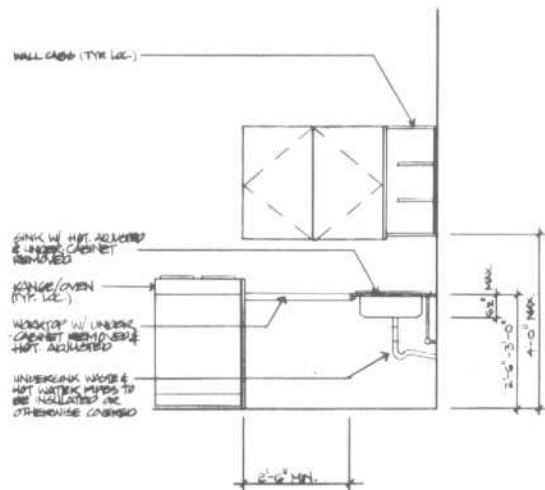
4 PLAN: TYPICAL ADAPTABLE KITCHEN : L-SHAPED  
1/2" = 1'-0"



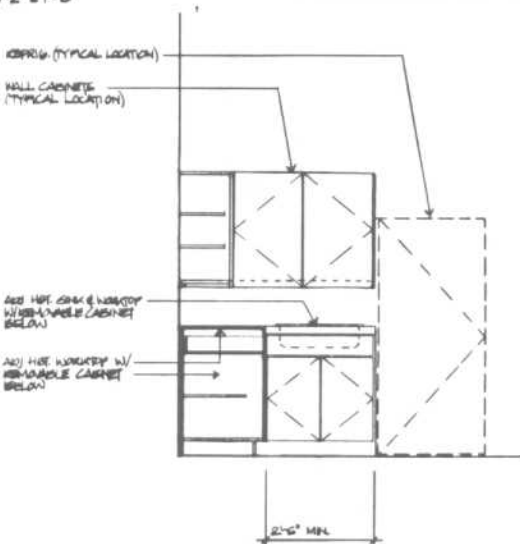
4A PLAN: TYPICAL ADAPTED KITCHEN : L-SHAPED  
1/2" = 1'-0"



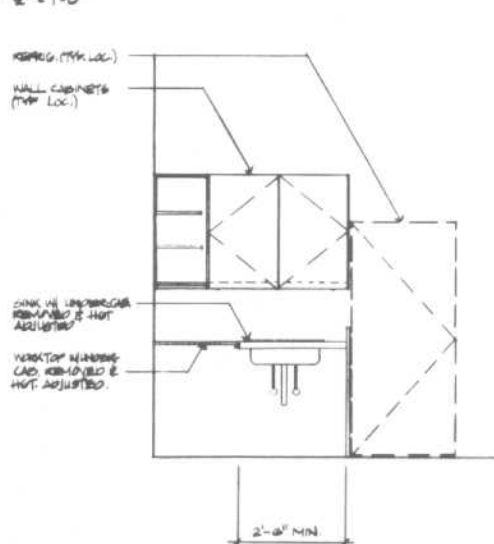
5 ELEVATION: TYPICAL ADAPTABLE KITCHEN : L-SHAPED  
1/2" = 1'-0"



5A ELEVATION: TYPICAL ADAPTED KITCHEN : L-SHAPED  
1/2" = 1'-0"



6 ELEVATION: TYPICAL ADAPTABLE KITCHEN : L-SHAPED  
1/2" = 1'-0"



6A ELEVATION: TYPICAL ADAPTED KITCHEN : L-SHAPED  
1/2" = 1'-0"

LIBRARY/STUDY

Anthropometric Data

It is difficult to develop precise formulas by which to design residential library shelving or to project the number of books that can be accommodated on a unit base because of the many variables involved. The size of books, the types of books and other reading materials, the reach limitations of the user, etc., all have an impact upon the design requirements.

It is possible, however, for preliminary planning purposes, to apply the broad guidelines indicated in Figs. 1 to 3. Seven volumes per foot of shelving can be used as a rule-of-thumb to project capacity. The height of the highest shelf above the floor should be limited to between 78 and 81 in; 24 in is the minimum height above the floor to gain access to a shelf without squatting. Limitations for shelving to serve children will differ and are indicated in Fig. 3.

TABLE 1 Library Shelving: Volumes per Linear Foot of Shelf Based on Subject

(Standard stack section 3 ft wide × 7½ ft high with 7 shelves)

Subject	Volumes per foot of shelf	Volumes per single face section
Art (excluding oversize)	7	147
Nonfiction	8	168
Economics	8	168
Fiction	8	168
General literature	7	147
History	7	147
Law	4	84
Medical	5	105
Periodicals, bound	5	105
Public documents	5	105
Technical and scientific	6	126
Average for overall estimating		125

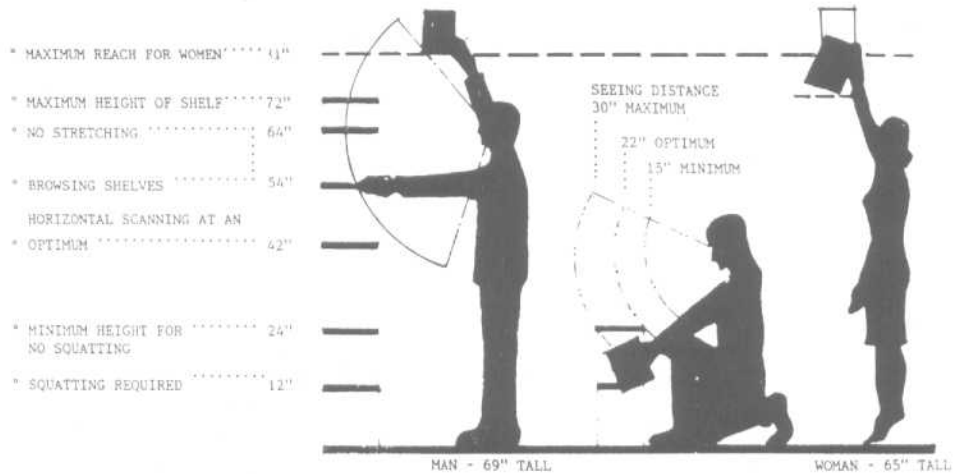


Fig. 1 Optimum shelving conditions for adults.

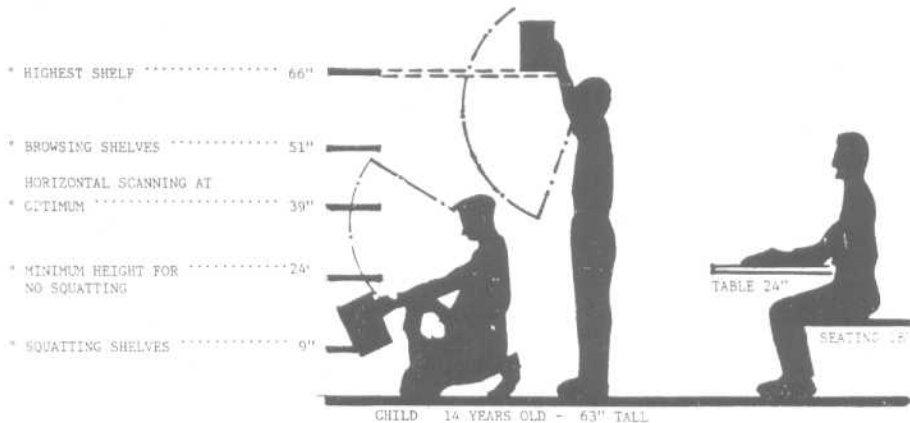


Fig. 2 Optimum shelving conditions for teenagers.

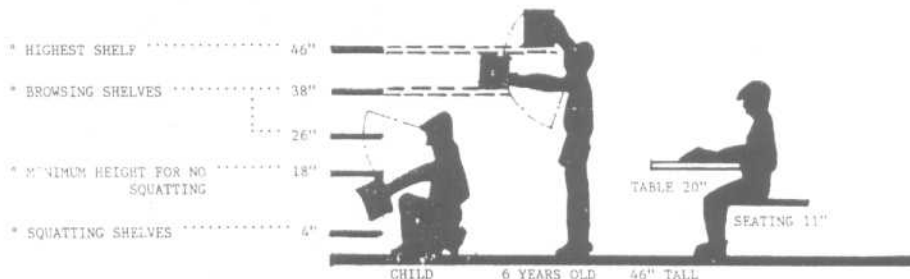
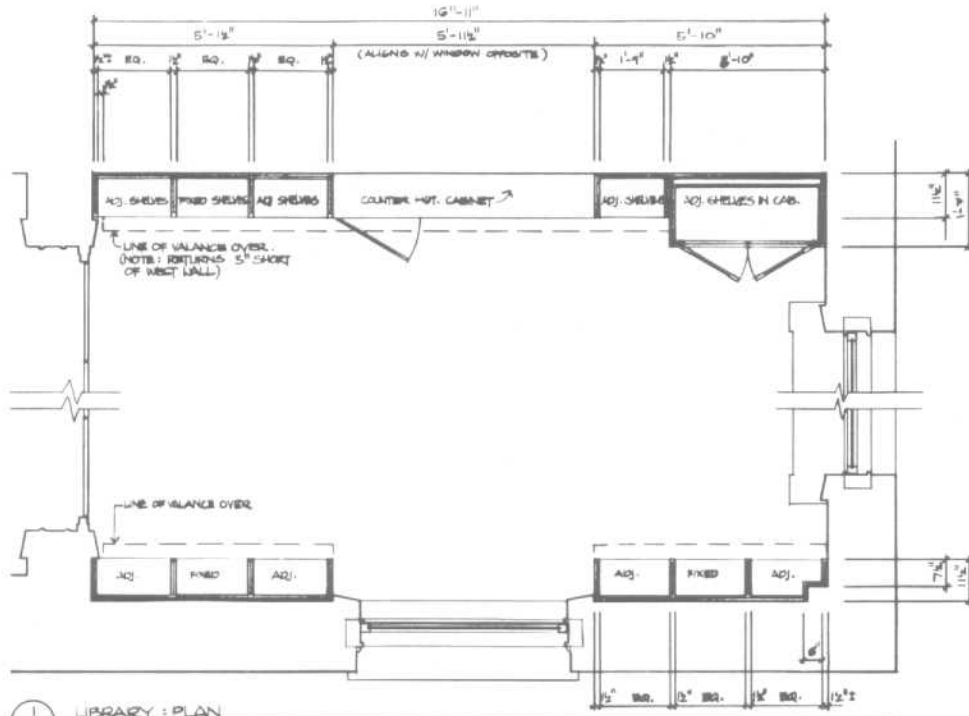
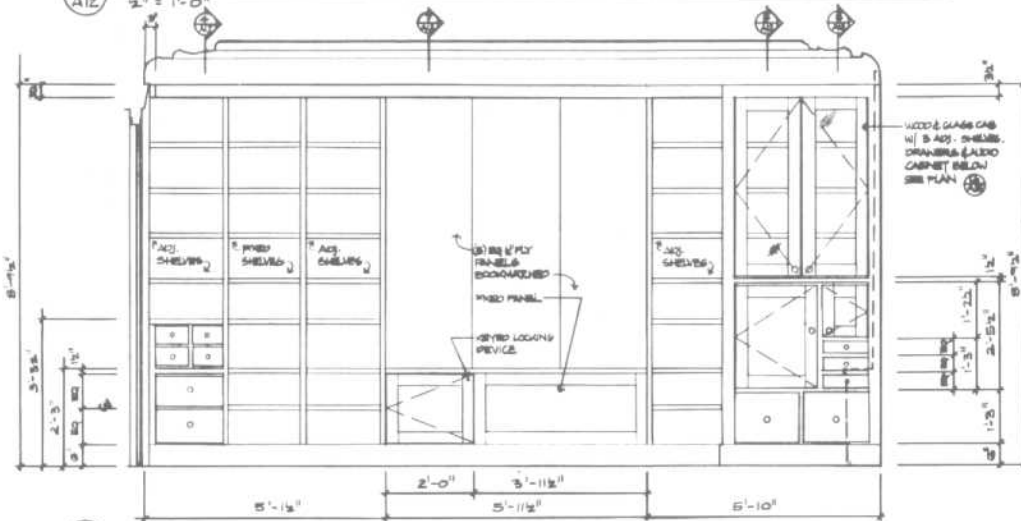


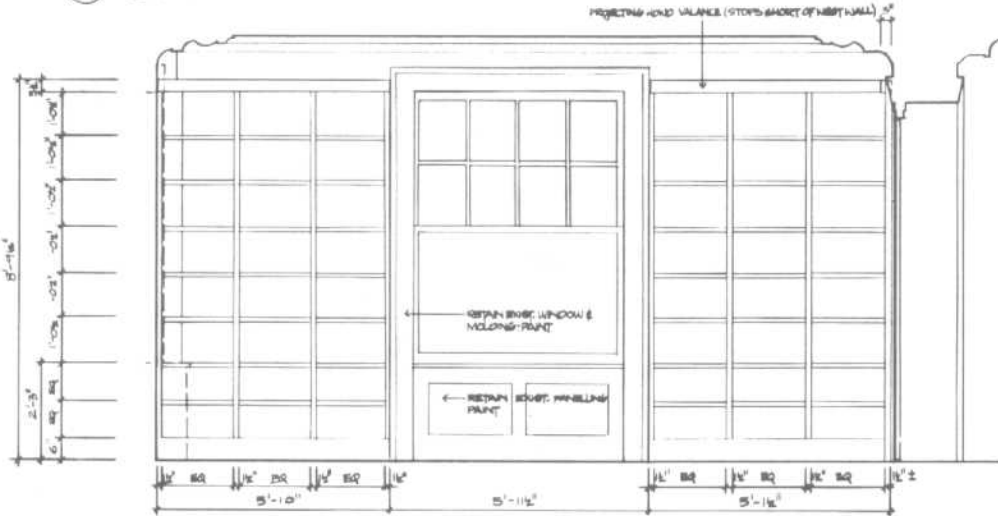
Fig. 3 Optimum shelving conditions for children.



1 LIBRARY : PLAN  
1/2" = 1'-0"



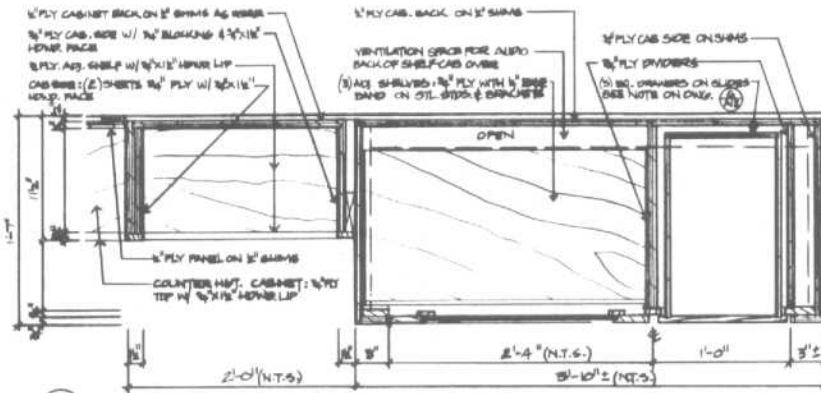
2 LIBRARY : NORTH ELEVATION  
1/2" = 1'-0"



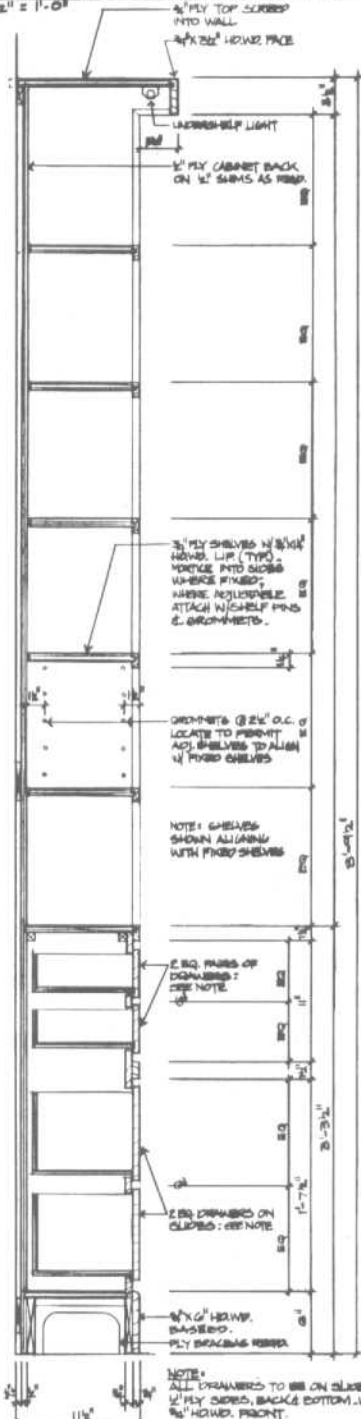
3 LIBRARY : SOUTH ELEVATION  
1/2" = 1'-0"

LIBRARY/STUDY

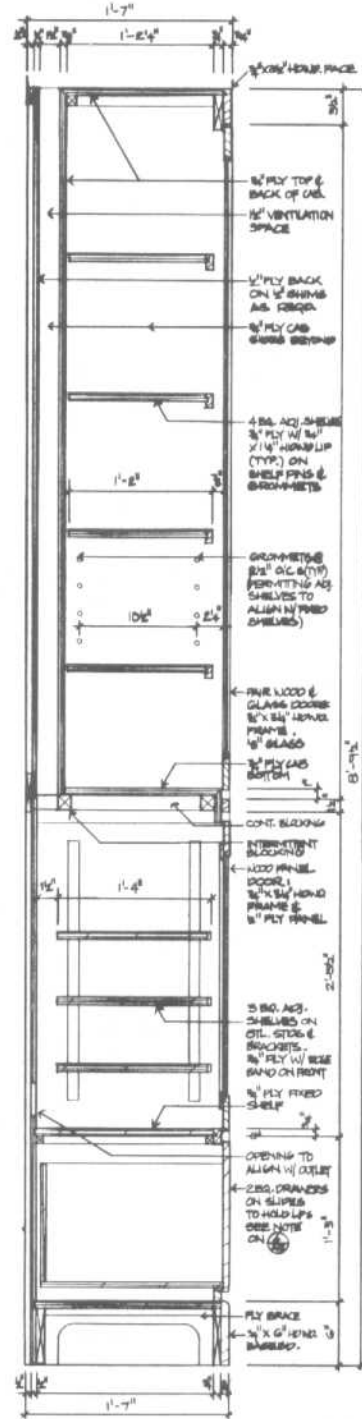
Library Shelving Details



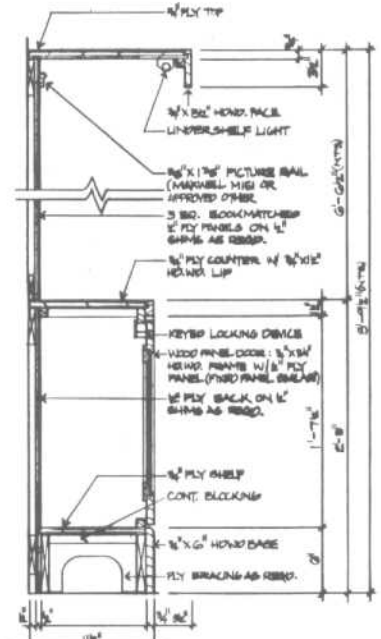
6 LIBRARY: PLAN OF SHELVES & AUDIO CABINET  
1/2" = 1'-0"



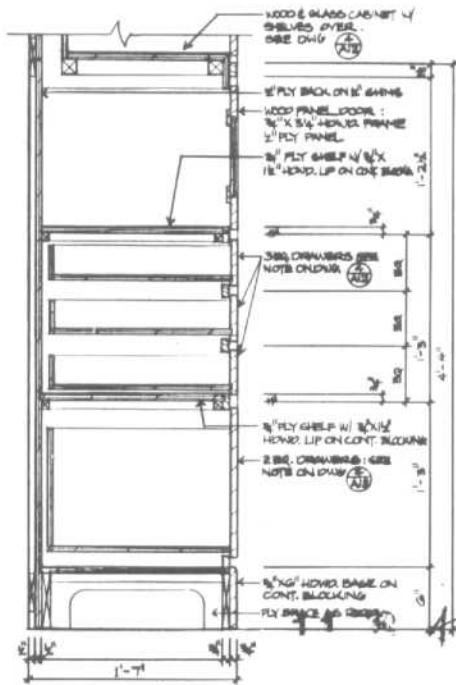
4 LIBRARY: DETAIL OF NORTH WEST CABINET  
1/2" = 1'-0"



5 LIBRARY: DETAIL @ AUDIO CABINET  
1/2" = 1'-0"

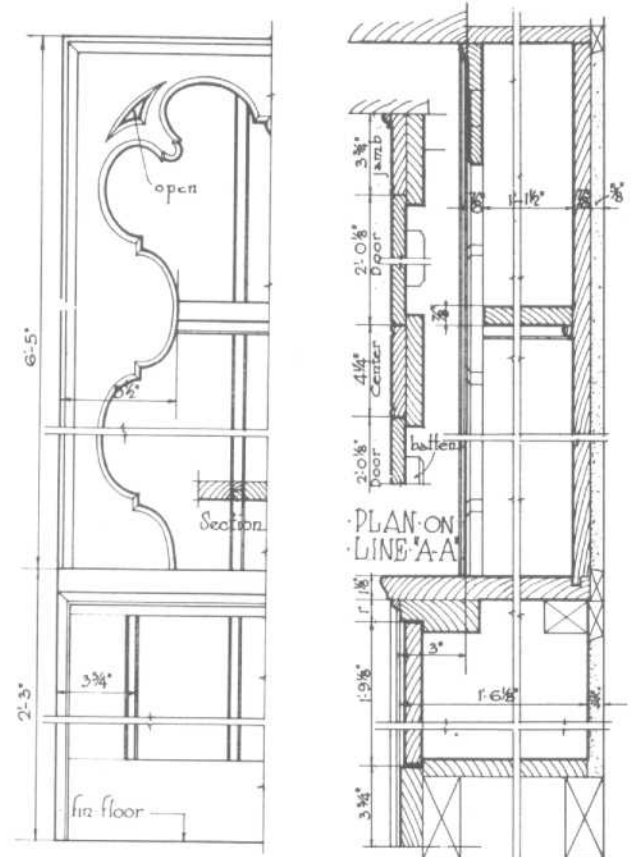


7 LIBRARY: COUNTER HGT. CABINET  
1/2" = 1'-0"

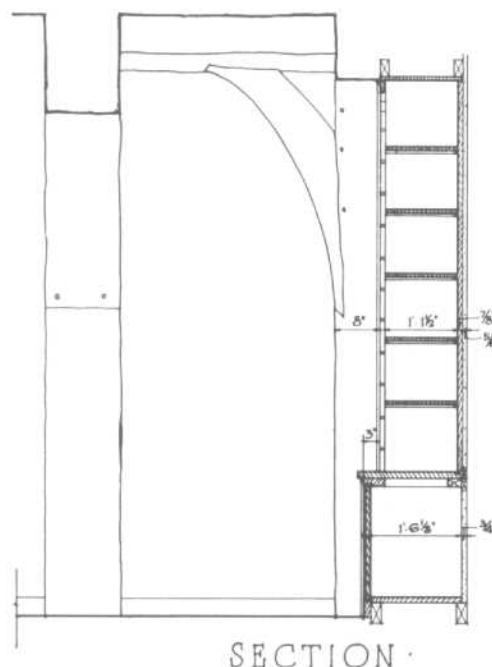
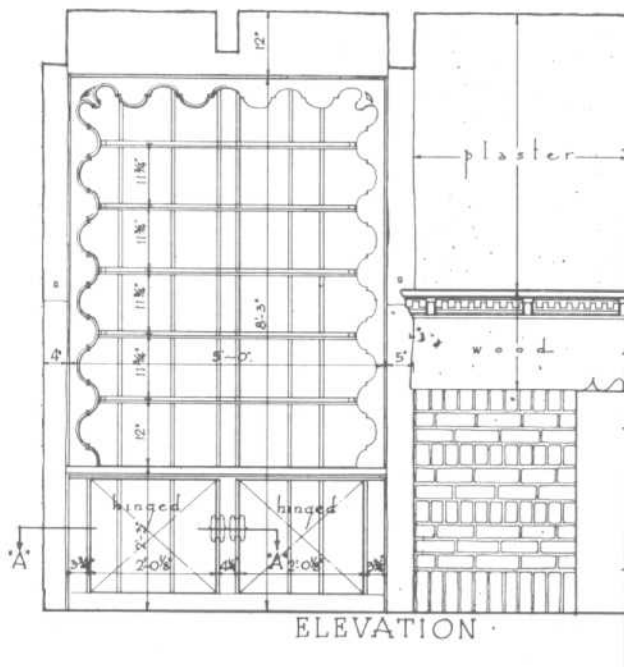


LIBRARY - DETAIL @ NORTHEAST CABINET  
1/2" = 1'-0"

DETAIL OF SHELVING



Note: All woodwork in Bookcase and Cupboards is White Oak

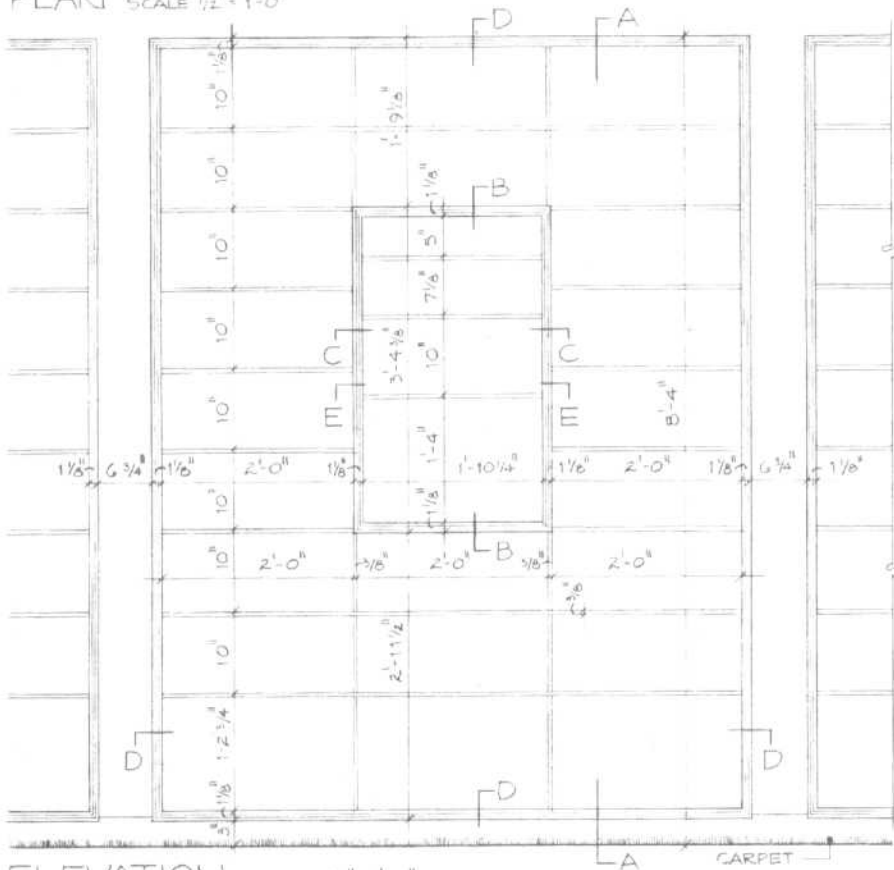


LIBRARY/STUDY

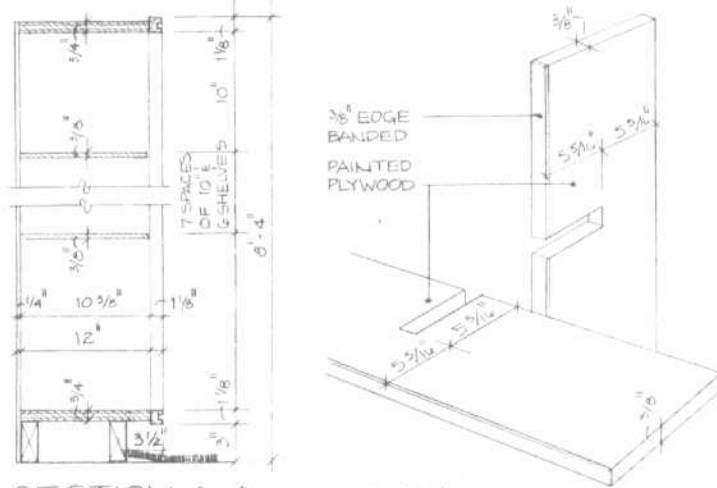
Built-In Bookshelves



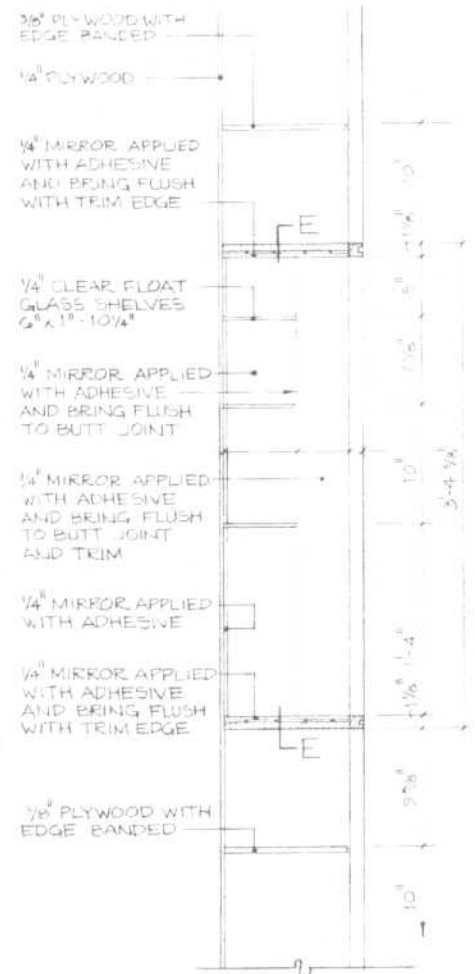
PLAN SCALE 1/2" = 1'-0"



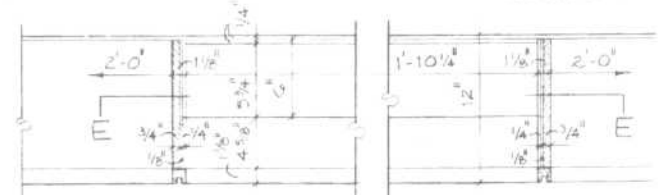
ELEVATION SCALE 1/2" = 1'-0"



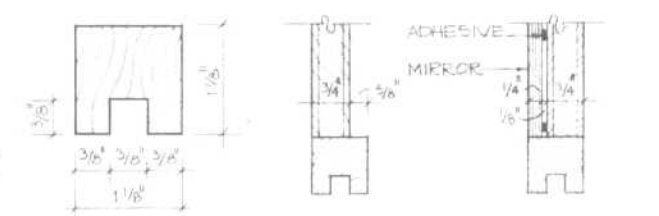
SECTION A-A SCALE 3/4" = 1'-0"



SEC. B-B THROUGH BAR SCALE 3/4" = 1'-0"



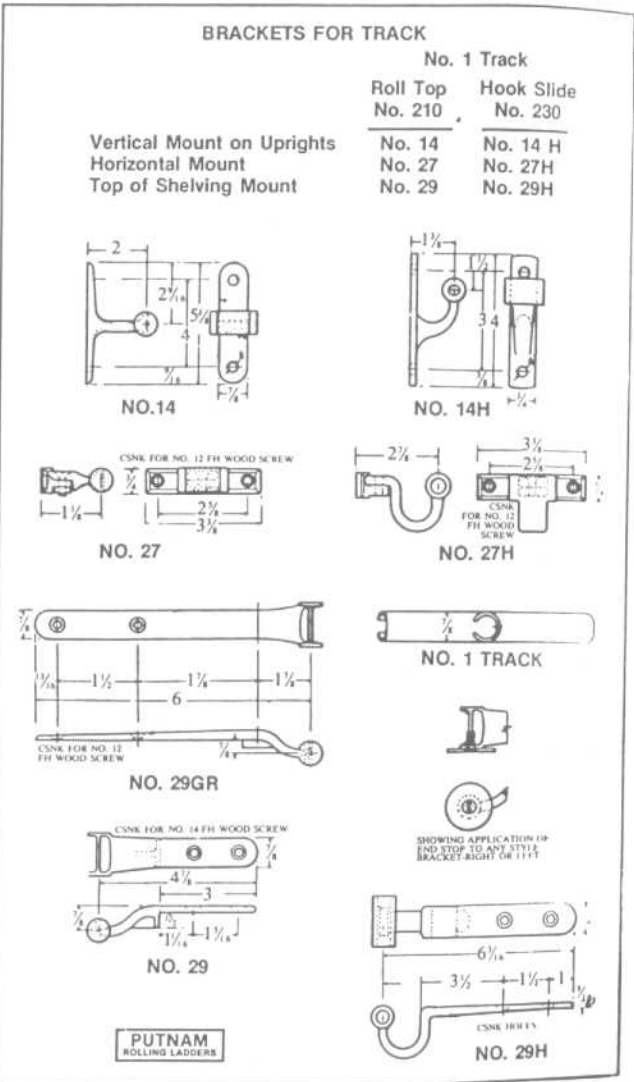
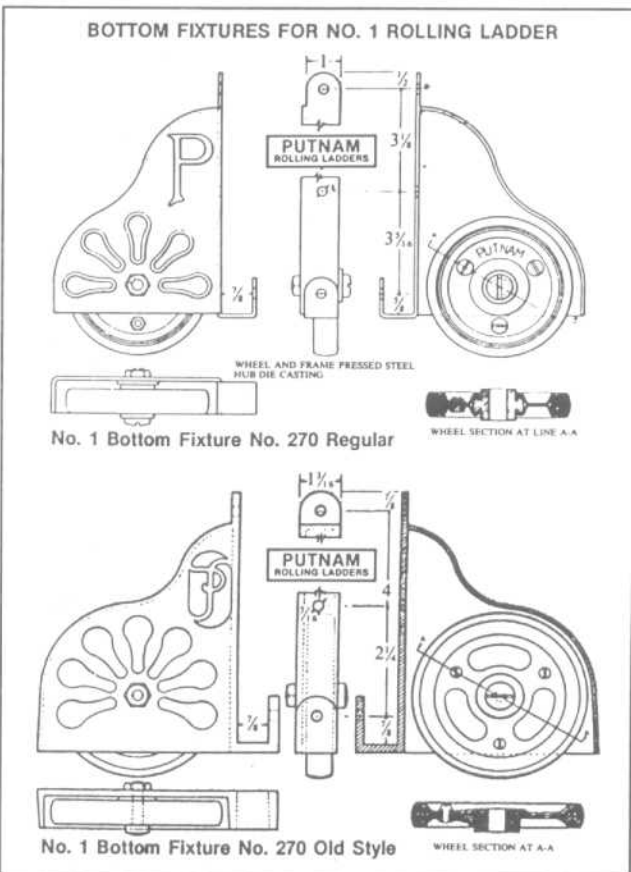
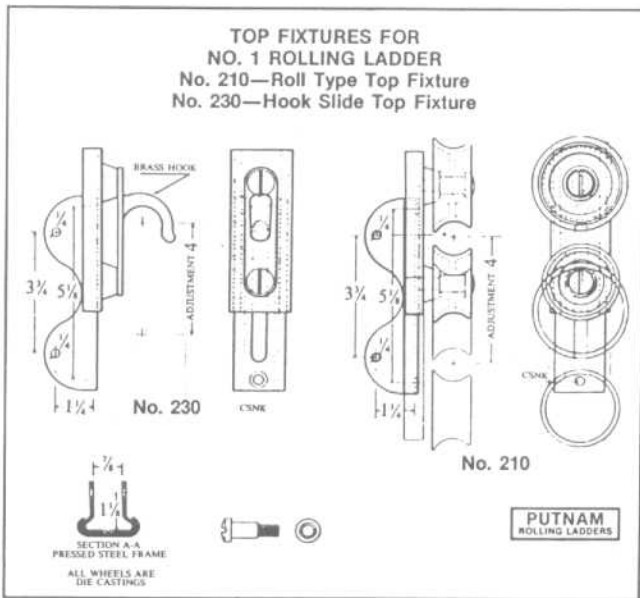
SECTION C-C THROUGH BAR SCALE 3/4" = 1'-0"



TRIM 1/2 FULL SIZE  
SEC. D SCALE 1/4" = 1'-0"  
SEC. E SCALE 1/4" = 1'-0"

**BUILT-IN BOOKSHELVES**

Here is a simple method of building in bookshelves, bar units, etc., for residences and other types of buildings by using an egg-crate system. The front of the shelf is supported by the vertical members and the back of the shelf is nailed to the plywood back. These built-in bookshelves and bar unit were developed for a residence on the Eastern Shore of Maryland. In this design Hugh Newell Jacobsen, FAIA, divided the built-in bookcases into units of three shelf widths and introduced a recessed vertical divider 3" deep by 7 1/2" wide between bookcase units. The major trim piece is solid wood 1 1/8" x 1 1/8" with a 3/8" wide by 3/8" deep groove at the middle. This simple trim piece acts as framing for sides, top, and bottom of the bookshelves and also for the bar unit with glass shelves and mirrored back, sides, top, and bottom.



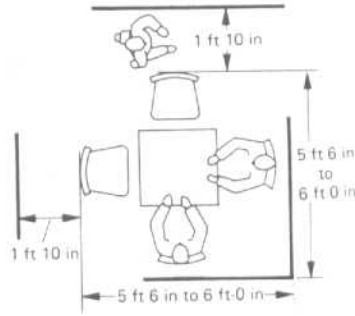
**FAMILY/RECREATION ROOMS**

Arrangements and Clearances

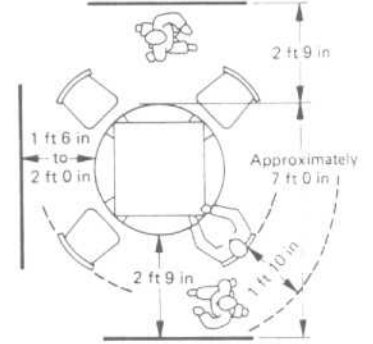
**Recreational Activities**

Indoor recreational activities invariably require definite spaces for equipment and clearances for using it. Not all games occupy floor areas indicated as necessary for those diagrammed on this page. But if interiors are planned to accommodate large units of equipment such as that required for table tennis, and provide necessary playing clearances, spaces will be adequate for many other uses as well.

Dimensions of game equipment and floor areas required for its use are both subject to variation. Sizes noted here are comfortable averages, not absolute minima.



Clearances for playing bridge



Clearances for playing poker

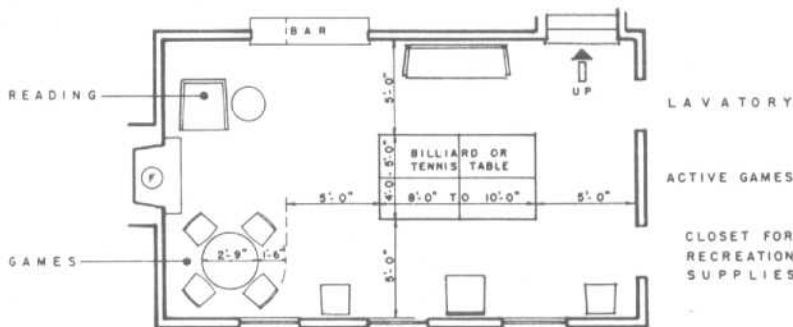
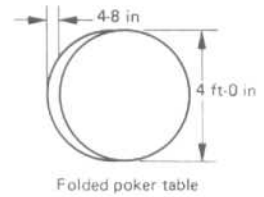
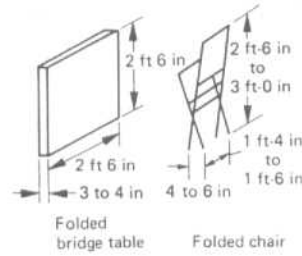
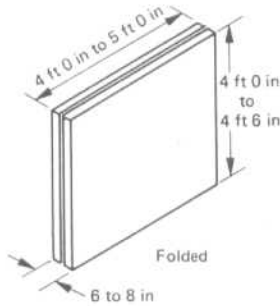
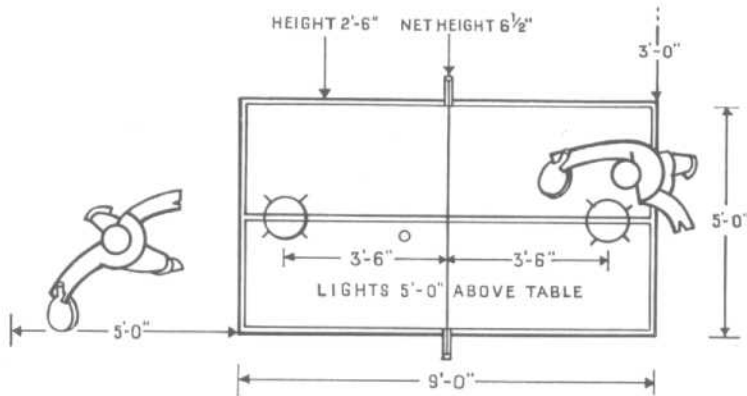


Fig. 1 Play room.

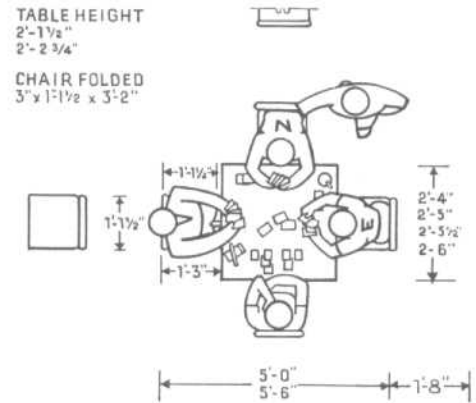


**FAMILY/RECREATION ROOMS**

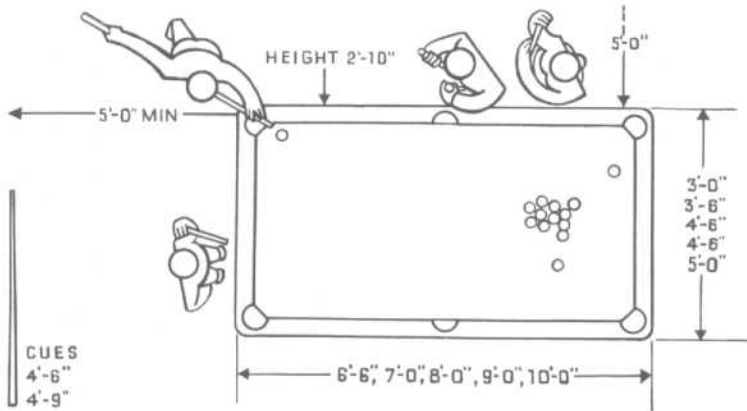
Arrangements and Clearances



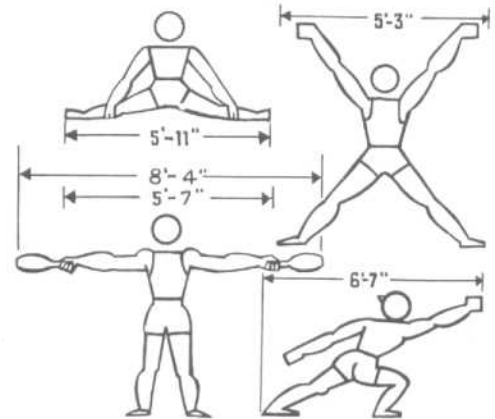
PING PONG



CARD PLAYING



POOL AND BILLIARDS



GYMNASTICS

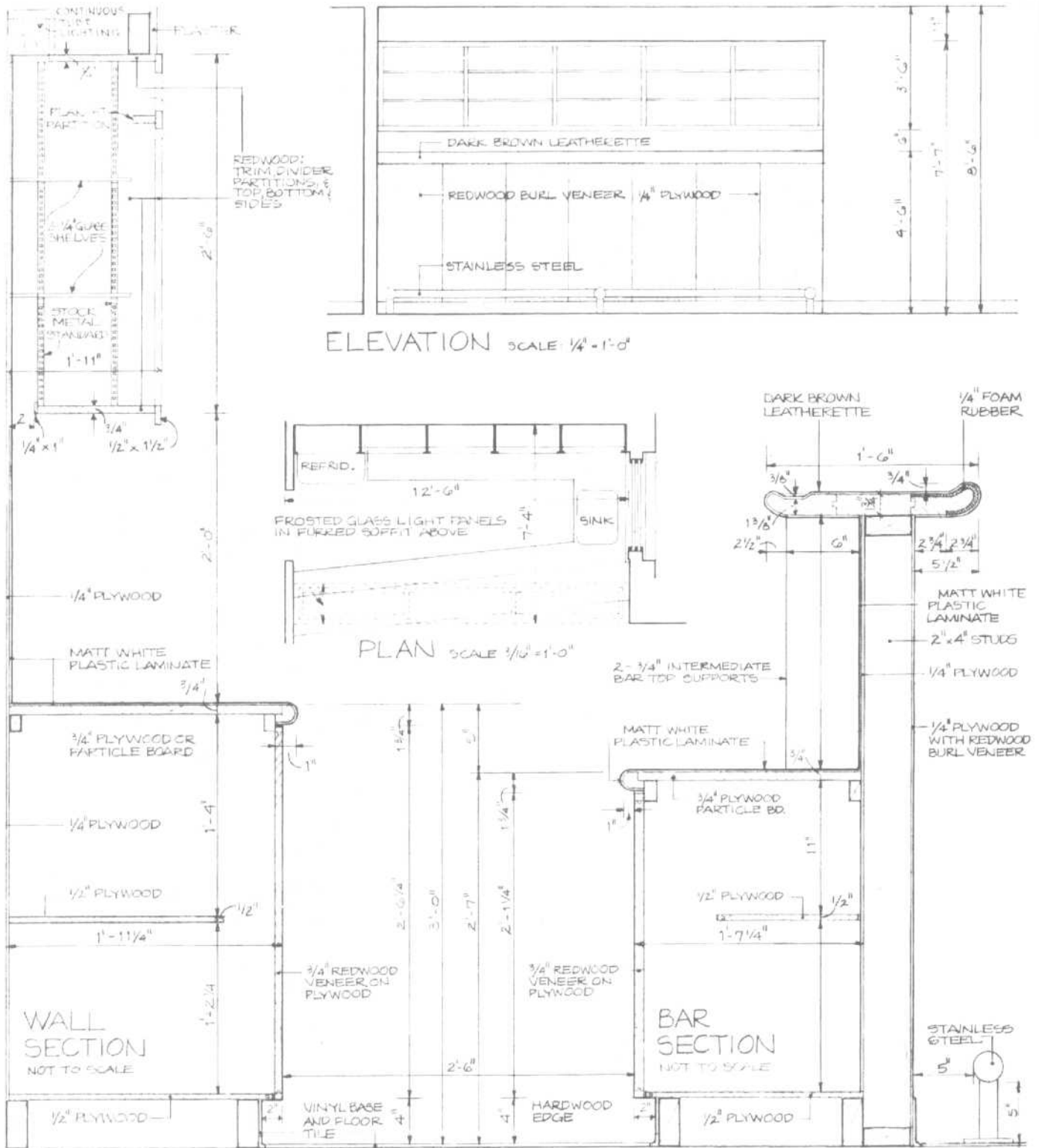
**TABLE 1 Pool and Billiard Table Sizes (in feet)**

Size	Where used
3 x 6	Home
3 1/2 x 7	Home
4 x 8	Home
	Commercial standard in South America, Mexico, and Spain
4 1/2 x 9	Popular U.S. commercial standard
5 x 10	U.S. professional standard
6 x 12	Commercial standard in Canada and England

Standard ping pong table sizes are 3 ft x 6 ft; 3 ft 6 in x 7 ft 0 in; 4 ft 0 in x 8 ft 0 in; 4 ft 8 in x 8 ft 6 in; 5 ft 0 in x 9 ft 2 in; 5 ft 6 in x 10 ft 2 in; 6 ft 8 in x 12 ft 8 in.

FAMILY/RECREATION ROOMS

Residential Bar

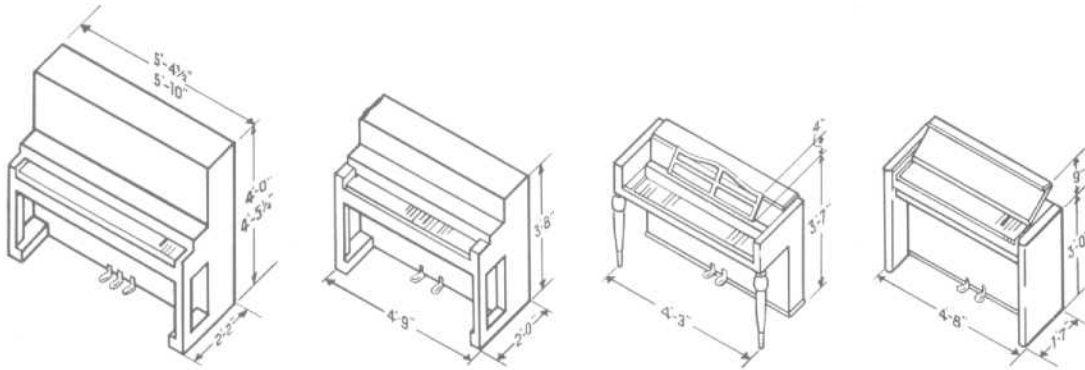


RESIDENTIAL BAR

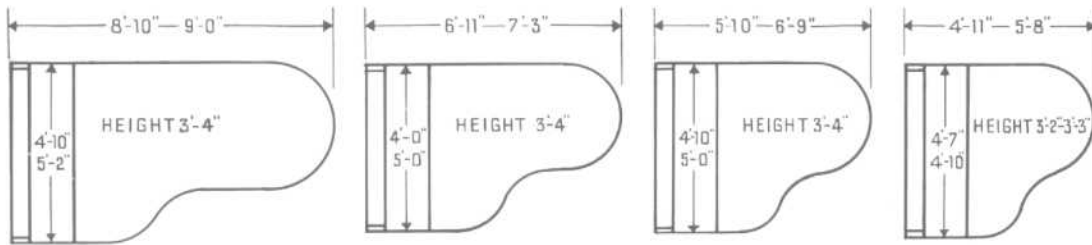
This small residential bar with double lighting was designed so that the back bar shelves would display all the types of bar glasses and the liquor bottles as a decorative element. Note how the recessed fluorescent tube fixtures indirectly light up all the glasses and the 2" open slot in the bottom shelf indirectly lights up the liquor bottles on the back bar shelf. The entire front bar has recessed light fixtures in the ceiling above; this allows for two different methods of lighting the bar area. Note also that the bar front is slightly padded with foam rubber and the entire bar top is finished with dark brown leatherette.

FAMILY/RECREATION ROOMS

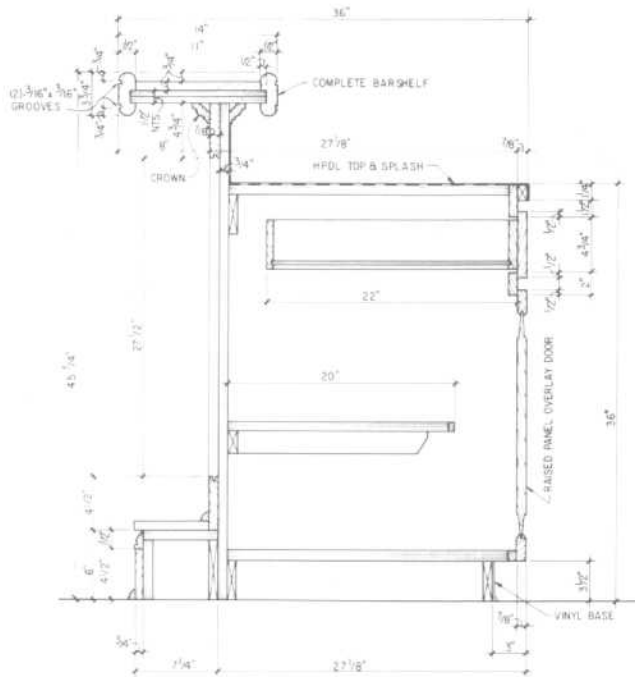
Piano Sizes; Bar Details



UPRIGHT PIANO SIZES



GRAND PIANO SIZES



SECTION THRU BAR CABINET

## LAUNDRY/SEWING ROOMS

## Laundry Room Layouts

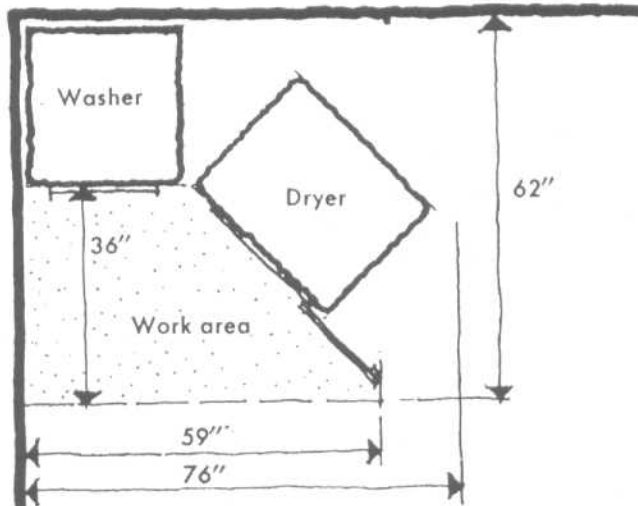


Fig. 1 Angle arrangement.

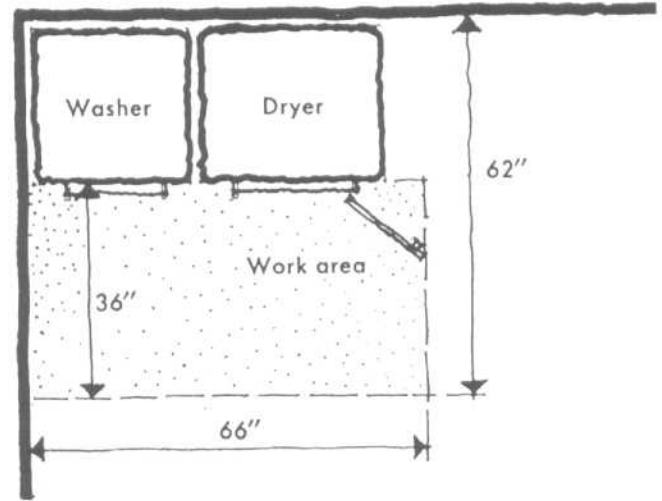


Fig. 2 Conventional arrangement.

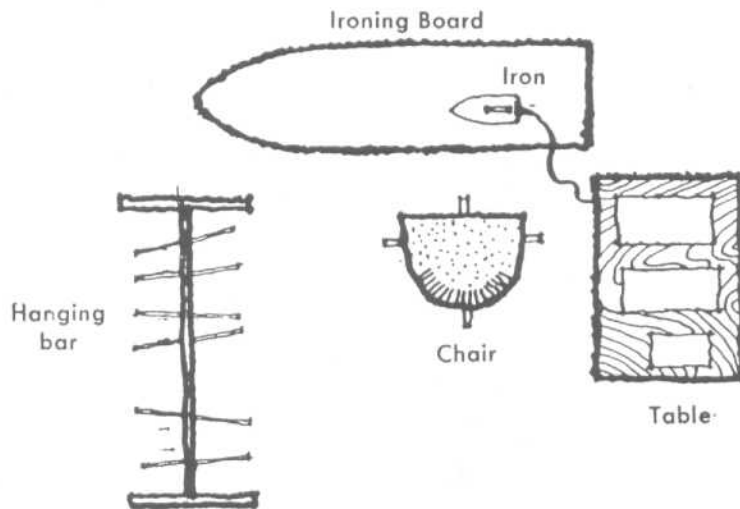


Fig. 3 Arrangement of ironing equipment based on flow of work.

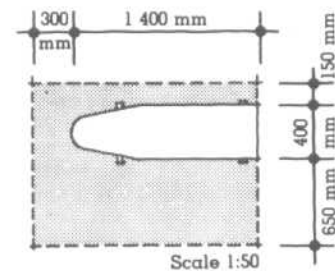


Fig. 4. Space around ironing board.

## HOME LAUNDRY ACTIVITIES

Home laundry includes the processes from sorting through ironing of clothes and household linens, including pretreating, washing, drying, and sprinkling.

## General Planning Suggestions

1. It is desirable to plan space for specific laundry processes.
2. Moistureproof surfaces are needed for pretreating and sprinkling of clothes.
3. Drying areas should be accessible for use under all climatic conditions.
4. To control moisture in the room, dryers should be located to permit venting to the outside of the house.
5. Adequate storage for washing equipment and supplies should be located near the place of first use.
6. Facilities for hanging drip-dry garments after washing should be provided.
7. In locating the washing equipment consideration should be given to convenience of inter-related household activities, distances from the source of soiled clothes and the drying areas, and the isolation of clutter.

TABLE 1 Space Requirements for Washer-Dryer Arrangements

Type and size of equipment	Auxiliary equipment	Work area, in	Total floor area, in	
			Width	Depth
Stacked arrangement: washer, 31 × 26 in; dryer, 31 × 26 in	Basket, 19-in diameter	43 × 37	43	63
Angle arrangement: washer 26 × 26 in; dryer, 31 × 26 in	Basket, 19-in diameter	36 × 59	62	76
Straight-line arrangement: washer, 26 × 26 in; dryer, 31 × 26 in	Basket, 19-in diameter	36 × 66	62	66

Figures 1 and 2 illustrate arrangements of laundry equipment. Space needed by a single worker in front of equipment or between equipment placed opposite is indicated. Overall dimensions of areas will vary with type and size of equipment selected. No allowance has been made between the back of equipment and the wall for electrical, plumbing, and dryer vent connections. The space required will depend on the type of installation used.

Counter space is provided for sorting and folding three washer loads of clothes. The

space under the counters has been used for bins, one for soiled clothing and the other for dry, clean articles that require further treatment before use or storage. Additional counter space can be provided by the tops of the dryer and washer, depending upon the type selected.

A tall storage cabinet for laundry supplies would complement each arrangement. In this cabinet, an ironing board, iron, mops, and buckets (needed for cleaning the laundry area) may also be stored.

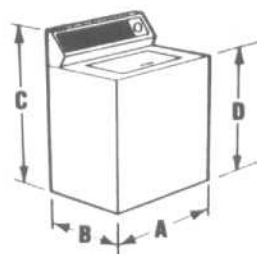


Fig. 5 Automatic washer. A = 24–30 in, B = 26–30 in, C = 42 in, D = 36 in.

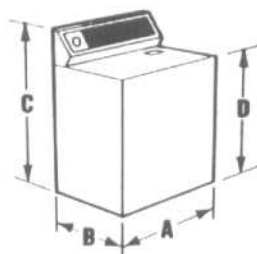


Fig. 6 Automatic dryer. A = 24–28 in, B = 24–26 in, C = 42 in, D = 36 in.

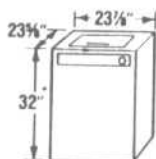


Fig. 7 Compact washer.

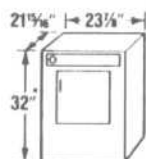


Fig. 8 Compact dryer.

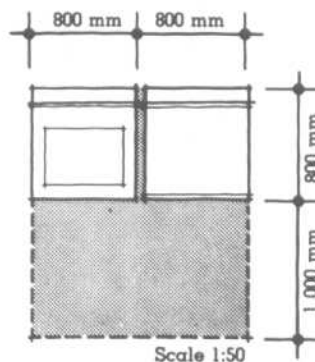


Fig. 10 Clearance in front of automatic washer and dryer. If the space in front of the automatic washer and dryer is a corridor, this dimension should be increased to at least 1200 mm (4 ft). This will permit a second person to pass through when someone is doing the laundry. If a washer and dryer are located opposite each other, this dimension should also be 1200 mm (4 ft).

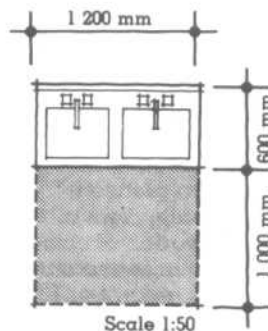


Fig. 11 Clearance in front of laundry tub.

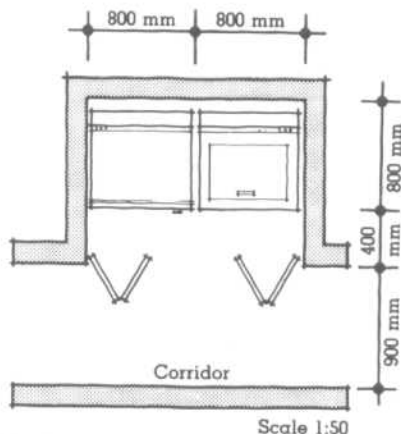


Fig. 9 When space is limited, it may be possible to locate the laundry space next to a corridor.

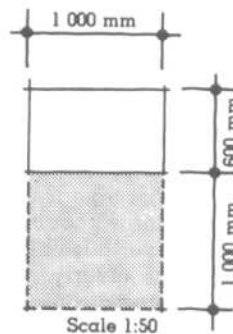


Fig. 12 Clearance in front of sorting counter or table.

**LAUNDRY/SEWING ROOMS**

Laundry Room Layouts

**LAUNDRY LOCATION**

The ideal location of the laundry space is a matter of preference. The laundry area may be separate or combined with the bathroom, the kitchen, the utility space, or the corridor. The most frequently mentioned advantages and disadvantages of these various options are listed below.

**Separate Laundry**

**Advantages**

A separate space can be used for other activities such as sewing and hobbies, if it is large enough.

Clothes may be hung for air drying without interfering with other household activities.

Noise from laundry appliances can be shut off from the rest of the dwelling.

Temporary holding or storage of clothing to be washed or ironed is made easier.

**Disadvantages**

Providing this extra room increases the cost of the dwelling.

**Laundry in Combination with Bathroom**

**Advantages**

When the bathroom is located near the bedrooms, the washer and dryer are close to where most laundry originates. This facilitates gathering soiled articles and putting away clean linen and clothing.

Combining the laundry space with a half bathroom adjacent to the kitchen provides many of the advantages of a separate laundry room.

The tops of the laundry appliances provide useful horizontal space on which to lay clothes.

Floor and wall finishes in bathrooms are usually resistant to high humidities.

Usually, additional plumbing costs are minimal.

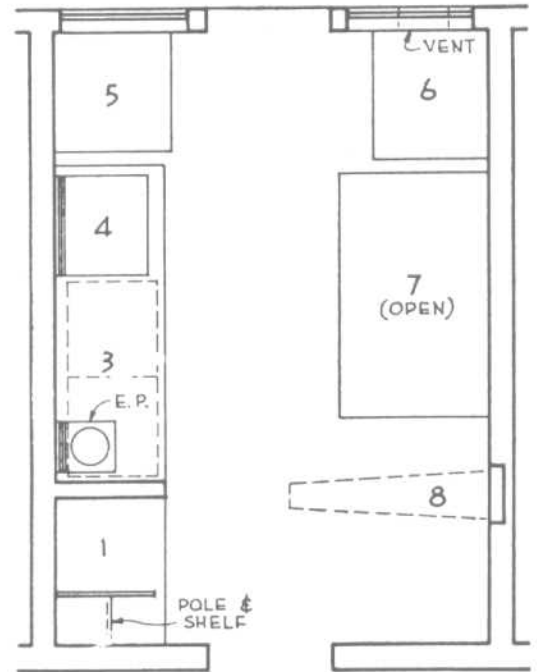
The bathroom sink may be used for hand washing.

Mechanical ventilation can be provided economically for both functions.

**Disadvantages**

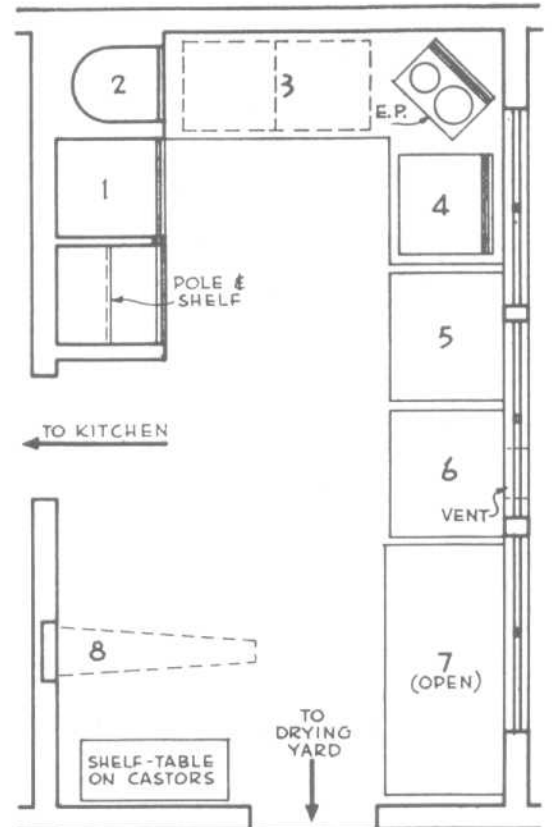
A bathroom will usually accommodate only washing and drying facilities. Other laundry related activities such as ironing, will have to be carried out elsewhere in the dwelling.

Occupants may wish to use the bathroom when laundry is being washed or dried.



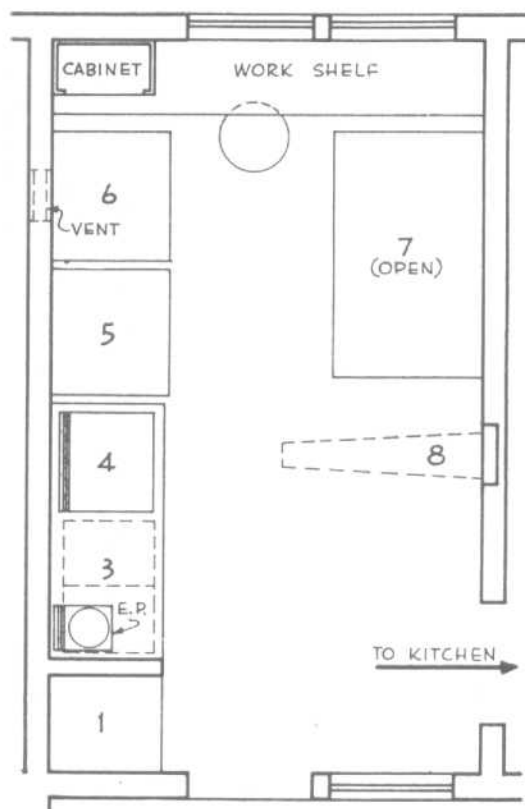
**KEY**

- 1. STORAGE CLOSET
- 2. CLOTHES CHUTE
- 3. SORTING SHELF
- 4. LAUNDRY TRAY
- 5. WASHING MACHINE
- 6. DRYER
- 7. IRONER
- 8. IRONING BOARD



## LAUNDRY/SEWING ROOMS

Laundry Room Layouts

**Laundry in Combination with Kitchen****Advantages**

Suitable in housing for young families because the person doing the laundry can keep an eye on the washing machine while doing other jobs and supervising the children.

Direct access to the outside for clothes drying is likely to be easier than from laundries located in a basement or on a second storey.

Kitchen sinks are usually sizeable and can be used for laundering.

Additional plumbing costs are usually small.

**Disadvantages**

Danger of cross-contamination through the handling of dirty washing during food preparation.

Grease and cooking smells can be passed on to clean clothes.

Noise generated by running appliances cannot easily be shut off from the rest of the dwelling.

**Laundry in Combination with Utility Space in Basement****Advantages**

Generally, as much space as needed can be provided.

Noise generated by running appliances can be easily shut off from the rest of the dwelling.

**Disadvantages**

Laundry must be carried up and down stairs, although automatic dryers have eased the problem of carrying heavy baskets of damp clothes to outdoor clotheslines.

**Laundry in Combination with Corridor****Advantages**

The space is used more economically (Fig. 9).

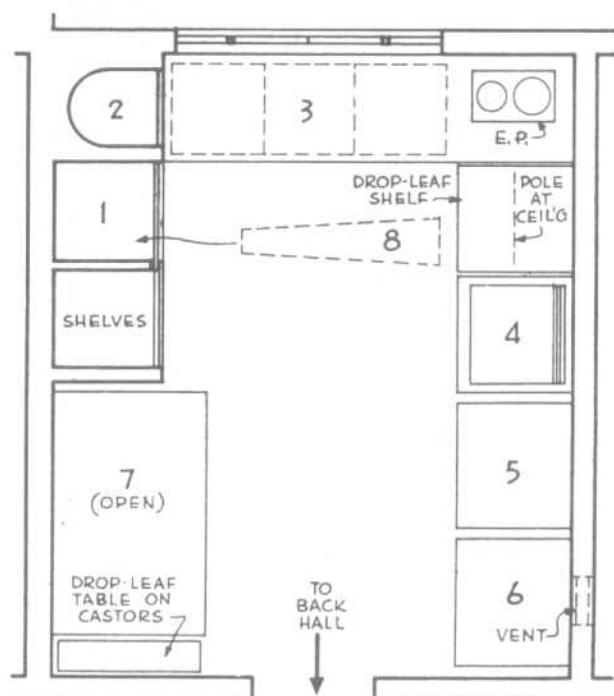
The space above the appliances may be used as a linen closet.

The appliances can be hidden from sight when they are not in use; they can be recessed into the wall and enclosed with doors.

**Disadvantages**

Noise generated by running appliances cannot be easily shut off from the rest of the dwelling.

An alcove adjacent to a corridor will accommodate only a minimum-sized laundry area. Other laundry related activities, such as ironing, will have to be carried out elsewhere in the dwelling.



LAUNDRY/SEWING ROOMS

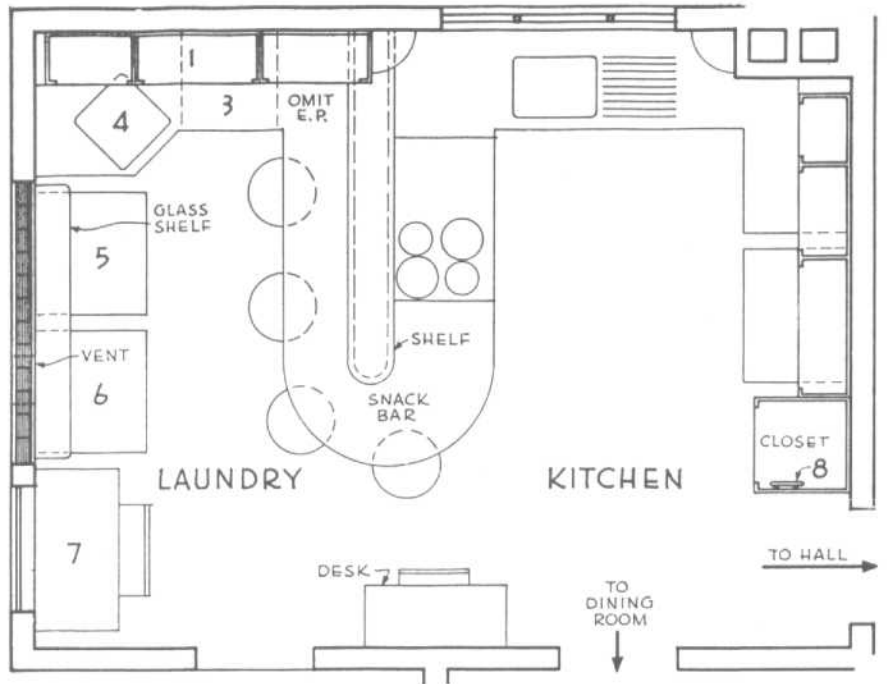
Laundry Room Layouts

Planning for Efficiency

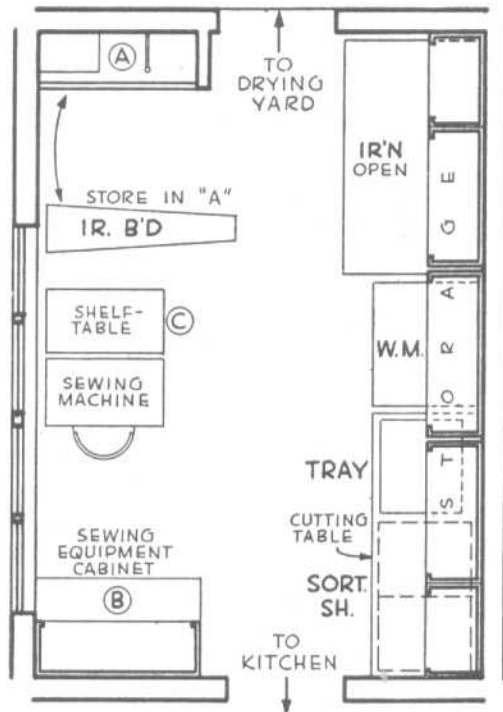
The sequence of laundering operations determines the planning of space and facilities and the placing of equipment. Convenience and time-and-step saving are easily achieved by placing the elements in their natural order of use: (1) clothes chute (with or without bins or hampers), (2) sorting table or counter, (3) washing machine, (4) laundry trays, (5) dryer, (6) ironer or mangle, (7) ironing board, (8) rack, "horse," or table for finished laundry. In addition, storage closet or cabinets will be necessary for soaps, powders, bluing, bleaches, starch, basket, clothespins, iron, etc.

KEY

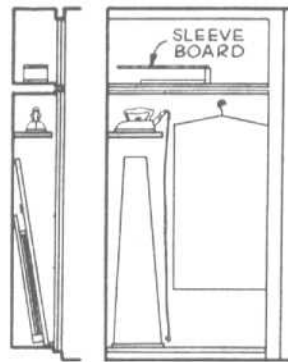
- 1. STORAGE CLOSET
- 2. CLOTHES CHUTE
- 3. SORTING SHELF
- 4. LAUNDRY TRAY
- 5. WASHING MACHINE
- 6. DRYER
- 7. IRONER
- 8. IRONING BOARD



KITCHEN AND LAUNDRY LAYOUT

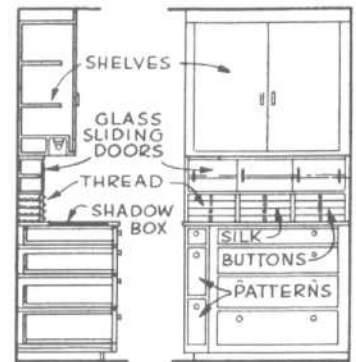


LAUNDRY-SEWING-MENDING



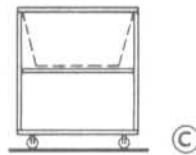
SEC. (A) ELEVATION

WASH BOARD MAY BE HUNG ON THE INSIDE OF ONE DOOR



SEC. (B) ELEVATION

WALL AND BASE CABINETS ARE STOCK TYPES WITH SHADOW BOX ADDED. IF SPECIALLY BUILT, CAN BE PORTABLE.



UNIT MAY CARRY CLOTHES BASKET IF TOP SHELF IS REMOVED.

KEY

- CLOS. STORAGE CLOSET
- CH. CLOTHES CHUTE
- SORT. SH. SORTING SHELF
- TRAY LAUNDRY TRAY
- W.M. WASHING MACHINE
- DRY. DRYER
- IR'N IRONER
- IR. B'D IRONING BOARD



## LAUNDRY/SEWING ROOMS

## Sewing Center Clearances

## General Planning Suggestions

1. An area especially planned for sewing, convenient to other activity areas, is desirable.

2. Most houses need storage space for sewing materials and equipment. The amount and kind of storage required varies according to the quality and frequency of sewing.

3. A minimum sewing area should include the machine, auxiliary work surfaces, a chair that permits freedom of motion, and storage arrangements. The work surface for layout and cutting may be outside the area for sewing machine operations and serve multiple purposes.

4. Consideration should be given to work surfaces at comfortable heights for the varying activities of sewing.

5. Light should be adequate for the activity.

TABLE 2 Dimensions of Area for Layout and Cutting Garments

Measurement	Dimensions, in	
	Minimum	Adequate
Working surface		
Length	56	72
Width		
Table, free-standing	28	36
Table obstructed on one side	28	32
Height	34-40 (range)	36 (median)
Clearance for worker	18	24

TABLE 3 Dimensions of Fitting Space

Use of Space	Minimum	Adequate
Viewing in mirror:		
Mirror dimensions, in		
Width	16	18
Length	42	60
Top to floor	70	72
Clearance in front of mirror, ft		
Width	3	4
Length	6-8	10
Clearance while fitting self, ft	6 x 4	
Clearance while being fitted, ft	8½ x 4	
Fitting garment on dress form, ft	5 x 4	7 x 6

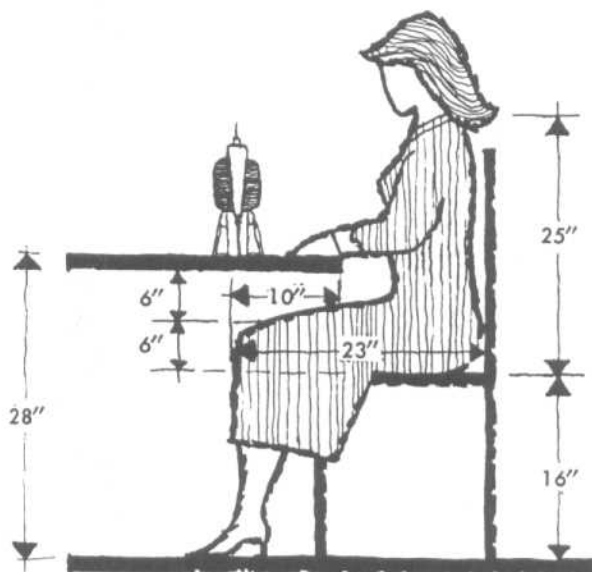


Fig. 13 Mean heights and clearances for sewing machine use.

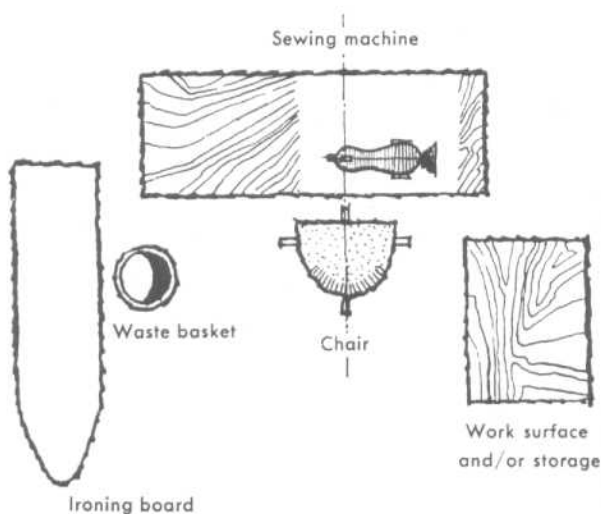


Fig. 14 Arrangement of sewing equipment based on flow of work.

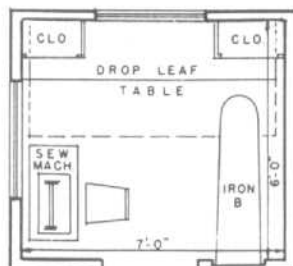


Fig. 15 Sewing room.

CLOSETS/STORAGE AREAS

Figures 1 and 2 show the vertical clearances related to male and female closet and storage facilities. Wherever possible or practical, the closet shelf should be located within human reach. The height shown for the high shelf has been established based on fifth percentile male and female data in order to place it within reach of individuals of smaller body size. Any shelf located at a greater distance should be used primarily for storage that requires only infrequent access. The location of the shelf just above the rod is essentially a function of rod height. The clearance between the bottom of the shelf and the top of the rod should allow for easy removal of the hanger.

Figure 3 illustrates two various types of walk-in storage facilities. Undoubtedly, it can be argued that the 36-in, or 91.4-cm, clearance shown between the hanging garment and the storage shelf or between opposite garments could be reduced about 50 percent. The authors contend, however, that in order to achieve any degree of comfort in the selection and removal of the desired garment, a minimum of 36 in should be maintained. The degree to which this dimension can be reduced is a question of the level of comfort the user is prepared to tolerate in exchange for the floor space saved. The two drawings of the plan view of the human figure illustrate clearances required for donning a coat or putting on a pair of stockings.

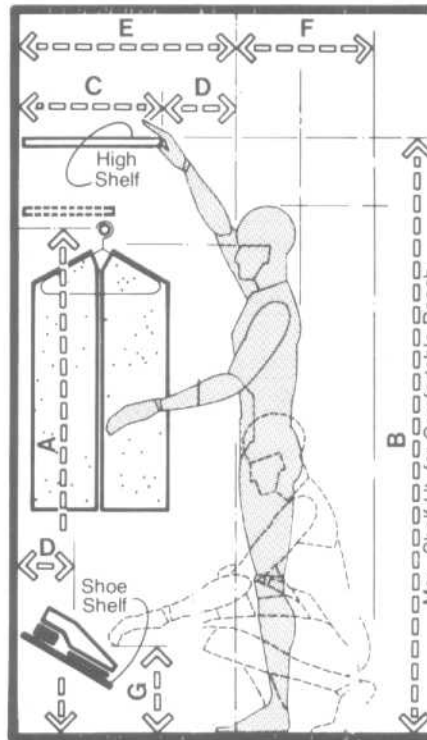


Fig. 1 Closet and storage facilities: male.

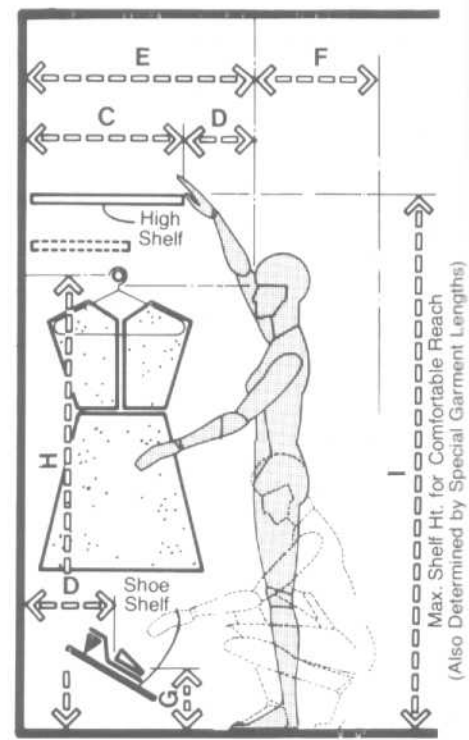


Fig. 2 Closet and storage facilities: female.

	in	cm
A	64-68	162.6-172.7
B	72-76	182.9-193.0
C	12-18	30.5-45.7
D	8-10	20.3-25.4
E	20-28	50.8-71.1
F	34-36	86.4-91.4
G	10-12	25.4-30.5
H	60-70	152.4-177.8
I	69-72	175.3-182.9
J	76	193.0
K	68	172.7
L	42	106.7
M	46	116.8
N	30	76.2
O	18	45.7

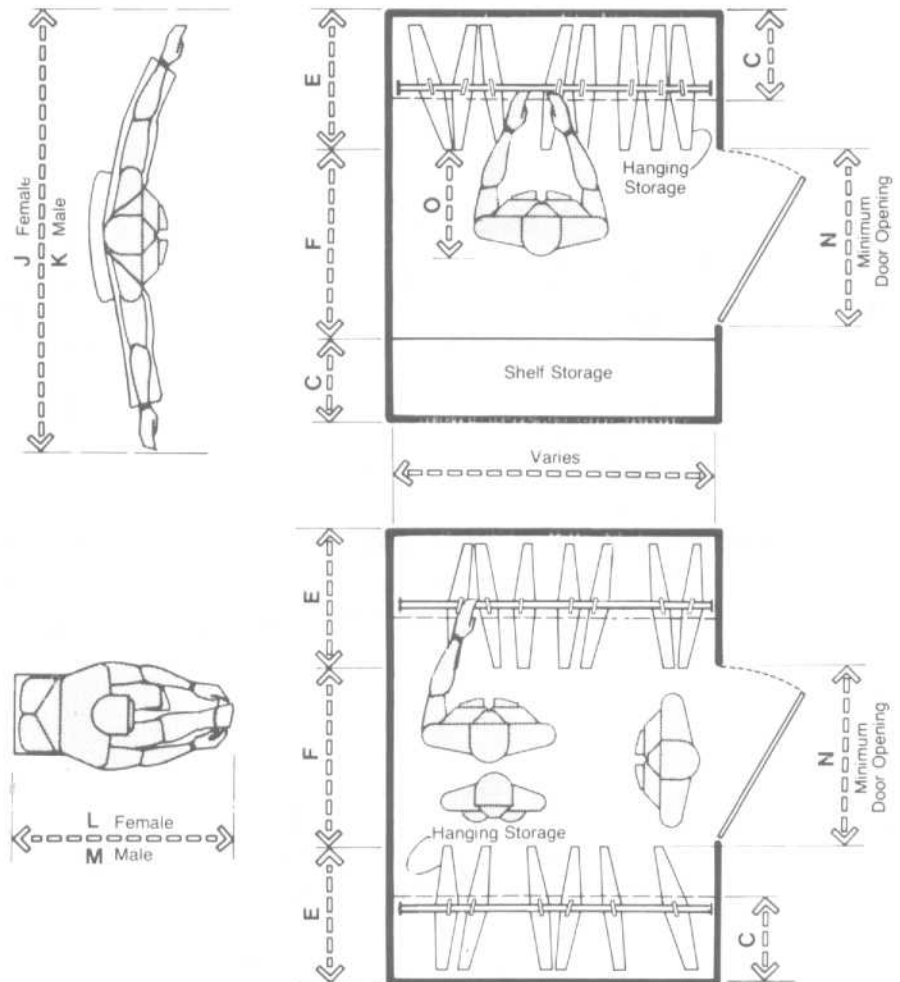


Fig. 3 Walk-in closet and storage facilities.

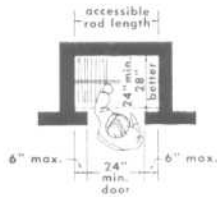
**CLOSETS/STORAGE AREAS**

Types of Closets

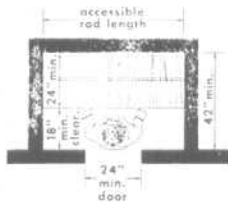
**CLOTHES CLOSETS**

The capacity of a clothes closet depends upon the accessible length of rod. Three types of closets are common.

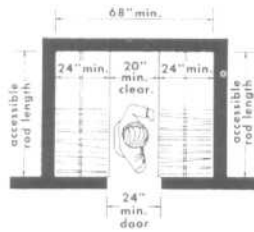
**Reach-in closet** The minimum front-to-back depth of space for hanging clothes is 24". The accessible rod length is equal to the width of the door opening plus 6" on each side.



**Edge-in closet** By providing an edge-in space of at least 18", the accessible rod length can be much longer than the door width. This requires less wall space than a full front opening.



**Walk-in closet** This type provides rods on one or both sides of an access path at least 20" wide. A wider access space within the closet may be used as a dressing area.



**Rod Lengths and Heights**

The Minimum Property Standards of HUD (1973) require that each bedroom have a closet, with rod and shelf, with minimum dimensions of

- For double-occupancy bedrooms: 24" by 60"
- For single-occupancy bedrooms: 24" by 36"
- For closet at entrance to house: 24" by 24"

A more desirable front-to-back depth would be 28" for bedroom closets and 30" for entrance closets to accommodate bulky outer garments.

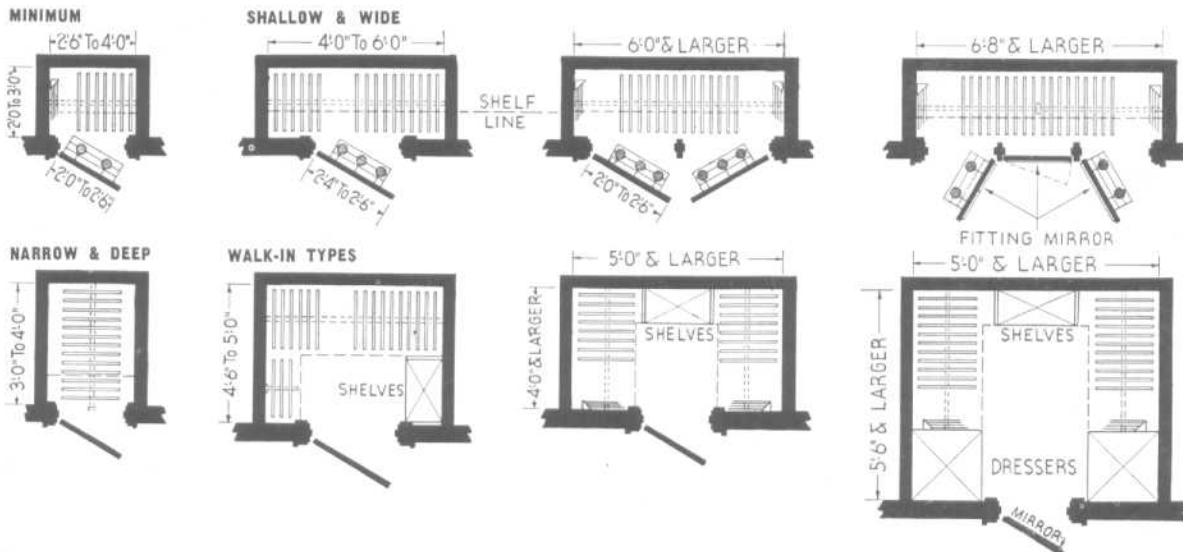
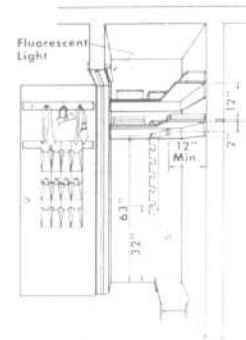
The average rod space per garment is about 2" for women's clothing, 2 1/4" for men's clothing, and 4" for heavy coats.

Recommended heights of rods are 68" for long robes, 63" for adult clothing, and 32" for children's clothing.

**Shelf Space and Lighting**

The shelf is normally located 2" above the rod, and another shelf may be located 12" higher. Shelves higher than the rod may also be installed at the end of the closet.

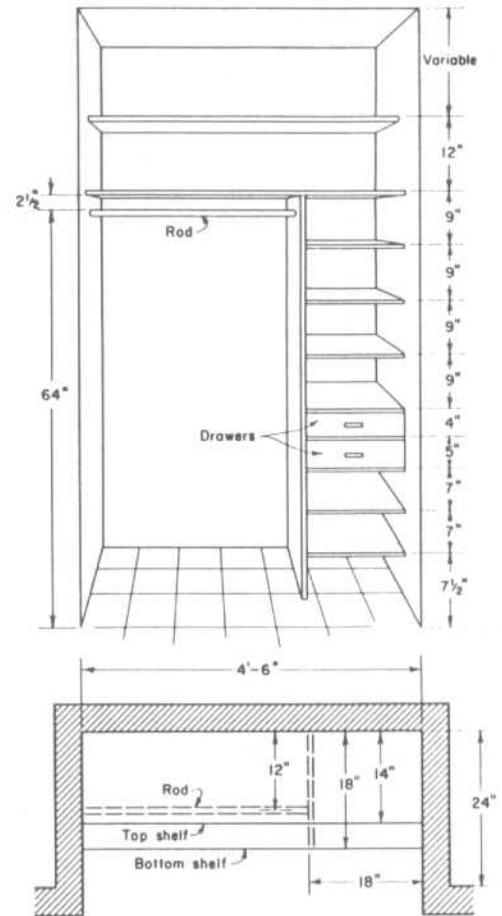
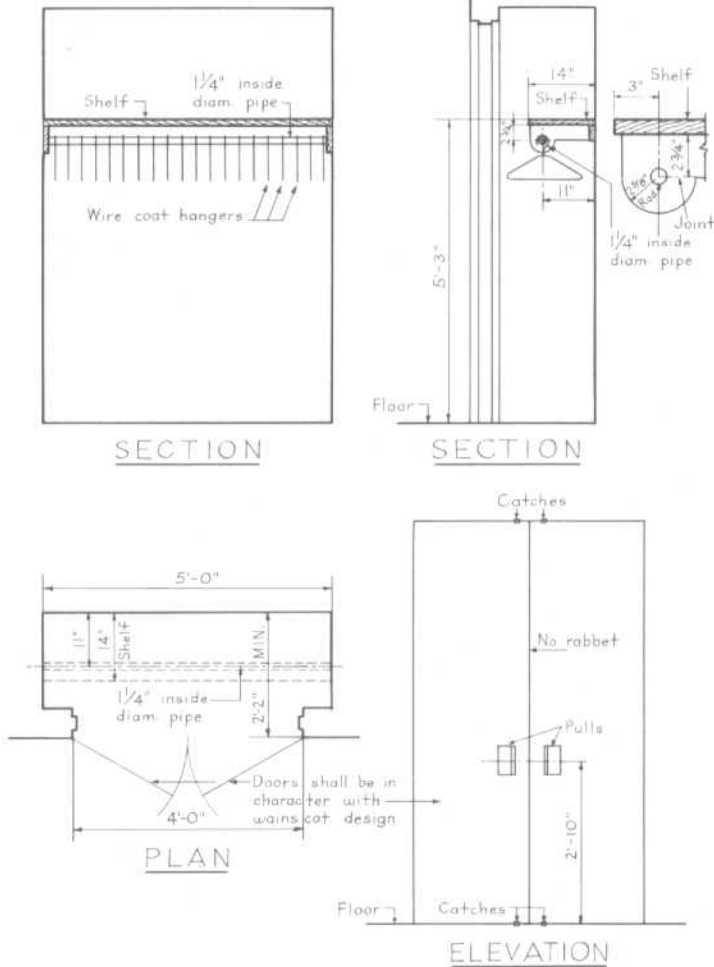
A fluorescent fixture over the door is recommended for lighting a closet. Delux cool white tubes match daylight for selecting clothes.



**CLOSETS/STORAGE AREAS**

**Clothes Closet Details**

Use when closet is 2'-2" or more.



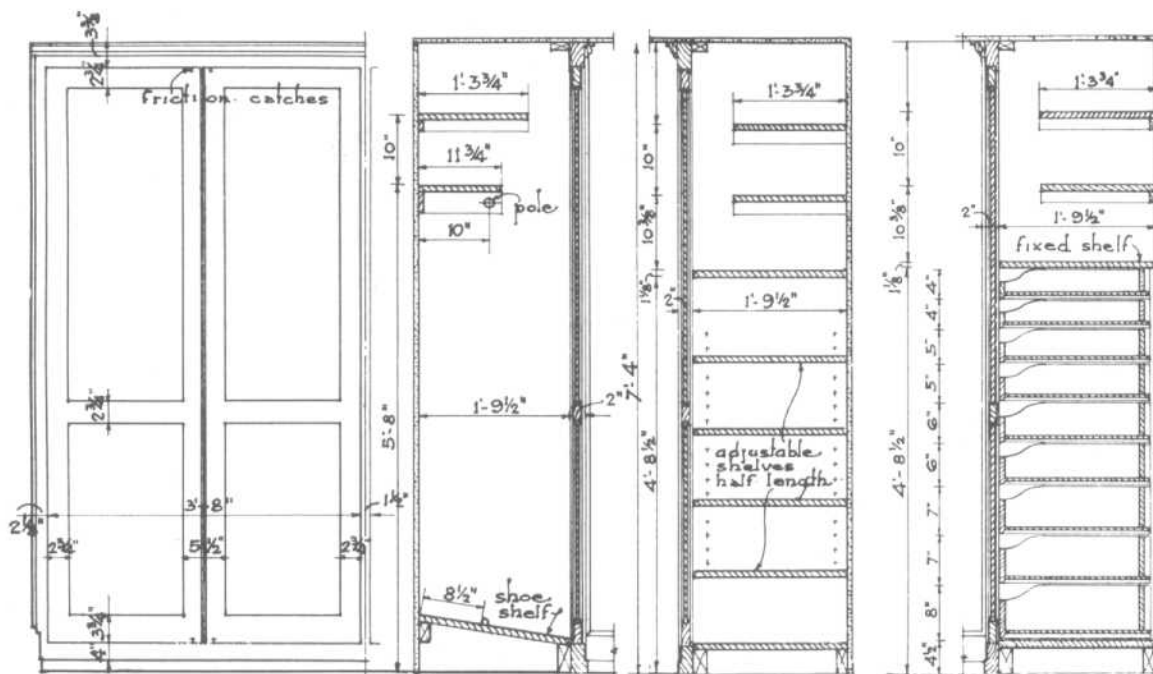
**Fig. 4 Bedroom closet designed for one person.** This diagram shows dimensions for rods, shelves, and drawers to hold underwear, sweaters, shoes, hats, purses, and ties. Research shows that each person needs at least 48 inches of rod space for hanging clothing.

**TABLE 1 Garment Dimensions**

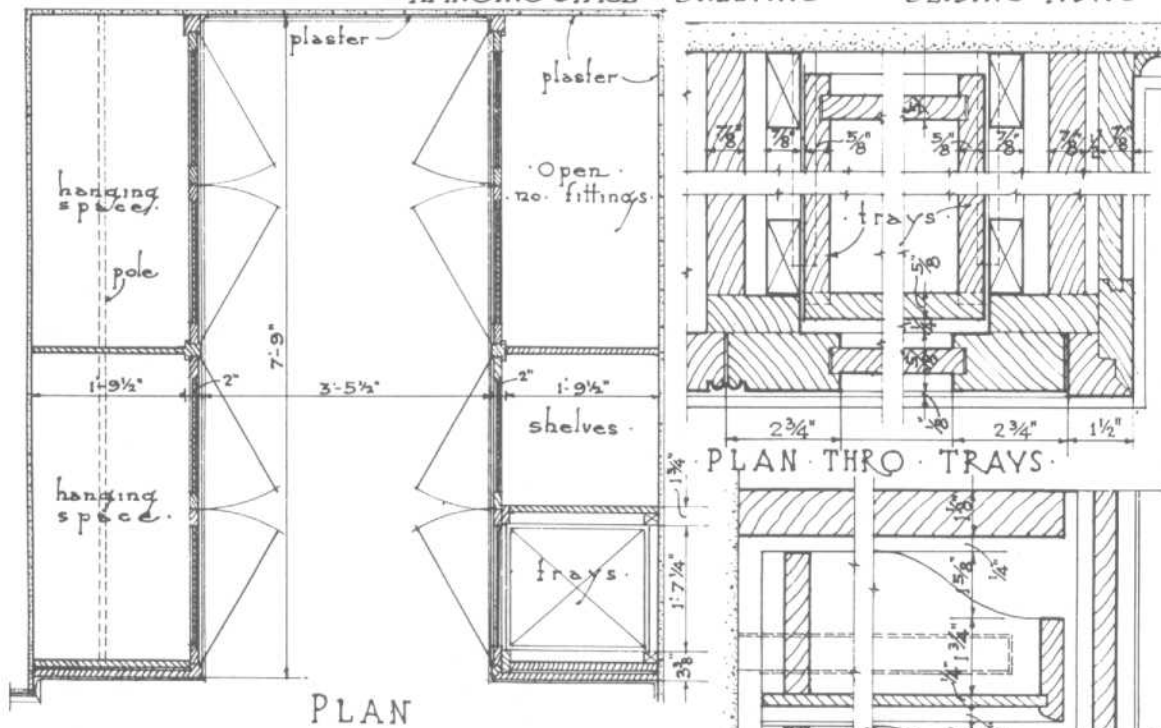
Men's garments	Allowance per garment, in	Women's garments	Allowance per garment, in
Heavy jackets and coats	3	Coats and jackets:	
Medium-weight jackets, coats, and raincoats	2	Heavy	3
Sweaters, light-weight jackets, and raincoats	1	Medium	2
Work pants:		Light	1
Folded on hanger	2 1/4	Sweaters	1 1/4
Hung full length	1 3/4	Other garments:	
Other garments:		Dress coats, winter	3 1/2
Top coats	2 1/2	Robes	2
Robes	2	Suits, wool (skirt under jacket)	2 1/2
Suits (trousers full length under jacket)	3	Skirts	1
Trousers	1 1/2	Jackets	2
Jackets	2	Blouses	1
Sweater jacket	1	House dresses	1 3/4
Shirts (all kinds)	1 1/2	Other dresses:	
		Average	2
		Full-skirted	2 1/2
		Straight-line	1 1/4
Men's garments	Range of lengths, in	Women's garments	Range of lengths, in
Suit jackets, other jackets, shirts	31-40	Blouses, jackets	25-35
Trousers:		Skirts, medium and short coats	31-43
Folded over hanger	29-37	Dresses, long coats, short robes	48-55
Full length	47-53	Long robes, long evening dresses	61-68
Overcoats, robes	48-54		

CLOSETS/STORAGE AREAS

Clothes Closet Details



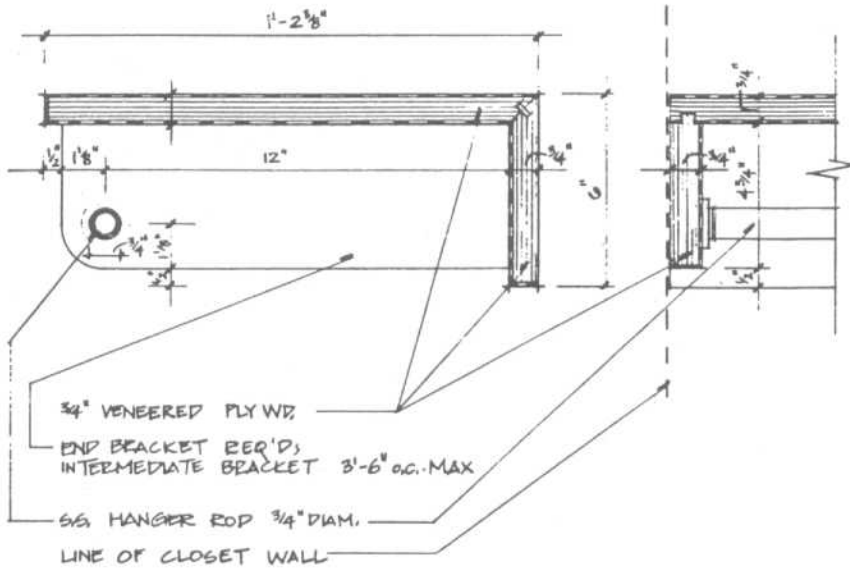
ELEVATION OF DOORS · SECTION THRO HANGING SPACE · SECTION THRO SHELVING · SECTION THRO SLIDING TRAYS



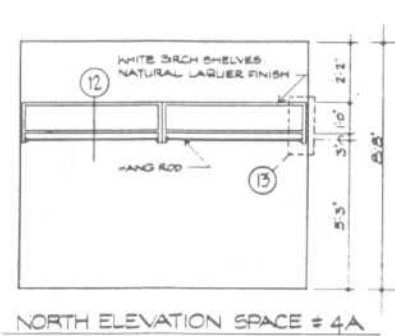
TYPICAL DETAILS OF A DRESSING ROOM WARDROBE

SECTION THRO TRAYS

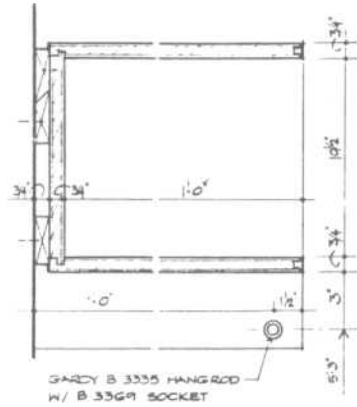




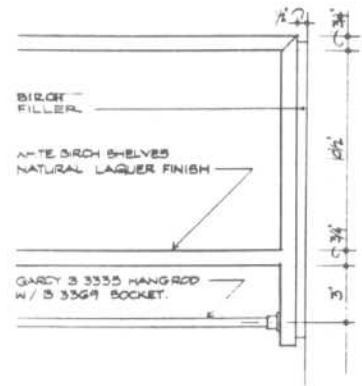
CLOSET SHELF DETAIL



11 SCALE  $\frac{3}{8}" = 1'-0"$



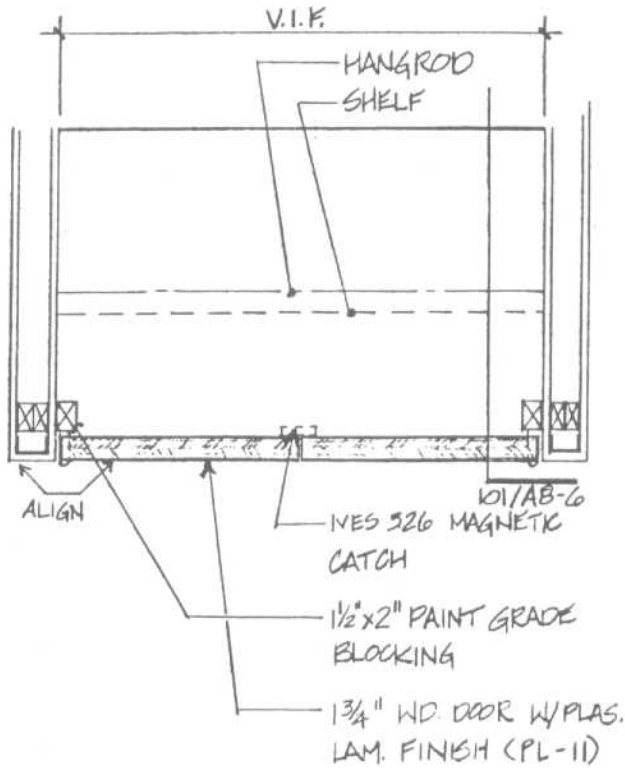
12 SCALE  $3" = 1'-0"$



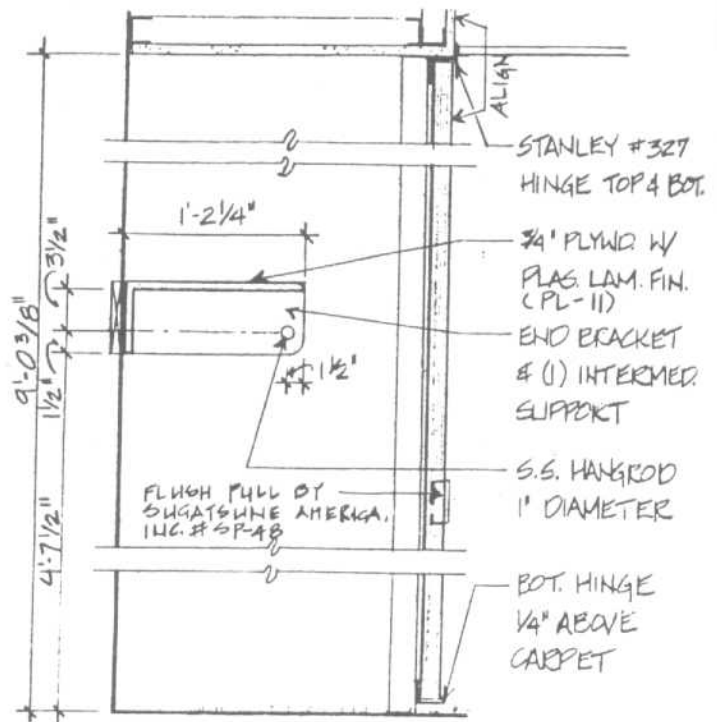
13 COAT & HAT SHELVES PART ELEVATION SCALE  $3" = 1'-0"$

CLOSETS/STORAGE AREAS

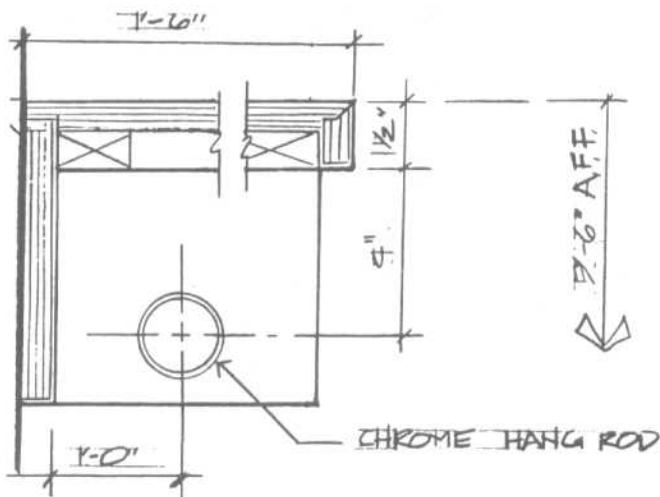
Clothes Closet Details



PLAN SECTION AT COAT CLOSET



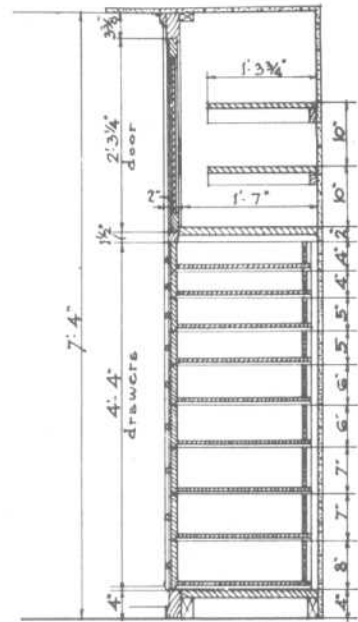
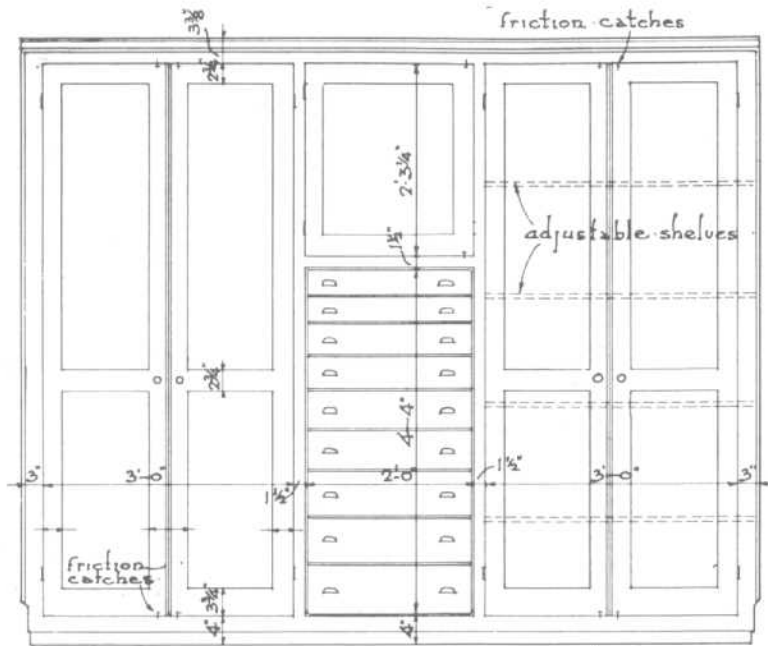
VERT. SECTION AT COAT CLOSET



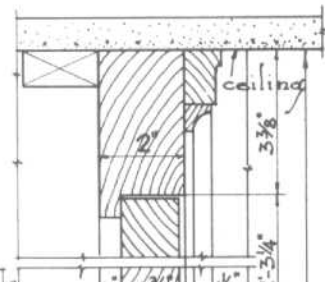
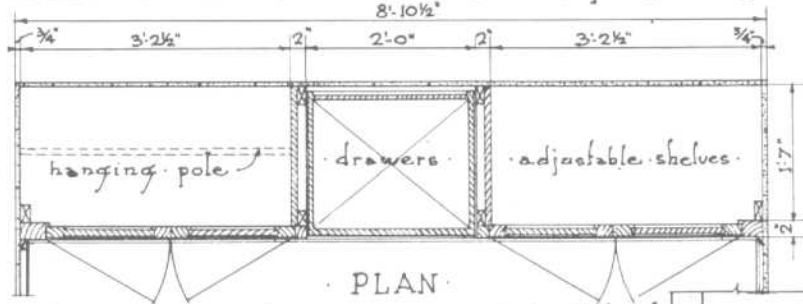
PROVIDE INTERMEDIATE SUPPORT FOR SPANS GREATER THAN 5'-0"

COAT CLOSET SHELF

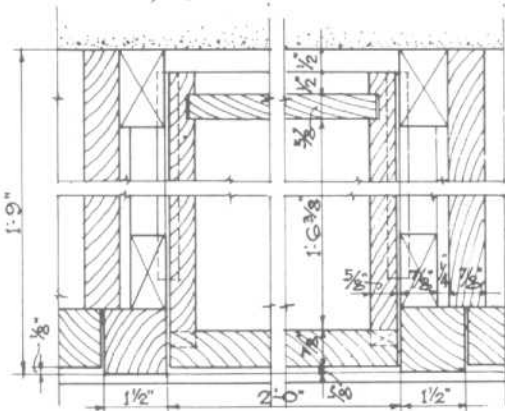




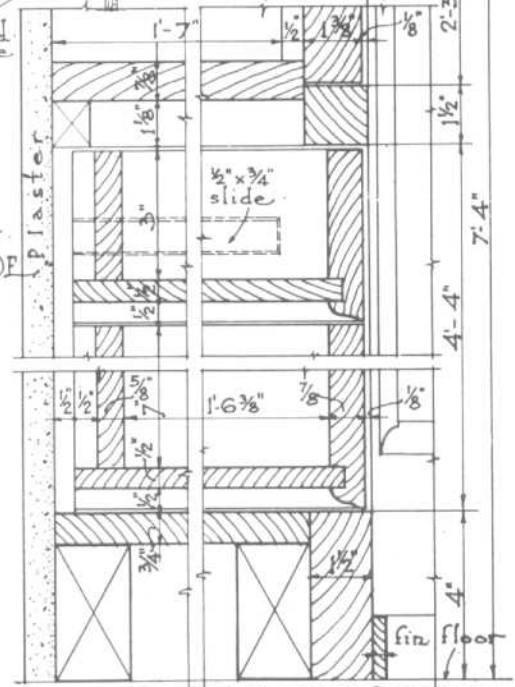
ELEVATION OF CLOSET DOORS & DRAWERS · SECTION THRO DRAWERS



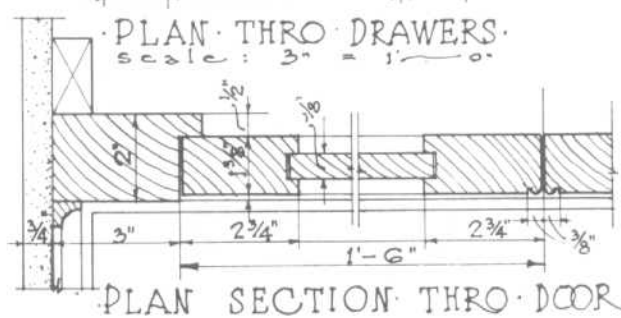
PLAN



SECTION THRO SLIDE



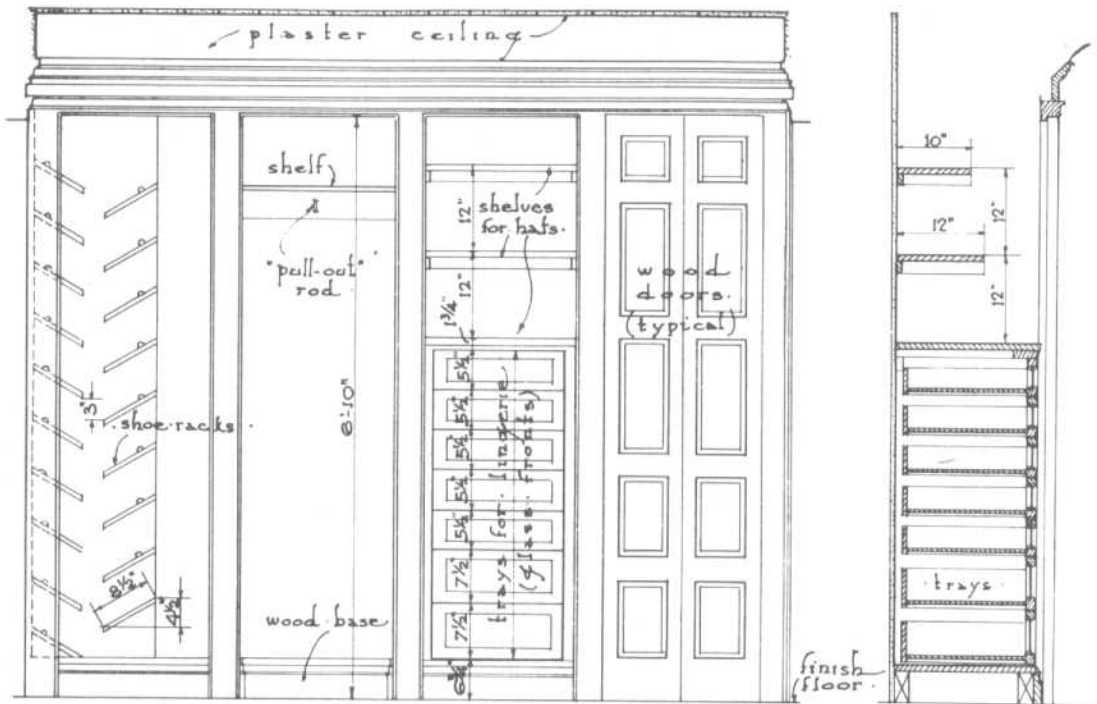
SECTION THRO DRAWERS



PLAN SECTION THRO DOOR

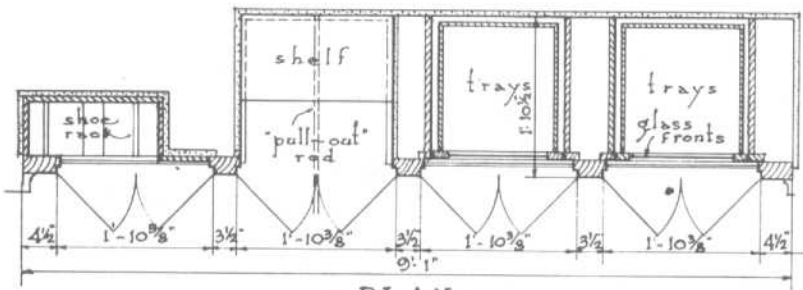
CLOSETS/STORAGE AREAS

Closet Wall Details

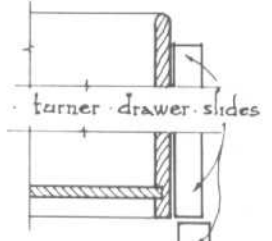


ELEVATION OF CLOSETS (DOORS REMOVED)

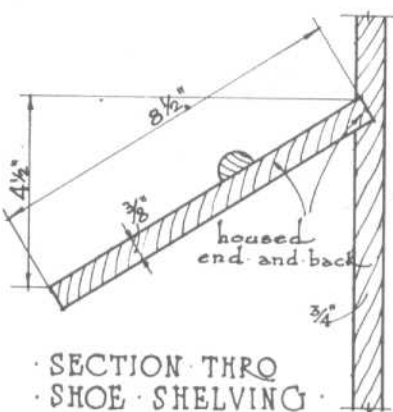
SECTION THRO TRAYS



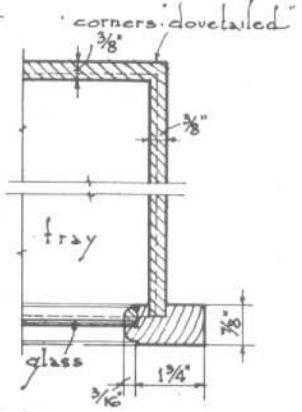
PLAN



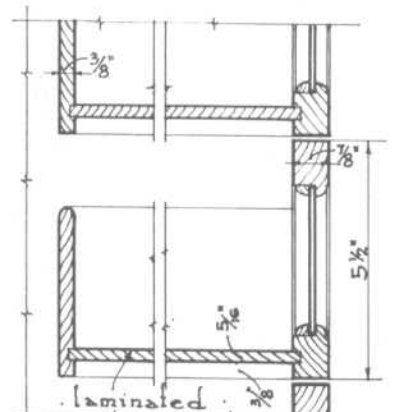
SECTION THRO SIDE OF TRAY



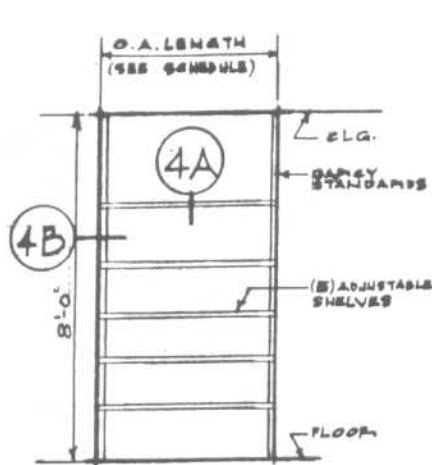
SECTION THRO SHOE SHELVING



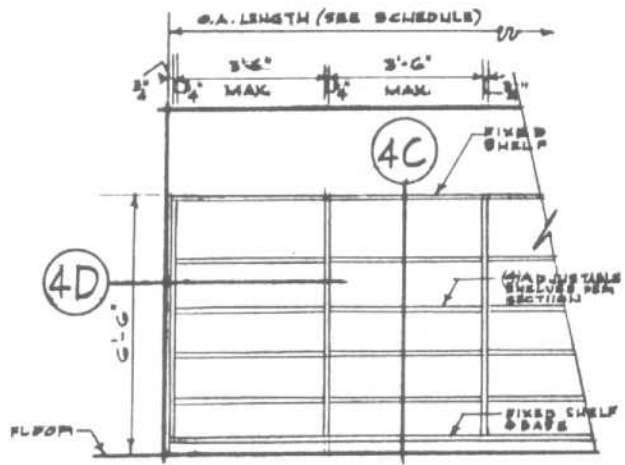
PLAN SECTION THRO TRAYS



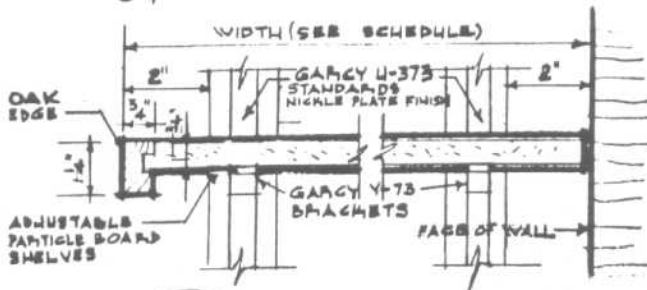
VERTICAL SECTION THRO TRAYS



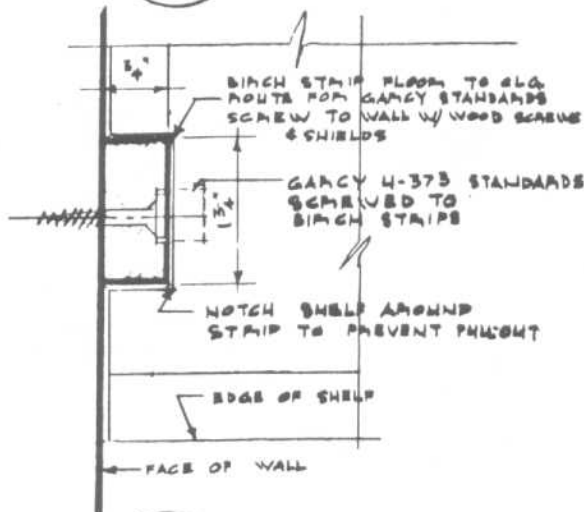
ELEVATION OF STORAGE CLOSETS 4'-0" OR LESS IN LENGTH  
 @ 1/4" = 1'-0"



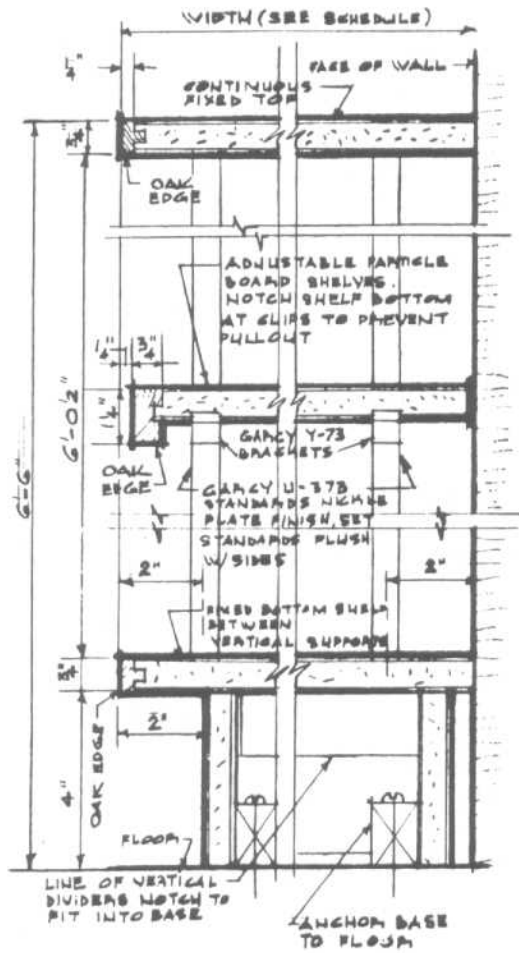
ELEVATION OF STORAGE CLOSETS OVER 4'-0" IN LENGTH  
 @ 1/4" = 1'-0"



4A @ 3" = 1'-0"



4B @ 1/2 FULL SIZE

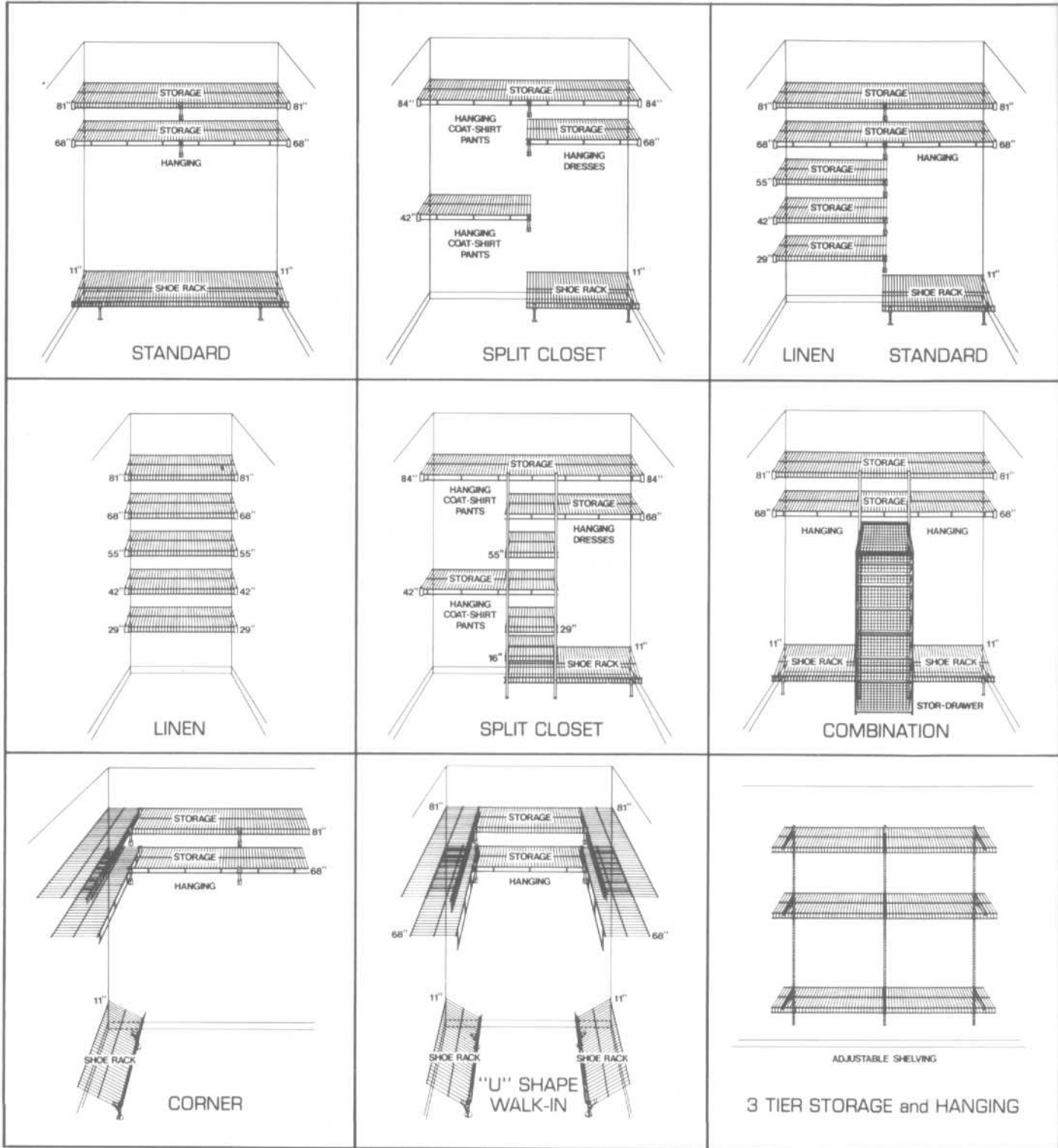


4C @ 3" = 1'-0"

4 STORAGE CLOSET SHELVING DETAILS

CLOSETS/STORAGE AREAS

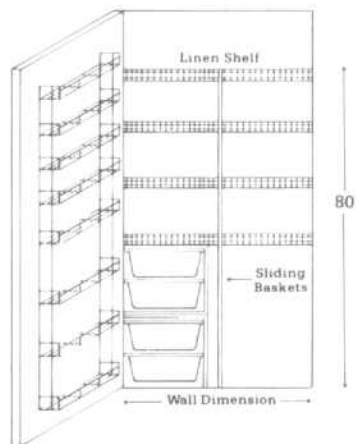
Wire Basket and Shelving Systems



CLOSETS/STORAGE AREAS

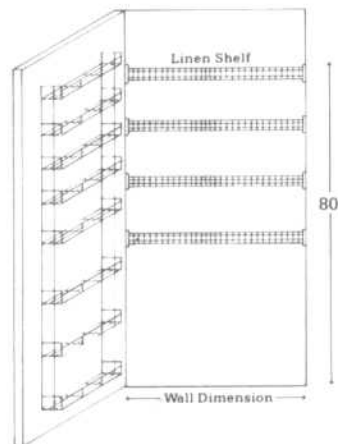
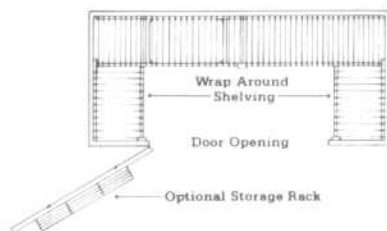
Wire Basket and Shelving Systems

PANTRY



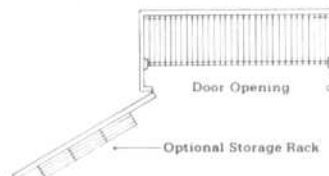
**Front View**  
Multiple-stacked, wrap-around storage shelving. Optional baskets and door racks. (9', 12', 16' and 20' widths available)

**Top View**  
All the shelving you'll ever need for full-size family food storage. Sliding baskets hold fruit, vegetables and other kitchen supplies. Optional door racks maximize storage area by utilizing all available space.

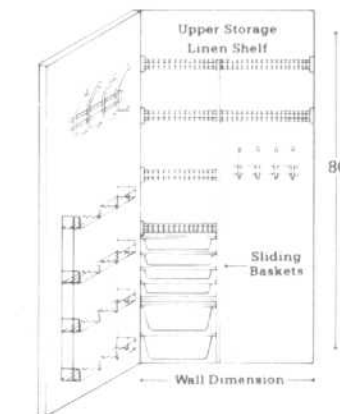


**Front View**  
Multiple-stacked storage shelving. Optional full-height door storage rack. (9', 12', 16' and 20' widths available)

**Top View**  
Standard pantry design provides ample shelving and storage for canned goods and other food items. Center pole gives extra support. Optional door racks provide easy access to your most needed items.

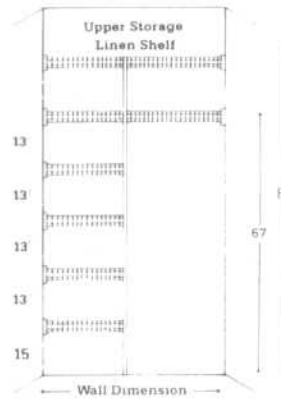
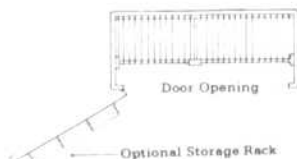


HOUSEKEEPING/UTILITY ROOM



**Front View**  
Double, full-width upper storage shelving with stacked storage shelving. (12', 16' widths available)

**Top View**  
Makes housework easier to handle by storing household cleaning items just where you need them. Plenty of shelving space for cloths, detergents and brushes. Wide storage area holds vacuum cleaner, brooms, mops and small appliances.



**Front View**  
Double, full-width storage shelving with side-mounted shelving and basket unit and optional door/wall storage rack. (12', 16' widths available)

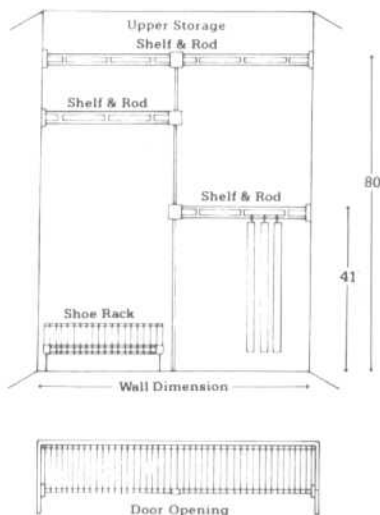
**Top View**  
Make a clean sweep of cleaning with full-length shelves that hold a variety of utensils. Storage baskets pack brushes, cloths and sundry items. Bottled detergents and cleaning products can be stored neatly and safely in optional door racks.



**CLOSETS/STORAGE AREAS**

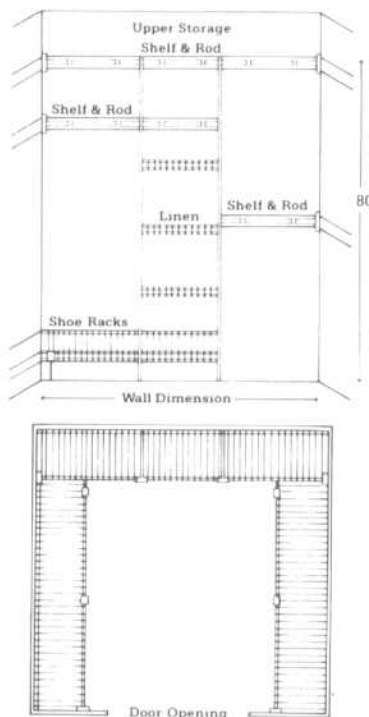
Wire Basket and Shelving Systems

**BEDROOM APPLICATIONS**



**Front View**  
Single and double hang with upper storage, center pole support and shoe racks. (12", 16" widths available)

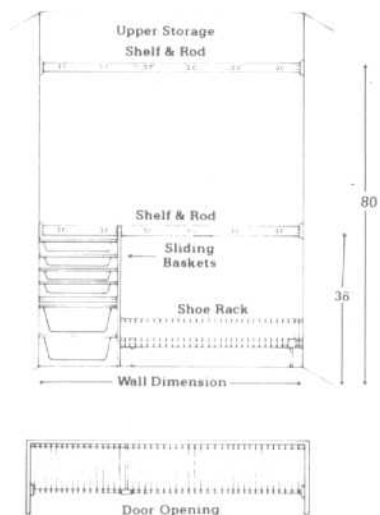
**Top View**  
Combination convenience for single and double hanging clothes. The perfect his and hers closet. Extra wide shelf space for clothing, linen and blankets in your master bedroom. Plus lots of room for her long dresses and coats — his shirts, suits and slacks. Shoe racks on both sides.



**Front View**  
Walk-In. Single and double hang with upper storage and central shelving unit with additional clearance and shoe racks. (12", 16" widths available)

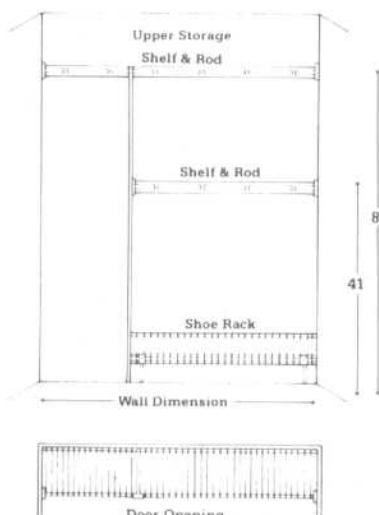
**Top View**  
Single hanging space for coats and other long garments. Double hanging convenience for shorter garments. Full shelves with central storage unit allow easy storage of sweaters, boots, sports equipment, tall and over-sized items. Tailor-made for couples with a 2nd bedroom.

**CHILDREN'S CLOSETS**



**Front View**  
Full-width, double hanging with lower shelving height. Sliding basket system and shoe racks. (12", 16" widths available)

**Top View**  
Specially designed for the children's room. Extra low-hanging shelf makes it easy for kids to reach. Stores toys and sports equipment in easy-access sliding baskets. Shoe rack keeps sneakers and other footwear neatly organized.



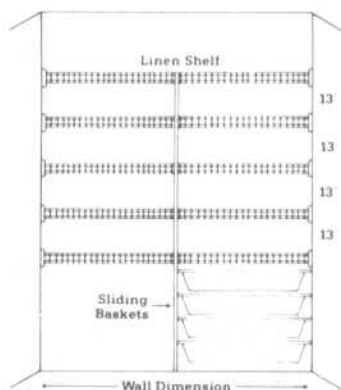
**Front View**  
Standard. Double hang with shoe rack and off-center pole support. (12", 16" widths available)

**Top View**  
Makes kids stuff out of chaos in any teenager's room. Plenty of storage space for footballs, beach equipment, basketballs, skates and other cumbersome items. Doubles as storage area for dresses and coats. Conveniently placed hanging rod for all your teenager's clothing.

**CLOSETS/STORAGE AREAS**

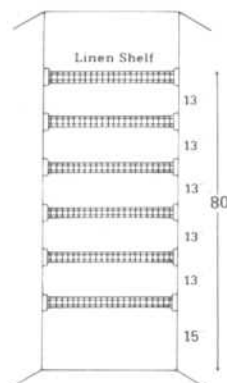
Wire Basket and Shelving Systems

**LINEN**



**Front View**  
Multiple-stacked linen shelving with pole support and sliding basket system. (9", 12", 16" and 20" widths available)

**Top View**  
Four extra-wide shelves for linen and blankets. Storage baskets slide out and hold dish cloths, pillowcases and smaller items. The perfect linen closet.



**Front View**  
Multiple-stacked linen shelving. (9", 12", 16" and 20" widths available)

**Top View**  
Bathroom linen closet stores towels, sheets and cleaning supplies in one easy-access area.

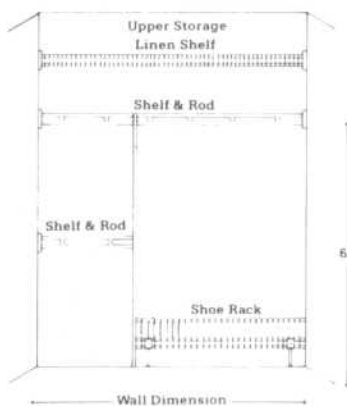


Door Opening



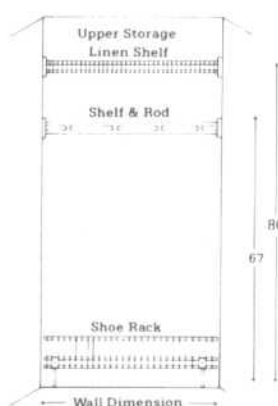
Door Opening

**FOYER/FRONT ENTRY CLOSET**



**Front View**  
Single hang with upper storage and off-center storage unit and shoe racks. (12", 16" widths available)

**Top View**  
A welcome addition to any home. Full-width, upper storage holds hats, gloves and sweaters. Off-center storage for umbrellas and winter items. Shelves, shoe racks and generous hanging space lets guests know they're welcome.



**Front View**  
Single hang with half-length shoe racks and upper storage. (12", 16" widths available)

**Top View**  
Holds coats, hats, shoes and guest clothing with care. Upper storage area for visitor's bags and small cases.



Door Opening

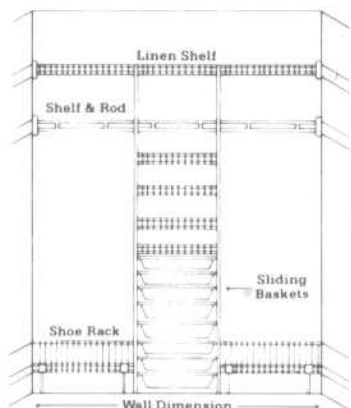


Door Opening

CLOSETS/STORAGE AREAS

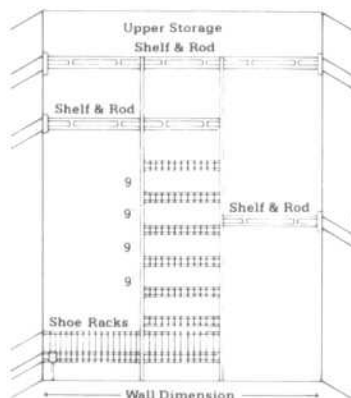
Wire Basket and Shelving Systems

MASTER BEDROOMS



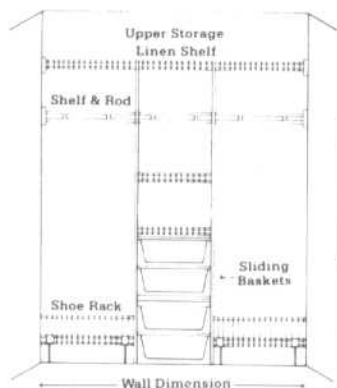
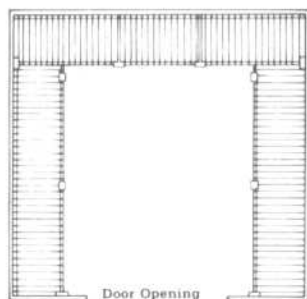
**Front View**  
Walk-In. Single hang with upper storage and central shelving/basket unit and shoe racks. (12", 16" widths available)

**Top View**  
Keeps shoes, shirts and clothing neatly organized. Sliding baskets for easy access to linen, underwear, etc. Full-length clothes storage for dresses, shirts and suits. Ideal for master bedroom.



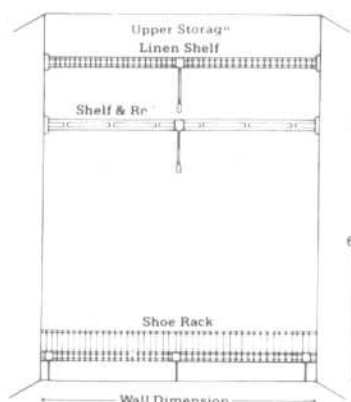
**Front View**  
Walk-In. Single and double hang with upper storage, central shelving and shoe racks. (12", 16" widths available)

**Top View**  
Hang dresses and coats on one side, suits and shorter garments on the other. Central shelving actually replaces a piece of furniture in the master bedroom!



**Front View**  
Single hang with upper storage and central shelving and basket unit, additional clearance and shoe racks. (12", 16" widths available)

**Top View**  
So well designed it actually replaces a piece of furniture! Four sliding baskets provide multiple storage capacity for shirts, underwear, socks and sweaters. Full-length clothes hanging space, full-width shoe racks and lots of shelf space make this system a must for your 2nd bedroom.



**Front View**  
Single hang with upper storage and full-width shoe racks. (12", 16" widths available)

**Top View**  
Doubles shelf/storage space. Single hanging for clothes, coats, shirts and jackets. Expands easily to accommodate future needs. Two full-length shoe racks.





# Office Spaces

General offices and multiple workstations	223
Private offices	231
Electronic workstations	241
Conference rooms	249
Reception areas	260
Furniture, furnishings, and equipment	278

## INTRODUCTION

The amount of office space built during the past few decades can be measured in the hundreds of billions of square feet. Within these buildings, workers spend nearly half their waking hours and a third of their entire lives.

Over the life span of a typical office building, the same spaces may be occupied by a succession of different tenants, each with their own programmatic requirements. Consequently, interior spaces may be recycled and redesigned many times, simply to accommodate the changing needs of new corporate users. In many instances redesign may be necessitated solely by the effect of technological change on the methodology of transacting business. Moreover, the escalating costs of land acquisition and construction and the increasing scarcity of urban building sites make it essential that the redesign reflects an efficient, cost-effective utilization of space, as well as one that is responsive to the human factors involved. It is necessary, therefore, for the designer to be familiar not only with the general planning criteria associated with office design, but with the architectural detailing of some of the typical interior elements contained within these spaces.

Accordingly, this section includes general planning criteria and examples of actual working drawings of typical interior conditions, prepared by various design professionals. The details alluded to include such items as trading desks, elevated computer floors, library furniture, built-in storage cabinets, work counters, wall paneling, vanities, reception desks, and conference room elements. Also included are illustrations and dimensional data pertaining to typical office furniture, equipment, and electronic media storage.

## GENERAL OFFICES AND MULTIPLE WORKSTATIONS

Planning Data: Basic Workstations

The so-called general office takes on a variety of forms and configurations. In its simplest variation it may be nothing more complex than several standard desks with returns located within a room or space. In its more sophisticated and ergonomically designed form, the general office may be based on an open planning or office landscaping concept, involving a system of workstations. The workstations include desk surfaces, files, acoustic partitions, and a host of other optional components to suit the nature of the particular work tasks involved. The systems are extremely flexible, allowing the workstations to be configured in a variety of shapes. Provision for power and lighting is quite common.

The design of the general office, like the design of the private office, requires a knowledge of the basic dimensional requirements and clearances of the workstation and, where applicable, of the visitor seating to be accommodated.

In certain instances, where customized and/or built-in storage elements, work coun-

ters, credenzas, etc., are required, a knowledge of architectural woodworking, as may be related to the design of such elements, can be quite helpful.

Accordingly, this part includes basic planning criteria for general office design, in addition to examples of architectural woodwork details in connection with some of the more common customized components of general office spaces.

The basic workstation, as illustrated in plan in Fig. 1, is the fundamental building block in understanding the anthropometric considerations for the planning and design of the general office. The worktask zone must be large enough to accommodate the paperwork, equipment, and other accessories that support the user's function. The work/activity zone dimension, shown in Fig. 1, is established by the space requirements needed for use of the typical return. In no case should this distance be less than the 30 in., or 76.2 cm, needed to provide adequate space for the chair clearance zone. The visitor seating zone, ranging in depth from 30 to 42 in., or

76.2 to 106.7 cm, requires the designer to accommodate both the buttock-knee and buttock-toe length body dimensions of the larger user. If an overhang is provided or the desk's modesty panel is recessed, the visitor seating zone can be reduced due to the additional knee and toe clearances provided. The specific type and size of the seating (i.e., if it swivels or if it has casters) also influence these dimensions.

Figure 2 shows the typical workstation expanded into the basic U-shaped configuration. The work/activity zone dimension range is shown as 46 to 58 in., or 116.8 to 147.3 cm; additional space is needed to allow for drawer extension of the lateral file. Not only does it provide more storage, the lateral file unit is generally the same height as that of the worksurface and is often utilized as a supplementary worksurface. The distance between this unit and that of the primary worksurface must be sufficient to allow for movement and rotation of the chair.

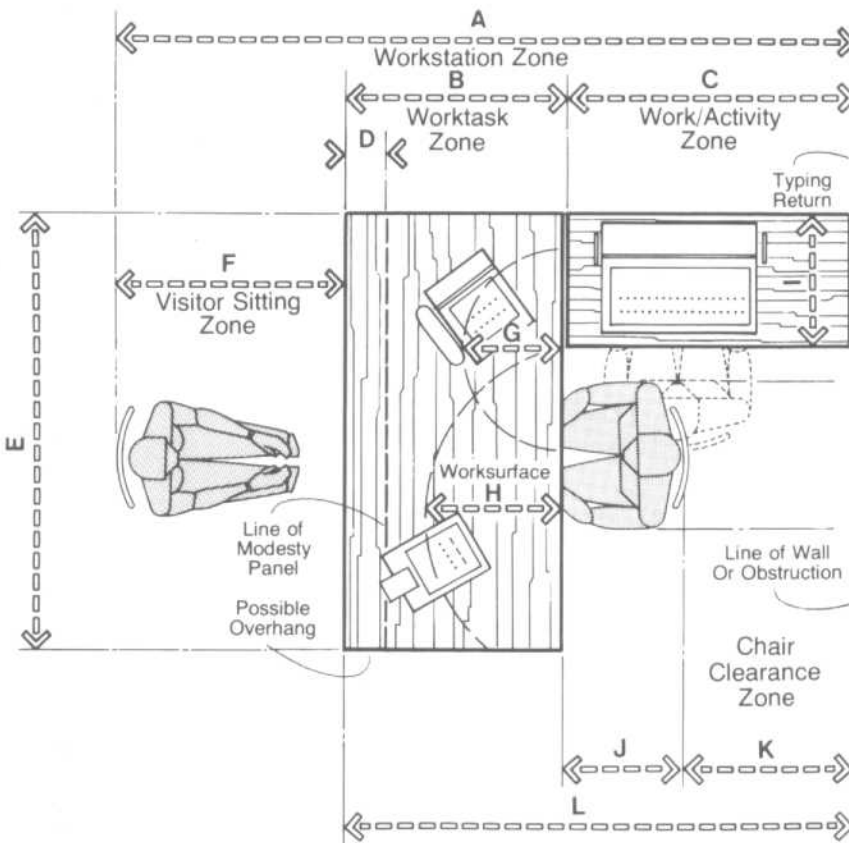
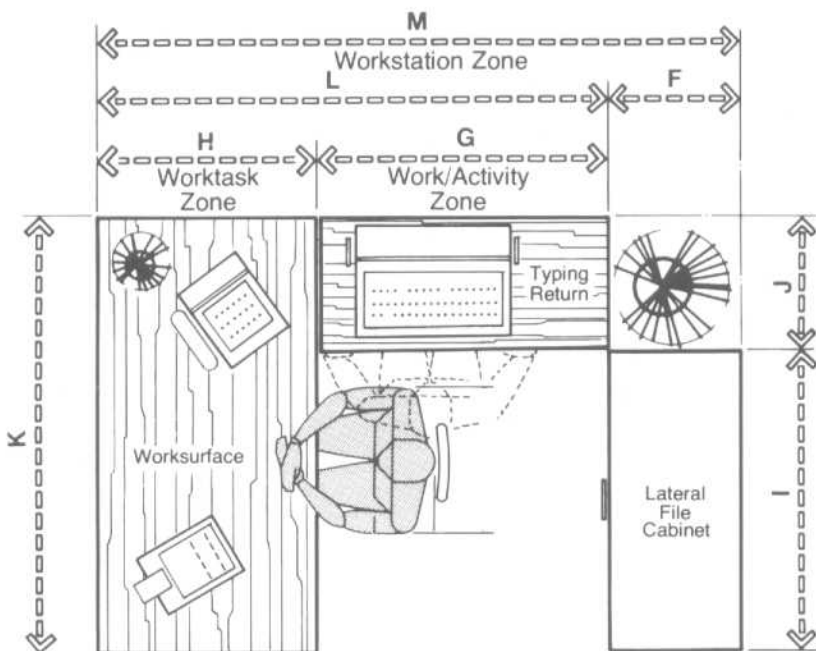


Fig. 1 Basic workstation with visitor seating.

	in	cm
A	90-126	228.6-320.0
B	30-36	76.2-91.4
C	30-48	76.2-121.9
D	6-12	15.2-30.5
E	60-72	152.4-182.9
F	30-42	76.2-106.7
G	14-18	35.6-45.7
H	16-20	40.6-50.8
I	18-22	45.7-55.9
J	18-24	45.7-61.0
K	6-24	15.2-61.0
L	60-84	152.4-213.4
M	24-30	61.0-76.2
N	29-30	73.7-76.2
O	15-18	38.1-45.7

GENERAL OFFICES AND MULTIPLE WORKSTATIONS

Planning Data: Basic Workstations



	in	cm
<b>A</b>	26-27	66.0-68.6
<b>B</b>	14-20	35.6-50.8
<b>C</b>	7.5 min.	19.1 min
<b>D</b>	29-30	73.7-76.2
<b>E</b>	7 min.	17.8 min.
<b>F</b>	18-24	45.7-61.0
<b>G</b>	46-58	116.8-147.3
<b>H</b>	30-36	76.2-91.4
<b>I</b>	42-50	106.7-127.0
<b>J</b>	18-22	45.7-55.9
<b>K</b>	60-72	152.4-182.9
<b>L</b>	76-94	193.0-238.8
<b>M</b>	94-118	238.8-299.7

Fig. 2 Basic U-shaped workstation.

## GENERAL OFFICES AND MULTIPLE WORKSTATIONS

Planning Data: Basic Workstations

## Minimum Square Footage Standards for the Open and Screened Workstation

**The Nonautomated Task.** Square footage workstation standards for the nonautomated task are developed primarily according to task profile, equipment, conferencing, and privacy requirements.

**Open**

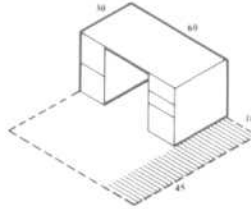
No requirement of equipment or task for privacy, concentration

**Screened**

Privacy required for reading, working, thinking, calculating, meetings, confidential phone calls, elimination of visual and acoustical distractions

**Task Profile:** Processing paper on work surface with quick turnaround.

- Continued flow of material is processed as it arrives at the workspace and is passed on to either another function or to group storage.
- Storage for permanent files and reference materials minimal.
- Reference material accessed infrequently. Telephone tasks may require concentration.



No  
30 x 60  
(76 x 152 cm)  
No  
3-4  
0-2

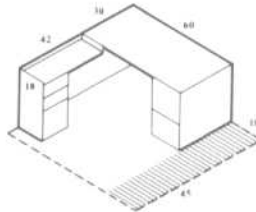
Guest chair  
Primary work surface

Secondary work surface  
File drawers  
Shelves

41 sq. ft.

**Task Profile:** Typewriter the primary tool for processing paper.

- Continued flow of material is processed as it arrives at the workspace and is passed on to either another function or to group storage.
- Storage for permanent files and reference materials minimal.
- Reference material access may be frequent. Tasks may require concentration.



No  
30 x 60  
18 x 42  
(46 x 107 cm)  
3-4  
0-2

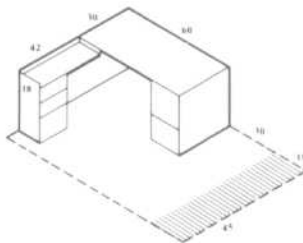
Guest chair  
Primary work surface  
Secondary work surface

File drawers  
Shelves

41 sq. ft.

**Task Profile:** Typewriter the primary tool for processing paper.

- Continued flow of material is processed as it arrives at the workspace and is passed on to either another function or to group storage.
- Storage for permanent files and reference materials minimal.
- Reference material access may be frequent. Tasks may require concentration. Limited conferencing required at the workspace.
- Need to see and hear co-workers or subordinates of secondary priority.



1  
30 x 60  
18 x 42  
3-4  
0-2

Guest chair  
Primary work surface  
Secondary work surface  
File drawers  
Shelves

56 sq. ft.

## GENERAL OFFICES AND MULTIPLE WORKSTATIONS

Planning Data: Basic Workstations

## The Nonautomated Task

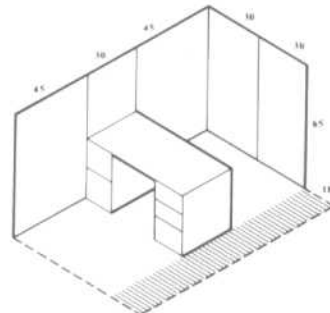
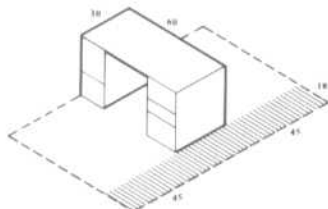
## Open

No requirement of equipment or task for privacy, concentration

## Screened

Privacy required for reading, working, thinking, calculating, meetings, confidential phone calls, elimination of visual and acoustical distractions

**Task Profile:** Same as 1 with addition of extended conferencing requirements at individual workstation.

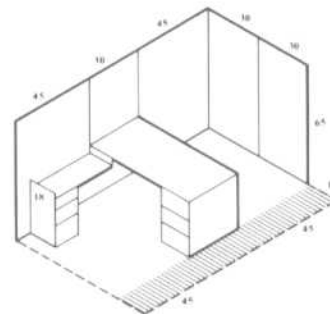
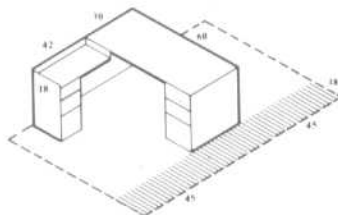


2  
30 x 60  
No  
3-4  
No

Guest chair  
Primary work surface  
Secondary work surface  
File drawers  
Shelves

65 sq. ft.

**Task Profile:** Same as 3 with addition of extended conferencing requirements at individual workstation.



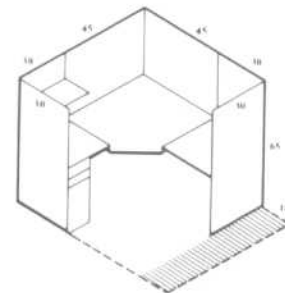
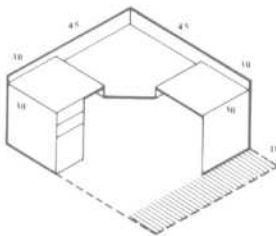
2  
30 x 60  
18 x 42  
3-4  
No

Guest chair  
Primary work surface  
Secondary work surface  
File drawers  
Shelves

65 sq. ft.

**Task Profile: Data Entry.**

- Paper, material, or information processed and/or maintained.
- Multiple reference sources may be used on a task.
- Reference materials used frequently.
- Limited volume of supplies and permanent records kept at the workspace.
- Electronic equipment used for keeping records current, information inputting, and maintaining data and records.
- Ability to see and hear co-workers may be desirable.
- Tasks may also require screening for concentration.



No  
45 x 45  
(114 x 114 cm)  
30 x 30  
(76 x 76 cm)  
1-2  
0-2

Guest chair  
Primary work surface  
Secondary work surface  
File drawers  
Shelves

48 sq. ft.

## GENERAL OFFICES AND MULTIPLE WORKSTATIONS

Planning Data: Multiple Workstations

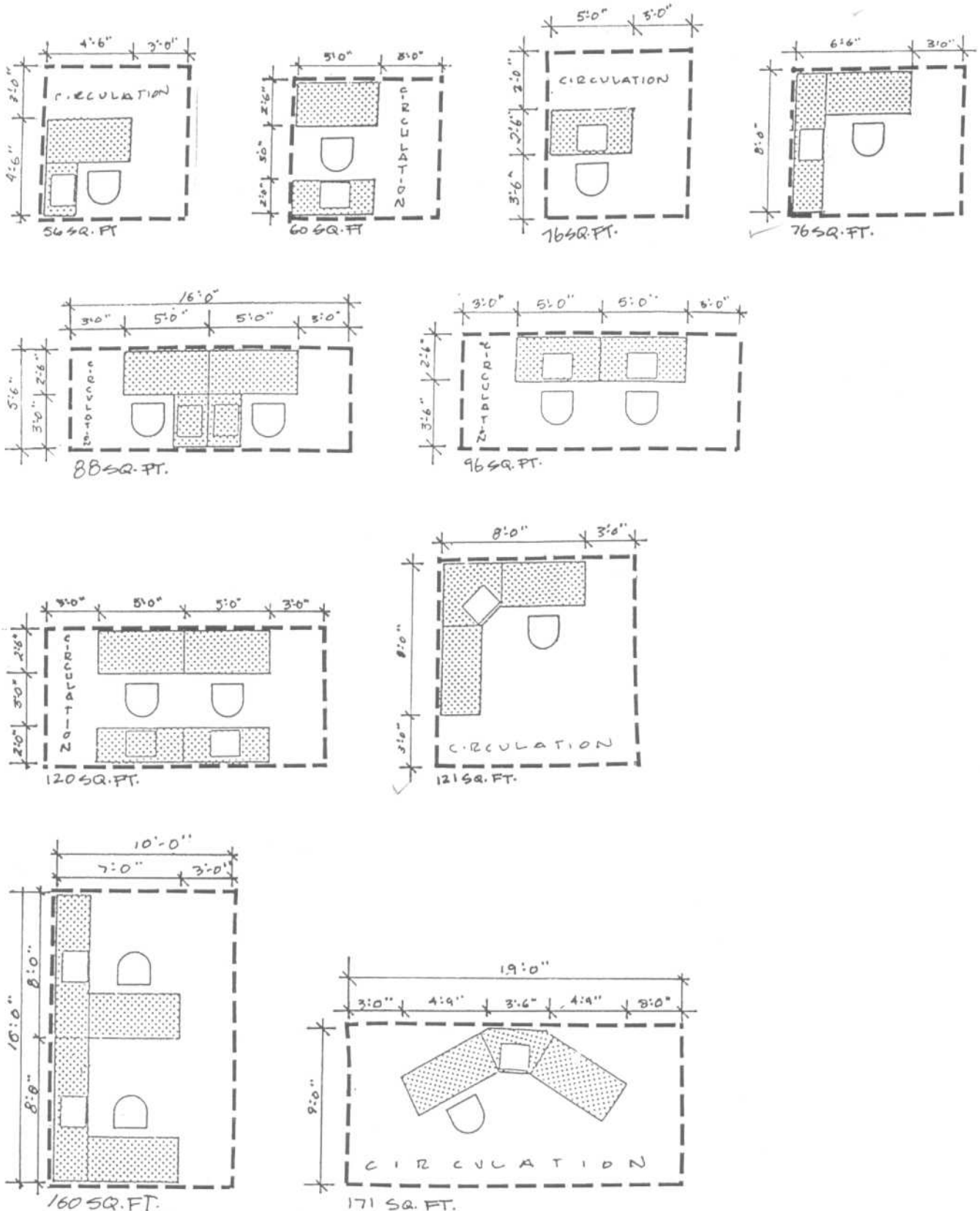


Fig. 3 Depending upon function, the sizes of individual and multiple workstations vary dramatically. Size of worksurface, length and depth of return, chair size, and circulation patterns all influence the gross square footage requirements.

## GENERAL OFFICES AND MULTIPLE WORKSTATIONS

Planning Data: Multiple Workstations

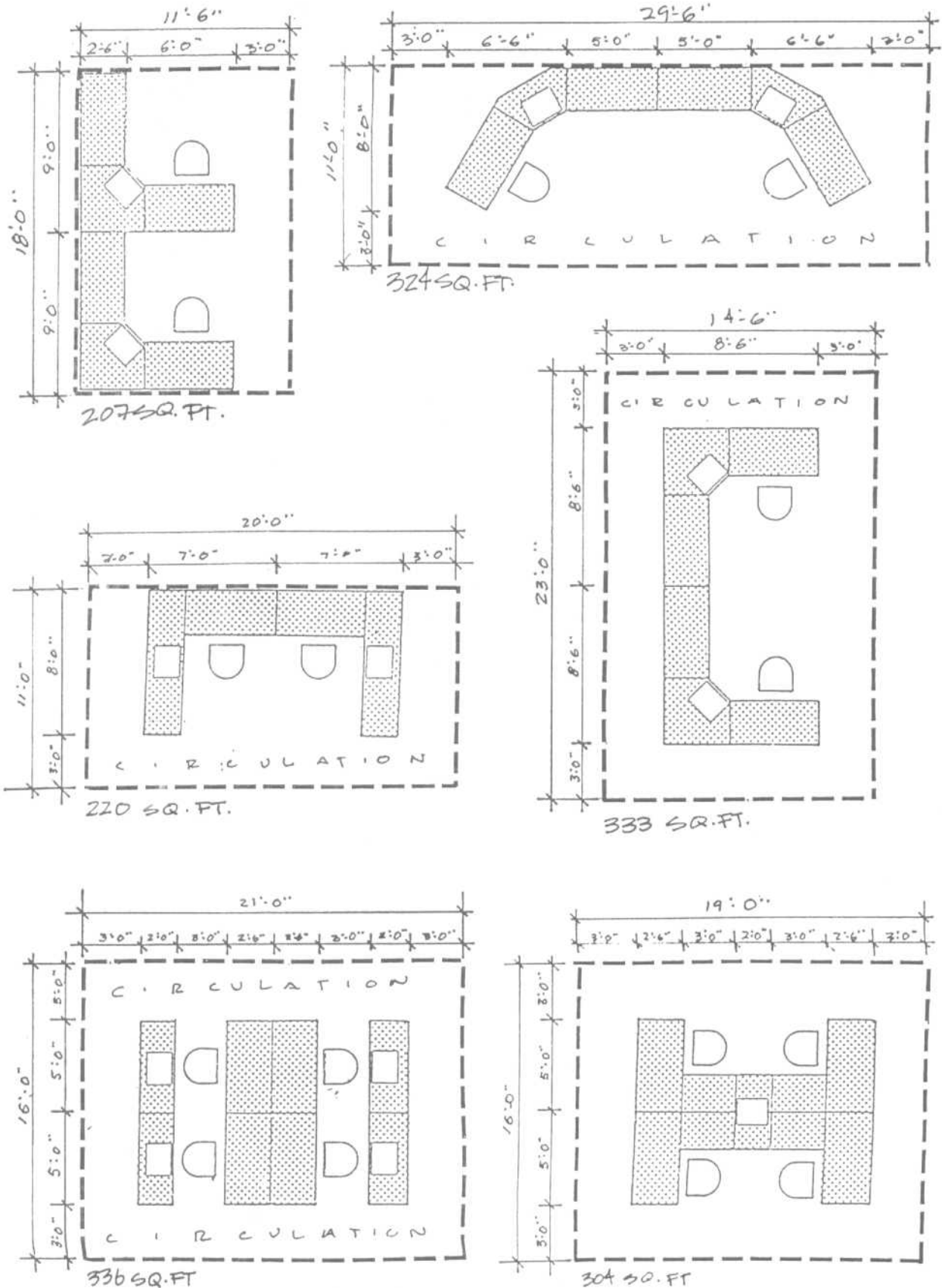


Fig. 4 Floating or free-standing workstations tend to utilize more floor area than workstations placed against a wall or sharing the same wall panel. Clustering of workstations will ultimately result in the use of less floor area, but at the expense of major ergonomic considerations. Decisions relative to both acoustical privacy and personal space are often sacrificed in the name of economy.



## GENERAL OFFICES AND MULTIPLE WORKSTATIONS

Planning Data: Multiple Workstations

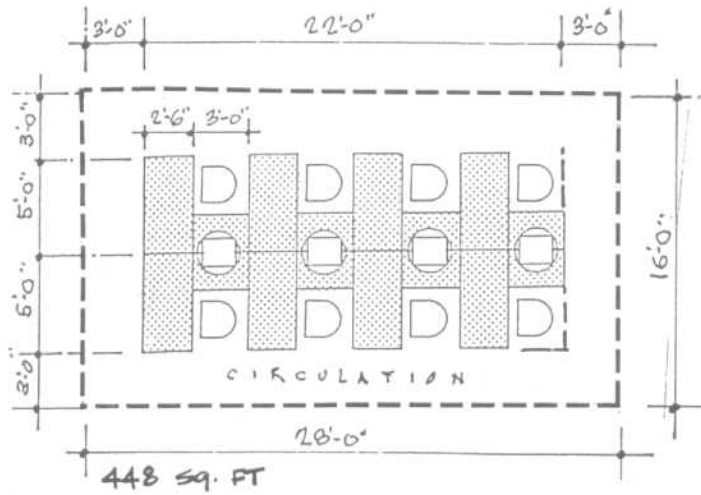


Fig. 5

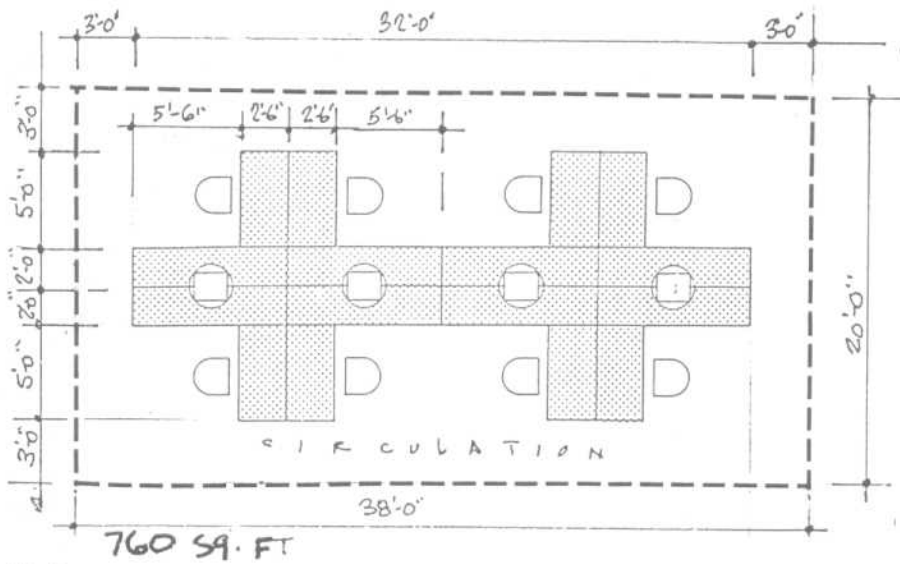


Fig. 6

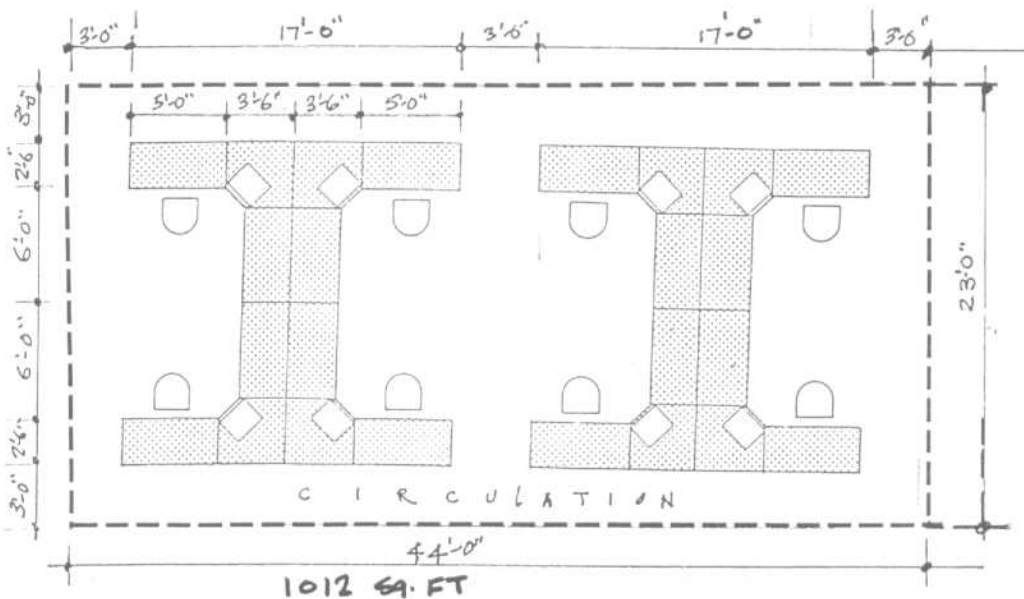
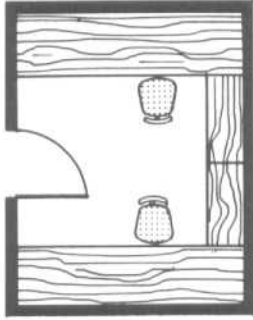
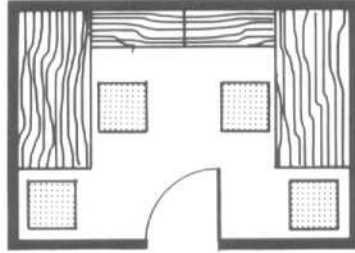
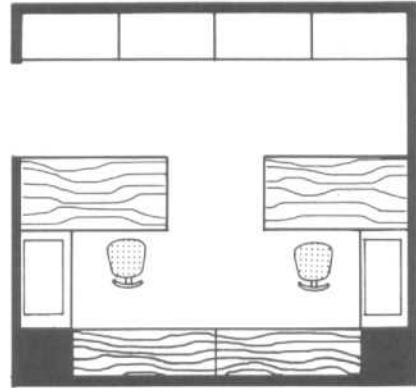
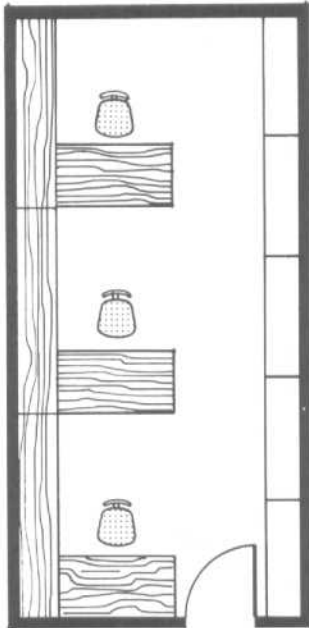
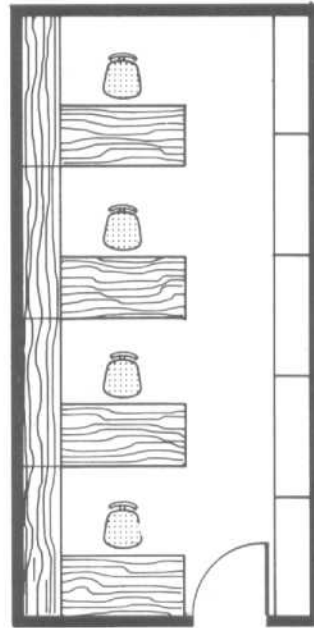
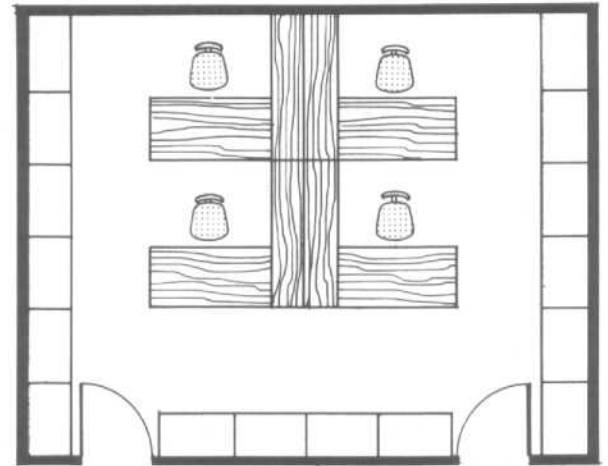
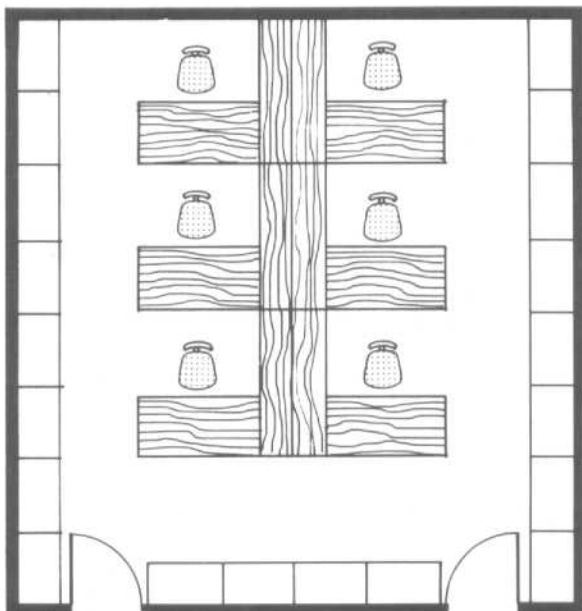


Fig. 7

Multiple workstations can result in efficient utilization of space and sharing of expensive computer terminals and equipment. If use of computer terminals is intensive, individual CRTs should be provided. Figures 5, 6, and 7 each show eight workstations, yet the setups range in area from 448 to 1012 ft<sup>2</sup>. Furniture size, function, and ergonomic considerations all affect setup.

## GENERAL OFFICES AND MULTIPLE WORKSTATIONS

Planning Data: Office Layout

Fig. 8 9 ft x 12 ft, 108 ft<sup>2</sup>.Fig. 9 9 ft x 14 ft, 126 ft<sup>2</sup>.Fig. 10 15 ft x 16 ft, 240 ft<sup>2</sup>.Fig. 11 12 ft x 25 ft, 300 ft<sup>2</sup>.Fig. 12 12 ft x 25 ft, 300 ft<sup>2</sup>.Fig. 13 18 ft x 25 ft, 414 ft<sup>2</sup>.Fig. 14 24 ft x 23 ft, 552 ft<sup>2</sup>.

It is not unusual to have two or more persons share an enclosed office space. In planning this type of office space, both circulation and clearance become critically important. Door swings, the extension of file drawers, and points of entry must all be carefully considered.

The design of the private office requires a knowledge of the basic dimensional requirements and clearances of the executive workstation and, where applicable, of visitor seating accommodations. In certain instances where various aspects of the office interior are customized and/or built into the construction, a knowledge of architectural woodwork detailing is also desirable.

This page and the following pages include the necessary planning criteria required, as well as details of certain customized components.

Executive workstation and/or desk size and configuration can be customized depending on desired image, scale, and ambience. Desks are also available in generally accepted standard sizes. It is these standard desks that are most used in the design of the private office. Figure 1 illustrates the range of desk dimensions, chair dimensions, and clearances involved.

Many private executive offices are being designed with desks that do not conform

	in	cm
A	30-39	76.2-99.1
B	66-84	167.6-213.4
C	21-28	53.3-71.1
D	24-28	61.0-71.1
E	23-29	58.4-73.7
F	42 min.	106.7 min.
G	105-130	266.7-330.2
H	30-45	76.2-114.3
I	33-43	83.8-109.2
J	10-14	25.4-35.6
K	6-16	15.2-40.6
L	20-26	50.8-66.0
M	12-15	30.5-38.1
N	117-148	297.2-375.9
O	45-61	114.3-154.9
P	30-45	76.2-114.3
Q	12-18	30.5-45.7
R	29-30	73.7-76.2
S	22-32	55.9-81.3

with the basic rectangular shape. Such a situation is illustrated in Fig. 2, which shows a circular executive desk. Such a desk is often selected if the executive in question plans to hold conferences within the office and prefers the psychology of having either visitors or employees gather around the worksurface in an egalitarian fashion. While a minimum desk size of 48 in, or 121.9 cm, is shown, this dimension is also influenced by the number of side chairs to be grouped around the desk.

A circular executive desk must be supported by supplementary credenza or file storage within easy reach of the executive chair. Side arm reach relative to the work/activity zone must always be studied carefully.

Figure 3 illustrates a typical circular lounge grouping found within an executive office. Providing for the appropriate leg clearance of 12 to 18 in, or 30.5 to 45.7 cm, is also determined by the sitting zone requirements. Buttock-knee length must also be considered.

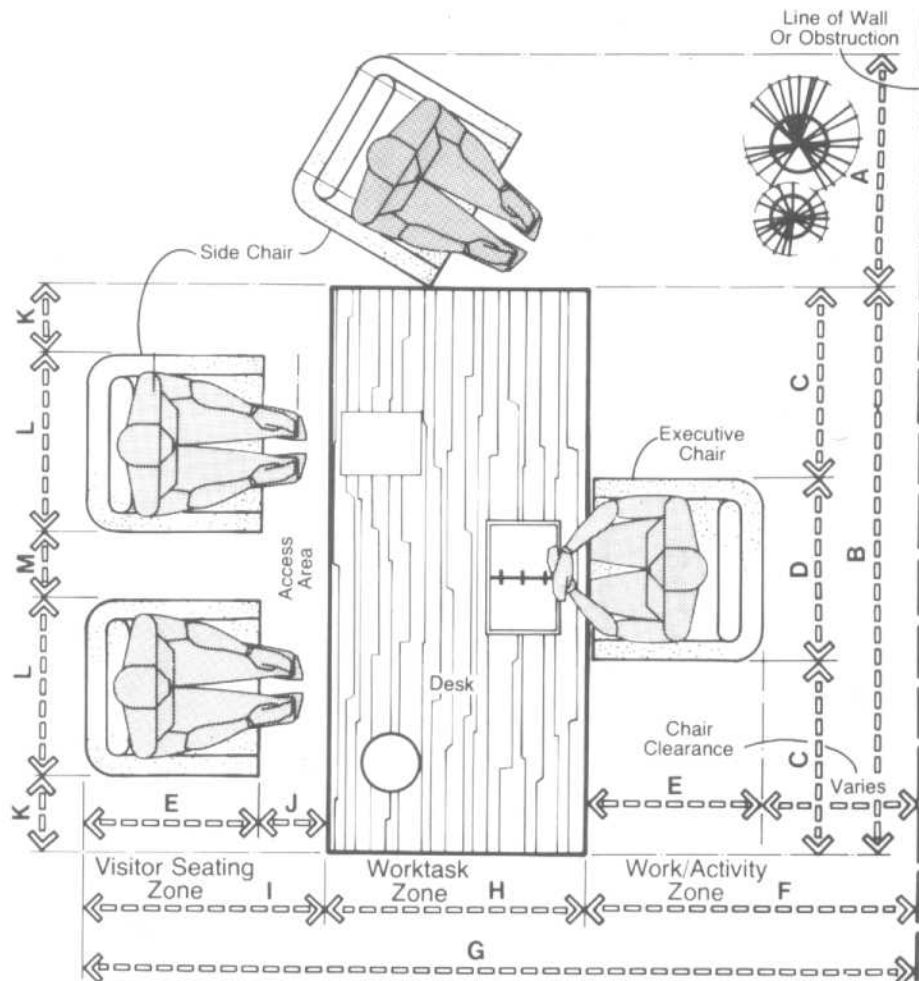
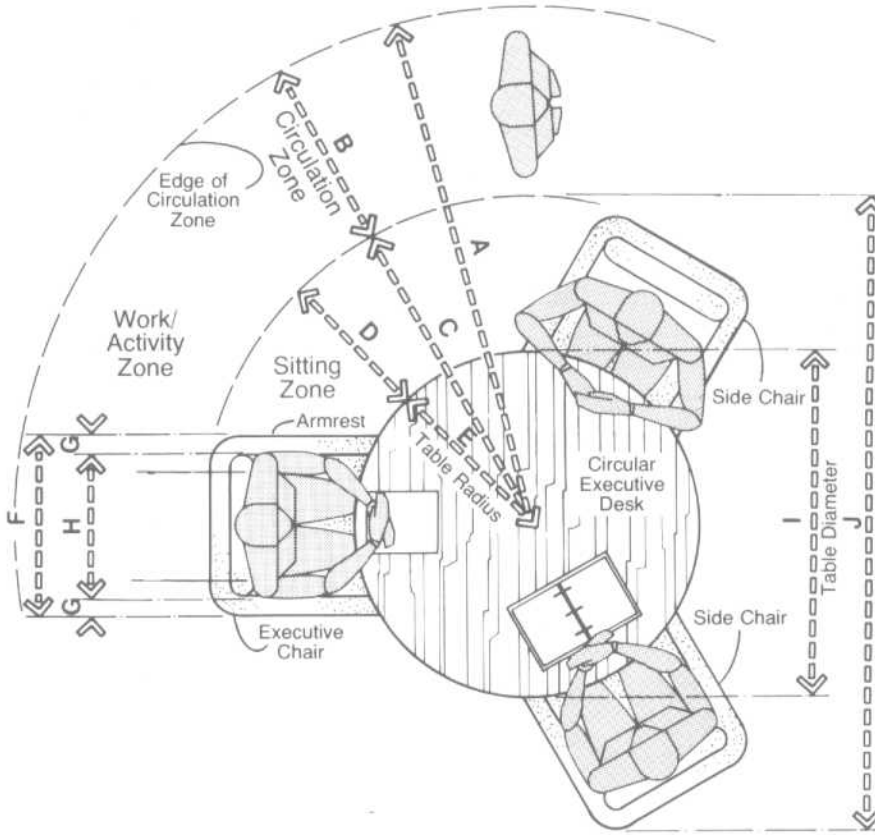


Fig. 1 Executive desk/visitor seating.

PRIVATE OFFICES

Executive Workstation



	in	cm
A	77-88	195.6-223.5
B	30	76.2
C	46-58	116.8-147.3
D	22-28	55.9-71.1
E	24-30	61.0-91.4
F	24-28	61.0-71.1
G	2-3	5.1-7.6
H	20-22	50.8-55.9
I	48-60	121.9-152.4
J	92-116	233.7-294.6
K	36-42	91.4-106.7
L	6-9	15.2-22.9
M	24	61.0
N	42-60	106.7-152.4
O	36-48	91.4-121.9
P	57-78	144.8-198.1
Q	33-48	83.8-121.9
R	12-18	30.5-45.7
S	21-30	53.3-76.2
T	24-32	61.0-81.3

Fig. 2 Circular executive desk.

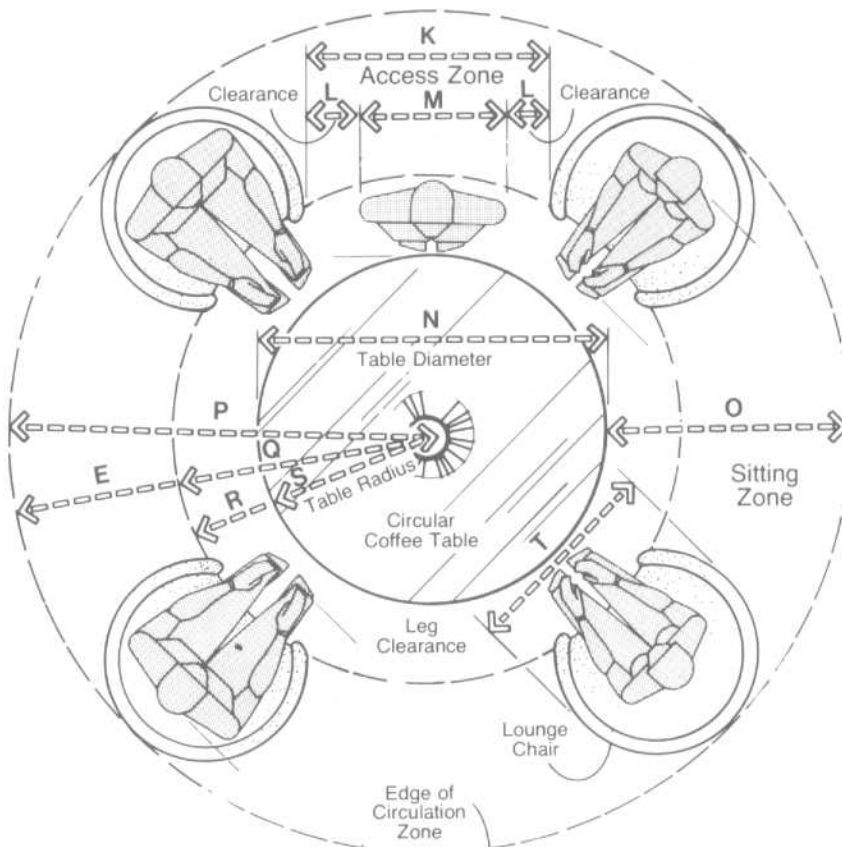


Fig. 3 Circular lounge grouping.

PRIVATE OFFICES

Planning Data: Typical Room Arrangements

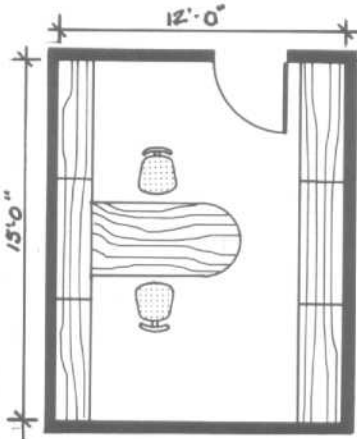


Fig. 4 12 ft x 15 ft, 180 ft<sup>2</sup>.

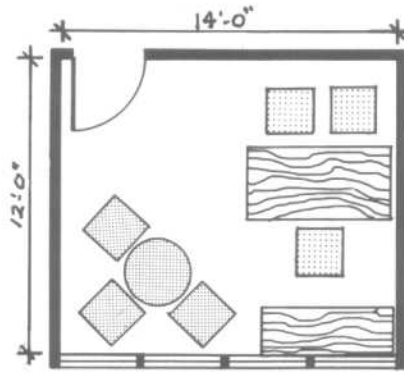


Fig. 5 14 ft x 12 ft, 168 ft<sup>2</sup>.

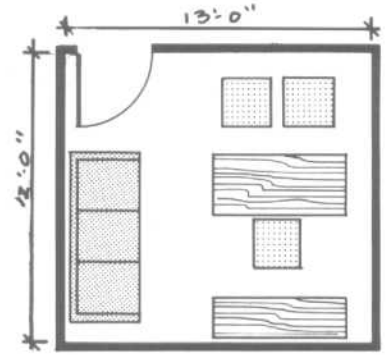


Fig. 6 13 ft x 12 ft, 156 ft<sup>2</sup>.

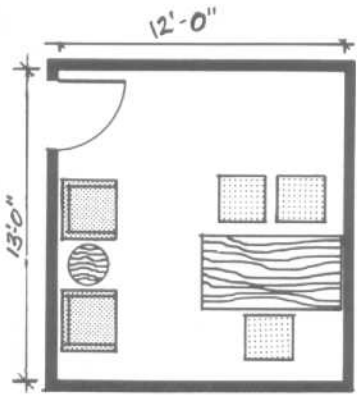


Fig. 7 12 ft x 13 ft, 156 ft<sup>2</sup>.

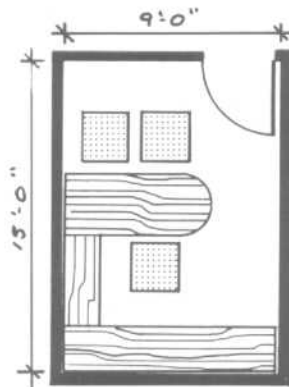


Fig. 8 9 ft x 15 ft, 135 ft<sup>2</sup>.

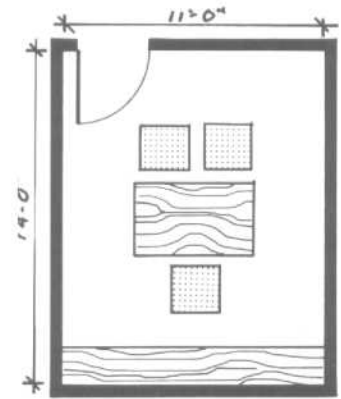


Fig. 9 11 ft x 14 ft, 154 ft<sup>2</sup>.

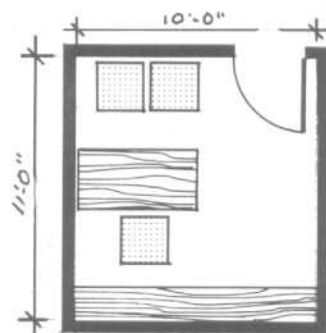


Fig. 10 10 ft x 11 ft, 110 ft<sup>2</sup>.

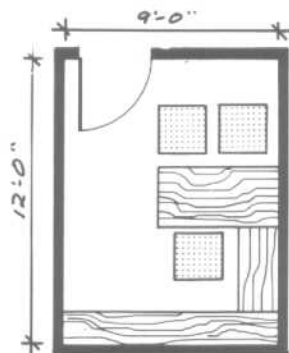
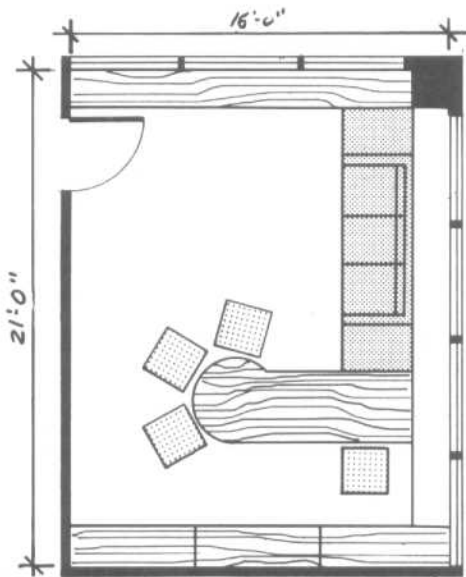
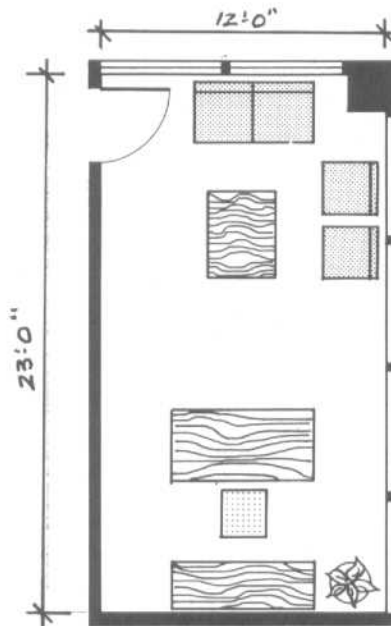
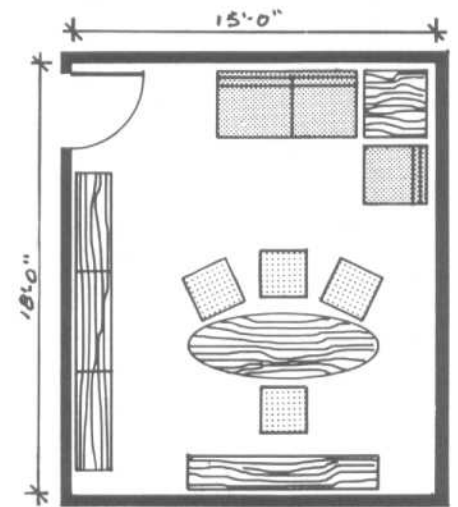
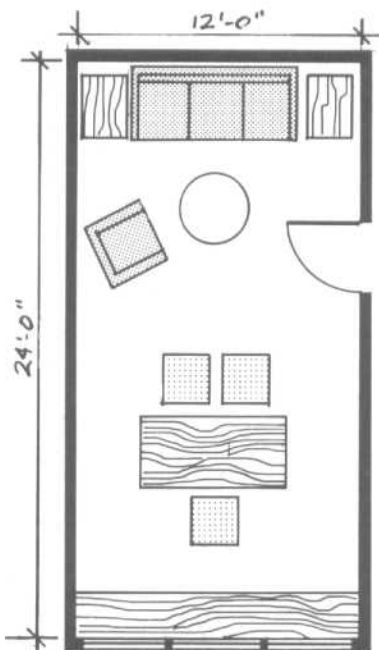
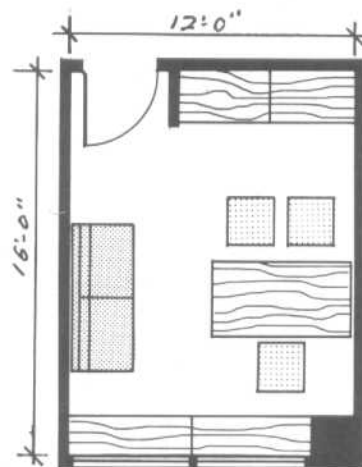
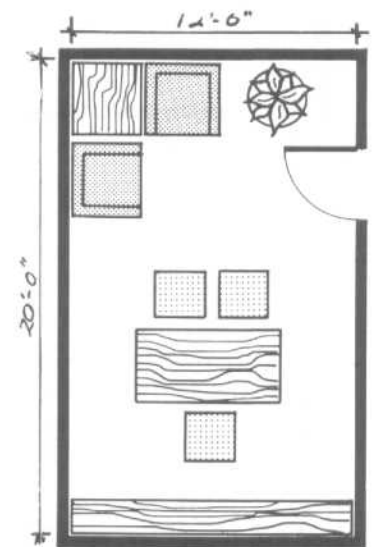


Fig. 11 9 ft x 12 ft, 108 ft<sup>2</sup>.

## PRIVATE OFFICES

Planning Data: Typical Room Arrangements

Fig. 12 16 ft × 21 ft, 336 ft<sup>2</sup>.Fig. 13 12 ft × 23 ft, 276 ft<sup>2</sup>.Fig. 14 15 ft × 18 ft, 270 ft<sup>2</sup>.Fig. 15 12 ft × 24 ft, 288 ft<sup>2</sup>.Fig. 16 12 ft × 16 ft, 192 ft<sup>2</sup>.Fig. 17 12 ft × 20 ft, 240 ft<sup>2</sup>.

The private offices illustrated in Figs. 12 to 17 reflect middle to senior management functional, as well as status, requirements. Each office layout should be carefully reviewed with the client to ensure that all programmatic functions have been met. Offices of this size do not easily accommodate an independent conference function.

PRIVATE OFFICES

Planning Data: Typical Room Arrangements

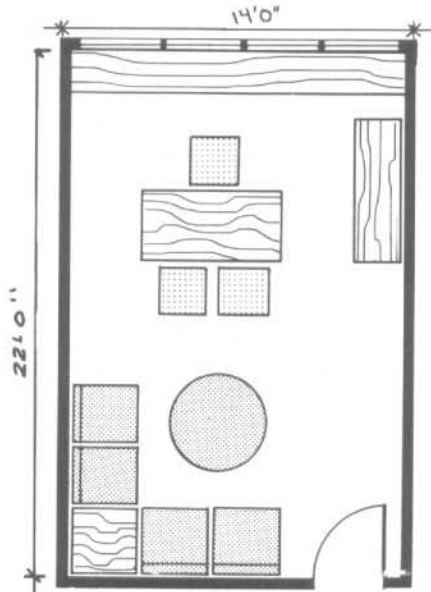


Fig. 18 14 ft x 22 ft, 308 ft<sup>2</sup>.

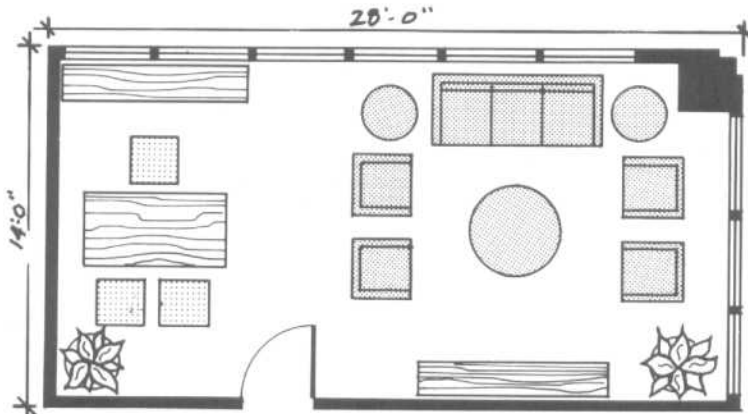


Fig. 19 14 ft x 28 ft, 392 ft<sup>2</sup>.

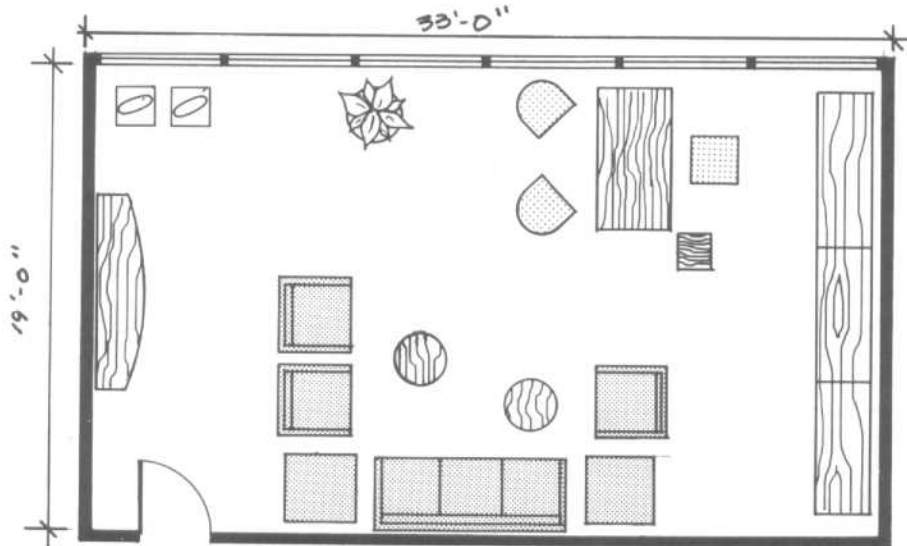


Fig. 20 19 ft x 33 ft, 627 ft<sup>2</sup>.

PRIVATE OFFICES

Wall Unit Details

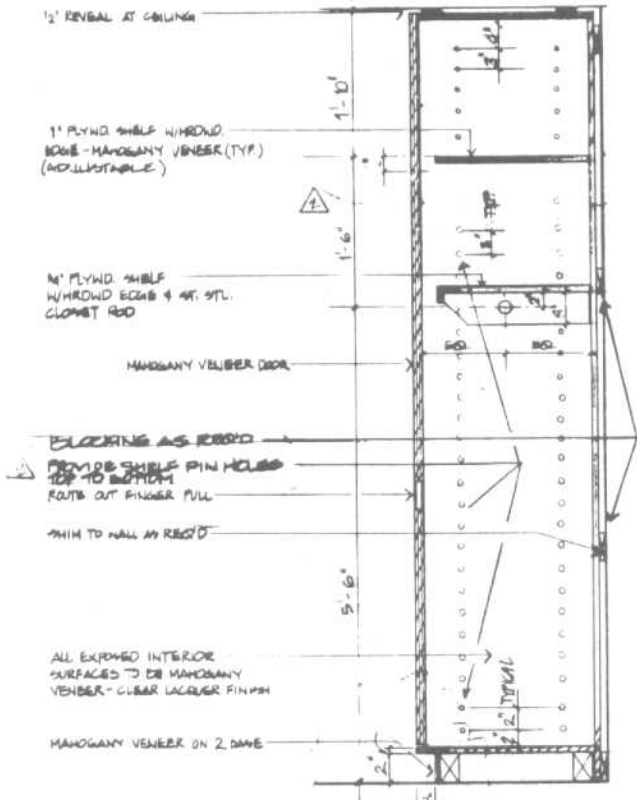
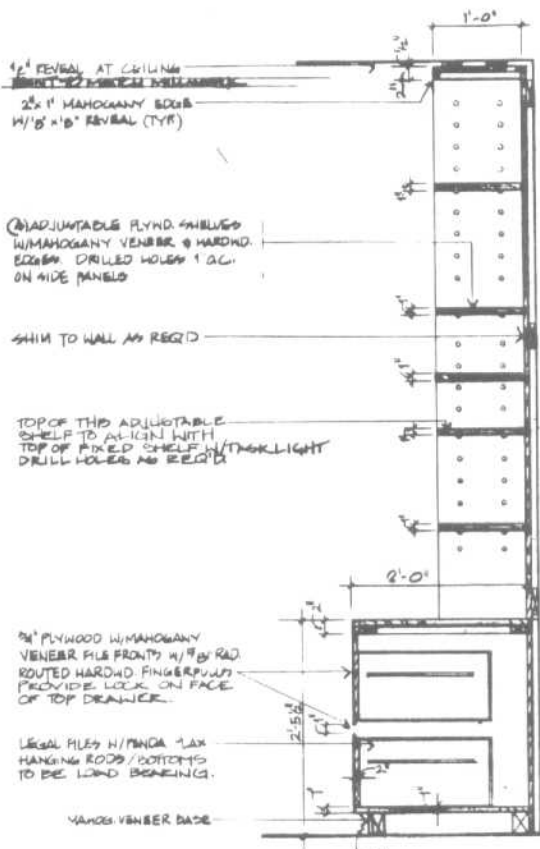
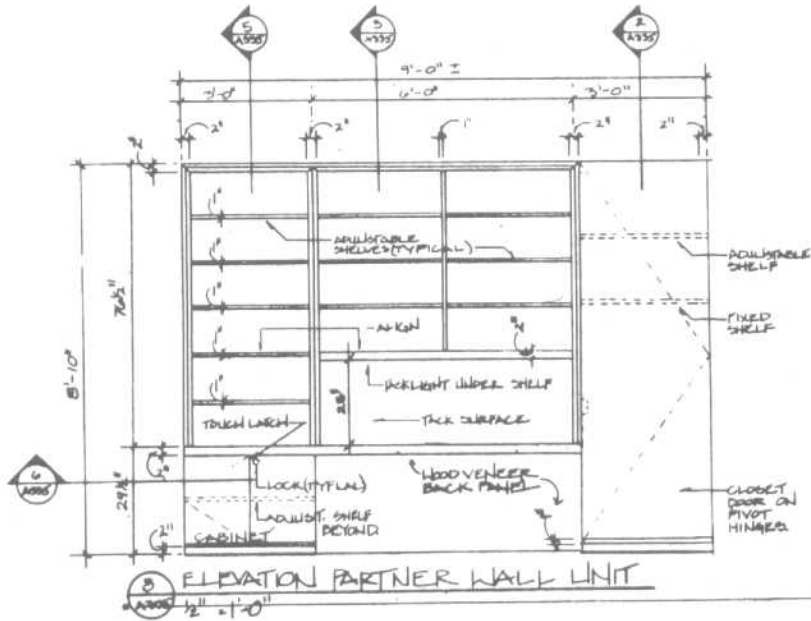
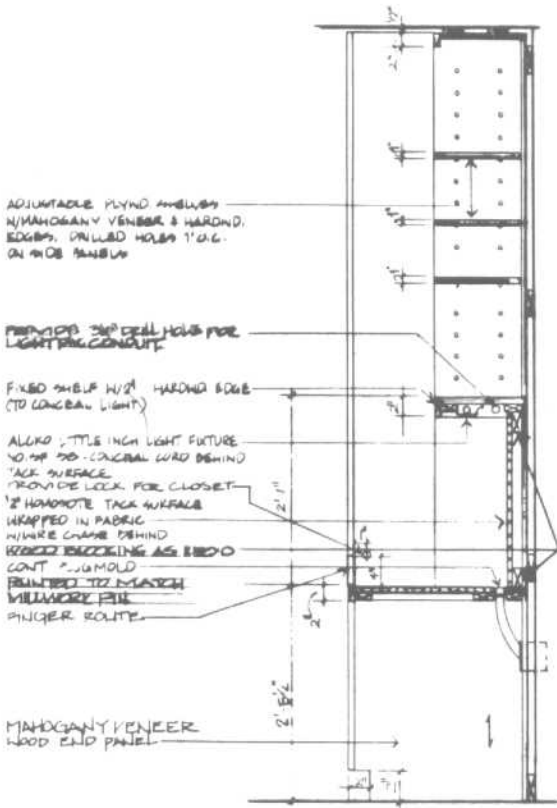
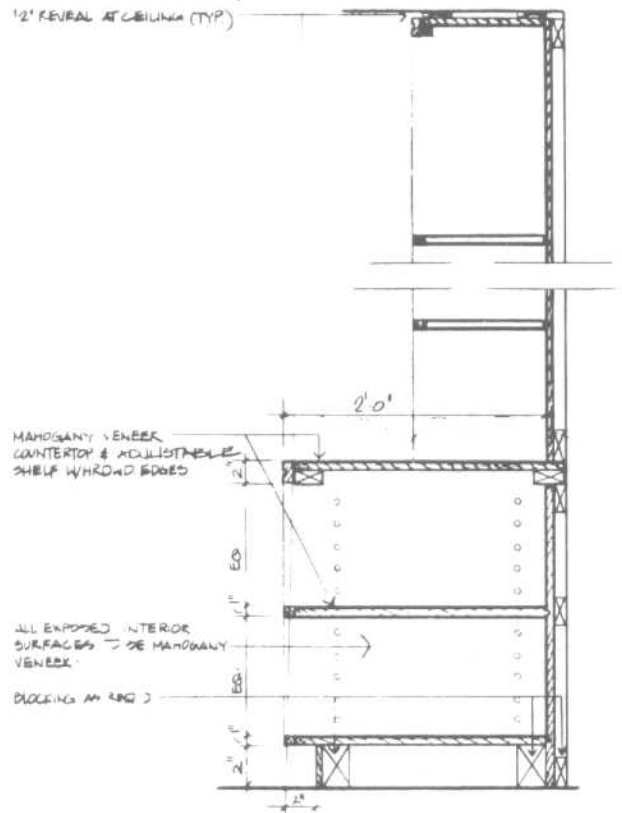


Fig. 21 Custom architectural woodwork, or "built-ins," is often required for executive offices. These architectural working drawings reflect the custom design of a storage wall for a partner in a law office. Careful analysis shows the incorporation of file, book, and coat storage within a floor-to-ceiling mahogany wood unit.

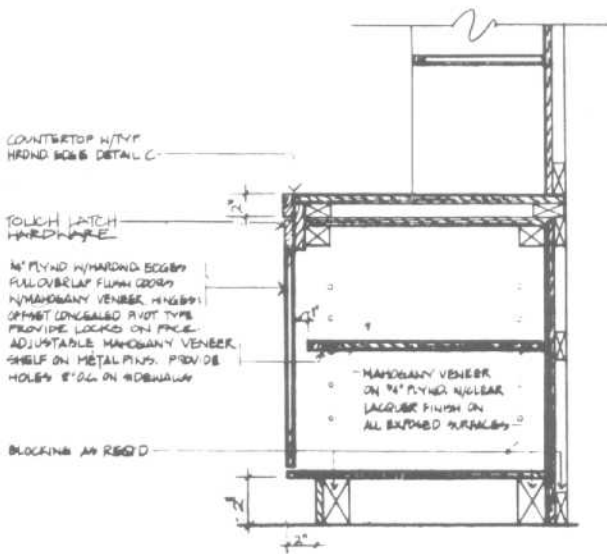




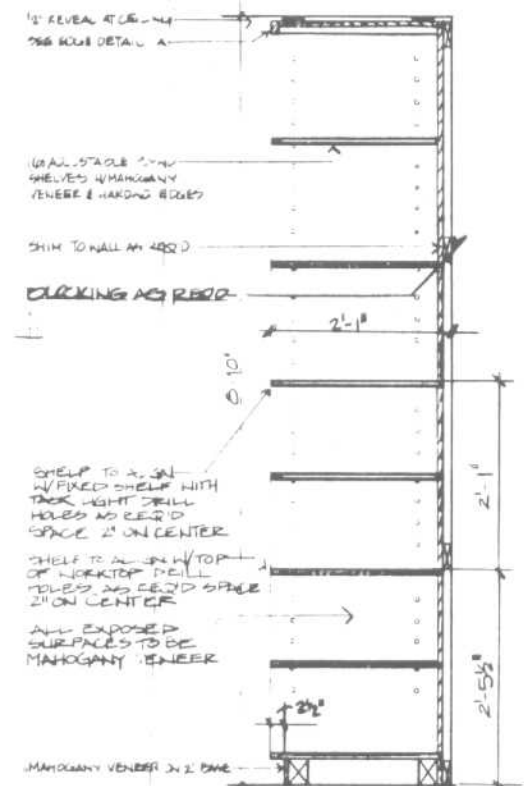
3 SECTION WALL UNIT  
A399 1'-1'-0"



4 SECTION OPEN SHELVING UNIT  
A399 1 1/2' x 1'-0"



5 SECTION THRU BASE CABINET  
A399 1 1/2' x 1'-0"



7 SECTION - 2 UNIT SPECIAL  
A399 1' x 1'-0"

Fig. 22 These details represent typical vertical sections taken through various storage components for the partner wall unit shown in Fig. 21. Careful attention must be given to integration of electronic equipment, electrical wiring, and task lighting.

PRIVATE OFFICES

Wall Unit Details

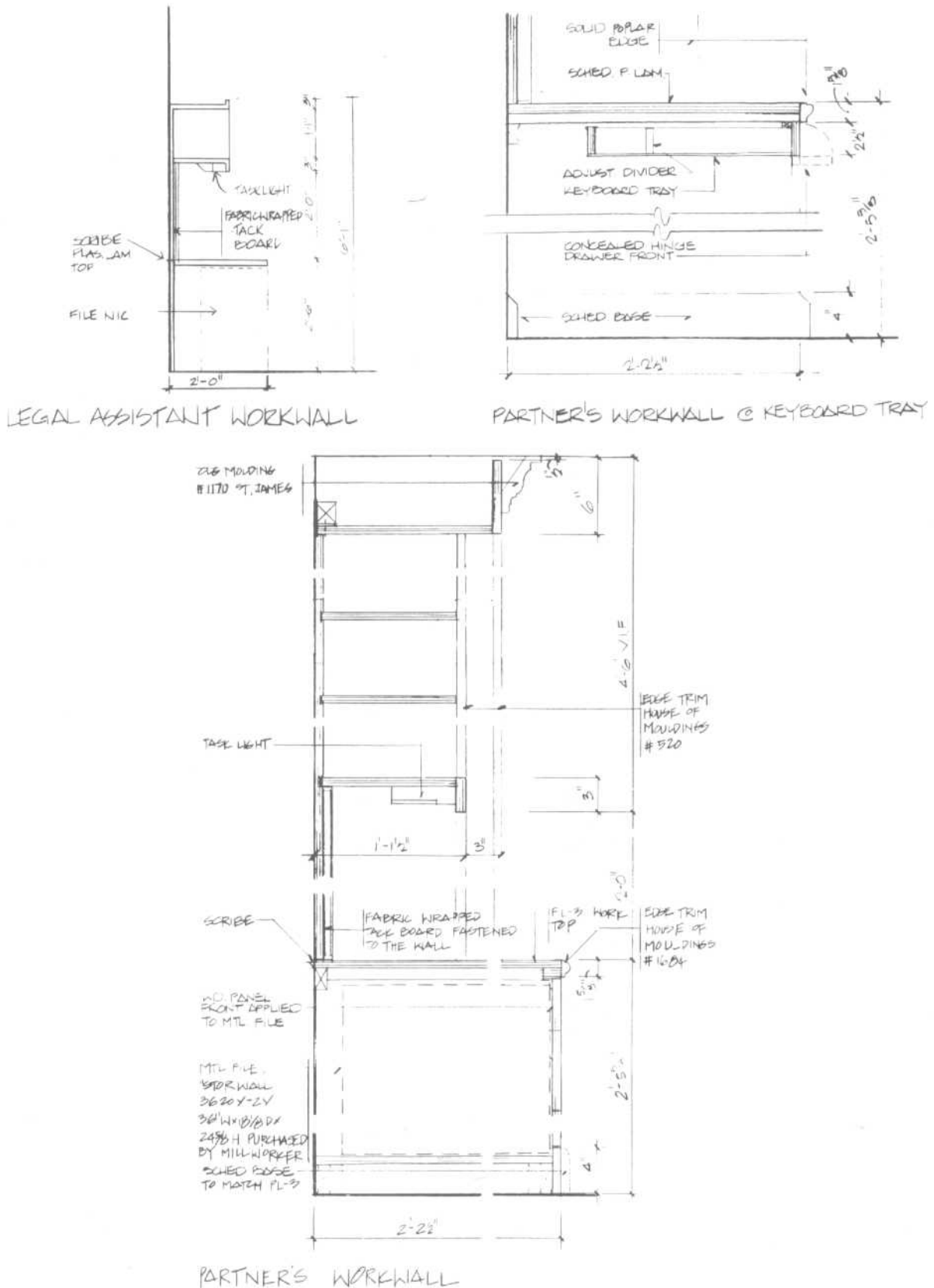


Fig. 23 In many instances, the utilization of standard wood moldings can enhance the overall appearance of an otherwise relatively simple workwall unit. Other cost-saving devices illustrated here are the application of a wood panel to a standard metal file and the use of a fabric-wrapped tack board. The incorporation of an undercabinet task light is almost always required.

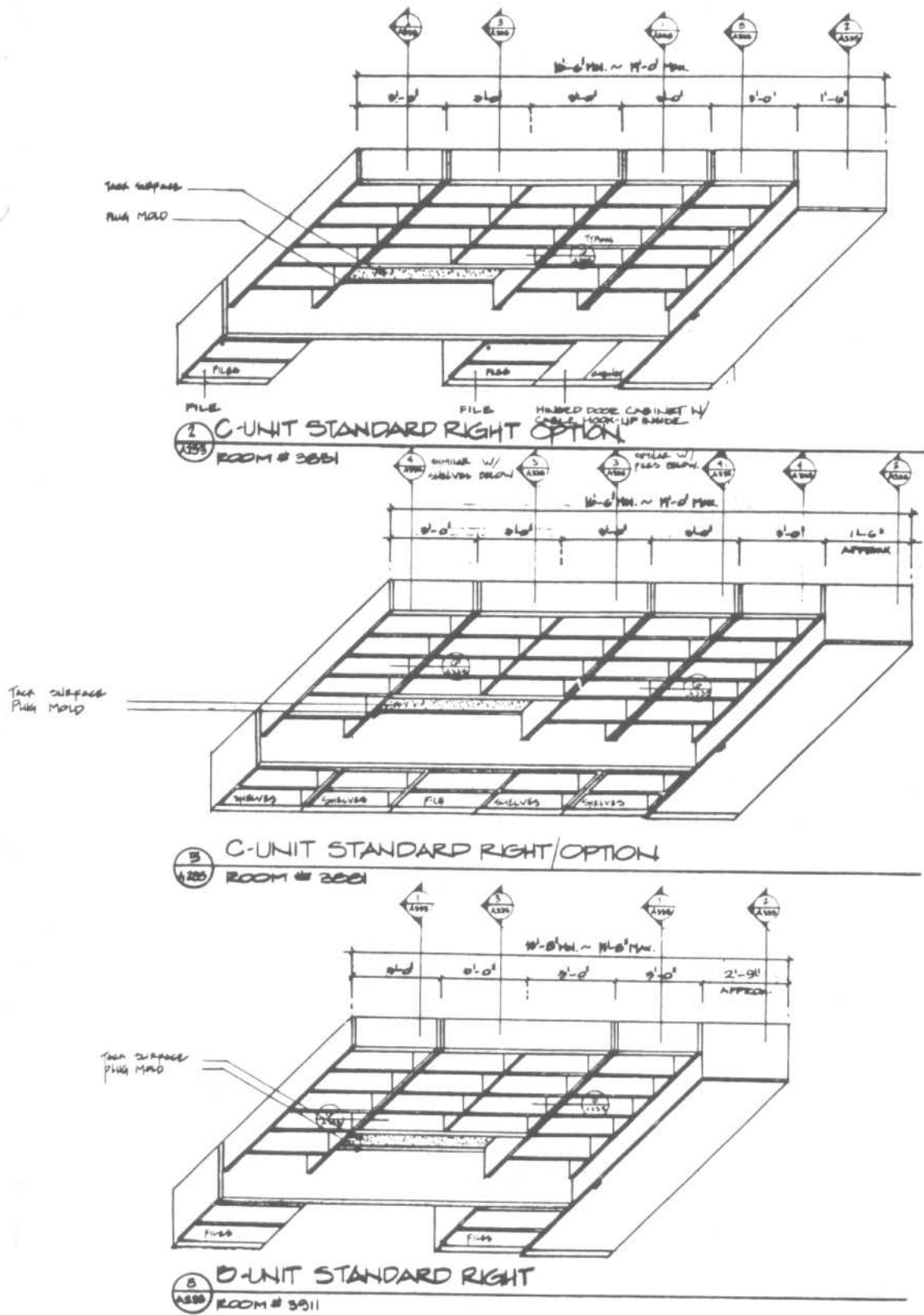


Fig. 24 These plan oblique drawings provide detailed design information to both client and architectural woodwork contractor. These drawings are particularly helpful when the office project for which these wall units are intended consists of many offices, and each office is to be customized within certain constraints.

PRIVATE OFFICES

Credenzas

Many private offices require the detailing of custom credenzas and storage units. The sophistication and complexity of such details can significantly influence the budget for the space as well as the time of installation. Figure 25 represents a "high-end" approach, while Fig. 26 is more appropriate for offices with a moderate budget.

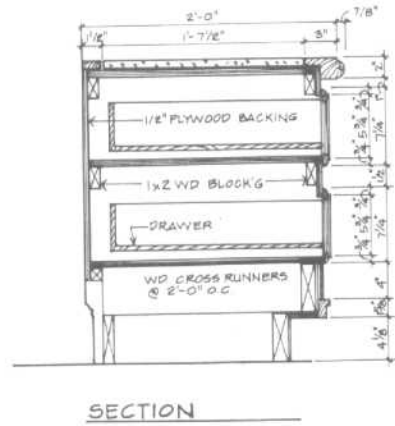
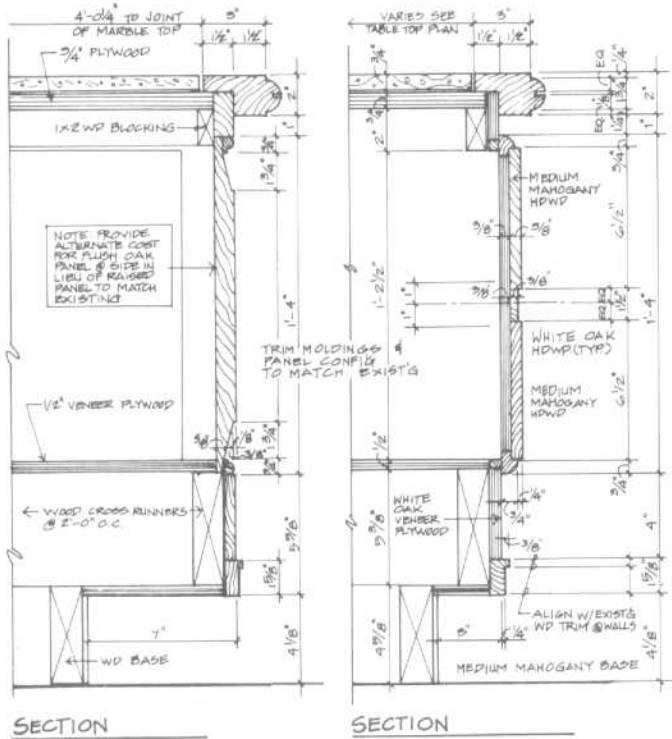
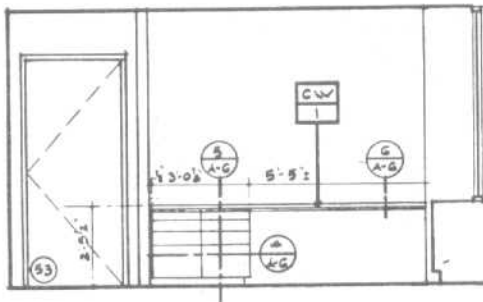
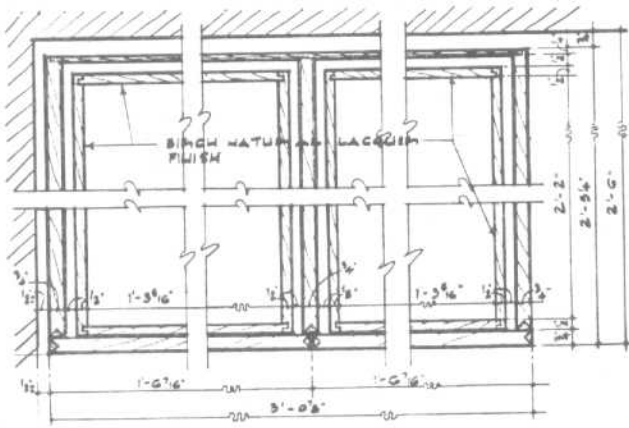


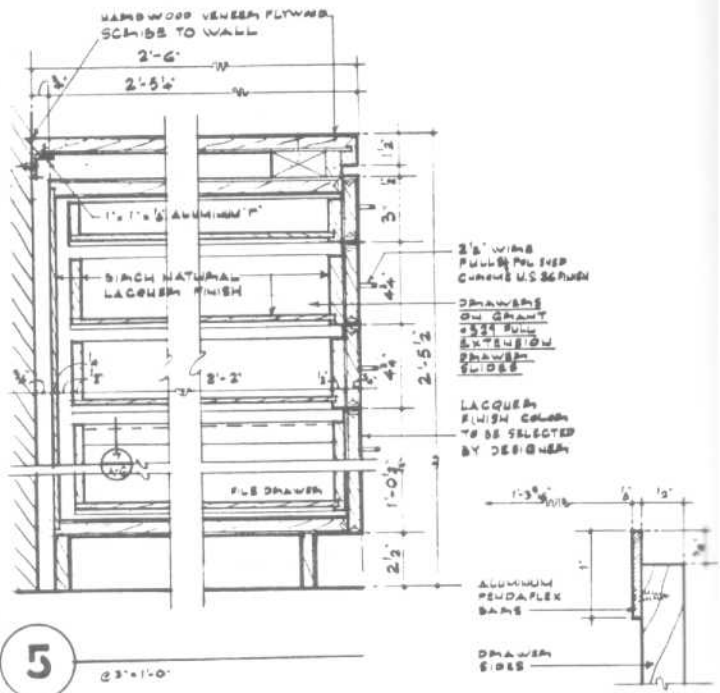
Fig. 25



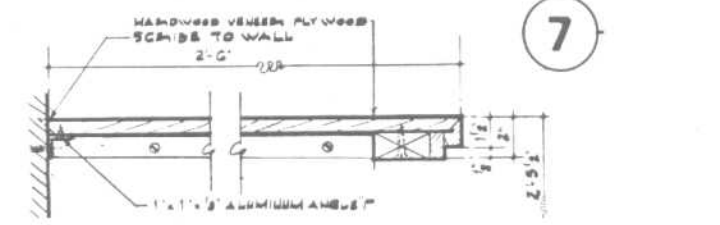
7 NORTH ELEVATION SPACE 1219  
@ 3/8" = 1'-0"



4 @ 3/8" = 1'-0"



5 @ 3/8" = 1'-0"



6 @ 3/8" = 1'-0"

New electronic technologies, together with the advent and proliferation of the microcomputer and the availability of inexpensive packaged software, have changed the complexion of the office workplace. The ergonomic considerations related to this new work environment have necessitated a re-evaluation of the traditional interface between the seated office worker and his or her workplace. It is essential that the design of this electronic workstation be responsive to human factors in order to avoid physical discomfort for the user. The location of the keyboard, angle of the visual display terminal, adjustability of the chair, field of vision, provisions for back support, and height of the seat above the floor are a few of the considerations in the design process.

This page and the following pages provide a variety of anthropometric and ergonomic planning data and details for use as reference in the design of the electronic workstation.

Figure 1 illustrates guidelines for use in establishing preliminary design assumptions for a workstation display console. Since the types of displays and the nature of the tasks associated with those displays can vary considerably, Fig. 1 cannot be taken too literally. The configuration shown, however, is fairly representational. Certain basic factors should be noted anthropometrically. The use of an adjustable chair will permit the eye height of the seated viewer to be raised or lowered to view the display, as may be required depending on body size. An adjustment range between 15 and 18 in, or 38.1 and 45.7 cm, should be adequate to accommodate the eye height sitting requirements of about 90 percent of all viewers. Adjustability, however, will be of little value if the vertical distance between the underside of the desk and the floor is insufficient to accommodate the knee height and thigh clearance when the seat is adjusted to the appropriate position. If such distance is not less than 26.5 in, or 67.3 cm, the majority of viewers will be accommodated.

The location of the top of the display should align with the standard sight line for optimum viewing conditions. Since the eye and the head can rotate within certain limitations and, in so doing, increase the area that can be scanned, displays can be located above the standard sight line when absolutely necessary. It should also be noted that the more perpendicular the normal sight line is to the display plane, the greater the viewing comfort. Accordingly, consideration should be given to sloping the display plane since the normal sight line is about 15° below the horizontal.

*Stature* is the vertical distance from the floor to the top of the head, measured while the subject stands erect, looking straight ahead.

*Elbow height* is the distance measured vertically from the floor to the depression formed at the elbow where the forearm meets the upper arm.

*Eye height* is the vertical distance from the floor to the inner corner of the eye, measured with the subject looking straight ahead and standing erect.

*Sitting height erect* is the vertical distance from the sitting surface to the top of the head with the subject sitting erect.

*Sitting height normal* is the vertical distance from the sitting surface to the top of

the head, measured with the subject sitting relaxed.

*Eye height* is the vertical distance from the inner corner of the eye to the sitting surface.

*Shoulder height* is the distance taken vertically from the sitting surface to a point on the shoulder midway between the neck and acromion.

*Shoulder breadth* is the maximum horizontal distance across the deltoid muscles.

*Elbow to elbow* is the distance across the lateral surfaces of the elbows measured with elbows flexed and resting lightly against the body with the forearms extended horizontally.

*Hip breadth* is the breadth of the body as measured across the widest portion of the hips. Note that a hip breadth measurement can also be taken with the subject in a standing position, in which case the definition would be the maximum breadth of the lower torso.

*Elbow rest height* is the height from the top of the sitting surface to the bottom of the tip of the elbow.

*Thigh clearance* is the distance taken vertically from a sitting surface to the top of the thigh at the point where the thigh and the abdomen intersect.

*Knee height* is the vertical distance from the floor to the midpoint of the kneecap.

*Popliteal height* is the distance, taken vertically, from the floor to the underside of the portion of the thigh just behind the knee while the subject is seated with body erect. The knees and ankles are usually perpendicular, with the bottom of the thigh and the back of the knees barely touching the sitting surface.

*Buttock-popliteal length* is the horizontal distance from the rearmost surface of the buttock to the back of the lower leg.

*Buttock-knee length* is the horizontal distance from the rearmost surface of the buttocks to the front of the kneecaps.

*Buttock-toe length* is the horizontal distance from the rearmost surface of the buttocks to the tip of the toe.

*Buttock-heel length* is the horizontal distance from the base of the heel to a wall against which the subject sits erect with his leg maximally extended forward along the sitting surface. This is sometimes referred to as buttock-leg length.

*Vertical reach* is the height above the sitting surface of the tip of the middle finger when the arm, hand, and fingers are extended vertically.

*Vertical grip reach* is usually measured from the floor to the top of a bar grasped in the right hand while the subject stands erect and the hand within which the bar is grasped is raised as high as it can be conveniently without experiencing discomfort or strain.

*Side arm reach* is the distance from the center line of the body to the outside surface of a bar grasped in the right hand while the subject stands erect and the arm is conveniently outstretched horizontally without experiencing discomfort or strain.

*Thumb tip reach* is the distance from the wall to the tip of the thumb measured with the subject's shoulders against the wall, his arm extended forward, and his index finger touching the tip of his thumb.

*Maximum body depth* is the horizontal distance between the most anterior point on the body to the most posterior. Anterior points are usually located on the chest or abdomen while the posterior points are usually found in the buttock or shoulder region.

*Maximum body breadth* is the maximum distance, including arms, across the body.

	in	cm
A	16-18	40.6-45.7
B	16 min.	40.6 min.
C	18 min.	45.7 min.
D	15-18 adjust.	38.1-45.7
E	26.5 min.	67.3 min.
F	30	76.2

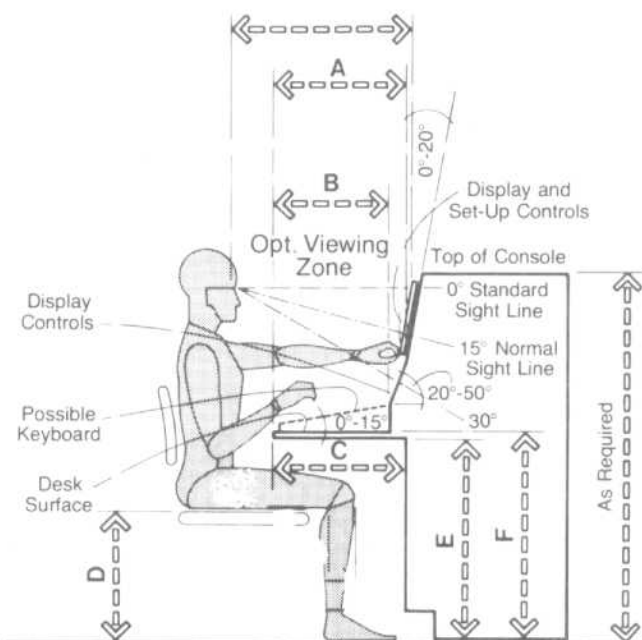


Fig. 1

**ELECTRONIC WORKSTATIONS**

Planning Data: Anthropometrics

■ Both the work surface and the display monitors must be lowered and raised as a unit with 31.8 cm of travel.

■ The work surface must be tilted anywhere between a horizontal position to 35° below horizontal. The work surface, at its lowest setting and with a 10° tilted angle, as is common in use, must be 63.5 cm in height at its front edge.

■ The work surface must raise to a horizontal height of 104 cm, accommodating a majority of people in a standing position.

■ The monitor screens must be tiltable to any position between 15° forward of vertical and 15° back. This lets the user adjust the screen to avoid reflective glare, and it accommodates various working positions of different lines of sight.

■ Adjustment controls designed for hand operation must be located within the operator's extended reach envelope.

■ All surfaces must have matte or dull finishes. This reduces the likelihood of reflective glare.

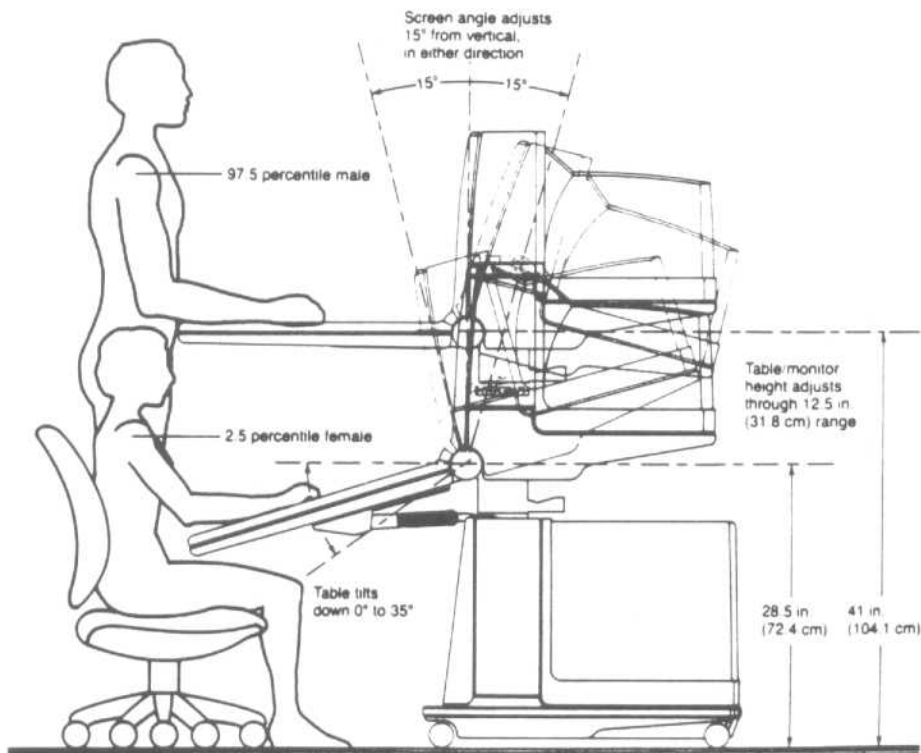
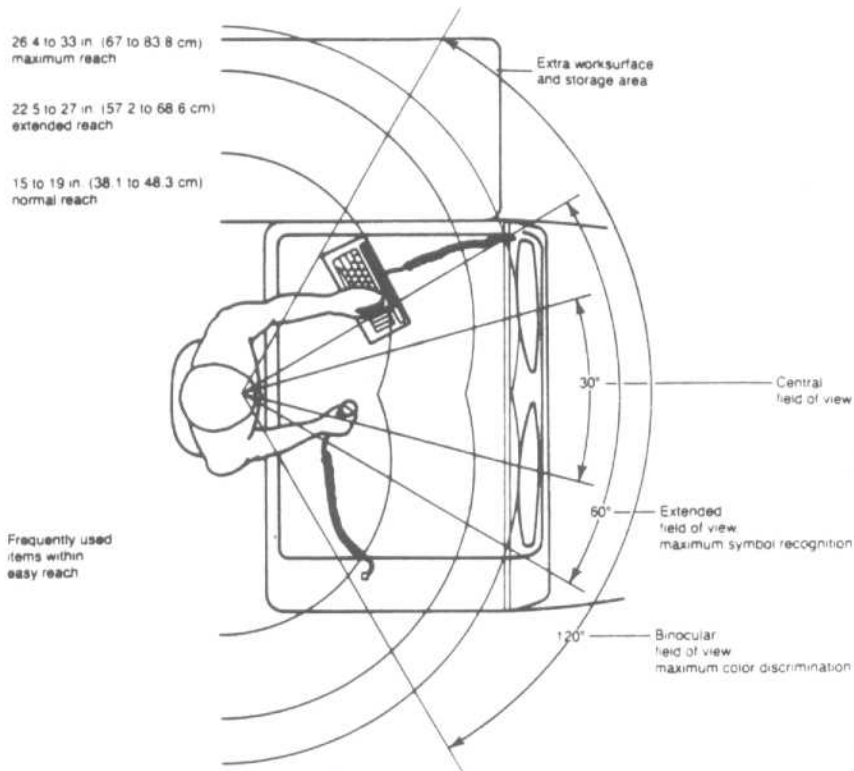
■ The workstation must be compact and relatively easy to move through a standard 81-cm doorway.

■ No structural components shall exist which inhibit the workstation's operation by users in wheelchairs, ensuring a barrier-free workstation.

■ Service personnel must have easy access to electrical components.

■ The digitizing surface must accommodate standard European and American D size drawings.

■ Screen depth of view must allow alphanumeric characters to be viewed at an angle between 20 and 28 arc minutes.



**The Automated Task.** *Square footage workstation standards for the automated task are also developed primarily according to task profile, equipment, conferencing, and privacy requirements.*

**Open**

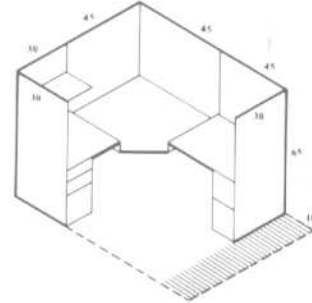
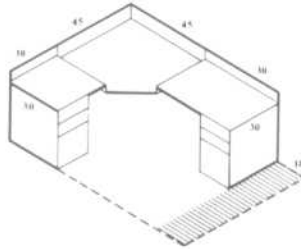
No requirement of equipment or task for privacy, concentration

**Screened**

Privacy required for reading, working, thinking, calculating, meetings, confidential phone calls, elimination of visual and acoustical distractions

**Task Profile: Data Retrieval.**

- Paper, material, or information processed, analyzed, and/or maintained.
- Multiple reference sources may be used on a task.
- Reference materials used frequently.
- Limited volume of supplies and permanent records kept at the workspace.
- Electronic equipment may be used for easy reference, retrieval, keeping records current, and maintaining data and records.
- Additional equipment such as microfilm viewers may be required.
- Ability to see and hear co-workers may be desirable.
- Tasks may also require screening for concentration.

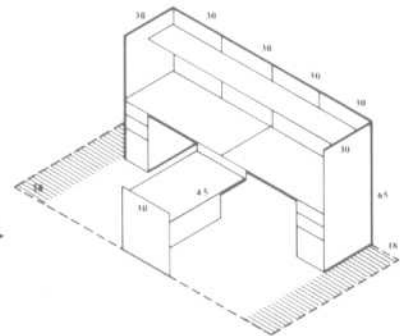
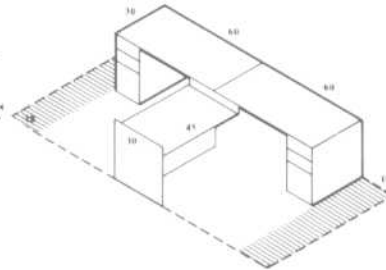


No  
45 x 45  
30 x 45  
(76 x 114 cm)  
3-4  
0-2

Guest chair  
Primary work surface  
Secondary work surface  
File drawers  
Shelves

**56 sq. ft.****Task Profile: Shared Tasks.**

- Paper, material, or information processed, analyzed, and/or maintained.
- More than one task may be performed concurrently.
- More than one operator uses same equipment.
- Multiple reference sources may be used on a task.
- Reference materials used may be used frequently.
- Electronic equipment may be used for easy reference, inputting/maintaining data and records, retrieval, keeping records current.
- Storage requirements vary according to task.

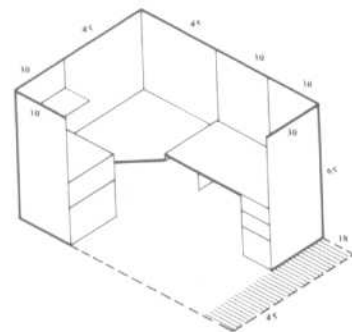
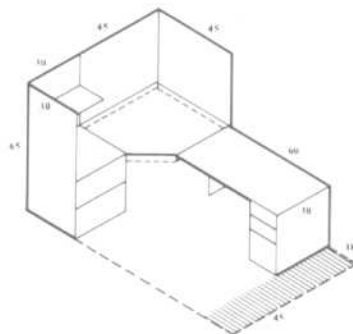


No  
30 x 45  
30 x 60  
(76 x 152 cm)  
1-2  
0-4

Guest chair  
Primary work surface  
Secondary work surface  
File drawers  
Shelves

**81 sq. ft.****Task Profile: Administrative Specialist/Secretarial.**

- Paper, material, or information processed, analyzed, and/or maintained.
- More than one task may be performed concurrently.
- Multiple reference sources may be used on a task.
- Reference materials used frequently.
- Electronic equipment may be used for easy reference, retrieval, keeping records current, inputting/maintaining data and records.
- If supervising, ability to see subordinates may be desirable to direct activities.
- If monitoring, visual access may be desirable.
- Moderate amount of storage required at the workspace, that is, casework, client accounts, supplies.



No  
45 x 45  
30 x 60  
3-4  
1-2

Guest chair  
Primary work surface  
Secondary work surface  
File drawers  
Shelves

**64 sq. ft.**



## ELECTRONIC WORKSTATIONS

**The Automated Task****Open**

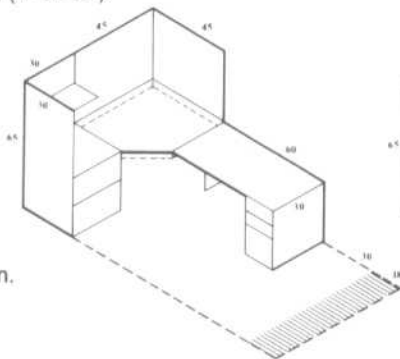
No requirement of equipment or task for privacy, concentration

**Screened**

Privacy required for reading, working, thinking, calculating, meetings, confidential phone calls, elimination of visual and acoustical distractions

**Task Profile: Administrative Specialist/Secretarial (+ Guest).**

- Paper, material, or information processed, analyzed, and/or maintained.
- More than one task performed concurrently.
- Multiple reference sources used on a task.
- Reference materials used frequently.
- Limited volume of supplies and permanent records kept at the workspace.
- Electronic equipment may be used for easy reference, retrieval, keeping records current
- Tasks are complex enough to require concentration.
- Extensive use of telephone and additional equipment such as desk-top printer and microfilm viewer may be required.
- Need to see and hear co-workers is secondary priority.
- Limited conferencing required at workspace.
- If supervising, ability to see subordinates may be desirable to direct activities.
- If monitoring, visual access may be desirable.



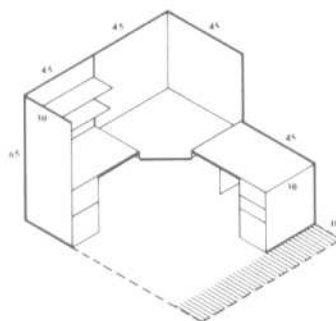
1  
45 x 45  
30 x 60  
3-4  
1-2

Guest chair  
Primary work surface  
Secondary work surface  
File drawers  
Shelves

80 sq. ft.

**Task Profile: Word Processing.**

- Time divided among administrative, processing paper, material, or information.
- More than one task may be performed concurrently.
- Multiple reference sources may be used on a task.
- Reference materials moderate but used frequently.
- Limited storage primarily for supplies.
- Ability to see and hear co-workers or subordinates is desirable.
- Typewriter and/or electronic equipment may be used to expedite processing and administrative tasks, for example, VDT, printer, transcriber, OCR, microfilm viewer, separate disk drives.



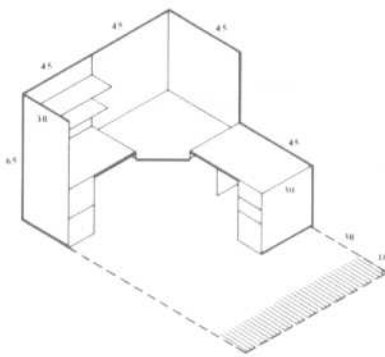
No  
45 x 45  
(114 x 114 cm)  
30 x 45  
(76 x 114 cm)  
3-4  
1-2

Guest chair  
Primary work surface  
Secondary work surface  
File drawers  
Shelves

67 sq. ft.

**Task Profile: Word Processing (+ Guest).**

- Time divided among administrative, processing paper, material, or information, and limited conferencing at workspace.
- More than one task may be performed concurrently.
- Multiple reference sources may be used on a task.
- Reference materials moderate but used frequently.
- Limited storage primarily for supplies.
- Typewriter and/or electronic equipment (VDT, printer, and so on) may be used to expedite processing and administrative tasks.
- Tasks are complex enough to require concentration for analysis, or heavy equipment operations require acoustical screening.
- Work surface needed for organization of work.



1  
45 x 45  
30 x 45  
3-4  
1-2

Guest chair  
Primary work surface  
Secondary work surface  
File drawers  
Shelves

86 sq. ft.



**The Automated Task****Open**

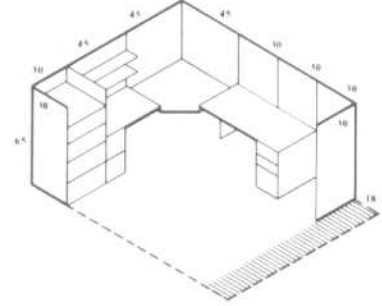
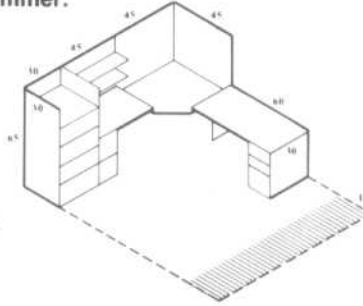
No requirement of equipment or task for privacy, concentration

**Screened**

Privacy required for reading, working, thinking, calculating, meetings, confidential phone calls, elimination of visual and acoustical distractions

**Task Profile: Technical/Systems Analyst/ Programmer.**

- Time divided among administrative, processing paper, material, or information, and limited conferencing at workspace.
- More than one task may be performed concurrently.
- Multiple reference sources may be used on a task.
- Reference materials may be extensive and used frequently.
- Ability to see and hear co-workers or subordinates desirable.
- Typewriter and electronic equipment (VDT, printer, and so on) may be used to expedite processing and administrative tasks.
- Moderate to extensive amount of storage required at the workspace for manuals, binders, computer printouts, coding sheets, supplies, permanent files, reference materials.



1  
45 x 45  
30 x 60  
(76 x 152 cm)  
6-8  
3-5

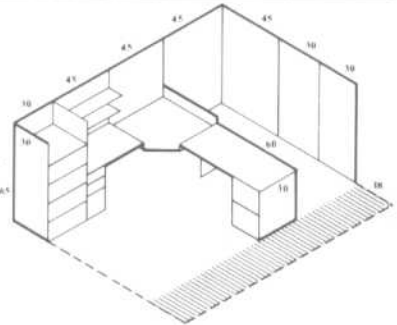
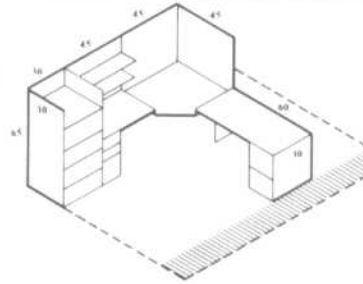
Guest chair  
Primary work surface  
Secondary work surface

File drawers  
Shelves

128 sq. ft.

**Task Profile: Administrative/Managerial.**

- Extensive conferencing at individual workspace.
- Analysis of reports, computerized materials, and so on.
- Varied tasks or projects performed simultaneously on an ongoing basis.
- Large amounts of storage extensively used.
- Storage for client/project files, reference manuals, documentation, correspondence.
- Telephone used extensively.
- Supervision of subordinates almost universal.
- Electronic equipment accommodation is secondary priority, used primarily for communication/electronic mail, scheduling.



2  
45 x 45  
30 x 60  
(76 x 152 cm)  
5-8  
3-5

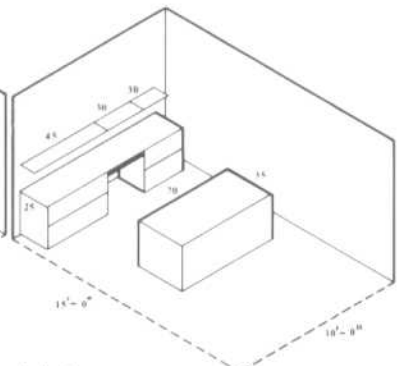
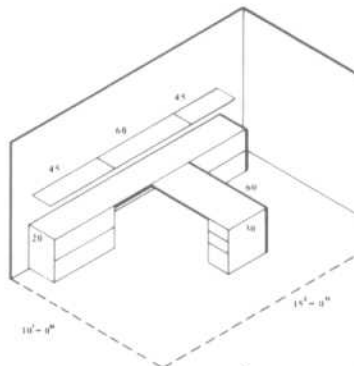
Guest chair  
Primary work surface  
Secondary work surface

File drawers  
Shelves

154 sq. ft.

**Task Profile: Administrative/Total Enclosure.**

- Extensive conferencing at individual workspace.
- Analysis of reports, computerized materials, and so on.
- Varied tasks on projects performed simultaneously on an ongoing basis.
- Large amounts of storage extensively used.
- Storage for client/project files, reference manuals, documentation, correspondence.
- Telephone used extensively.
- Supervision of subordinates almost universal.
- Electronic equipment accommodation is secondary priority, used primarily for communication/electronic mail, scheduling.
- Subject matter of job responsibilities requires confidentiality.



2  
30 x 60  
20 sq ft  
(15 sq m)  
5-8  
3-5

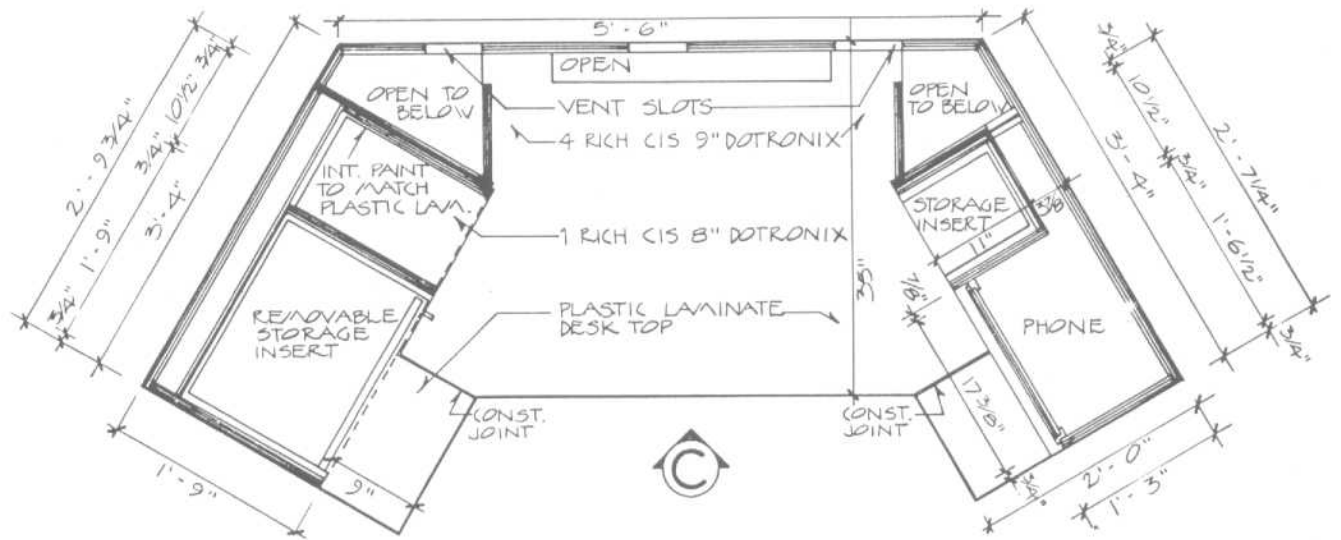
Guest chair  
Primary work surface  
Secondary work surface

File drawers  
Shelves

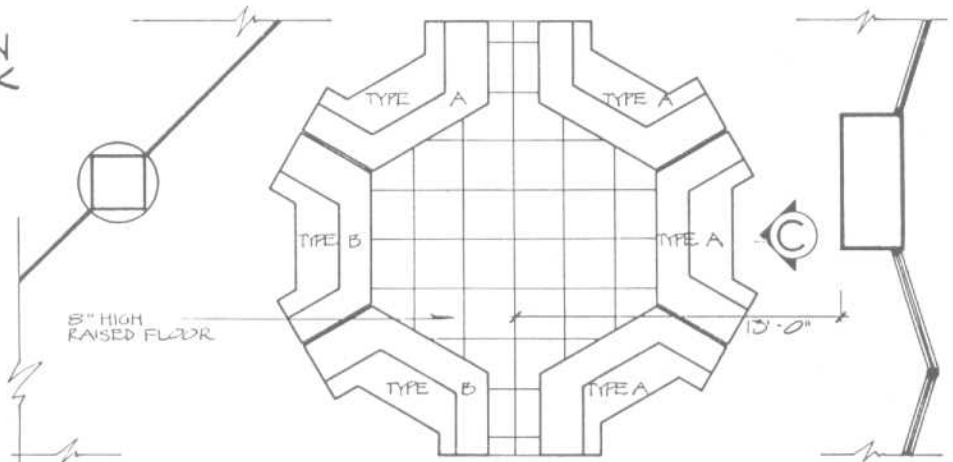
150 sq. ft.

**ELECTRONIC WORKSTATIONS**

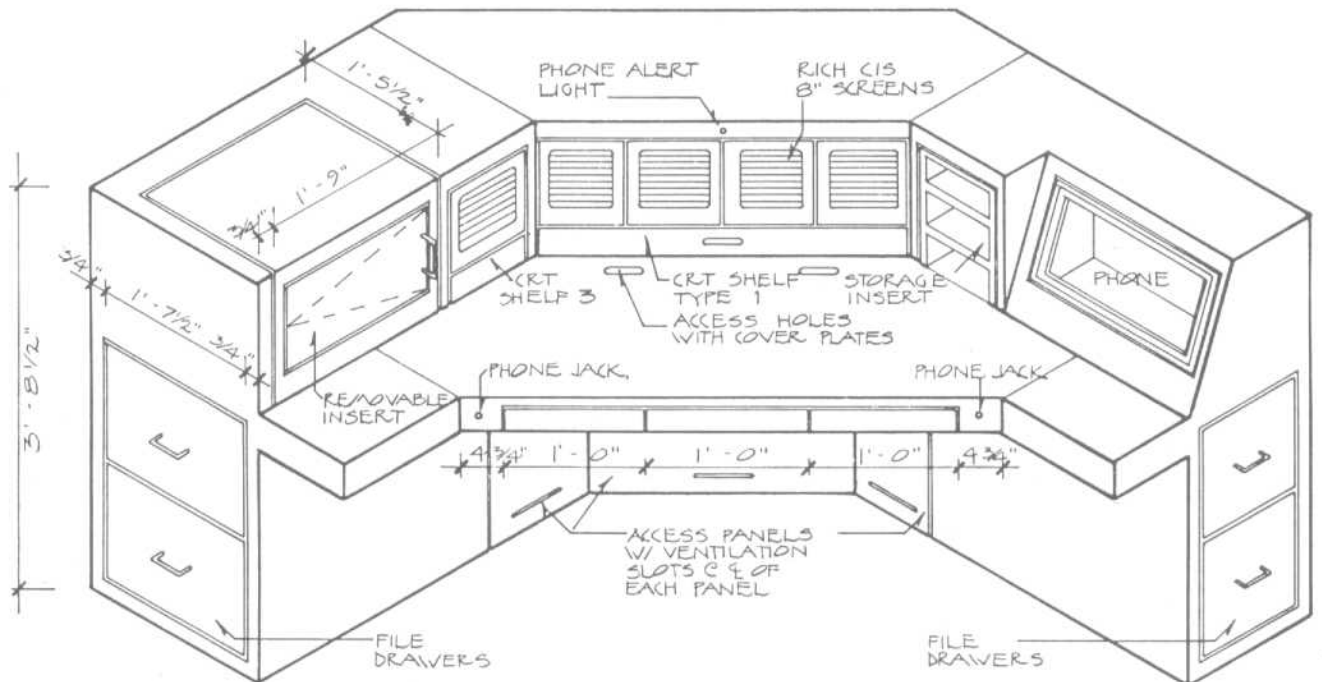
Trading Desk Details



**A** PLAN / SECTION TRADING DESK TYPE 'A'



**B** PLAN - 20TH FLOOR TRADING ROOM

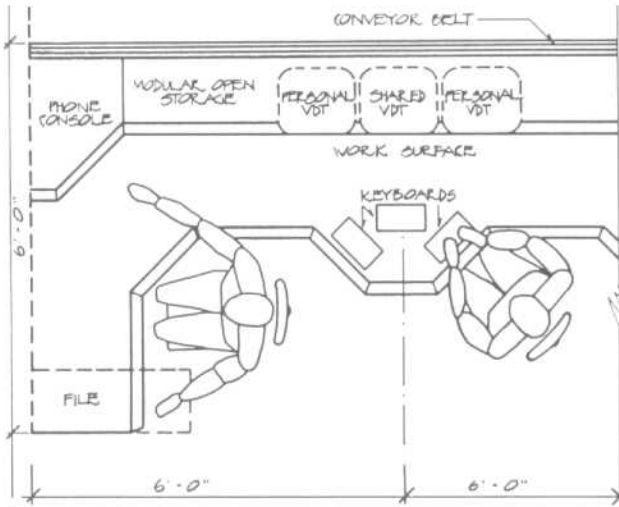


**C** FRONT VIEW - TRADING DESK TYPE 'A'

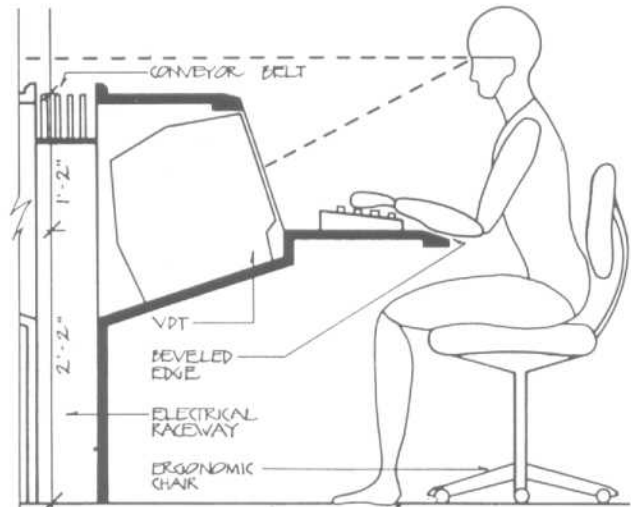
Fig. 2 Technologically and electronically complex trading desks must be ergonomically correct in every respect. With little, if any, margin for error when designing and detailing multiple workstations of this type, a full-size mockup is always required.

ELECTRONIC WORKSTATIONS

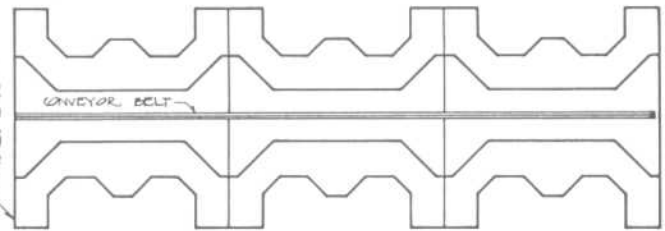
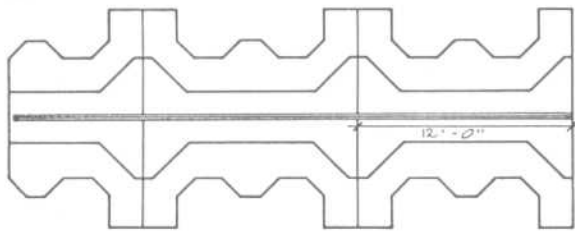
Trading Desk Details



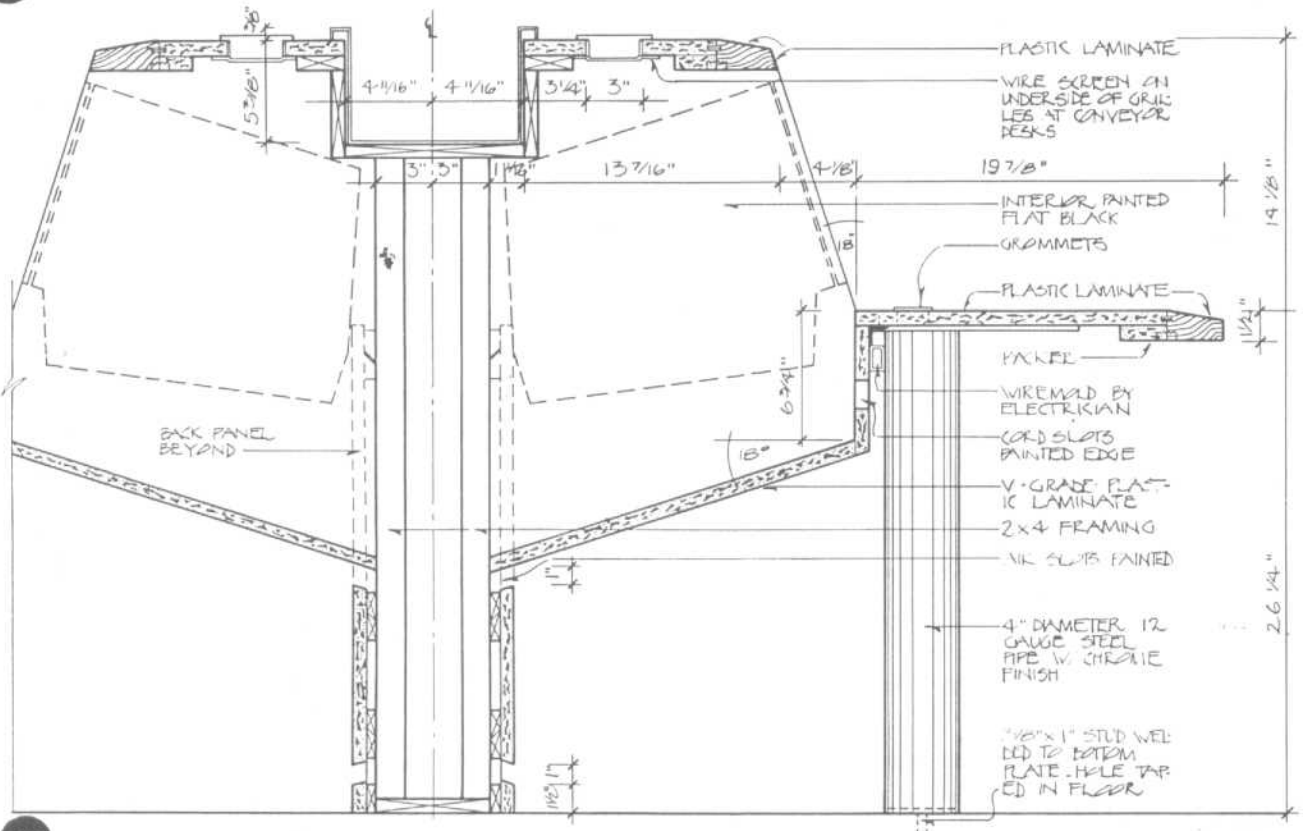
**A** ERGONOMICS FACTORS - PLAN



**C** ELEVATION/SECTION



**B** TYPICAL PLAN LAYOUT



**DD** SECTION THRU TYPICAL DESK



## CONFERENCE ROOMS

Planning Data: Table Sizes and Seating Capacities

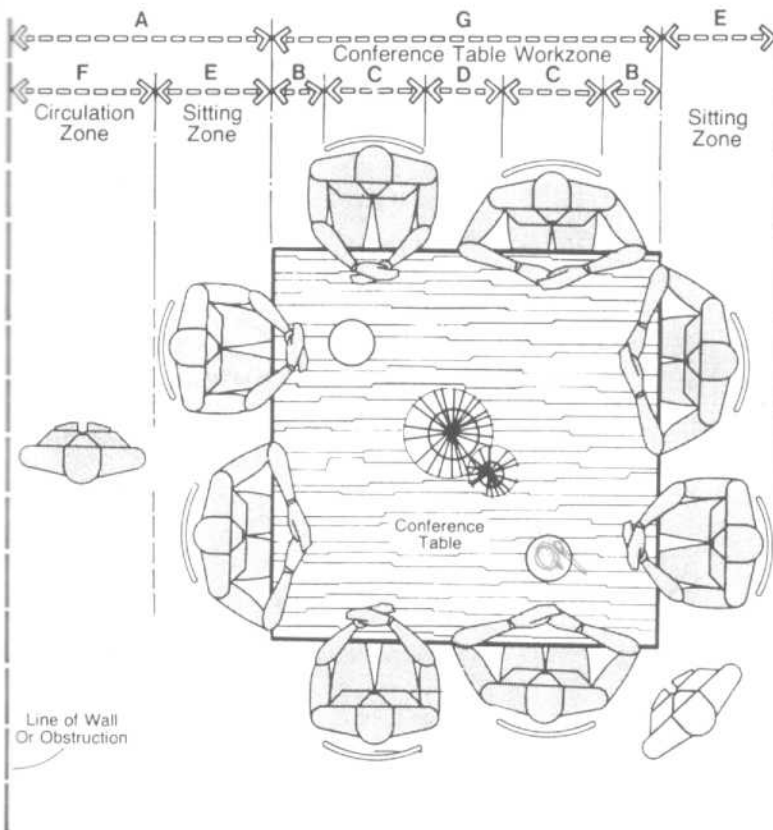


Fig. 1 Square conference table.

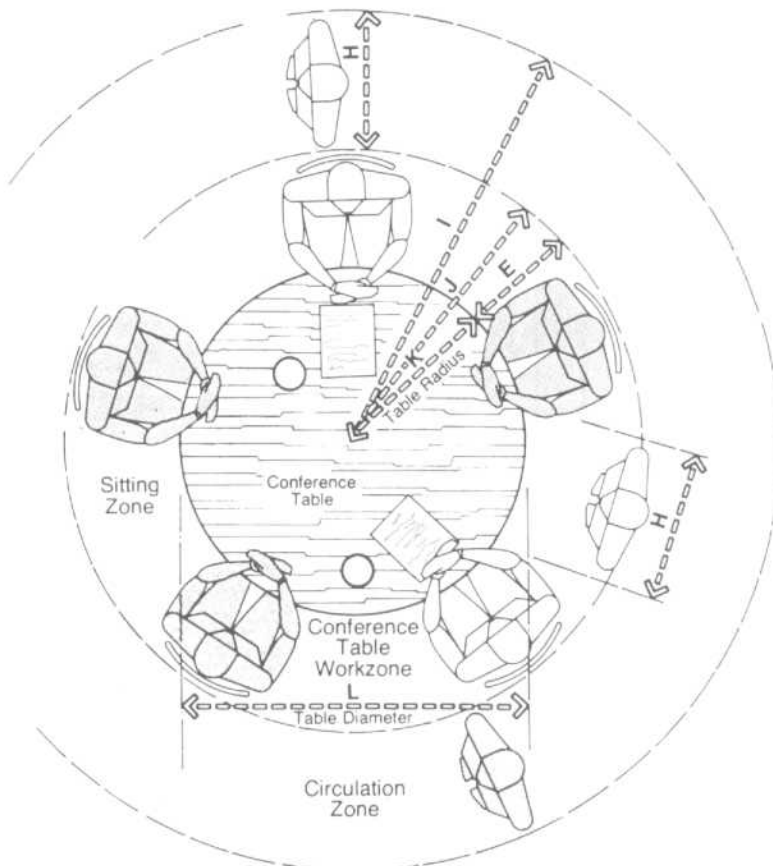


Fig. 2 Circular conference table.

Consideration must be given to clearances and circulation around the larger conference table, as indicated in Figs. 1 and 2. A minimum of 48 in, or 121.9 cm, is suggested from the edge of the table to the wall or nearest obstruction. This dimension under ordinary circumstance allows for a circulation zone beyond the sitting zone of 30 to 36 in, or 76.2 to 91.4 cm, based upon a maximum body breadth measurement of the larger person. The greater dimension is recommended to allow for the chair in a pulled-out position.

The actual dimensions of the conference table are a function of the number of people to be seated. The square table illustrated in Fig. 1 provides for eight people, with each side ranging from 54 to 60 in, or 137.2 to 152.4 cm. The larger dimension is more appropriate to accommodate people of larger body size and to allow for a more generous work zone for each person. This translates into 30 in, or 76.2 cm, per person, which constitutes a comfortable perimeter allocation. The circular table shown in Fig. 2 comfortably accommodates five people while allowing for a 30-in, or 76.2-cm, access zone between chairs. To accommodate both sitting zone and circulation zone, a space with a radius ranging from 72 to 81 in, or 182.9 to 205.7 cm, must be provided.

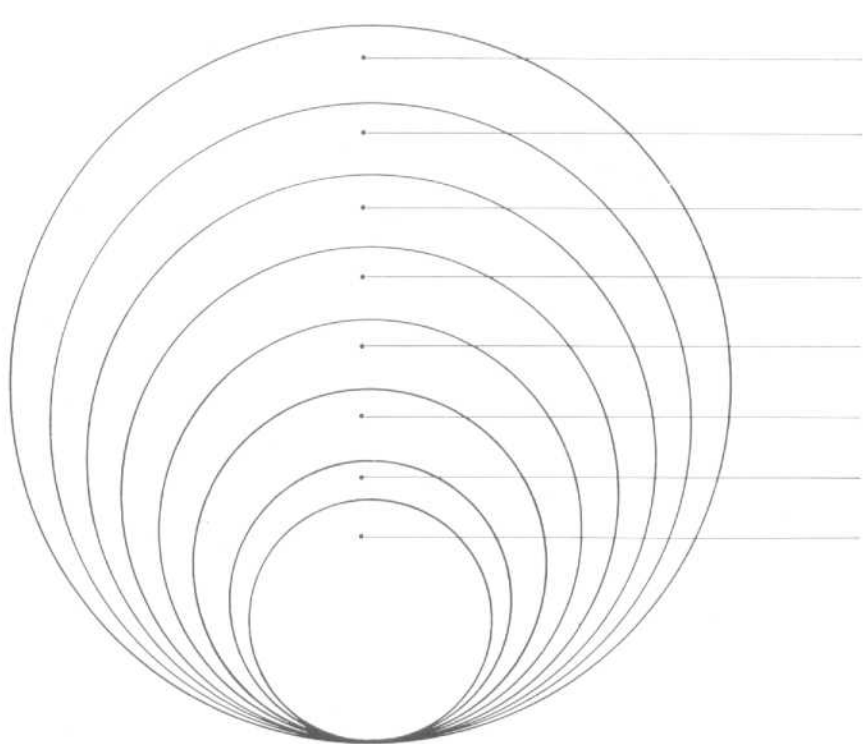
	in	cm
A	48–60	121.9–152.4
B	4–6	10.2–15.2
C	20–24	50.8–61.0
D	6–10	15.2–25.4
E	18–24	45.7–61.0
F	30–36	76.2–91.4
G	54–60	137.2–152.4
H	30	76.2
I	72–81	182.9–205.7
J	42–51	106.7–129.5
K	24–27	61.0–68.6
L	48–54	121.9–137.2

## CONFERENCE ROOMS

### Planning Data: Table Sizes and Seating Capacities

Round conference tables offer the advantages of intimacy, "equality," and compactness. On the other hand, if status is an issue, or if one wall within the space is an audiovisual wall, this table shape can be less than satisfactory. The same problems can arise with a square conference table. In both instances, however, the total seating around each table shape must be viewed in the context of chair size, chair spacing, and tasks to be performed at the table.

### ROUND TABLES



Diam.	Circum.	Approx. Seating	Recommended Minimum Room Size
10'0"	31'5"	12-15	20'0" x 20'0"
9'0"	28'2"	11-14	19'0" x 19'0"
8'0"	25'1"	10-12	18'3" x 18'3"
7'0"	22'0"	9-11	16'0" x 16'0"
6'0"	18'10"	8-9	14'6" x 14'6"
5'0"	15'9"	7-8	13'0" x 13'0"
4'0"	12'6"	5-6	11'6" x 11'6"
3'6"	11'0"	4-5	10'6" x 10'6"

### SQUARE TABLES



W	L	Approx. Seating	Recommended Minimum Room Size
5'0"	5'0"	8-12	13'0" x 13'0"
4'6"	4'6"	4-8	12'0" x 12'0"
4'0"	4'0"	4-8	11'6" x 11'6"
3'6"	3'6"	4	10'6" x 10'6"
3'0"	3'0"	4	9'0" x 9'0"

**CONFERENCE ROOMS**

Planning Data: Table Sizes and Seating Capacities

Rectangular and boat-shaped conference tables lend themselves toward formal settings where status and hierarchy are important. Both table shapes are also more suitable in a room where an audiovisual wall is placed at one end of the space, or where speakers are making presentations. The boat-shaped table also offers greater visibility of others seated at the table, as well as ease of circulation around its perimeter.

**RECTANGULAR TABLES**

W	L	Approx. Seating	Recommended Minimum Room Size
6'0"	28'0"	28-30	18'0" x 40'0" <i>5496 x 12192</i>
6'0"	26'0"	26-28	18'0" x 38'0"
6'0"	24'0"	24-26	18'0" x 36'0"
5'0"	22'0"	22-24	15'0" x 32'0"
5'0"	20'0"	20-22	15'0" x 30'0"
4'6"	18'0"	18-20	13'6" x 27'0"
4'6"	16'0"	16-18	13'6" x 25'0"
4'6"	14'0"	14-16	13'6" x 23'0"
4'0"	13'0"	12-14	12'0" x 21'0"
4'0"	12'0"	12-14	12'0" x 20'0"
4'0"	11'0"	10-12	12'0" x 19'0"
4'0"	10'0"	10-12	12'0" x 17'0"
4'0"	9'6"	8-10	12'0" x 16'6"
3'6"	9'0"	8-10	10'6" x 16'0"
3'6"	8'6"	8-10	10'6" x 15'6"
3'6"	8'0"	8-10	10'6" x 15'0"
3'6"	7'6"	6-8	10'6" x 14'6"
3'6"	7'0"	6-8	10'6" x 14'0"
3'0"	6'6"	6-8	10'0" x 13'6"
3'0"	6'0"	6-8	10'0" x 13'0"
2'6"	5'6"	4-6	9'0" x 12'6"
2'6"	5'0"	4-6	9'0" x 12'0"

**BOAT SHAPED TABLES**

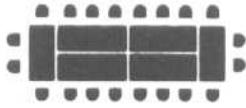
3'5"	8'0"	8-10	10'0" x 15'0"
3'8"	9'0"	8-10	11'0" x 16'0"
3'11"	10'0"	10-12	12'0" x 17'0"
4'3"	11'0"	10-12	13'0" x 19'0"
4'7"	12'0"	12-14	14'0" x 21'0"
4'11"	14'0"	14-16	15'0" x 23'0"
5'3"	16'0"	16-18	16'0" x 26'0"
5'7"	18'0"	20-22	17'0" x 29'0"
6'0"	20'0"	20-24	18'0" x 32'0"

**CONFERENCE ROOMS**

Planning Data: Table Sizes and Seating Capacities

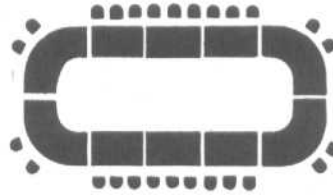
**CONFERENCE/MEETING ROOMS**

**Solid Conference**  
For 20 people



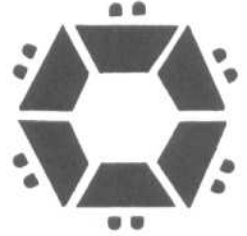
4-30"x72" tables  
2-30"x 60" tables

**Race Track**  
For 26 people



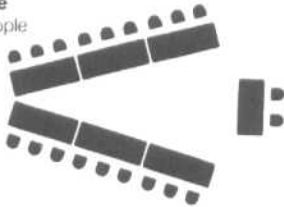
6-30"x72" tables  
4-30" wide crescents

**Trapezoid/Round**  
For 12 people

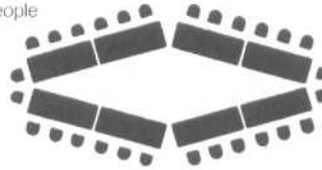


6-30"x30"x30"x 60" tables

**V-Shape**  
For 20 people



**Boat Shape**  
For 28 people



**BANQUET ROOMS**

**60" diameter tables**  
Capacity: 180 people

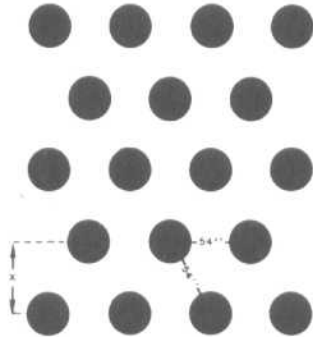


Table Size	Capacity	Centerline Spread*
48" dia.	6 persons	7'5"
54" dia.	6-8 persons	7'10"
60" dia.	8-10 persons	8'3"
66" dia.	10 persons	8'8"
72" dia.	10-12 persons	9'1"

**30" x 96" tables**  
Capacity: 180 people

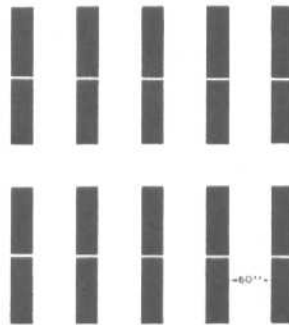


Table Size	Capacity
30"x48"	4-6 persons
30"x60"	6 persons
30"x72"	8 persons
30"x96"	10 persons

**18" x 72" classroom style tables**  
Capacity: 162 people

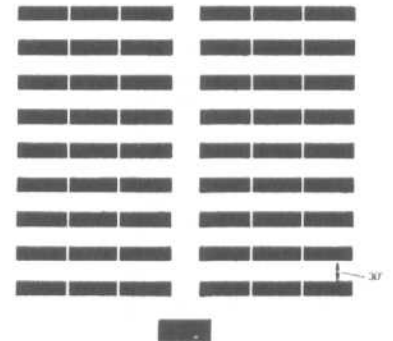


Table Size	Capacity
18"x60"	2 persons
18"x72"	3 persons
18"x96"	4 persons



CONFERENCE ROOMS

Planning Data: Table Sizes and Seating Capacities

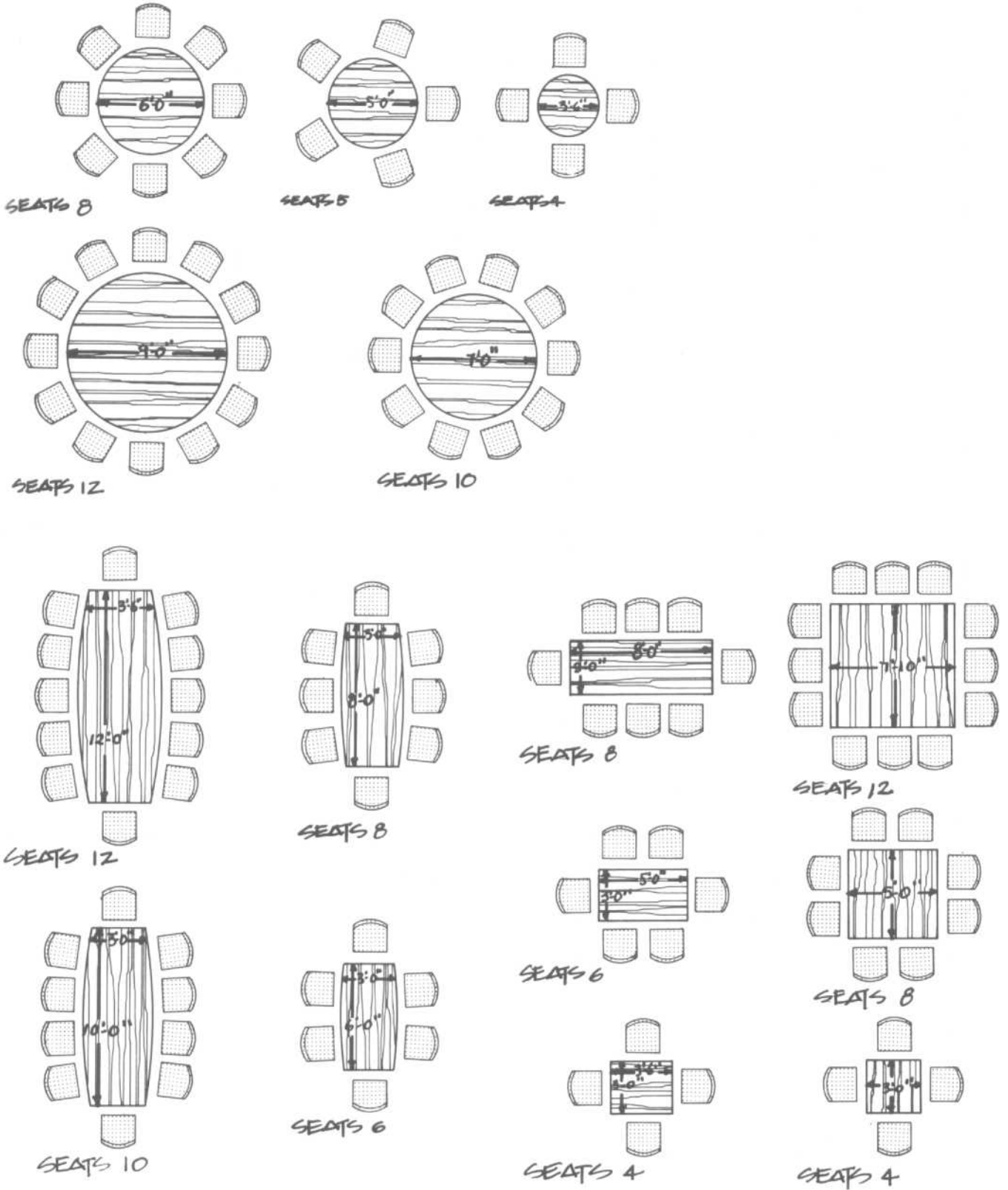
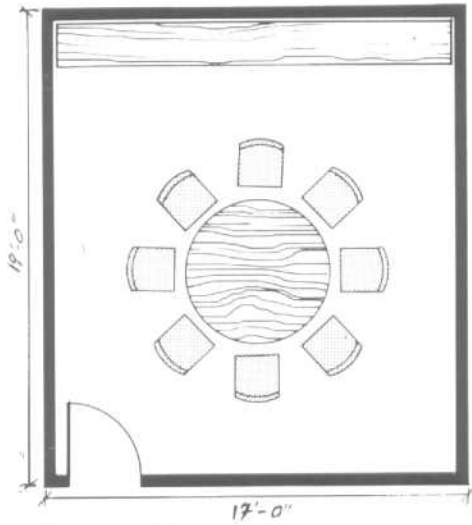


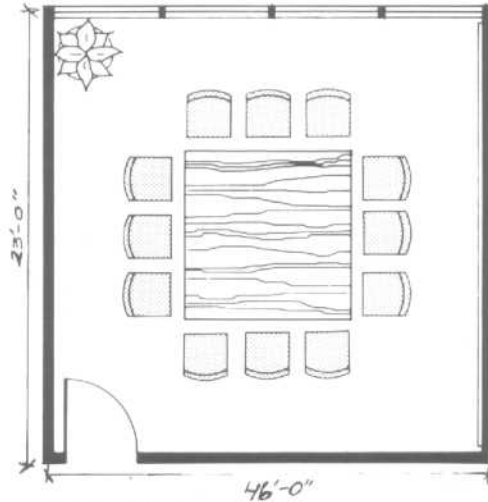
Fig. 3 These conference tables are useful in making initial space planning allocations.

CONFERENCE ROOMS

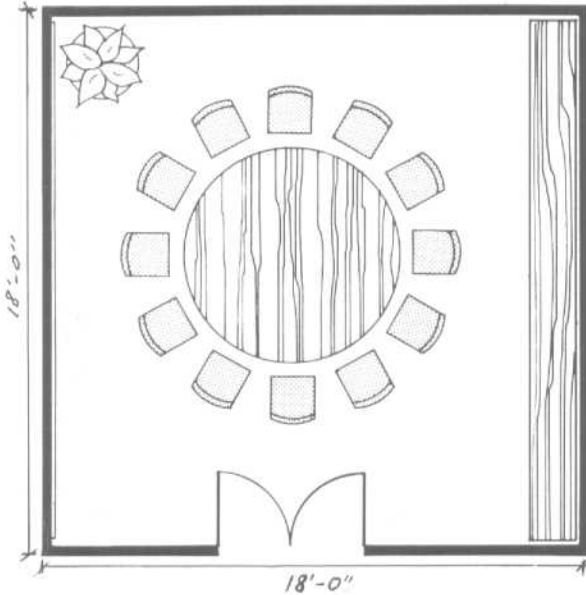
Planning Data: Table Sizes and Seating Capacities



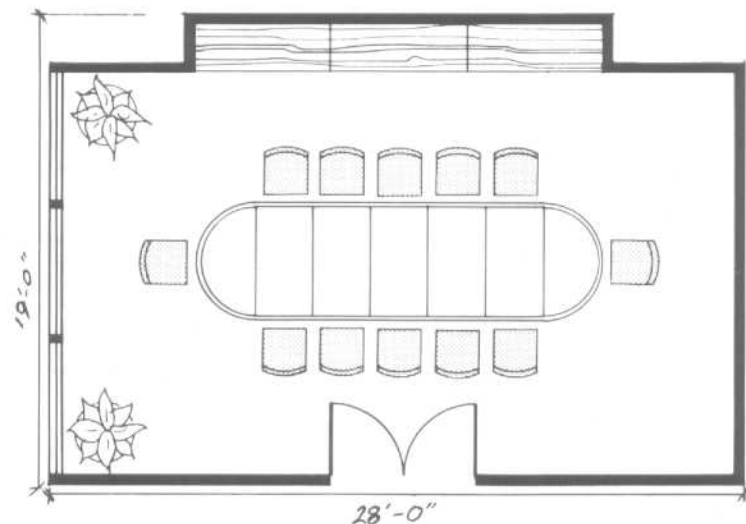
Seats 8, 323 ft<sup>2</sup>



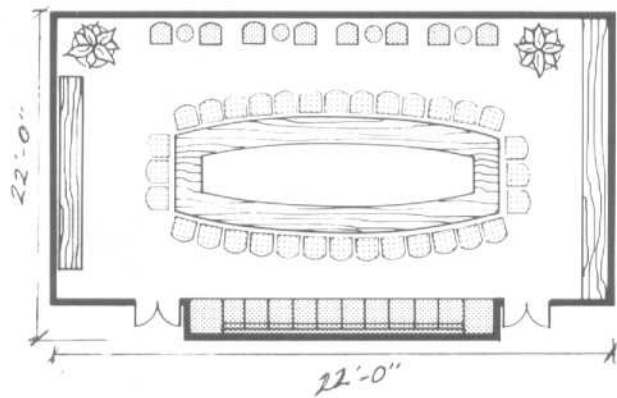
Seats 12, 324 ft<sup>2</sup>



Seats 12, 484 ft<sup>2</sup>



Seats 12, 532 ft<sup>2</sup>

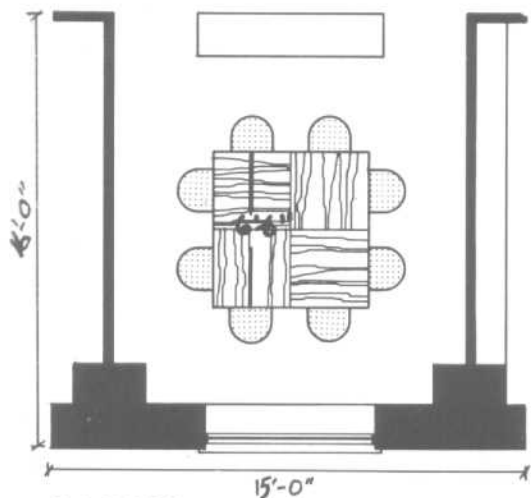


Seats 50, 1058 ft<sup>2</sup>

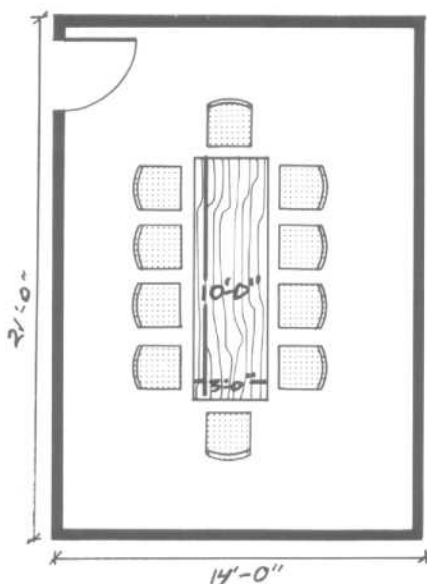
Fig. 4 These drawings provide the designer with a variety of conference room sizes, table shapes, floor areas, and seating capacities. They are useful in client discussions and in making preliminary area allocations. Chair size and circulation areas behind the chairs will, of course, cause overall dimensions to vary.

CONFERENCE ROOMS

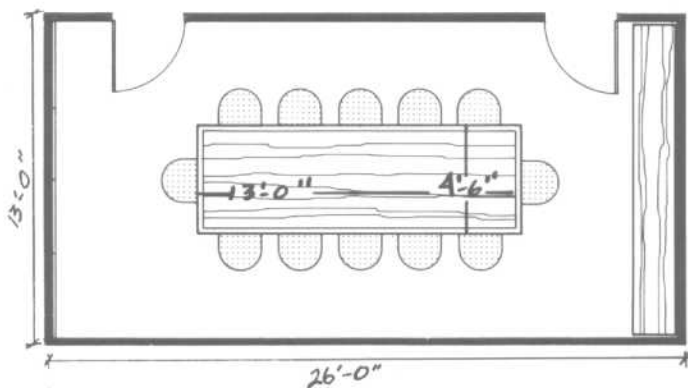
Planning Data: Room Layouts



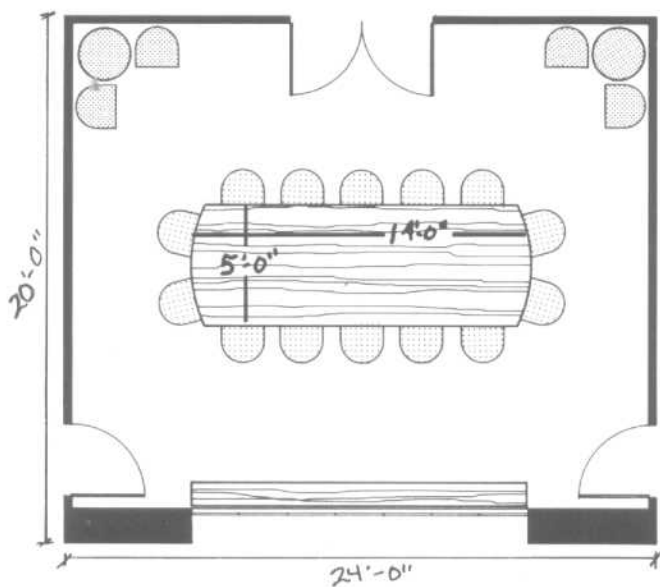
Seats 8, 272 ft<sup>2</sup>



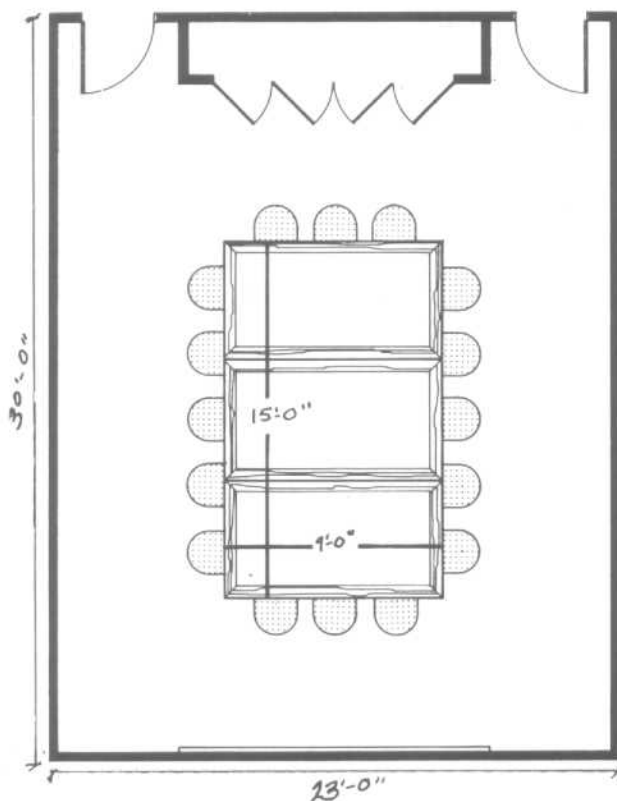
Seats 10, 294 ft<sup>2</sup>



Seats 12, 338 ft<sup>2</sup>



Seats 18, 480 ft<sup>2</sup>



Seats 16, 690 ft<sup>2</sup>

CONFERENCE ROOMS

Table Base and Edge Treatments

It is important for the designer to understand and appreciate some of the important details that make up a conference table. The base treatments shown in Fig. 5 are but a few of the myriad possibilities. Perhaps even more important to consider are the finished edges of glass and wood conference tables, representative details of which are shown in Figs. 6 and 7. Other edge details could be made of marble, granite, or even leather. Fingers, hands, and arms make intimate contact with these edge details, something that should be carefully considered.

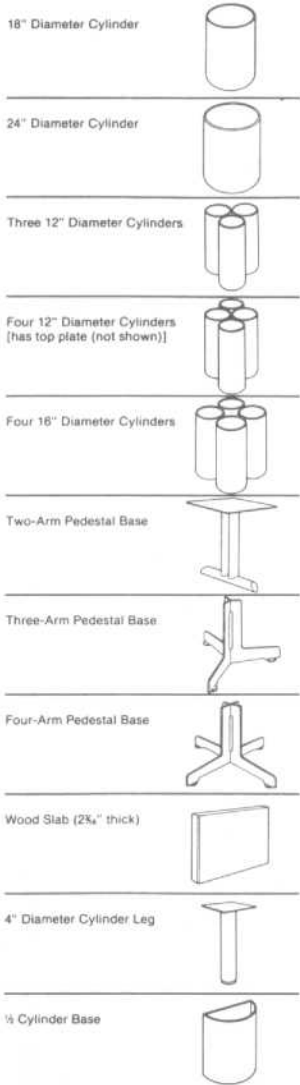


Fig. 5 Base treatment.

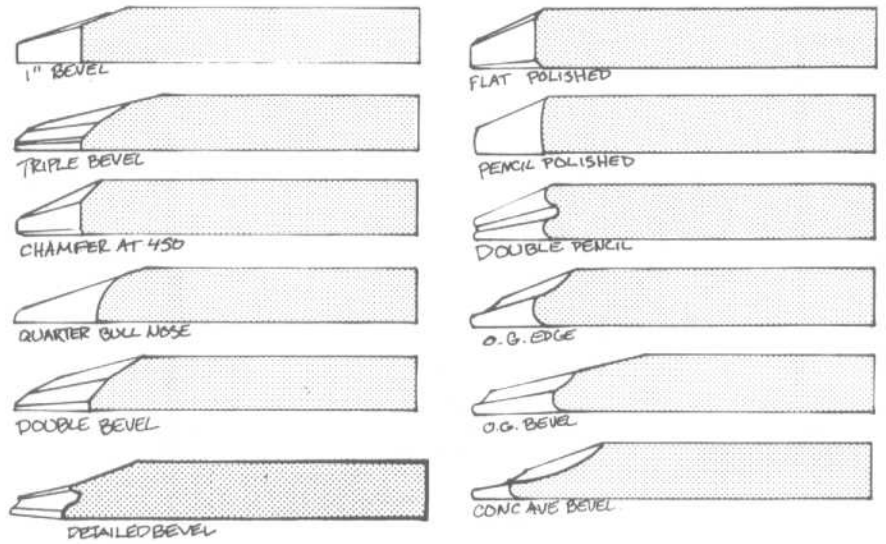


Fig. 6 Glass edge treatment.

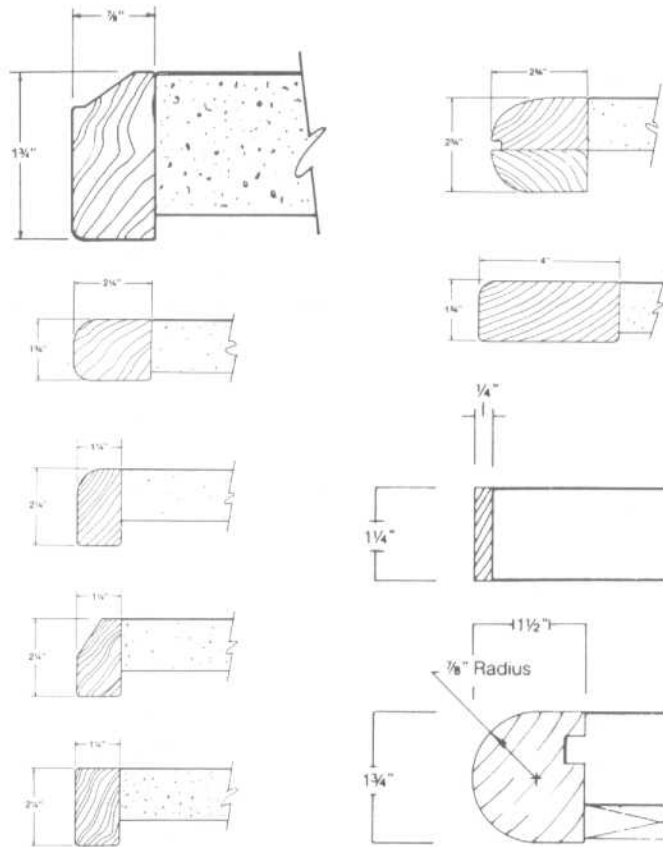
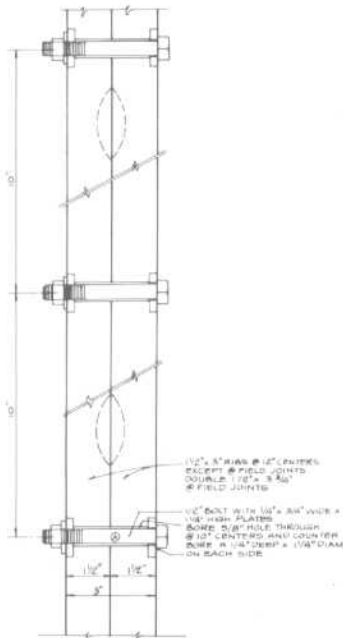


Fig. 7 Wood edge treatment.

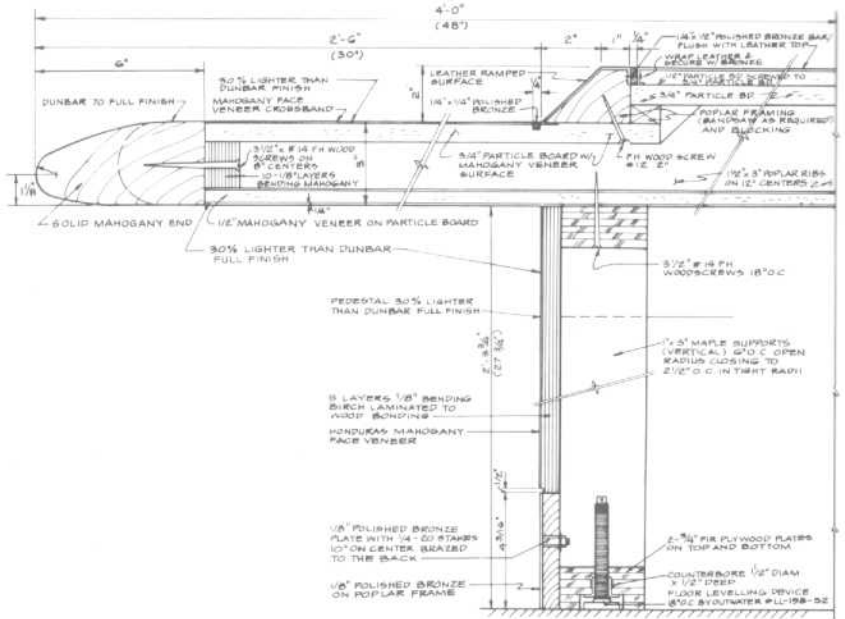


CONFERENCE ROOMS

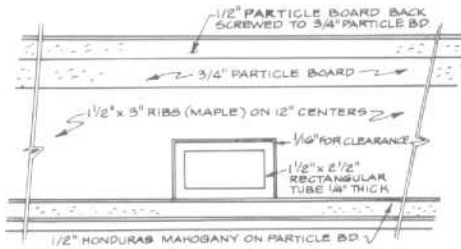
Conference Table Details



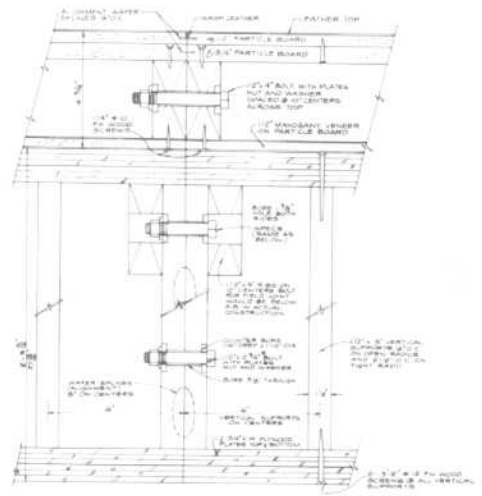
TOP SECTION @ FIELD JOINT CONFERENCE TABLE



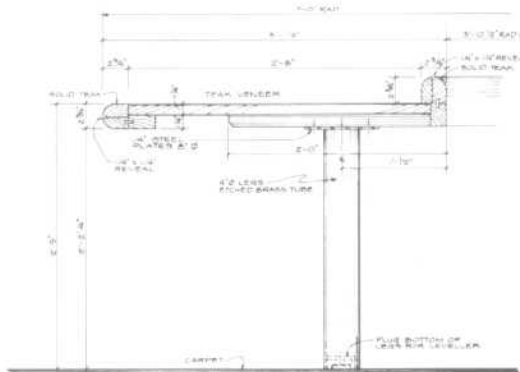
TYPICAL SECTION CONFERENCE TABLE



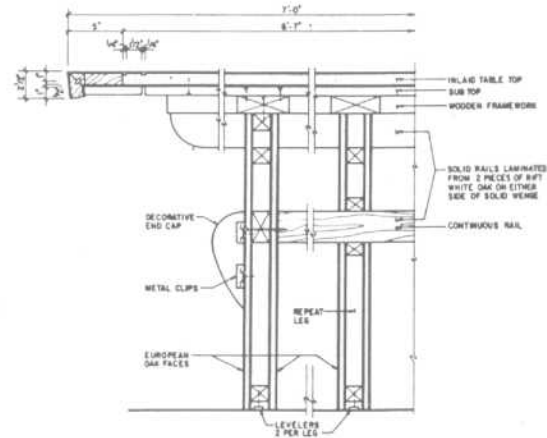
SECTION THROUGH SUPPORT FRAME



FIELD JOINT SIDE SECTION CONFERENCE TABLE



SECTION AT CONFERENCE TABLE

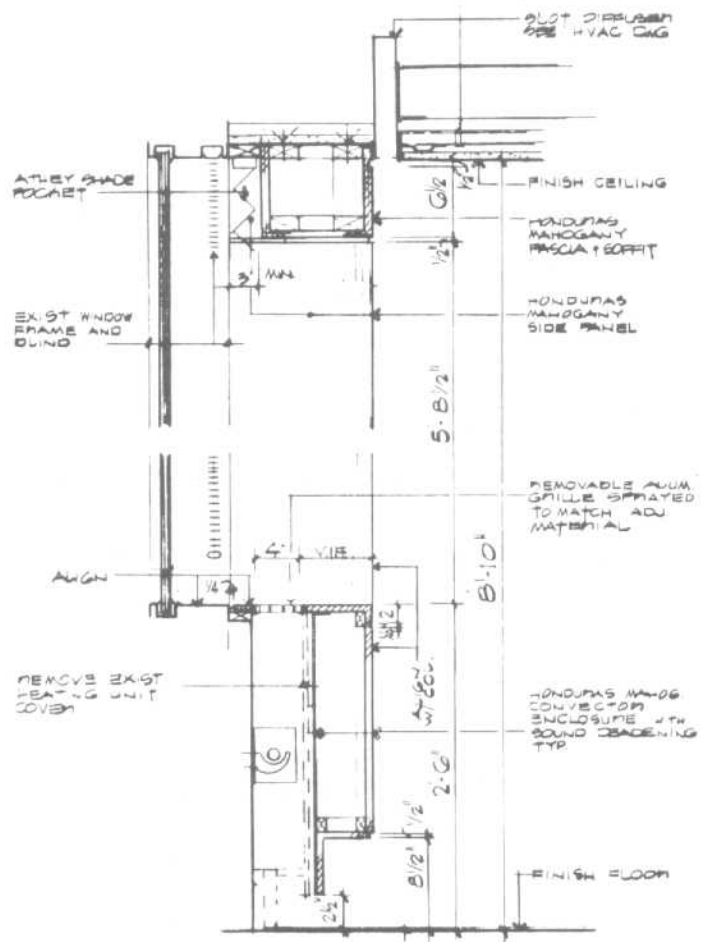
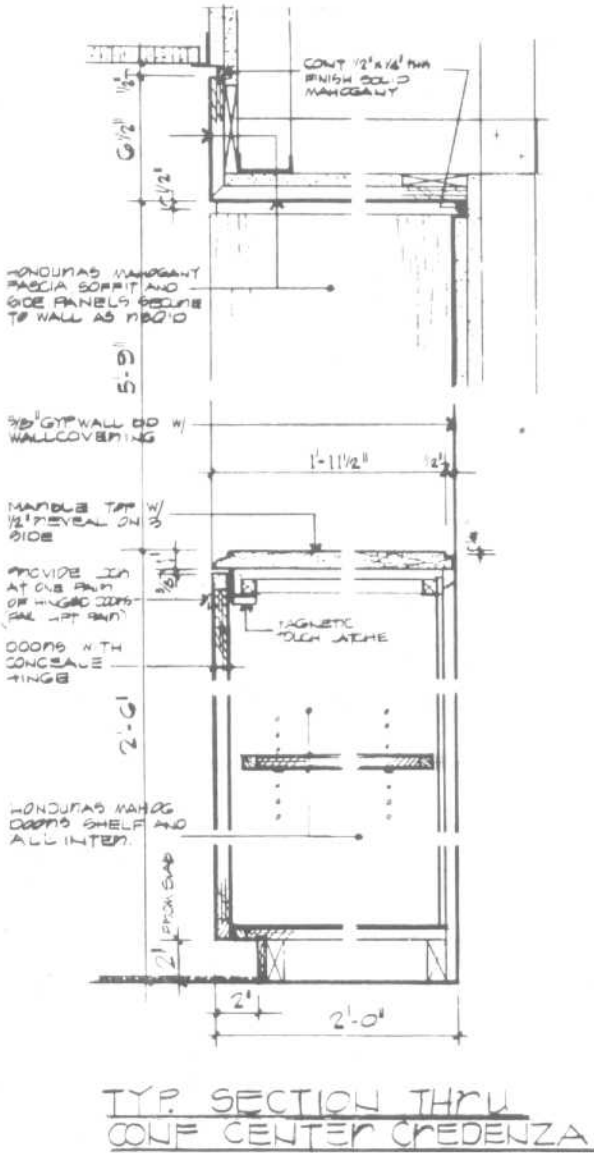


SECTION AT CONFERENCE TABLE

CONFERENCE ROOMS

Credenzas and Heating Unit Enclosures

Custom credenza units are often designed to complement the details of a conference table. They serve multiple functions, including storage, incorporation of electronic media equipment, display, and as a work surface. In addition, architectural woodwork is used to enclose existing convector covers and to frame window openings. It is important for the designer to consider providing ease of access to the heating and air-handling elements behind the woodwork, as well as allowing the appropriate flow of air.



## RECEPTION AREAS

## Planning Data: Receptionist's Workstation

Proper design of the reception area is critical in communicating an organization's desired corporate image. Reception spaces are both the first and last areas with which the visitor interacts and, accordingly, have considerable visual impact in communicating that image.

Not only must the reception space look attractive, but it must function properly as well. The two most important planning elements in this regard are the visitor's seating area and the receptionist's workstation or desk.

While most of the examples in this part are drawn from corporate interiors, the designer is urged to take into consideration the needs of special user groups who must interact with a receptionist. If small children are to communicate (or see or be seen), how high is the privacy wall? If a wheelchair-bound user is to approach the reception desk, is there room for the footrests to be accommodated? The designer must consider all user populations.

This part deals primarily with basic planning data relative to the design of a receptionist's workstation and furniture arrangements of the seating areas. Also included are related details directly from the working drawings of design firms.

For the purpose of privacy or security, the receptionist's workstation is often an area physically separated by built-in furniture and/or partitions. Figure 1 shows a counter height receptionist's workstation. While the relationship of worksurface to seat height is key, other anthropometric considerations are eye height and sitting height normal. The minimum height of the opening above the floor has been established at 78 in, or 198.1 cm. Sitting height and eye height are significant in providing unobstructed vision. Figure 2 de-

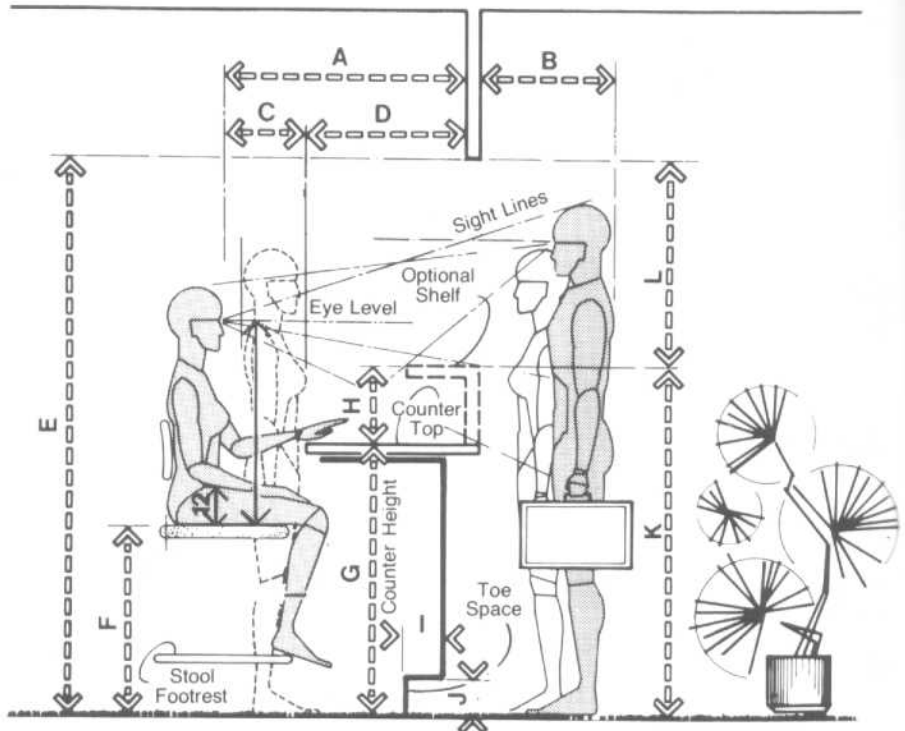


Fig. 1 Receptionist's workstation/counter height.

picts a desk height receptionist's workstation. The depth of the worksurface ranges from 26 to 30 in, or 66 to 76.2 cm, allowing for thumb tip reach required for the exchange of

papers and packages. Both Figs. 1 and 2 show in broken line an added counter top element often provided for security or as a visual screen of the work surface top.

	in	cm
A	40-48	101.6-121.9
B	24 min.	61.0 min.
C	18	45.7
D	22-30	55.9-76.2
E	78 min.	198.1 min.
F	24-27	61.0-68.6
G	36-39	91.4-99.1
H	8-9	20.3-22.9
I	2-4	5.1-10.2
J	4	10.2
K	44-48	111.8-121.9
L	34 min.	86.4 min.
M	44-48	111.8-121.9
N	54	137.2
O	26-30	66.0-76.2
P	24	61.0
Q	30	76.2
R	15-18	38.1-45.7
S	29-30	73.7-76.2
T	10-12	25.4-30.5
U	6-9	15.2-22.9
V	39-42	99.1-106.7

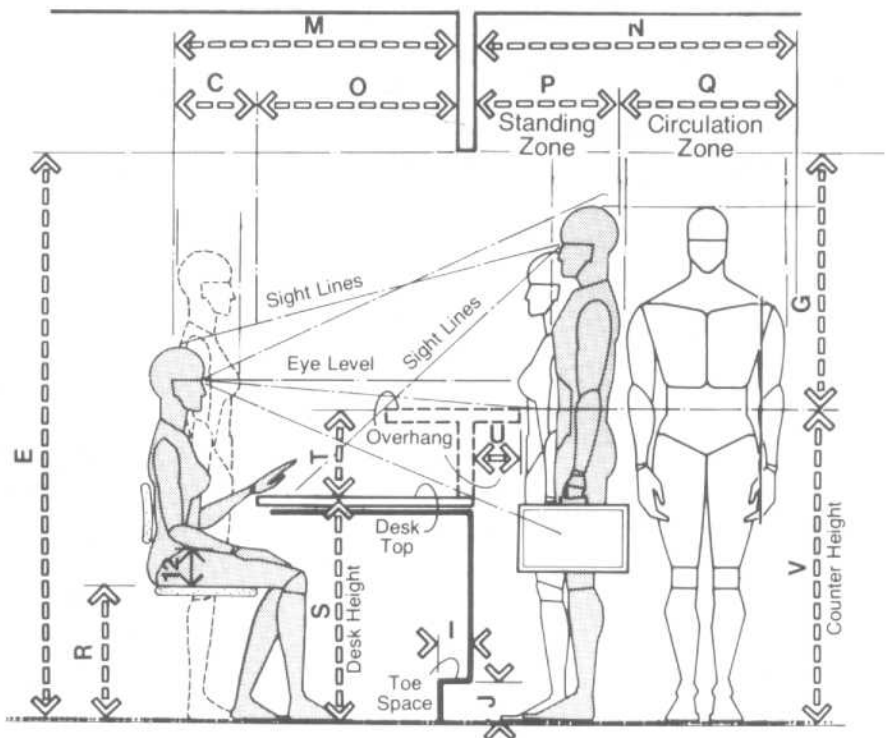


Fig. 2 Receptionist's workstation/desk height.



## RECEPTION AREAS

Planning Data: Seating Arrangements

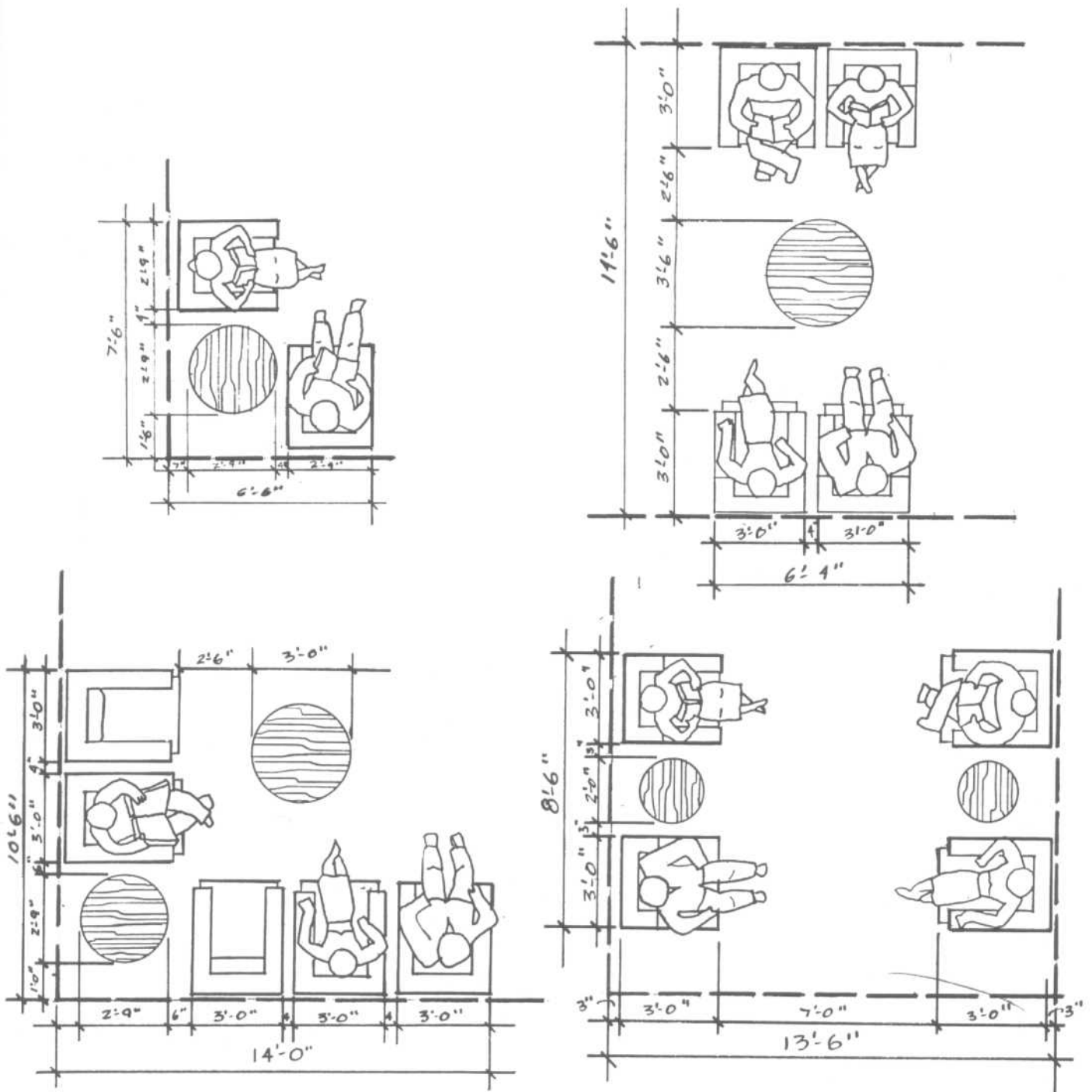
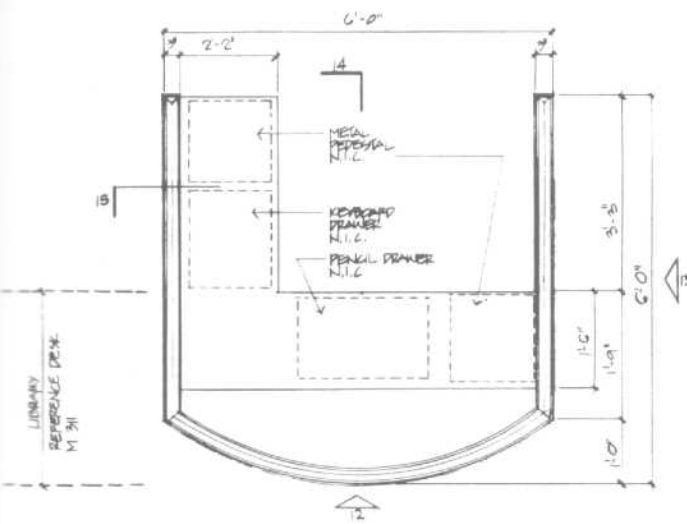


Fig. 3 The seating arrangements illustrated here provide some typical conditions that the designer must address. Individual seats are preferred over sofas. Corner seating arrangements must always consider leg clearance. Circulation between low tables and the edges of chairs must be adequate to allow for the legs of persons seated in the chairs. Convenient locations for side tables, so that magazines, ashtrays, artwork, or portable lighting can be placed on them, are important.



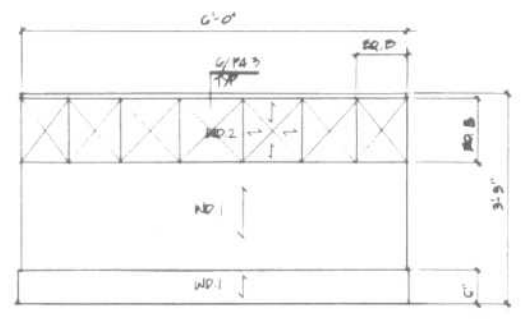
RECEPTION AREAS

Reception Desk Details

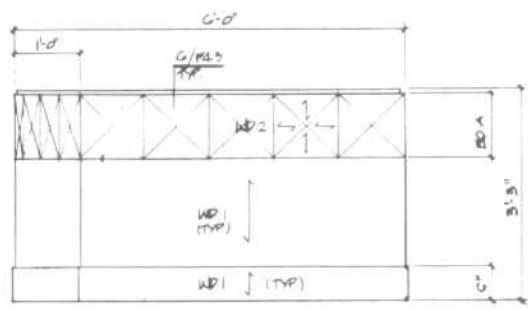


11 PLAN - M 305

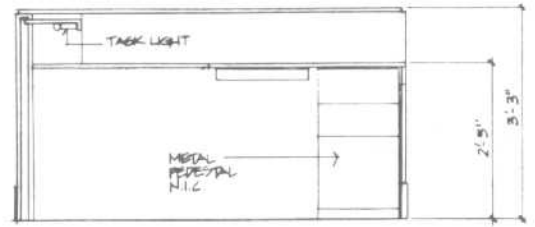
AS SHOWN @  
M. 305, NO  
DIAMOND PATTERN  
G.M. 311. VERTICAL  
WD-2 ONLY.



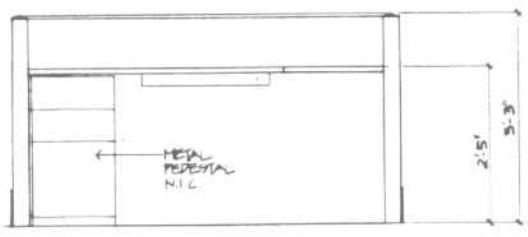
12 ELEVATION



13 ELEVATION - LEFT



14 SECTION -



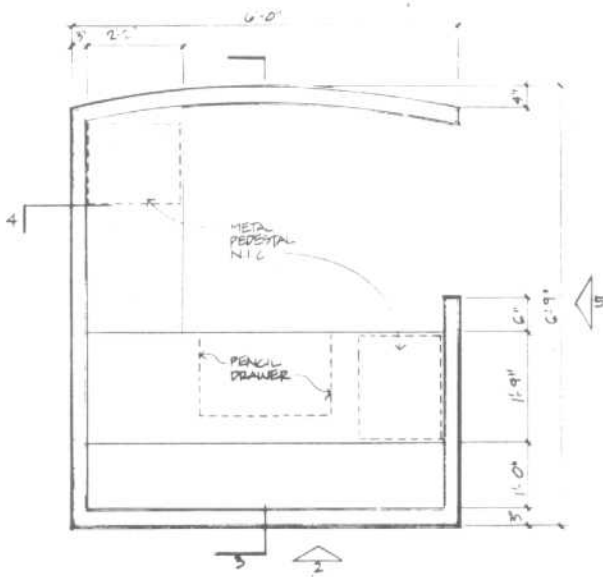
15 SECTION -

M. 311  
M. 305

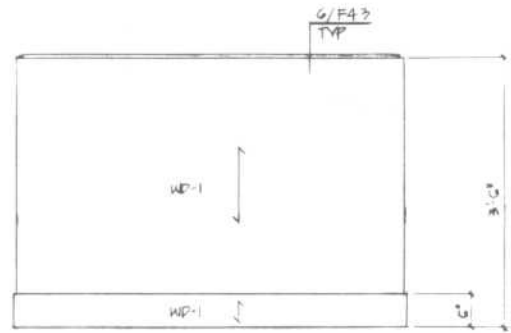
Fig. 5 More privacy can be achieved in the design of a reception desk when there is enclosure on three sides, as is shown here. When designing custom reception desks, it is important to fully understand the tasks that the person working there will be asked to perform, in order to provide for adequate storage, work surfaces at the appropriate height, the incorporation of electronic equipment, and task lighting.

RECEPTION AREAS

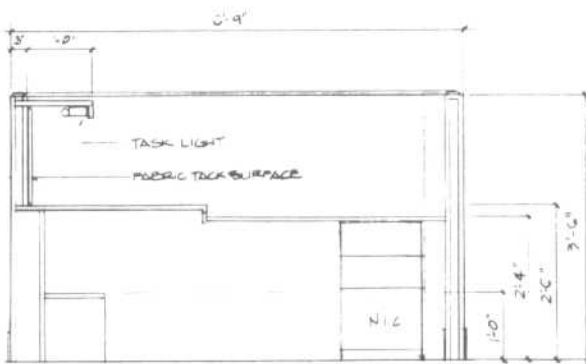
Reception Desk Details



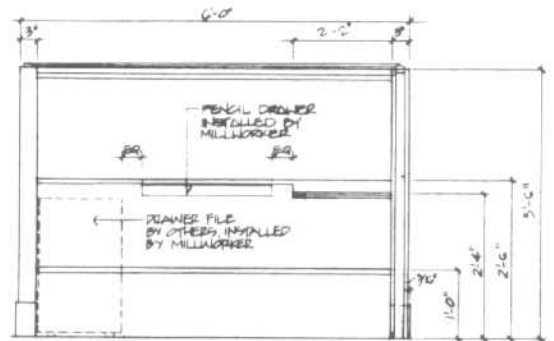
1 PLAN M.300



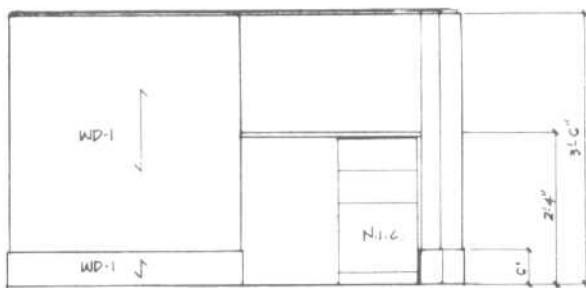
2 ELEVATION - FRONT



3 SECTION-

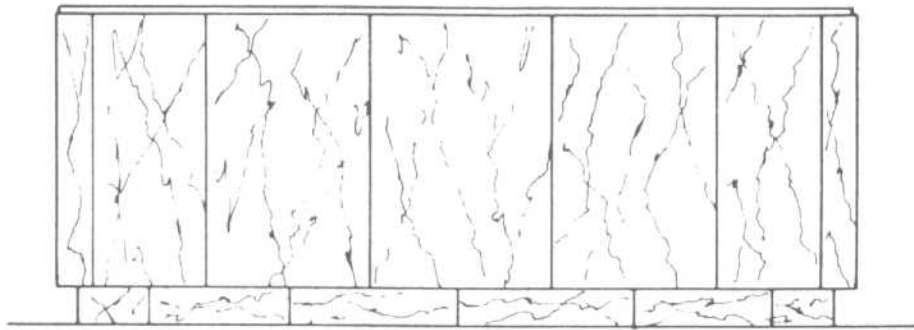


4 SECTION-

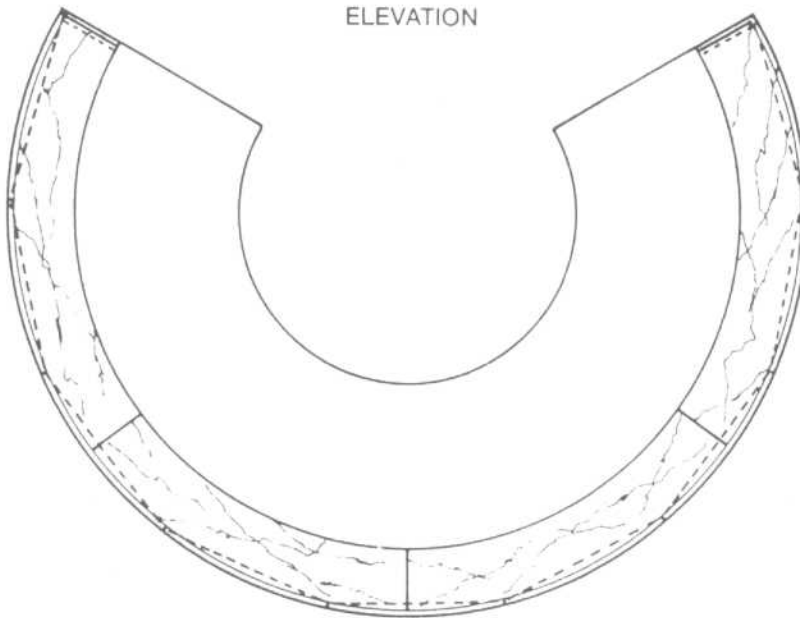


5 ELEVATION - LEFT

Fig. 6 The reception desk shown here is designed in order to provide privacy on three sides with partial privacy on the fourth side. In this example, a right-hand typing return has been provided. Careful consideration should always be given to the height and placement of task lighting in order to ensure that the surface or task below is being lit properly. Many designers do not give this adequate thought. Overall costs of custom-designed reception desks can be reduced by integrating standard metal file components into the architectural woodwork.



ELEVATION



## PLAN RECEPTION DESK

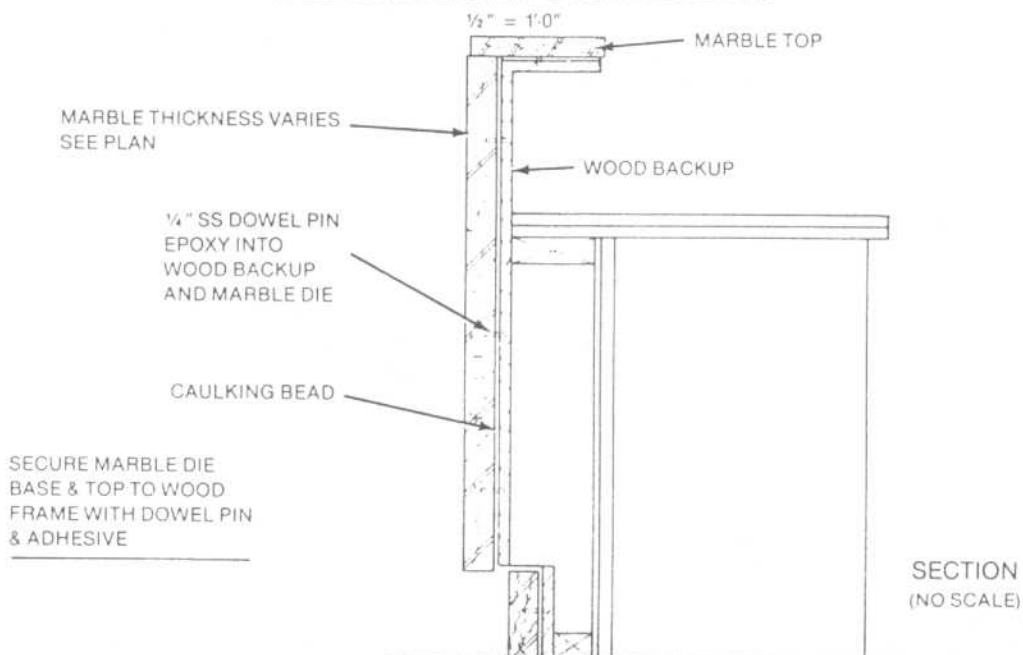


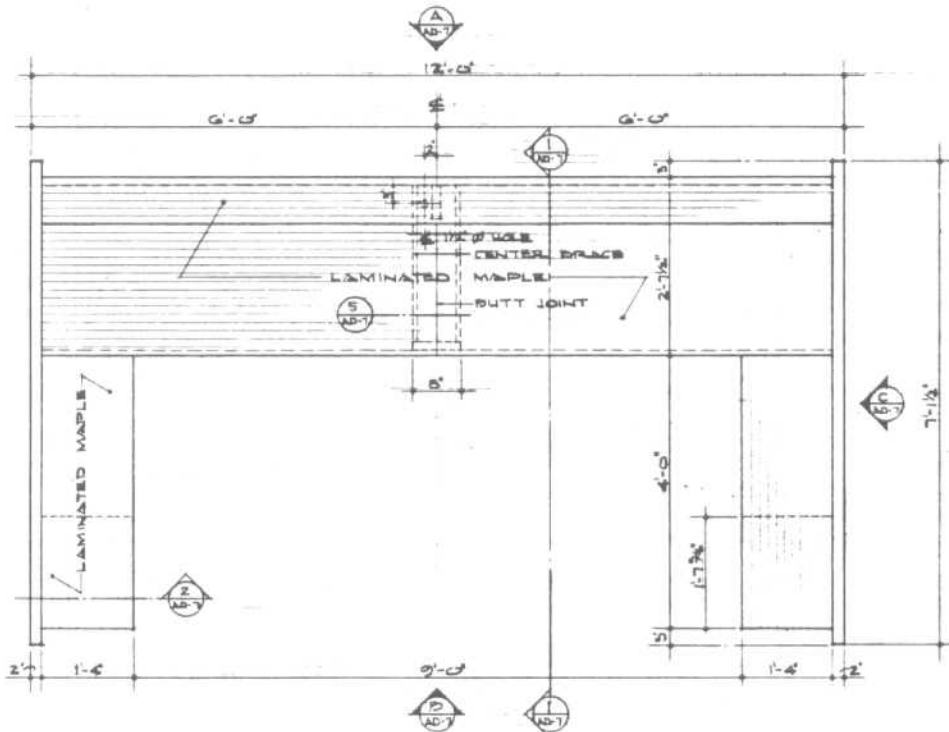
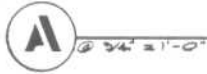
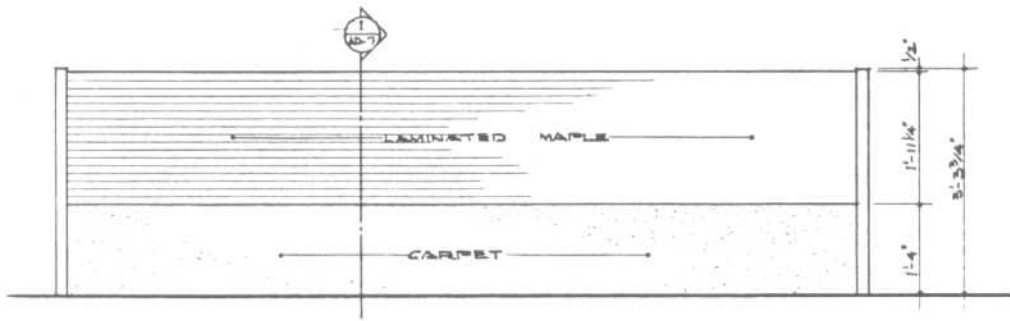
Fig. 7 A larger reception desk can accommodate work surfaces on three sides, as shown here. With this type of configuration, however, the designer must be concerned with the orientation of the open side. As with all custom reception desks, the designer must anticipate the integration of wiring and electronic equipment within the architectural woodwork.





RECEPTION AREAS

Reception Desk Details



PLAN OF RECEPTION DESK SPACE 15-2  
 $\textcircled{3/4} = 1'-0"$

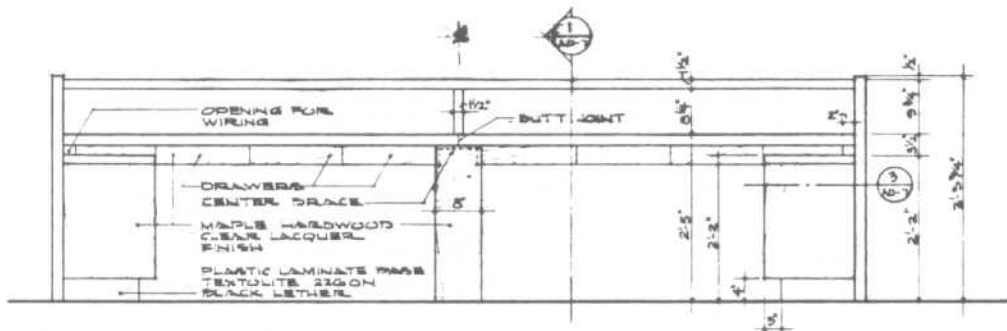
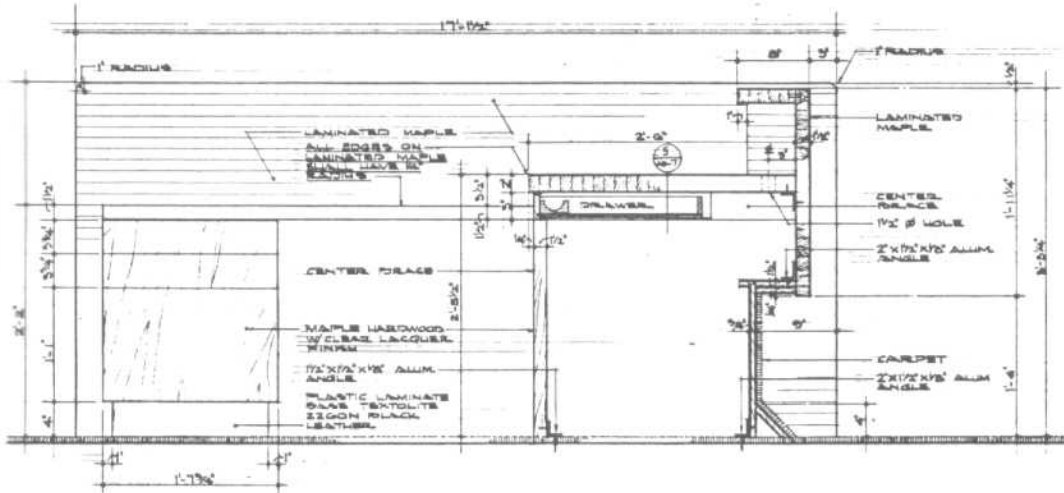


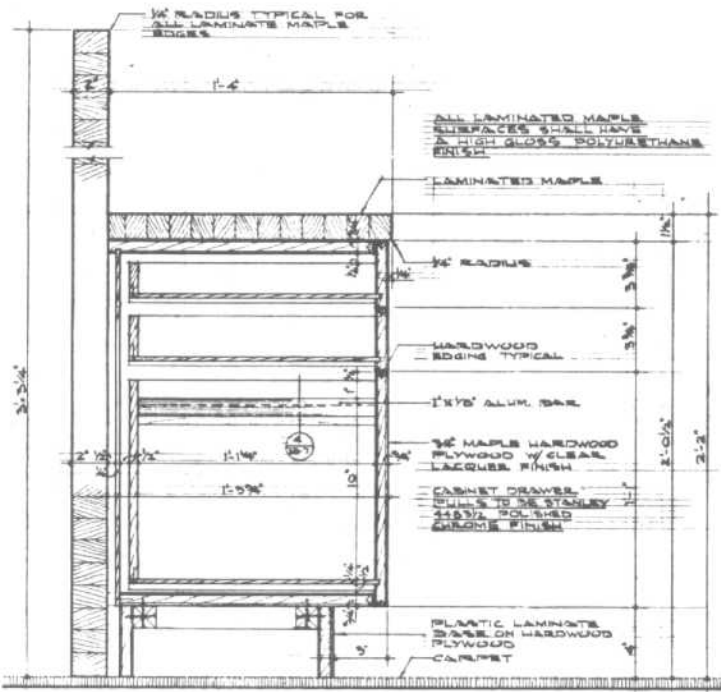
Fig. 9 A reception desk can often consist of two workstations.



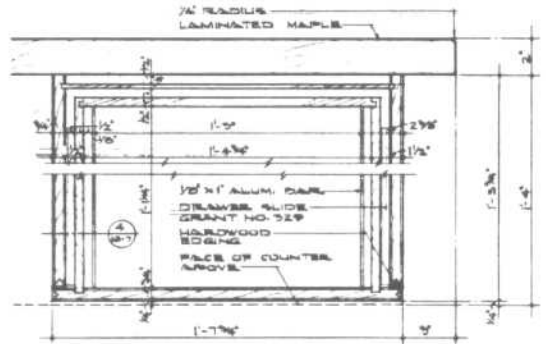
RECEPTION AREAS  
Reception Desk Details



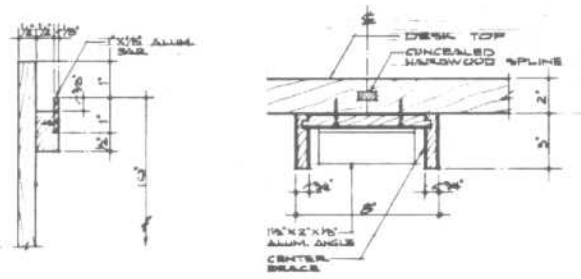
1 @ 1/2" = 1'-0"



2 @ 3/4" = 1'-0"



3 @ 3/4" = 1'-0"



4 @ 1/2" FULL SIZE

5 @ 3/4" = 1'-0"

Fig. 9 (Continued)

RECEPTION AREAS

Reception Desk Details

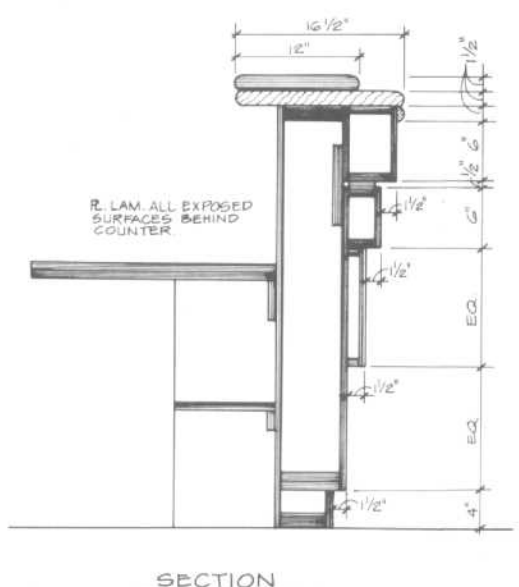
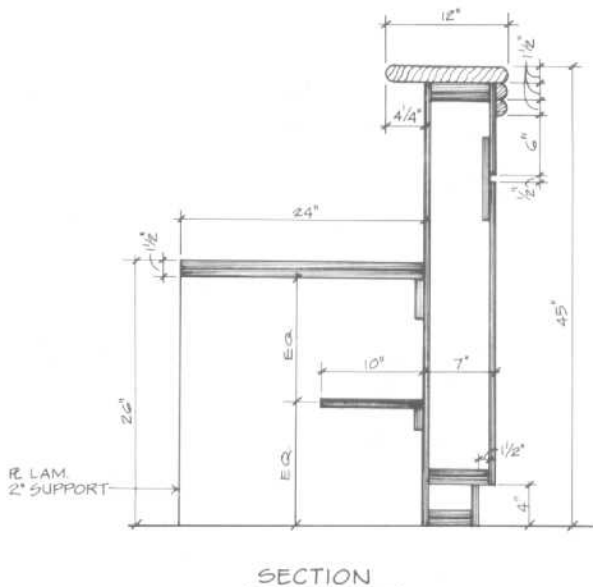
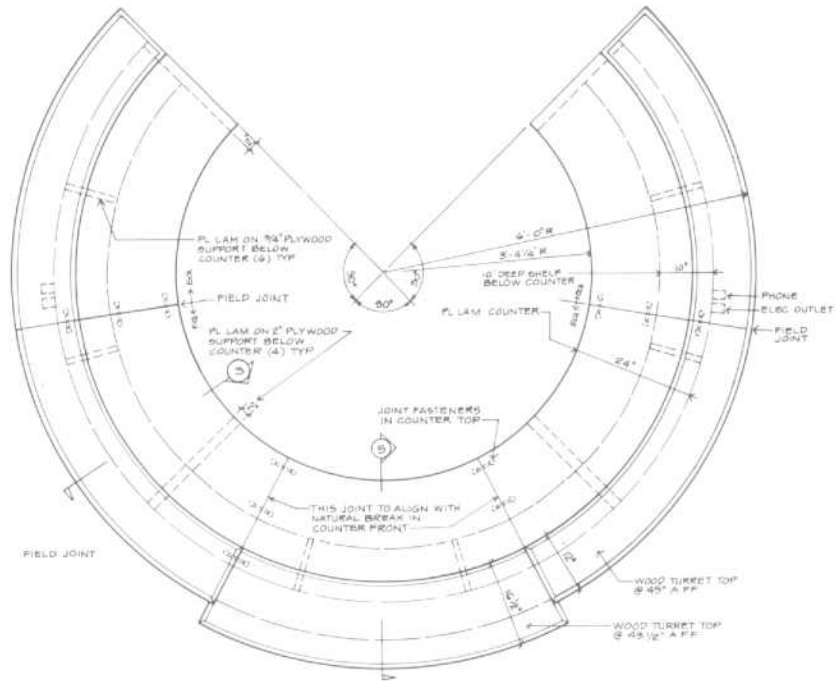
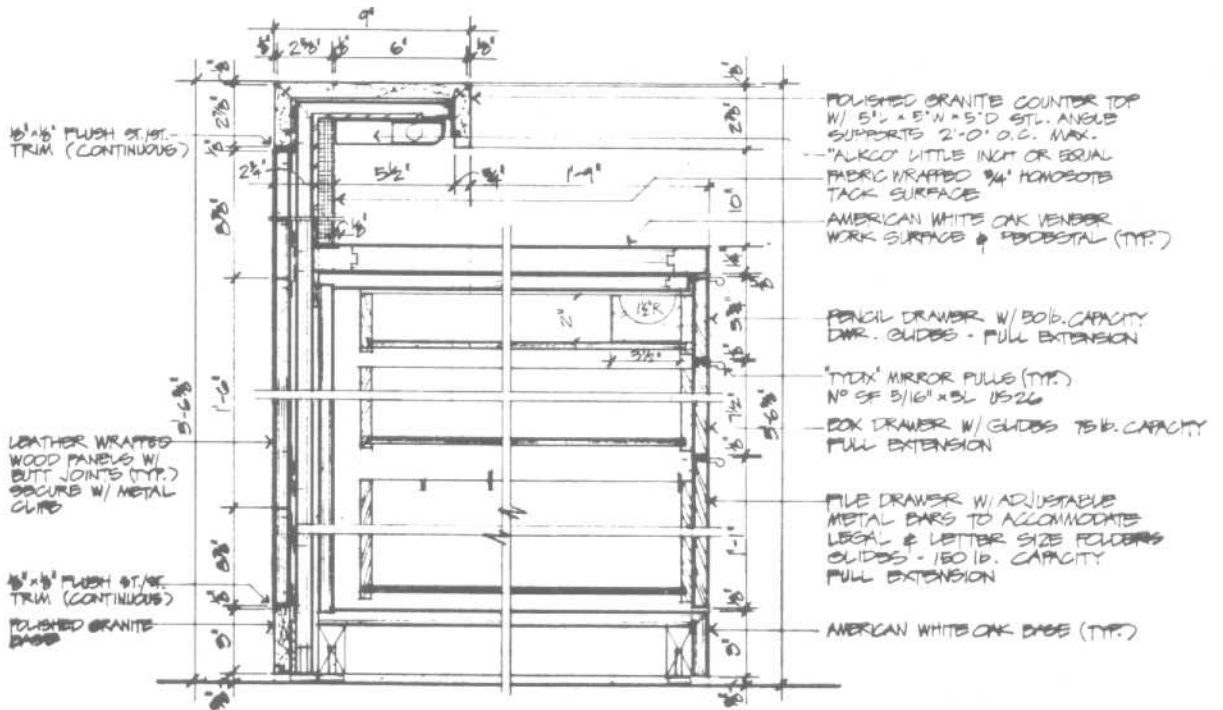
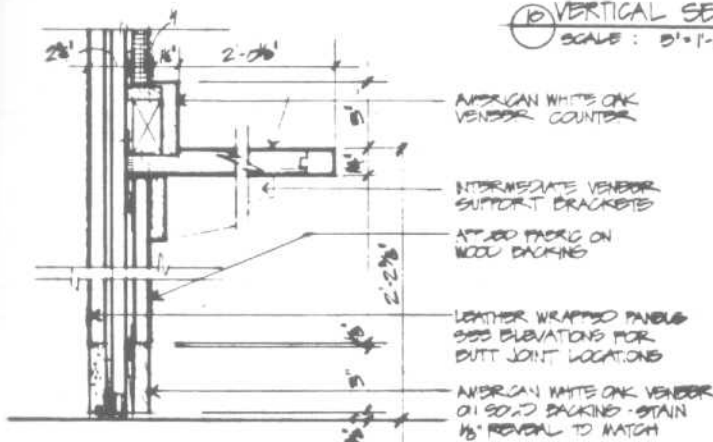


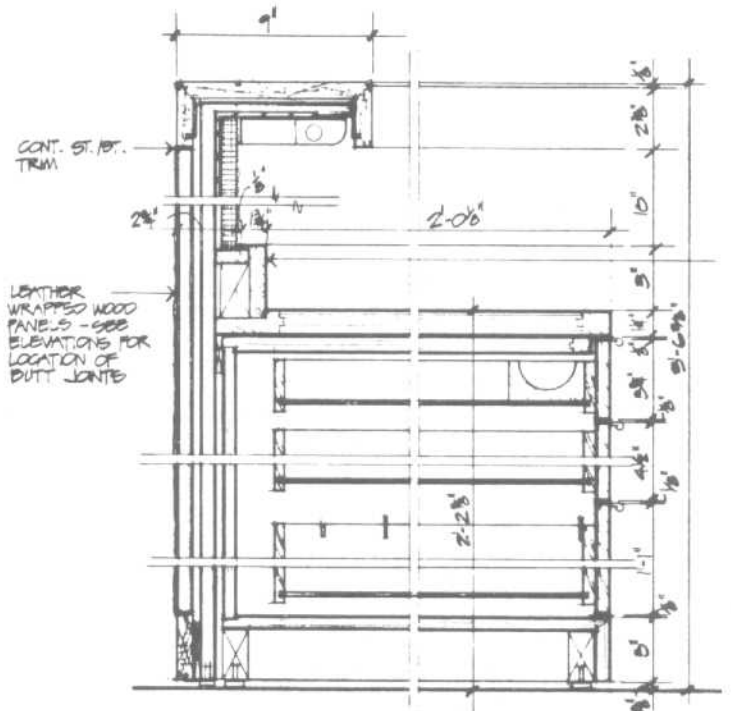
Fig. 10 A circular reception desk can make a bold and sophisticated corporate statement. The designer is cautioned, however, to carefully analyze the minimum radius required for chair movement. Custom built-in files and drawers, if also curved, can become costly and sometimes impractical.



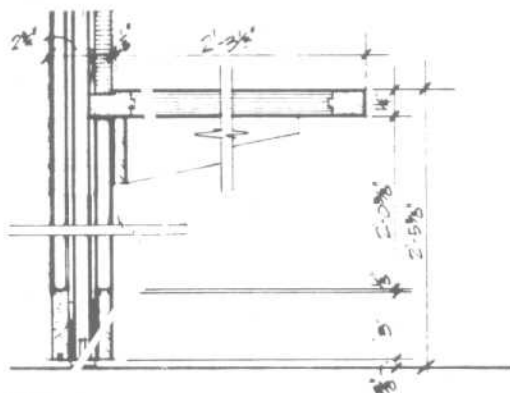
⑩ VERTICAL SECTION @ HIGH PEDESTAL  
SCALE: 3/4" = 1'-0"



⑪ VERTICAL SECTION @ LOW WORK SURFACE  
SCALE: 3/4" = 1'-0"



⑫ VERTICAL SECTION @ LOW PEDESTAL  
SCALE: 3/4" = 1'-0"



⑬ VERTICAL SECTION @ HIGH WORK SURFACE  
SCALE: 3/4" = 1'-0"

Fig. 11 A fully detailed reception desk will require many large-scale vertical sections to explain the various storage, drawer, work surface, lighting, and electrical requirements. Examples of such details are shown here.



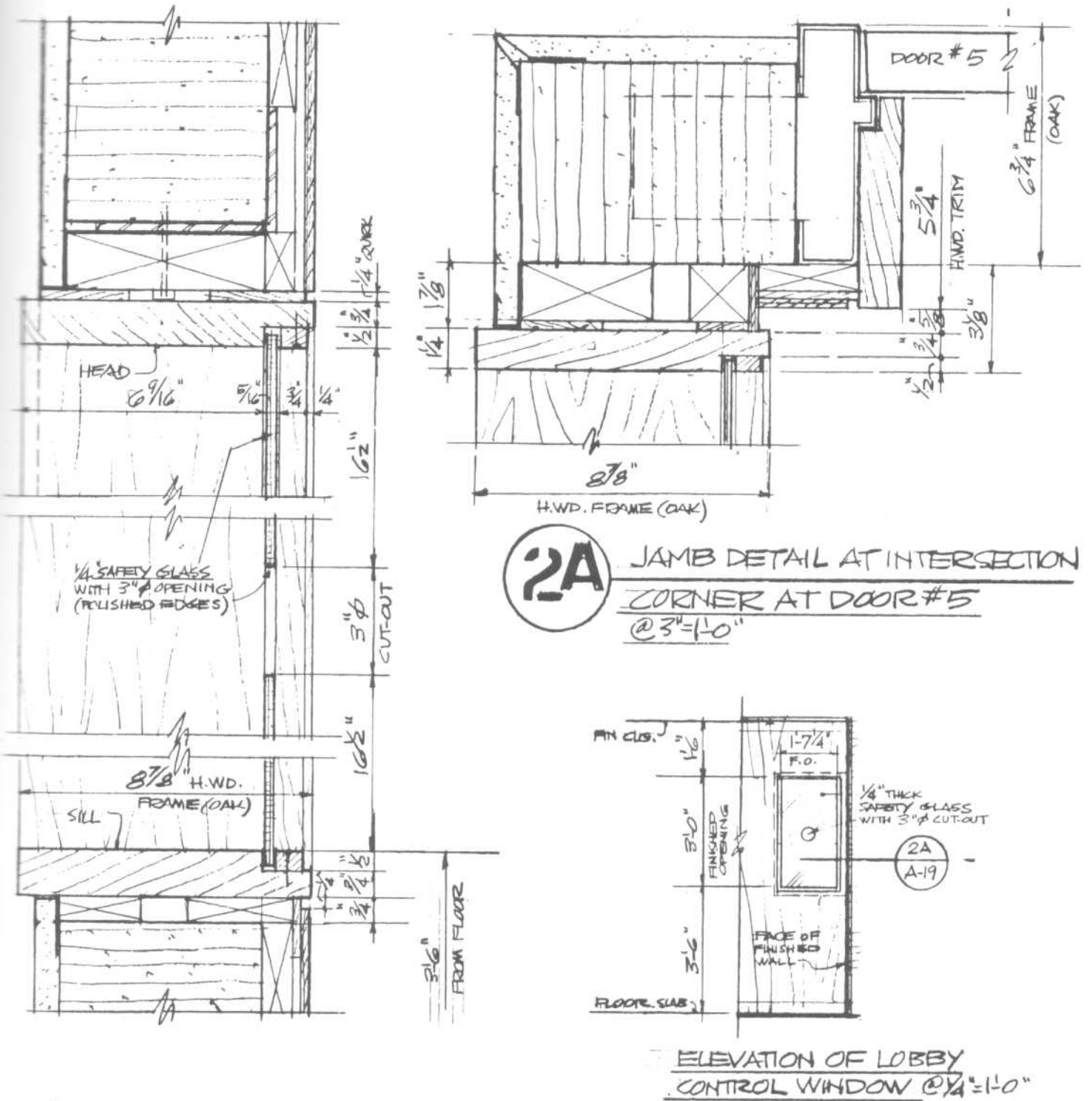
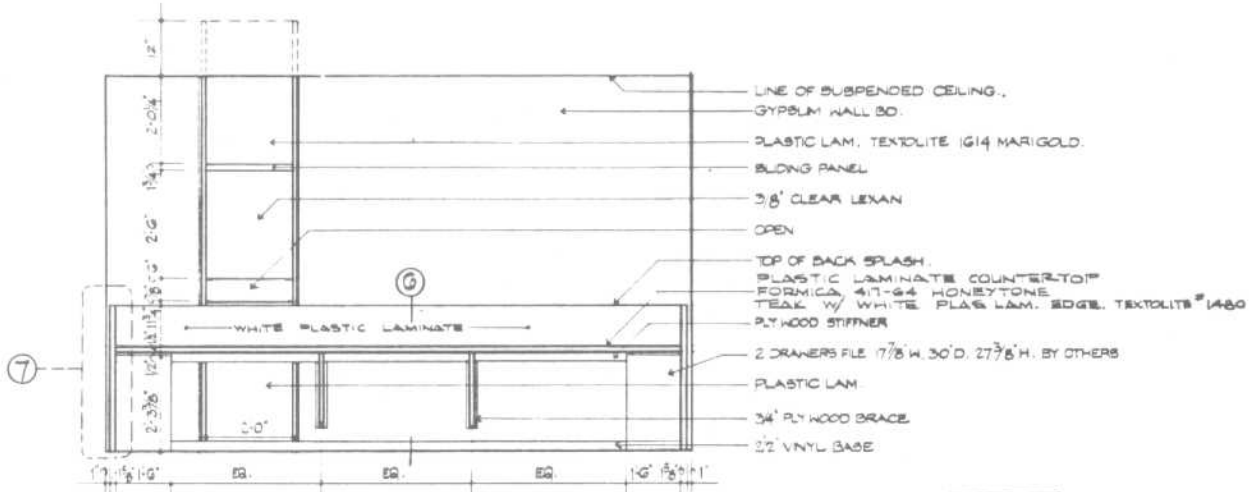


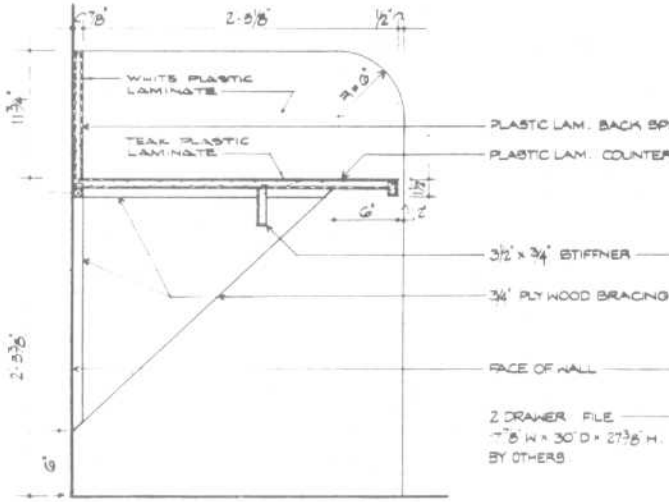
Fig. 12 A receptionist's workstation need not be freestanding within a reception area, where security and privacy are of critical importance. A receptionist may be located on the opposite side of a glass partition as shown here. Such a solution is often suggested when the receptionist performs multiple tasks such as typing and answering phones.

RECEPTION AREAS

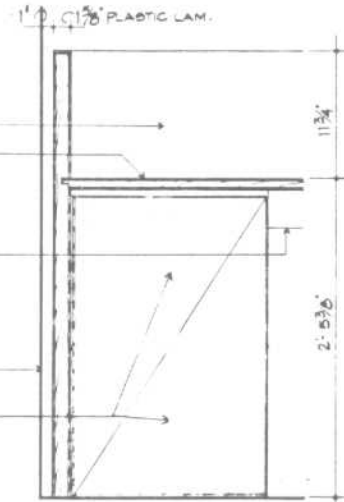
Reception Window/Pass-Through



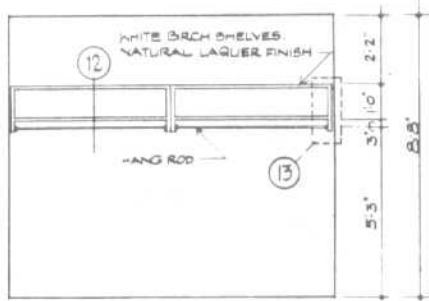
5 NORTH ELEVATION FROM SPACE NO. 13  
SCALE 1/2" = 1'-0"



6 SCALE 1/2" = 1'-0"

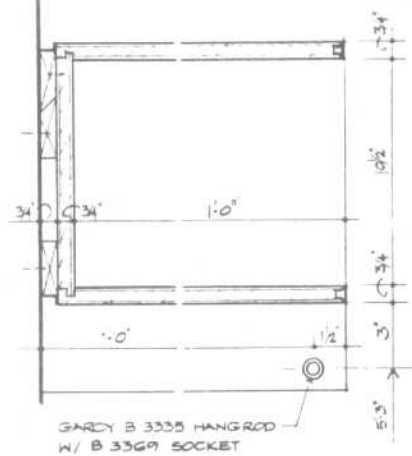


7 SCALE 1/2" = 1'-0"

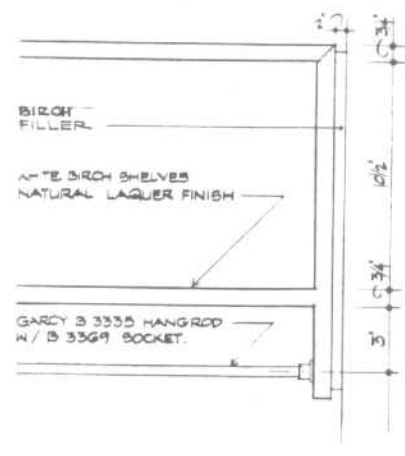


NORTH ELEVATION SPACE # 4A

11 SCALE 3/8" = 1'-0"



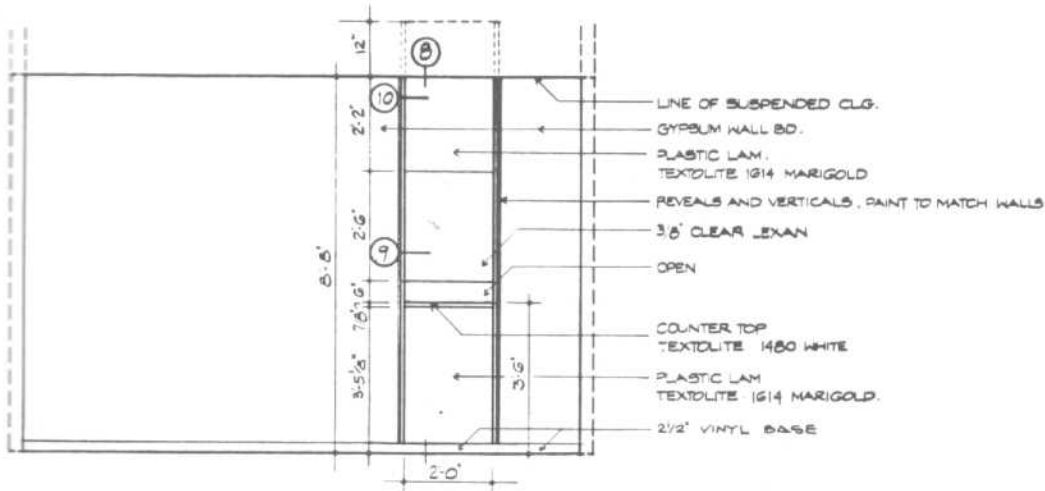
12 SCALE 3" = 1'-0"



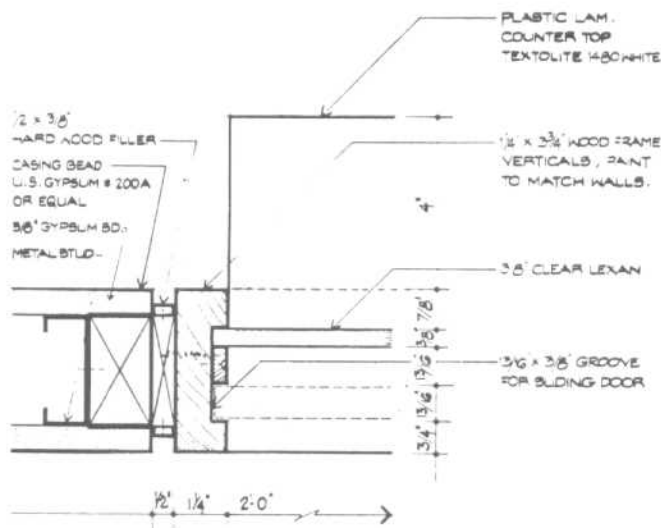
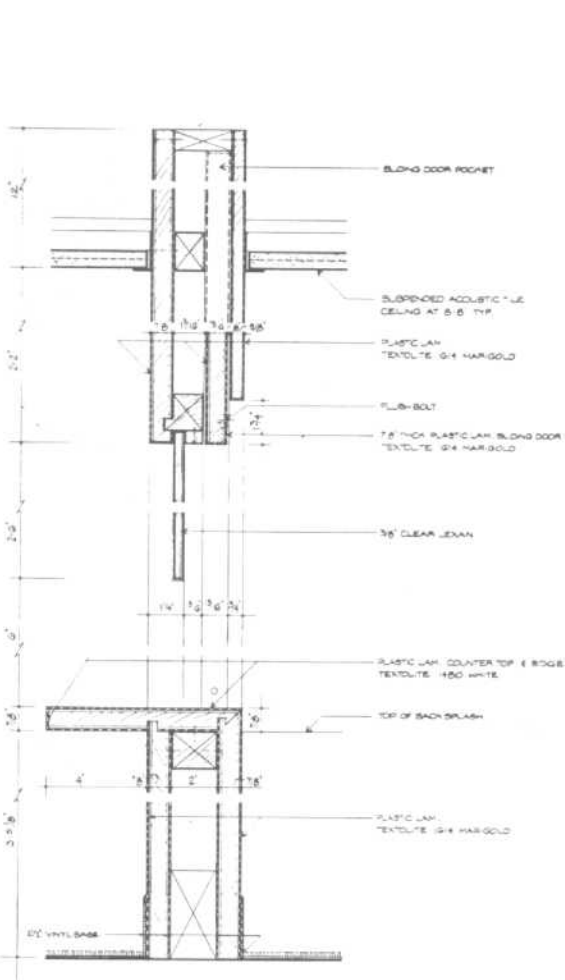
13 COAT & HAT SHELVES PART ELEVATION  
SCALE 3" = 1'-0"

RECEPTION AREAS

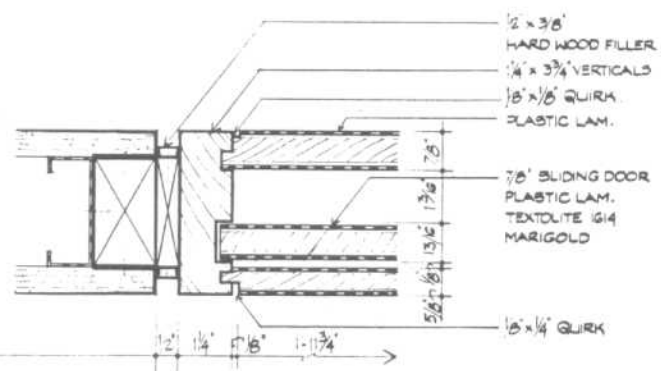
Reception Window/Pass-Through



4 SOUTH ELEVATION FROM SPACE NO. 14  
SCALE 1/2" = 1'-0"



9 SCALE : HALF FULL SIZE

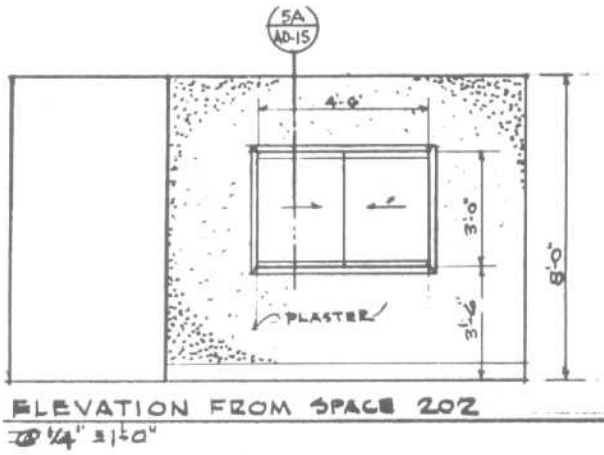


10 SCALE : HALF FULL SIZE

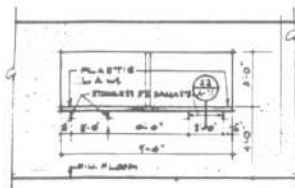
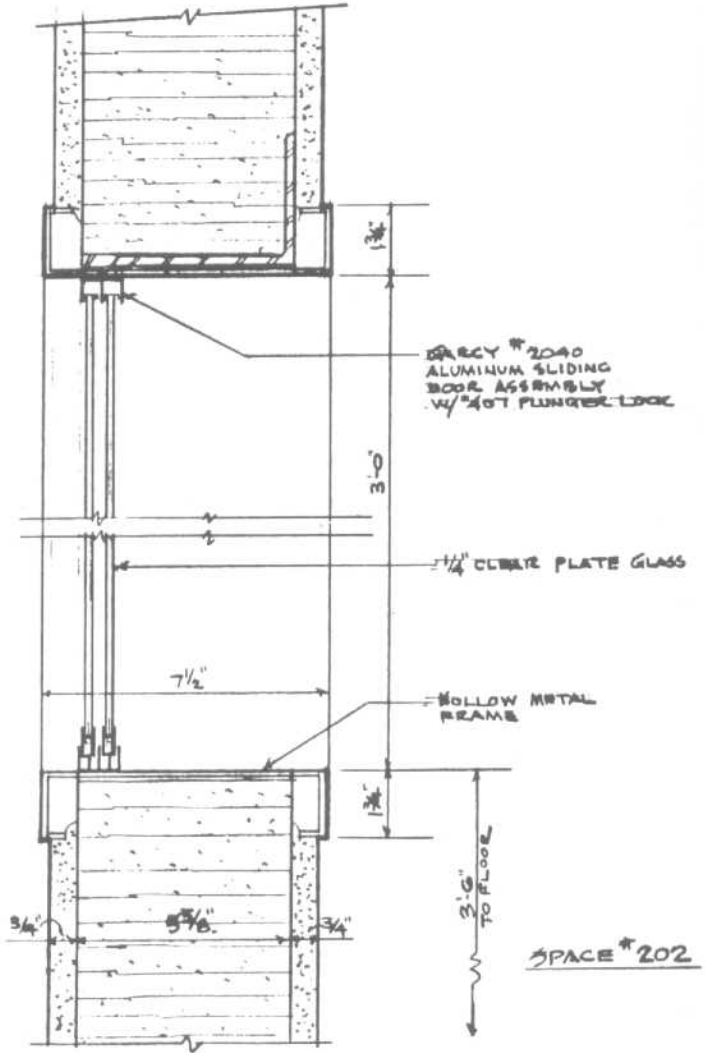
Fig. 12 (Continued)

RECEPTION AREAS

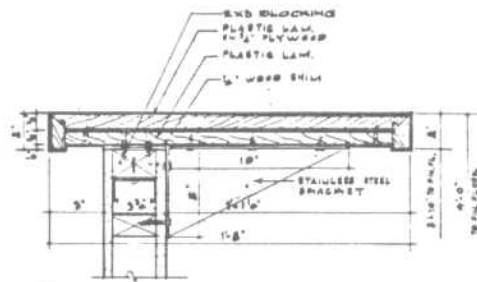
Reception Window/Pass-Through



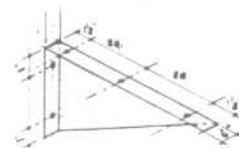
5A



21 EAST ELEVATION  
Ø 5/8" 3 1/2" 1'-0"



22  
Ø 3" 1'-0"



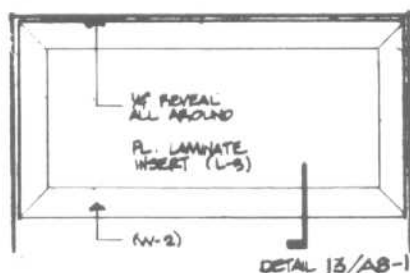
ISOMETRIC OF  
STAINLESS STEEL BRACKET  
NOT TO SCALE

Fig. 12 (Continued)

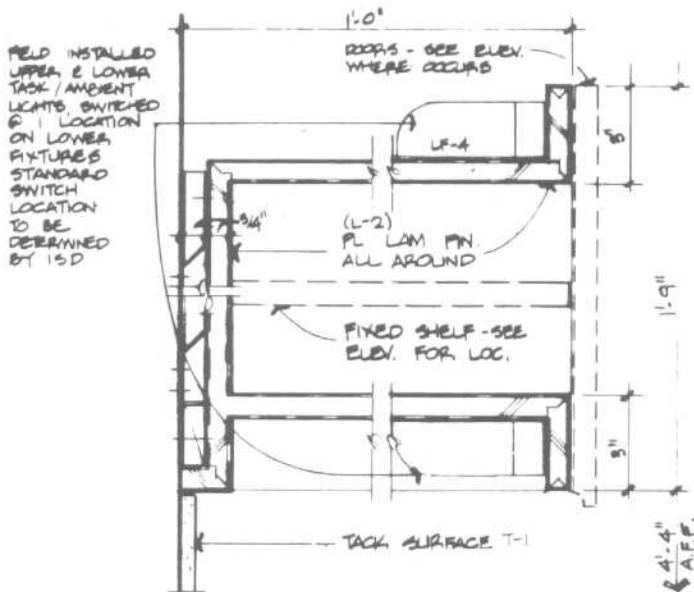


RECEPTION AREAS

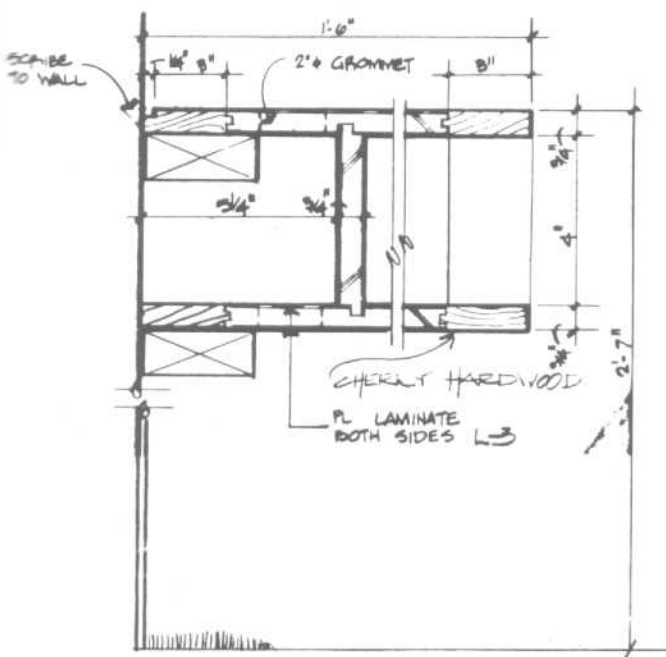
Wall Shelf; Coat Closet; Telephone Shelf



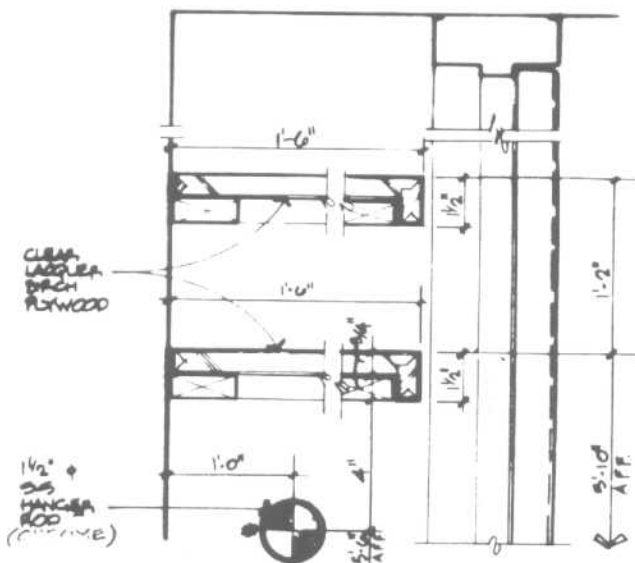
PLAN VIEW



DETAIL - WALL SHELF



SECTION



DETAIL - TYP. COATS

DETAIL: PHONE SHELF

Fig. 13 While the reception desk is typically the major element to be designed and detailed for a reception area, other custom-designed components must also be carefully considered. A phone shelf, a wall shelf, a coat hanging area, and a work surface are often items that must be carefully designed and detailed.

FURNITURE, FURNISHINGS, AND EQUIPMENT

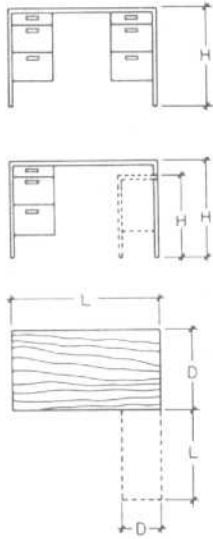
Desks and Seating

Furniture, furnishings, and equipment are the basic building blocks in the design of office spaces. The illustrations and dimensional data contained in this part are based on the product lines available from particular manufacturers.

Although the data, to a great extent, are fairly standard throughout the industry, there will be some variations according to manufacturer. Accordingly, although the informa-

tion presented is adequate for preliminary planning purposes, the designer is cautioned to reconcile preliminary assumptions with the actual dimensional data of the manufacturer whose product is ultimately specified.

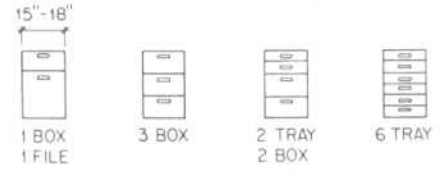
Included in the data provided in this part are examples of filing cabinets, storage cabinets, conference tables, desks, and electronic media.



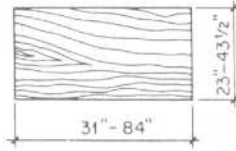
DESK DIMENSIONS

	DESKS				RETURNS	
	DOUBLE PEDESTAL		SINGLE PEDESTAL		FOR EXECUTIVE DESK RETURNS ARE AVAILABLE AT SAME HEIGHT AS DESK	
	STANDARD	RANGE	STANDARD	RANGE	STANDARD	RANGE
D	2'-6"	2'-0"-3'-3"	2'-6"	2'-0"-3'-3"	1'-6"	1'-3"-1'-8"
H	2'-5"	2'-4"-2'-6"	2'-5"	2'-4"-2'-6"	2'-2"	2'-1"-2'-3"
L	5'-0"	4'-6"-7'-0"	5'-0"	3'-9"-7'-0"	3'-0"	2'-0"-5'-0"

DESKS-SINGLE OR DOUBLE PEDESTAL WORK TABLES ARE OF SIMILAR DIMENSIONS. FOR EXECUTIVE DESKS WITH RETURNS, RETURNS ARE AVAILABLE AT THE SAME HEIGHT AS THE DESK SURFACE. A MINIMUM CLEAR WIDTH OF 22" SHOULD BE PROVIDED FOR KNEE ROOM, 24" IS NORMAL.



VARIOUS DRAWER ARRANGEMENTS FOR PEDESTALS

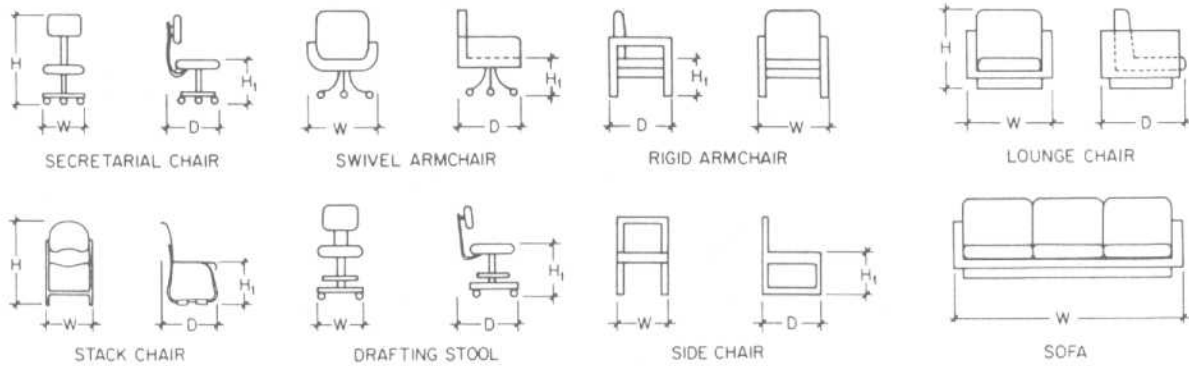


ARTIST AND DRAFTING DESKS OR TABLES

PEDESTALS FOR SECRETARIAL RETURNS WILL BE REDUCED IN HEIGHT THE EQUIVALENT OF ONE PENCIL DRAWER.

STANDARD SIZE ENGINEERING OR ARCHITECTURAL DRAFTING TABLES ARE 37 1/2" x 43 1/2" D x 60"-72"-84" W x 37" H.

Fig. 1 Office planning: desks — sizes.



CHAIR DIMENSIONS

	SECRETARIAL		SWIVEL ARMCHAIR		RIGID ARMCHAIR		STACK CHAIR		RIGID AND ADJUSTABLE DRAFTING STOOL		SIDE CHAIR	
	STD.	RANGE	STD.	RANGE	STD.	RANGE	STD.	RANGE	STD.	RANGE	STD.	RANGE
W	1'-5"	1'-4"-1'-8"	2'-4"	1'-8"-2'-6"	1'-10"	1'-6"-2'-3"	1'-9"	1'-6"-1'-11"	1'-6"	1'-5"-2'-0"	1'-8"	1'-4"-2'-0"
D	1'-7 1/2"	1'-6"-2'-0"	2'-3"	1'-8"-2'-6"	1'-10"	1'-7"-2'-8"	1'-9"	1'-7"-1'-10"	1'-8"	1'-6"-2'-0"	1'-10"	1'-6"-2'-8"
H	2'-6"	2'-5"-2'-10"	2'-9"	2'-6" 3'-0"	2'-6"	2'-4"-2'-10"	2'-6"	2'-4"-2'-9"	3'-0"	2'-11"-3'-6"	2'-6"	2'-4"-2'-10"
H <sub>1</sub>	1'-5"	1'-4"-1'-8"	1'-5"	1'-4"-1'-10"	1'-6"	1'-4"-1'-7"	1'-5"	1'-5"-1'-6"	2'-4"	1'-5"-2'-10"	1'-6"	1'-5"-1'-7"

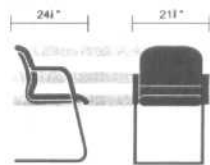
LOUNGE CHAIR AND SOFA DIMENSIONS

	LOUNGE CHAIR		SOFA
	STD.	RANGE	
W	2'-6"	2'-6"-3'-4"	D, H AND H <sub>1</sub> SIMILAR 2 SEATS-5'-0"-6'-7" 3 SEATS-6'-0"-7'-6" 4 SEATS-7'-8"-9'-0"
D	2'-7"	2'-2"-3'-4"	
H	2'-6"	2'-1"-3'-4"	
H <sub>1</sub>	1'-3"	1'-0"-1'-6"	

Fig. 2 Office planning: seating — sizes.

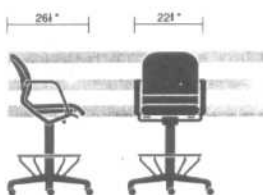
## FURNITURE, FURNISHINGS, AND EQUIPMENT

## Chairs

operator  
sled base

height range:  
33"  
arm height range:  
25"  
seat height range:  
18"

## operator stool



height range:  
39" - 46" pneumatic  
39" - 46" veomatic  
arm height range:  
31" - 38" pneumatic  
31" - 38" veomatic  
seat height range:  
22" - 29" pneumatic  
22" - 29" veomatic

## operator



height range:  
33" - 37" pneumatic  
33" - 37" veomatic  
34" fixed  
seat height range:  
16" - 20" pneumatic  
16" - 20" veomatic  
17" fixed

## operator

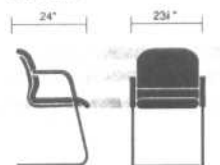


height range:  
33" - 37" pneumatic  
33" - 37" veomatic  
34" fixed  
arm height range:  
25" - 29" pneumatic  
25" - 29" veomatic  
26" fixed  
seat height range:  
16" - 20" pneumatic  
16" - 20" veomatic  
17" fixed

## mid-manager



height range:  
33" - 37" pneumatic  
33" - 37" veomatic  
34" fixed  
seat height range:  
17" - 21" pneumatic  
17" - 21" veomatic  
17" fixed

mid-manager  
sled base

height:  
33"  
arm height:  
25"  
seat height:  
18"

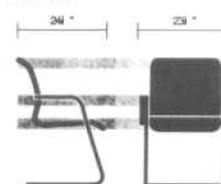
## mid-manager



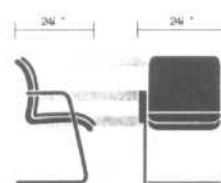
height range:  
33" - 37" pneumatic  
33" - 37" veomatic  
34" fixed  
arm height range:  
25" - 29" pneumatic  
25" - 29" veomatic  
25" fixed  
seat height range:  
17" - 21" pneumatic  
17" - 21" veomatic  
17" fixed

high back  
mid-manager

height range:  
39" - 43" pneumatic  
39" - 43" veomatic  
arm height range:  
25" - 29" pneumatic  
25" - 29" veomatic  
seat height range:  
17" - 21" pneumatic  
17" - 21" veomatic  
45 pounds  
Shipped Set-Up

manager  
sled base

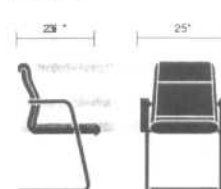
height:  
35"  
arm height:  
29"  
seat height:  
18"

executive  
manager  
sled bases

height:  
35"  
arm height:  
29"  
seat height:  
18"

manager  
high back

height range:  
42" - 46" pneumatic  
42" - 46" veomatic  
arm height range:  
25" - 29" pneumatic  
25" - 29" veomatic  
seat height range:  
17" - 21" pneumatic  
17" - 21" veomatic

grand class  
manager  
sled bases

height:  
33"  
arm height:  
25"  
seat height:  
18"

## manager



height range:  
34" - 39" pneumatic  
34" - 39" veomatic  
35" fixed  
arm height range:  
25" - 29" pneumatic  
25" - 29" veomatic  
26" fixed  
seat height range:  
17" - 21" pneumatic  
17" - 21" veomatic  
18" fixed

grand class  
manager

height range:  
34" - 39" pneumatic  
34" fixed  
arm height range:  
25" - 29" pneumatic  
25" fixed  
seat height range:  
17" - 21" pneumatic  
17" fixed

## executive



height range:  
42" - 46" high back  
34" - 39" manager  
arm height range:  
25" - 29"  
seat height range:  
17" - 21"  
50 pounds  
Shipped Set-Up

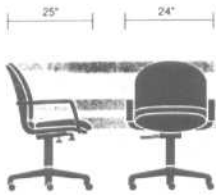
grand class  
high back

height range:  
42" - 46"  
arm height range:  
25" - 29"  
seat height range:  
17" - 21"  
60 pounds  
Shipped Set-Up

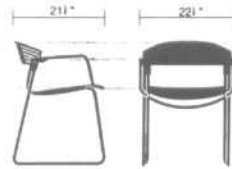
Chair types are often associated with certain generic job titles. The designer, however, is cautioned not to make assumptions as to chair selection without a thorough understanding of the tasks the individual is to perform. Ergonomic considerations are to be carefully reviewed in order to select a chair with appropriate attributes, i.e., seat height, adjustability, back and arm support, firmness, etc. Overall chair size must be understood within the context of available clearances and workstation configuration.

FURNITURE, FURNISHINGS, AND EQUIPMENT

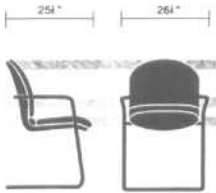
Chairs



height range:  
33" - 37" pneumatic  
31" - 35" vecoma  
33" fixed  
arm height range:  
24" - 28" pneumatic  
23" - 26" pneumatic  
24" fixed  
seat height range:  
18" - 22" pneumatic  
16" - 20" vecoma  
18" fixed

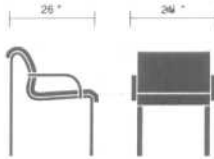


height:  
29"  
arm height:  
25"  
seat height:  
17"  
15 pounds  
Shipped Set-Up



height range:  
33"  
arm height range:  
25"  
seat height range:  
18"

43 pounds  
Shipped Set-Up

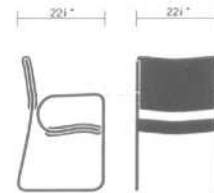


height:  
31"  
arm height:  
25"  
seat height:  
19"  
36 pounds  
Shipped Set-Up



height range:  
41" - 45" high back  
33" - 37" mid back  
arm height range:  
24" - 28"  
seat height range:  
18" - 21"

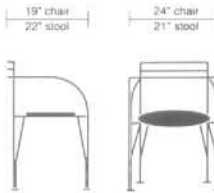
67 pounds  
Shipped Set-Up



height range:  
33"  
arm height range:  
25"  
seat height range:  
17"



height range:  
41" - 44" high back  
37" - 40" mid back  
35" - 38" low back  
arm height range:  
25" - 29"  
seat height range:  
17" - 20"



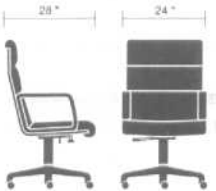
height:  
30" chair  
33" stool  
arm height:  
26"  
seat height:  
17" chair  
30" stool  
21 pounds  
Shipped Set-Up



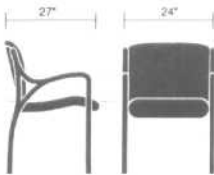
height range:  
41" - 44" high back  
37" - 40" mid back  
arm height range:  
26" - 29"  
seat height range:  
17" - 20"



height:  
33"  
arm height:  
25"  
seat height:  
17"  
20 pounds  
Shipped Set-Up



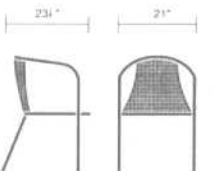
height range:  
41" - 45" high back  
33" - 37" mid back  
arm height range:  
24" - 28"  
seat height range:  
18" - 21"  
67 pounds  
Shipped Set-Up



height:  
32"  
arm height:  
25"  
seat height:  
17"



height range:  
42" - 45" high back  
38" - 41" mid back  
arm height range:  
24" - 27"  
seat height range:  
18" - 21"  
64 pounds  
Shipped Set-Up



height:  
28"  
seat height:  
16"

## Executive Chairs

Tilt-Swivel Chair  
with Casters

Option: CA

Non-Swivel Lounge  
Chair

Swivel Lounge Chair

Non-Swivel Lounge  
Arm Chair

Swivel Lounge Arm Chair

Tilt-Swivel Reclining  
Arm Chair

Ottoman



## Lounge

Non-Swivel Lounge Chair



Swivel Lounge Chair

Non-Swivel Lounge  
Armchair

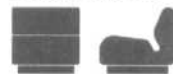
Swivel Lounge Armchair

Tilt-Swivel Reclining  
Armchair

Ottoman



Straight Module



## Side/Pull-up Chairs

Non-Swivel Side Chair



Swivel Side Chair



Non-Swivel Arm Chair



Swivel Arm Chair

Tilt-Swivel Arm Chair  
with GlidesTilt-Swivel Arm Chair  
with Casters

Option: CA

Executive Chairs

Tilt-Swivel Chair  
with Glides

## Lounge Chair



Ottoman

Lounge Chair  
and Ottoman

Eames™ Chaise



Sofa Compact



Nelson Sling Sofa



Eames Executive Lounge Chairs

Executive Swivel  
Lounge ChairAdjustable Executive  
Tilt-Swivel Lounge Chair

Adjustable Tilt-Swivel



FURNITURE, FURNISHINGS, AND EQUIPMENT

Reception and Lounge Seating

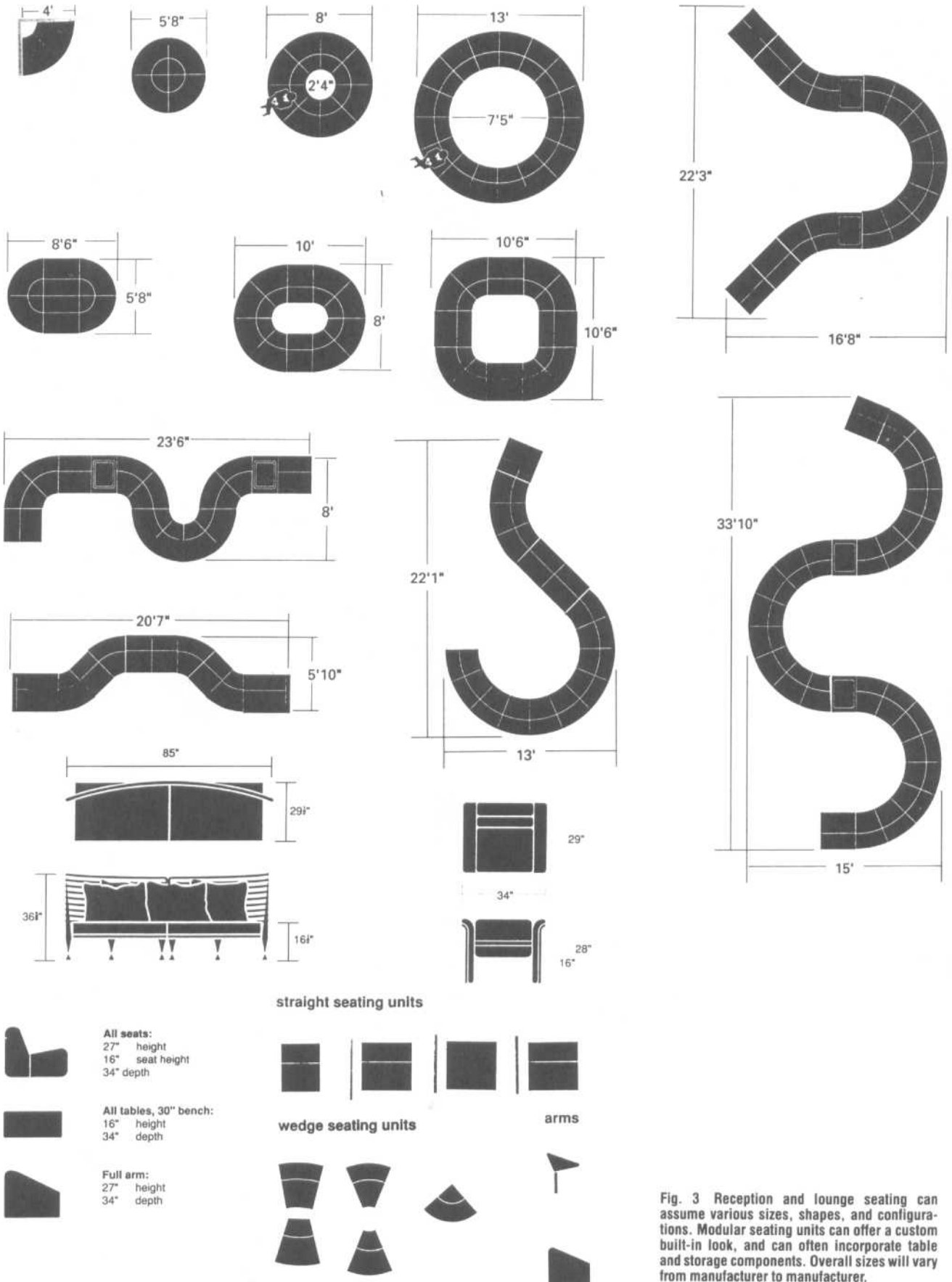


Fig. 3 Reception and lounge seating can assume various sizes, shapes, and configurations. Modular seating units can offer a custom built-in look, and can often incorporate table and storage components. Overall sizes will vary from manufacturer to manufacturer.

**FURNITURE, FURNISHINGS, AND EQUIPMENT**

**Conference Tables**

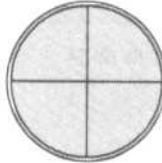
Conference tables come in an infinite variety of shapes and sizes. Figures 4 to 6 attempt to provide a representative sampling of such tables, along with dimensional information and seating capacities. The designer is cautioned to use such information as a preliminary planning tool only, and to carefully lay out conference rooms with actual furniture pieces that have been selected. Chair width and spacing will ultimately dictate conference table seating capacity.



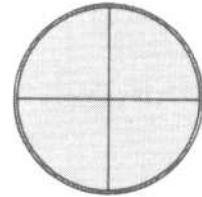
42" diameter, seats 4



48" diameter, seats 5

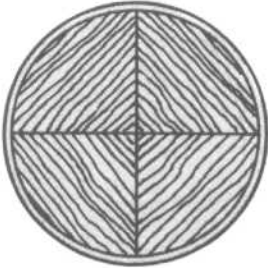


54" diameter, seats 6



60" diameter, seats 7

**Veneer Tops**



"Diamond"

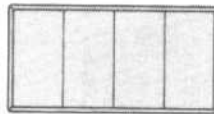


"Reverse diamond"

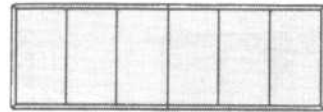


"Sunburst"

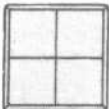
Fig. 4



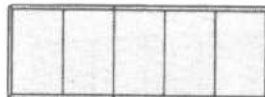
60" x 122", seats 10



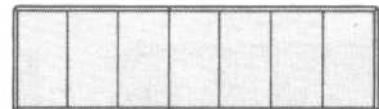
60" x 180", seats 14



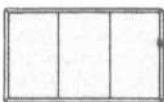
60" x 60", seats 8



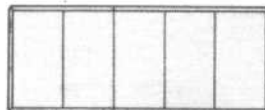
53" x 151", seats 12



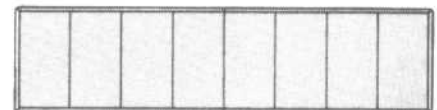
60" x 209", seats 16



53" x 93", seats 8



60" x 151", seats 12

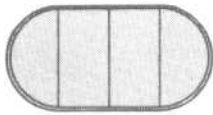


60" x 238", seats 18

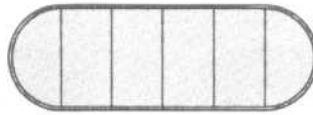
Fig. 5

FURNITURE, FURNISHINGS, AND EQUIPMENT

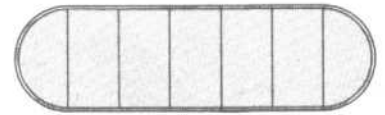
Conference Tables



60" x 118", seats 6-8



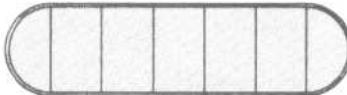
60" x 176", seats 10-12



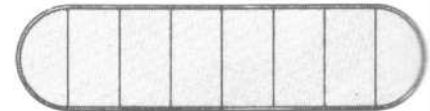
60" x 205", seats 12-14



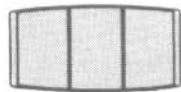
53" x 140", seats 8-10



53" x 198", seats 12-14



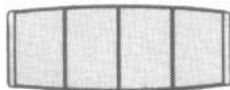
60" x 234", seats 14-16



One piece top, 48" x 96", seats 8



One piece top, 48" x 117 1/4" x 29", seats 6-8



One piece top, 48" x 126 1/2", seats 10



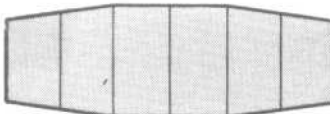
Two piece top, 53" x 146 3/4" x 29", seats 8-10



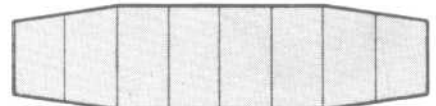
Two piece top, 60" x 204 3/4" x 29", seats 12-14



Two piece top, 54" x 156", seats 12



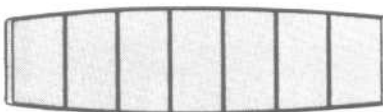
Two piece top, 60" x 175 3/4" x 29", seats 10-12



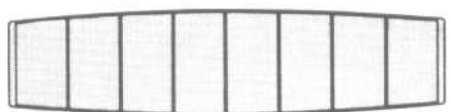
Two piece top, 60" x 233 3/4" x 29", seats 14-16



Two piece top, 60" x 185 3/4", seats 14



Two piece top, 60" x 216", seats 16







Two piece top, 60" x 245 1/4", seats 18

Fig. 6



TABLE 1 Vertical File Cabinets

Description	Cabinet height		Outside dimensions		
			Depth	Width	Height
	58 $\frac{3}{8}$ "	Letter	28 $\frac{1}{16}$ "	14 $\frac{7}{8}$ "	58 $\frac{3}{8}$ "
		Legal	28 $\frac{1}{16}$ "	17 $\frac{7}{8}$ "	58 $\frac{3}{8}$ "
	52 $\frac{3}{8}$ "	Letter	28 $\frac{1}{16}$ "	14 $\frac{7}{8}$ "	52 $\frac{3}{8}$ "
		Legal	28 $\frac{1}{16}$ "	17 $\frac{7}{8}$ "	52 $\frac{3}{8}$ "
		Card	28 $\frac{1}{16}$ "	14 $\frac{7}{8}$ "	52 $\frac{3}{8}$ "
	41 $\frac{1}{4}$ "	Letter	28 $\frac{1}{16}$ "	14 $\frac{7}{8}$ "	41 $\frac{1}{4}$ "
		Legal	28 $\frac{1}{16}$ "	17 $\frac{7}{8}$ "	41 $\frac{1}{4}$ "
	29 $\frac{3}{8}$ "	Letter	30"	14 $\frac{7}{8}$ "	29 $\frac{3}{8}$ "
		Legal	30"	17 $\frac{7}{8}$ "	29 $\frac{3}{8}$ "
	27 $\frac{3}{8}$ "	Letter	30"	14 $\frac{7}{8}$ "	27 $\frac{3}{8}$ "
		Legal	30"	17 $\frac{7}{8}$ "	27 $\frac{3}{8}$ "

Standard vertical file cabinets are usually designed to accommodate standard height drawers and half-height file insert drawers (optional). Cabinets are available in letter-size widths (14 $\frac{7}{8}$ " and legal-size widths (17 $\frac{7}{8}$ "). Vertical file drawers are usually 12" high and accommodate front-to-back filing.

Standard cabinets are available in four heights: five-drawer (58 $\frac{3}{8}$ "), four-drawer (52 $\frac{3}{8}$ "), three-drawer (41 $\frac{1}{4}$ "), and two-drawer (29 $\frac{3}{8}$ " or 27 $\frac{3}{8}$ "). The depths of the three-, four-, and five-drawer cabinets are 28 $\frac{1}{16}$ ", while the depth of the 2-drawer cabinets is 30". Table 1 lists these dimensional data. It should be noted that although adequate for preliminary planning purposes, the data are based on Steelcase cabinets.

#### Guidelines for Customizing Vertical Files

Depending on the manufacturer, vertical file cabinets can be customized. Usually two half-height file insert drawers may be substituted for a 12-in-high drawer in any or all positions. Table 2 indicates the dimensions and linear capacities of such insert drawers, while Fig. 7 illustrates basic guidelines for customizing.

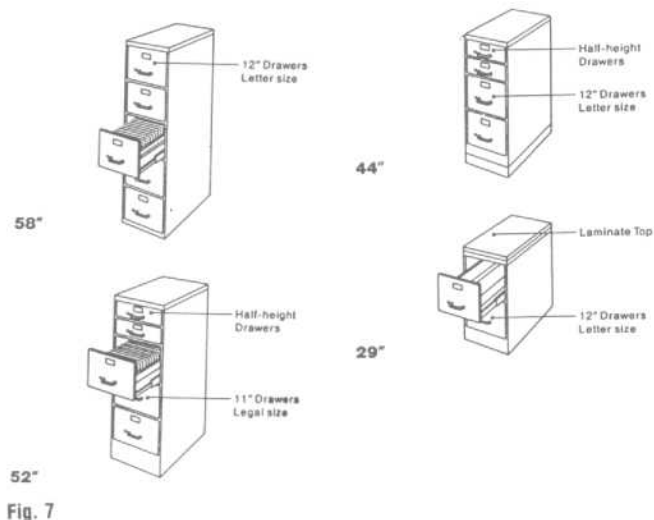



Fig. 7

## FURNITURE, FURNISHINGS, AND EQUIPMENT





## Vertical File Drawers; Overfile Cabinets; Roll-Away Carts

TABLE 2 Vertical File Insert Drawers

Description	Inside dimensions			Linear capacity
	Depth	Width	Height	
Half-height (3x5 or 4x6 cards)	26 <sup>7</sup> / <sub>8</sub> "	6"(2)	4 <sup>3</sup> / <sub>8</sub> "	53 <sup>7</sup> / <sub>8</sub> ** (2 rows)
				
Half-height (checks)	26 <sup>7</sup> / <sub>8</sub> **	10 <sup>3</sup> / <sub>4</sub> "	4 <sup>3</sup> / <sub>8</sub> "	26 <sup>7</sup> / <sub>8</sub> "
Half-height (cash)	8 <sup>1</sup> / <sub>4</sub> "	3 <sup>1</sup> / <sub>4</sub> "	1 <sup>7</sup> / <sub>8</sub> "	Bills
	8 <sup>1</sup> / <sub>2</sub> "	11 <sup>1</sup> / <sub>2</sub> "	1 <sup>7</sup> / <sub>8</sub> "	Storage
	4 <sup>3</sup> / <sub>8</sub> "	2 <sup>1</sup> / <sub>4</sub> "	1 <sup>3</sup> / <sub>4</sub> "	Coin tray
Half-height (box)	26 <sup>7</sup> / <sub>8</sub> "	12 <sup>1</sup> / <sub>4</sub> "	4 <sup>3</sup> / <sub>4</sub> "	26 <sup>7</sup> / <sub>8</sub> " front-to-back 12 <sup>1</sup> / <sub>4</sub> " side-to-side
Half-height (microfilm)	26 <sup>1</sup> / <sub>4</sub> **	4"(3)	4 <sup>3</sup> / <sub>8</sub> "	80 <sup>3</sup> / <sub>4</sub> ** (3 compartments)
Full height (letter size)	26 <sup>7</sup> / <sub>8</sub> **	6"(2)	10 <sup>1</sup> / <sub>8</sub> "	53 <sup>7</sup> / <sub>8</sub> ** (2 compartments)
Full height (letter size)	26 <sup>7</sup> / <sub>8</sub> **	4"(3)	10 <sup>1</sup> / <sub>8</sub> "	80 <sup>3</sup> / <sub>4</sub> ** (3 compartments)
Full height (box)	26 <sup>7</sup> / <sub>8</sub> "	15 <sup>1</sup> / <sub>4</sub> "	4 <sup>3</sup> / <sub>4</sub> "	—
Full height (3x5 cards)	26 <sup>7</sup> / <sub>8</sub> **	5"(3)	4 <sup>1</sup> / <sub>2</sub> "	80 <sup>3</sup> / <sub>4</sub> ** (3 compartments)
Full height (4x6 cards)	26 <sup>7</sup> / <sub>8</sub> **	6 <sup>1</sup> / <sub>4</sub> "(2)	4 <sup>3</sup> / <sub>8</sub> "	53 <sup>7</sup> / <sub>8</sub> " (2 compartments)
Full height (legal size)	26 <sup>7</sup> / <sub>8</sub> **	7 <sup>1</sup> / <sub>2</sub> "(2)	10 <sup>1</sup> / <sub>8</sub> "	See style no. C
Full height (legal size)	26 <sup>7</sup> / <sub>8</sub> **	5"(3)	10 <sup>1</sup> / <sub>8</sub> "	See style no. D

\*Deduct <sup>5</sup>/<sub>8</sub>" when compressor is used.

TABLE 3 Drawers, Overfile Cabinets, and Roll-Away File Cart

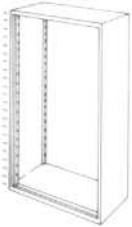
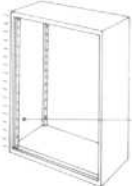


Description	Width	Inside dimensions			Linear capacity
		Depth	Width	Height	
12" Letter-size drawer	—	27 <sup>3</sup> / <sub>8</sub> "	12 <sup>1</sup> / <sub>4</sub> "	10 <sup>1</sup> / <sub>2</sub> "	27 <sup>3</sup> / <sub>8</sub> " front-to-back *
					
12" Legal-size drawer	—	27 <sup>3</sup> / <sub>8</sub> "	15 <sup>1</sup> / <sub>4</sub> "	10 <sup>1</sup> / <sub>2</sub> "	27 <sup>3</sup> / <sub>8</sub> " front-to-back
					
Description	Width	Outside/inside dimensions			Linear capacity
		Depth	Width	Height	
Overfile cabinet Fits over two letter-size files	29 <sup>3</sup> / <sub>4</sub> "	28 <sup>5</sup> / <sub>8</sub> "/28 <sup>1</sup> / <sub>2</sub> "†	29 <sup>3</sup> / <sub>4</sub> "/27 <sup>7</sup> / <sub>8</sub> "	28 <sup>1</sup> / <sub>8</sub> " /25 <sup>3</sup> / <sub>8</sub> "	55 <sup>3</sup> / <sub>4</sub> " side-to-side on 2 shelves (1 adj., <sup>3</sup> / <sub>4</sub> " thick)
					
Overfile cabinet Fits over two legal-size files	35 <sup>3</sup> / <sub>4</sub> "	28 <sup>5</sup> / <sub>8</sub> "/28 <sup>1</sup> / <sub>2</sub> "†	35 <sup>3</sup> / <sub>4</sub> "/33 <sup>7</sup> / <sub>8</sub> "	28 <sup>1</sup> / <sub>8</sub> "/25 <sup>3</sup> / <sub>8</sub> "	67 <sup>3</sup> / <sub>4</sub> " side-to-side on 2 shelves (1 adj., <sup>3</sup> / <sub>4</sub> " thick)
Overfile cabinet Fits over three letter size files	44 <sup>5</sup> / <sub>8</sub> "	28 <sup>5</sup> / <sub>8</sub> "/28 <sup>1</sup> / <sub>2</sub> "†	44 <sup>5</sup> / <sub>8</sub> "/42 <sup>3</sup> / <sub>4</sub> "	28 <sup>1</sup> / <sub>8</sub> "/25 <sup>3</sup> / <sub>8</sub> "	85 <sup>1</sup> / <sub>2</sub> " side-to-side on 2 shelves (1 adj., <sup>3</sup> / <sub>4</sub> " thick)
Overfile cabinet Fits over three legal-size files	53 <sup>5</sup> / <sub>8</sub> "	28 <sup>5</sup> / <sub>8</sub> "/28 <sup>1</sup> / <sub>2</sub> "†	53 <sup>5</sup> / <sub>8</sub> "/51 <sup>3</sup> / <sub>4</sub> "	28 <sup>1</sup> / <sub>8</sub> "/25 <sup>3</sup> / <sub>8</sub> "	103 <sup>1</sup> / <sub>2</sub> " side-to-side on 2 shelves (1 adj., <sup>3</sup> / <sub>4</sub> " thick)
Roll-away file cart		30 <sup>1</sup> / <sub>4</sub> "/28"	15 <sup>1</sup> / <sub>8</sub> "/12 <sup>1</sup> / <sub>8</sub> "	22 <sup>7</sup> / <sub>8</sub> "/13 <sup>3</sup> / <sub>8</sub> "	25" Letter/legal
					

\*Deduct <sup>5</sup>/<sub>8</sub>" when compressor is used.†Deduct 1<sup>1</sup>/<sub>2</sub>" when ordered with sliding doors.

## FURNITURE, FURNISHINGS, AND EQUIPMENT

## Lateral File Cabinets

TABLE 4 Lateral File Cabinets

Description (cabinet inside height)	Cabinet width	Outside/inside dimensions		
		Depth	Width	Height
 60"	30"	18"/17 1/8"*	30"/28 1/2"	64 5/8"/60"
	36"	18"/17 1/8"*	36"/34 1/2"	64 5/8"/60"
	42"	18"/17 1/8"*	42"/40 1/2"	64 5/8"/60"
 48"	30"	18"/17 1/8"*	30"/28 1/2"	52 3/8"/48"
	36"	18"/17 1/8"*	36"/34 1/2"	52 3/8"/48"
	42"	18"/17 1/8"*	42"/40 1/2"	52 3/8"/48"
 36"	30"	18"/17 1/8"*	30"/28 1/2"	41 1/4"/36"
	36"	18"/17 1/8"*	36"/34 1/2"	41 1/4"/36"
	42"	18"/17 1/8"*	42"/40 1/2"	41 1/4"/36"
 24"	30"	18"/17 1/8"*	30"/28 1/2"	28 1/4"/24"
	36"	18"/17 1/8"*	36"/34 1/2"	28 1/4"/24"
	42"	18"/17 1/8"*	42"/40 1/2"	28 1/4"/24"

## Loaded Weights

Description	Cabinet inside height											
	24"			36"			48"			60"		
Cabinet width	30"	36"	42"	30"	36"	42"	30"	36"	42"	30"	36"	42"
Loaded weight in pounds	285	336	391	401	475	553	524	645	720	610	725	843

\*Deduct 5/8" when compressor is used.



24"



36"



48"



60"

Standard lateral file cabinets are usually available in three widths — 30", 36", and 42" — and with 12"-high drawers or roll-out shelves. Some cabinets are designed on a 3" module to accommodate 3", 6", 9", 12", and 15"-high drawers and shelves.

Ganging hardware is usually included with each file cabinet. Cabinets should be ganged with adjacent files or bolted to the floor. Counterbalance weights should be used for single-application files.

Table 4 shows the outside and inside dimensions of four lateral file cabinets, and their loaded floor weights based on 12"-high drawers filled to capacity.

It should be noted that the dimensional data and load factors are based on Steelcase cabinets. Although these data are adequate for preliminary planning purposes, it is essential that the data of the equipment being specified are verified with its manufacturer.

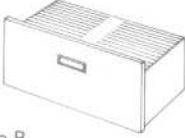

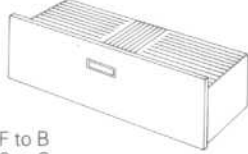


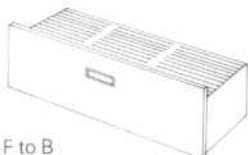
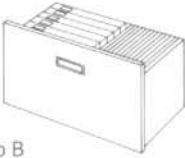
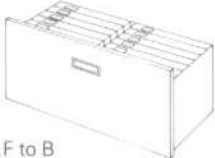
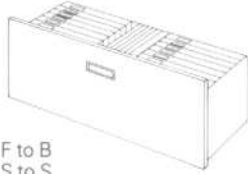
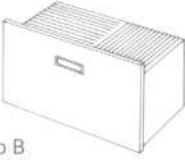
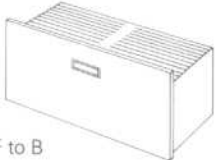

## FURNITURE, FURNISHINGS, AND EQUIPMENT

## Lateral File Cabinets

## Filing Arrangements

Most lateral file drawers are designed for filing both letter-size and legal-size documents, in addition to EDP printouts. Lateral file drawers can usually accommodate materials in a front-to-back (F to B) arrangement or in a side-to-side (S to S) arrangement. In some instances a combination of the two is possible. The actual capacity in linear inches for each arrangement and for each particular drawer or shelf has been calculated and is shown in the "Linear capacity" column in Tables 2, 3, 6, 7 and 8. It should be noted that the dimensional data in Table 5 are based on Steelcase drawers.




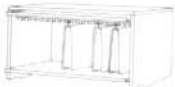
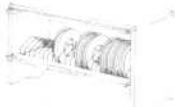

TABLE 5 Filing Arrangements

Description	30" width	36" width	42" width
Letter/legal, 12" drawer	 <p>F to B</p>	 <p>F to B</p>	 <p>F to B S to S</p>
	 <p>F to B S to S</p>	 <p>F to B S to S</p>	 <p>F to B</p>
EDP binders, 15" drawer	 <p>F to B S to S</p>	 <p>F to B</p>	 <p>F to B S to S</p>
EDP folders, 15" drawer	 <p>F to B S to S</p>	 <p>F to B</p>	 <p>F to B S to S</p>

## FURNITURE, FURNISHINGS, AND EQUIPMENT

## Lateral File Cabinets

TABLE 6 Drawers, Shelves, Add-On Cabinets

Description	File cabinet width	Style no.	Outside/inside dimensions			Linear capacity
			Depth	Width	Height	
12" legal fixed shelf with door 	30"		16½"	28½"	10½"*	28½" side-to-side
	36"		16½"	34½"	10½"*	34½" S to S
	42"		16½"	40½"	10½"*	40½" S to S
15" legal fixed shelf with door 	30"		16½"	28½"	13½"	28½" S to S
	36"		16½"	34½"	13½"	34½" S to S
	42"		16½"	40½"	13½"	40½" S to S
Center hook filing hanger bar 	30"		17"	28½"	10⅝" (12" high door) 12¾" (15" high door)	28½" S to S 28½" S to S
	36"		17"	34½"	10⅝" (12" high door) 12¾" (15" high door)	34½" S to S 34½" S to S
	42"		17"	40½"	10⅝" (12" high door) 12¾" (15" high door)	40½" S to S 40½" S to S
T-bar 	30"		17"	28½"	10¼" (12" high door) 12¾" (15" high door)	28½" S to S 28½" S to S
	36"		17"	34½"	10¼" (12" high door) 12¾" (15" high door)	34½" S to S 34½" S to S
	42"		17"	40½"	10¼" (12" high door) 12¾" (15" high door)	40½" S to S 40½" S to S
Wire tape rack 	30"		17"	28½"	7⅞" ( 9" high door) 10⅞" (12" high door) 13⅞" (15" high door)	28½" S to S 28½" S to S 28½" S to S
	36"		17"	34½"	7⅞" ( 9" high door) 10⅞" (12" high door) 13⅞" (15" high door)	34½" S to S 34½" S to S 34½" S to S
	42"		17"	40½"	7⅞" ( 9" high door) 10⅞" (12" high door) 13⅞" (15" high door)	40½" S to S 40½" S to S 40½" S to S
Add-on cabinet 	30"	830-610	18"/16⅜"*	30"/28⅞"	15¾"/13⅞"	28⅞" S to S
	36"	836-610	18"/16⅜"*	36"/34⅞"	15¾"/13⅞"	34⅞" S to S
	42"	842-610	18"/16⅜"*	42"/40⅞"	15¾"/13⅞"	40⅞" S to S
	30"	830-710	18"/16⅜"*	30"/28⅞"	28⅞"/25⅞"	28⅞" S to S
	36"	836-710	18"/16⅜"*	36"/34⅞"	28⅞"/25⅞"	34⅞" S to S
	42"	842-710	18"/16⅜"*	42"/40⅞"	28⅞"/25⅞"	40⅞" S to S

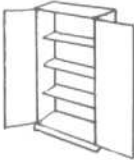
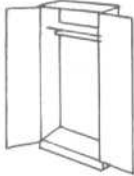
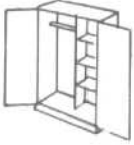

\*Deduct ⅝" when compressor is used.

## FURNITURE, FURNISHINGS, AND EQUIPMENT

## Storage Cabinets

Standard cabinets often provide a fast, flexible, and economical solution to many storage problems. Table 7 provides dimensional data and capacities for four typical cabinet types. These cabinets are manufactured by Steelcase. The dimensions of cabinets of other manufacturers will differ somewhat. The data in Table 7, however, are adequate for preliminary planning purposes.

TABLE 7 Storage Cabinets






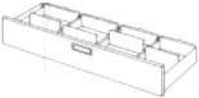
Description	Outside/inside dimensions			Linear capacity
	Depth	Width	Height	
Storage cabinet 	18"/17"	36"/33 $\frac{1}{8}$ "	41 $\frac{1}{4}$ "/35 $\frac{5}{8}$ "	99 $\frac{1}{2}$ " side-to-side on 3 shelves (2 adj., 1" thick)
	18"/17"	36"/33 $\frac{1}{8}$ "	52 $\frac{3}{8}$ "/46 $\frac{3}{8}$ "	99 $\frac{1}{2}$ " S to S on 3 shelves (2 adj., 1" thick)
	18"/17"	36"/33 $\frac{1}{8}$ "	64 $\frac{5}{8}$ "/58 $\frac{3}{4}$ "	132 $\frac{3}{4}$ " S to S on 4 shelves (3 adj., 1" thick)
	18"/17"	36"/33 $\frac{1}{8}$ "	80 $\frac{1}{2}$ "/74 $\frac{1}{2}$ "	165 $\frac{5}{8}$ " S to S on 5 shelves (4 adj., 1" thick)
	24"/23"	36"/33 $\frac{1}{8}$ "	64 $\frac{5}{8}$ "/58 $\frac{3}{4}$ "	132 $\frac{3}{4}$ " S to S on 4 shelves (3 adj., 1" thick)
	24"/23"	36"/33 $\frac{1}{8}$ "	80 $\frac{1}{2}$ "/74 $\frac{1}{2}$ "	165 $\frac{5}{8}$ " S to S on 5 shelves (4 adj., 1" thick)
Wardrobe cabinet 	18"/17"	36"/33 $\frac{1}{8}$ "	52 $\frac{3}{8}$ "/46 $\frac{3}{8}$ "	Not for filing
	18"/17"	36"/33 $\frac{1}{8}$ "	64 $\frac{5}{8}$ "/58 $\frac{3}{4}$ "	Not for filing
	18"/17"	36"/33 $\frac{1}{8}$ "	80 $\frac{1}{2}$ "/74 $\frac{1}{2}$ "	Not for filing
	24"/23"	36"/33 $\frac{1}{8}$ "	64 $\frac{5}{8}$ "/58 $\frac{3}{4}$ "	Not for filing
	24"/23"	36"/33 $\frac{1}{8}$ "	80 $\frac{1}{2}$ "/74 $\frac{1}{2}$ "	Not for filing
Wardrobe/storage cabinet 	18"/17"	36"/33 $\frac{1}{8}$ "	52 $\frac{3}{8}$ "/46 $\frac{3}{8}$ "	43 $\frac{1}{4}$ " S to S on 3 shelves (2 adj., 1" thick)
	18"/17"	36"/33 $\frac{1}{8}$ "	64 $\frac{5}{8}$ "/58 $\frac{3}{4}$ "	58" S to S on 4 shelves (3 adj., 1" thick)
	18"/17"	36"/33 $\frac{1}{8}$ "	80 $\frac{1}{2}$ "/74 $\frac{1}{2}$ "	58" S to S on 4 shelves (3 adj., 1" thick)
	24"/23"	36"/33 $\frac{1}{8}$ "	64 $\frac{5}{8}$ "/58 $\frac{3}{4}$ "	58" S to S on 4 shelves (3 adj., 1" thick)
	24"/23"	36"/33 $\frac{1}{8}$ "	80 $\frac{1}{2}$ "/74 $\frac{1}{2}$ "	58" S to S on 4 shelves (3 adj., 1" thick)
Wardrobe 	18"/16 $\frac{5}{8}$ "	18"/15 $\frac{1}{8}$ "	41 $\frac{1}{8}$ "/35 $\frac{7}{8}$ "	15 $\frac{1}{8}$ " on bar
	18"/16 $\frac{5}{8}$ "	18"/15 $\frac{1}{2}$ "	52 $\frac{1}{4}$ "/47"	15 $\frac{1}{2}$ " on bar
	18"/16 $\frac{5}{8}$ "	18"/15 $\frac{1}{8}$ "	64 $\frac{1}{2}$ "/59 $\frac{1}{4}$ "	15 $\frac{1}{8}$ " on bar

## FURNITURE, FURNISHINGS, AND EQUIPMENT

## Interior Card Trays

TABLE 8 Interior Card Trays

(For use in vertical or lateral files)

Description	Style No.	Inside dimensions			Linear capacity
		Depth	Width	Height	
3 x 5 card 	4335	11 $\frac{7}{8}$ "	5"	3 $\frac{1}{4}$ "	10 $\frac{1}{4}$ "
3 x 5 card	4337M	14 $\frac{7}{8}$ "	5"	3 $\frac{1}{4}$ "	13 $\frac{1}{4}$ "
5 x 8 card 	4355	11 $\frac{7}{8}$ "	8 $\frac{1}{8}$ "	4 $\frac{3}{4}$ "	11 $\frac{1}{4}$ "
5 x 8 card	4357	14 $\frac{7}{8}$ "	8 $\frac{1}{8}$ "	4 $\frac{3}{4}$ "	13 $\frac{1}{4}$ "
4 x 6 card 	800-TN-46	12"	6 $\frac{1}{8}$ "	4 $\frac{3}{8}$ "	11 $\frac{3}{8}$ "
4 x 6 card	800-TW-46	15"	6 $\frac{1}{8}$ "	4 $\frac{3}{8}$ "	14 $\frac{3}{8}$ "
Tab card 	7201	11 $\frac{7}{8}$ "	7 $\frac{1}{2}$ "	3 $\frac{3}{8}$ "	10 $\frac{3}{8}$ "
Tab card	7204	14 $\frac{7}{8}$ "	7 $\frac{1}{2}$ "	3 $\frac{3}{8}$ "	13 $\frac{3}{8}$ "
Coin and bill 	4388	8 $\frac{1}{4}$ " 5 $\frac{7}{8}$ "	3 $\frac{1}{8}$ " 11 $\frac{1}{2}$ "	1 $\frac{7}{8}$ " 1 $\frac{7}{8}$ "	* †
Coin and bill	4389	7 $\frac{7}{8}$ " 2 $\frac{3}{8}$ "	3 $\frac{3}{4}$ " 2 $\frac{1}{4}$ "	1 $\frac{7}{8}$ " 1 $\frac{3}{4}$ "	* †
Number of card trays accommodated per 6"-high drawer or shelf					
		4337M	800TW46†	4357	7204M
6" high shelves/drawers 	842 DWDV-6	7	5	4	5
	842 SWDV-6	7	5	—	5
	836 DWDV-6	6	4	3	4
	836 SWDV-6	6	4	—	4
	830 DWDV-6	5	3	3	3
	830 SWDV-6	5	3	3	3
	830 SWDV-3	5	3	—	3

\*Dimensions of each of 6 bill compartments.

†Dimensions of each of 5 coin compartments.

‡Card trays cannot be installed in 6"-high shelf located directly below a door. Use 3"-high shelf and refer to guidelines.

FURNITURE, FURNISHINGS, AND EQUIPMENT

Storage Components Glossary



**Lower storage/Lateral file**  
Free-standing wall- or panel-mounted files with width dimension greater than depth dimension.



**Rails**  
Mount in lateral file for drawer suspended filing, front-to-back or side-to-side.



**Media compartment kit**  
Can be retrofit or factory assembled to 800/900 Series 6" roll-out shelf. Provides dividers and partitions adjustable for storing a variety of media-cassettes, mini-cassettes, cartridges, floppy disks, and more.



**Storage cabinet**  
Storage for general supplies. Available in 2, 3, or 4 adjustable shelves.



**Mobile pedestal**  
Supports drawers in several combinations and has casters for mobility.



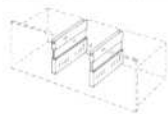
**T-bar filing for bound printouts**  
Accepts EDP printouts in T-bar type binders.



**Overfile cabinet**  
For use above lateral or vertical files. Sliding door, lock, and shelf-modifier options.



**Vertical file**  
Letter- or legal-size filing cabinet with depth dimension greater than width dimension. For front-to-back filing only.



**Partition**  
A double metal wall that mounts into a lateral file drawer to divide drawer.



**Vertical file drawer**  
6" high and 12" high drawers for letter or legal-size filing cabinets.



**Personal drawer**  
For personal items. An adjustable divider is included. 3" high.



**Wardrobe**  
Provides full-width coat rod for hanging clothes mounted beneath full-width shelf.



**Pull-out keyboard shelf**  
Attaches beneath work-surface for computer keyboard support and storage.



**Wire tape racks**  
Racks can be freestanding or built-in to lateral files for storage of magnetic tapes and disk cartridges on edge. Dividers can be positioned to accommodate media of different thicknesses.

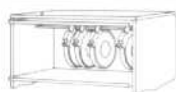


## FURNITURE, FURNISHINGS, AND EQUIPMENT

## Storage Components Glossary

**Bookcase**

Units have adjustable shelves which can accommodate rows of standard ring binders and other bound materials.

**Center hook filing hanging bar**

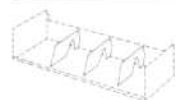
Accepts printouts and magnetic tape reels with center hooks.

**Combination wardrobe and storage cabinet**

Units are divided – space for hanging clothes and two or three vertically adjustable shelves.

**Compressor**

A spring-loaded plate that supports file material. Can be moved and locked in position. Used in vertical and lateral file drawers, pedestal file drawers and card trays.

**Divider**

Metal plate used to separate and support file material. For lateral file and pedestal file drawers, fixed and roll-out shelves.

**Double-door storage cabinet**

For miscellaneous storage below worksurface. Includes one adjustable shelf and two swing-arm doors.

**File drawer**

For letter- or legal-size documents 12" and 15" high. 15" high drawers can also be used for computer printouts. For front-to-back or side-to-side or combination filing.

**File insert drawers**

For use in vertical files instead of card trays.

**Hanging folder frame**

A metal rod mounted in lateral and vertical files for suspended file material. Can be mounted on partitions for front-to-back filing.

**Interior card trays**

Portable trays in various sizes for common card sizes: 3 x 5, 4 x 6, etc. Compressor included.

**Lateral file drawer**

3" tray drawer, 6" card drawer, and 9", 12" and 15" high file drawers. Letter or legal-size filing. Dividers, three sway blocks, compressor, hanging folder frames, rails, or partitions available.

**Lateral file fixed shelf**

12" or 15" high shelves with or without doors and with three dividers.

**Lateral file posting shelf**

Metal pull-out shelf option on 48" and 60" interior height lateral files. When not specified, the space will be filled by a posting shelf filler.

**Lateral file roll-out shelf**

3", 6", 12", and 15" high shelves extend for accessibility.

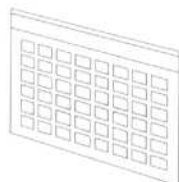
**Lateral file workshelf**

3" high roll-out workshelf with laminate surface.

## FURNITURE, FURNISHINGS, AND EQUIPMENT

## Electronic Media Storage

## Microfiche

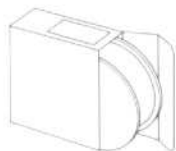


4" x 6"

**Description** Microfiche is a 4" x 6" film transparency containing multiple rows of greatly reduced page images of any written, printed or graphic material. Image reductions range from 13 up to several hundred times smaller than the originals. A microfiche viewer enlarges the images so that they are readable. Labeling information is written or printed on a narrow strip along the long edge at the top of the microfiche.

Microfiche may be stored in interior card trays, in lateral file 6"-high roll-out shelves, and in a lateral file media compartment.

## Microfilm



1" x 4" diameter reel  
(1¼" x 4¼" x 4¼" box)

**Description** Microfilm is roll photographic film on a reel or in a square cartridge that contains images of pages of written, graphic or printed material reduced hundreds of times. A microfilm viewer enlarges the images so that they are readable. Microfilm on a reel is kept in a square plastic or cardboard box for protection and ease of handling. Microfilm is most conveniently stored on edge. Labeling is placed on one of the edges of the reel or box.

Microfilm may be stored in the lateral file media compartment kit, in an interior card tray, and in lateral file 6"-high drawers or shelves.

## Print-out Paper



**Description** Print-out paper, also known as continuous form data processing paper, is used in almost all computer printers and some word processing equipment. The most common types are recognizable by:

- Small "pin-feed" holes along both edges which are used by the printer to grip and advance the paper.

- Green or grey-shaded stripes across the paper which serve to organize the printed information.

After printing, the print-out may exist in a "fan-folded" stack or it may be "burst," i.e., separated into individual sheets along the perforations that exist at the fold lines.

If the print-out consists of a significant number of sheets, it may be "bound" for easier handling. Fan-folded printouts *must* be bound along the top or long edge. Print-outs

that have been burst may be bound along *either* the long edge *or* the short edge. The binding may consist of only a narrow metal or plastic clamp or it may be include a stiff plastic or fiberboard cover. Frequently the binding may include hooks at both ends so the print-out may be hung from two rails like a hanging file folder. Other hooks may be used to suspend it from special bars or rails.

Identification information may be marked on one of the edges (depending on how the print-out is stored) or on the front sheet of the binding cover.

Print-out paper may be stored in Steelcase lateral and vertical files depending on the paper size. Check the file which will accommodate your paper. Boxed paper can be stored in storage cabinets.

## Cartridges



5/8" x 4" x 6" (cartridge)  
7/8" x 4¼" x 6¼" (cartridge in case)

**Description** Cartridges have ¼" wide magnetic tape loaded into a reel-to-reel cartridge generally made of clear plastic with metal back plate. They look similar to an oversize recording cassette. Cartridges come in and are sometimes stored in a "flip-open" plastic or cardboard box. Labels or identification information are located on the long edge or on the side along the long edge of the cartridge or the box.

Cartridges may be stored in interior card trays or in a media compartment kit in lateral file 6"-high drawers or shelves.

**Cassettes****Standard Cassette Case**

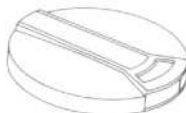
$1\frac{1}{16}'' \times 2\frac{3}{4}'' \times 4\frac{5}{16}''$

**Mini Cassette Case**

$\frac{7}{16}'' \times 1\frac{1}{2}'' \times 2\frac{7}{8}''$

**Description** Cassettes are available in "standard" and "mini" sizes and consist of magnetic tape loaded into a reel-to-reel configuration in a plastic case. Standard cassettes for electronic equipment are identical in size and appearance to those used for home recording. Cassettes may be used in microcomputers and in word processing or dictation equipment. They come in and are frequently stored in a flip-open plastic case. Labels or identification information may be located on the long edge or side of the cassette or its case.

Cassettes may be stored in a lateral file media compartment kit.

**Disk Cartridges**

1" x 10" diameter

3" x 10" diameter

1" x 15" diameter

3" x 15" diameter

**Description** Disk cartridges are round plastic cases which contain a series of rotating platters (or disks) on which data is magnetically recorded. The number of platters in a case varies with the height of the case. In use, the entire case is inserted in a computer disk drive unit where recording arms, which read/record information, enter the case through a slot with a spring door.

Disk cartridges are flat in appearance with an elongated Y-shaped protrusion on the top. They can be stored flat or on edge.

Labels for identification are usually located on the edge of the disk cartridge. Frequently disk cartridges have to be stored in a temperature/humidity controlled environment.

Disk cartridges may be stored in lateral file 6"-high roll-out shelves, storage cabinets, and bookcases.

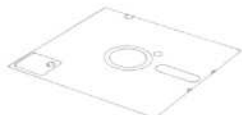
**Disk Packs**

7" x 10" diameter

7" x 15" diameter

**Description** Disk packs are round plastic cases which contain a series of rotating platters (or disks) on which data is magnetically recorded. The number of platters in a unit varies with the height of the plastic case. In use, the entire case is inserted in a computer disk drive unit where recording arms, to read/record information, enter the case through a slot with a spring door. Disk packs are flat on the bottom and upright with the handle on top. Identification is generally located on the edge of the disk pack. These units should be stored in a temperature/humidity controlled environment. Disk packs *must not* be stored one on another.

Disk packs may be stored in storage cabinets, bookcases, and on 3"- and 6"-high lateral file shelves.

**Floppy (Flexible) Disks**

8" x 8"

$5\frac{1}{4}'' \times 5\frac{1}{4}''$

$3\frac{1}{2}'' \times 3\frac{1}{2}''$

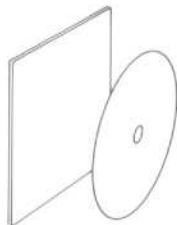
**Description** Floppy disks, also called diskettes or flexible disks, are small record-like disks each permanently enclosed in a square, stiff paper envelope. They are used to magnetically record information in all types of small computer and word processing equipment. Labels are placed on the paper envelope.

Floppy disks may be stored in 12"-high lateral file drawers and shelves.

FURNITURE, FURNISHINGS, AND EQUIPMENT

Electronic Media Storage

Laser Disks



12 1/4" x 12 3/8" jacket  
12" diameter  
4 3/4" diameter

**Description** Laser disks look like long-play record albums complete with a paper protective sleeve. Data are stored and retrieved by laser beam.

Laser disks may be stored in 15"-high lateral file drawers and shelves.

Magnetic, Tab, and Aperture Cards



3 1/4" x 7 3/8"

**Description** Magnetic cards, also known as mag cards, are a tab-size black plastic card with magnetic material coated on one or both sides. The cards are used to record or reproduce information in word processing equipment. In some cases one or more of the cards will be kept in a paper envelope. Identifying information will be marked on the face of the envelope.

Tab cards, also known as keypunch cards, are 80 column cards or punch cards with small holes in them to represent bits of data. Although they may be stored in a workstation or central storage area, they are usually used and produced in a mainframe computer room or keypunch department, and are stored in

specially separated decks. The decks are most frequently identified by markings across the edges of the cards.

Aperture cards are tab cards with a piece of microfilm mounted over a hole in their center. They are most frequently used for microfilm images of engineering or architectural drawings. Aperture card reader/printers enlarge the image on a screen for reference and, if required, reproduce a full-sized copy of the drawing. Identifying information is printed in a narrow band along the top (long edge) of the card.

These cards may be stored in interior card trays and in lateral file 6"-high drawers and roll-out shelves.

Magnetic Tape Reels



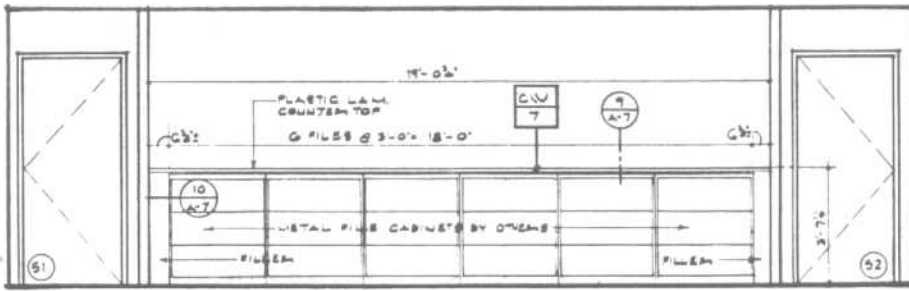
1" x 7 1/2" diameter  
1" x 8 1/2" diameter  
1" x 10 1/2" diameter  
1" x 15" diameter

**Description** Magnetic tape is typically 1/2" wide and loaded on reels of varying diameters. A flexible plastic strip locks around the outside of the reel to protect the tape and prevent unraveling when it is not in use. This media is used in large tape drive units that are generally found only in computer rooms. The long-term storage of magnetic tapes is subject to strict temperature and humidity requirements to prevent damage. Tapes are labeled both on the side and on the flexible strip that is placed around the edge of the reel. They can be stored flat or on edge. For flat storage, handle like disk cartridges.

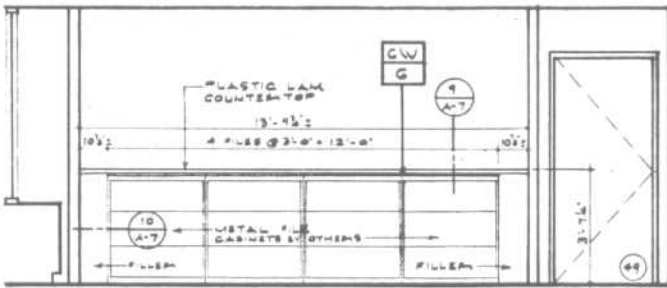
Magnetic tape reels may be stored in the lateral file add-on cabinets, storage cabinets, or in free-standing wire racks on lateral file shelves.

FURNITURE, FURNISHINGS, AND EQUIPMENT

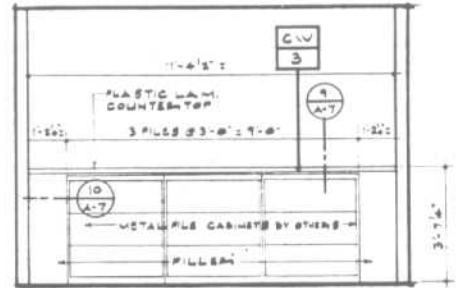
File Countertop



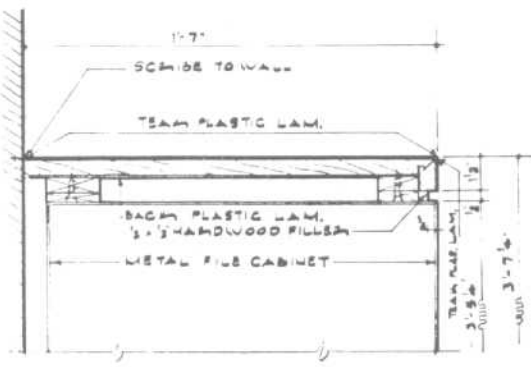
6 NORTH ELEVATION SPACE No. 15  
@ 1/2" = 1'-0"



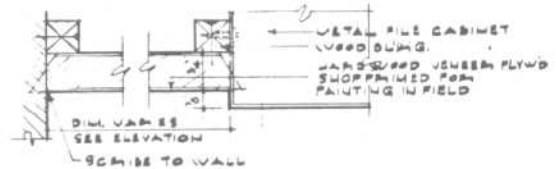
4 NORTH ELEVATION SPACE No. 16  
@ 1/2" = 1'-0"



3 WEST ELEVATION SPACE No. 12  
@ 1/2" = 1'-0"



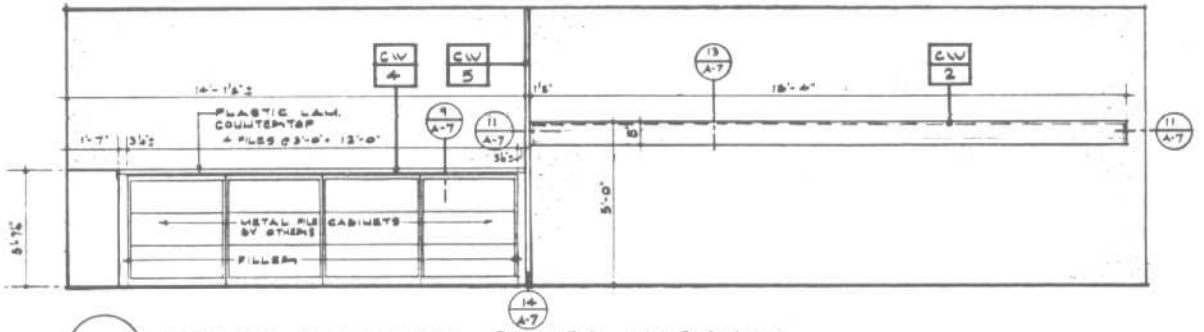
9 @ 3" = 1'-0"



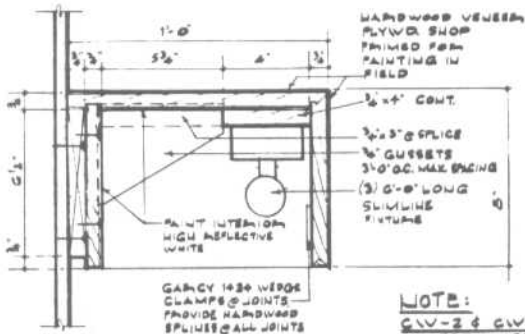
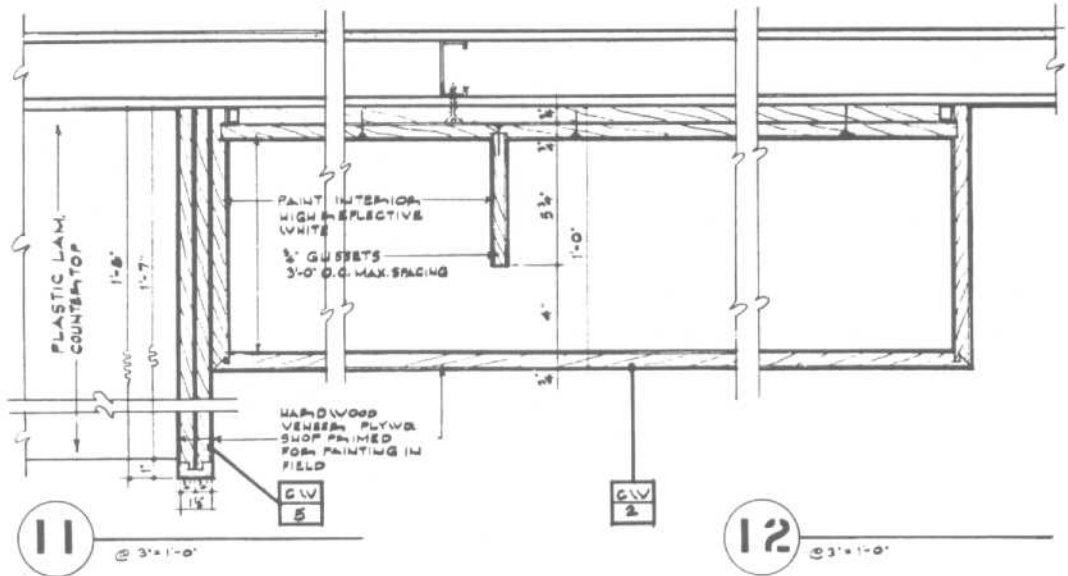
10 @ 1/2" FULL SIZE

FURNITURE, FURNISHINGS, AND EQUIPMENT

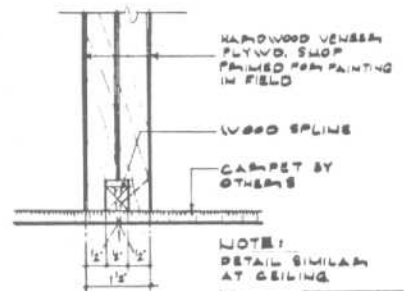
File Counter with Shelf Light



**3** NORTH ELEVATION SPACES 15, 21 + 20  
@ 3'-1'-0"



**NOTE:**  
CW-2 & CW-5 SHALL BE PAINTED W/ PRATT'S LAMBEAT #G124 TIGER LILY SEMI-GLOSS



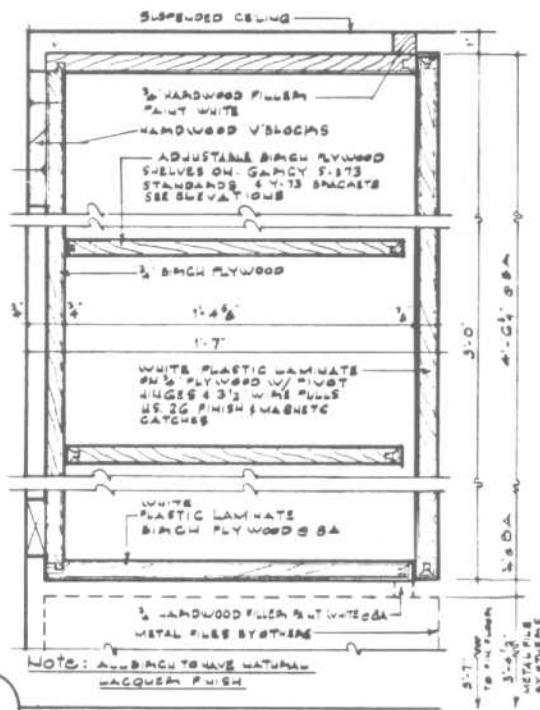
**NOTE:**  
DETAIL SIMILAR AT CEILING

**13** @ 3'-1'-0" **CW 2**

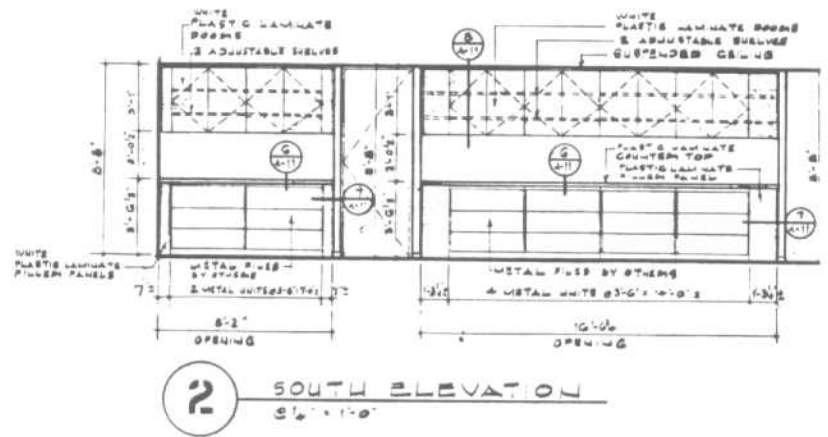
**14** @ 1/2\" FULL SIZE **CW 5**

FURNITURE, FURNISHINGS, AND EQUIPMENT

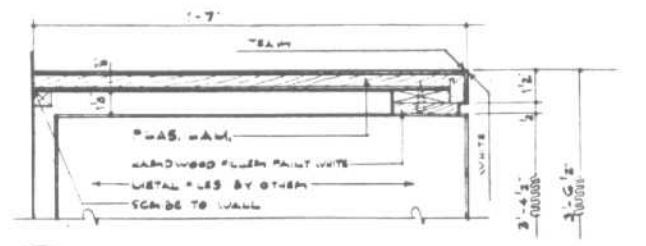
File Storage Walls with Overhead Cabinets



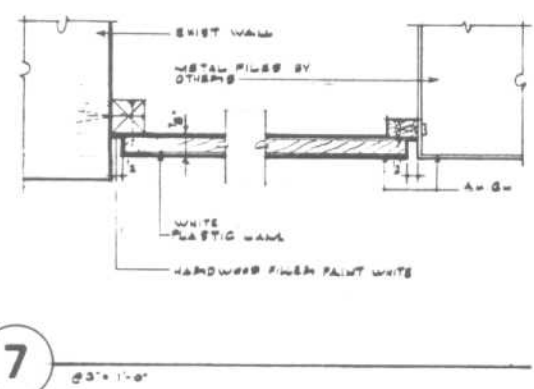
8



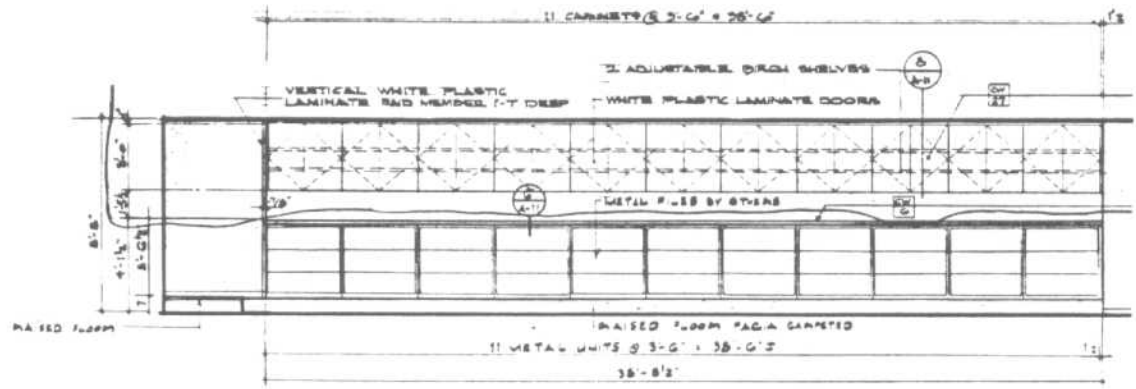
2 SOUTH ELEVATION  
8'-8" x 10'-0"



6



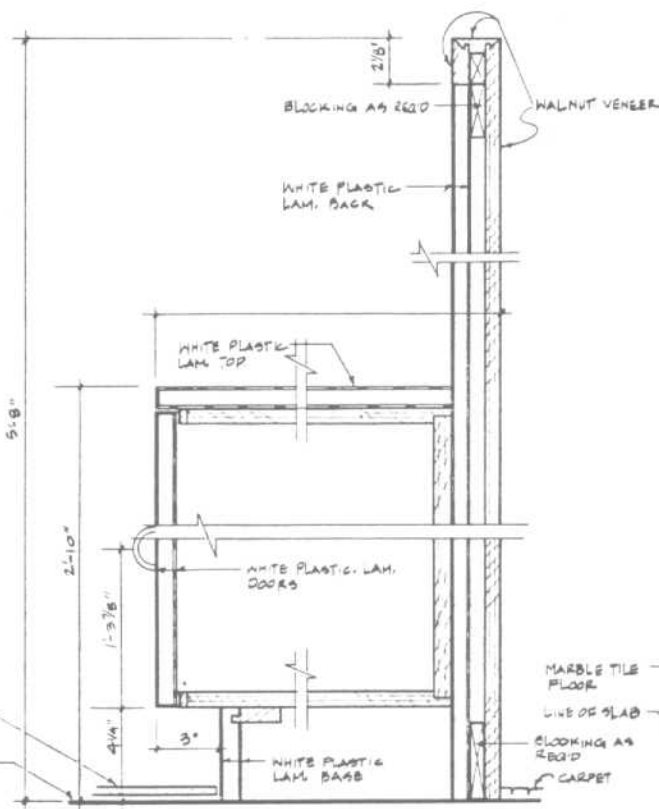
7 3'-0" x 1'-0"



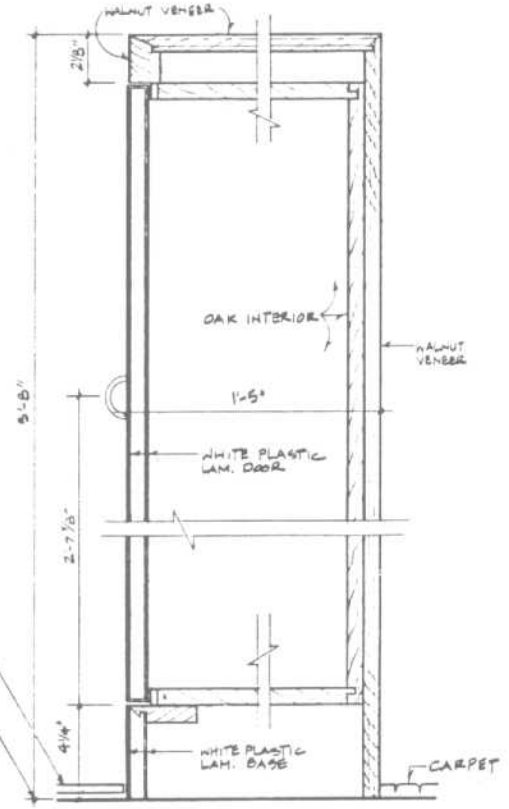
1 NORTH ELEVATION  
8'-8" x 36'-8 1/2"



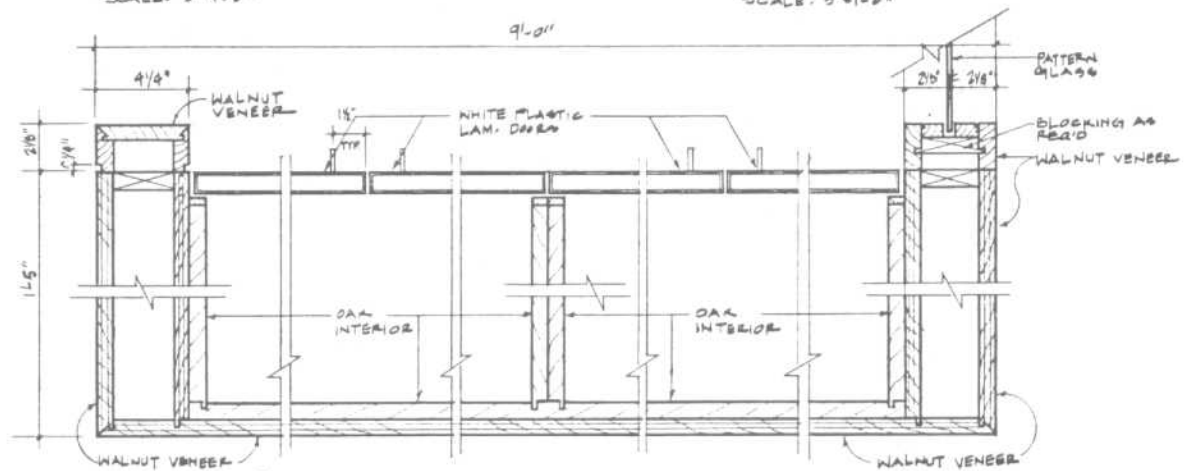




**SECTION 1**  
SCALE: 3"=1'-0"



**SECTION 2**  
SCALE: 3"=1'-0"

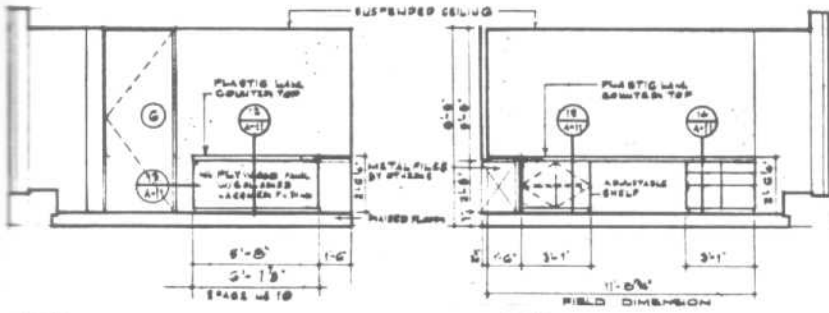


**SECTION 3**  
SCALE: 3"=1'-0"



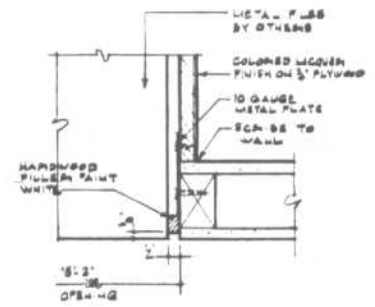
FURNITURE, FURNISHINGS, AND EQUIPMENT

Countertop with Base Cabinets

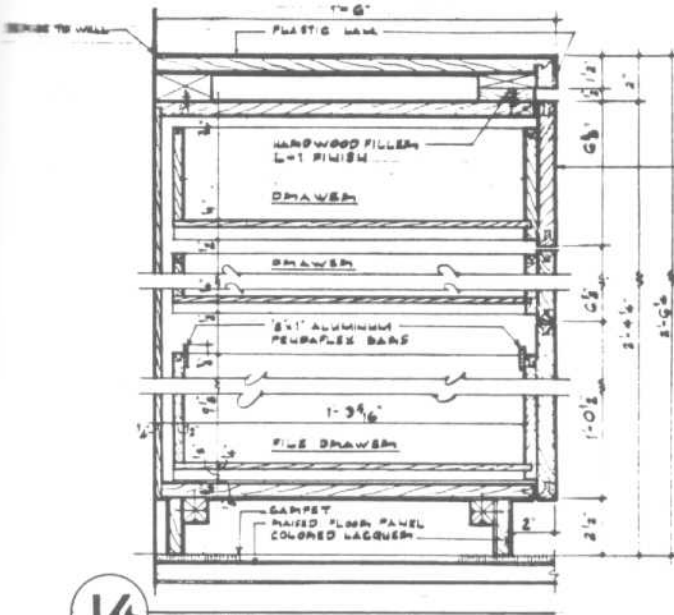


9 NORTH ELEVATION  
SPACE #19 @ 1/4" x 1'-0"

10 EAST ELEVATION  
SPACE #29 @ 1/4" x 1'-0"

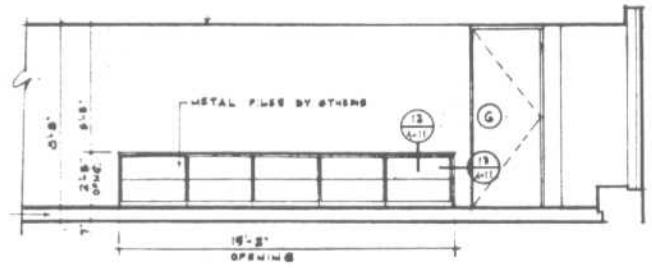


13 @ 1'-0"

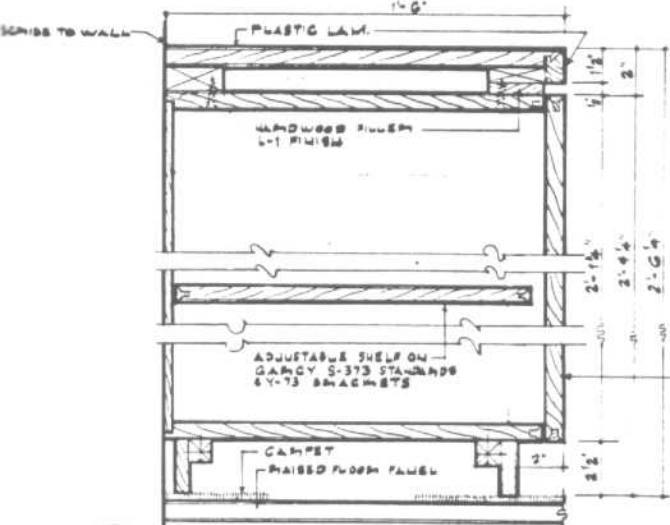


14 @ 3' x 1'-0"

COLORED LACQUER FINISH

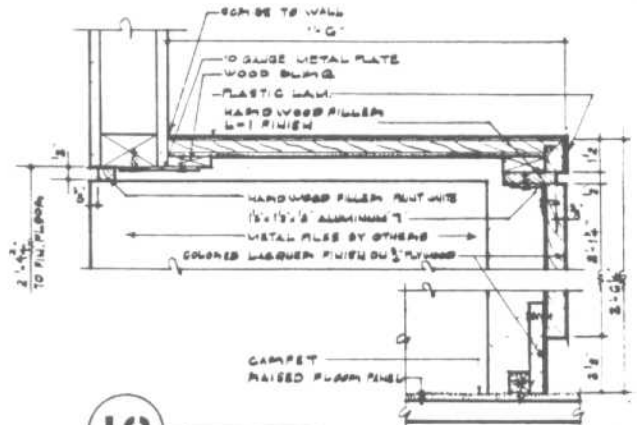


11 SOUTH ELEVATION SPACE #18  
@ 1/4" x 1'-0"

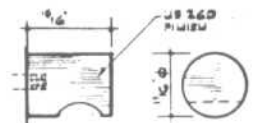


15 @ 3' x 1'-0"

COLORED LACQUER FINISH ON PLYWOOD



12 @ 3' x 1'-0"

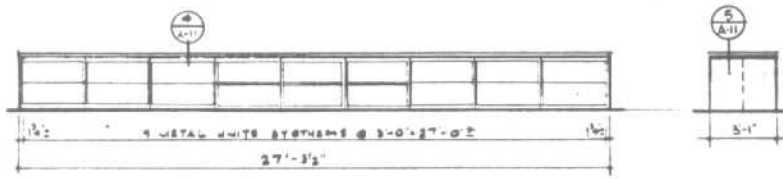


16 SIDE ELEVATION OF PULL  
FRONT ELEVATION OF PULL  
@ 1/4" x 1'-0"

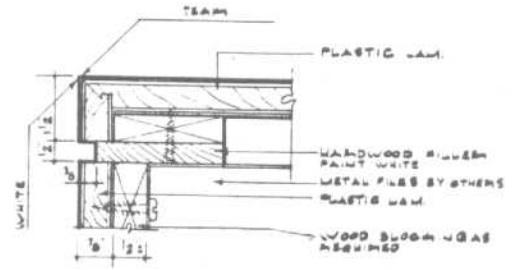
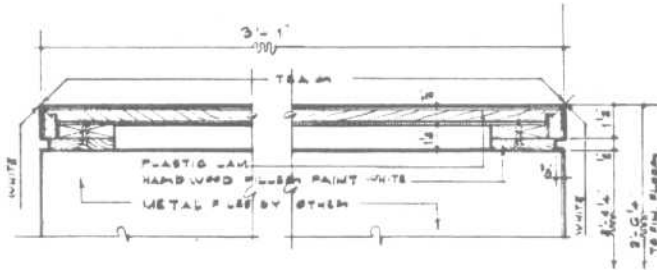
FURNITURE, FURNISHINGS, AND EQUIPMENT

Island File Counter, Compact Kitchen

ISLAND FILE COUNTER



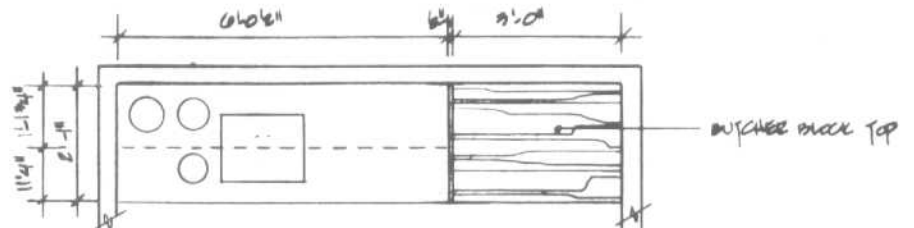
3 ISLAND UNIT  
@ 1/2" = 1'-0"



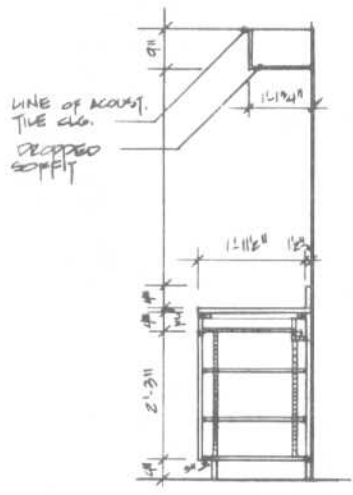
4 @ 3/4" = 1'-0"

5 @ 1/2" FULL SIZE

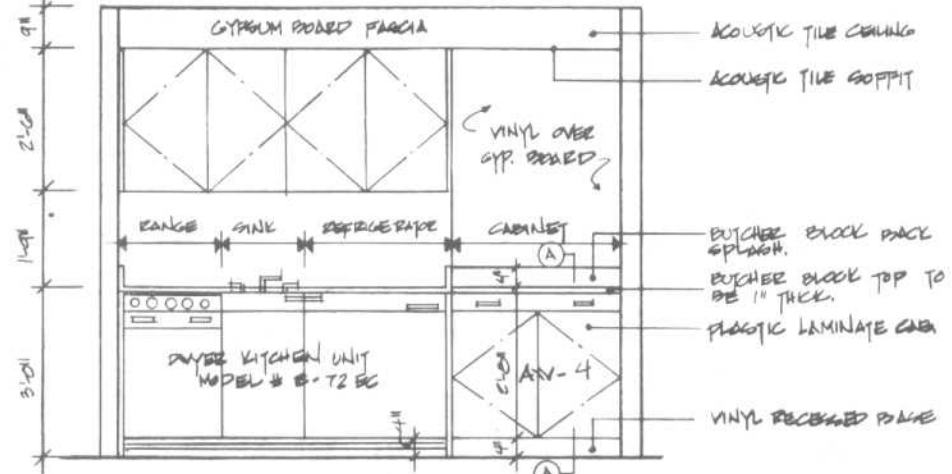
COMPACT KITCHEN



5 PLAN VIEW / PANTRY



5 AN-4 / SECTION A-A  
SCALE 1/2" = 1'-0"



5 ELEVATION / PANTRY  
SCALE 1/2" = 1'-0"

# Hospitality Spaces

Restaurants	307
Bars	346
Hotels	374

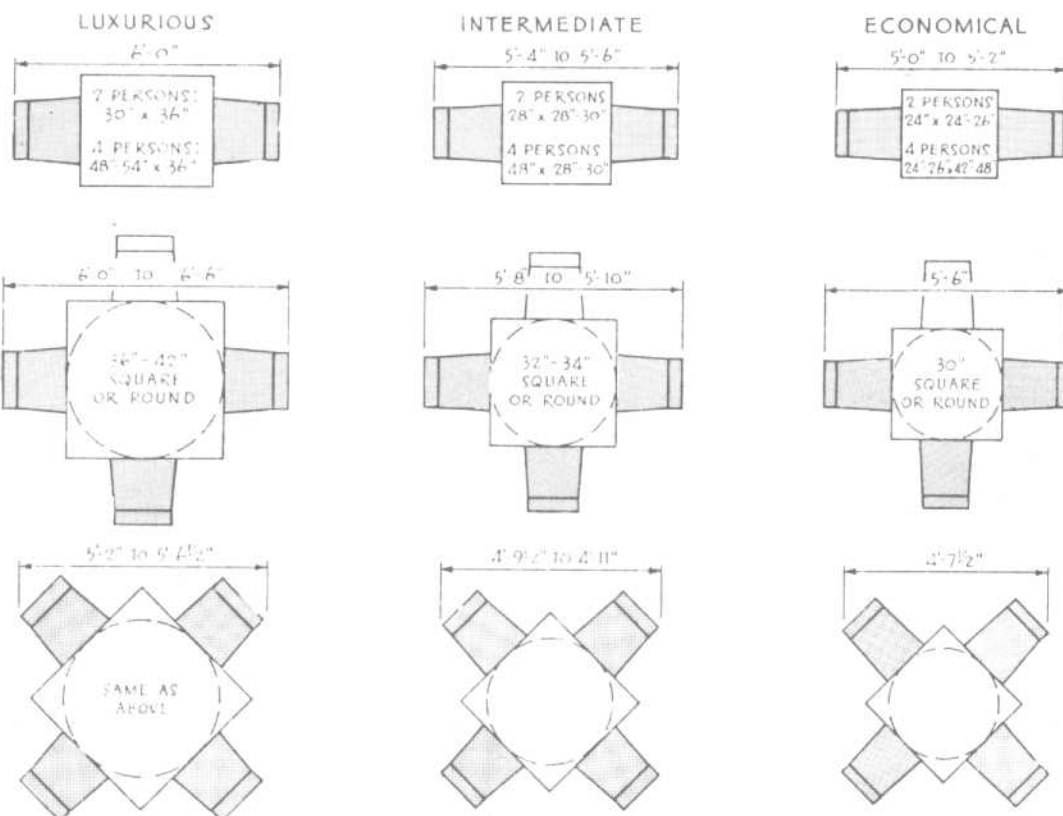
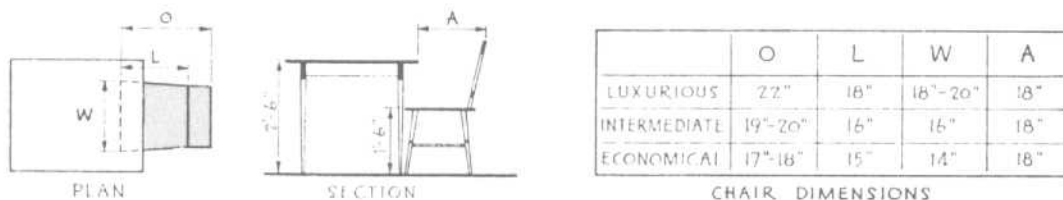


The basic components of any restaurant interior are the chair and the table. Depending upon restaurant type, menu, service, table setting, furniture selection, and degree of intimacy required, table size and overall chair space requirements can, and should, vary greatly. A restaurant that encourages rapid turnover of customers will normally provide smaller table top and chair sizes. On the other hand, those restaurants that encourage limited turnover and emphasize the dining and dining experience will typically

provide larger table top sizes and larger, more comfortable chairs, with greater distance between table groupings.

There is no agreement among even the most experienced restaurateurs and restaurant designers as to what the optimal table and chair dimensions should be. In addition, many other design factors will influence the final decision, including circulation and egress, accessibility standards, methods of service, and the overall dimensions of any given space.

Figures 1 to 19 provide the designer with restaurant planning standards that have been developed by many experienced architects and interior designers. These drawings not only show the various individual table and chair arrangements, but provide the designer with groupings of these arrangements, as well as an indication of overall size, floor area, and number of persons accommodated. These arrangements, however, should only be utilized for preliminary planning information.



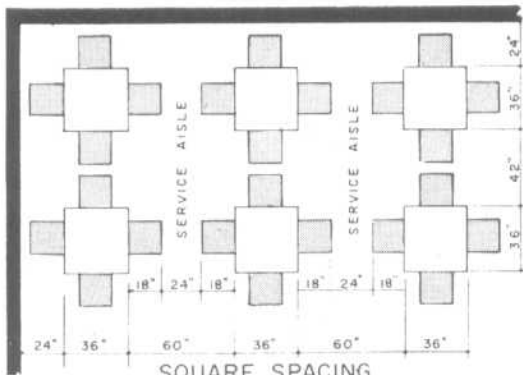
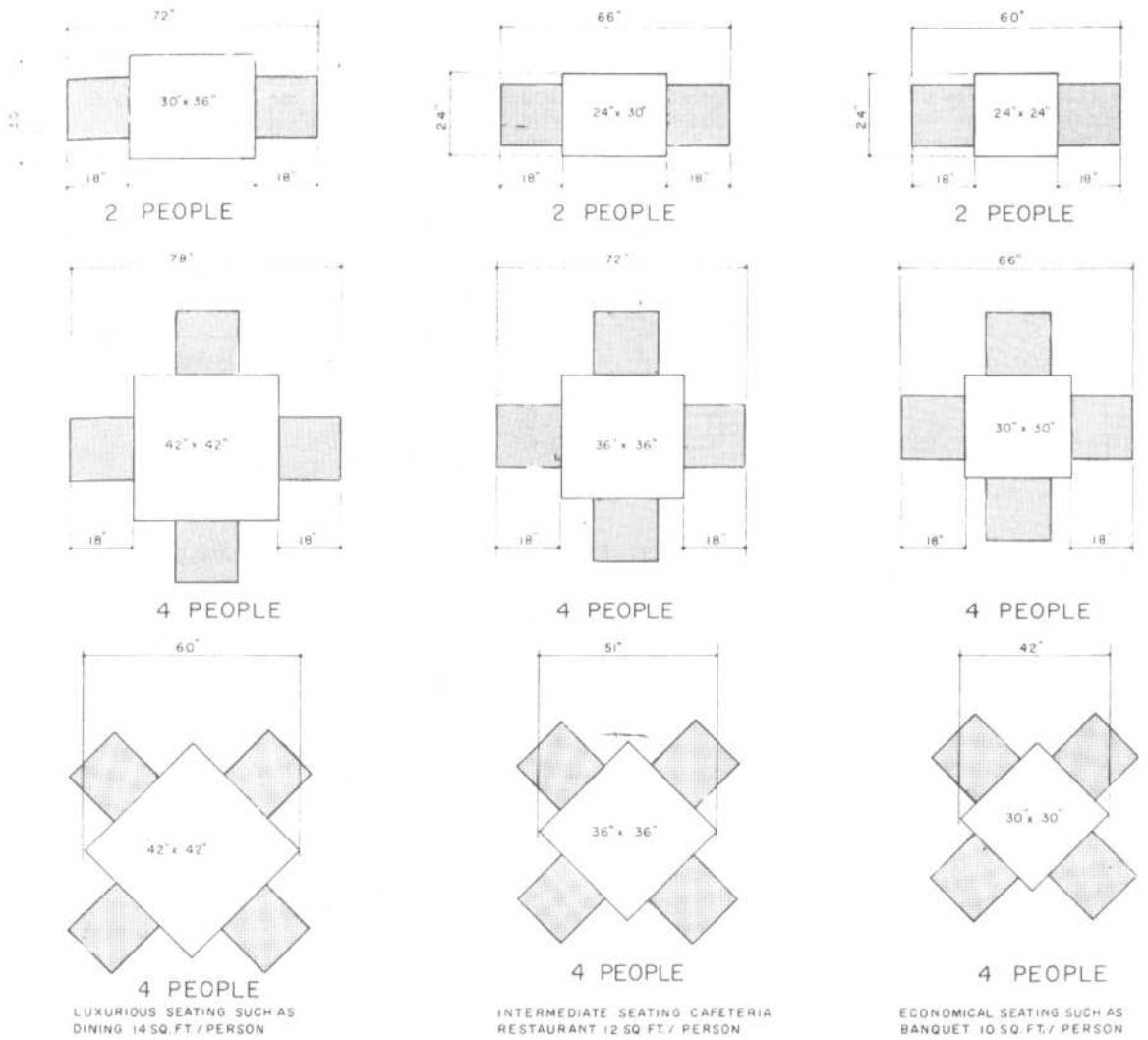
CHAIR-AND-TABLE UNITS (OCCUPIED)

AISLE WIDTHS:	FOR PUBLIC CIRCULATION:	FOR SERVICE ONLY:	FOR MAIN ENTRANCE:
	54" MINIMUM CLEAR WIDTH	24" MIN. BETWEEN CHAIR BACKS	LARGE AS POSSIBLE

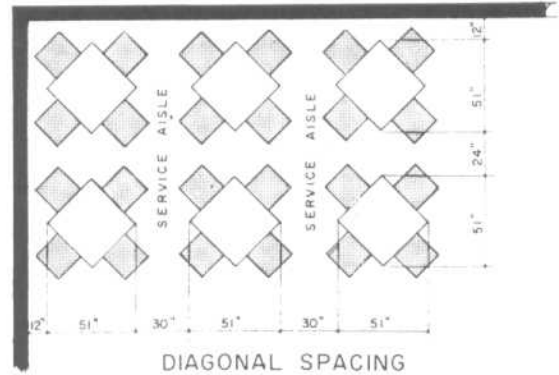
Fig. 1

RESTAURANTS

Types and Sizes of Table Arrangements



SERVICE AISLES: SQUARE SEATING 60" MIN BETW TABLE TOPS, 24" AISLE PLUS TWO CHAIRS BACK TO BACK 36" CHAIRS: 17" TO 18" FROM FLOOR TO SEAT, 17" PREFERRED FOR WOMEN TABLES: 29" TO 30" HIGH



SERVICE AISLES: DIAGONAL SEATING 30" MIN BETW CORNERS OF TABLE TOPS

Fig. 2



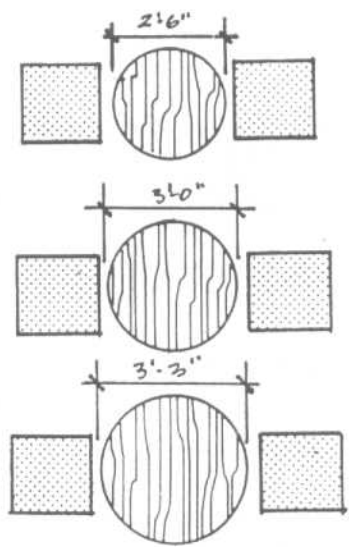
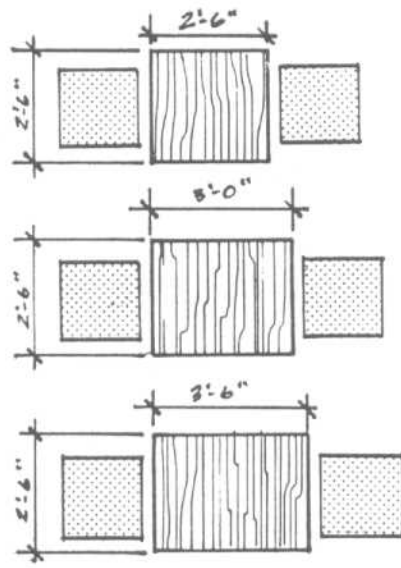
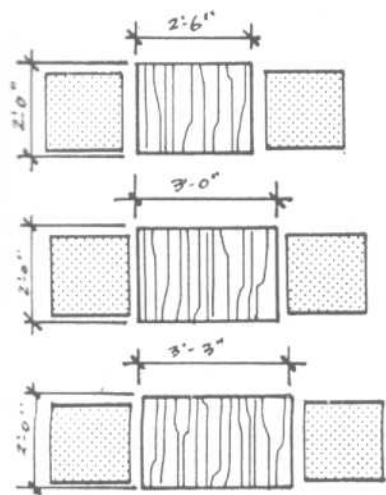


Fig. 3 Seating for 2.

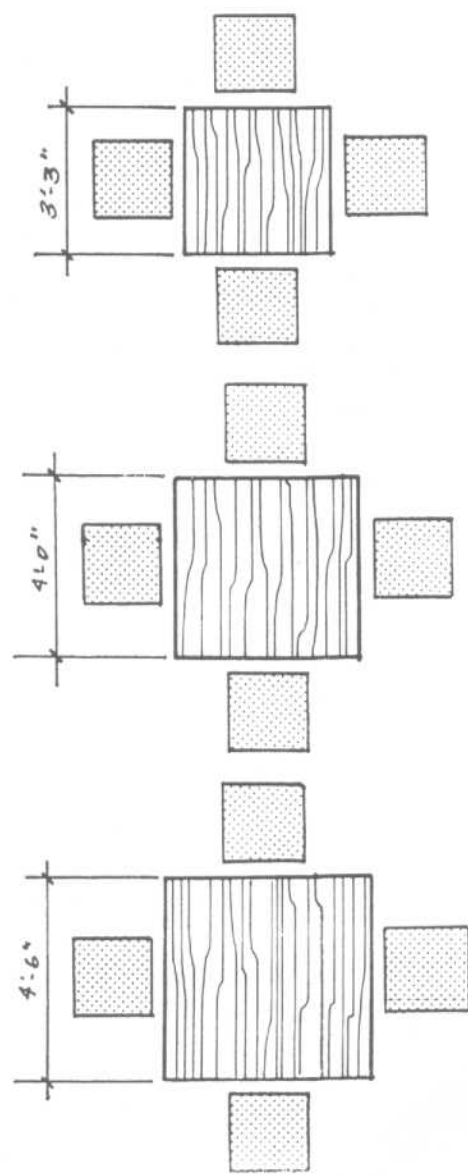
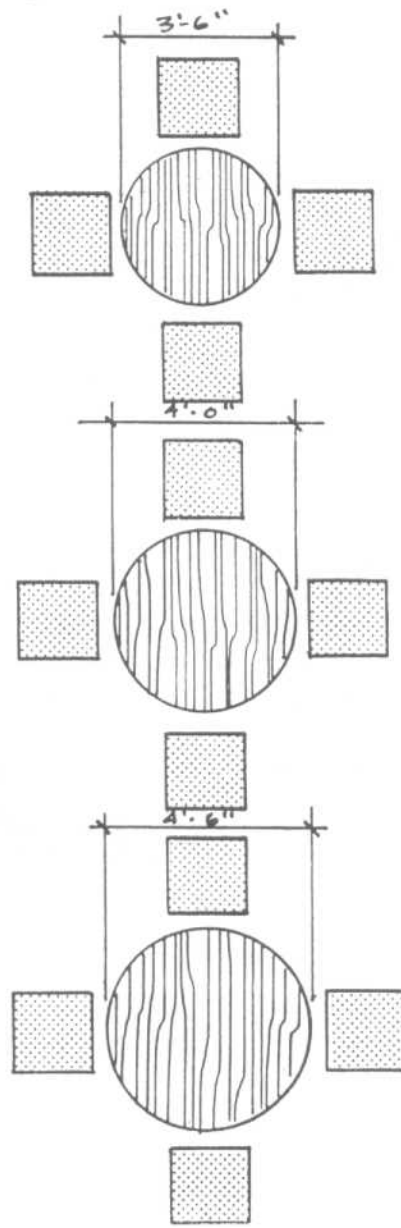
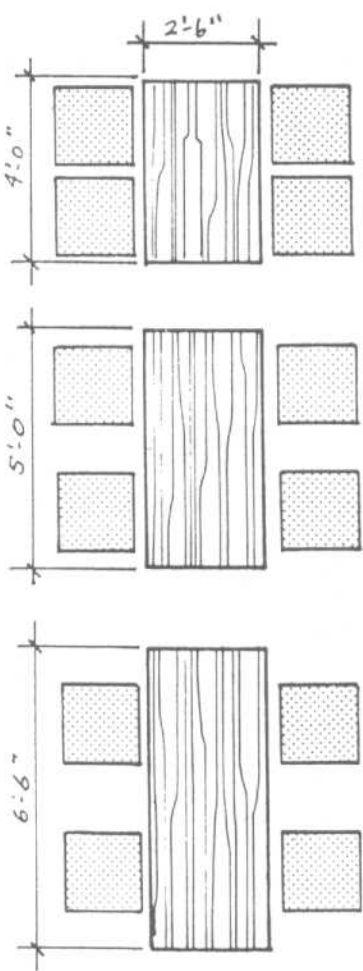


Fig. 4 Seating for 4.

RESTAURANTS

Types and Sizes of Table Arrangements

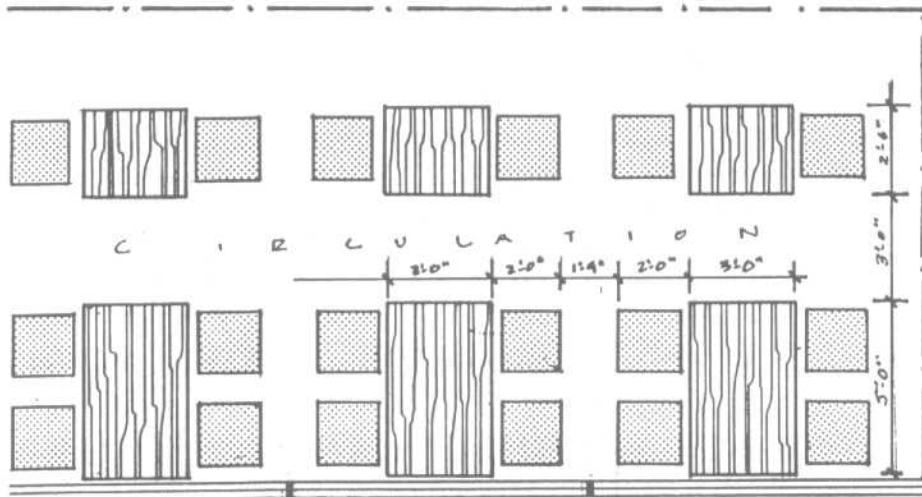


Fig. 5 13 ft x 27 ft, 351 ft<sup>2</sup>, seats 18.

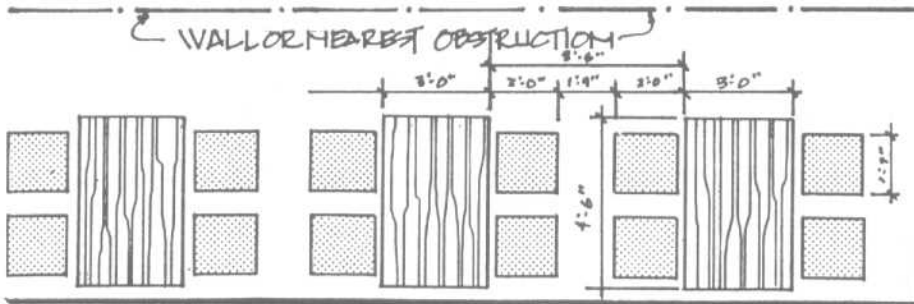


Fig. 6 8 ft x 27 ft, 216 ft<sup>2</sup>, seats 12.

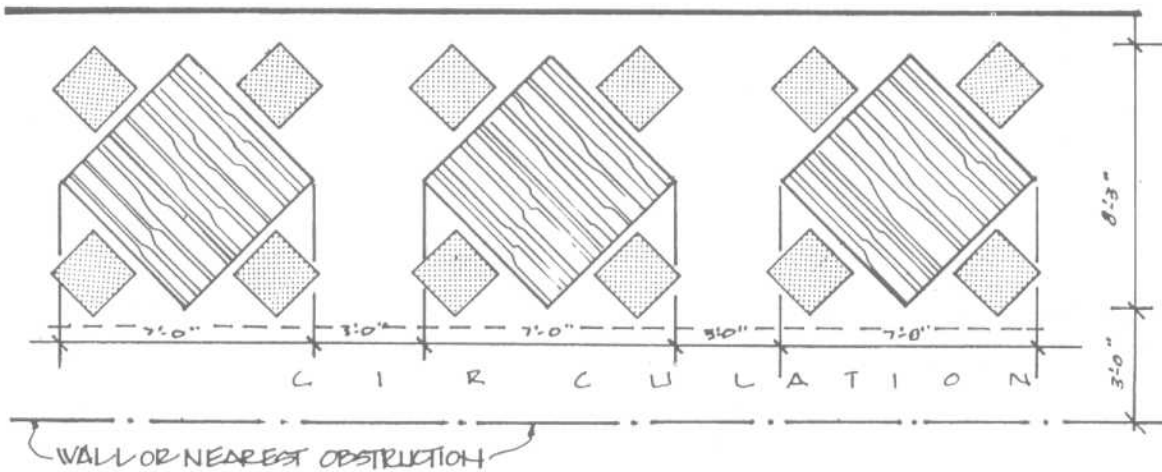


Fig. 7 33 ft x 11 ft, 363 ft<sup>2</sup>, seats 12.

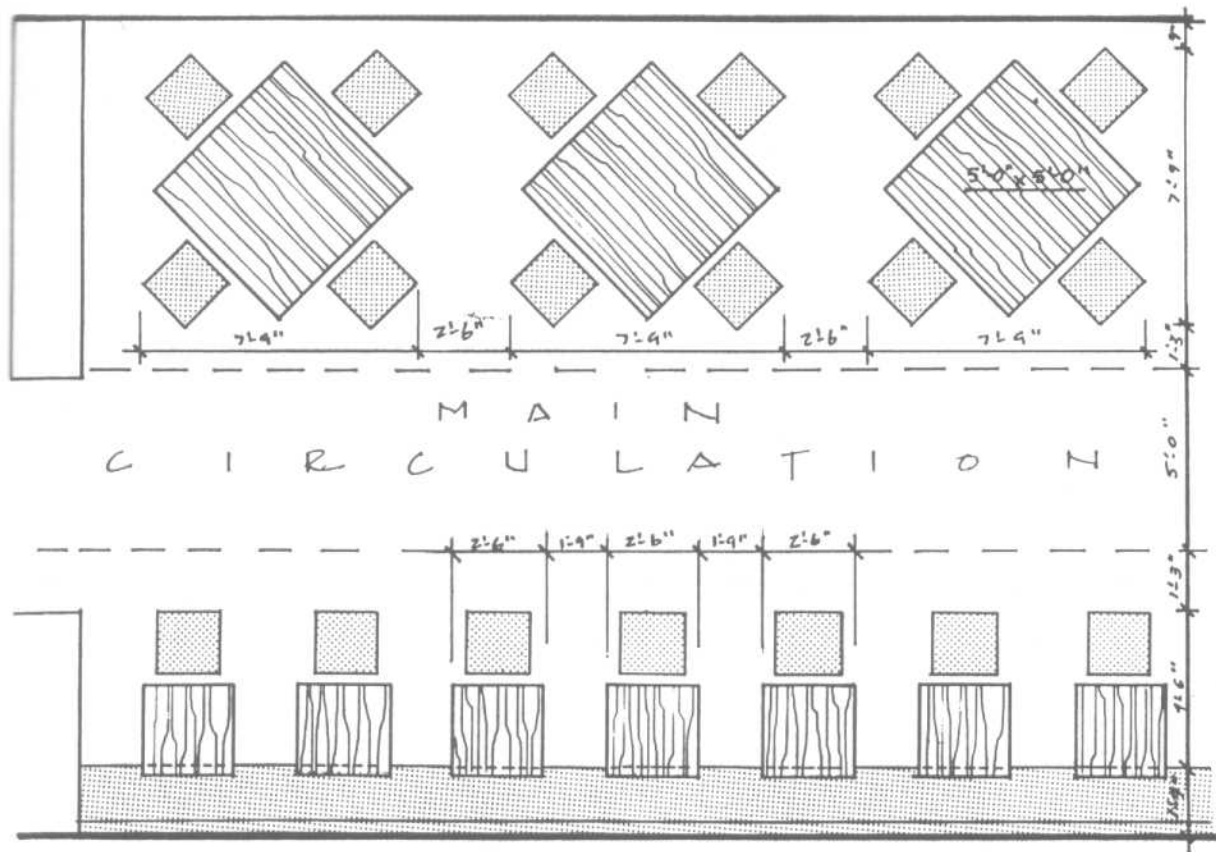


Fig. 8 33 ft x 22 ft, 726 ft², seats 26.

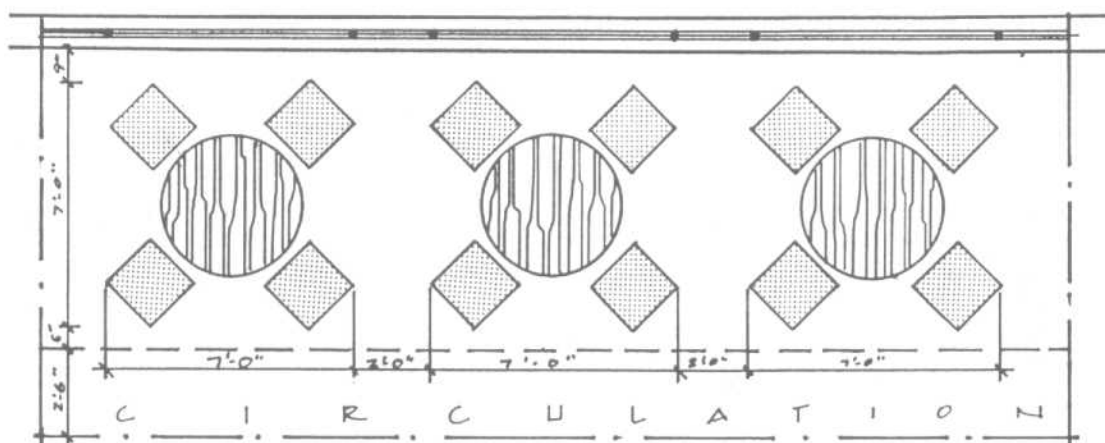


Fig. 9 11 ft x 28 ft, 308 ft², seats 12.

RESTAURANTS

Tables: Design Criteria

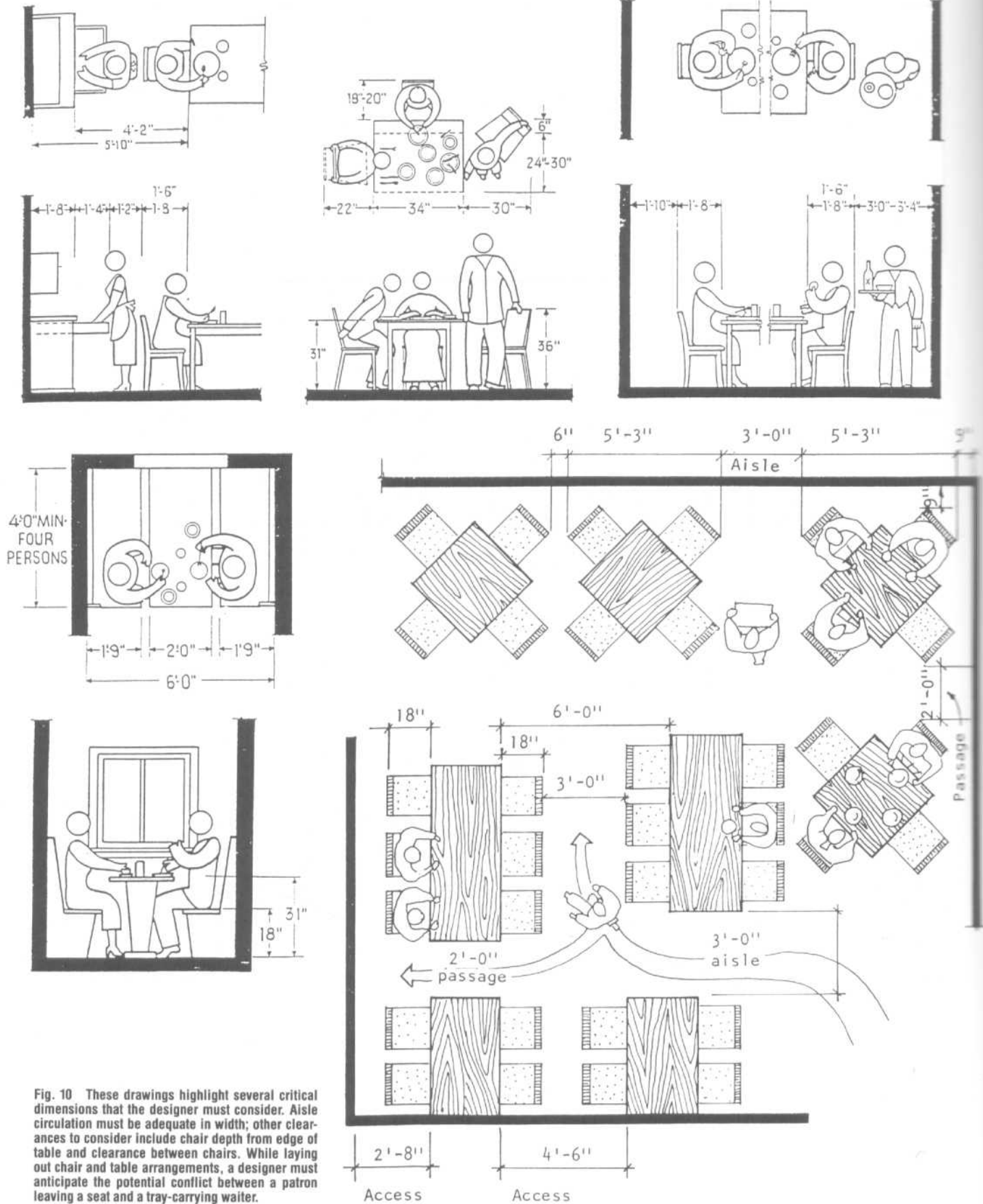


Fig. 10 These drawings highlight several critical dimensions that the designer must consider. Aisle circulation must be adequate in width; other clearances to consider include chair depth from edge of table and clearance between chairs. While laying out chair and table arrangements, a designer must anticipate the potential conflict between a patron leaving a seat and a tray-carrying waiter.

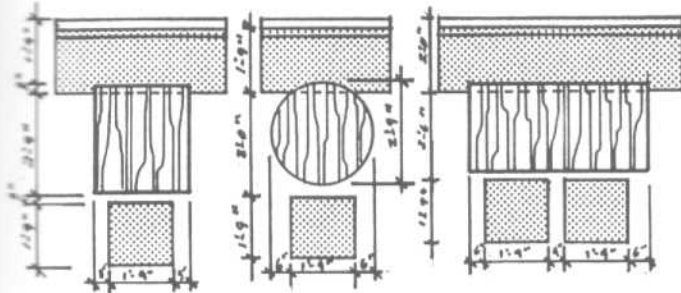


Fig. 11 Mixed banquette seating.

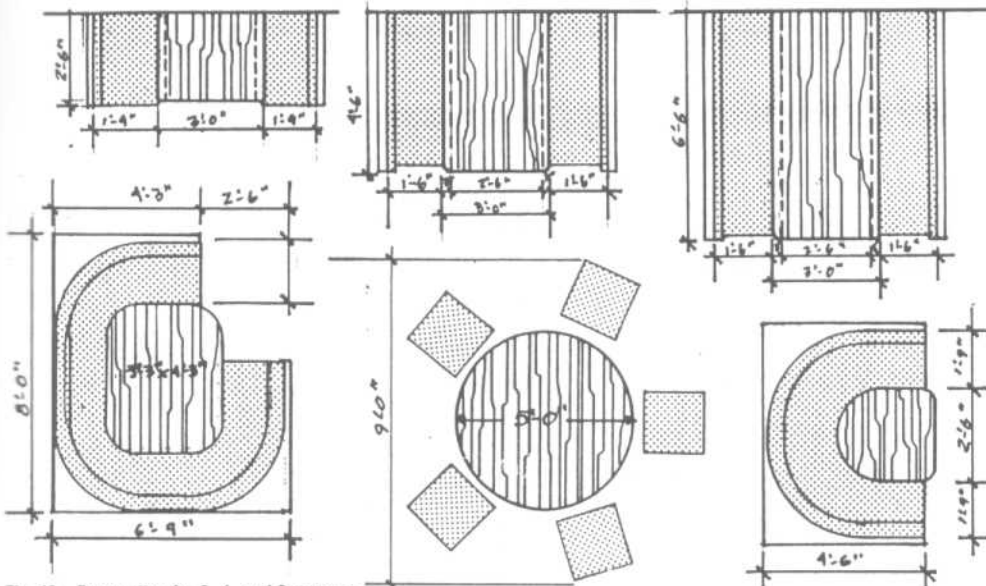


Fig. 12 Banquettes for 2, 4, and 6 persons.

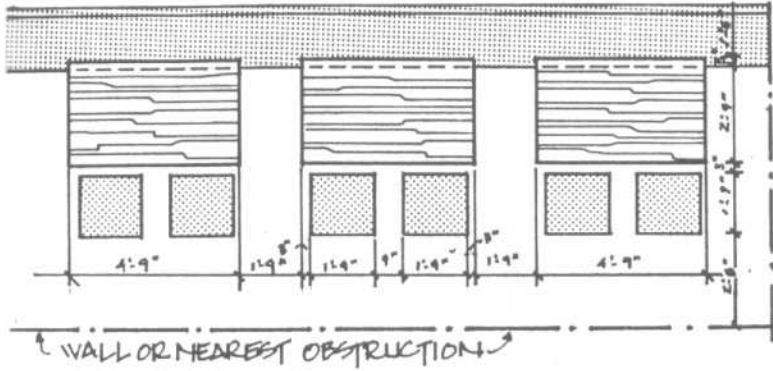


Fig. 13 21 ft x 9 ft, 189 ft<sup>2</sup>, seats 12.

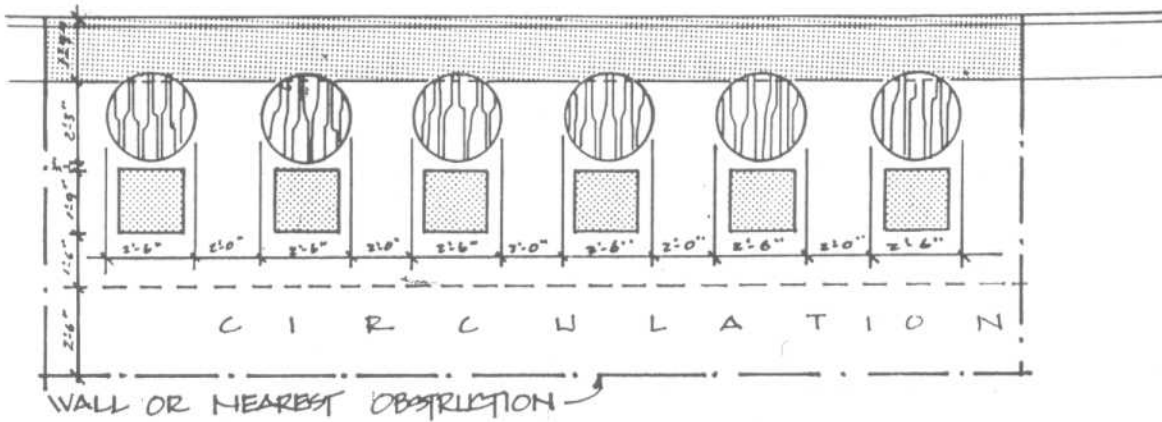


Fig. 14 27 ft x 10 ft, 270 ft<sup>2</sup>, seats 12.

RESTAURANTS

Types and Sizes of Banquette Arrangements

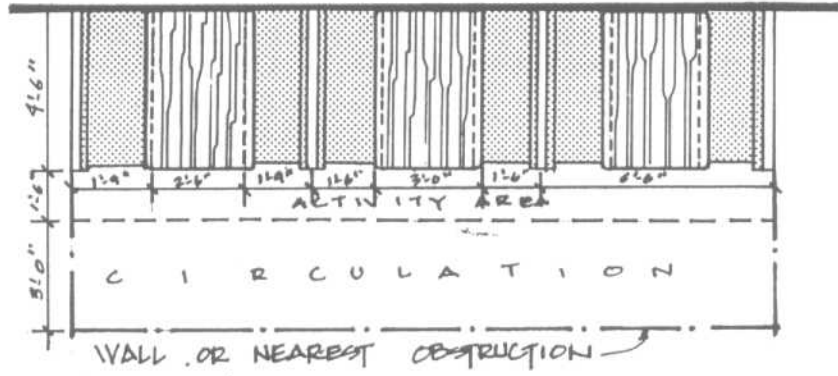


Fig. 15 19 ft x 9 ft, 171 ft<sup>2</sup>, seats 12.

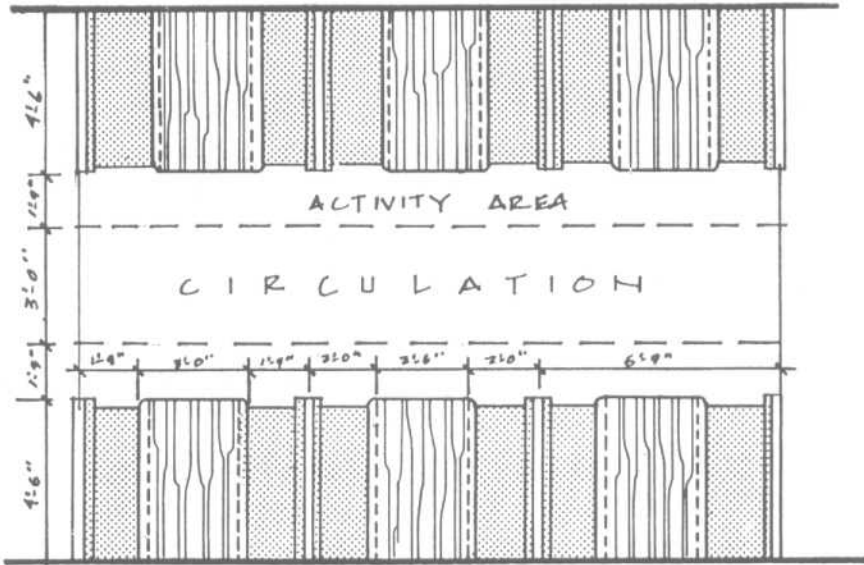


Fig. 16 19 ft x 15 ft, 285 ft<sup>2</sup>, seats 24.

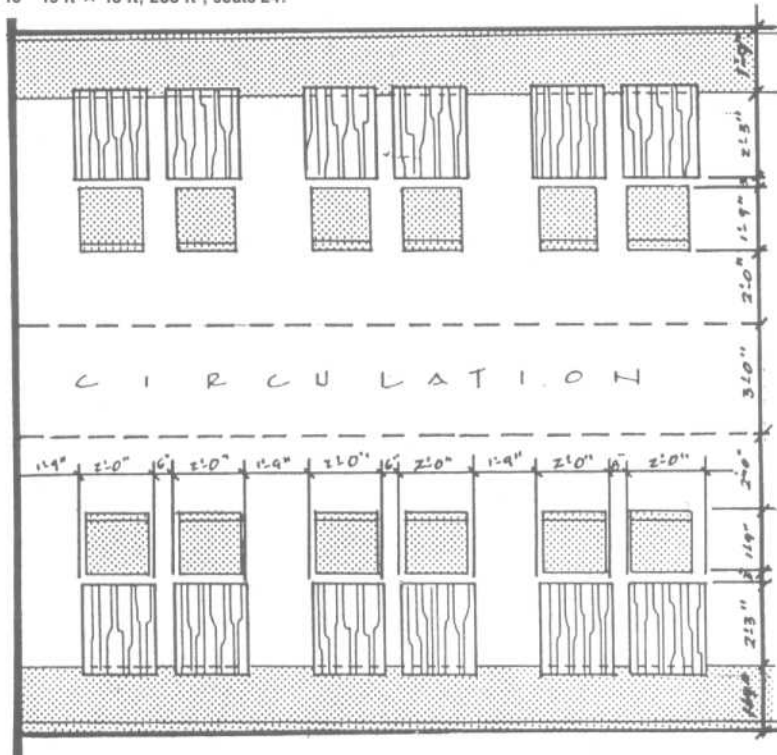


Fig. 17 21 ft x 19 ft, 400 ft<sup>2</sup>, seats 24.

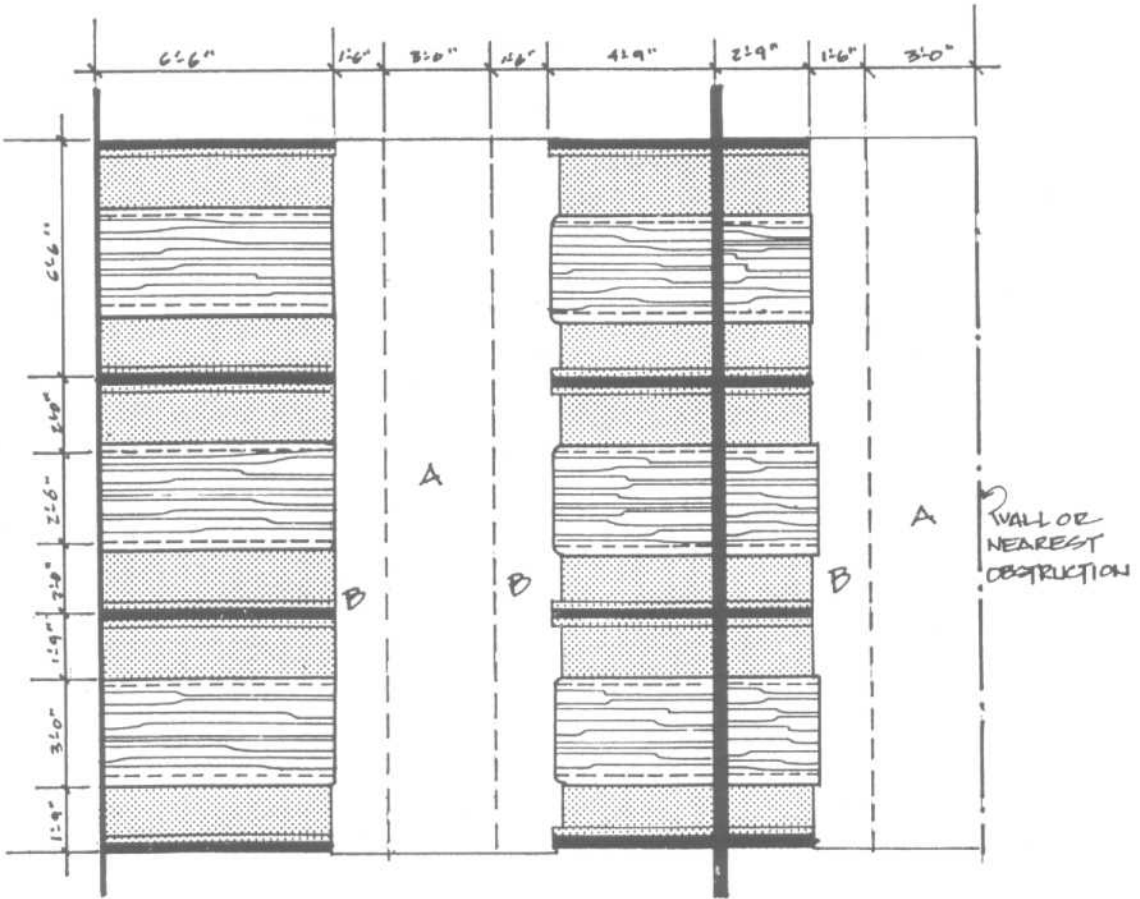


Fig. 18 24 ft x 20 ft, 480 ft<sup>2</sup>, seats 36. A = main circulation, B = activity zone.

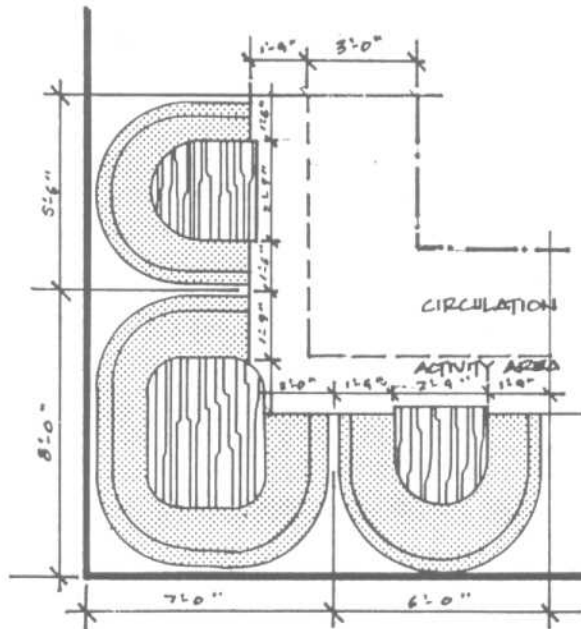


Fig. 19 13 ft x 13 ft, 169 ft<sup>2</sup>, seats 16.



RESTAURANTS

Dining Room Seating

Restaurant and Dining Room Seating

Dispersed seating suitable for guests with restricted mobility should be available in restaurants, coffee shops, and dining facilities. As a guide, the Uniform Federal Accessibility Standards (UFAS) require a minimum of 5 percent of restaurant seating to be accessible. Accessible aisles should connect the entrance to these seating locations, public restrooms, and self-service areas such as salad bars, condiment stands, or buffet tables. Comfortable seating for waiting should be available to customers near the entrance.

A variety of accessible seating should be available, suitable for large and small dining groups. Small tables may not be accessible to guests in wheelchairs because of the restricted kneespace. Therefore, a party of one or two may require a table usually set up for four. Restaurants or coffee shops with built-in seating, such as booths or banquettes, should also provide some chairs for guests who have difficulty getting into and out of bench seating. These chairs can be removed to seat guests in wheelchairs. Where seating areas are raised on platforms, accessible seating and similar services should be available on the main-floor level or a ramp to the upper level should be provided.

Aisles serving accessible seating should be at least 3'0" wide, which typically requires a 6'0" clearance between parallel tables, or 4'6" between rotated tables. (See Fig. 21.) Aisle widths should also provide room for customers to be seated at tables. At least a 2'6" clear space should be available behind each seating location. This space allows chairs to be withdrawn from the table and staff to assist guests reposition chairs close to the table.

For wheelchair seating, a 3'0" to 3'6" aisle is necessary, depending on the width of the kneespace. (See Fig. 25.) Wheelchairs positioned at tables project approximately 5" further into aisles than most chairs. To allow guests with restricted mobility to turn around, seating arrangements should also include a 5'0" diameter circle or T-shaped clear area at dead-end aisles.

Dining Tables and Chairs

Accessible seating locations should allow guests with restricted mobility to dine with ambulatory customers. Tables should provide kneespace for customers in wheelchairs, and dining chairs should be coordinated to provide comfortable seating at the same table height.

Dining room chairs should be stable to maintain balance as guests seat themselves, and comfortable to sit in during dinner. Chairs should be light and easy to reposition. The seat should have a slight slant to the rear to transfer body weight to the back of the chair. However, an exaggerated incline makes it difficult to rise. The seat should be approximately 16" deep and at least 16" wide to allow space for customers to reposition themselves during the meal. Padding or cushions on the chair seat should be firm, and the chair back should also be slightly inclined to the rear. To help guests sit and rise, dining chairs should have armrests 7" to 8" above the front edge of the seat. (See Fig. 22.) Supports or cross-bracing should not

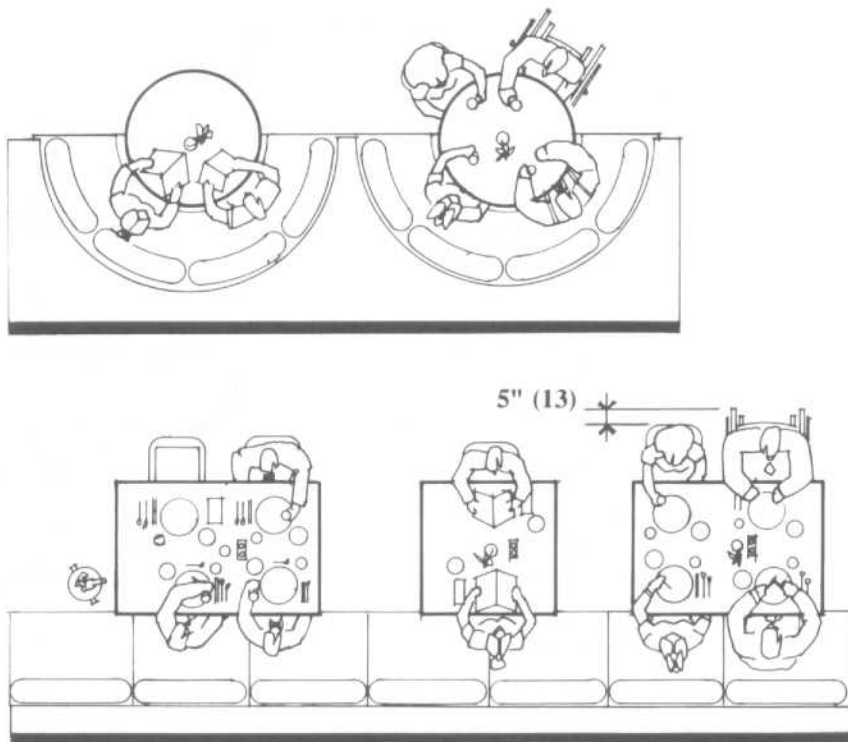


Fig. 20 Restaurants or coffee shops with fixed seating should include some movable seating for guests in wheelchairs and guests who have difficulty getting into and out of the bench seating. Number in parentheses is dimension in centimeters.

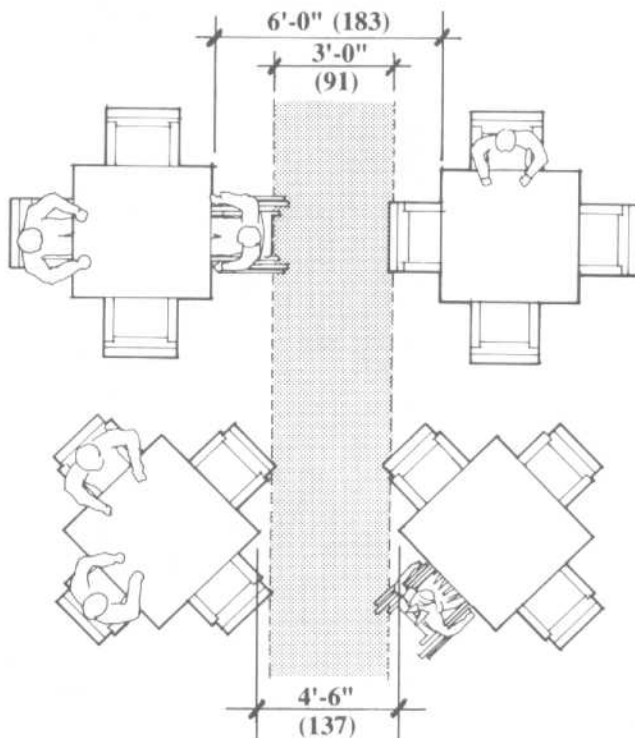


Fig. 21 Aisles serving accessible seating should provide a path at least 3'0" wide for passage and clear space for guests to seat themselves at tables. Numbers in parentheses are dimensions in centimeters.



interfere with kickspace below the seat, so the feet can be positioned to rise. The front edge of the chair seat should be low enough to allow the feet to rest on the floor, but not so low that it is difficult to rise. This is determined by the lower leg length (popliteal height) which varies between 15" and 20" for most adults.

The height of the chair seat should be 10½" to 11½" below the top of the table. Common seat heights vary between 14" and 18". Because the height of wheelchair seats is typically 19", a relatively high chair seat is necessary to coordinate with the table height. A chair with an 18" high seat is comfortable for most ambulatory guests and closely approximates the height of a wheelchair seat.

Dining room tables should have a stable surface at a convenient height and knee-space and legroom below the tabletop for customers in wheelchairs. Narrow table configurations allow face-to-face seating, which

reduces the distance between diners, making conversation easier and table lighting more effective. For safety, the corners and edges of the top should be rounded.

Full-height wheelchair kneespace is 2'6", which requires tabletops to be at least 2'7" above the floor, too high for most seating. Many wheelchairs now provide adjustable or two-tier armrests, which allow customers to sit close to tables in a kneespace only 2'3" high. To provide this kneespace, the tabletop (without an apron) should be 2'4½" to 2'5" above the floor. This is 11" to 11½" above the chair seat, 10½" to 11" above the seat of wheelchairs, and convenient for both. This kneespace also permits the armrests of chairs to pass below the tabletop so seated customers can draw close. This combination of tables and chairs is suitable for the majority of wheelchair users and most ambulatory guests.

Footroom is important for customers with wheelchairs or leg braces. The footrests of

wheelchairs are 2½" to 3" above the ground and angled slightly forward, which requires 1'7" of footroom, measured from the edge of the tabletop. The outside width of footrests is only 1'6", but 2'6" of side-to-side clearance is necessary to maneuver into position beneath the table. To provide kneespace, table legs should be at least 2'6" apart, and the tabletop, for face-to-face seating, should be 3'6" wide. Pedestalbase tables should have low, tapered bases and a minimum diameter of 3'6", although 4'0" is preferred.

A portable raised leaf should be available to modify tables for customers in wheelchairs with high armrests. The leaf should be approximately the size of a place setting, 1'4" by 2'0", and secured to the underside of an accessible table with clamps. The raised leaf should project 6" beyond the edge of the table and provide 2'6" clearance above the floor. (See Fig. 24.)

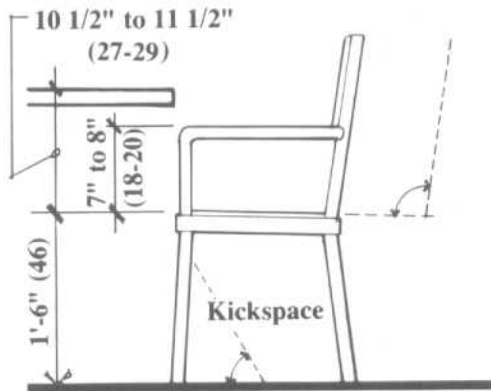


Fig. 22 Dining room chairs should have a seat 10½" to 11½" below the top of the table and armrests 7" to 8" above the seat. To coordinate with an accessible table, the seat height should be 18". Numbers in parentheses are dimensions in centimeters.

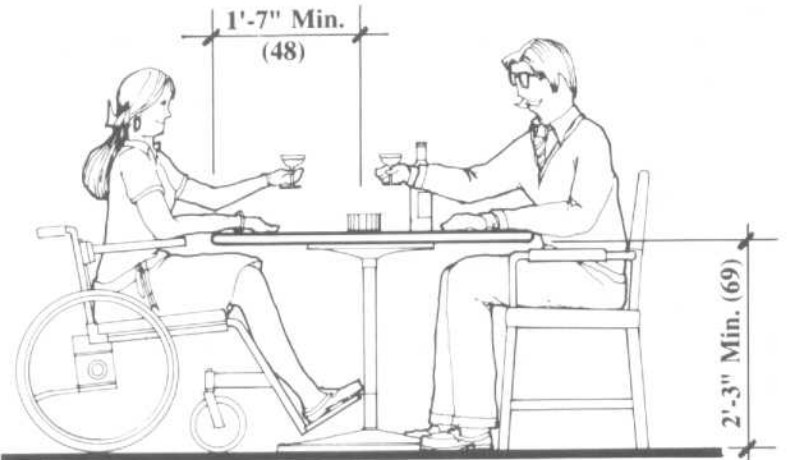
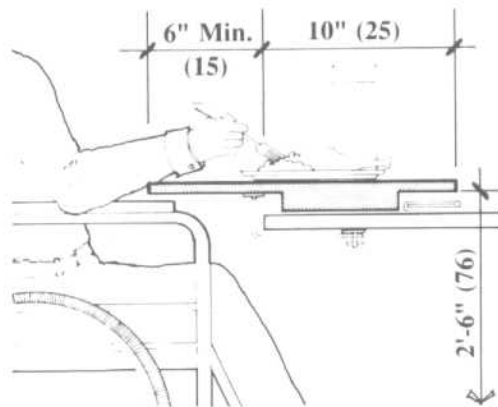


Fig. 23 Accessible tables should provide kneespace at least a 2'3" high by 2'6" wide with 1'7" of footroom. To increase the kneespace height, a raised portable leaf can be provided. (See Fig. 24.) Numbers in parentheses are dimensions in centimeters.



Kneespace Width	Clearance
2'-6" (minimum)	3'-6"
3'-0" or greater	3'-0"

Fig. 24 A portable raised leaf can be provided for accessible tables to accommodate customers in wheelchairs with high armrests. Numbers in parentheses are dimensions in centimeters.

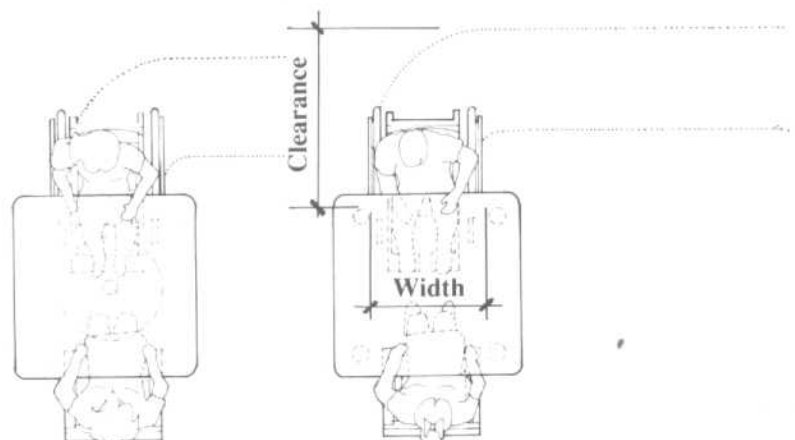


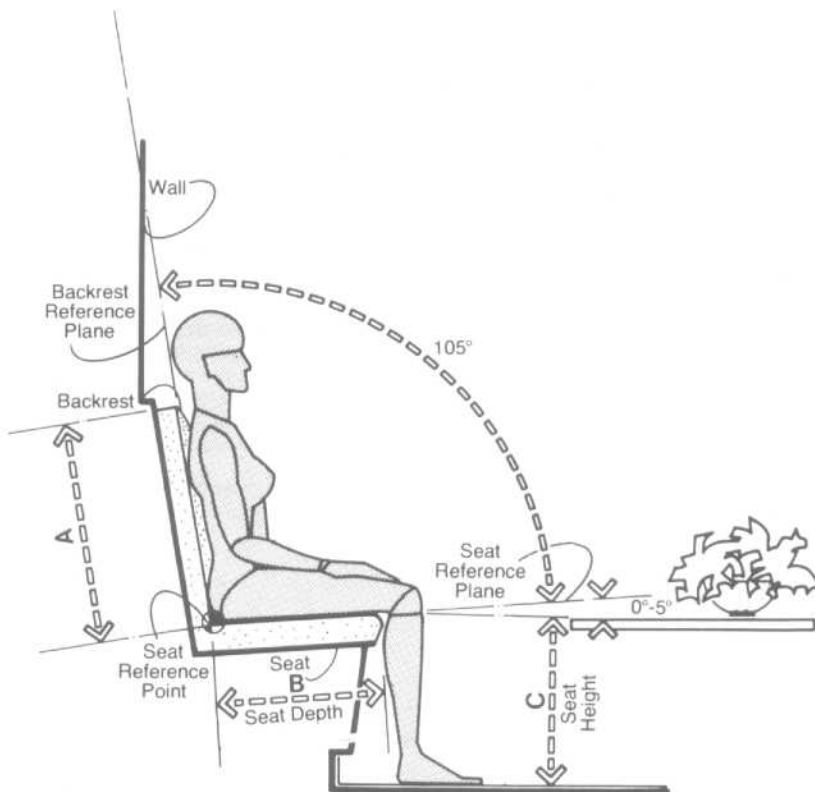
Fig. 25 The necessary maneuvering room required to access a kneespace depends on its width.

RESTAURANTS

Banquettes: Design Criteria

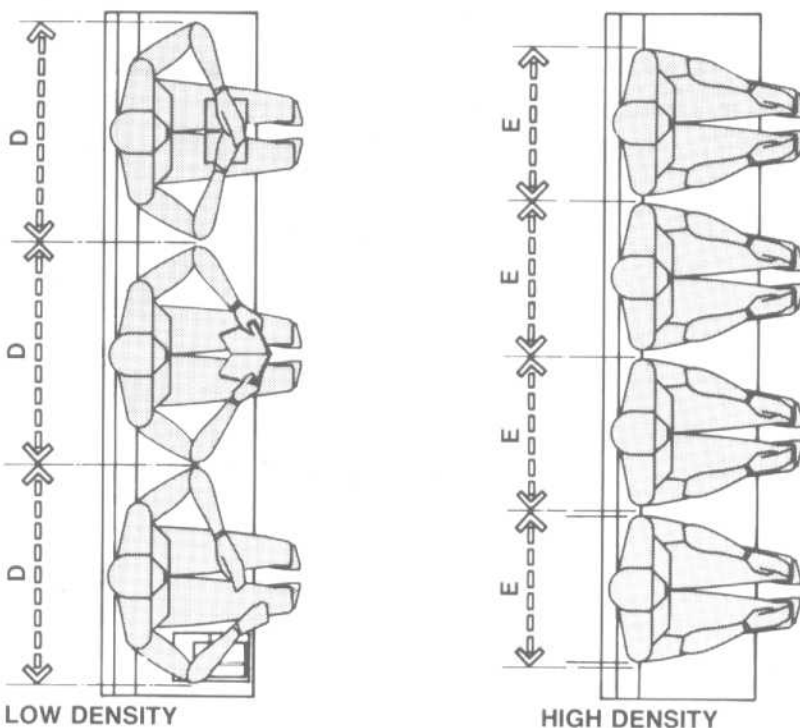
Figure 27 shows the basic dimensions for the design of banquette seating. The lack of armrests makes it difficult to define seat boundaries. The user, therefore, tends to establish a territory by assuming a desired sitting posture and placing personal articles next to him or her, such as a briefcase, purse, or package. Since the nature of this type of seating can permit some form of body contact, hidden dimensions and personal space also play an important part in how close the users sharing the banquette will sit.

Because of the many hidden psychological factors involved, the actual efficiency of this seating type in terms of capacity is questionable. Figure 27 indicates two possible seating situations, each dictated by the anthropometrics involved. One arrangement is based on the premise that the user's elbows will be extended, possibly in conjunction with some activity, such as reading, or simply as an attempt to stake out additional territory, as would be the case in the strategic positioning of some personal article on the seat. In this situation it would be reasonable to assume that each user would take up about 30 in, or 76.2 cm, of space. The other diagram shows a more compact seating arrangement. Figure 26 shows a section through a typical banquette.



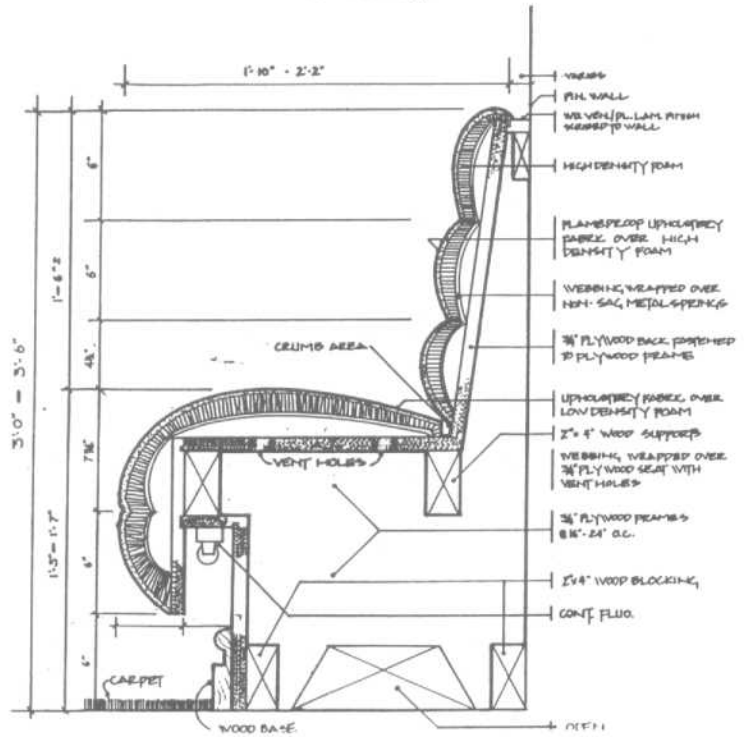
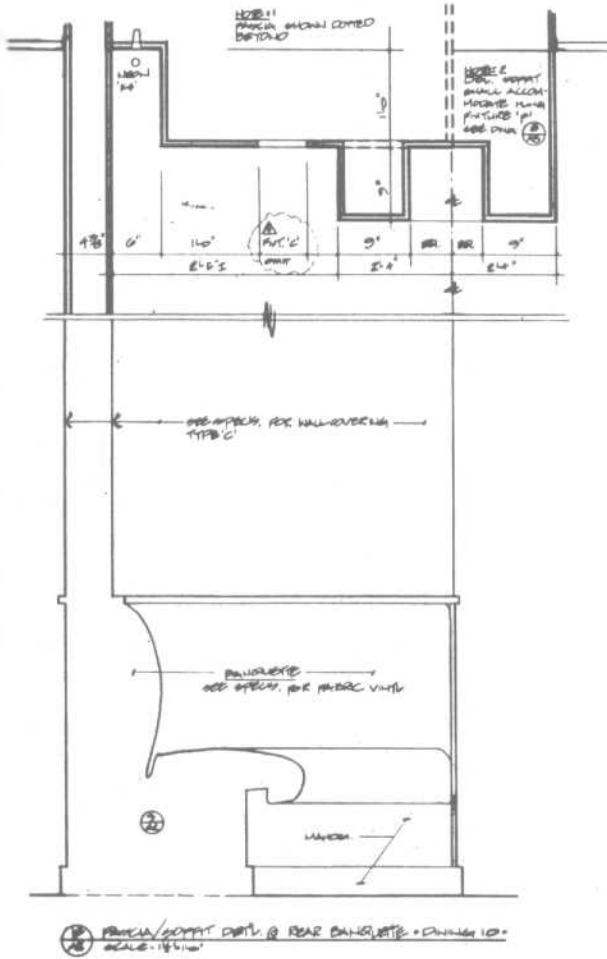
SECTION  
Fig. 26 Banquette seating.

	in	cm
A	18-24	45.7-61.0
B	15.5-16	39.4-40.6
C	16-17	40.6-43.2
D	30	76.2
E	24	61.0

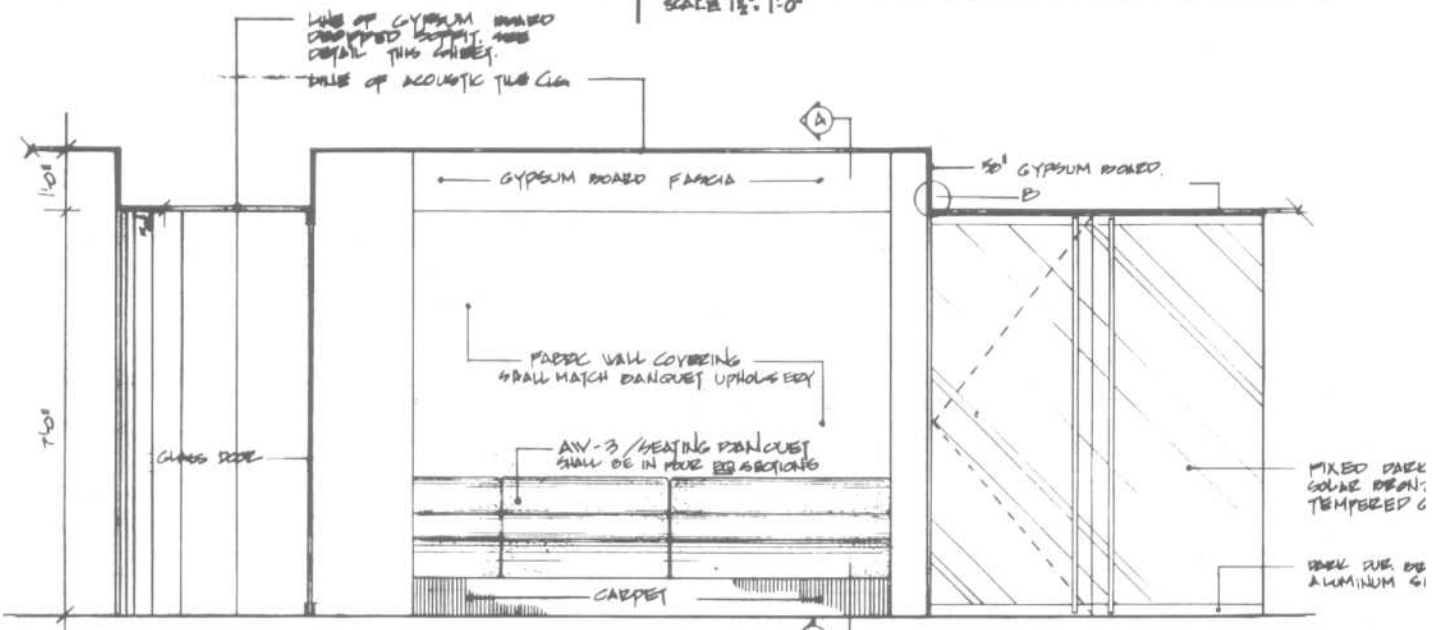


LOW DENSITY  
HIGH DENSITY  
Fig. 27 Banquette seating.

Banquette seating provides the designer with one of the few opportunities to custom design restaurant seating. While there can be a great variety of aesthetic solutions achieved through use of various materials, ergonomic considerations must be analyzed carefully. Specific attention should be given to depth of seat, slope of seat and back, height of back, and relationship of seat height to table height.



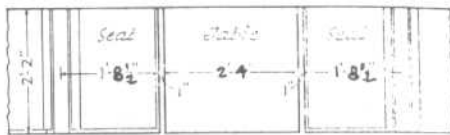
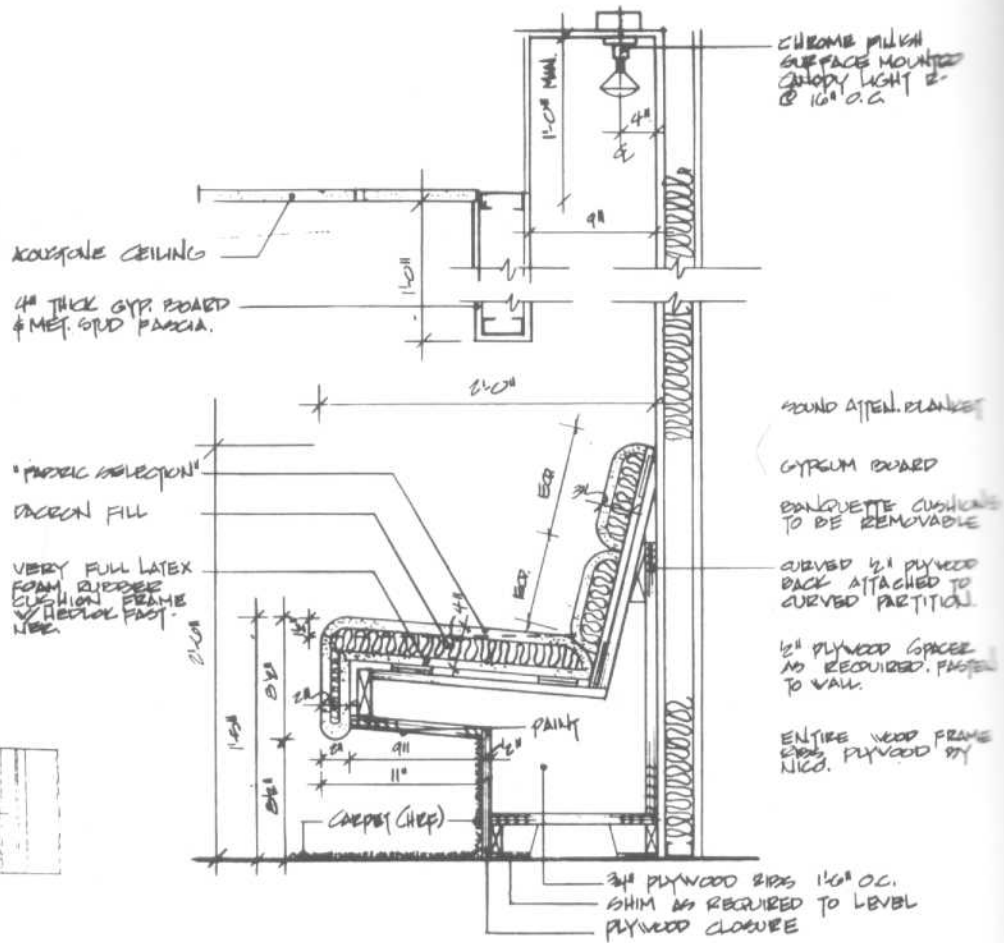
TYPICAL BANQUETTE DETAIL  
SCALE 1 1/2\"/>



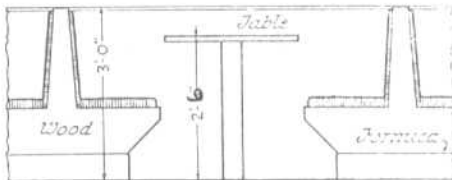
④ ELEVATION / CONFERENCE ROOM

RESTAURANTS

Banquette/Bench Seating Details

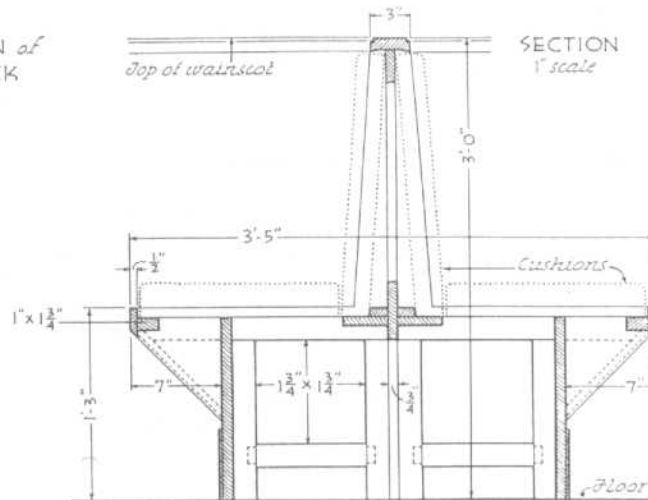
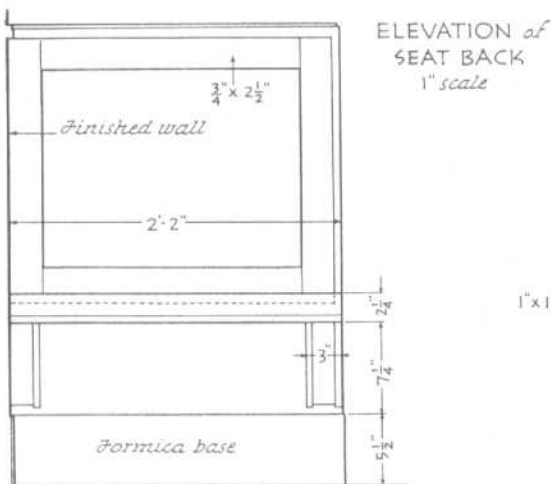


PLAN of SEATS 3/8" scale

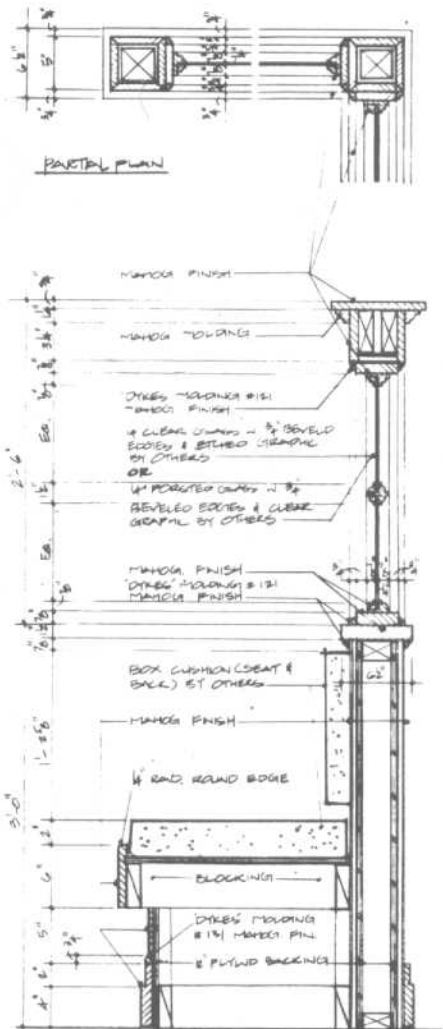


ELEVATION of SEATS

**4** AW-3 / SECTION THRU BANQUETTE  
SCALE 1/2" = 1'-0"

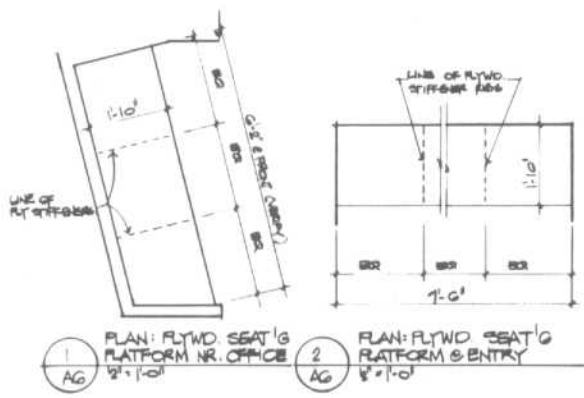


Banquette seating can be detailed relatively simply, as Figs. 28 to 30 suggest. The simplest form of banquette seating may take the form of a plywood seating platform with a removable seat cushion, or a box cushion seat and back support. Such seating is appropriate in fast food or quick turnover restaurant operations.

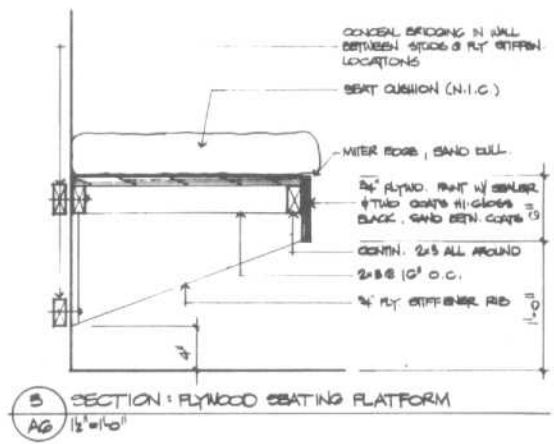


**B** DETAIL OF BANQUETTE & LOW PARTITION  
SCALE: 1/2" = 1'-0"

Fig. 28

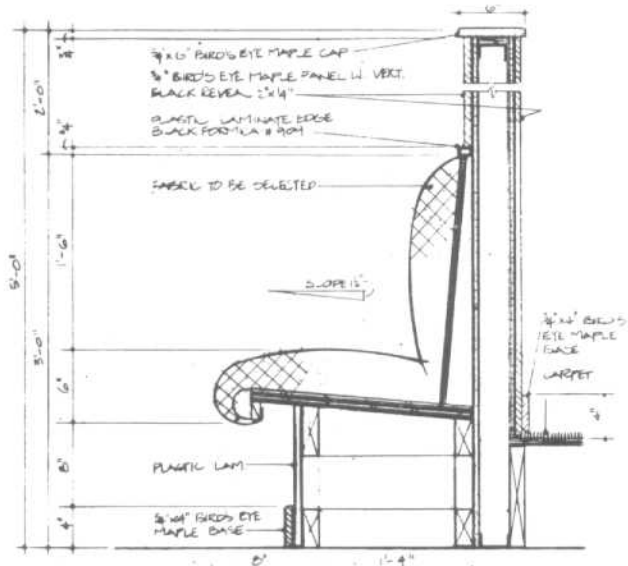


**1** AG PLAN: PLYWOOD SEATING PLATFORM NR. OFFICE 2'-10" x 1'-0"  
**2** AG PLAN: PLYWOOD SEATING PLATFORM & ENTRY 2'-10" x 1'-0"



**B** SECTION: PLYWOOD SEATING PLATFORM  
SCALE: 1/2" = 1'-0"

Fig. 29



**A** SECTION OF BANQUETTE  
SCALE: 1/2" = 1'-0"

Fig. 30

RESTAURANTS

Lunch Counters: Design Criteria

Figure 31 shows some of the basic clearances required for a typical counter: 36 in, or 91.4 cm, for workspace behind the counter; 18 to 24 in, or 45.7 to 61 cm, for the counter top; and 60 to 66 in, or 152.4 to 167.6 cm, between the front face of the counter and the nearest obstruction. Figure 32 shows a section through the counter and back counter. Most counters are about 42 in, or 106.7 cm, in height. The clearance from the top of the seat to the underside of the counter top and the depth of the counter top overhang are extremely important. Buttock-knee length and thigh clearance are the key anthropometric measurements to consider for proper body fit. Footrest heights should take into consideration popliteal height. In most cases this is ignored, and 42-in counters are provided with 7-in, or 17.8-cm, footrests that are 23 in, or 58.4 cm, below the seat surface, which cannot work. The popliteal height of the larger user, based on 99th percentile data, is only about 20 in, or 50.8 cm. Therefore, the feet dangle unsupported several inches above the footrest and the body is deprived of any stability. The footrest shown in Fig. 32, although higher, only serves a portion of the seated users and is intended primarily for standing patrons. The most logical solution is a separate footrest, integral with the stool.

	in	cm
A	60–66	152.4–167.6
B	18–24	45.7–61.0
C	36	91.4
D	24	61.0
E	12–18	30.5–45.7
F	35–36	88.9–91.4
G	42	106.7
H	30–31	76.2–78.7
I	11–12	27.9–30.5
J	10	25.4
K	12–13	30.5–33.0

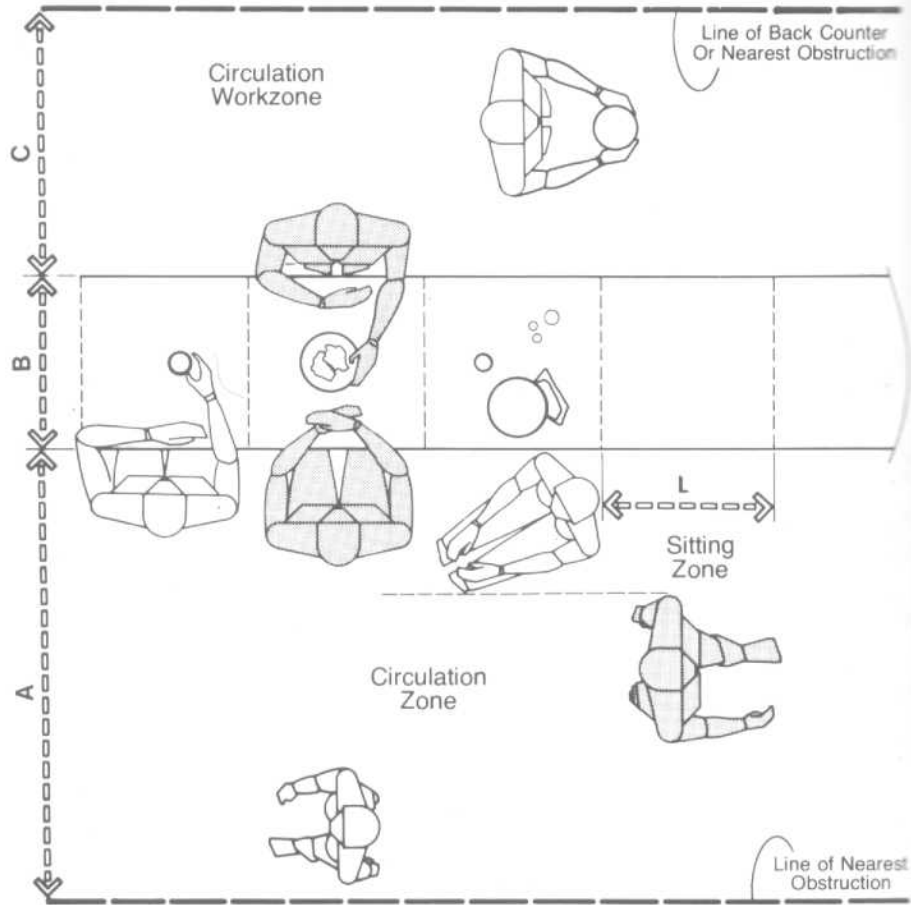


Fig. 31 Lunch counter.

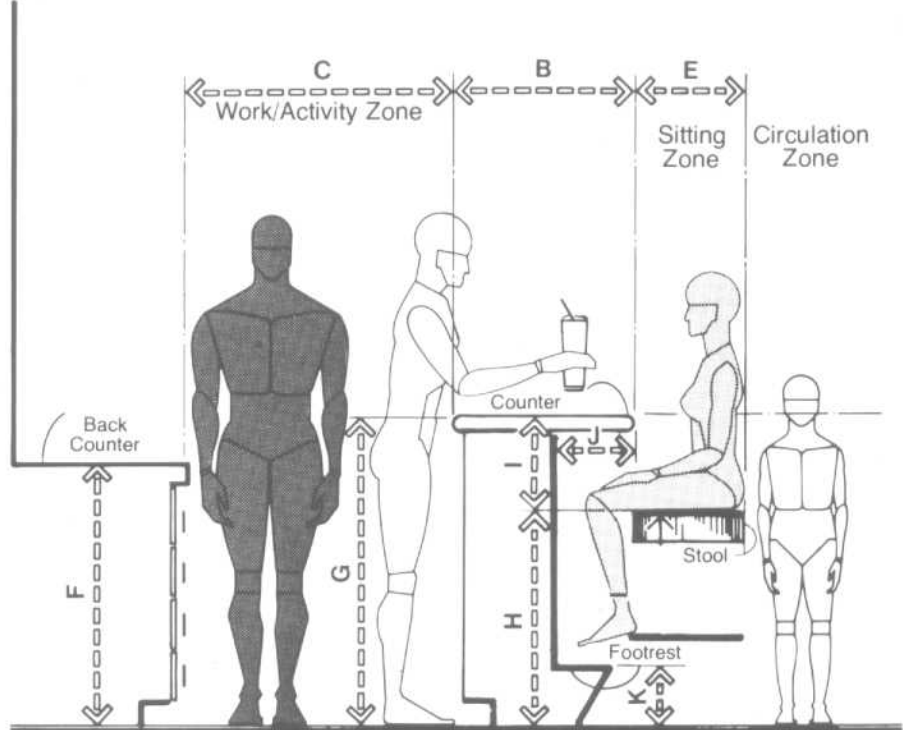
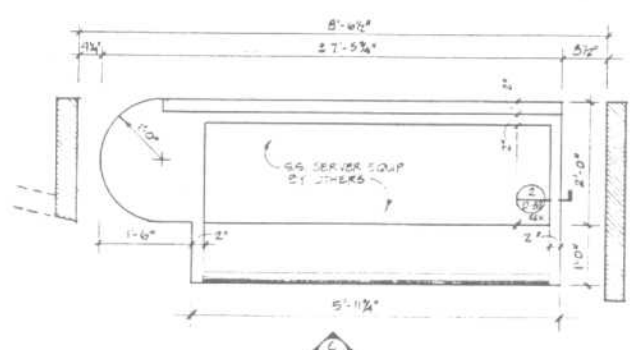


Fig. 32 Lunch counter.

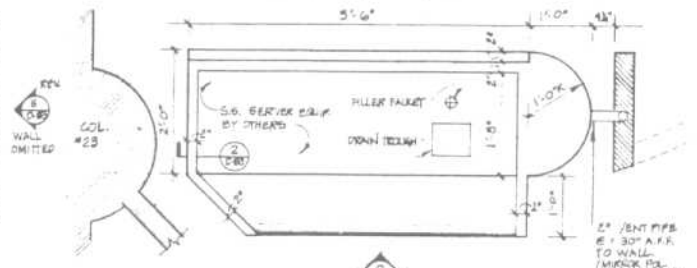


PLAN

SCALE 3/4" = 1'-0"

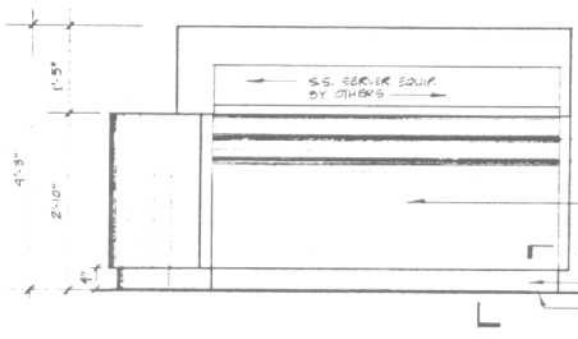
NOTE:

1. ALL WOOD VENEER SHALL BE OAK LEXEX
2. SEE K.C.M. DWG # K0-16 FOR DETAIL OF SERVERY EQUIP. COUNTER.
3. STAINLESS STEEL BASE TO MATCH FINISH OF SERVERY EQUIP. COUNTERTOP.



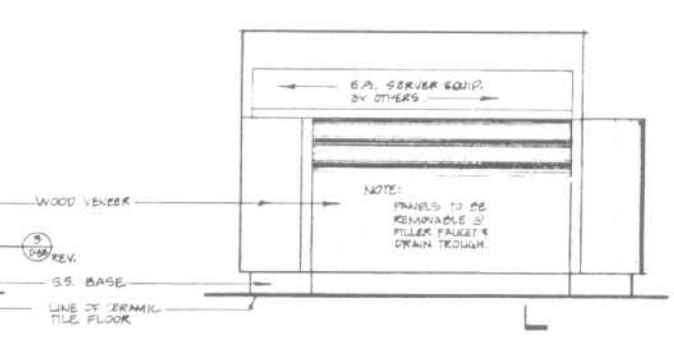
PLAN

SCALE 3/4" = 1'-0"



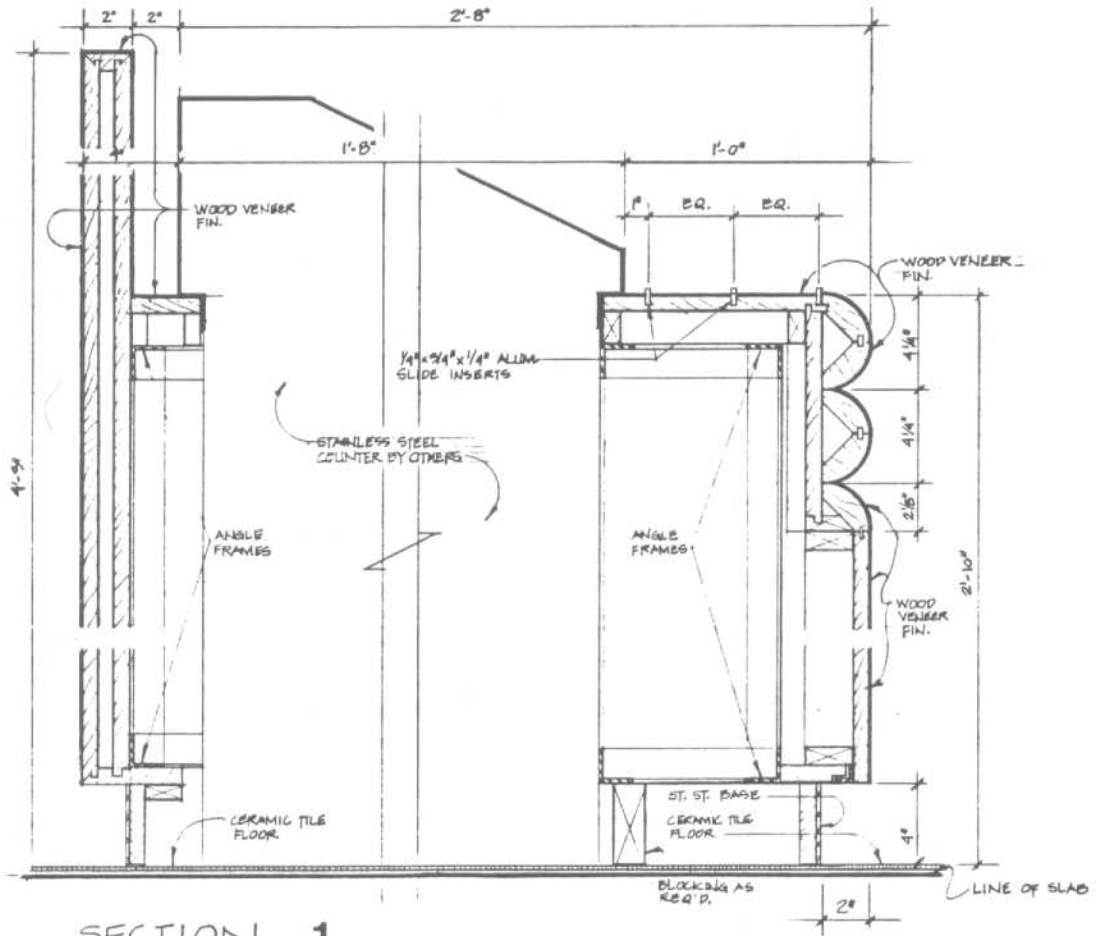
ELEVATION C

SCALE 3/4" = 1'-0"



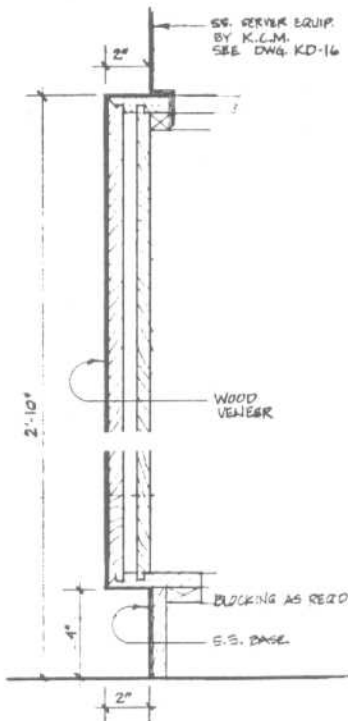
ELEVATION D

SCALE 3/4" = 1'-0"



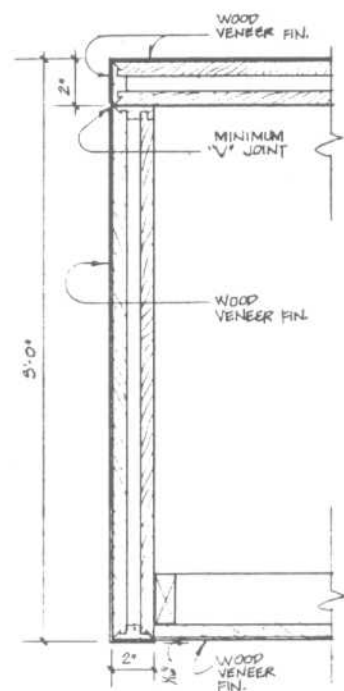
**SECTION 1**

SCALE: 3" = 1'-0"



**SECTION 2**

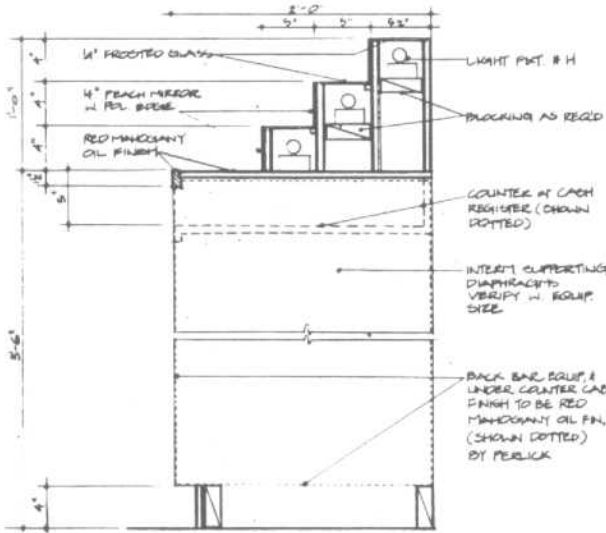
SCALE: 3" = 1'-0"



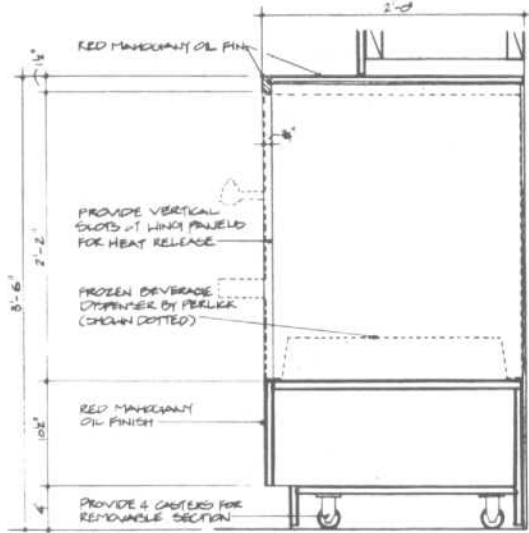
**PLAN SECTION 3**

SCALE: 3" = 1'-0"

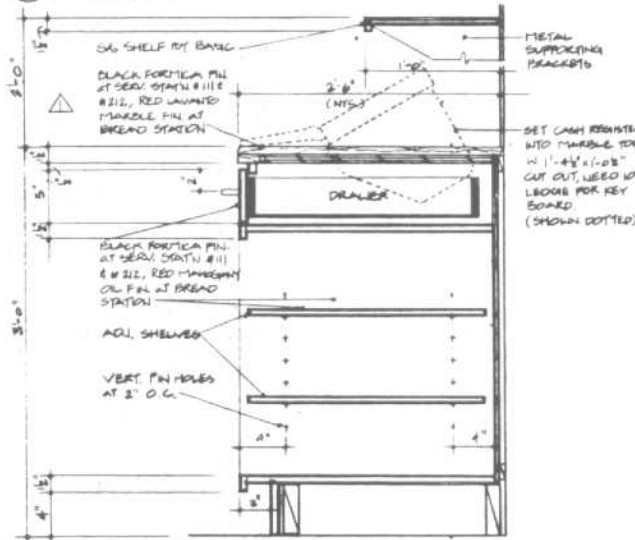




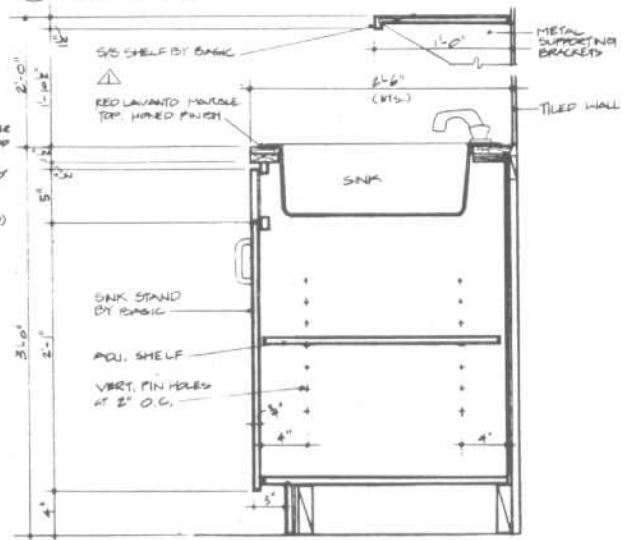
3 SECT. OF BACK BAR COUNTER W. LIQUOR DISPLAY  
A1 SCALE: 1/2" = 1'-0"



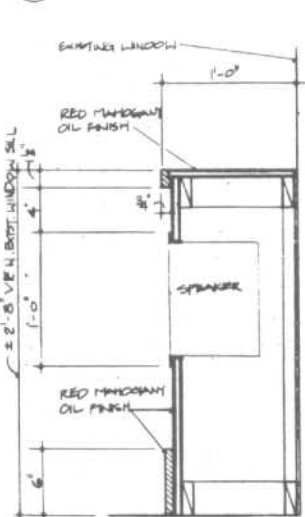
4 SECT. OF CABINET FOR FROZEN BEVERAGE DISPENSER  
A1 SCALE: 1/2" = 1'-0"



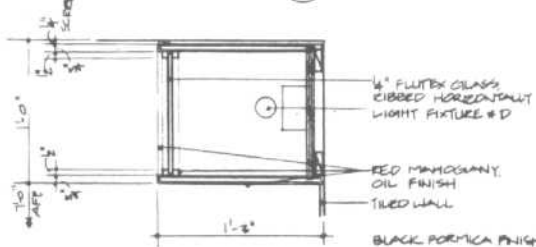
8 CABINET DETAIL AT SERVICE STATIONS # 111 & 112, BREAD STN # 113  
A1 SCALE: 1/2" = 1'-0"



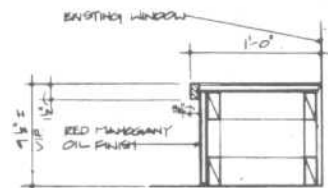
9 CABINET DETAIL AT KITCHEN # 112  
A1 SCALE: 1/2" = 1'-0"



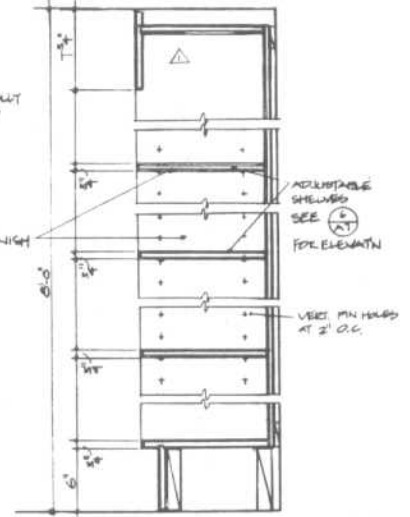
10 DET. OF WINDOW SILL CABINET  
A1 SCALE: 1/2" = 1'-0"



14 LIGHT/CAB ABOVE COUNTER AT KITCHEN # 112  
A1 SCALE: 1/2" = 1'-0"



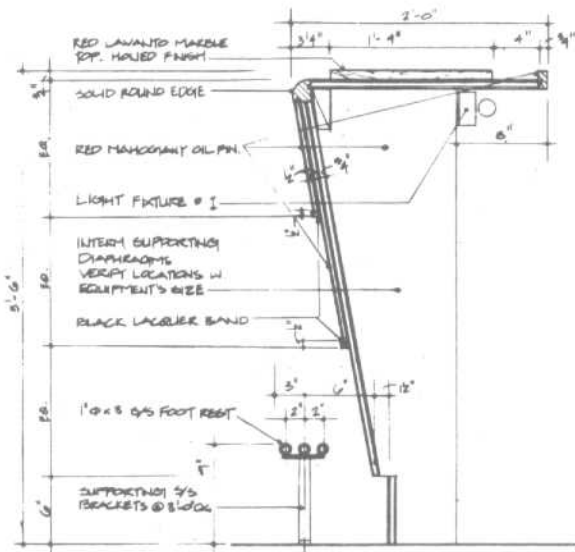
15 DET. OF LOW WINDOW SILL CAB. AT DINING # 111  
A1 SCALE: 1/2" = 1'-0" (GR. DET. AT VIP DINING # 211)



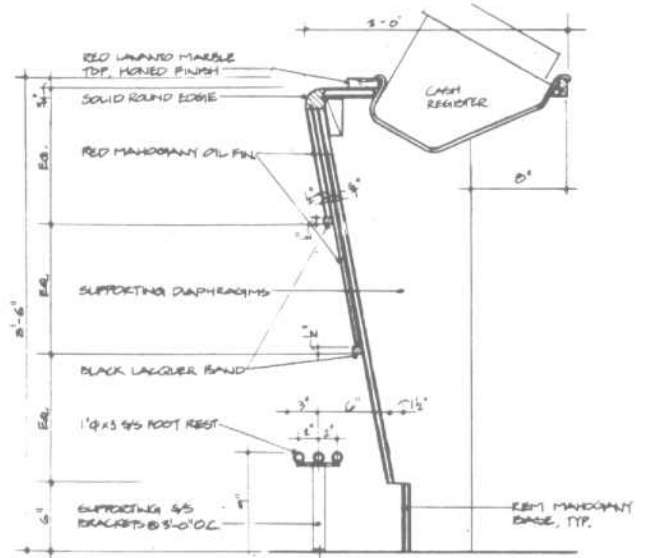
16 CABINET DET. OF GLASS STORAGE  
A1 SCALE: 1/2" = 1'-0"

RESTAURANTS

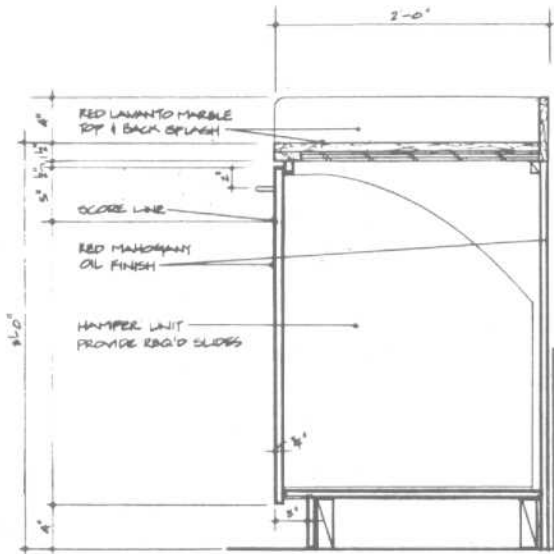
Miscellaneous Counter Details



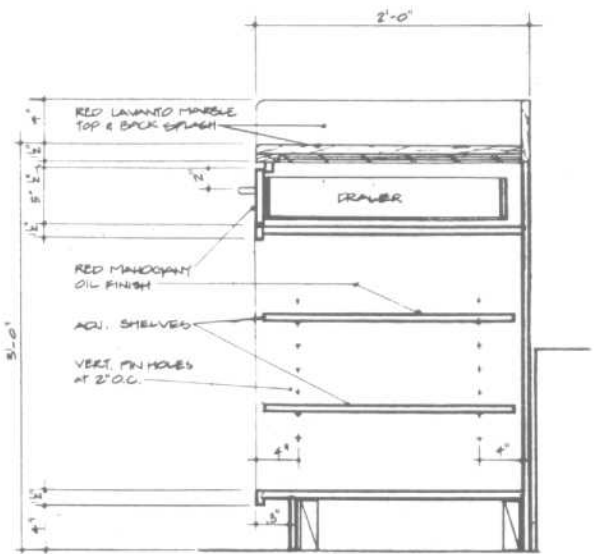
1 SECT. of FRONT BAR COUNTER  
SCALE: 1/8" = 1'-0"



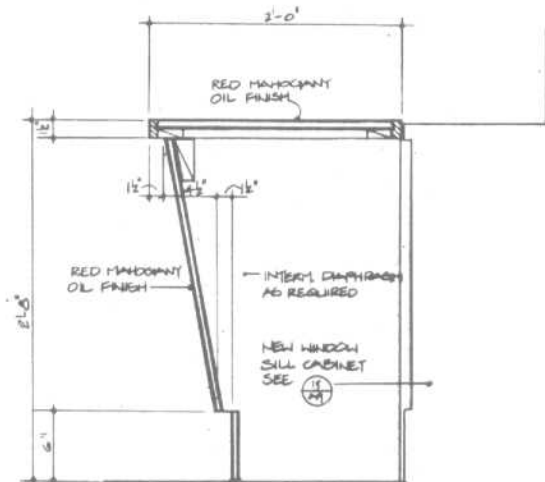
2 SECT. of CASH REGISTER COUNTER at BAR # 108  
SCALE: 1/8" = 1'-0"



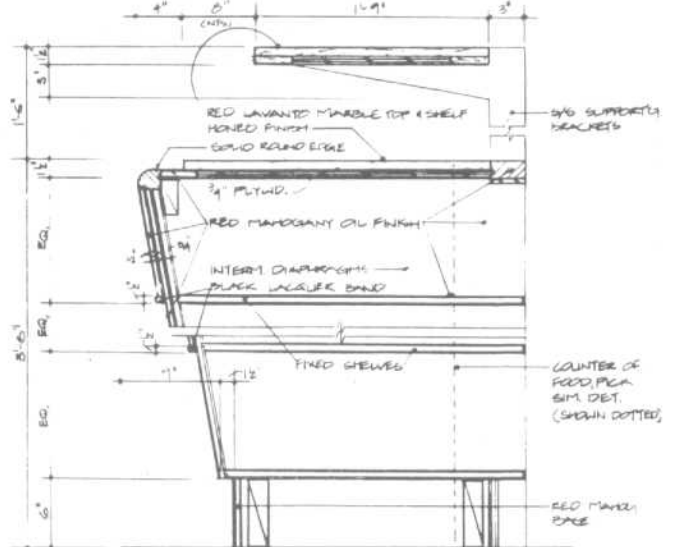
6 CAB. DETAIL of HAMPER UNIT at SERVICE STATION # 108  
SCALE: 1/8" = 1'-0"



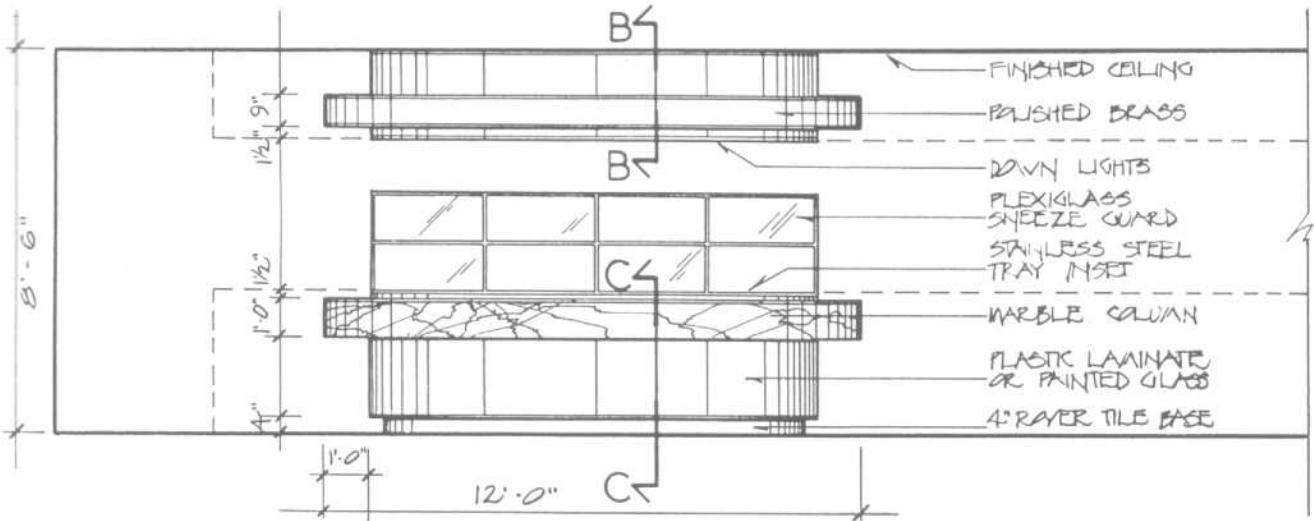
7 CABINET DETAIL at SERVICE STATION # 108  
SCALE: 1/8" = 1'-0"



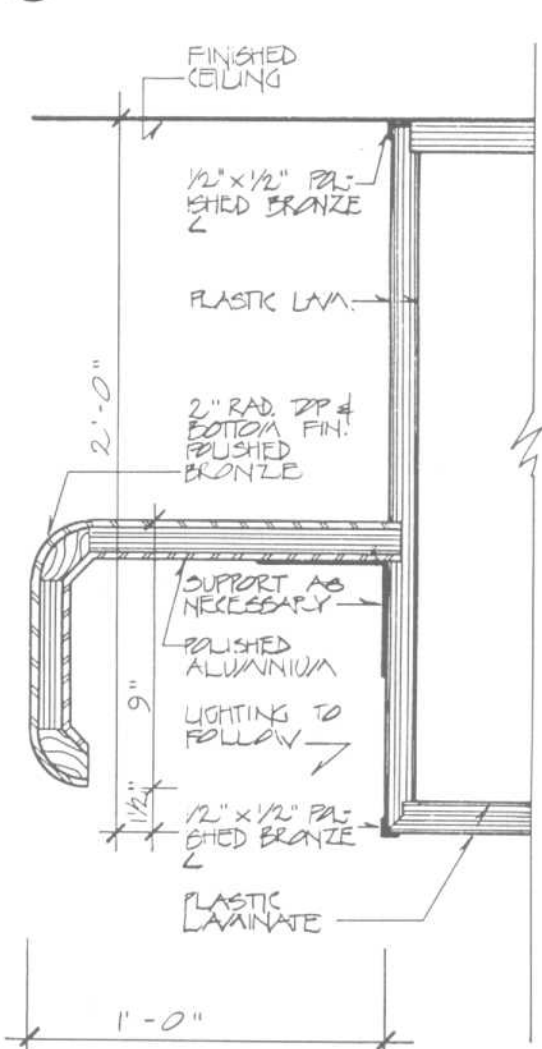
10 DETAIL of FLORAL CABINET  
SCALE: 1/8" = 1'-0"



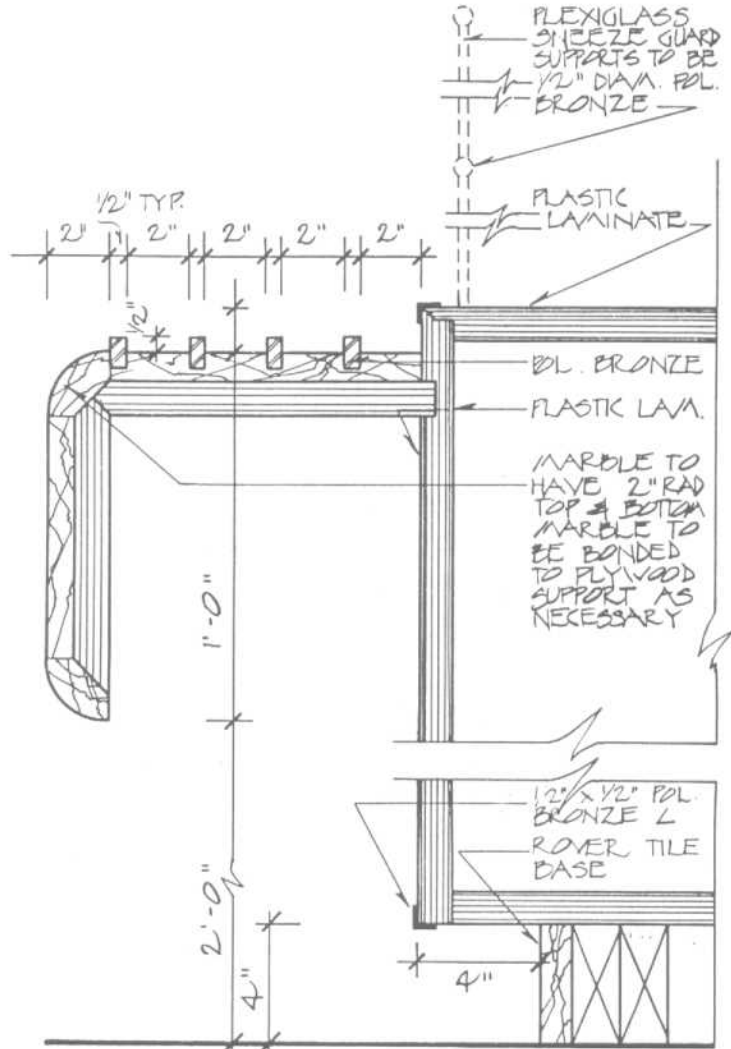
5 SECT. of COUNTER at ESPRESSO & ANTIPASTO # 108  
SCALE: 1/8" = 1'-0"



**A** ELEVATION OF SERVING ISLAND



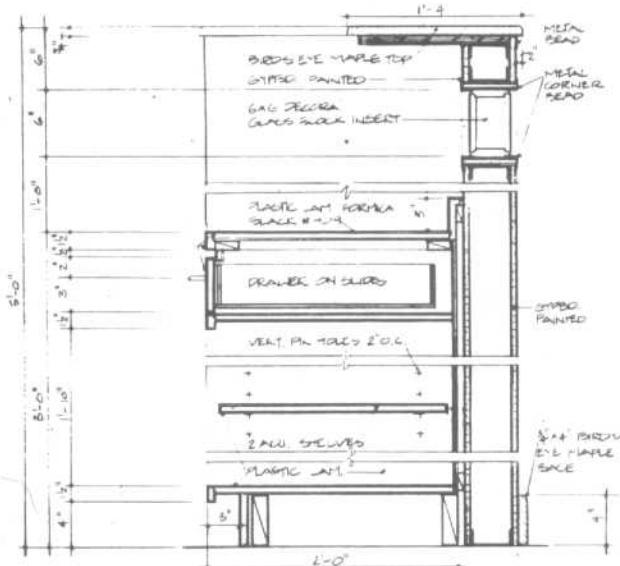
**BB** SECTION THRU HOOD



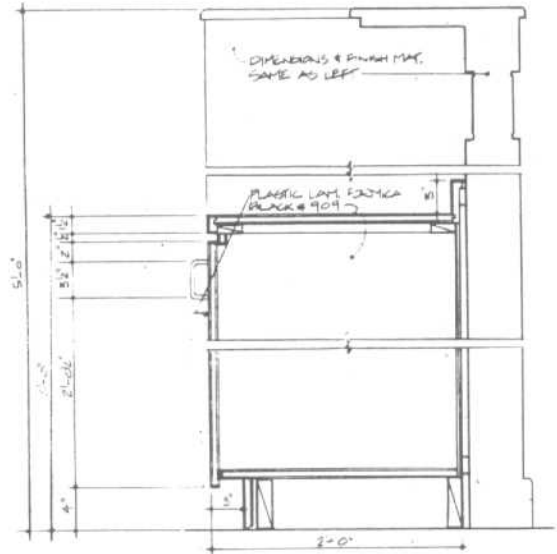
**CC** SECTION THRU SERVING COUNTER

RESTAURANTS

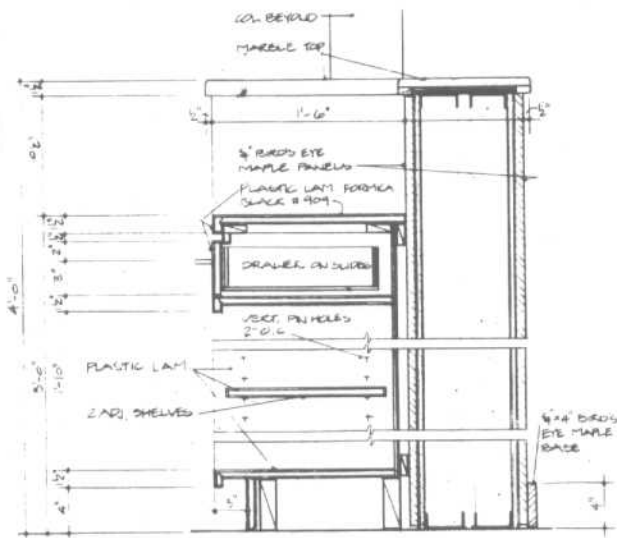
Waiter Station/Host Counter Details



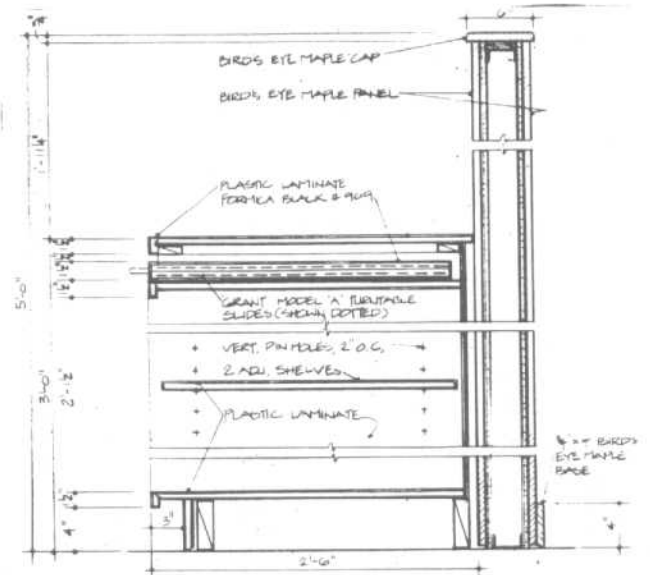
1 CABINET SECTION at WAITER STATIONS #11 & #12  
SCALE: 1/2" = 1'-0"



2 CABINET SECTION at WAITER STATIONS #11 & #12  
SCALE: 1/2" = 1'-0"

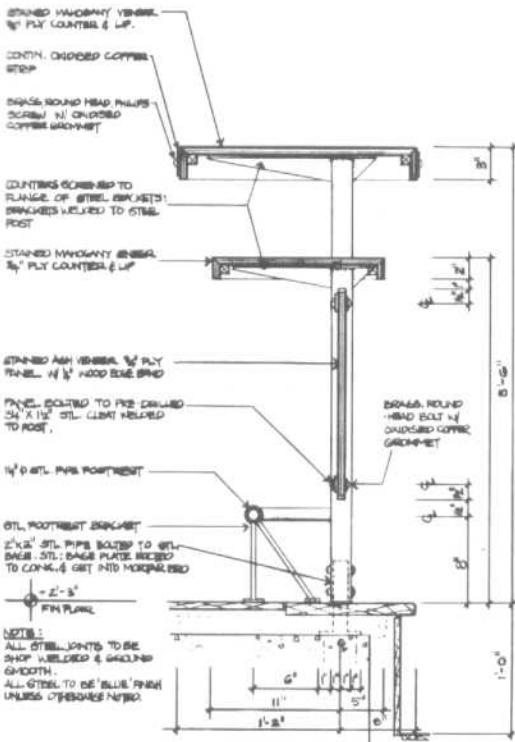


3 CABINET SECTION at HOST COUNTER (NORTH)  
SCALE: 1/2" = 1'-0"

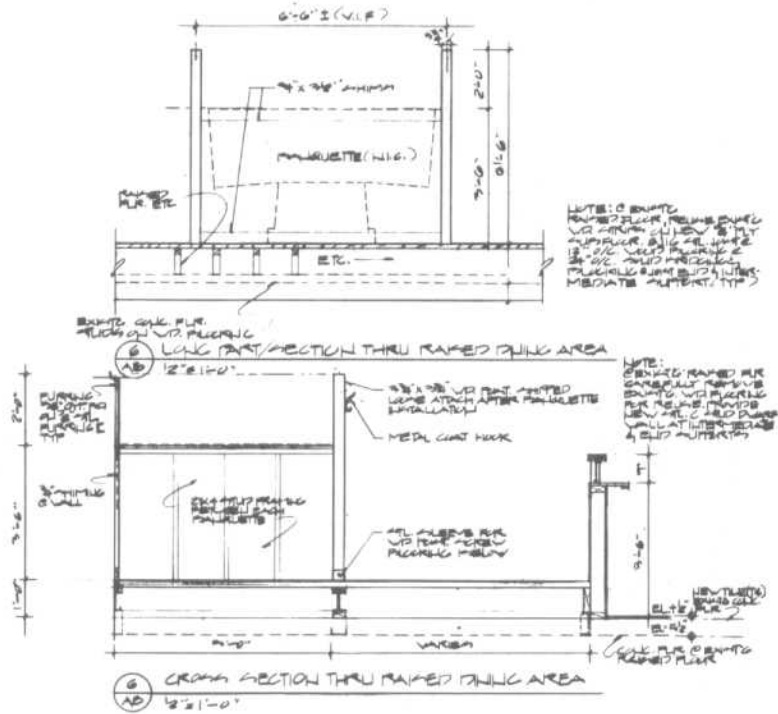


4 CABINET SECTION at HOST COUNTER (SOUTH)  
SCALE: 1/2" = 1'-0"

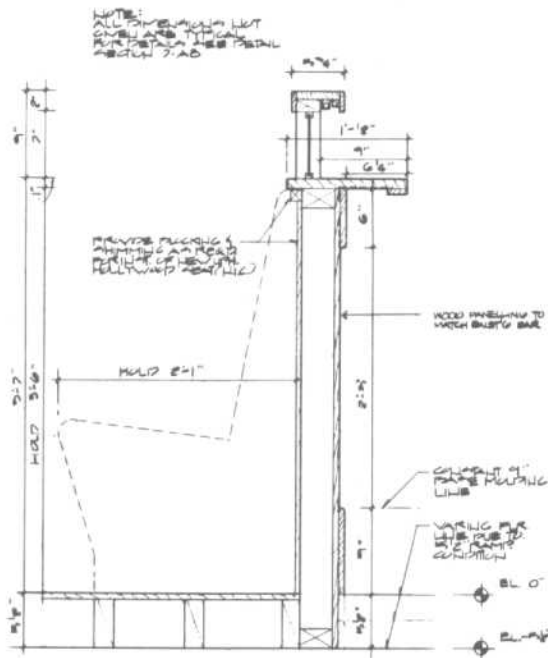
Fig. 33 Waiter stations and host/hostess counters can be designed as freestanding elements or integrated into the interior architecture, as shown by these details. Special attention must be given to specific drawer and storage requirements.



3  
A1B  
DETAIL OF LUNCH COUNTER  
12" x 11'-0"



8  
AB  
CROSS SECTION THRU RAISED DINING AREA  
12" x 11'-0"



10  
AB  
SECTION CURVED SEAT IN SHUFFLE DECK AREA  
12" x 11'-0"

RESTAURANTS

Wheelchair Accessibility to Self-Service Areas

Self-Service Areas

Salad bars, buffet lines, condiment stands, and other self-service areas should be accessible. Cafeteria or food-service lines should have a minimum width of 3'0", but a width of 3'6" is recommended to permit ambulatory customers to pass customers in wheelchairs.

The tray slide should be 2'10" above the floor, the maximum height for customers in wheelchairs and convenient for ambulatory guests. The tray slide should be continuous, if possible, from the entrance to the cashier. Tray slides restrict access to the counters and therefore should not be wider than necessary (1'0" recommended). In this instance, the reach of a customer in a wheelchair is extended if the wheelchair can be angled or positioned perpendicular to the tray slide. This is possible if the lower face of the counter is recessed to provide low knee-space. (See Fig. 34.)

For guests with a limited range-of-motion, food, beverages, utensils, or other items should be displayed near the edge of the counter where they are easier to see and reach. When duplicate items are displayed, a vertical rather than horizontal arrangement allows customers to select items at the most convenient height. Self-service systems, such as beverage or ice-dispensers, should be easy to operate without fine hand function. Instructions and price information should be prominently displayed in large clear lettering.

Salad bars and buffets should provide a 3'0" wide clear space for access on all sides and plate slides, or areas to temporarily set plates, at a maximum height of 2'10". This permits customers to serve themselves with one hand, without simultaneously balancing the plate or bowl. Kneespace 2'3" high below the counter or table allows front wheelchair approach, to increase customers' forward reach. Condiments should be located as low and close to the edge of the counter or table as practical. A tilted mirror above the food display at salad bars also aids customers in wheelchairs and children. (See Fig. 35.) For some customers with restricted mobility, poor balance, or limited hand function, it is more difficult to carry a plate. Therefore trays should be available at both salad bars and buffets.

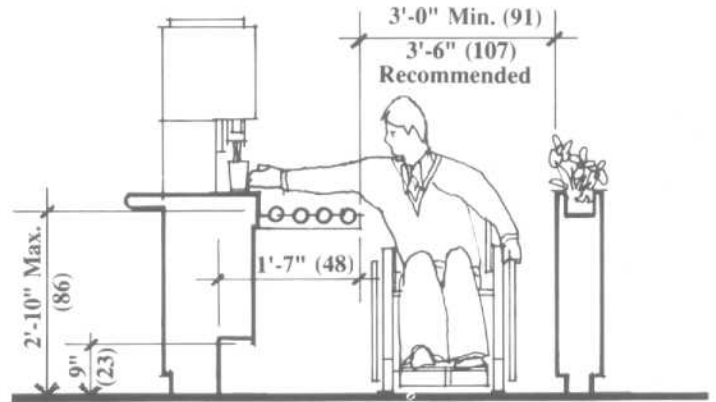


Fig. 34 Cafeteria lines should be wide enough to accommodate guests in wheelchairs. Food and beverages should be within a convenient vertical and horizontal reach. Numbers in parentheses are dimensions in centimeters.

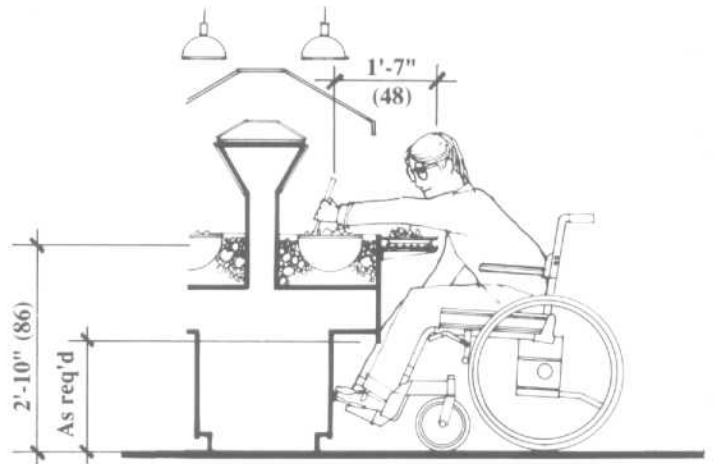
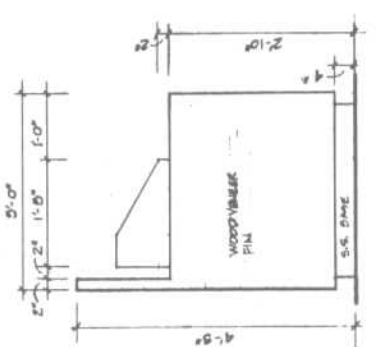
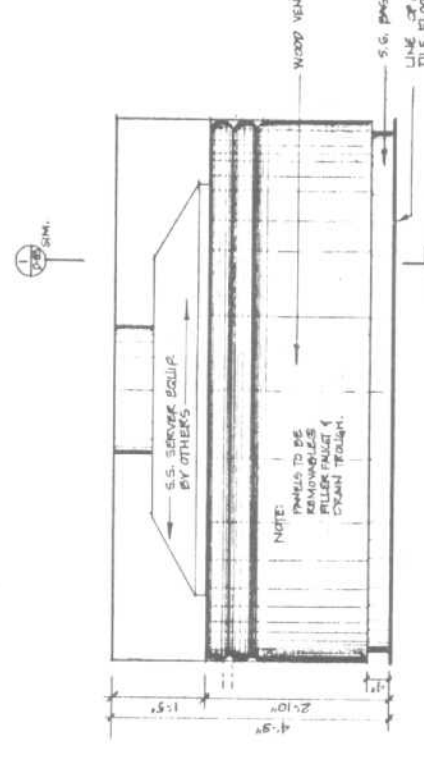
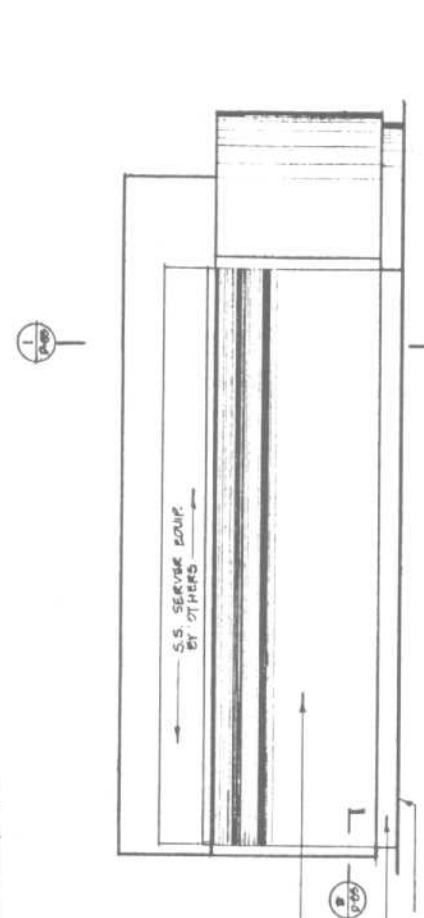
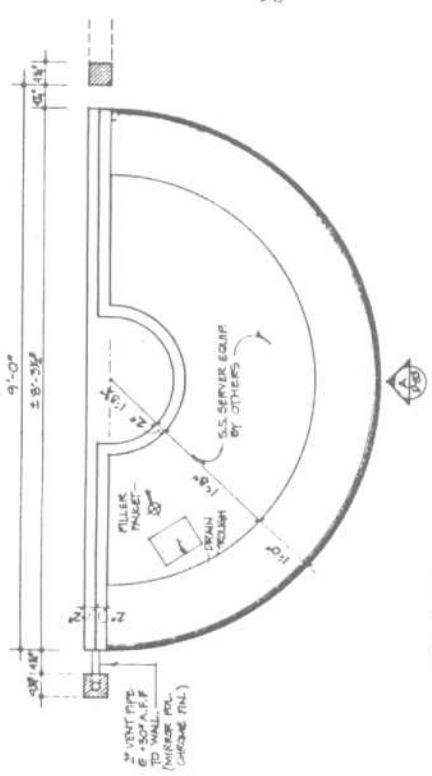
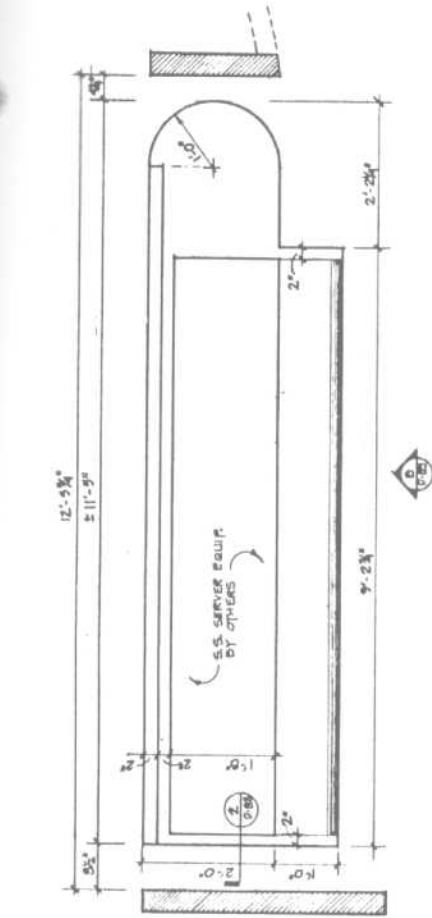
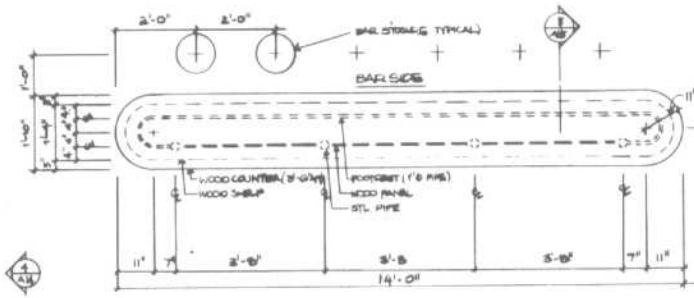


Fig. 35 A plate slide is recommended at salad bars and a kneespace at the counter. A mirrored surface above the bar is a further aid to guests in wheelchairs. Numbers in parentheses are dimensions in centimeters.

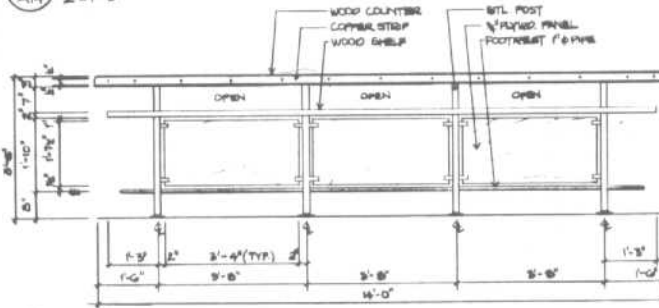


RESTAURANTS

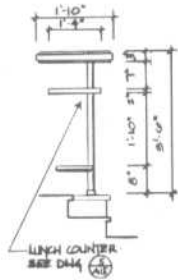
Lunch Counters: Cashier Station



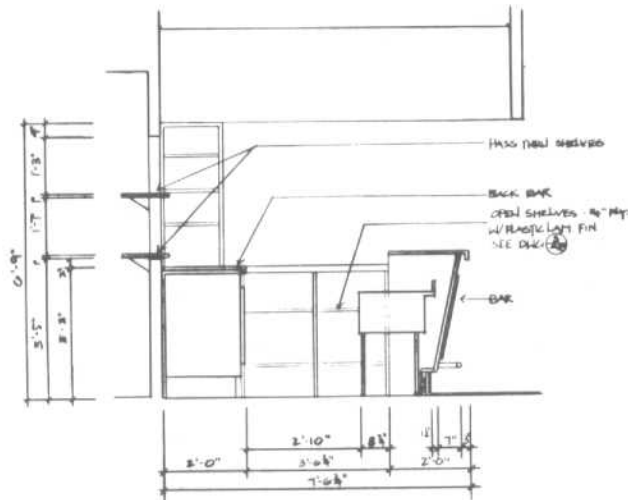
6 PLAN OF LUNCH COUNTER  
A14 2' = 1'-0"



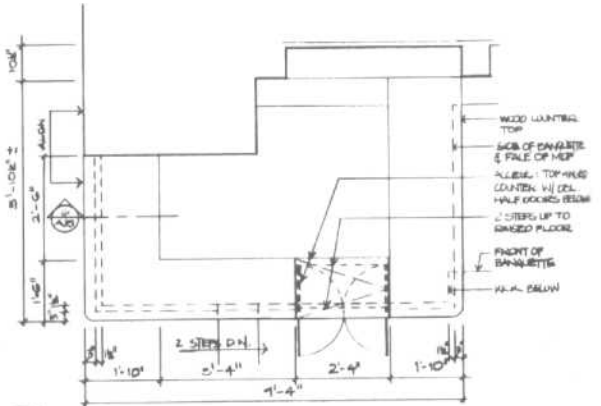
7 ELEVATION OF LUNCH COUNTER FROM DINING ROOM  
A14 2' = 1'-0"



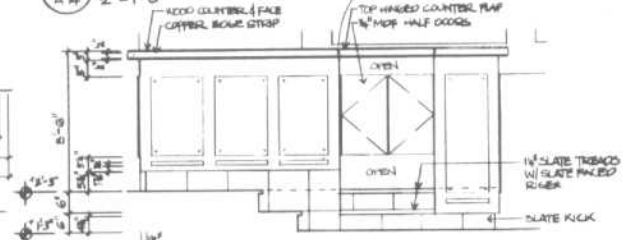
8 SIDE ELEVATION OF LUNCH COUNTER  
A14 2' = 1'-0"



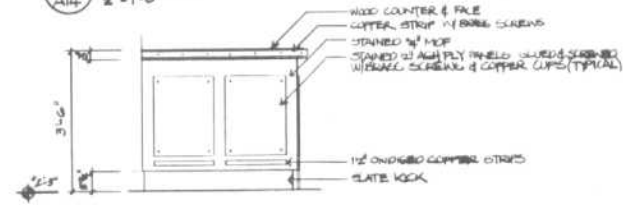
9 SECTION THRU BAR  
A14 2' = 1'-0"



10 PLAN OF CASHIER STATION  
A14 2' = 1'-0"



11 SOUTH ELEVATION OF CASHIER STATION  
A14 2' = 1'-0"

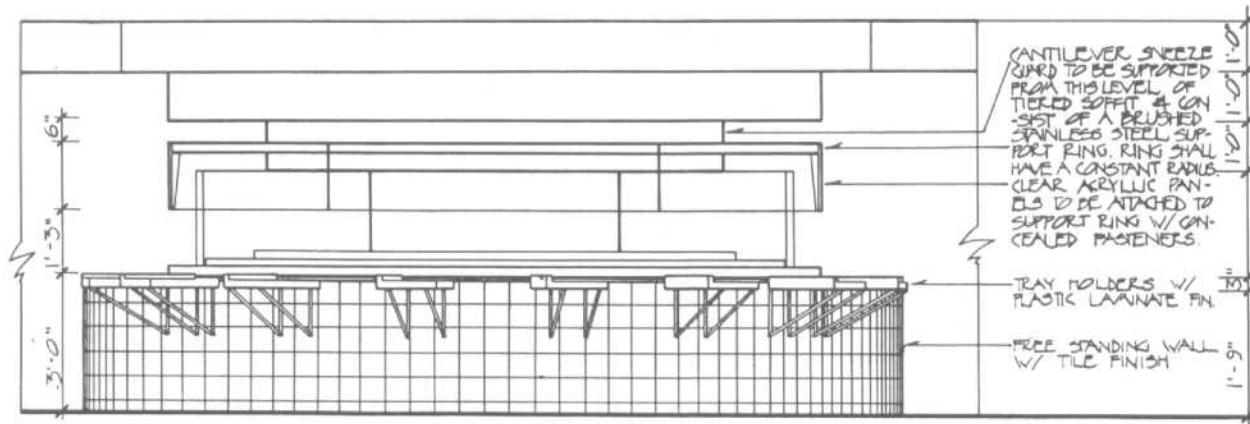


12 WEST ELEVATION OF CASHIER STATION  
A14 2' = 1'-0"

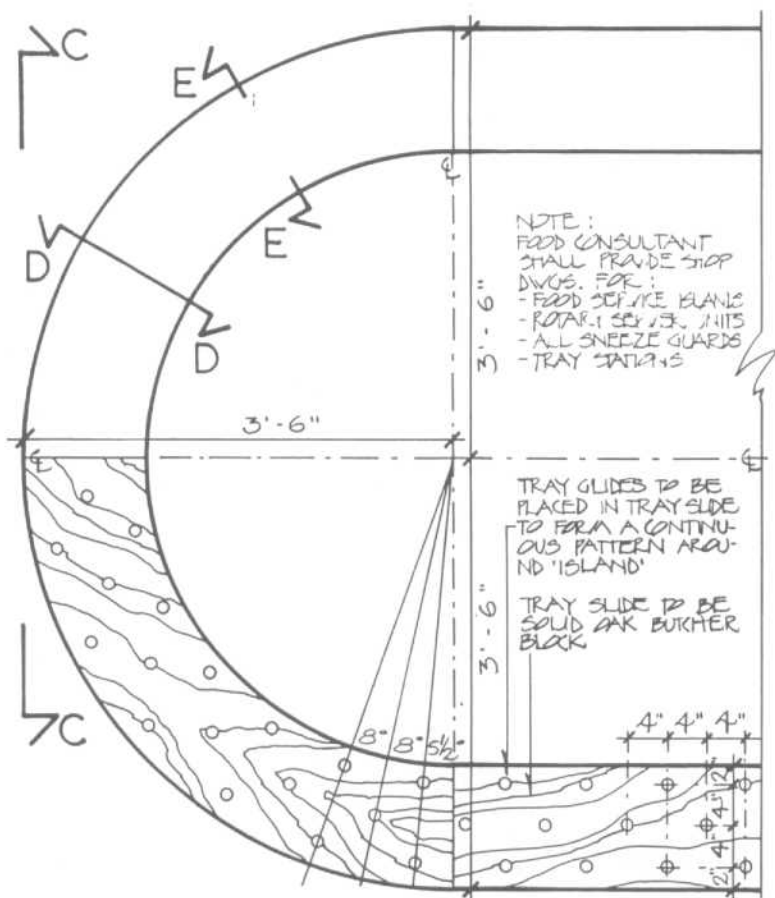


13 EAST ELEVATION OF CASHIER STATION  
A14 2' = 1'-0"

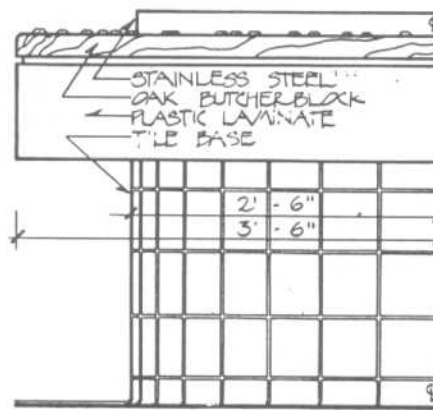




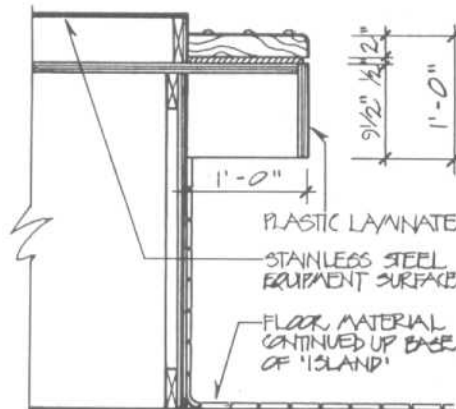
**A** ELEVATION OF TYPICAL 'ROTARY SERVING' UNIT



**B** PARTIAL PLAN OF TYPICAL 'ISLAND'



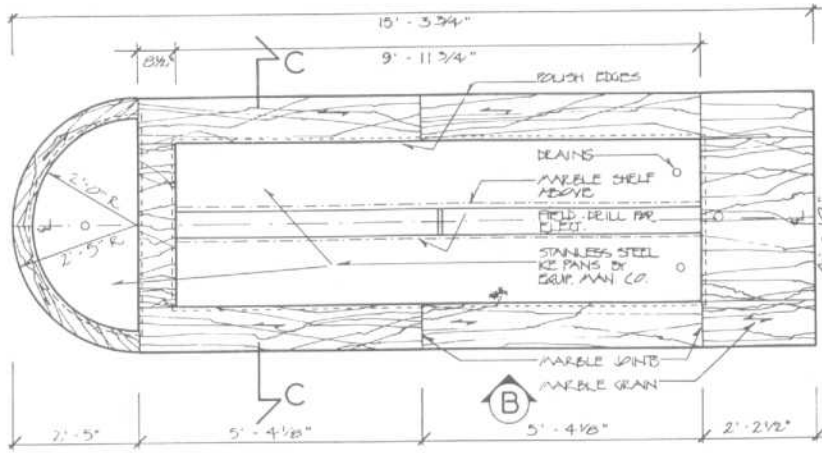
**C** PARTIAL ELEVATION



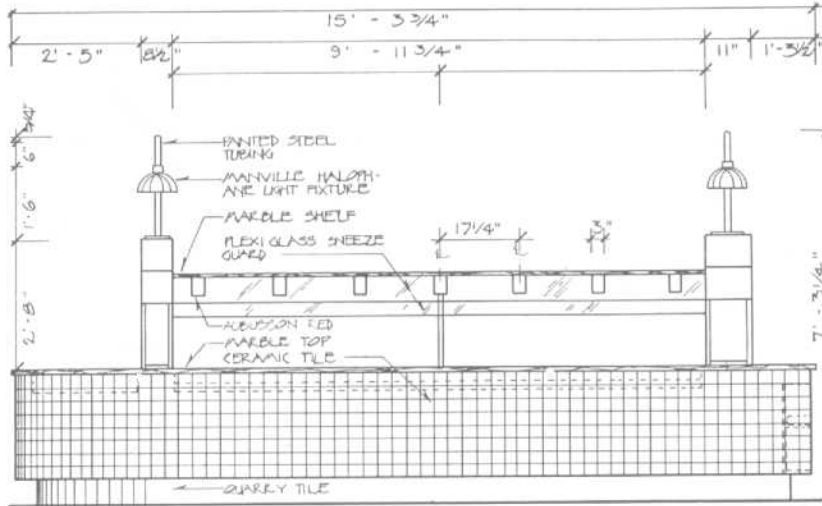
**DD** SECTION OF TRAY SLIDE

RESTAURANTS

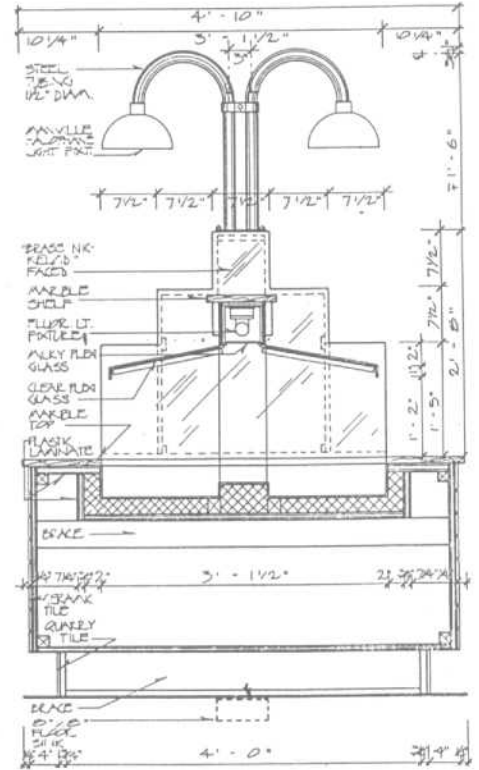
Cafeteria/Servery Counter Details



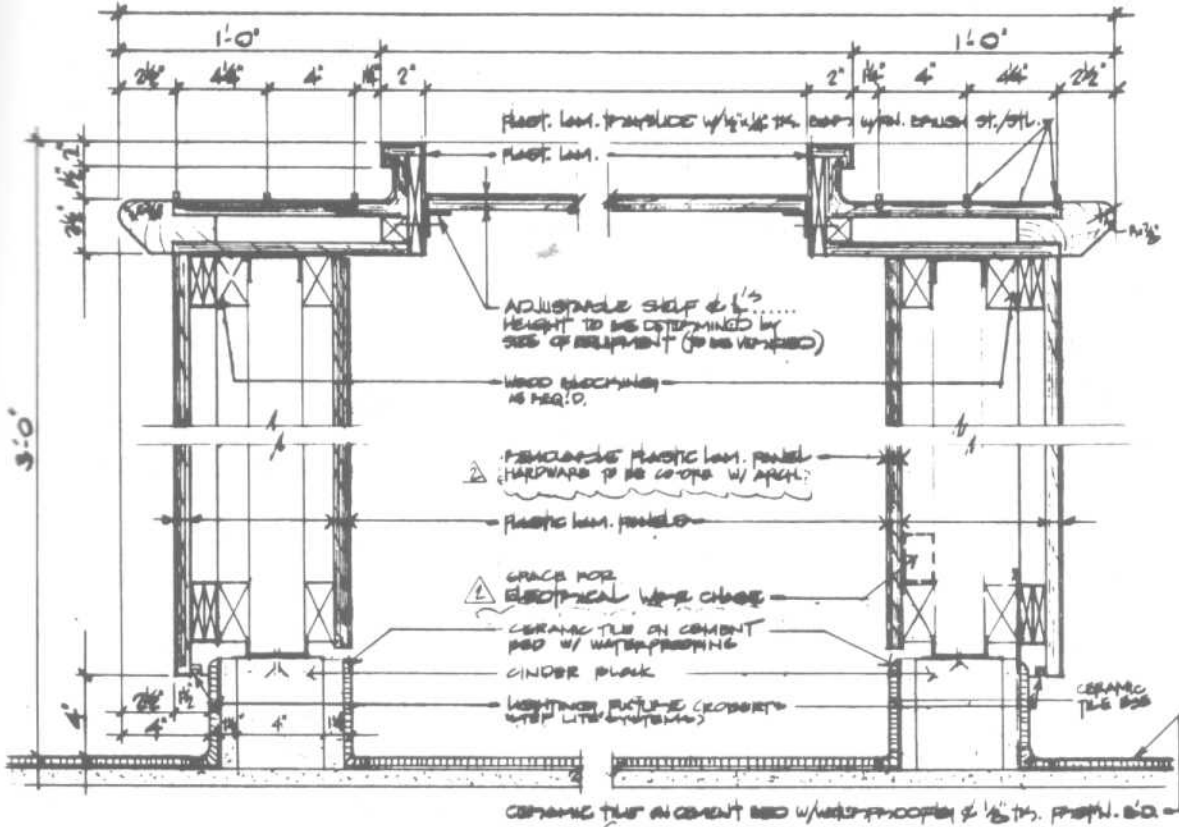
**A** PLAN AT MARBLE COUNTER



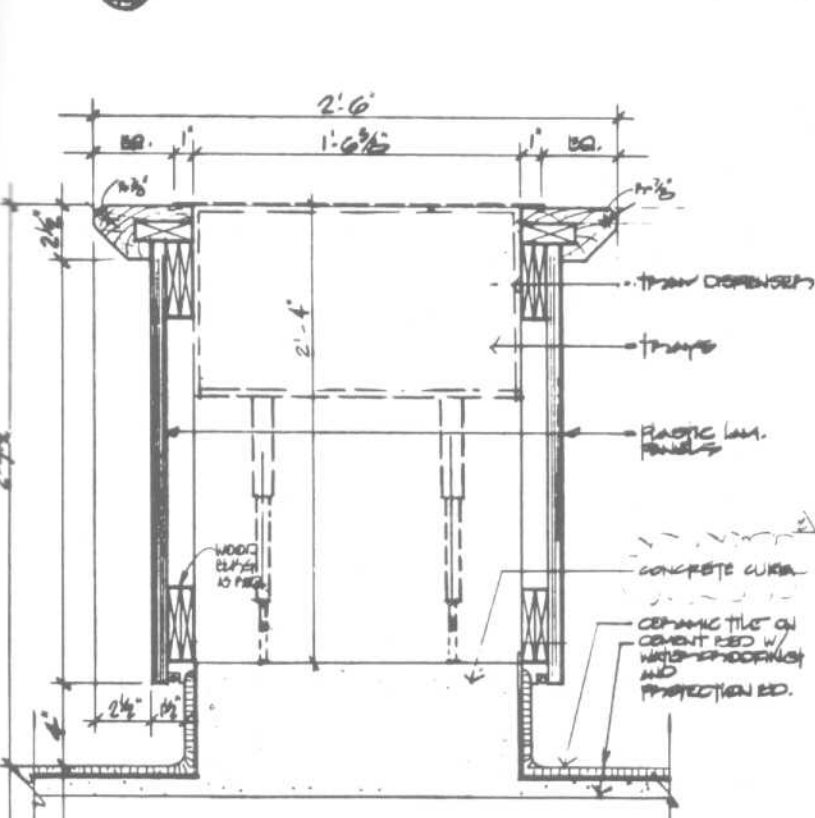
**B** ELEVATION



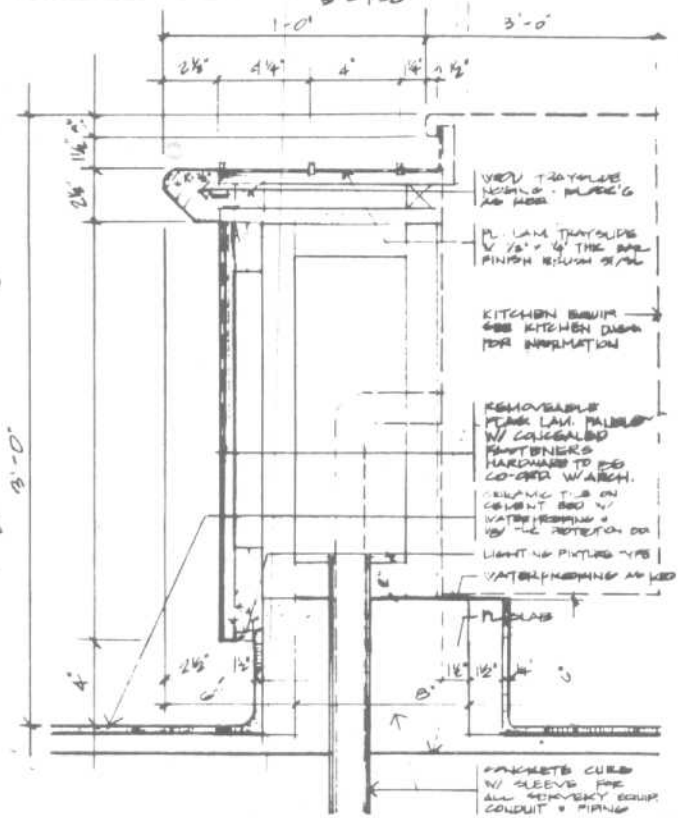
**CC** SECTION



1 SECTION THROUGH CASHIER'S COUNTER



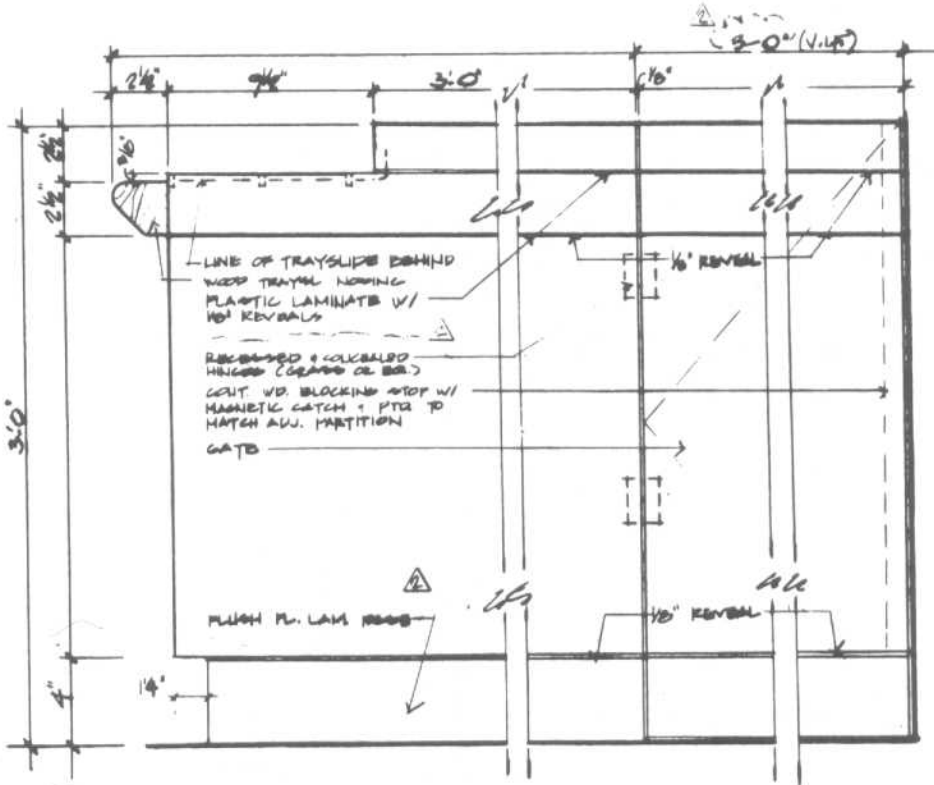
2 SECTION THROUGH TRAY PICK-UP COUNTER



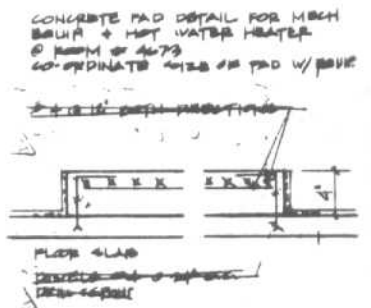
3 SECTION DETAIL - SERVERY TRANSGLIDE

RESTAURANTS

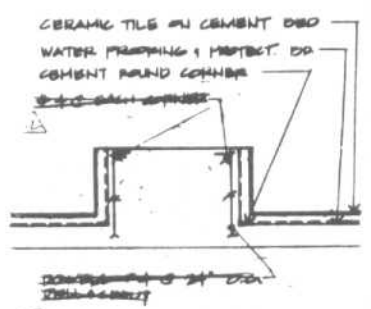
Cafeteria/Servery Counter Details



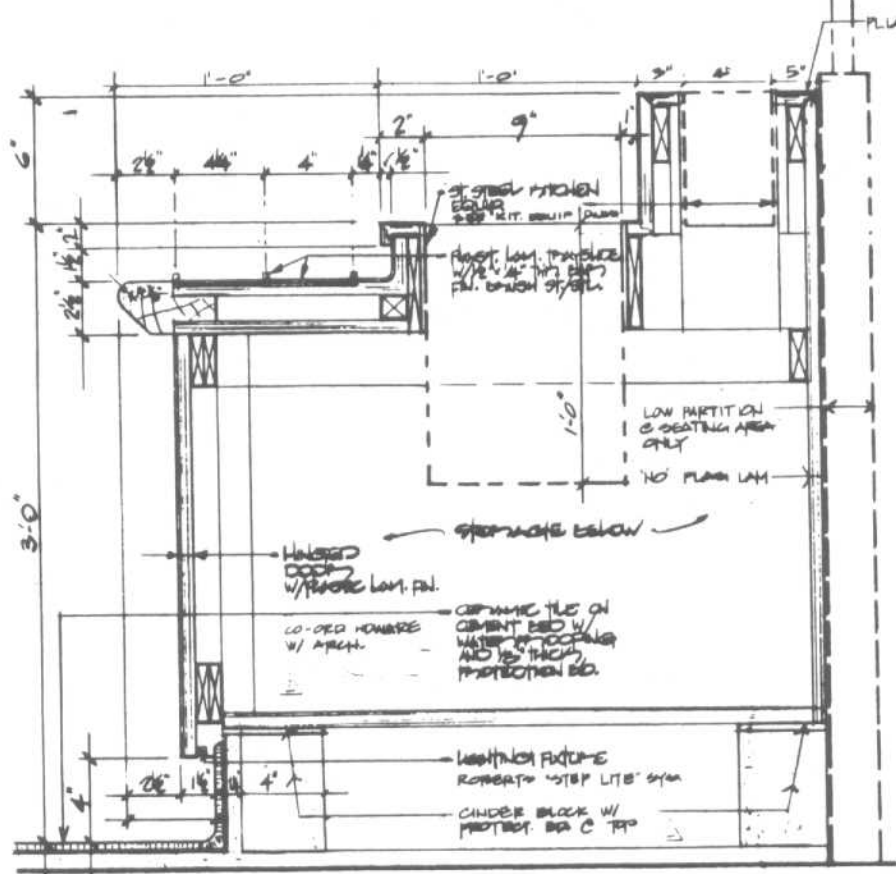
4 ELEVATION @ SIDE + GATE SERVERY ISLAND  
 1/8" = 1'-0"



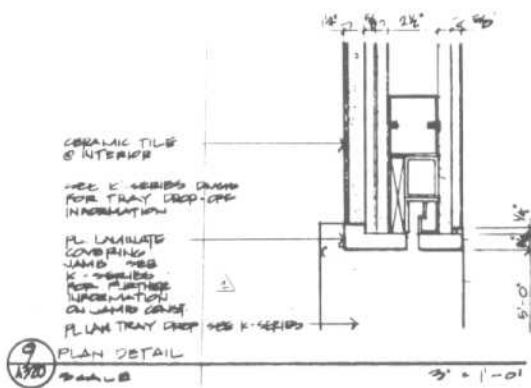
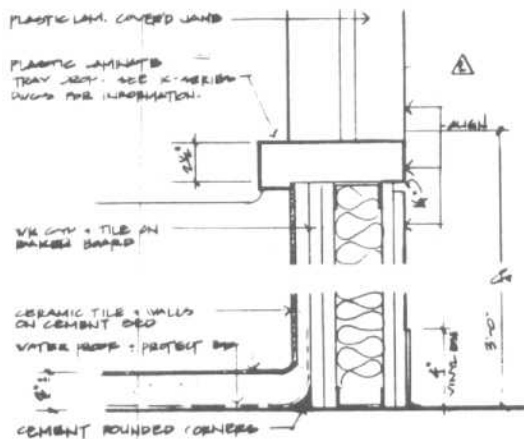
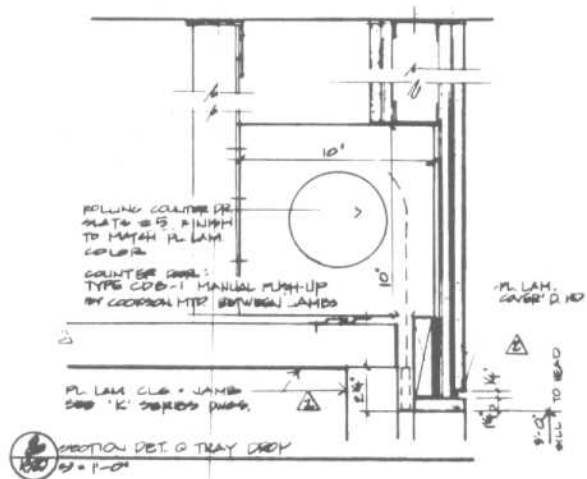
5 CONCRETE PAD DETAIL  
 1/4" = 1'-0"



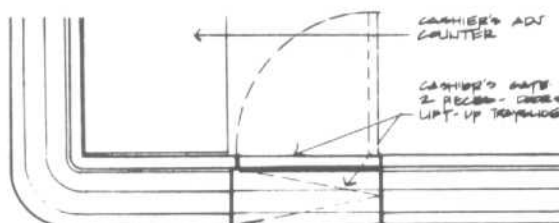
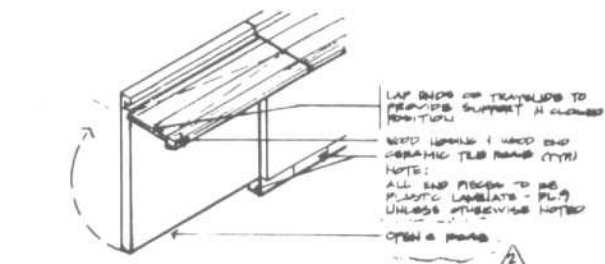
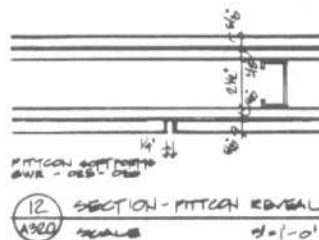
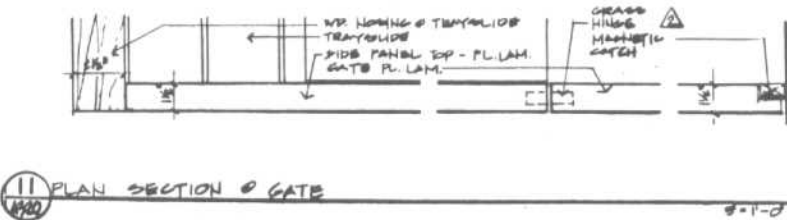
6 CONCRETE CURB @ SERVERY COUNTER  
 1/4" = 1'-0"



7 SECTION THROUGH CONDIMENT COUNTER  
 SCALE  
 1/8" = 1'-0"



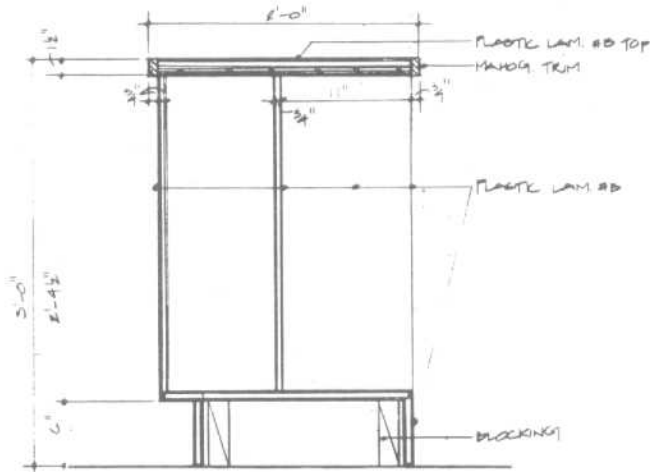
SECTION DETAIL OF TRAY DROP  
 SCALE: 3/8" = 1'-0"



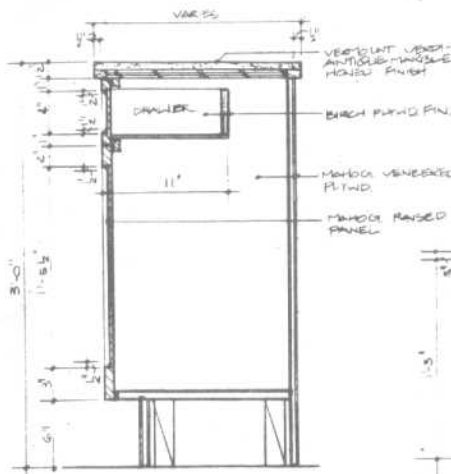
AXONOMETRIC + PLAN CASHIER'S GATE  
 SCALE

RESTAURANTS

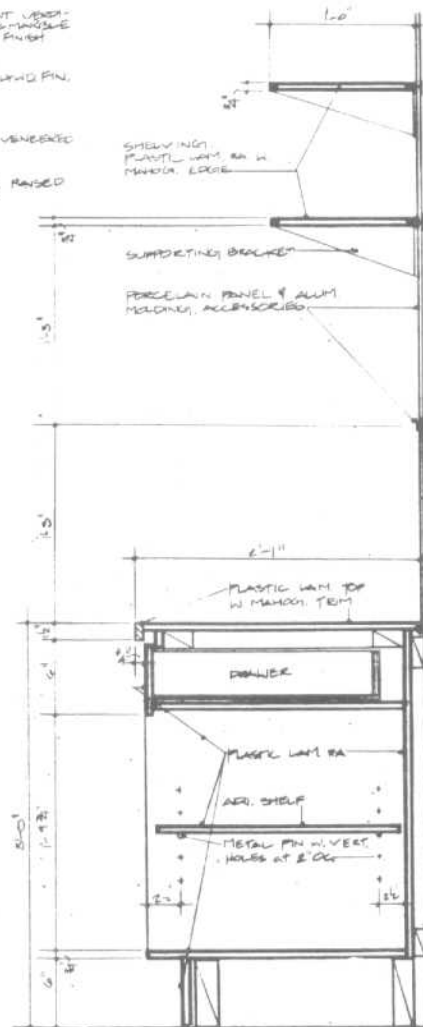
Service Counter; Host Cabinet; Waiter's Station; Trash Counter



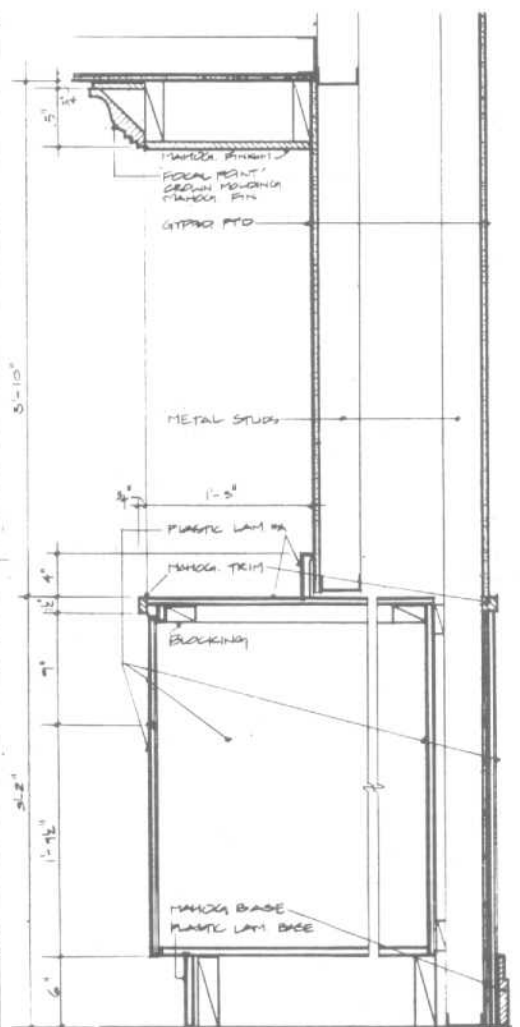
15 SECTION THRU SERVICE COUNTER  
ALL SCALE: 1/2" = 1'-0"



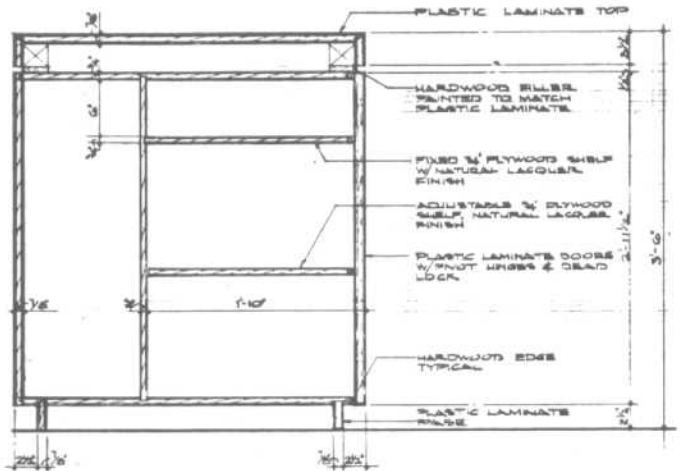
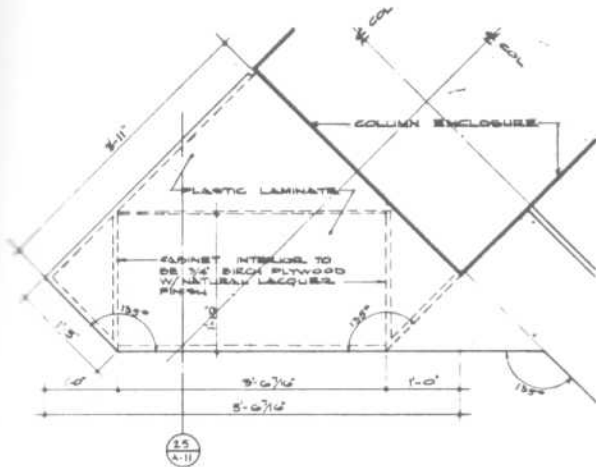
16 SECT. OF HOST CABINET  
ALL SCALE: 1/2" = 1'-0"



18 TYP. WAITER'S STATION CABINET  
ALL SCALE: 1/2" = 1'-0"



19 SECT. OF TRASH COUNTER CABINET  
ALL SCALE: 1/2" = 1'-0"

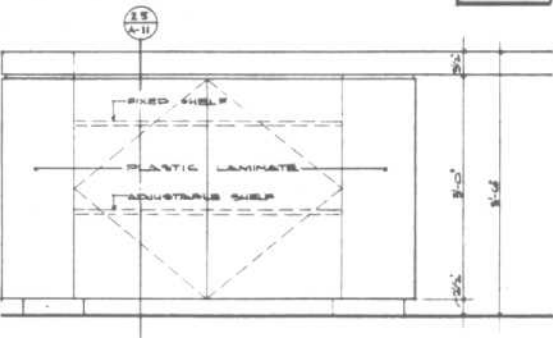


23 CONDIMENT CABINETS  
SPACE NO. 21 @ 1'-0"

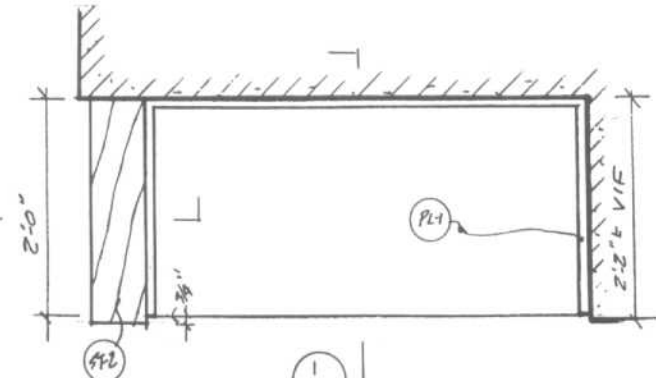
CW  
13

25

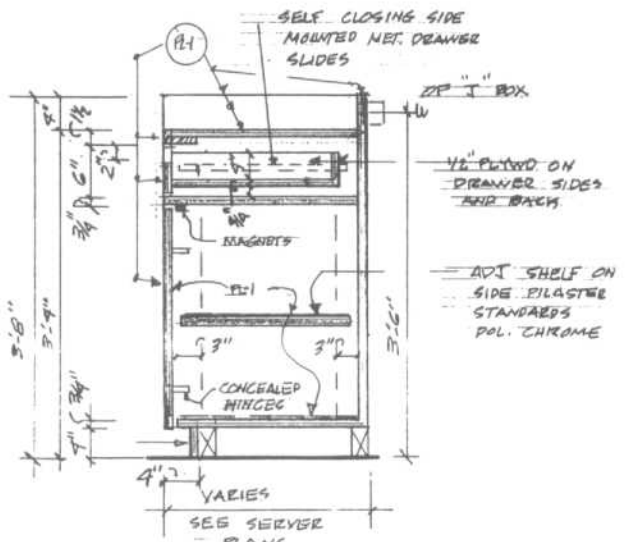
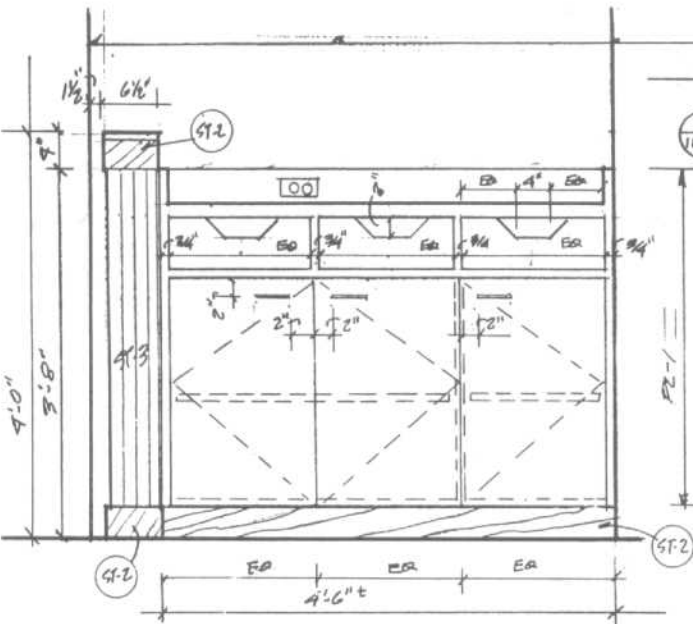
NOTE:  
ALL PLASTIC LAMINATE  
SHALL BE TEXTURITE  
MUSHROOM NO. 682



24 @ 1'-0"



2 SERVER PLAN C... DINING RM. # 4  
11/7/01



A SERVER SECT. BLEV. C DINING RM. # 4  
1"=1'-0"

1 TYP. SERVER SECTION  
1"=1'-0"

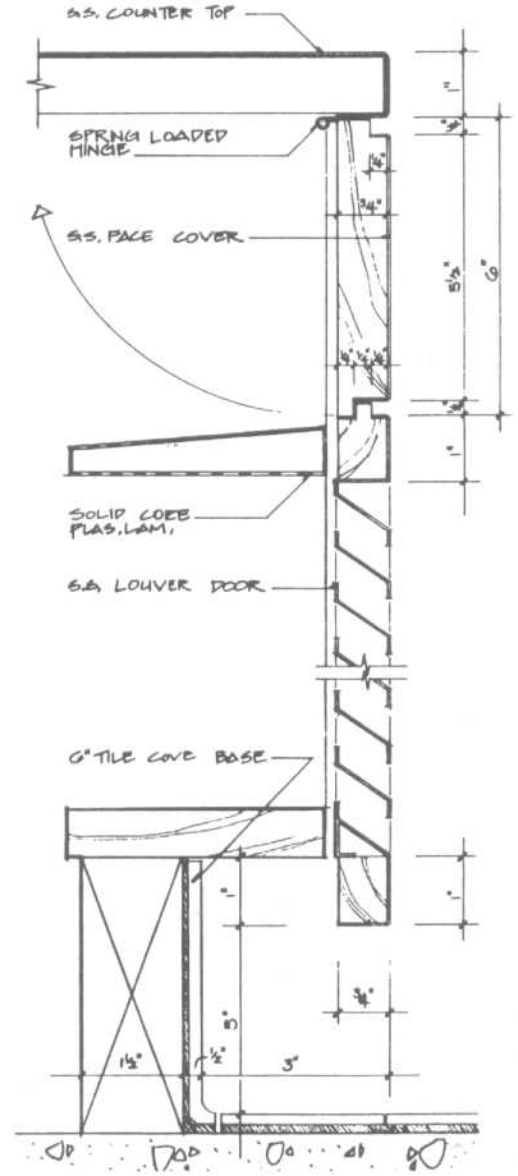
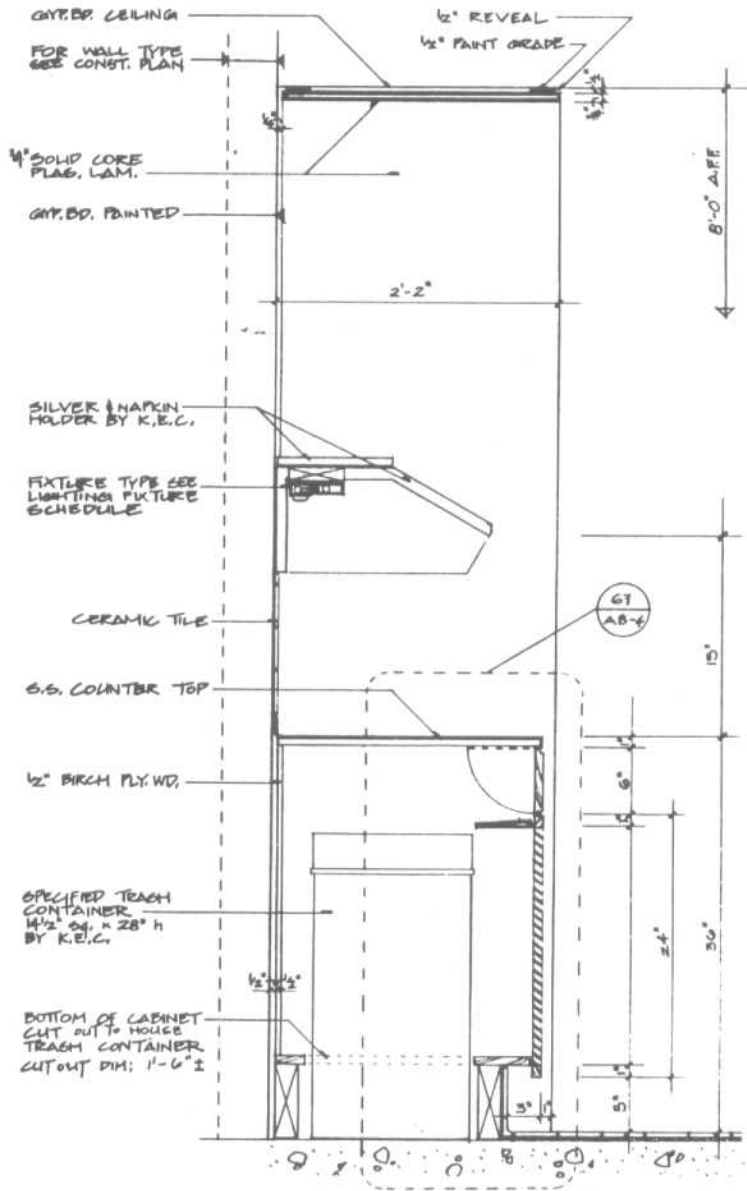




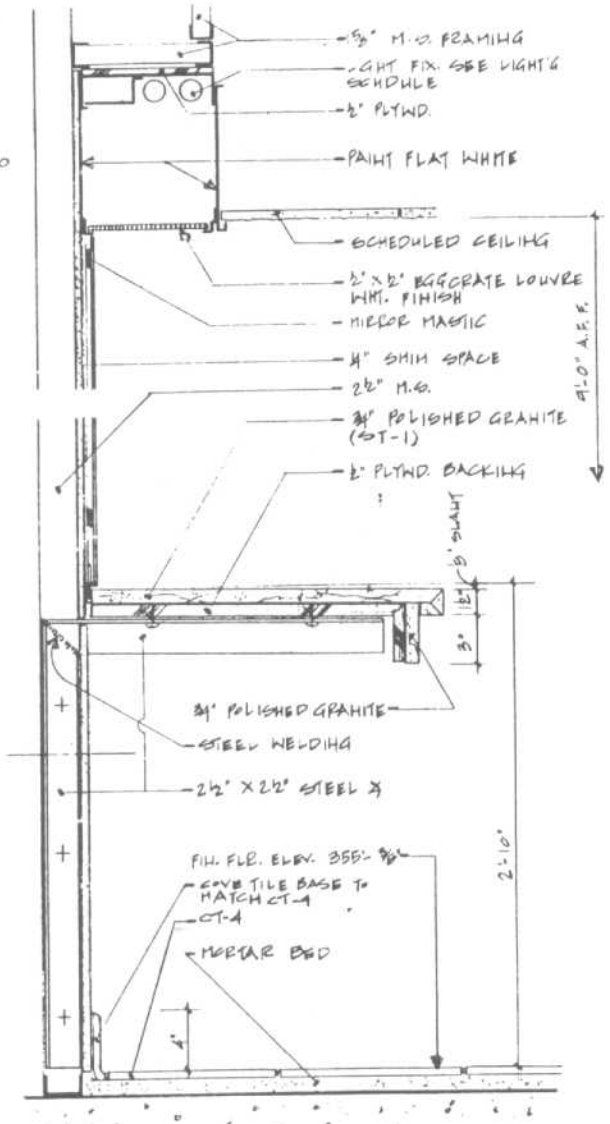
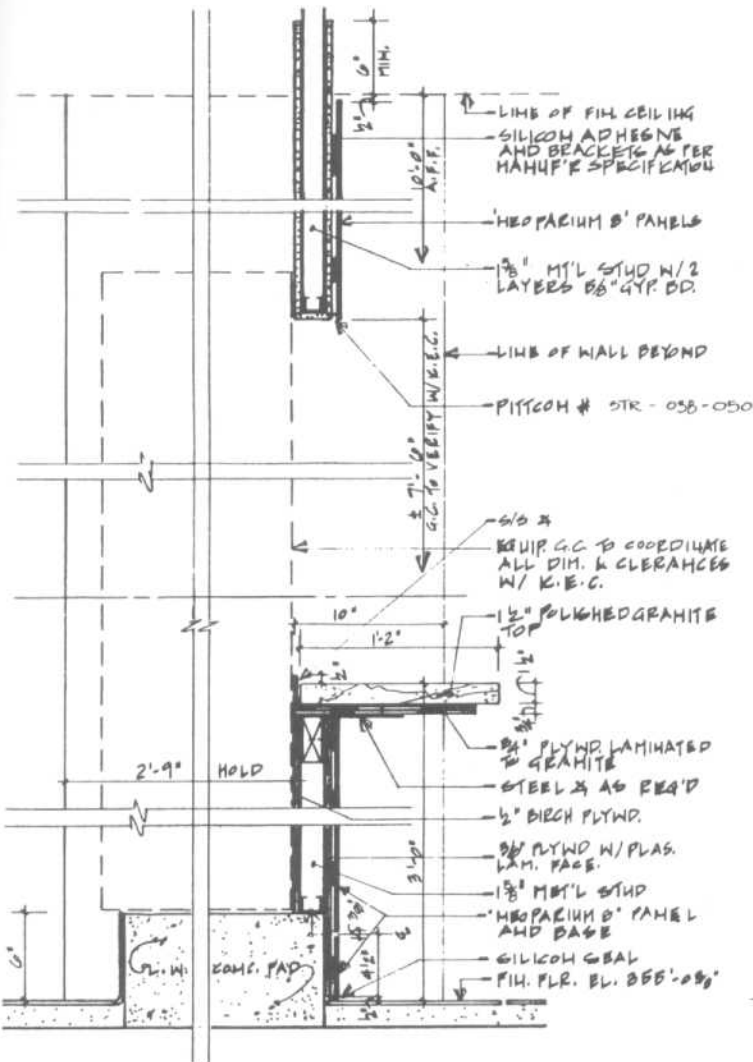


RESTAURANTS

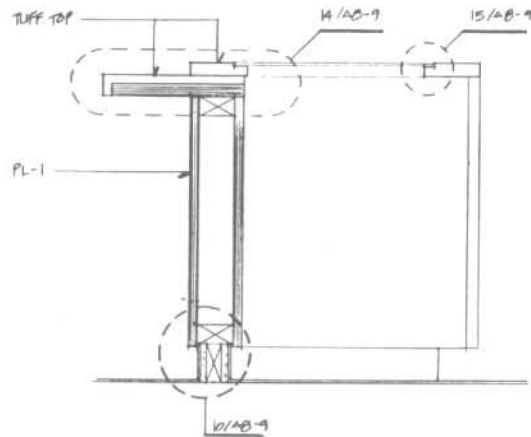
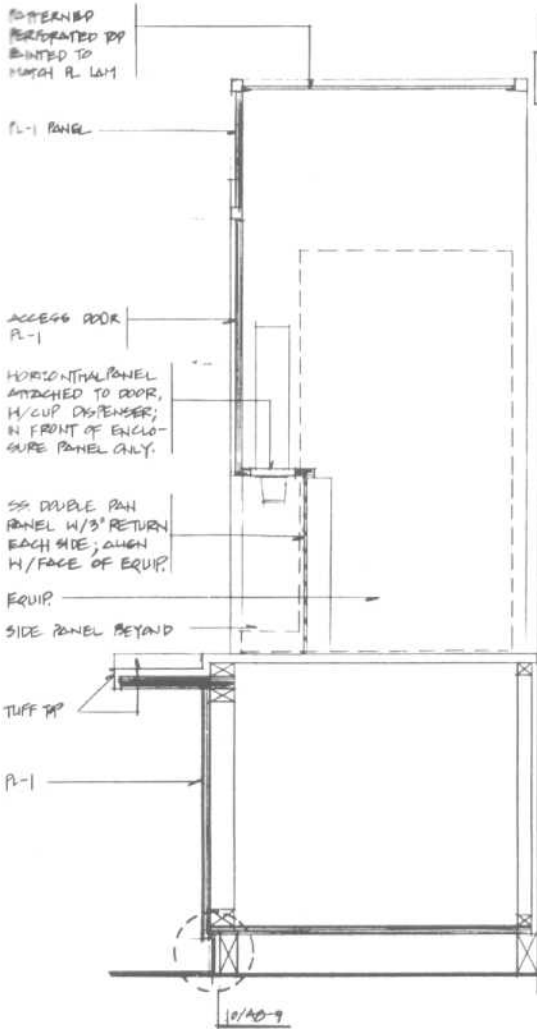
Condiment Counter Details



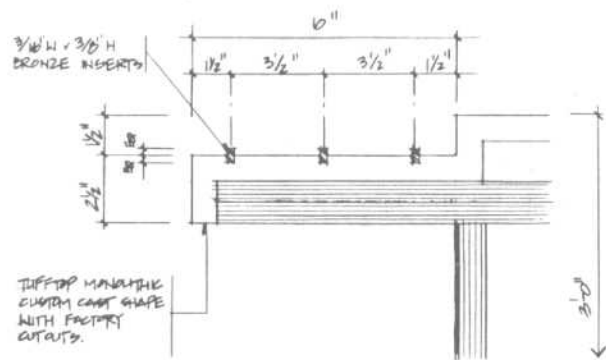
DETAIL SECTION AT  
CONDIMENT COUNTER



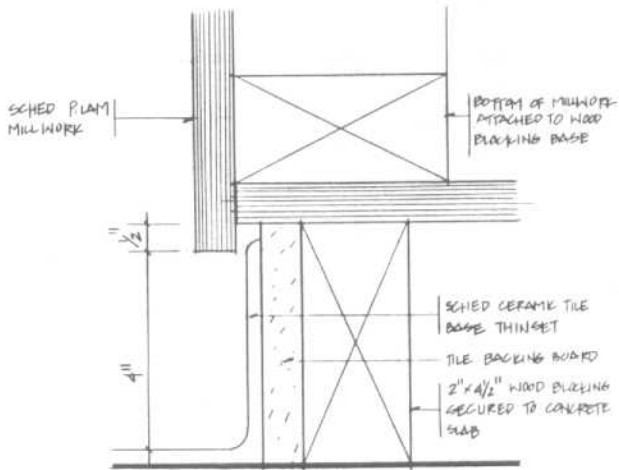




HOT FOOD STAND



COLD BEVERAGE & DESSERT STAND



HALF SCALE

TYPICAL BASE DETAIL @ SERVICE MILLWORK | 10

TRAY SIDE

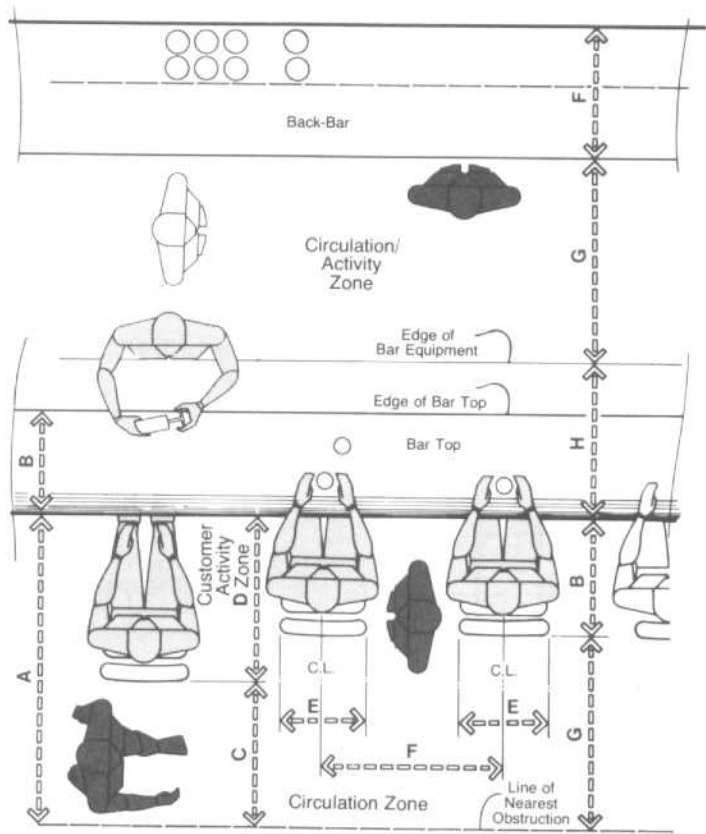
**BARS**

Bar Section Details

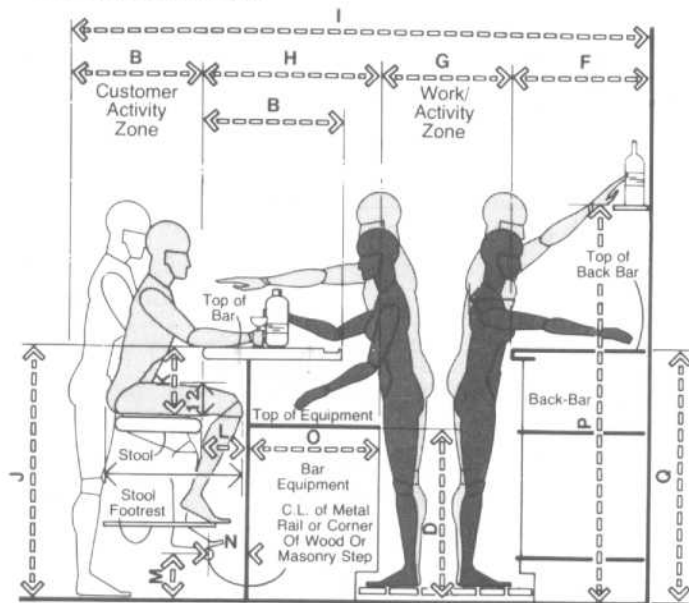
The distance between bar and backbar should allow adequate workspace. A minimum of 36 in, or 90 cm, should provide space for one bartender to serve and another to circulate behind. Maximum body depth and maximum body breadth are the primary anthropometric considerations in establishing clearance. A one-bartender operation would require a 30-in, or 75-cm, clearance.

In regard to bar stools, clearance between the stool seats is more critical than center line spacing, and it should allow patrons of larger body size a comfortable side approach and departure from the stool without body contact with the next person. A 12-in, or 30-cm wide stool on 24-in, or 61-cm, centers, which is quite common, will allow only less than 5 percent of male users access to the stool without disturbing the next patron, while a 30-in, or 75-cm, spacing will accommodate 95 percent of the users. The tradeoff however, would be the loss of two seats for every 120 in, or 300 cm, of bar length. A spacing of 12-in stools on 28-in, or 70-cm, centers is suggested as a compromise. The ultimate decision is an individual one and must reconcile human factors with economic viability.

	in	cm
A	54	137.2
B	18-24	45.7-61.0
C	24	61.0
D	30	76.2
E	16-18	40.6-45.7
F	24-30	61.0-76.2
G	30-36	76.2-91.4
H	28-38	71.1-96.5
I	100-128	254.0-325.1
J	42-45	106.7-114.3
K	11-12	27.9-30.5
L	6-7	15.2-17.8
M	7-9	17.8-22.9
N	6-9	15.2-22.9
O	22-26	55.9-66.0
P	60-69	152.4-175.3
Q	36-42	91.4-106.7



**BAR AND BACK-BAR**



**BAR / SECTION**

Fig. 1

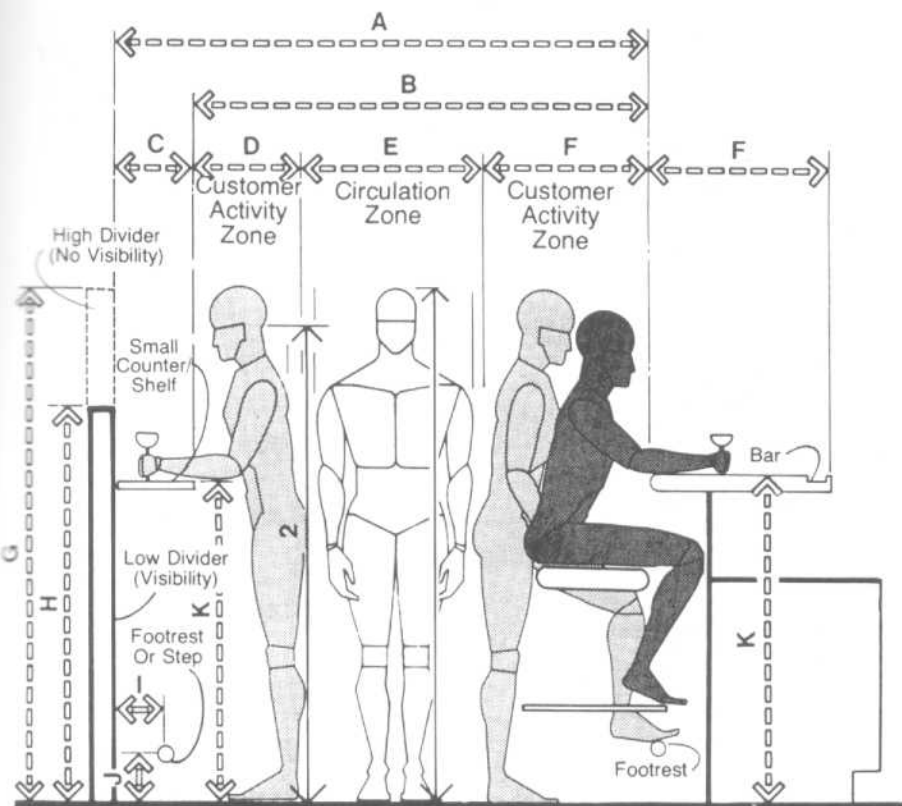


Fig. 2 Bar/clearances public side.

To ensure proper circulation and interface, adequate clearances in front of the bar are illustrated in Fig. 2. A customer activity zone of 18 to 24 in, or 45.7 to 61.0 cm, should be provided to allow for seating, standing, and access, in addition to a general circulation zone of at least 30 in, or 76.2 cm. If a supplementary drinking surface or shelf is provided, a smaller activity zone of 18 in is suggested in front of the shelf. The shelf can be 10 to 12 in, or 25.4 to 30.5 cm, deep. Figure 3 shows suggested clearances for 18 or 24 in cocktail tables.

	in	cm
A	76-84	193.0-213.4
B	66-72	167.6-182.9
C	10-12	25.4-30.5
D	18	45.7
E	30	76.2
F	18-24	45.7-61.0
G	76	193.0
H	54-56	137.2-142.2
I	6-9	15.2-22.9
J	7-9	17.8-22.9
K	42-45	106.7-114.3
L	24	61.0
M	29-33	73.7-83.8
N	32-36	81.3-91.4

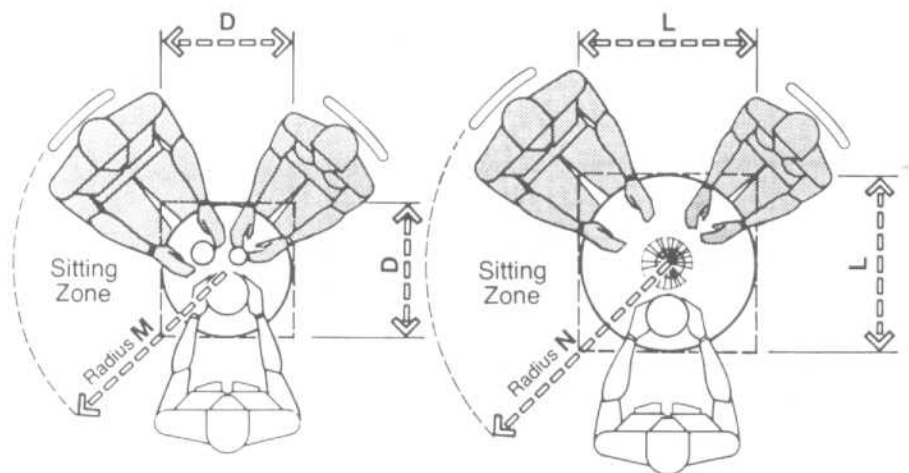


Fig. 3 Cocktail tables/seating for two.

BARS

Bar Shapes: Planning Criteria

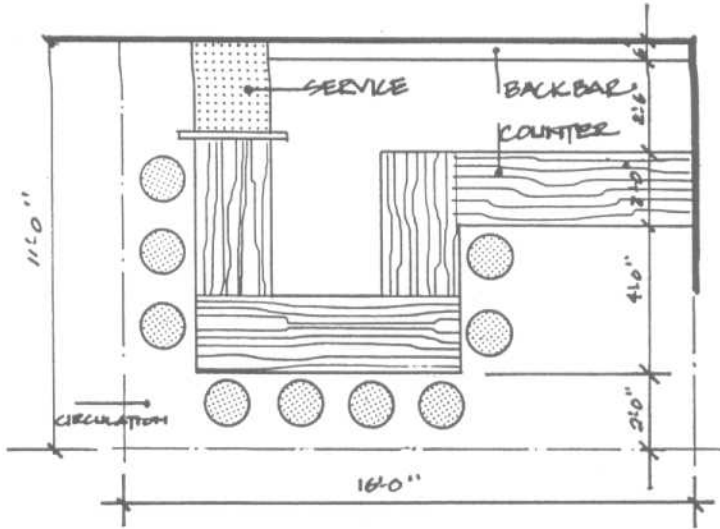


Fig. 4 U shape: 16 ft × 11 ft, 176 ft<sup>2</sup>, seats 9.

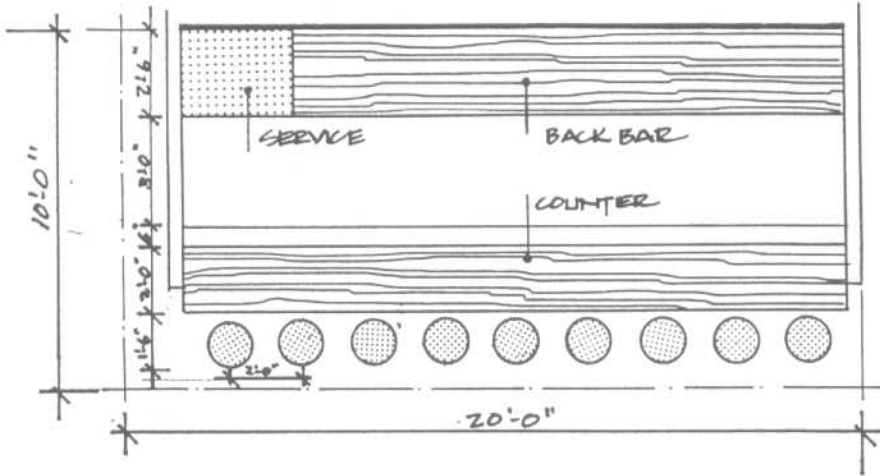


Fig. 5 Straight/enclosed: 20 ft × 10 ft, 200 ft<sup>2</sup>, seats 9.

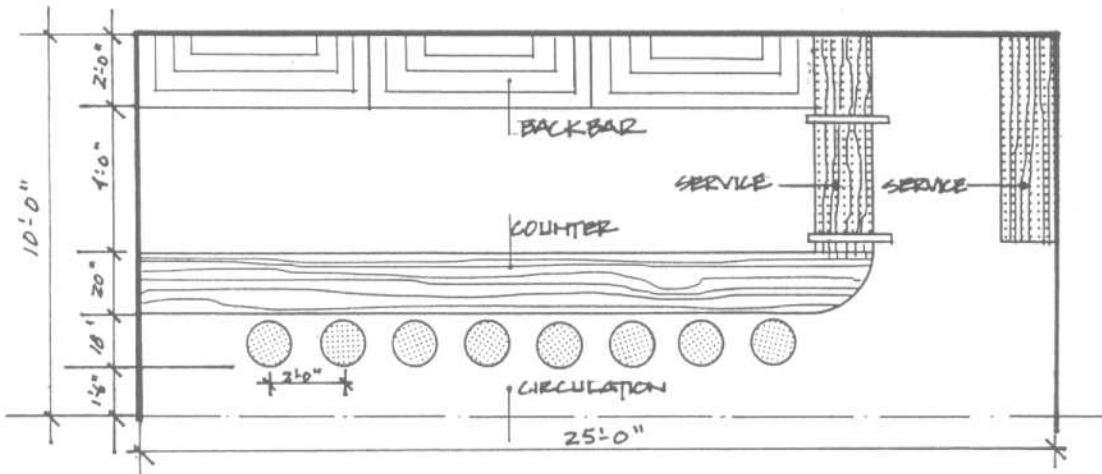


Fig. 6 Straight bar: 25 ft × 10 ft, 250 ft<sup>2</sup>, seats 8.

Bar shapes, seating capacities, overall dimensions, and "footprints" of bar areas vary greatly. Figures 4 to 22 show examples of bar designs drawn at a scale of  $\frac{1}{4}'' = 1'-0''$ . Careful study of these designs would suggest that seating width, spacing, and circulation areas must be given special attention.



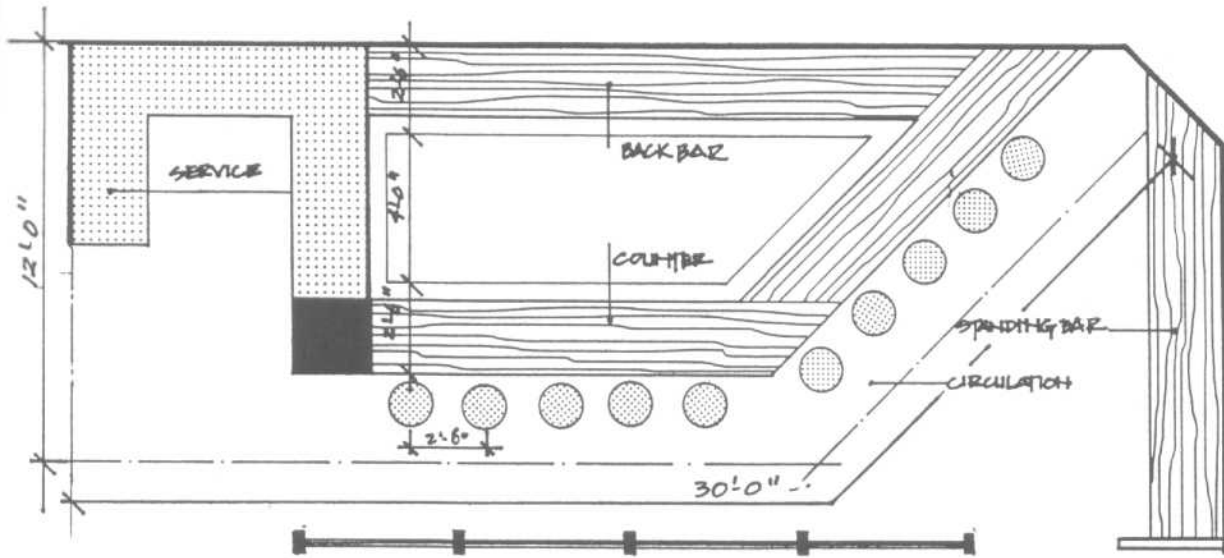


Fig. 7 Angular: 30 ft × 12 ft, 320 ft<sup>2</sup>, seats 10.

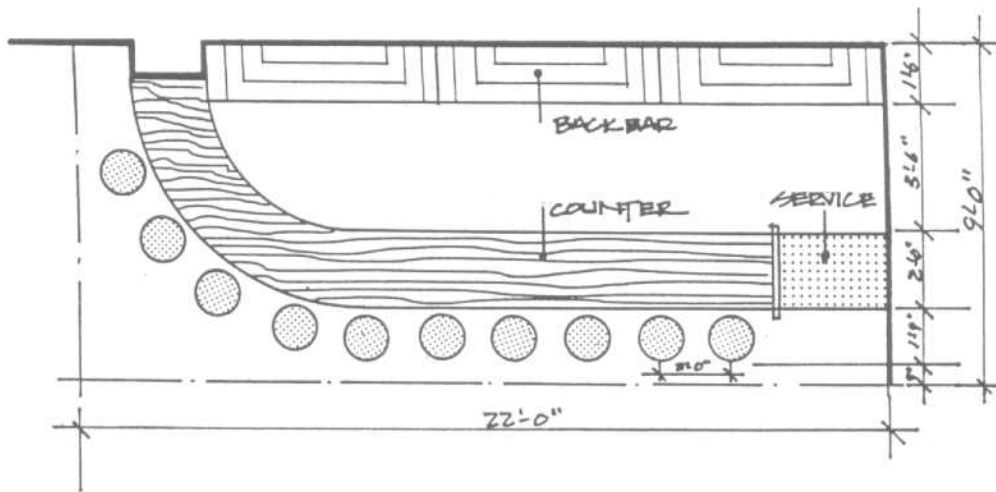


Fig. 8 Enclosed/rounded end: 22 ft × 9 ft, 198 ft<sup>2</sup>, seats 10.

BARS

Bar Shapes: Planning Criteria

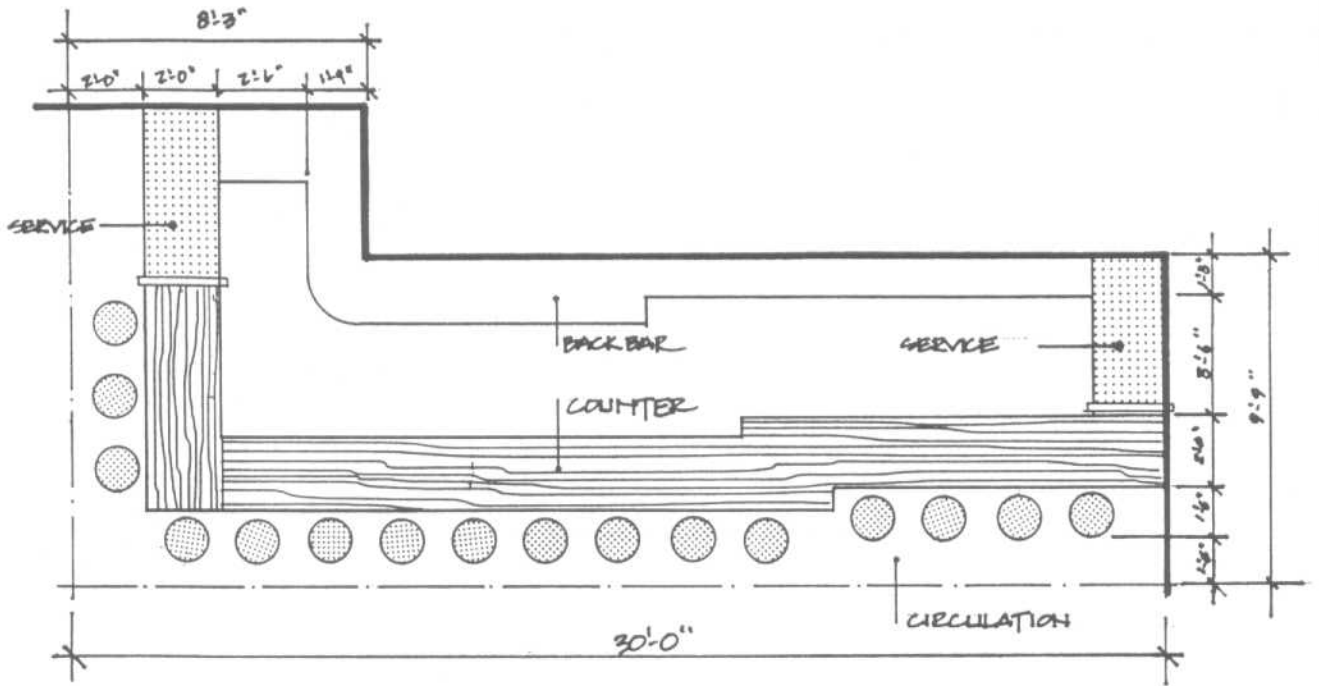


Fig. 9 L shape: 30 ft × 13 ft, 390 ft<sup>2</sup>, seats 15.

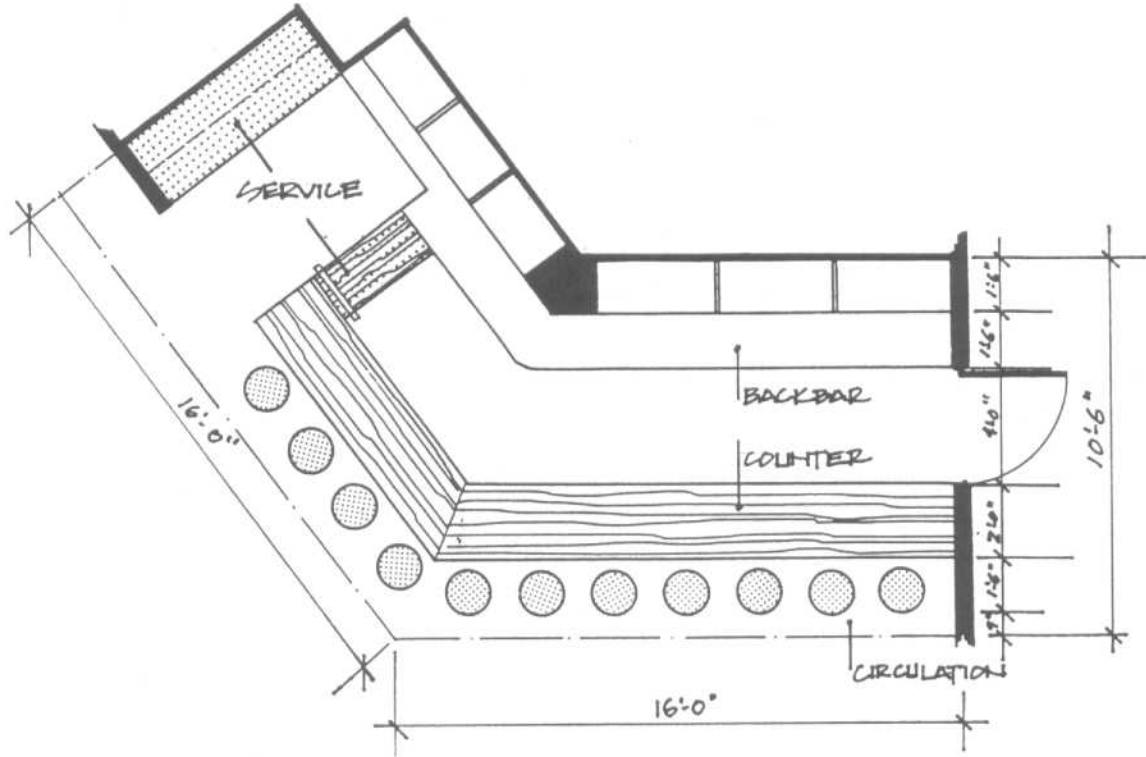


Fig. 10 Angular: 16 ft × 16 ft, 256 ft<sup>2</sup>, seats 11.

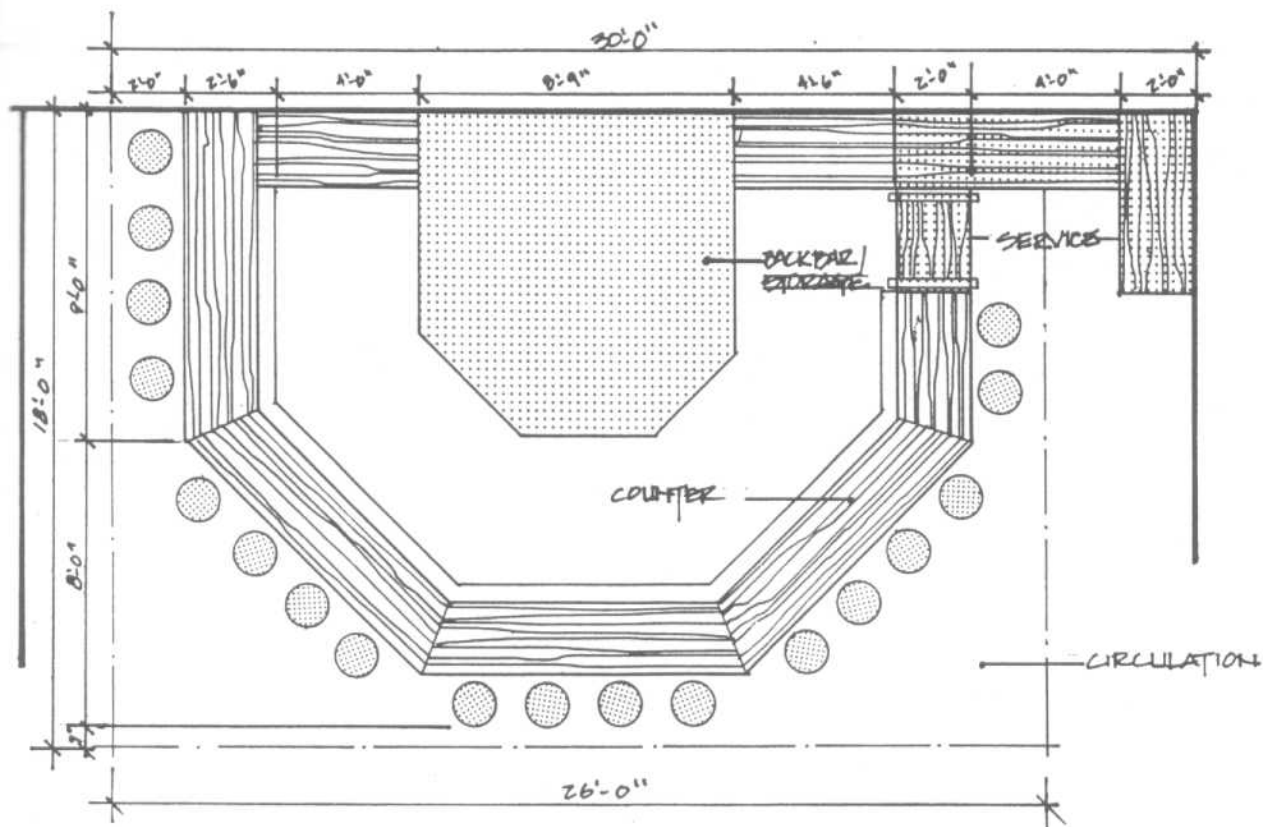


Fig. 11 Octagon/partial: 26 ft × 18 ft, 468 ft<sup>2</sup>, seats 16.

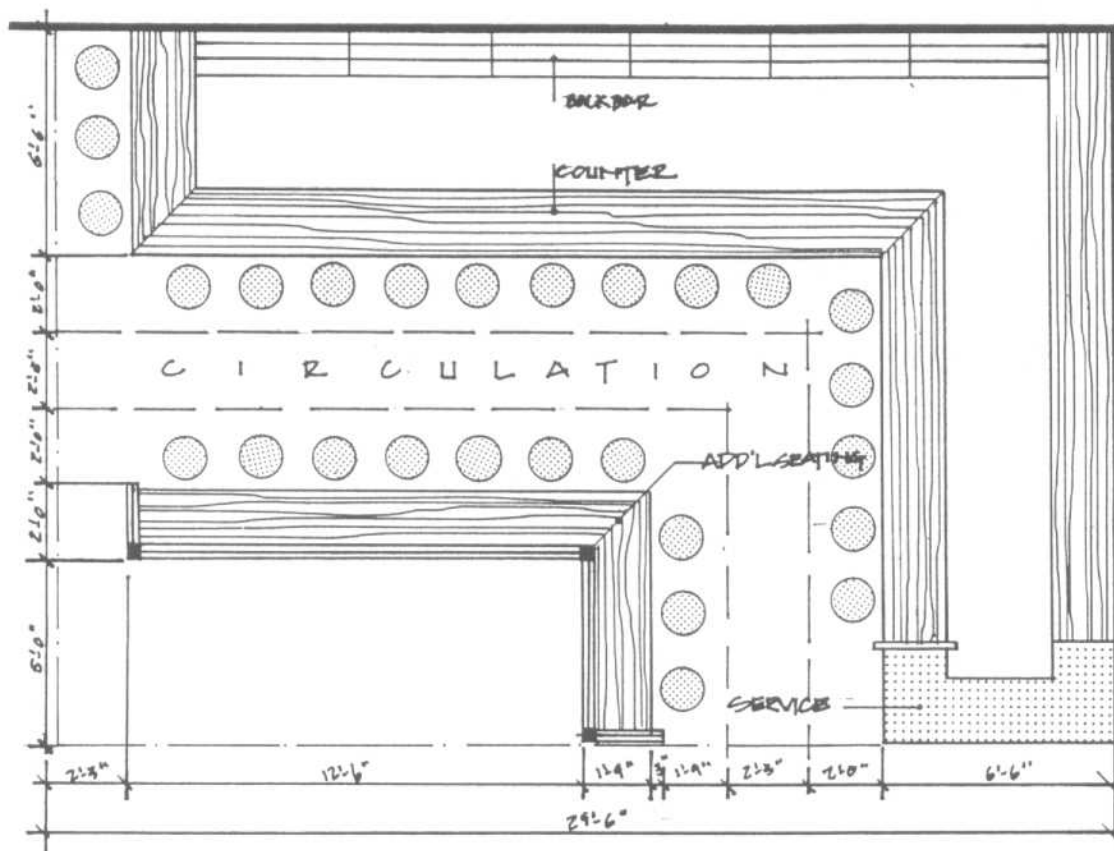


Fig. 12 L shape: 27 ft × 20 ft, 510 ft<sup>2</sup>. Bar seating, 17; additional seating, 10.

BARS

Bar Shapes: Planning Criteria

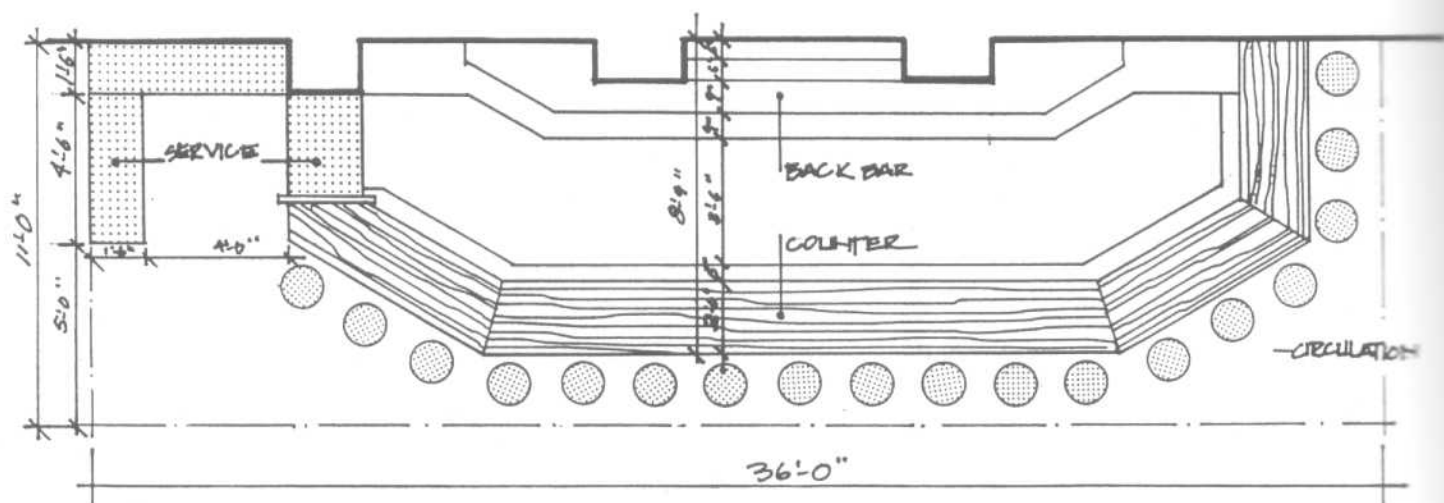


Fig. 13 Polygon: 36 ft × 11 ft, 396 ft<sup>2</sup>, seats 18.

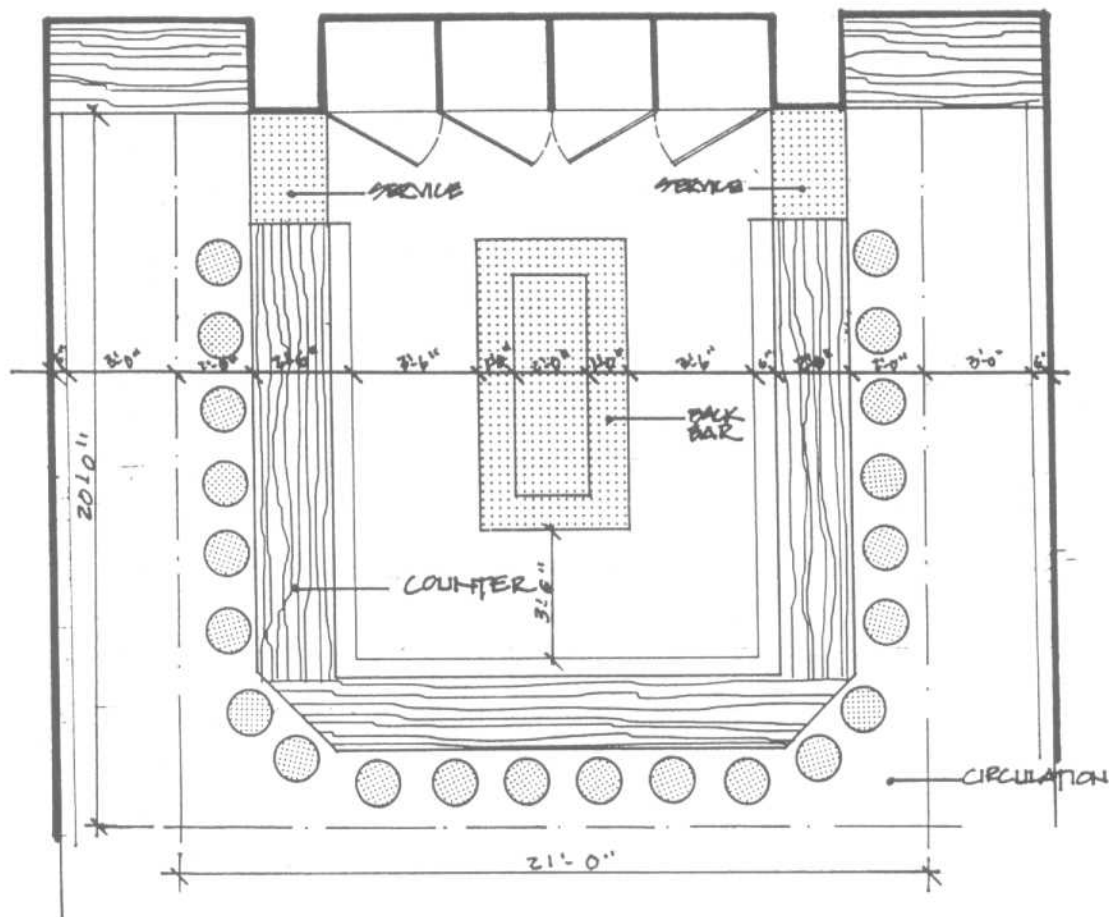


Fig. 14 U shape: 21 ft × 20 ft, 420 ft<sup>2</sup>, seats 22.

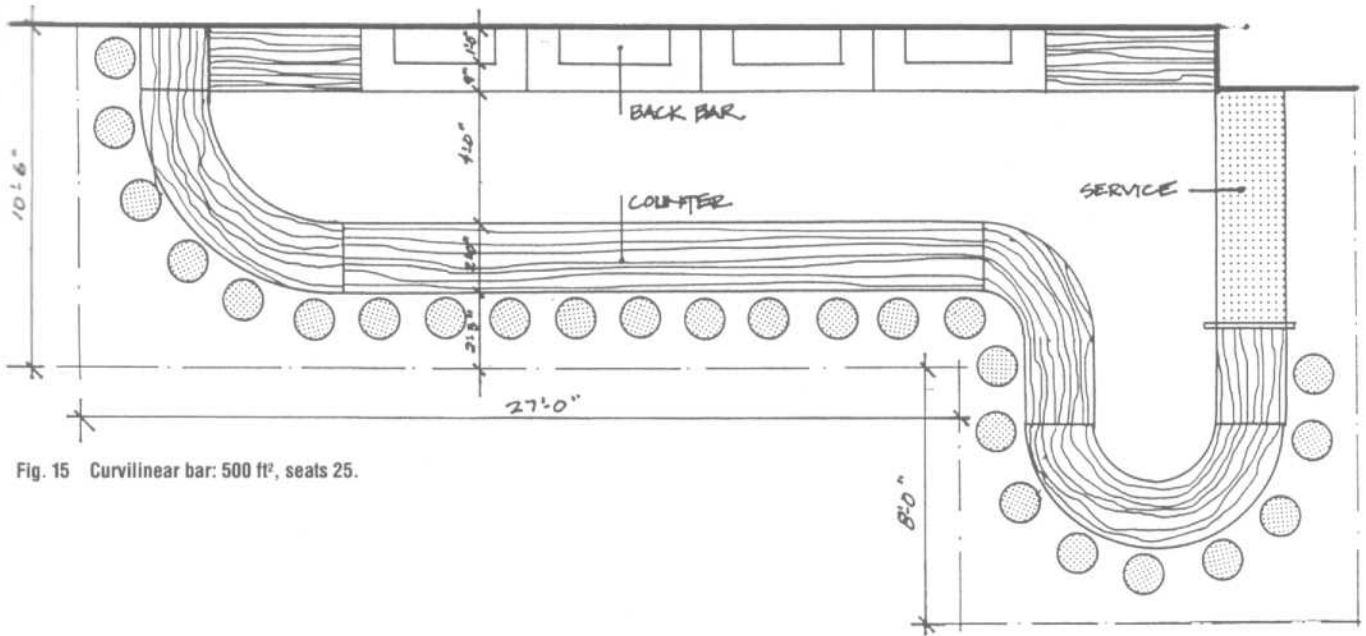


Fig. 15 Curvilinear bar: 500 ft<sup>2</sup>, seats 25.

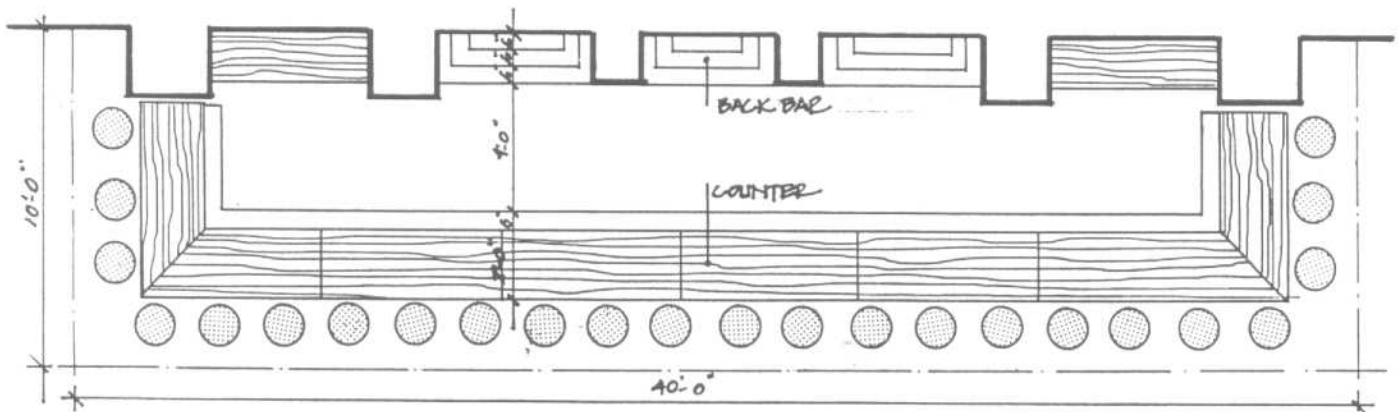


Fig. 16 Straight bar: 40 ft × 10 ft, 400 ft<sup>2</sup>, seats 24.

BARS

Bar Shapes: Planning Criteria

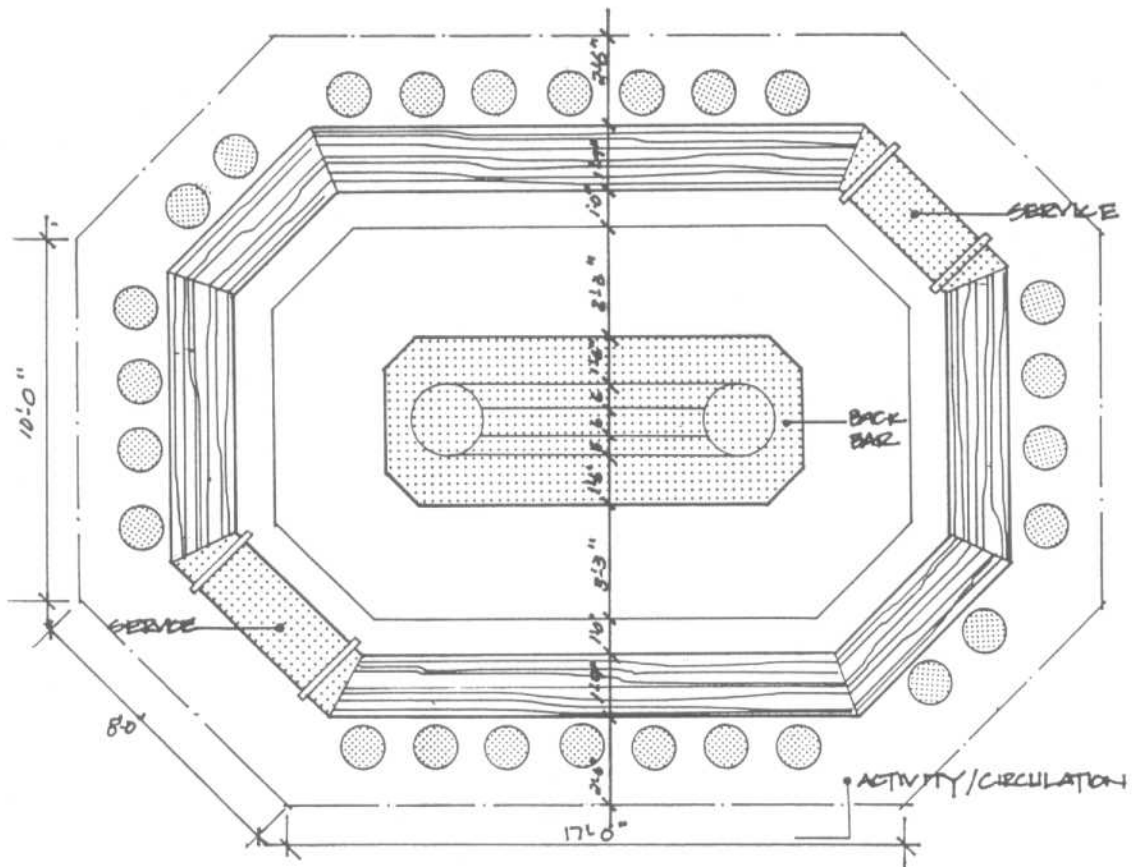


Fig. 17 Octagon/freestanding: 28 ft × 21 ft, 558 ft<sup>2</sup>.

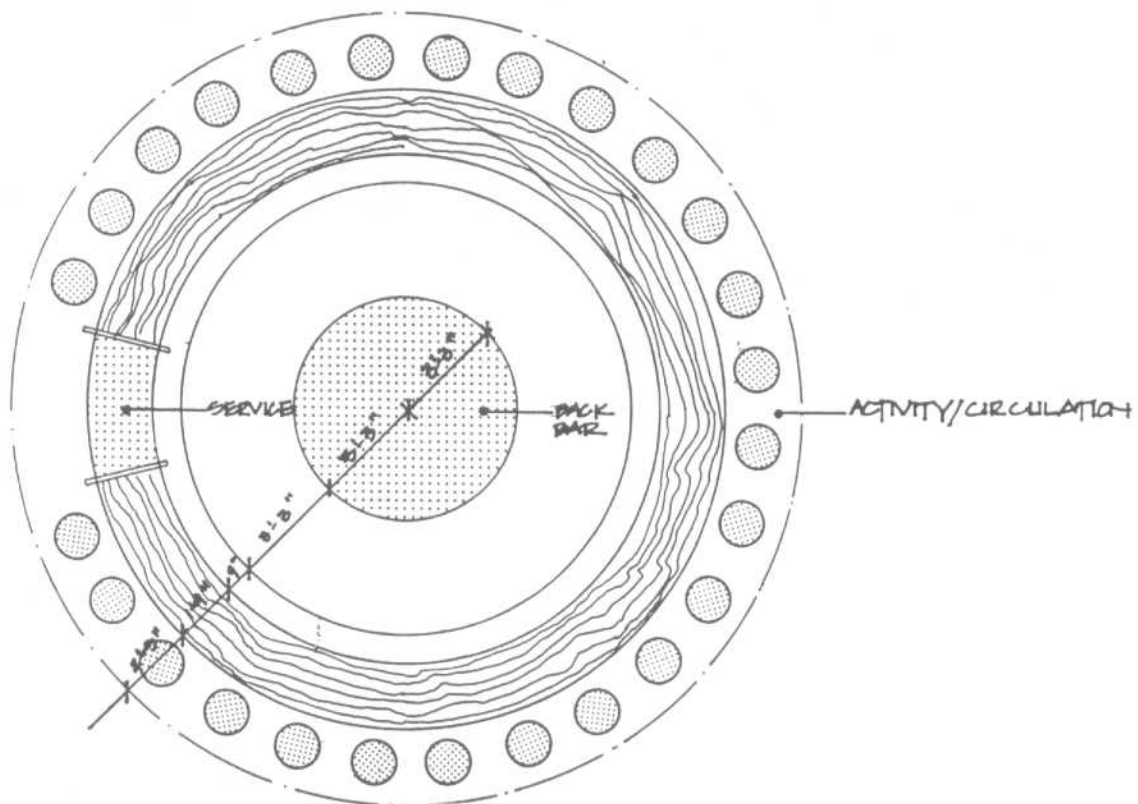


Fig. 18 Circular/freestanding: 22 ft × 22 ft, 334 ft<sup>2</sup>, seats 26.

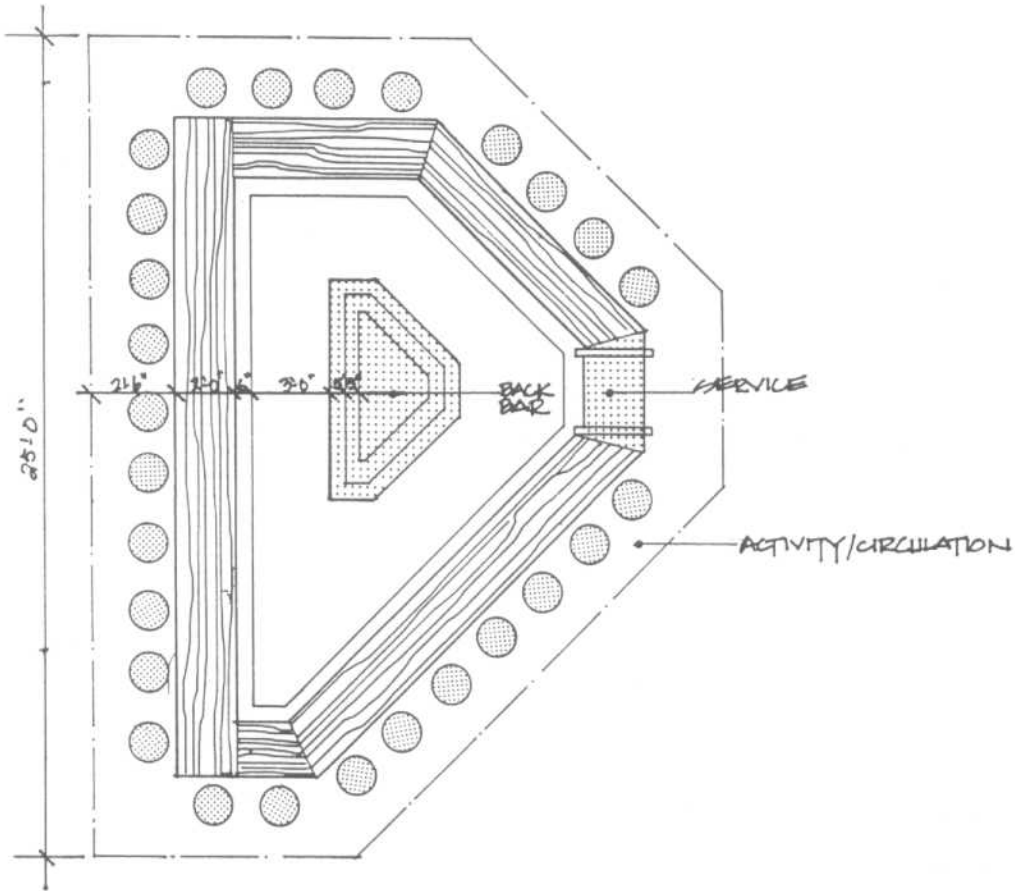


Fig. 19 Polygon irregular: 20 ft × 25 ft, 360 ft<sup>2</sup>, seats 27.

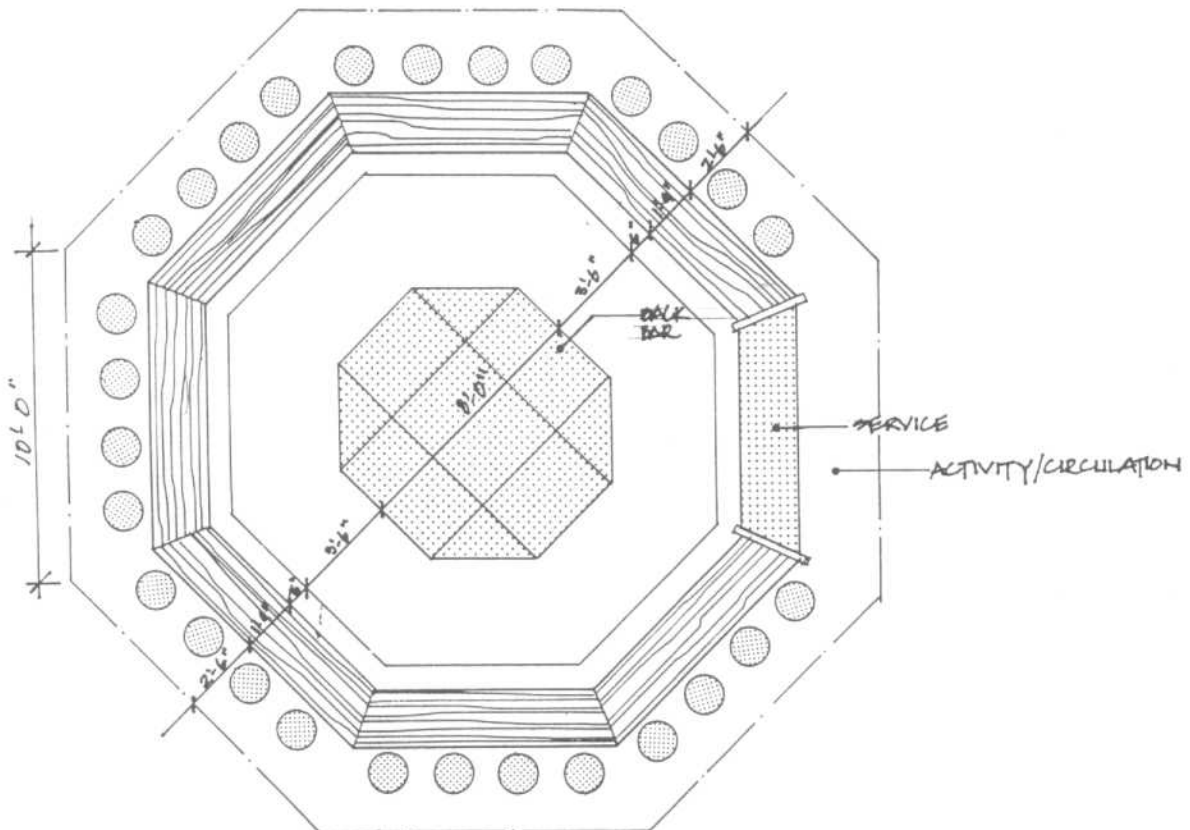


Fig. 20 Octagon: 25 ft × 25 ft, 429 ft<sup>2</sup>, seats 28.

BARS

Bar Shapes: Planning Criteria

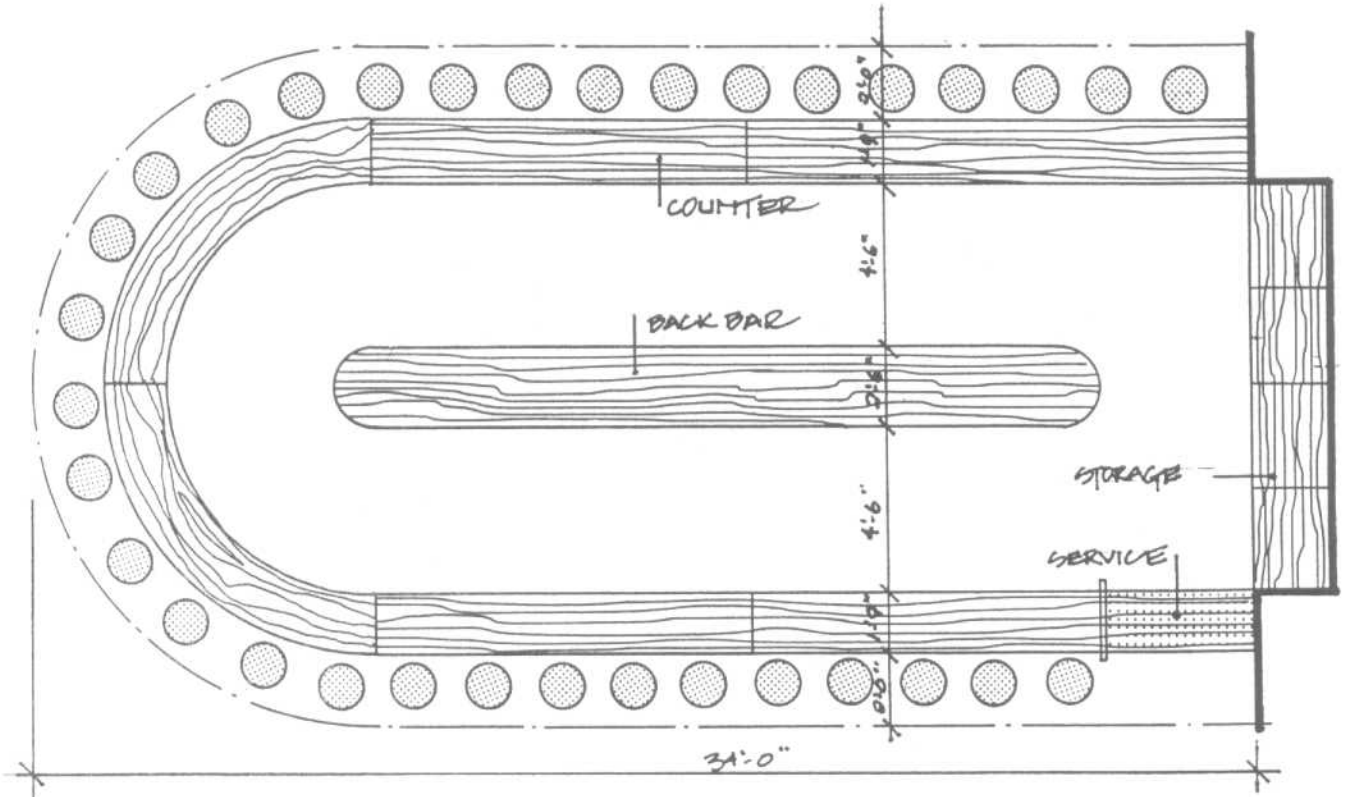


Fig. 21 Horseshoe/oval end: 34 ft × 19 ft, 546 ft<sup>2</sup>, seats 34.

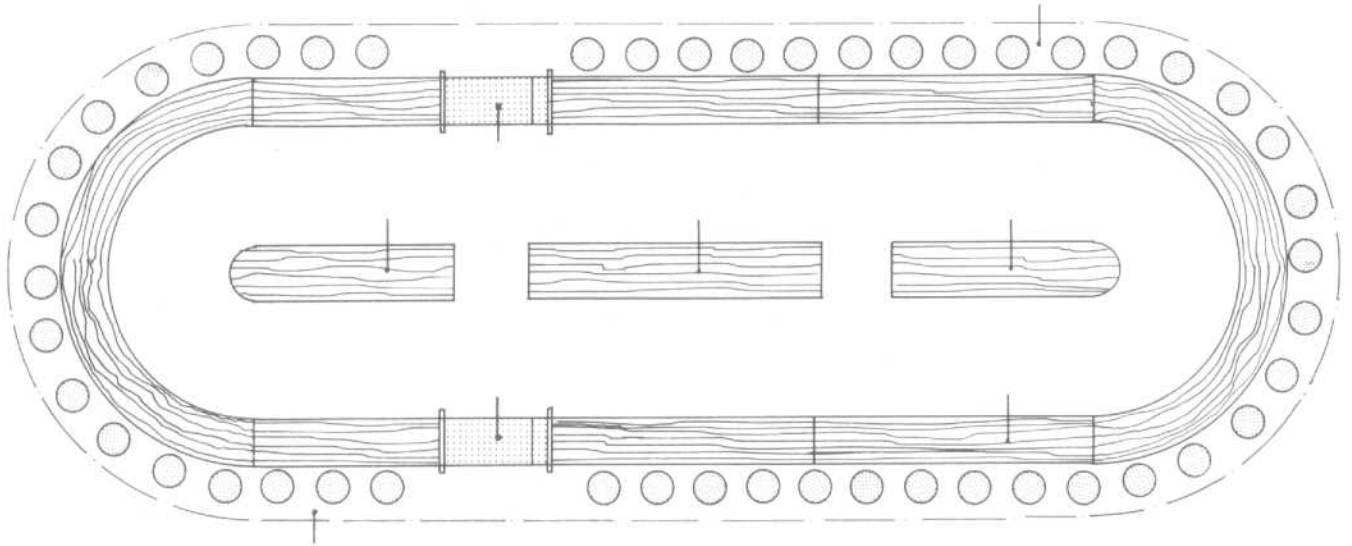
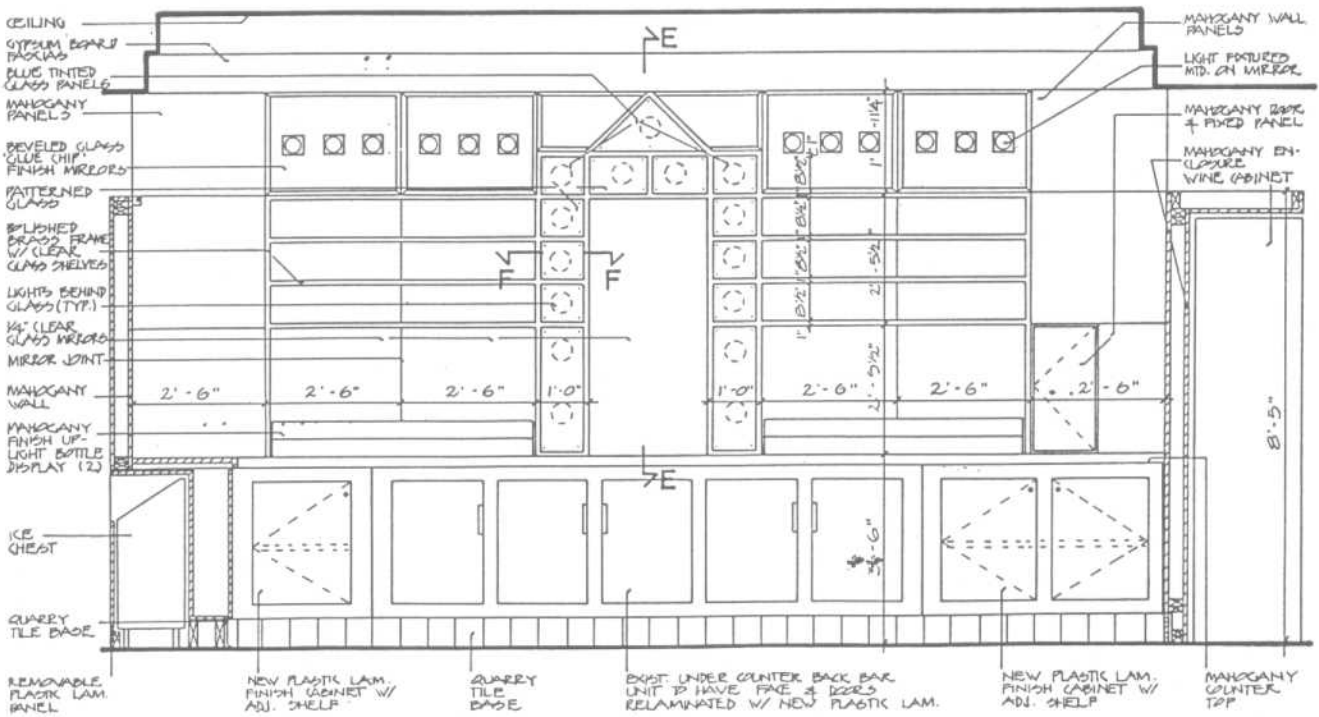


Fig. 22 Racetrack: 50 ft × 19 ft, 750 ft<sup>2</sup>, seats 48.



The detailing of bars and backbars can vary from the very simple and basic to the complicated and intricate. Figures 23 to 40 provide the designer with selected examples of working drawings from some of the most experienced restaurant and hospitality design firms in the world. Careful review of these drawings would suggest that overall dimensions and clearances vary from detail to detail. In that regard, individual requirements based upon bar type and the hospitality area serviced must be given careful consideration. In addition, local building codes and health codes must be consulted.



**B** ELEVATION

Fig. 23



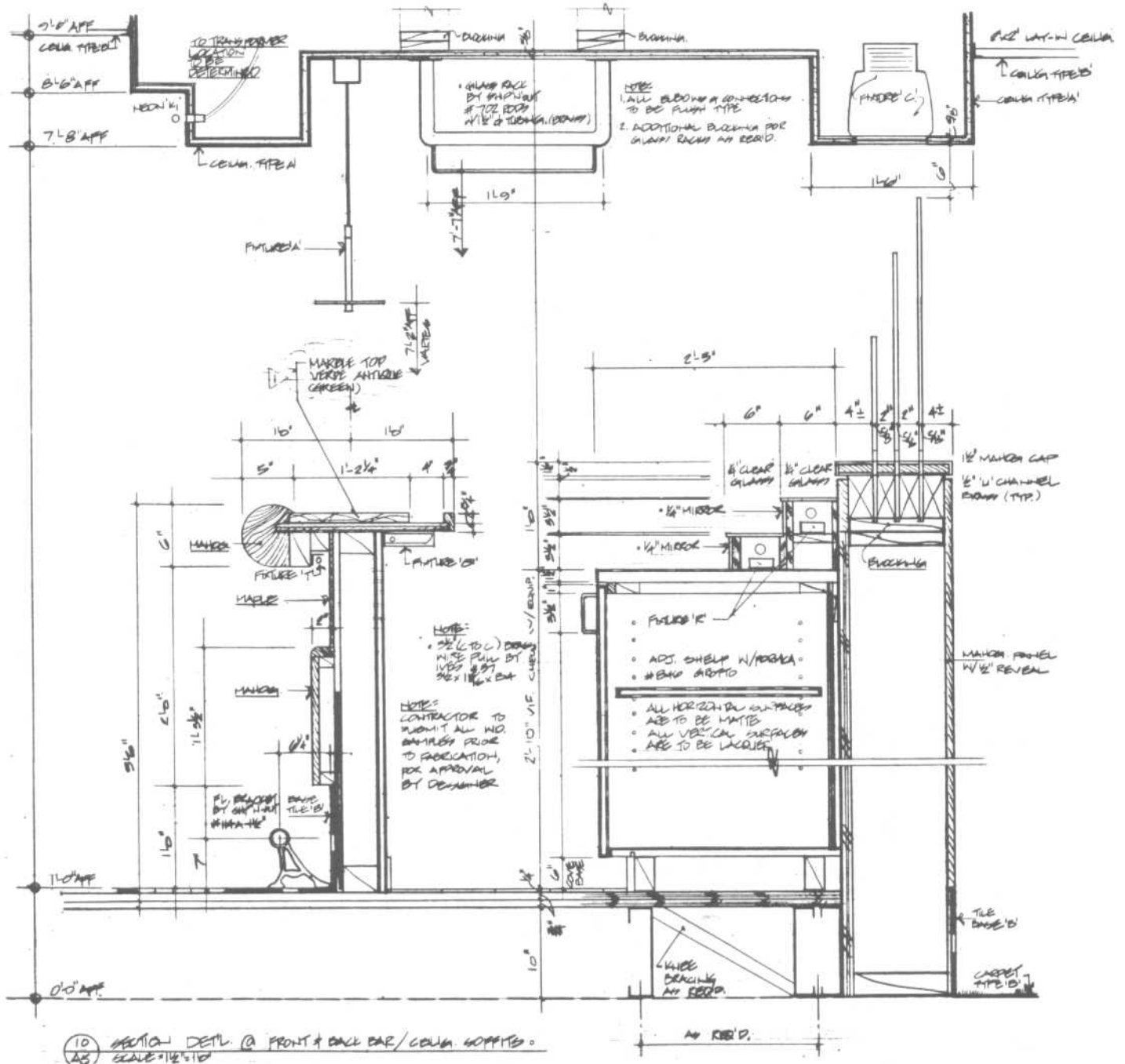
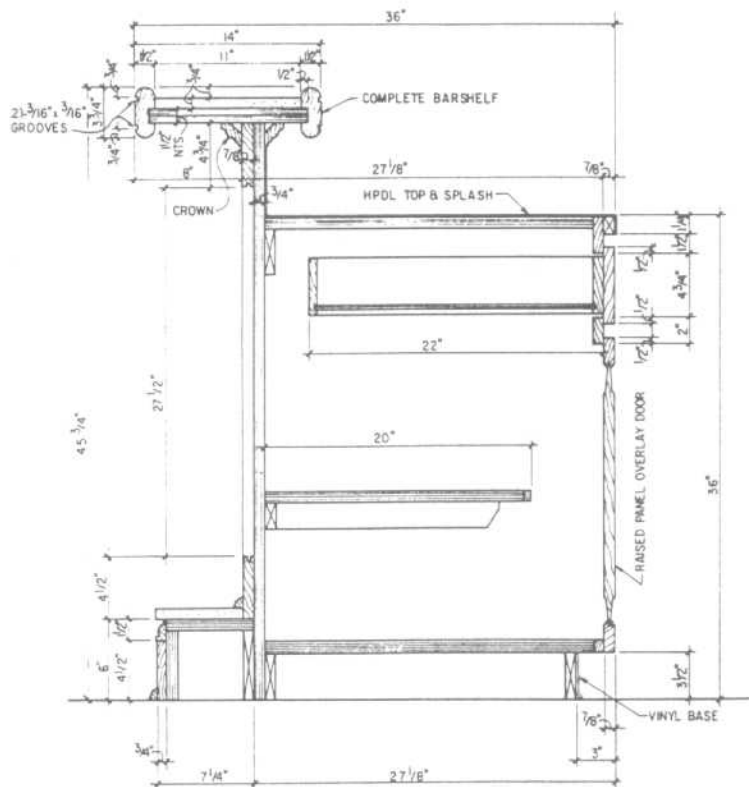
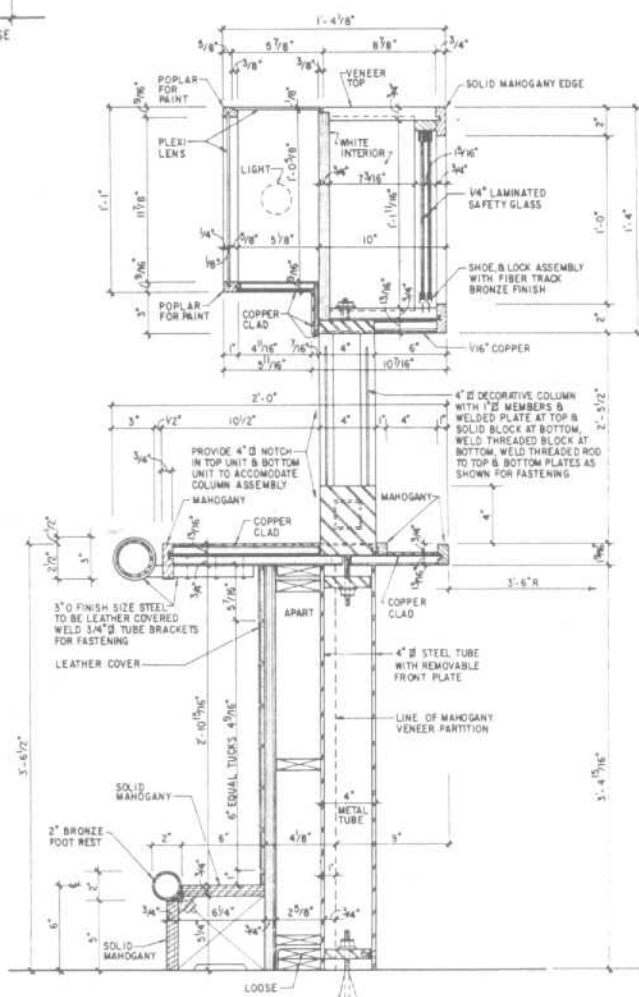


Fig. 24





SECTION THRU BAR CABINET

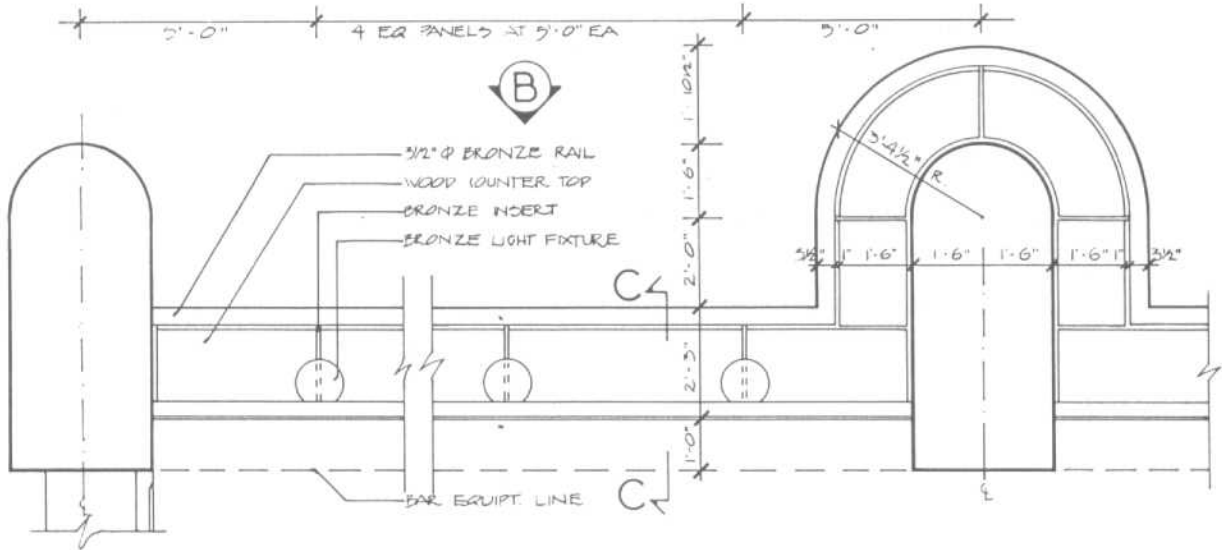


VERTICAL SECTION AT METAL POST AND LIGHT BOX

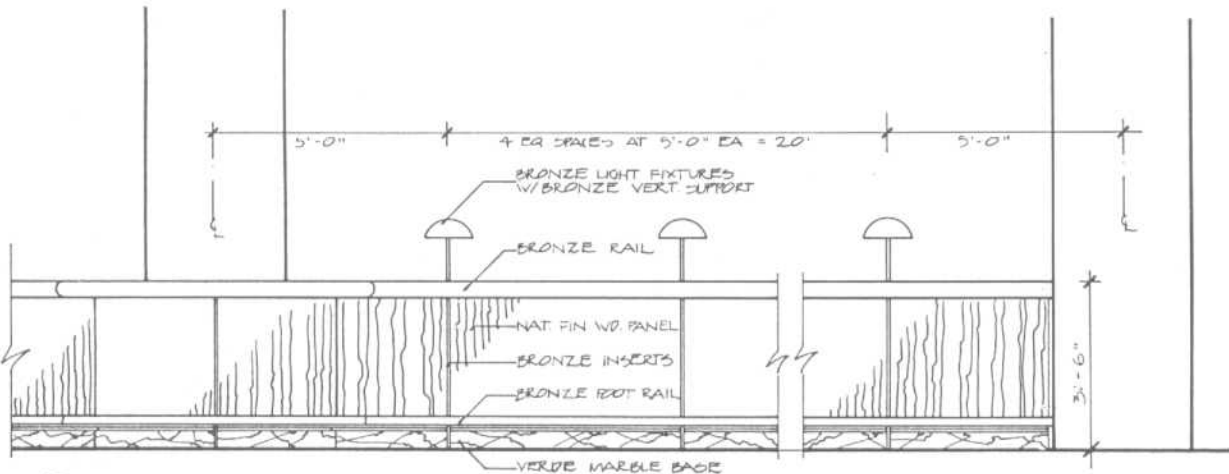
Fig. 26

**BARS**

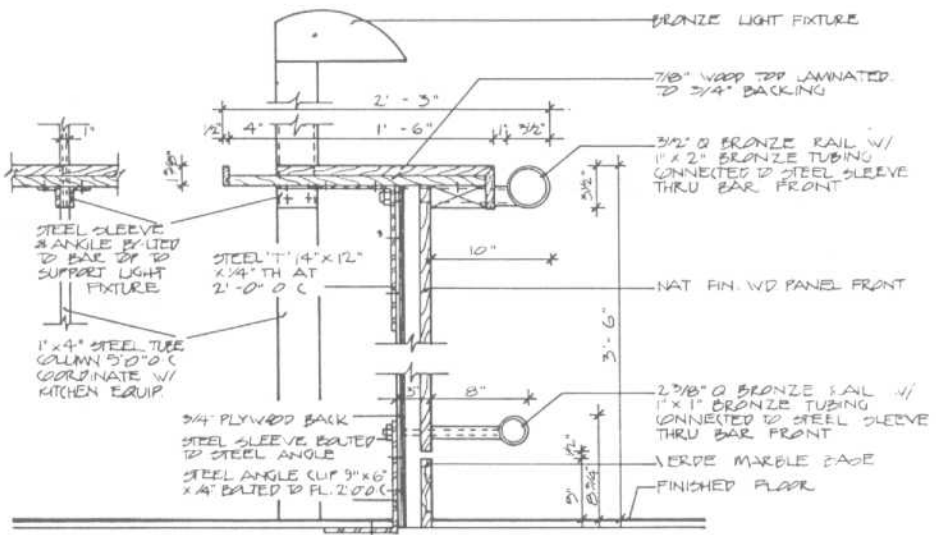
Bar Plans, Elevations, and Sections



**A** PLAN



**B** ELEVATION



**CC** ELEVATION

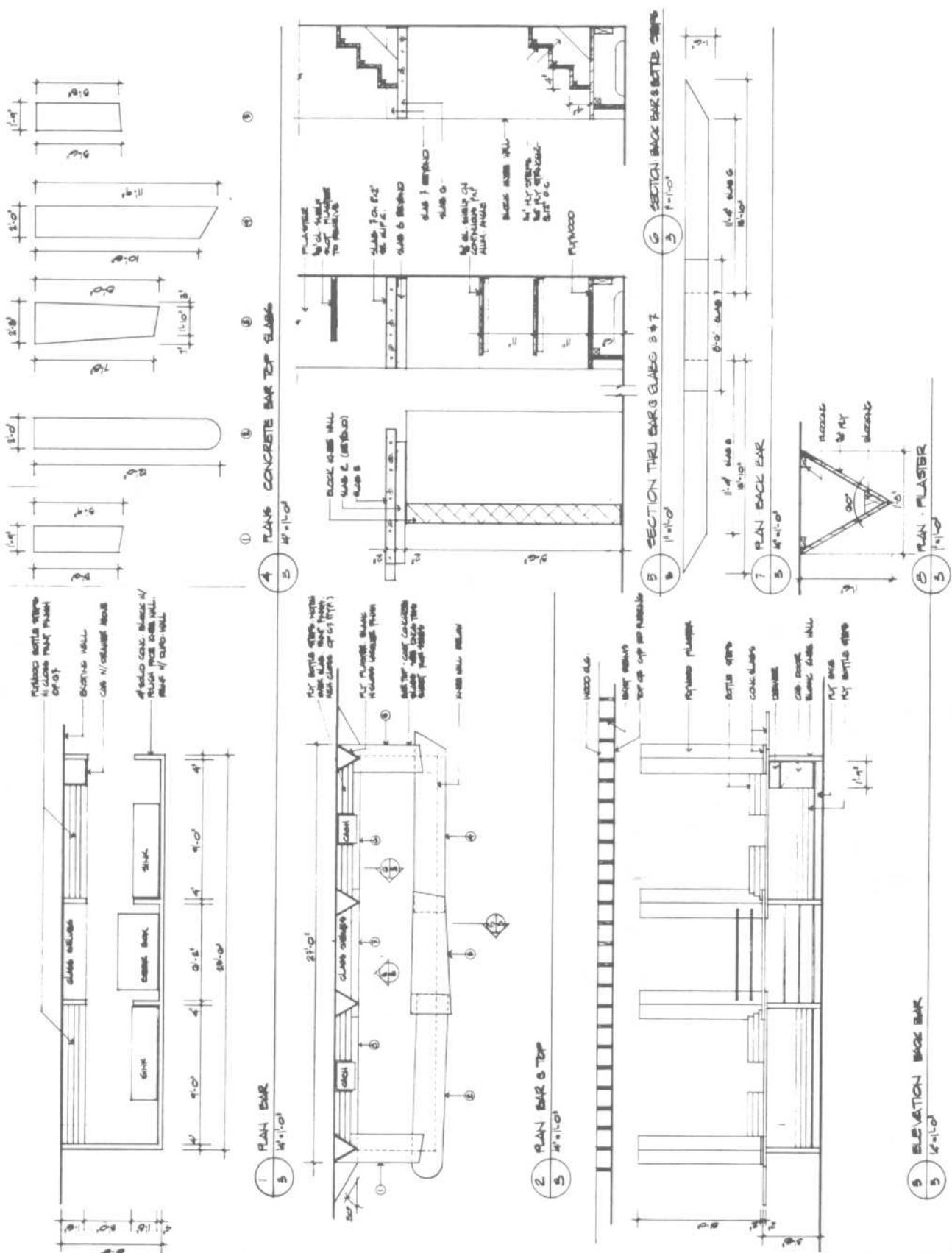
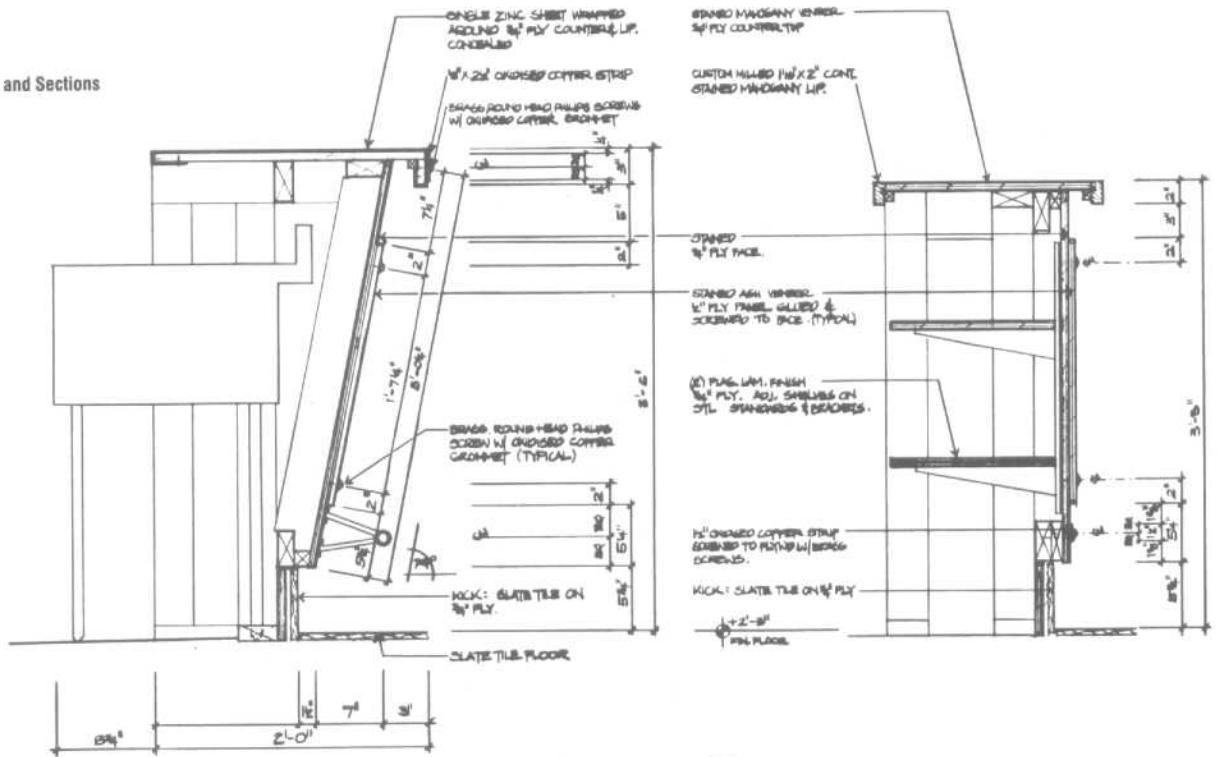


Fig. 28

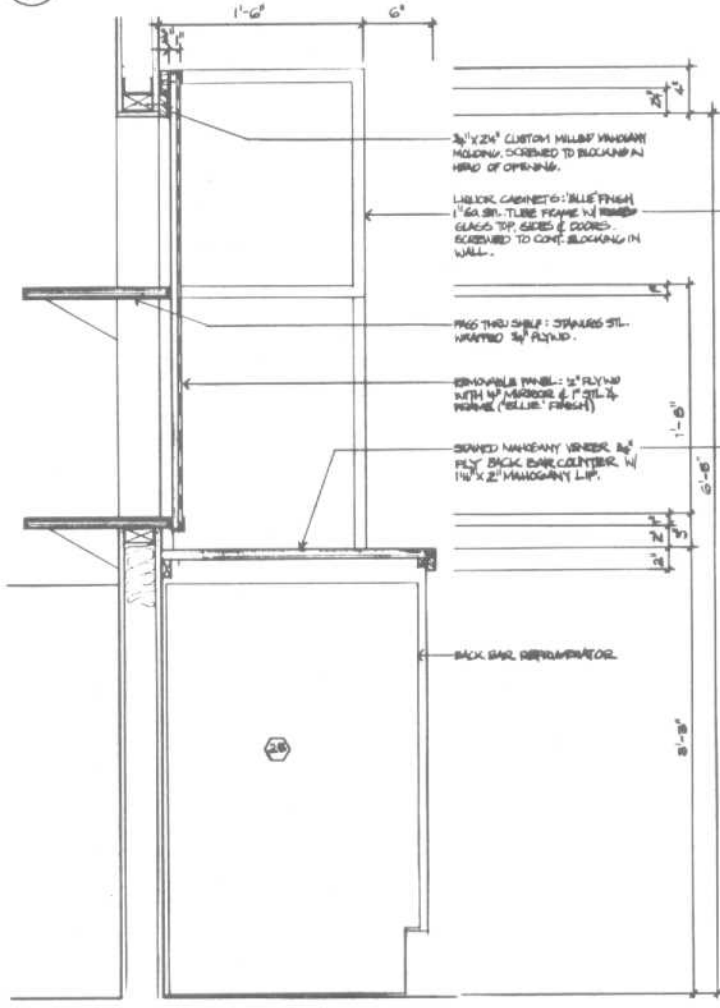
**BARS**

Bar Plans, Elevations, and Sections

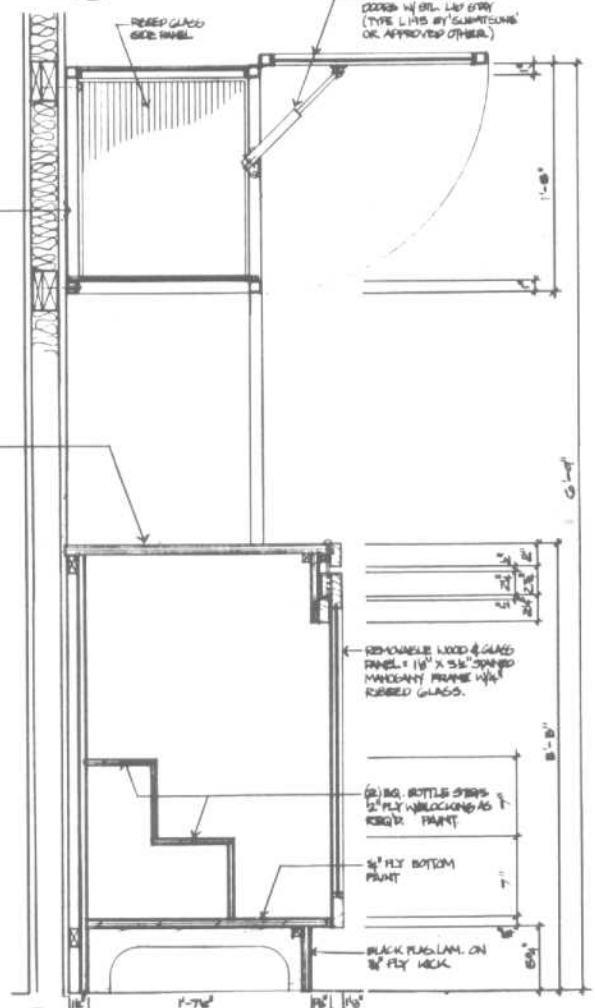


1 SECTION @ FRONT BAR  
A15 1 1/2" = 1'-0"

3 DETAIL OF BAR THRU NORTH SIDE  
A15 1 1/2" = 1'-0"



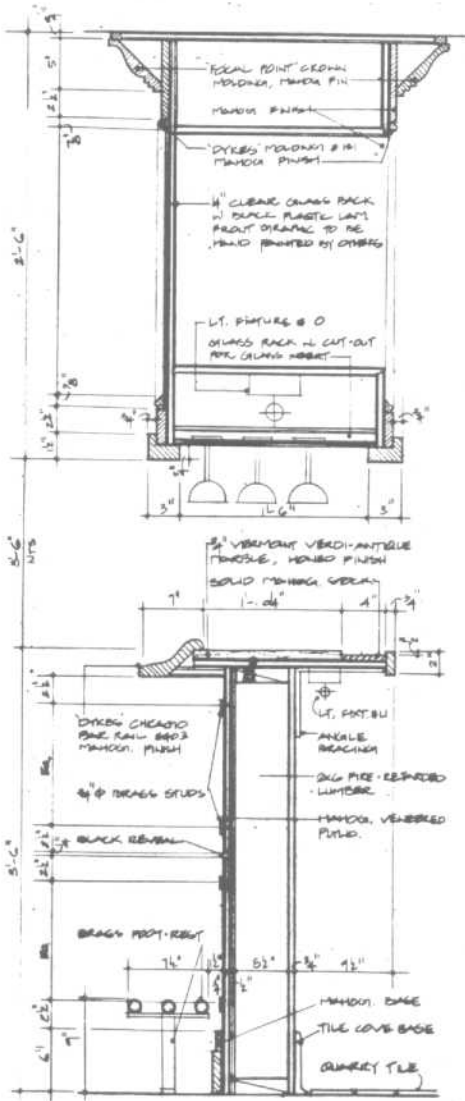
2 SECTION THRU BACK BAR @ PASS THRU  
A15 1 1/2" = 1'-0"



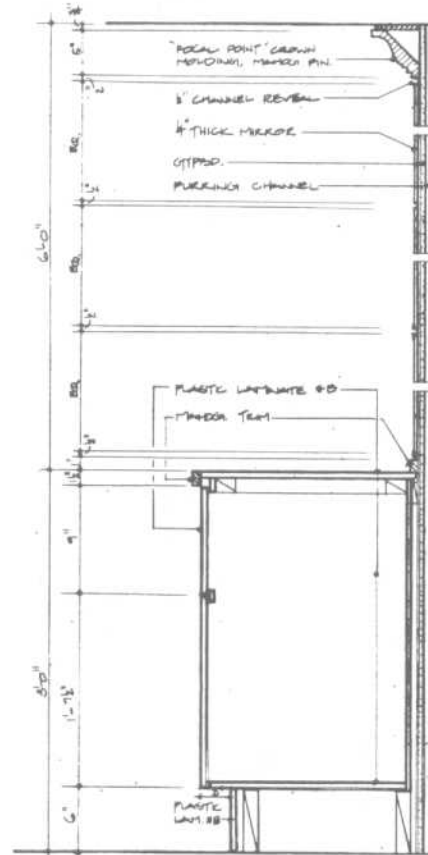
4 SECTION THRU BACK BAR @ BOTTLE STEPS  
A15 1 1/2" = 1'-0"

Fig. 29





9 DETAILS OF BAR COUNTER & GLASS RACK  
SCALE: 1/8" = 1'-0"



10 SECTION OF SERVING COUNTER # 104  
SCALE: 1/8" = 1'-0"

Fig. 30

BARS

Bar Plans, Elevations, and Sections

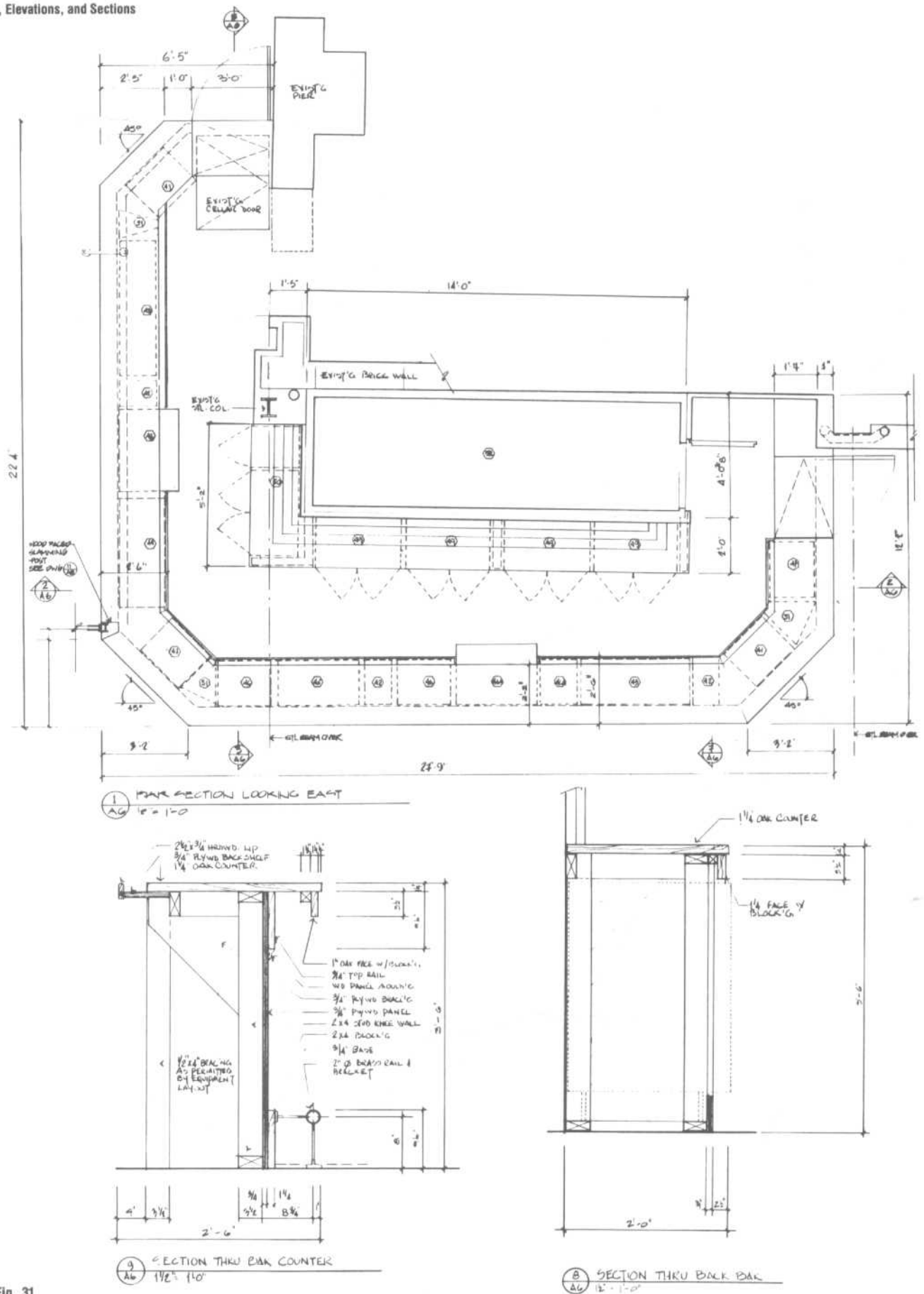
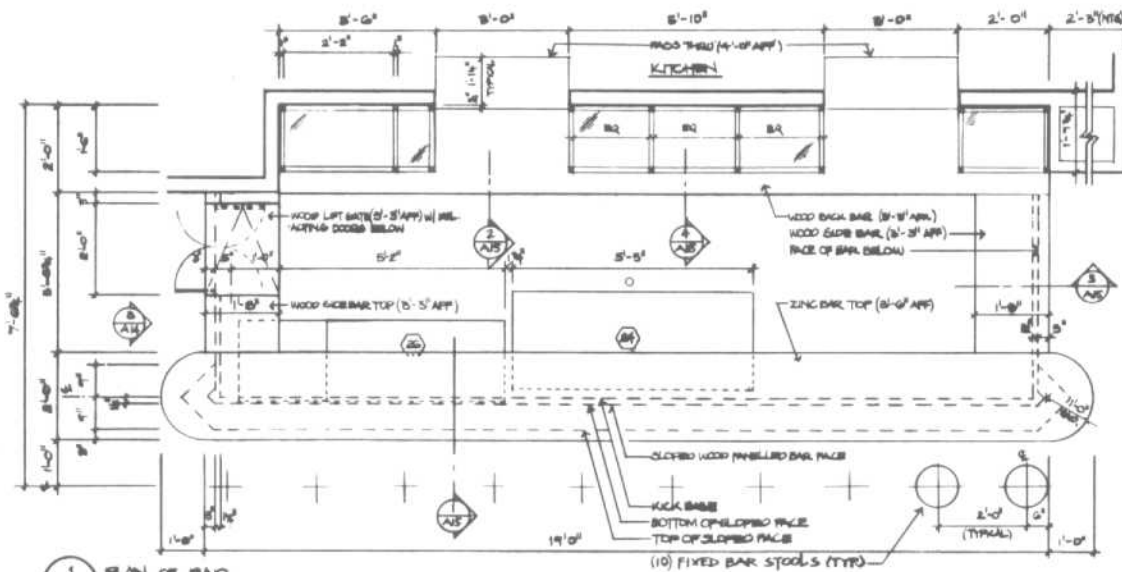
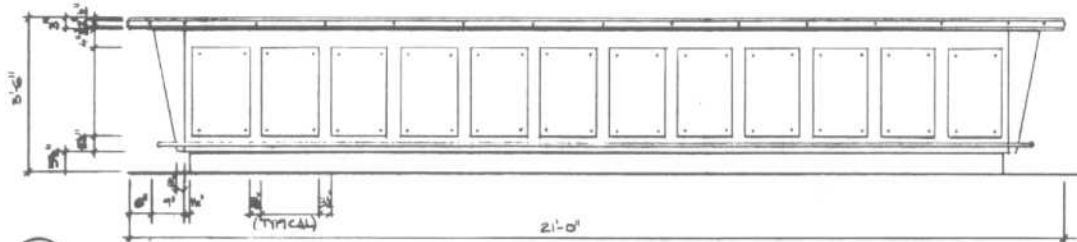


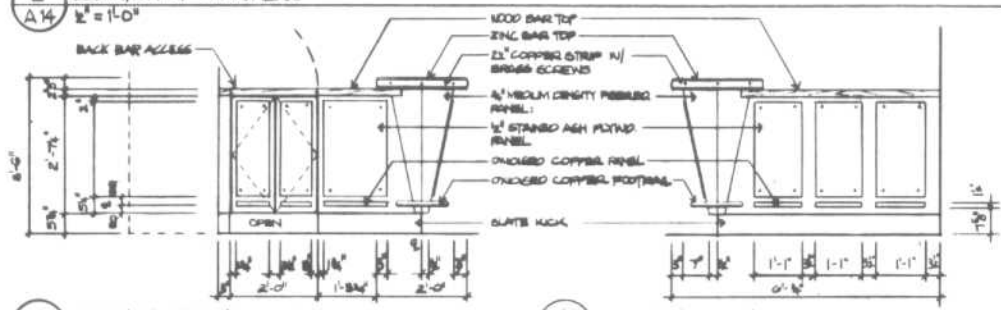
Fig. 31



1 PLAN OF BAR  
A14 1/2" = 1'-0"

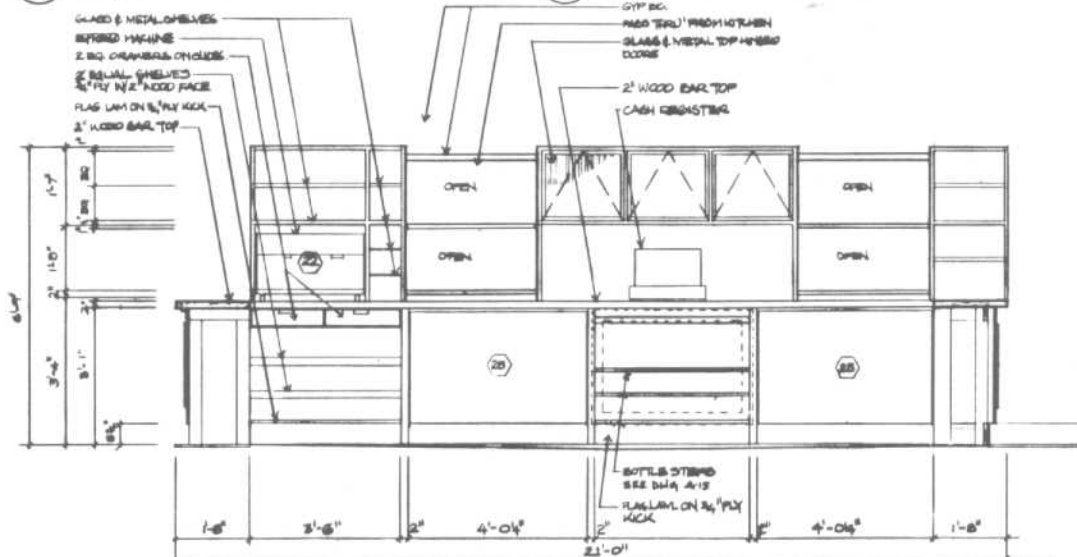


2 ELEVATION OF FRONT BAR  
A14 1/2" = 1'-0"



3 SOUTH ELEVATION OF BAR  
A14 1/2" = 1'-0"

4 NORTH ELEVATION OF BAR  
A14 1/2" = 1'-0"



5 ELEVATION OF BACK BAR  
A14 1/2" = 1'-0"

**BARS**

Bar Section Details

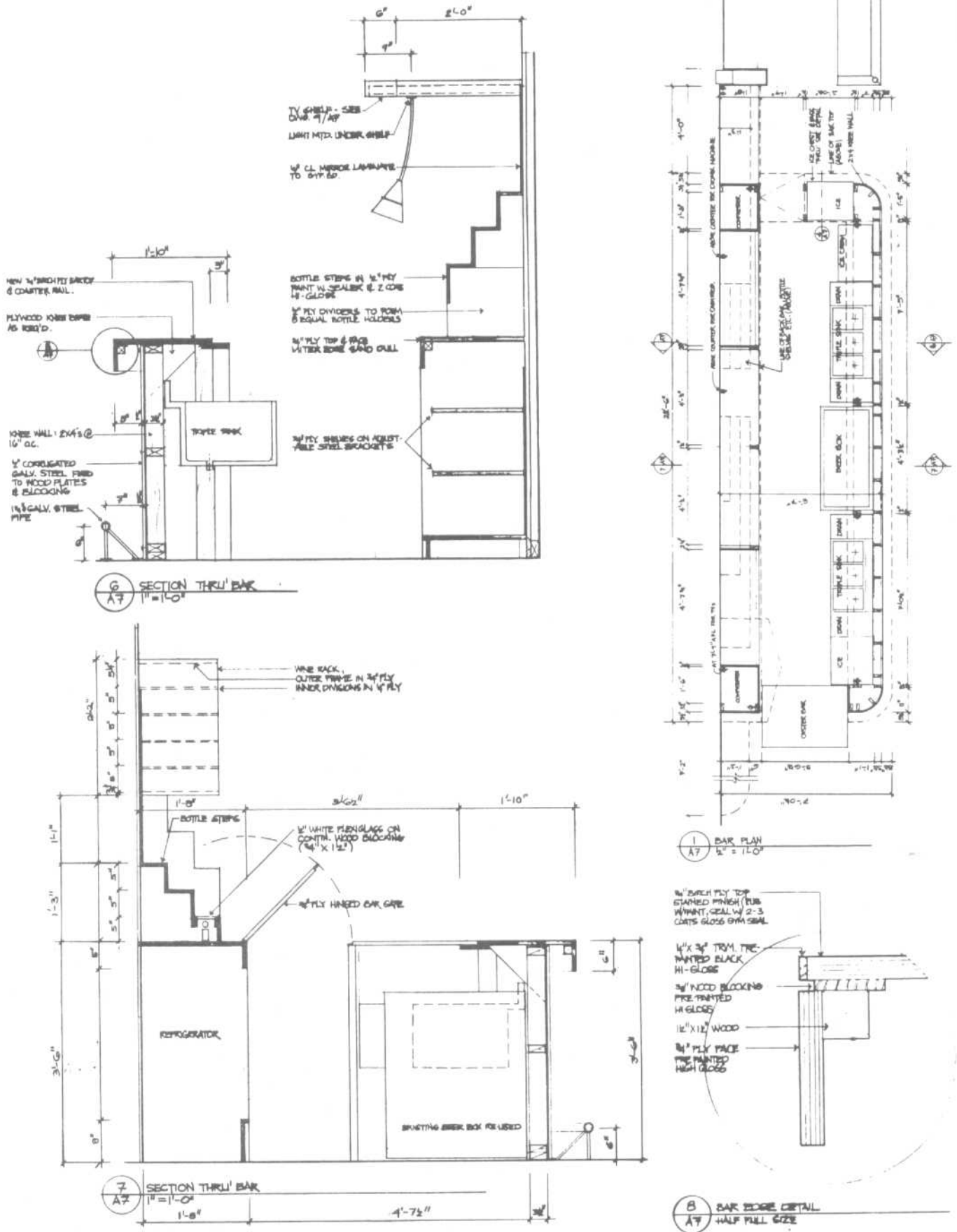
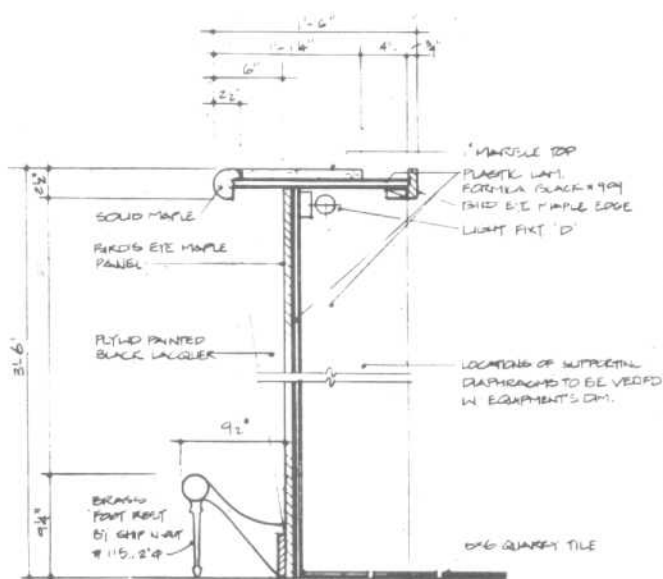
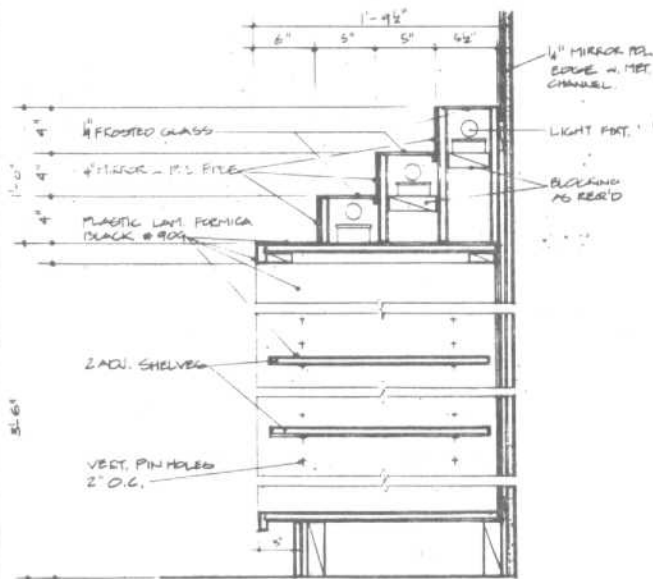


Fig. 33

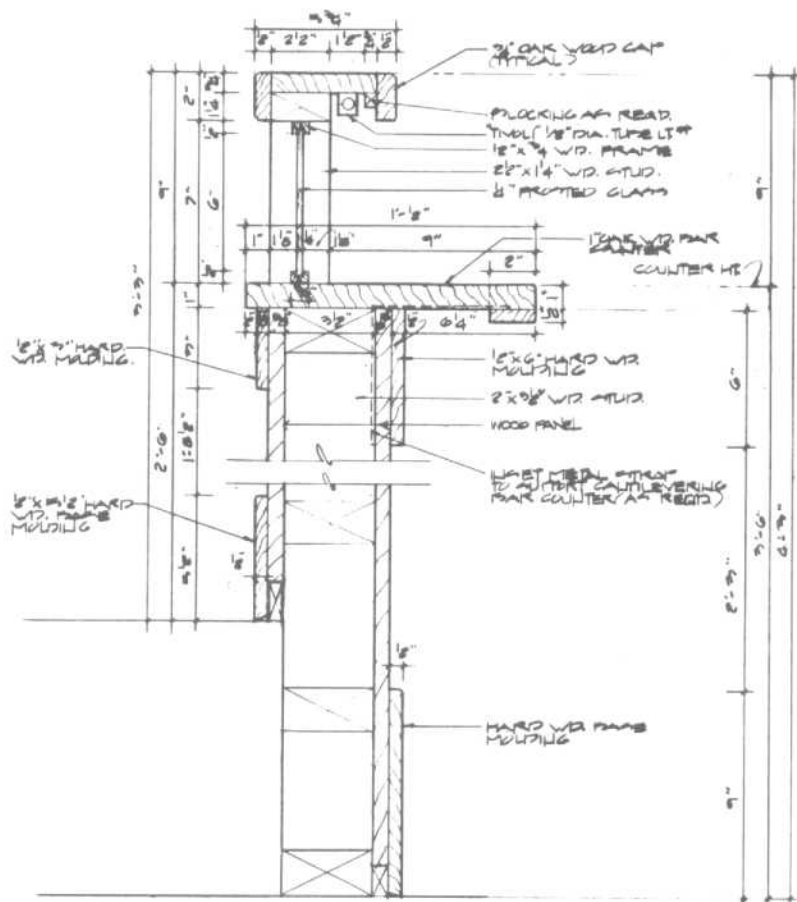


6 DETAIL OF BAR COUNTER  
SCALE: 1/2"=1'-0"



9 DETAIL OF BACK BAR COUNTER  
SCALE: 1/2"=1'-0"

Fig. 34



7 DETAIL SECTION THROUGH BAR COUNTER & RAISED FLOOR  
SCALE: 1/2"=1'-0"  
NOTE: ALL SURFACES INDICATED AS GYP. SH. TO BE WOOD PANNELLING TO MATCH EXIST'G BAR FRONT

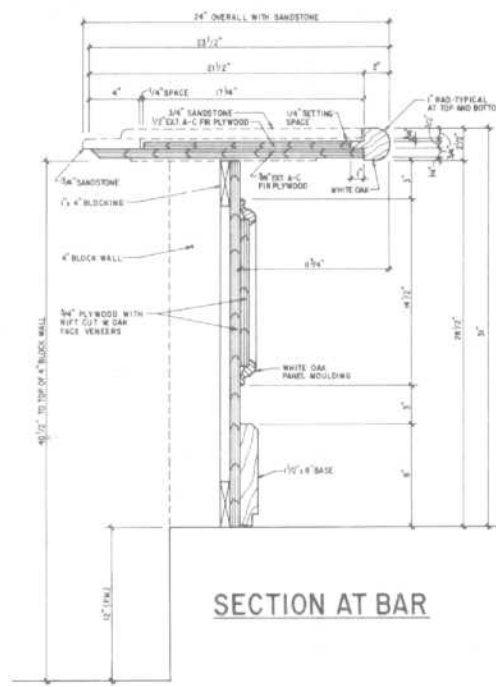


Fig. 36

Fig. 35



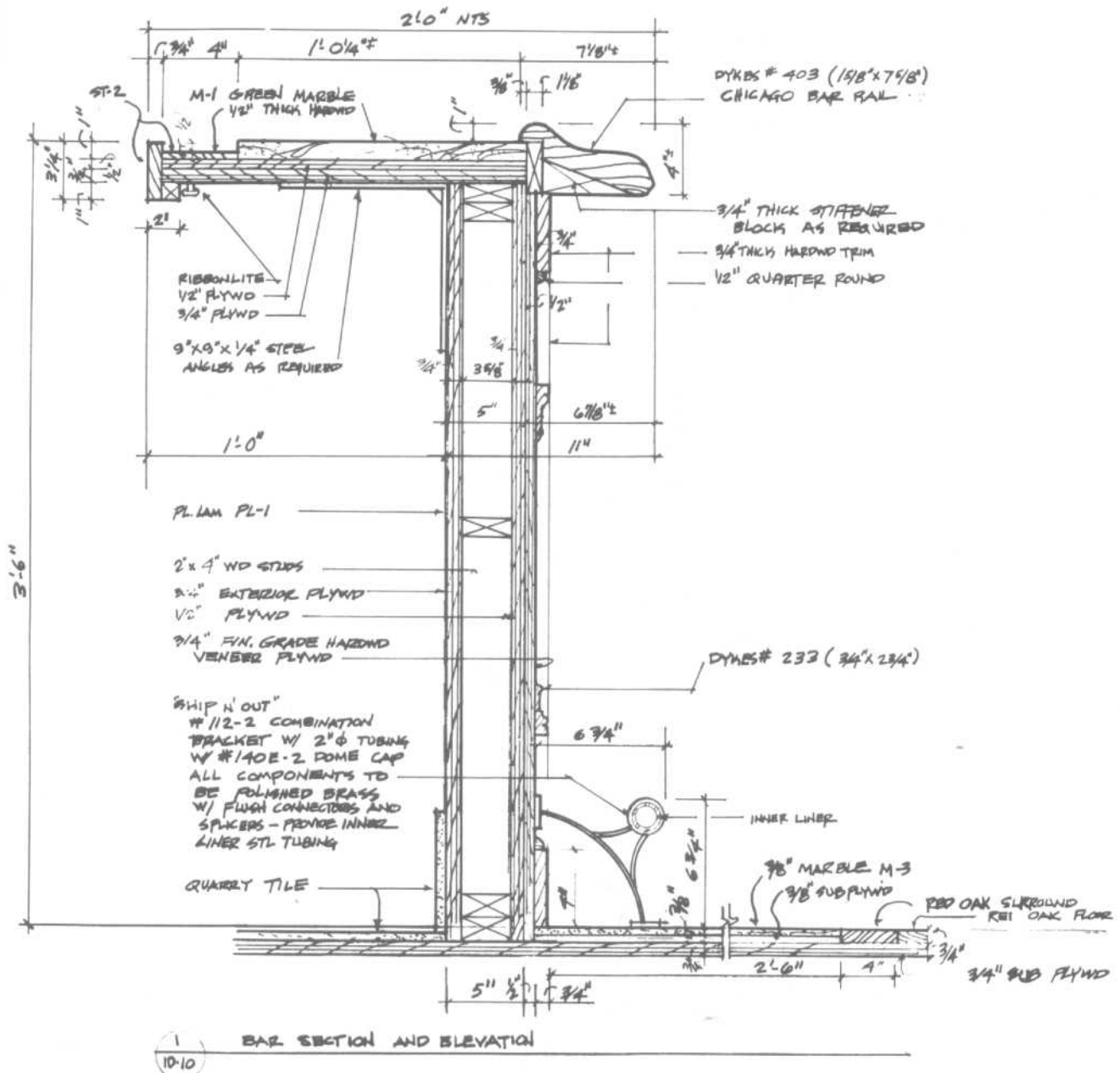
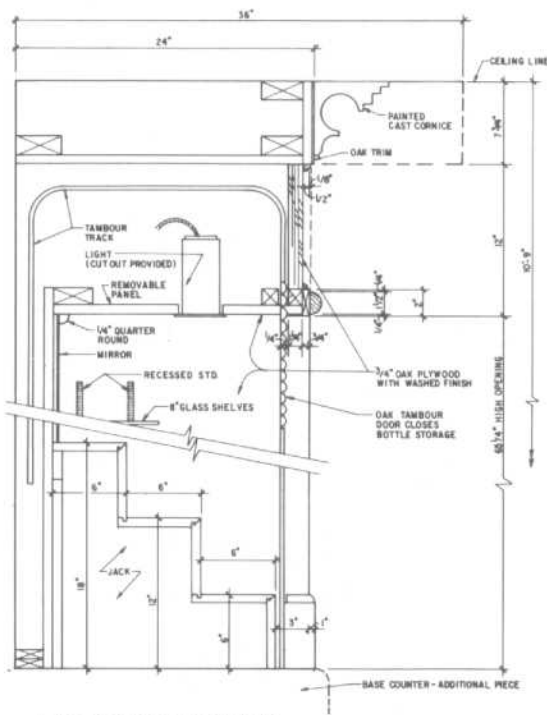


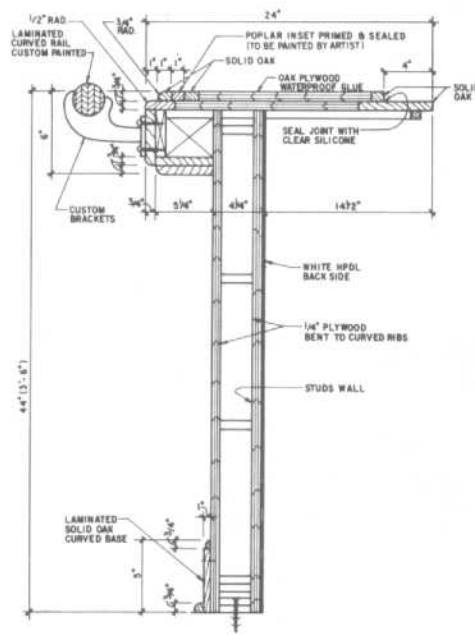
Fig. 38



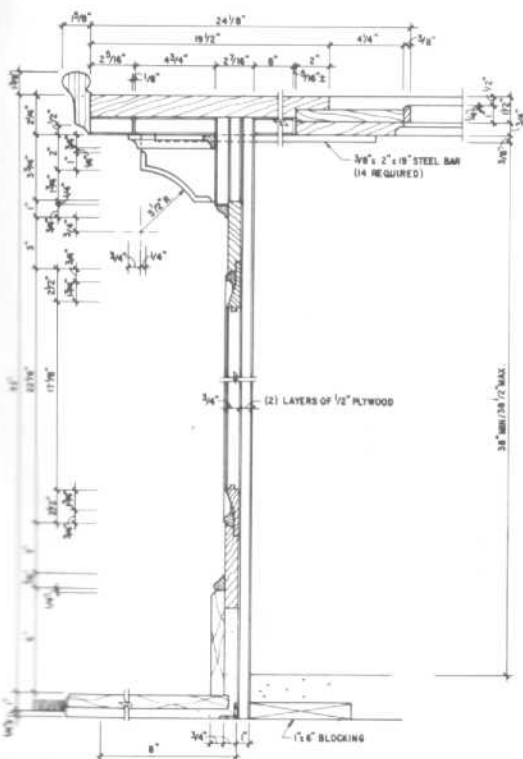




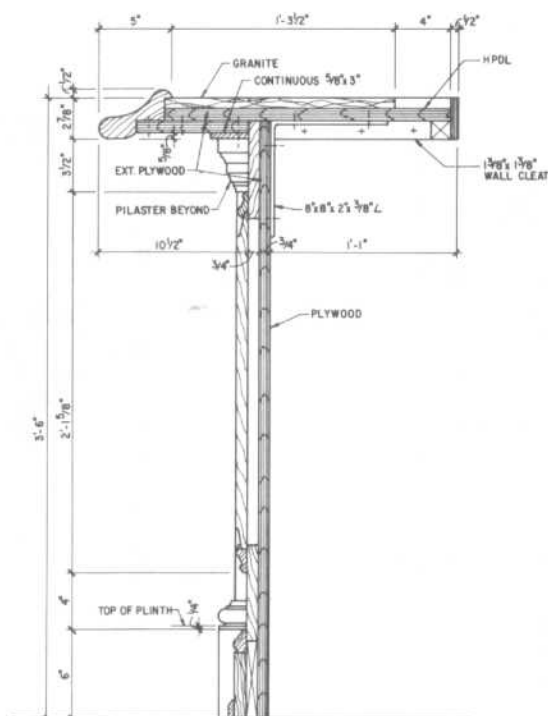
**BACK BAR SECTION**



**SECTION AT CURVED BAR**



**VERTICAL SECTION AT BAR**



**SECTION AT BAR**

Fig. 40

HOTELS

Guestroom Plans

It is interesting to note how trends in hotel design have headed off in two directions, especially in regard to the design of rooms. On one hand, an effort is being made to provide more luxurious multipurpose rooms and suites. The hotel room as office away from work or as fantasy sleeping/relaxation environment often results in rooms with

work areas, living rooms, and hot tubs, just to name a few of the more popular amenities. On the other hand, there is a trend toward economy accommodations. Hotel rooms are being designed as a place to rest and sleep, a place to feel comfortable and safe at a reasonable cost. Accordingly, these rooms use less floor area and provide less second-

ary or frill items. With both of these approaches, however, designers must ensure that the room or suite layouts are accessible to the physically challenged. In that regard, various room layouts and bathroom plans are provided in this section that address this issue.

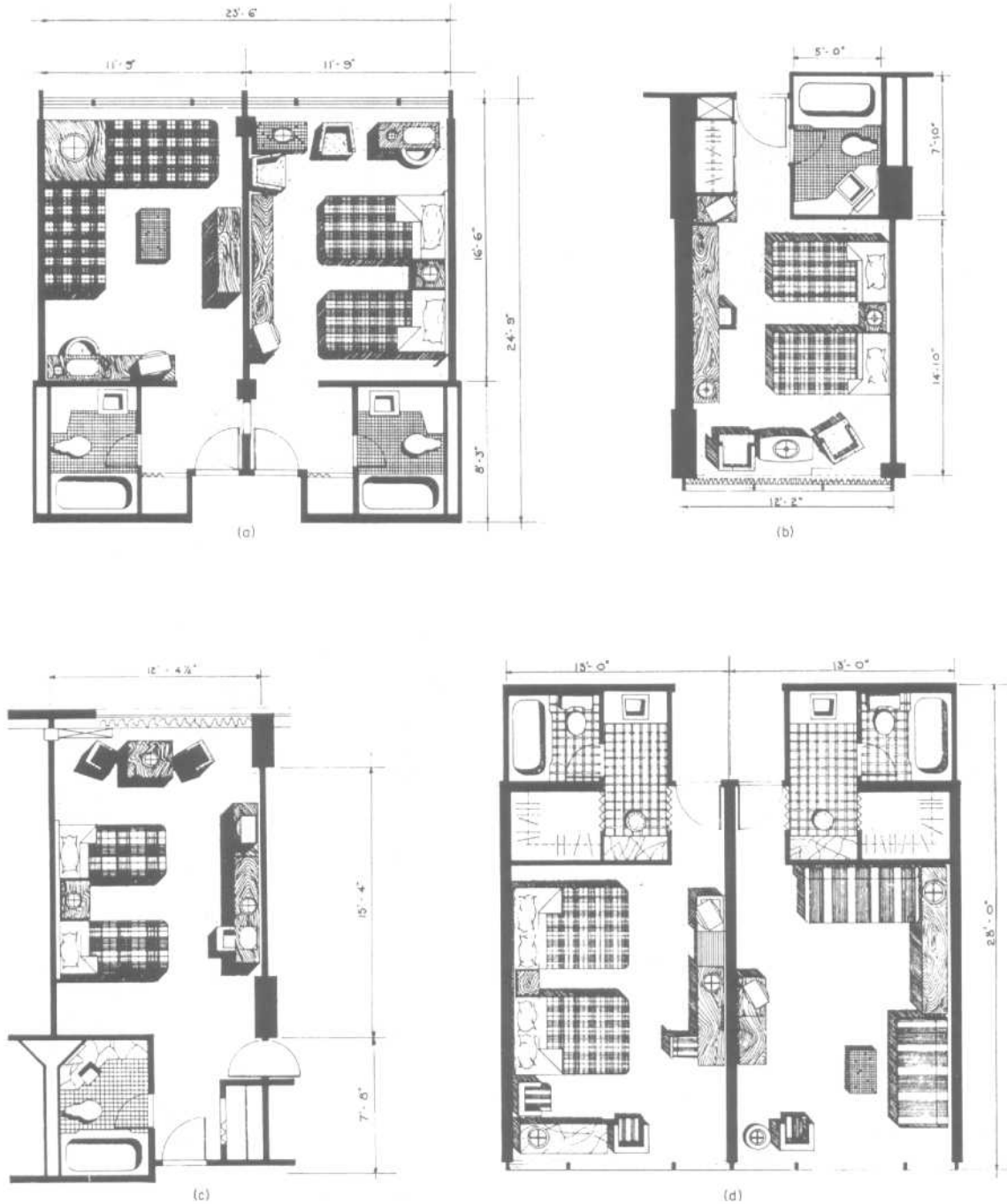


Fig. 1 (a) Uris Brothers Hotel, New York. (b) Americana Hotel, New York, typical lower room. (c) Loews N.Y. Motel, typical room. (d) Causeway Inn, Tampa, Florida.

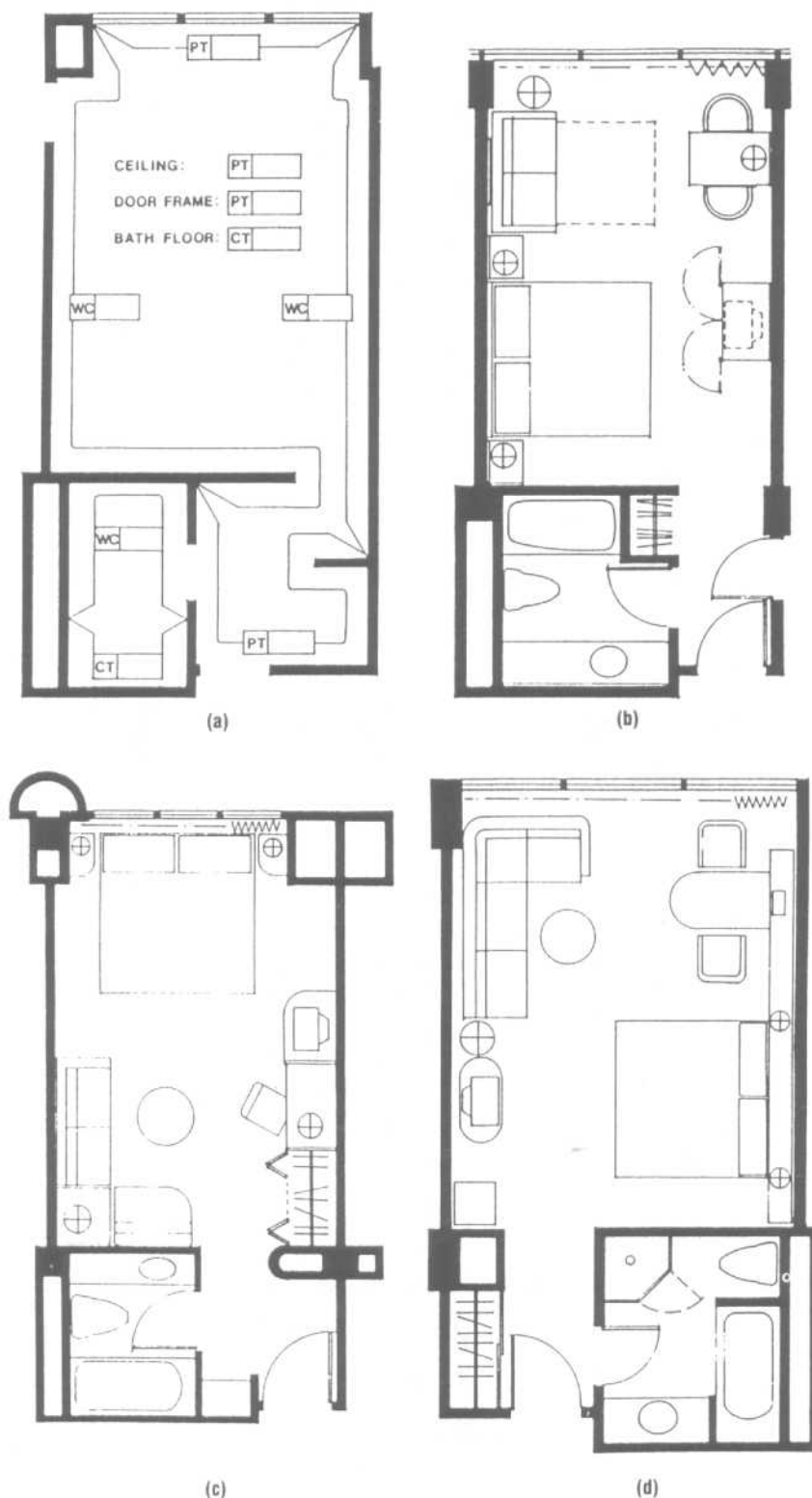


Fig. 2 Guestroom plans. (a) Typical double-double finishes plan: vinyl wallcovering (WC), paint (P), carpet (C), ceramic tile (CT) identified and keyed to legend. (b) King-studio (Holiday Inn): standard layout with armoire unit and large lounge area including a convertible sofa. (c) Reversed layout (Sheraton, Washington, D. C.): unusual room with bed placed in front of window and lounge area near bathroom. (d) Luxury king room (Sheraton Grande, Los Angeles): oversized room with shelf/ledge in place of headboard, large desk surface, and lounge area; four-fixture bathroom.

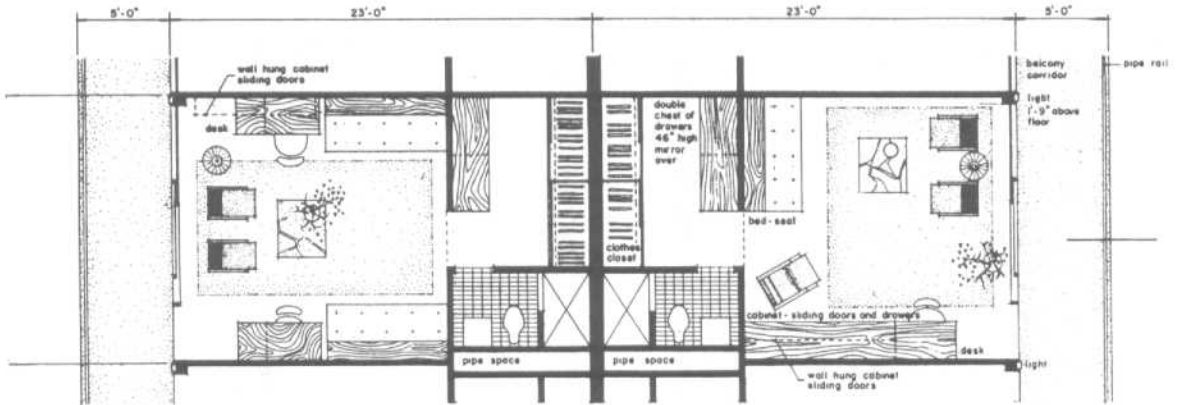


Fig. 3 Motel rooms — exterior entrance.

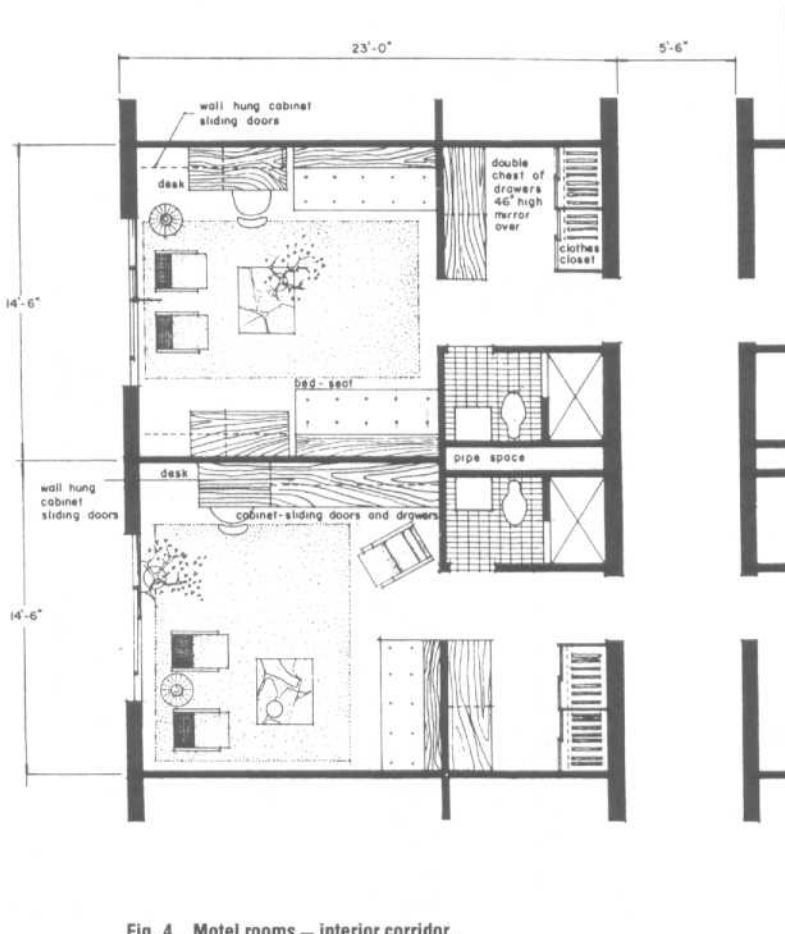


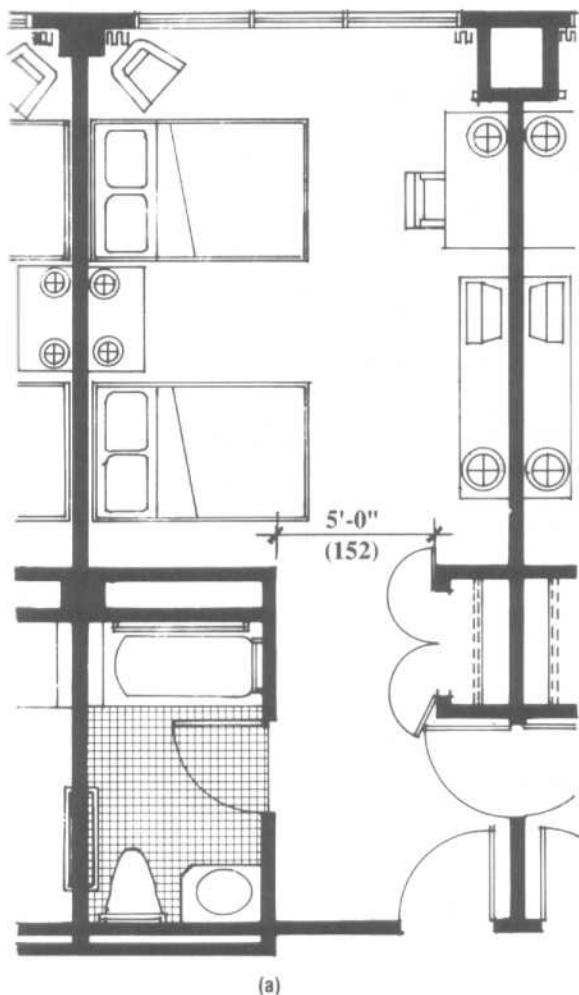
Fig. 4 Motel rooms — interior corridor.

**Guestroom Plans**

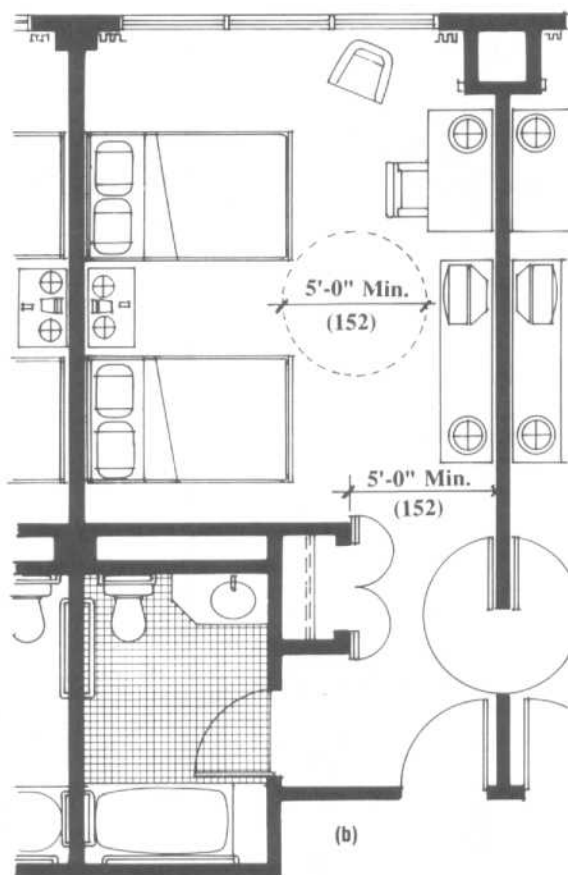
Accessible guestrooms have design features and floor plans that provide the maneuvering clearances for guests with limited mobility. Figures 5 to 9 show sample plans of guestrooms and bathrooms with the required:

- Widths and clearances at the entry, connecting, closet, and bathroom doors
- Maneuvering space in front of the closet, in the sleeping area, and within the bathroom
- Clearances to use and transfer to fixtures in the bathroom
- Clearances to open dresser drawers, to maneuver into kneespace at the desk, and to access the bed, bedside table, windows, blinds, and thermostat

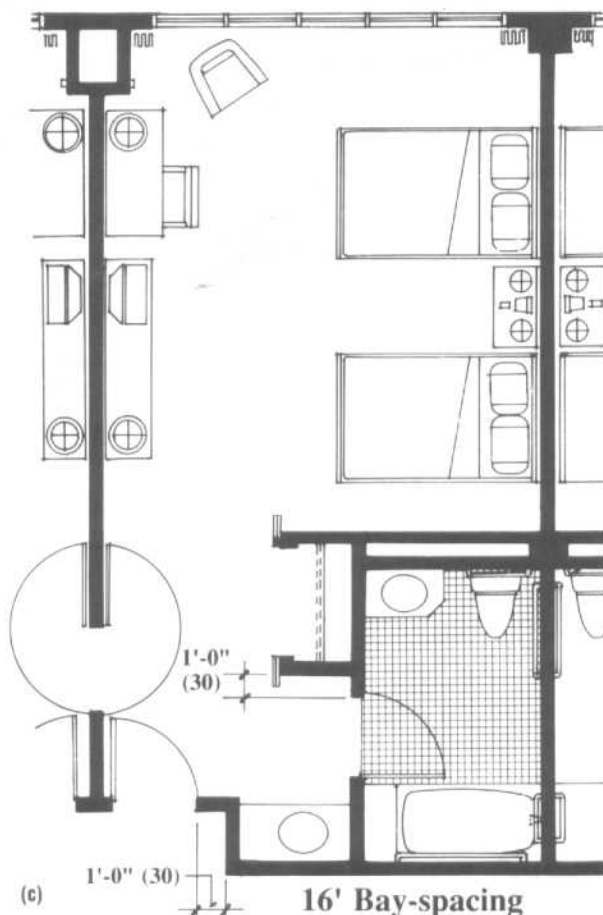
Clearances may depend on the design of specific furnishings. The width of the access aisle at the bed is determined by the design of the bedside table. Access to dressers is determined by the width of the drawer. The maneuvering space to turn into the desk is determined by the width of the kneespace.



**14' Bay-spacing**

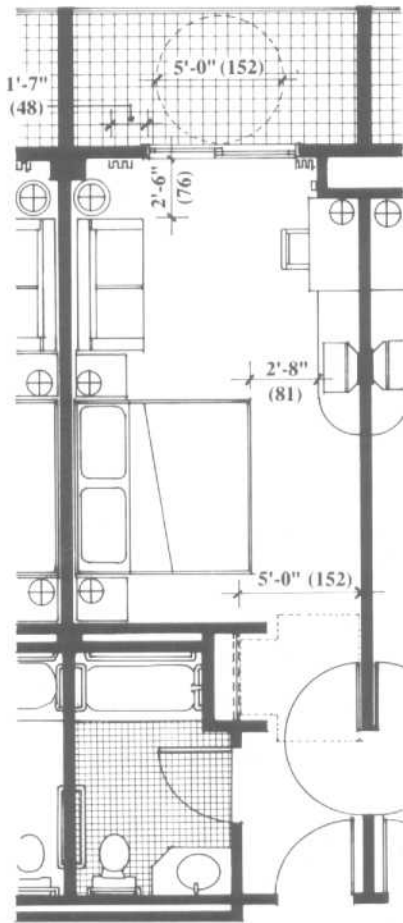


**15' Bay-spacing**



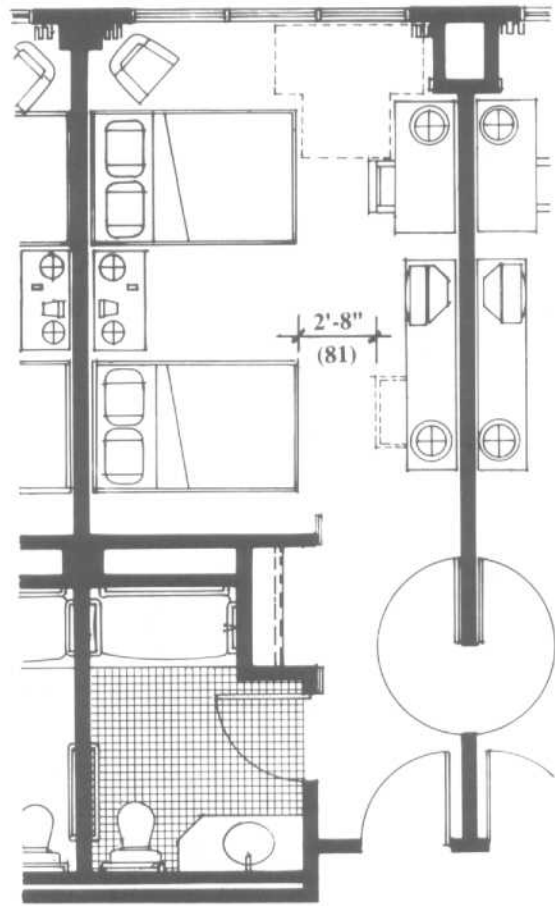
**16' Bay-spacing**

Fig. 5 Bay-spacings of (a) 14', (b) 15', and (c) 16' can easily accommodate guests with restricted mobility.



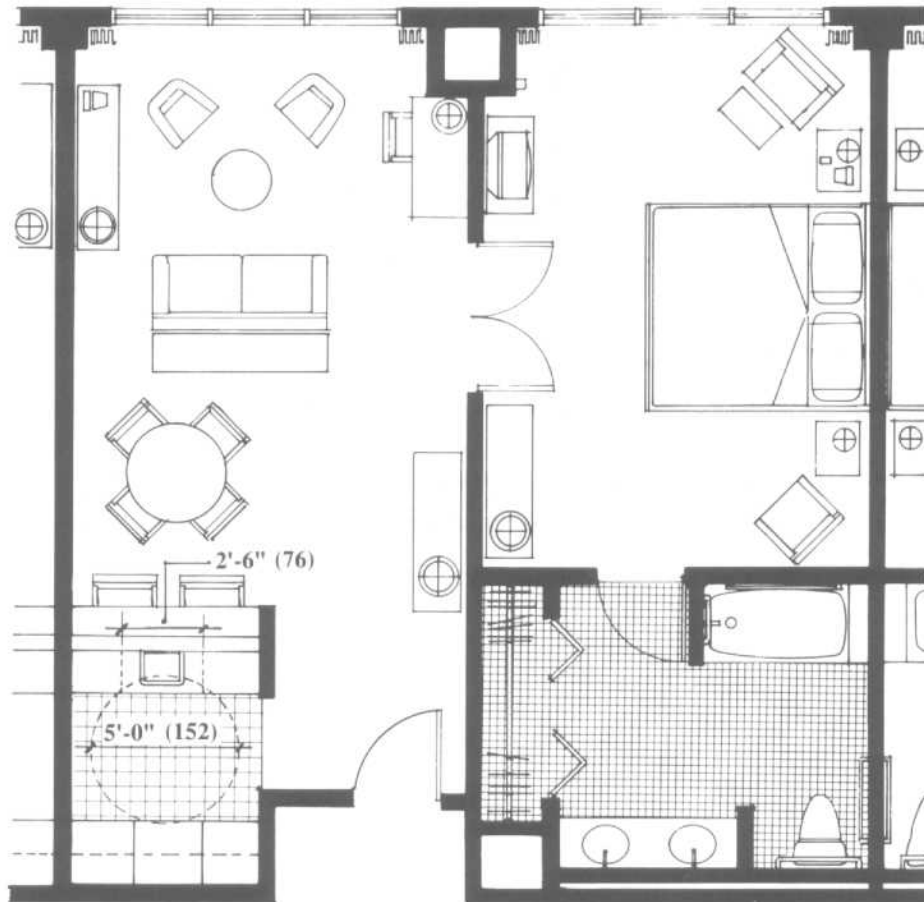
12' Bay-spacing

Fig. 6 This alternative 12'0" bay-spacing design requires the dresser to be offset from the foot of the bed. The bathroom wall is stepped back to provide clearances for the bathroom door and connecting door. The heating/cooling unit projects into the room to allow access to the thermostat. If balconies are provided, a minimum depth of 5'0" is recommended to allow guests with wheelchairs to turn around.



13' Bay-spacing

Fig. 7 A 13'0" bay-spacing provides room for wheelchair clearances, including a turning space in front of the closet and at the foot of the beds, an access aisle between the beds, a T-turnaround at the window aisle for access to temperature controls and blinds and drapes, door clearances, and a bathroom that meets ANSI standards.



### Suite with 14' Bay-spacing

Fig. 8 Accessible suites should meet the same requirements for accessible guestrooms and guest baths. Because suites are usually more generous in terms of space, providing accessibility is less difficult. If a small kitchenette is included, a knee-space 2'3" high should be provided below the sink. A countertop height of 2'10" (2" lower than standard) is suitable for both ambulatory guests and guests in wheelchairs. A pull-out lapboard at a height of 2'6" provides a workspace for guests in wheelchairs. The kitchenette should include a 5'0" turning space.

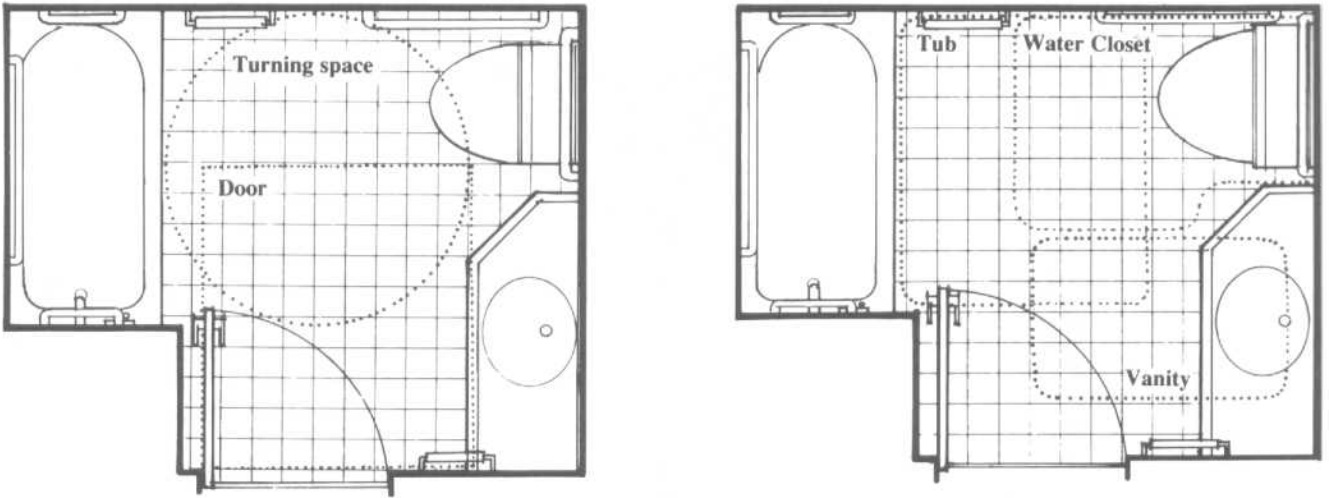


Fig. 9 These two diagrams illustrate the same bathroom plan with the required clearances for door operation and turning space and access to each fixture, including the tub/shower, vanity, and water closet. Clearances for maneuvering space, door operation, and individual fixtures can "overlap." Because of the vertical characteristics of wheelchairs, clearances can include toespace (9" high) below water closet and kneespace (2'3" high) below vanities.



The hotel registration desk serves as both a symbol of hospitality for the arriving guest and the operational nerve center for the hotel. With the advent of electronic check-in procedures, credit cards, and computer-aided management, the registration desk has become a sophisticated electronic workstation not unlike a trading table or an airline reservations desk. At the same time, this electronic data processing capability is meant to be maintained at low visibility for reasons of hotel image and confidentiality. Accordingly, the designer must be able to

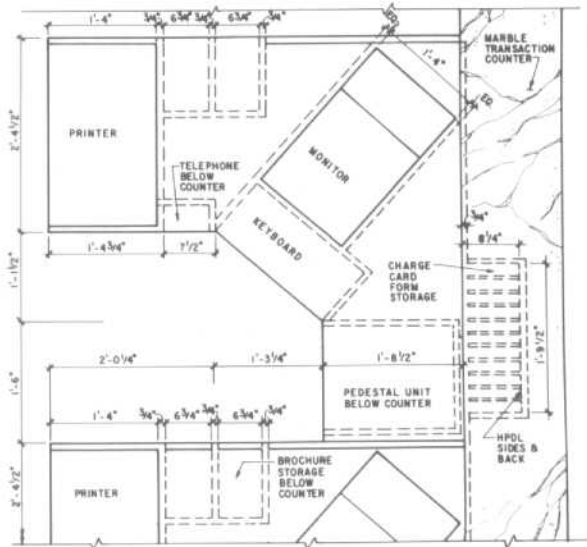
project the appropriate hospitality image while at the same time integrating all of the required technologies. Figures 10 to 13 show examples of architectural working drawings and details that meet many of these requirements.

The design of a front desk or registration desk can take many forms and be constructed with a variety of materials. Regardless of the design vocabulary used or architectural style, certain important design considerations must be observed.

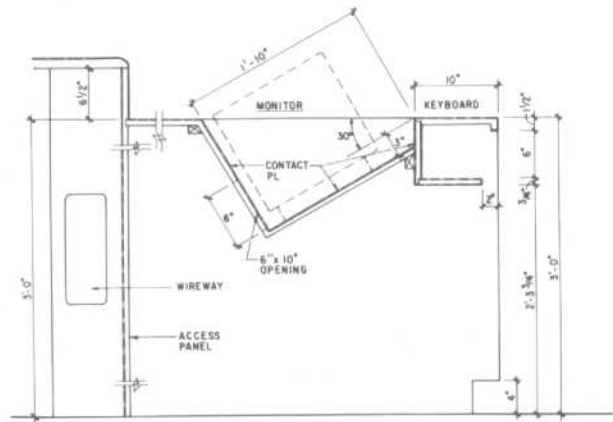
1. The number of persons actively staffing

the counterlike facility will dictate both the width and overall depth of the front desk. It is suggested that between 5–7 ft be allocated per staff workstation and that one workstation be allocated for every 125–150 rooms. For every additional 125–150 rooms, an additional workstation should be provided. Peak check-in/check-out loads could require even more staff workstations.

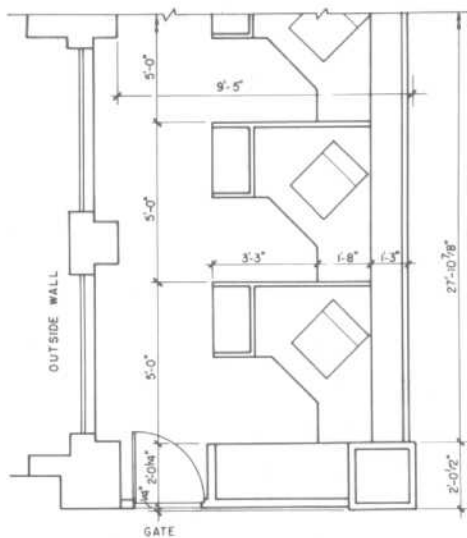
2. The front desk should be easily accessible from and to the main hotel entrance. "Easily accessible" strongly implies clear visibility.



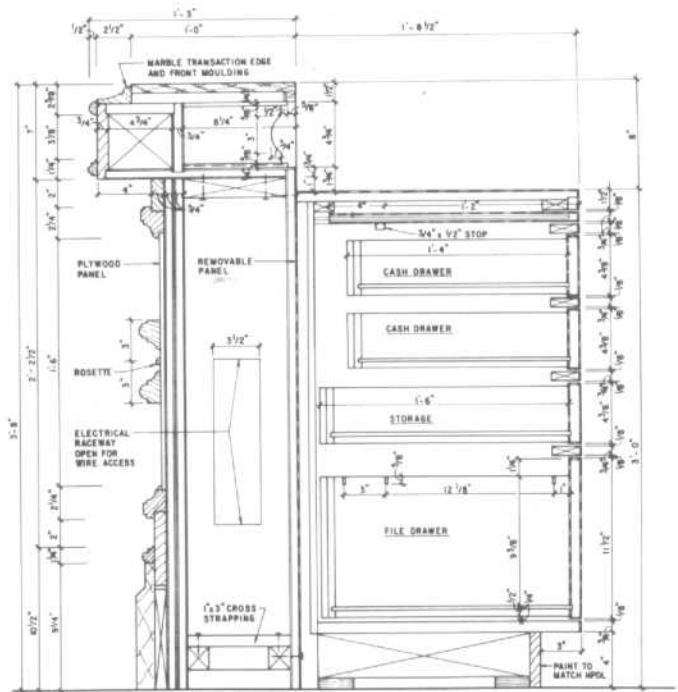
**ENLARGED PARTIAL PLAN  
REGISTRATION COUNTER  
GRAND FLORIDIAN HOTEL**



**SECTION AT REGISTRATION DESK  
GRAND FLORIDIAN HOTEL**



**PARTIAL PLAN  
REGISTRATION COUNTER  
GRAND FLORIDIAN HOTEL**



**SECTION AT COUNTER  
GRAND FLORIDIAN HOTEL**

HOTELS

Registration Desk

3. Elevators servicing the hotel guest rooms should be readily visible from the front desk. This is not always feasible in extremely large hotels.

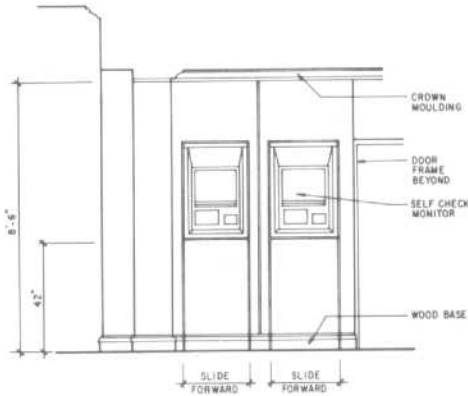
4. The front desk should be designed in such a way as to take into consideration the various users it will accommodate. Special attention should be given to the fact that hotel guests may be physically challenged or chairbound. The overall height, writing sur-

faces, and overhangs should be designed to accommodate a hotel guest seated in a wheelchair.

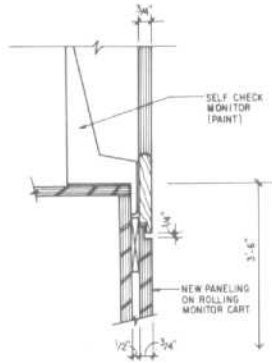
5. The basic front desk design should avoid, wherever possible, visual obstructions that block sightlines or create blind spots. Accordingly, columns and high walls should be avoided.

6. Equipment and custom elements that are typically incorporated within the front

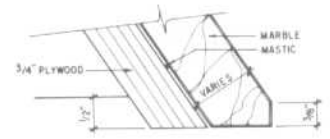
desk include computer monitors/CRTs with keyboards and printer, room racks, reservation racks, information racks, room status displays, mail drawers, key drawers, alpha guest listings, message-waiting display, credit card imprinters, fax and telex, guest/employee paging system, automatic wake-up system, electric receptacles, cable chases, alarm systems, and file and cash drawers.



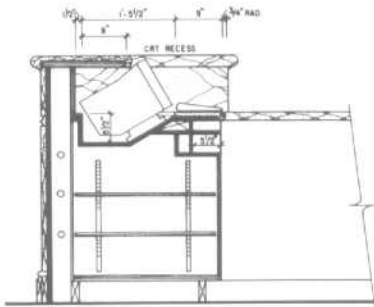
**ELEVATION  
AT SELF CHECK MONITOR**



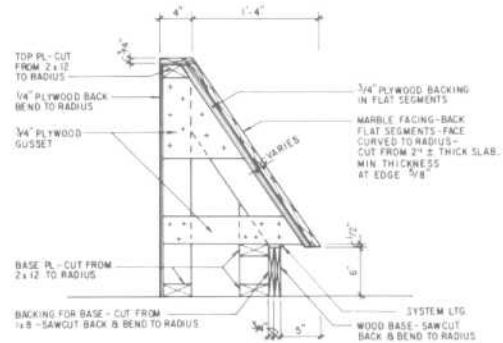
**SECTION DETAIL  
AT SELF CHECK MONITOR**



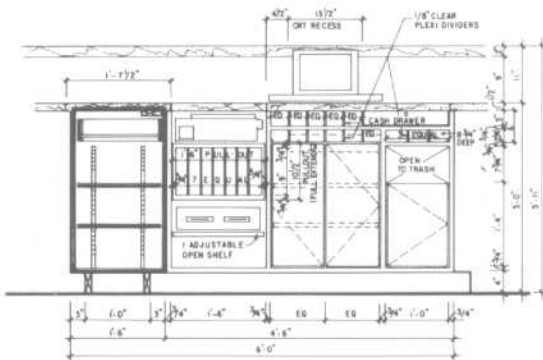
**SECTION DETAIL-  
SETTEE**



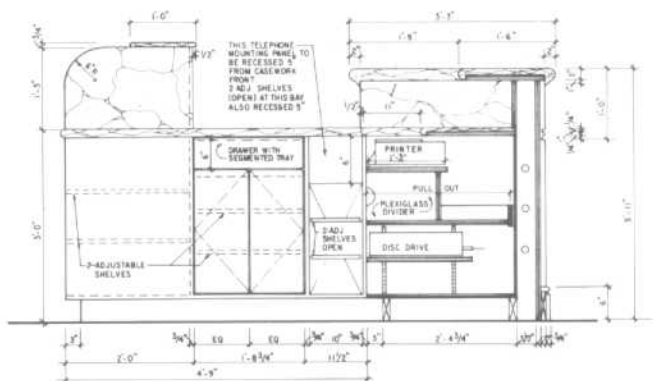
**ELEVATION/SECTION-  
REGISTRATION COUNTER**



**SECTION-CIRCULAR SETTEE BACK**

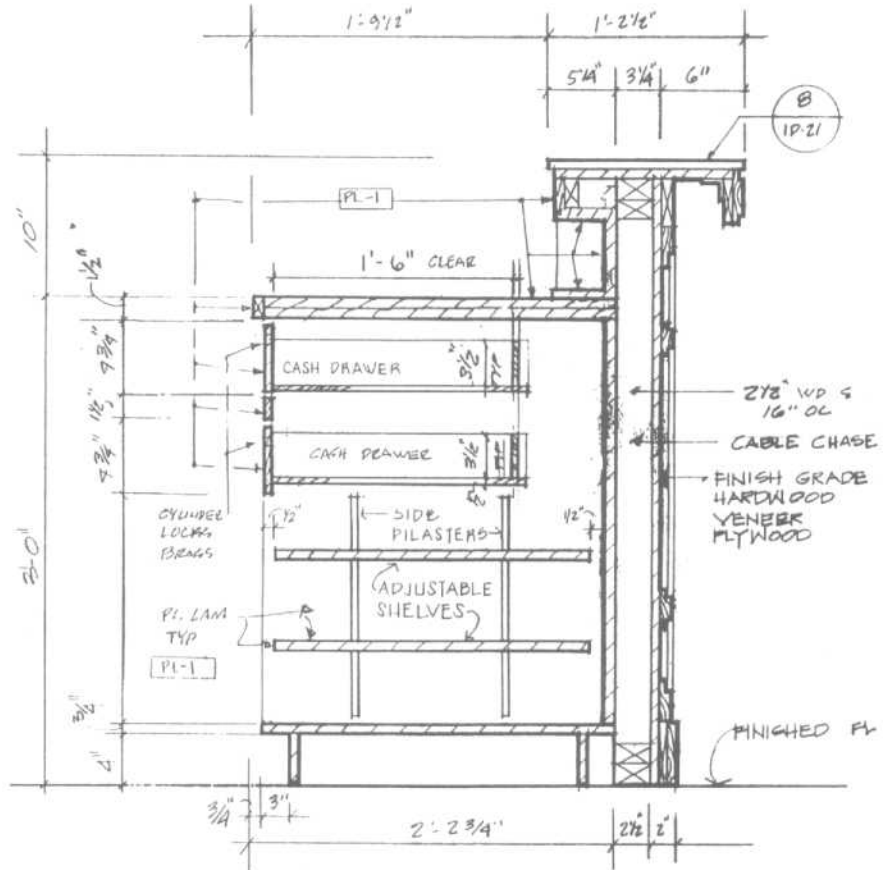


**ELEVATION - REGISTRATION COUNTER**

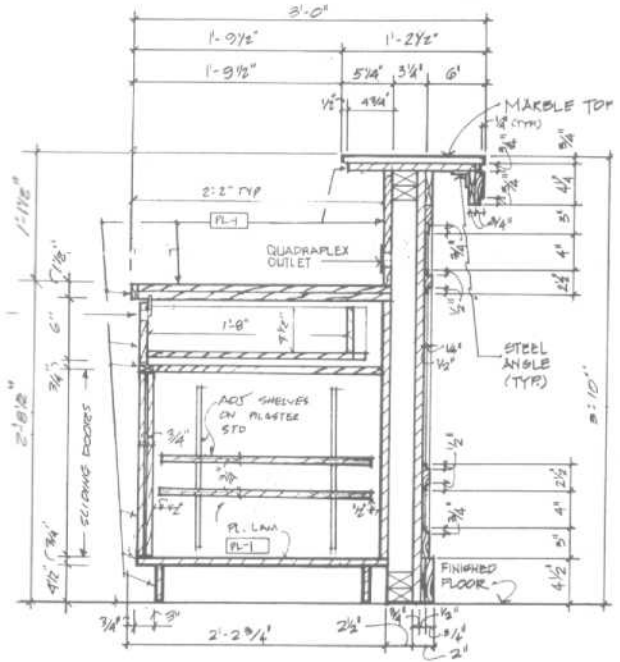


**ELEVATION/SECTION - REGISTRATION COUNTER**

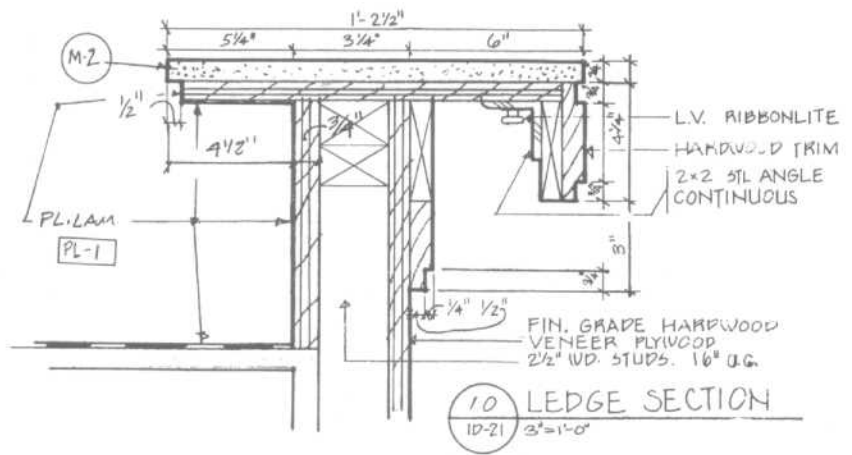
Fig. 11



5 REGISTRATION DESK STORAGE  
1/2" = 1'-0"

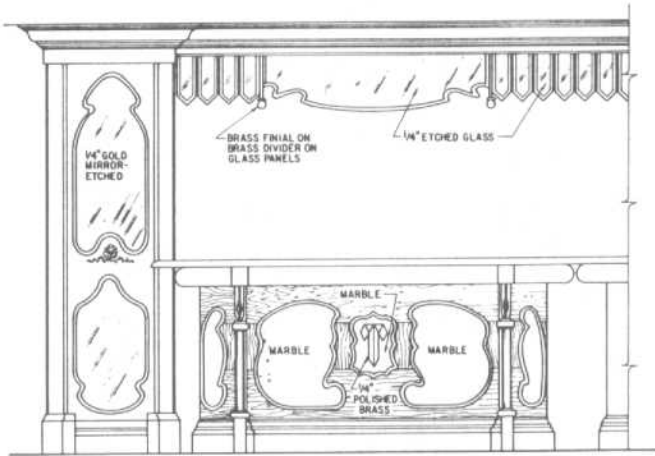


1 RECEPTION DESK STORAGE  
SCALE: 1/8" = 1'-0"

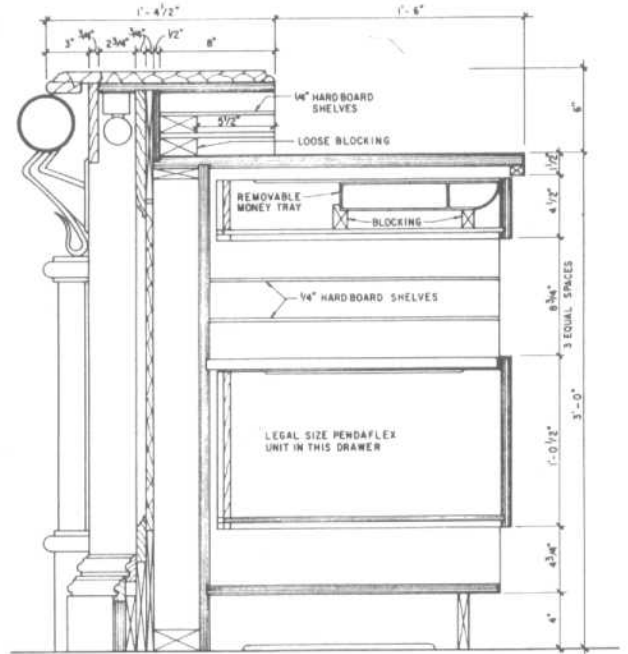


10 LEDGE SECTION  
3" = 1'-0"

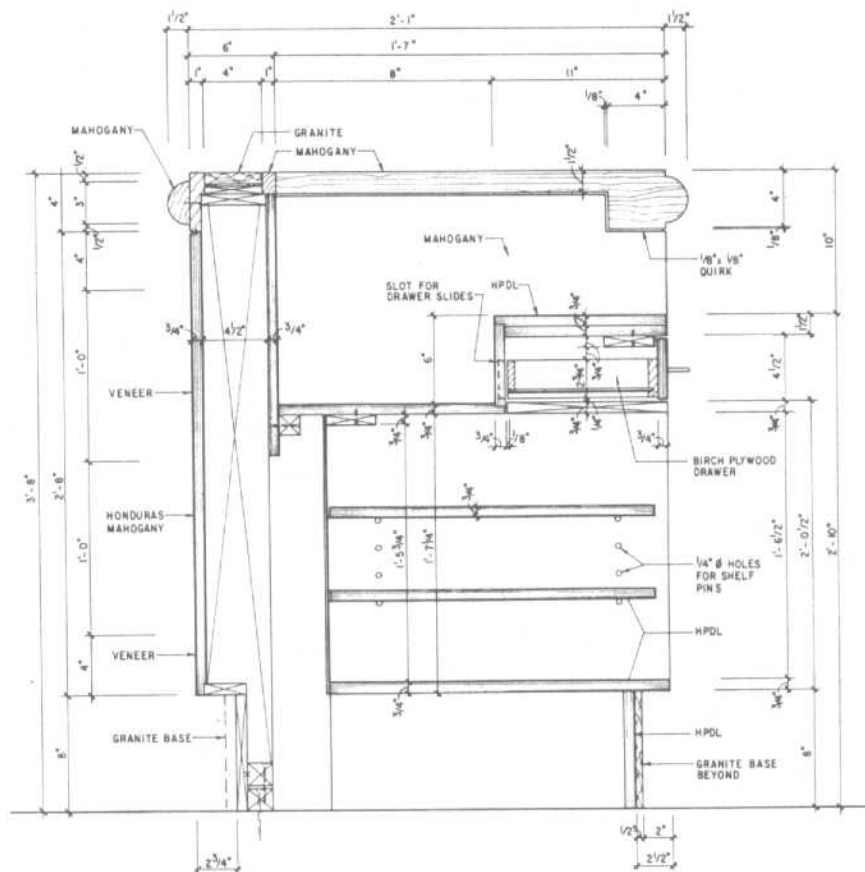
Fig. 12



PARTIAL ELEVATION-FRONT DESK  
TROPICANA HOTEL



VERTICAL SECTION  
REGISTRATION DESK TROPICANA HOTEL



VERTICAL SECTION AT RECEPTION DESK

Fig. 13

# Retail Spaces

<b>Shops</b>	<b>387</b>
<b>Banks</b>	<b>396</b>
<b>Department stores</b>	<b>401</b>



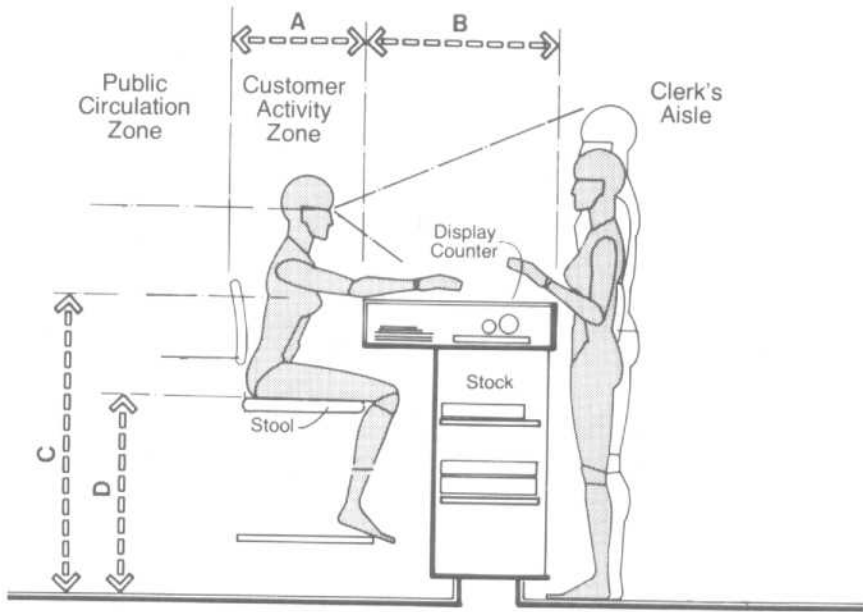


Fig. 1 Seated customer/high counter height.

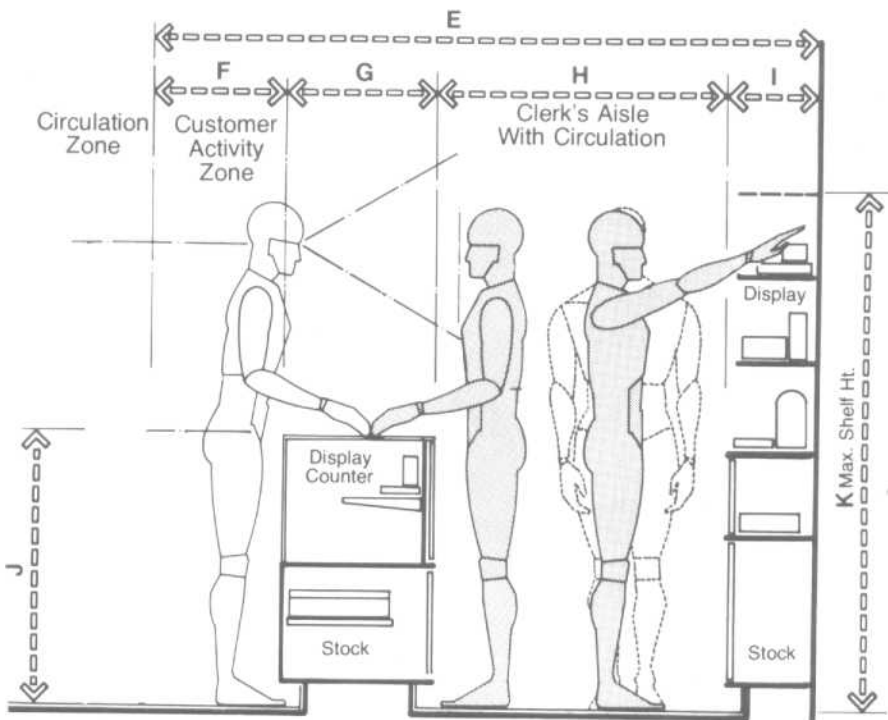


Fig. 2 Typical sales area/standing customer.

The essential function of retail spaces is to display and sell merchandise. The design of these spaces involves the manipulation and coordination of architectural, interior design, and merchandising elements as necessary to meet the programmatic needs of the client. It is critical that the space in which the customer and store personnel function is of the highest quality. Ensuring this quality requires a knowledge of the planning and design of the various interior components that constitute the building blocks of retail spaces.

Figure 1 shows the clearances involved for a 42-in, or 106.7-cm, high counter to service a seated user. By filling the recess with an additional display, however, the counter can also be used exclusively as a typical sales counter. It should be noted, however, that although sometimes used for special display situations, such a counter height is not recommended. Both the customer and the sales clerk of smaller body size would find coping with such a height uncomfortable anthropometrically, particularly when one considers that the counter would be higher than the elbow height of slightly over 5 percent of the population. From a merchandising viewpoint, where customer convenience is of paramount importance, it would be unwise to exceed 39 to 40 in, or 99 to 101.6 cm, as a counter height. In addition, the smaller sales clerk forced to tend such a counter for extended periods of time could be subjected to severe backaches and pains. Getting on and off a high stool for elderly and disabled people or those of smaller body size can be not only difficult, but hazardous. Figure 2 illustrates the clearances for a typical sales counter.

	in	cm
A	26-30	66.0-76.2
B	18-24	45.7-61.0
C	42	106.7
D	28	71.1
E	84-112	213.4-284.5
F	18	45.7
G	18-24	45.7-61.0
H	30-48	76.2-121.9
I	18-22	45.7-55.9
J	35-38	88.9-96.5
K	72	182.9

## SHOPS

## Planning Data

Figure 3 shows the clearances required for a medium height display counter. The suggested seat height of 21 to 22 in, or 53.3 to 55.8 cm, requires a footrest for the seated customer. The counter height shown will allow the display to be viewed by both the seated customer and the standing sales clerk. The customer activity zone allows adequate space for the chair. Knee height, buttock-knee length, popliteal height, and eye height sitting are all significant human dimensions to consider in the design of counters to be used by a seated customer.

Figure 4 shows a low 30-in, or 76.2-cm, display counter also for use by a seated customer. The anthropometric considerations are the same. Although the counter height is less than ideal for the standing clerk, for the standing user's optimum comfort, the counter height should be about 2 or 3 in, or 5 to 7.6 cm, below elbow height. This will allow a person to handle objects comfortably on the counter surface or use the counter as support for his or her arms. The 30-in height is too low to permit such use.

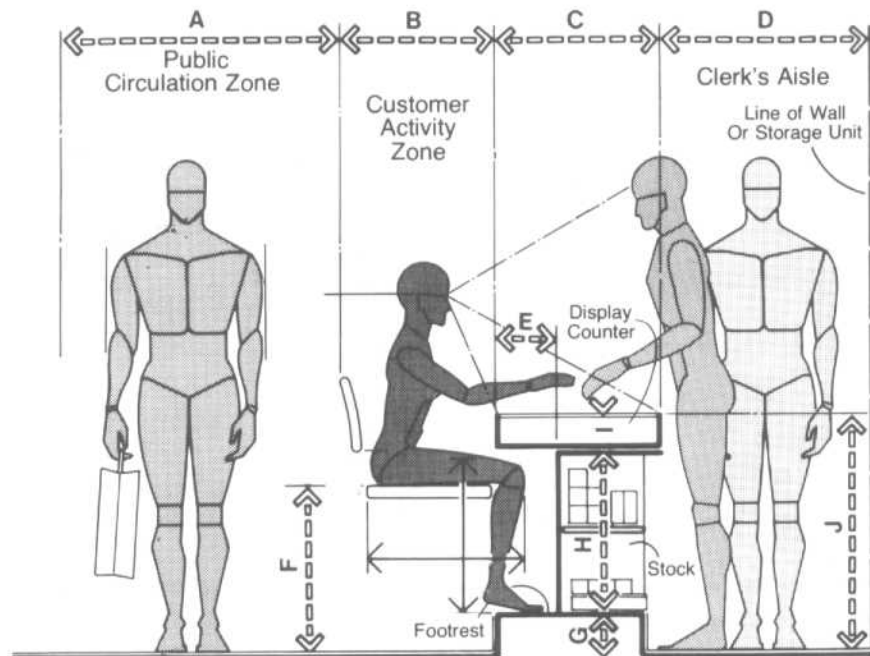


Fig. 3 Seated customer/desirable counter height.

	in	cm
A	36	91.4
B	26-30	66.0-76.2
C	18-24	45.7-61.0
D	30 min.	76.2 min.
E	10	25.4
F	21-22	53.3-55.9
G	5	12.7
H	23-25	58.4-63.5
I	4-6	10.2-15.2
J	34-36	86.4-91.4
K	30	76.2
L	16-17	40.6-43.2

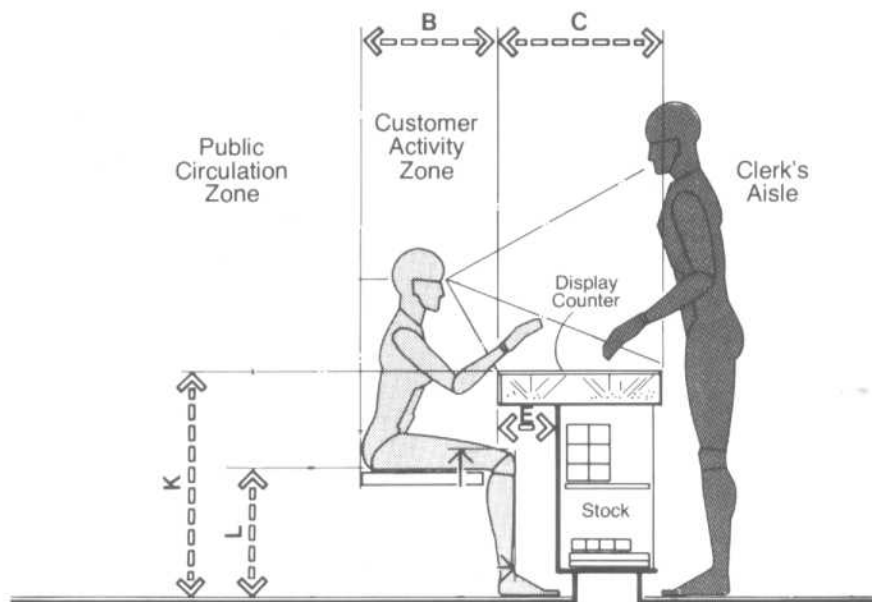


Fig. 4 Seated customer/low counter height.



Shelving is probably used more than any other single interior component for the storage and/or display of merchandise. Not only must the merchandise be within reach anthropometrically, but it must be fairly visible as well. The heights established must therefore be responsive to vertical grip reach dimensions as well as to eye height. In establishing height limits, the body size data of the smaller person should be used. Since in retail spaces, departments may cater exclusively to members of one sex or the other, two sets of data are presented. One is based on the body size of the smaller female and the other on the body size of the smaller male. The suggested heights reflect a compromise between reach requirements and visibility requirements.

Figure 6 illustrates the clearances involved in hanging-type merchandise cases. Rod heights should be related not only to human reach limitations, but in certain cases to the sizes of the merchandise displayed. There is usually no conflict in respect to garments.

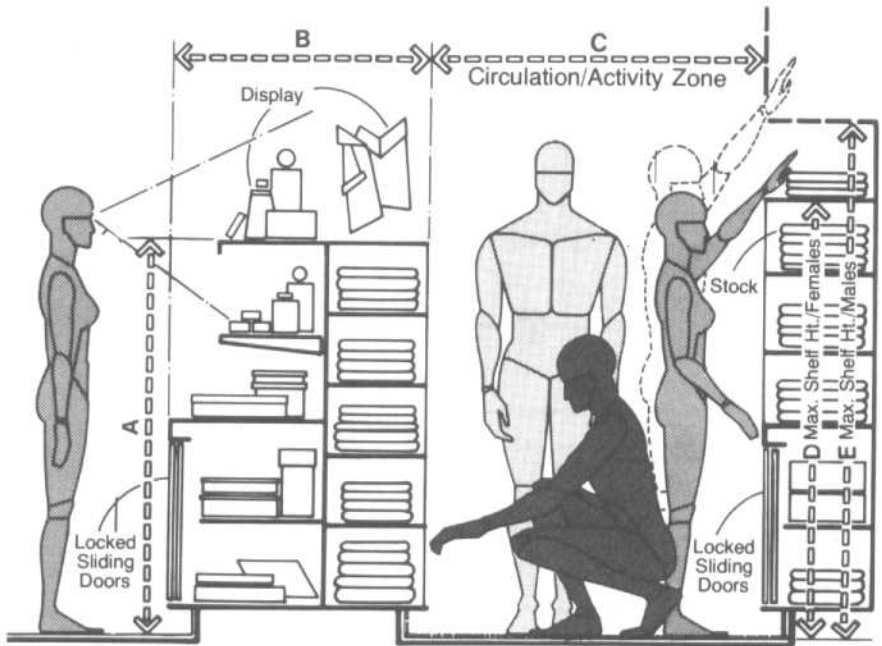


Fig. 5 Typical merchandise cases.

	in	cm
A	48 max.	121.9 max.
B	30-36	76.2-91.4
C	51 min.	129.5 min.
D	66	167.6
E	72	182.9
F	84-96	213.4-243.8
G	20-26	50.8-66.0
H	28-30	71.1-76.2
I	18-24	45.7-61.0
J	18 min.	45.7 min.
K	72 max.	182.9 max.
L	4	10.2
M	42	106.7
N	26 min.	66.0 min.

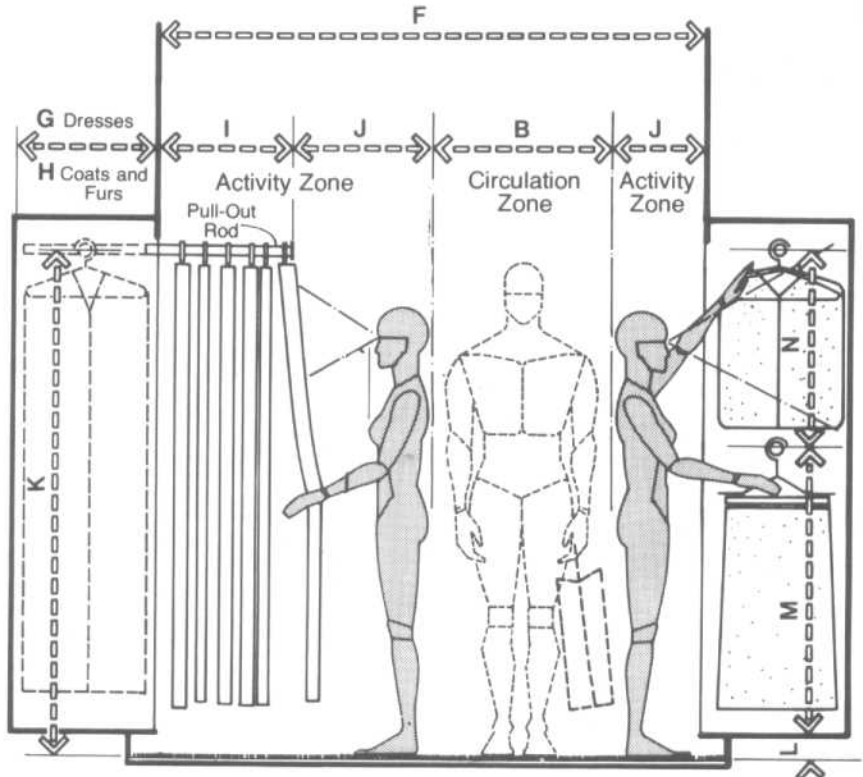
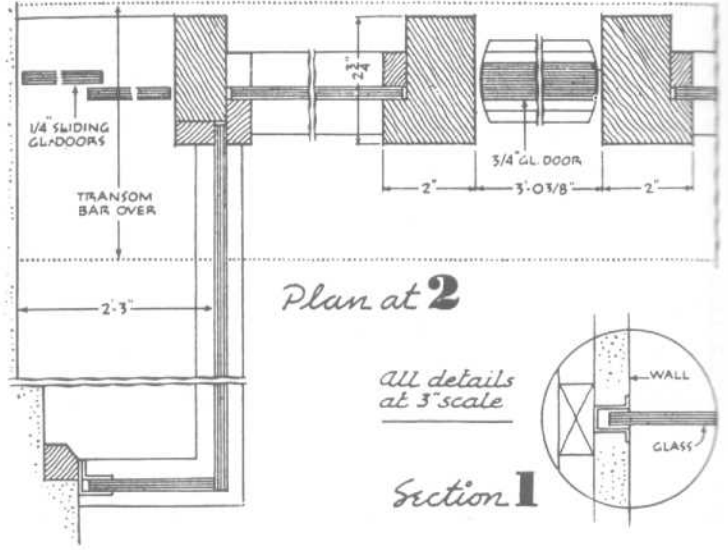


Fig. 6 Hanging merchandise cases.



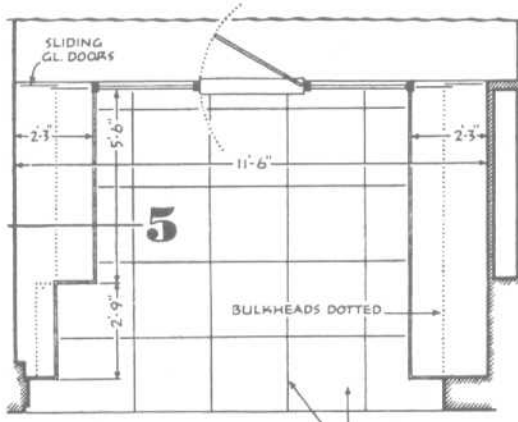
Section 3/16" SCALE



Plan at 2

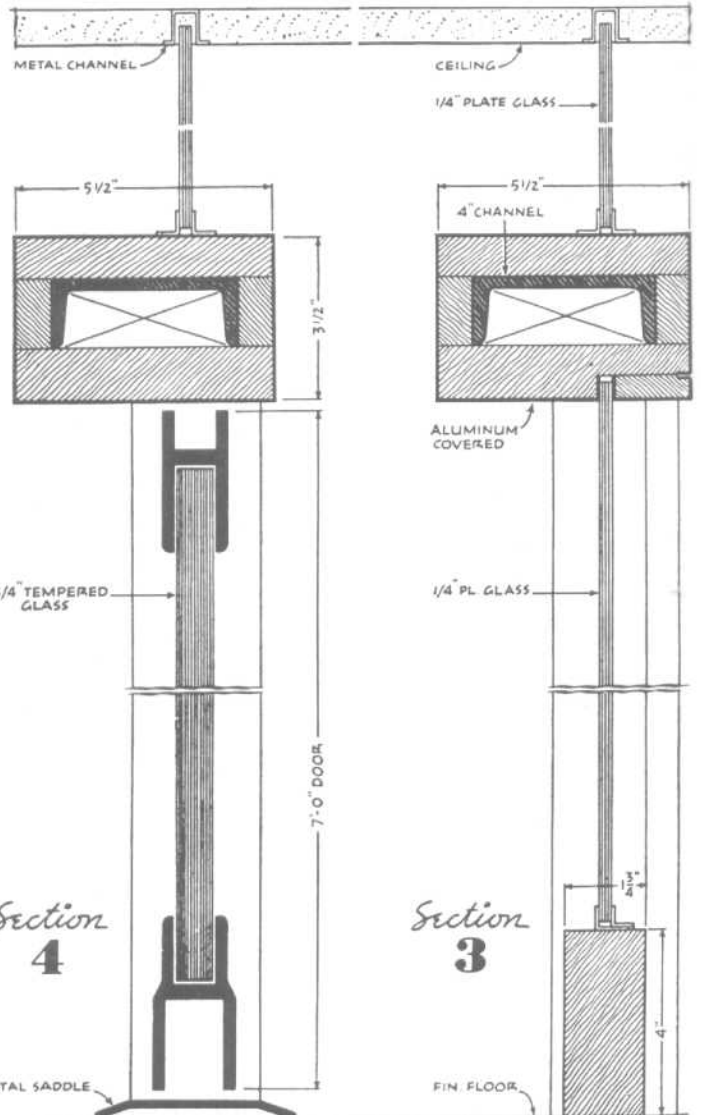
All details at 3" scale

Section 1



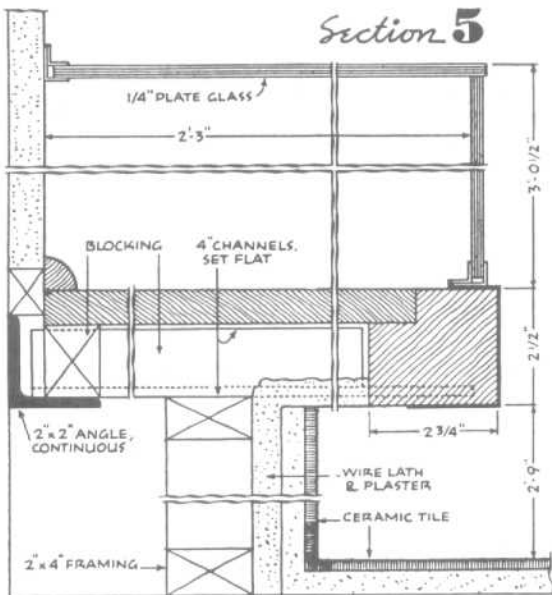
Plan 3/16" SCALE

CERAMIC TILE FLOOR WIDE CEMENT JOINTS

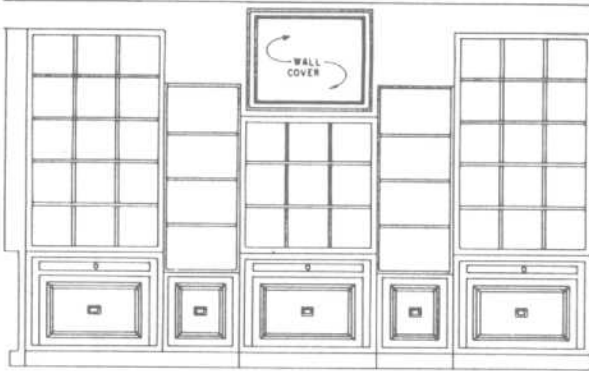


Section 4

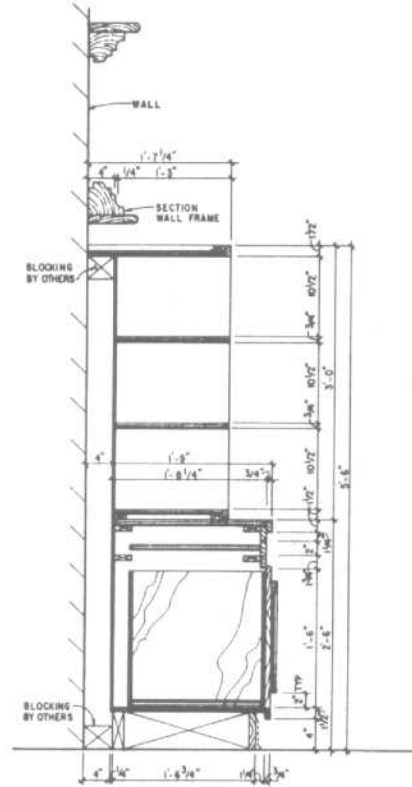
Section 3



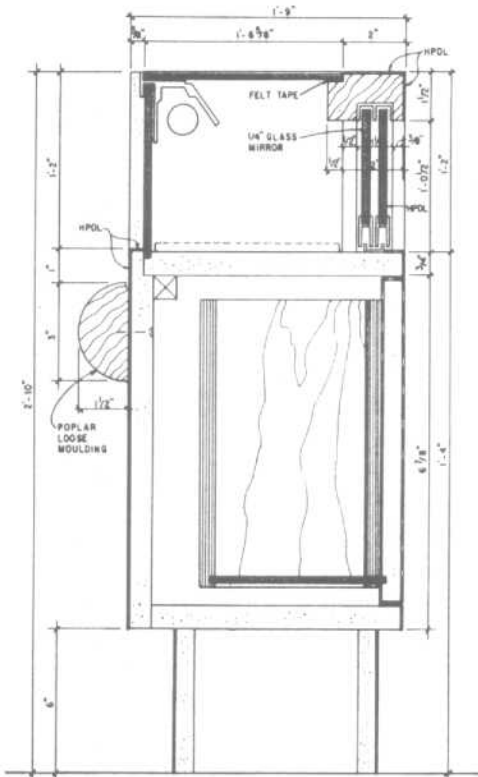
Section 5



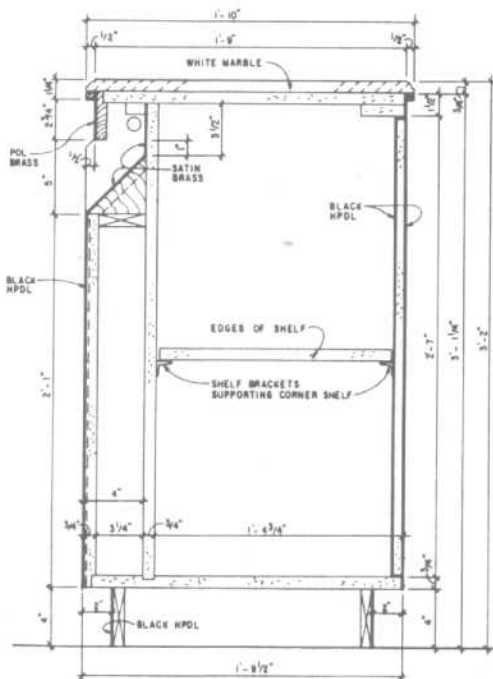
ELEVATION-SHIRT DISPLAY CASE



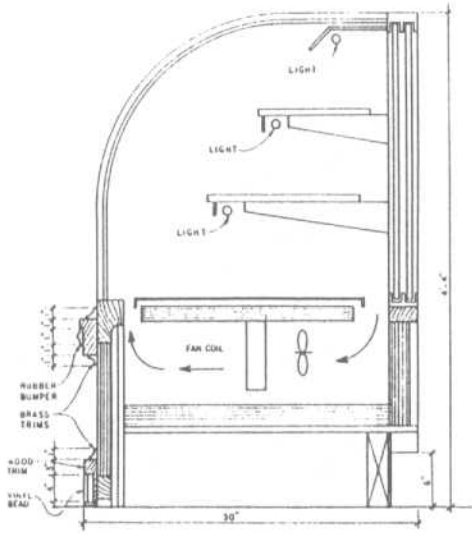
VERTICAL SECTION SHIRT DISPLAY



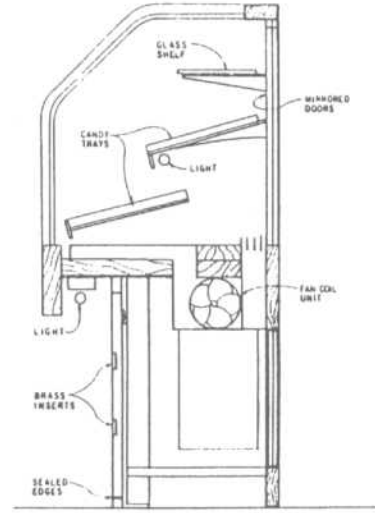
VERTICAL SECTION JEWELRY SHOWCASE



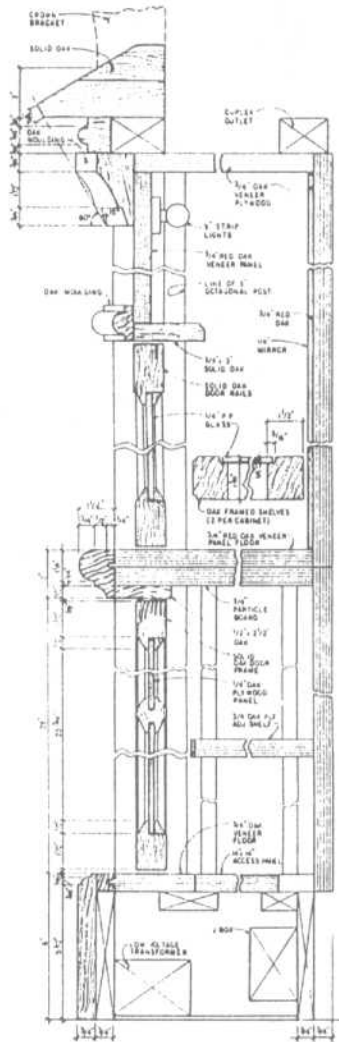
VERTICAL SECTION COSMETIC DISPLAY



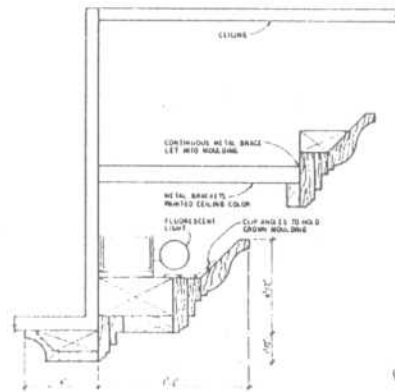
REFRIGERATED CASE



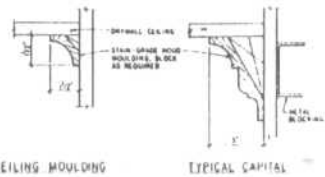
REFRIGERATED CASE



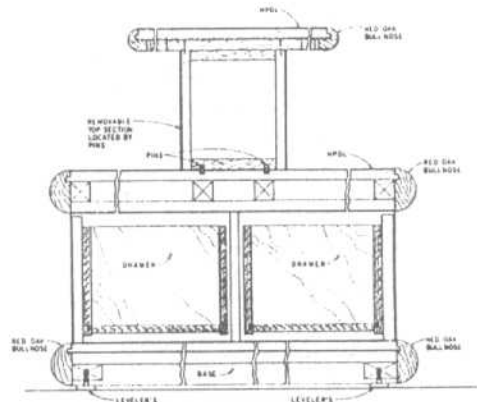
CROSS SECTION-DISPLAY CABINET



CEILING MOULDING



TYPICAL TRIM

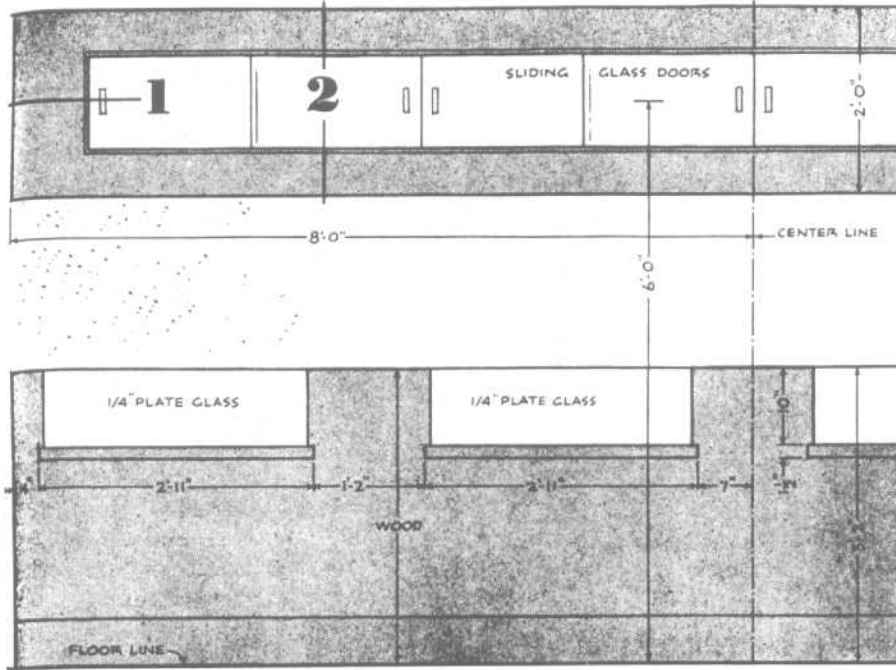


ISLAND DISPLAY

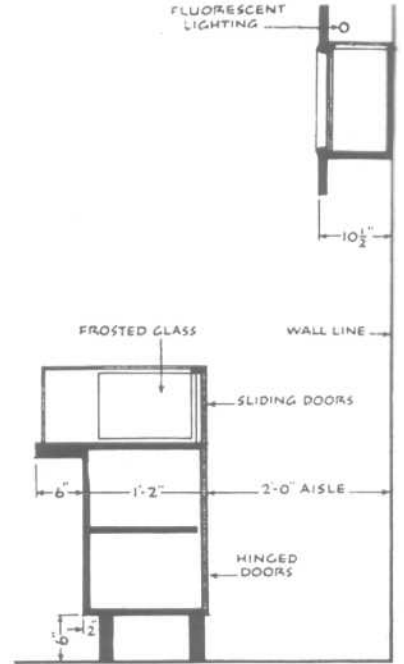


SHOPS

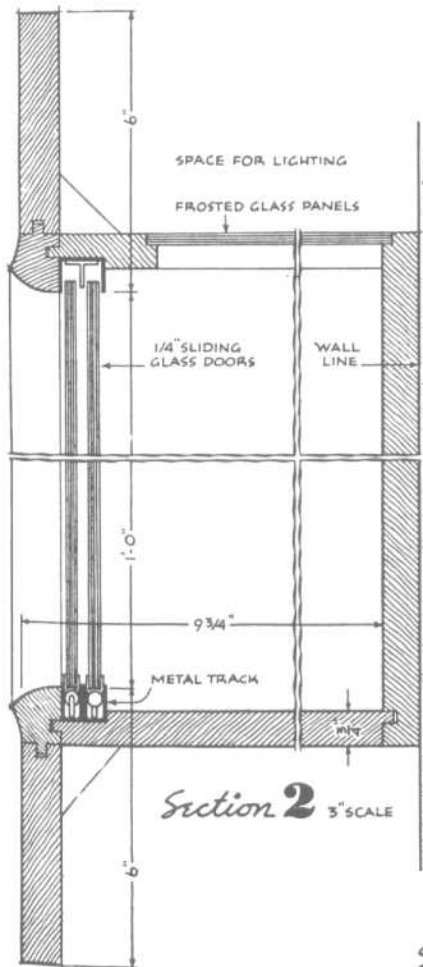
Sales Counter



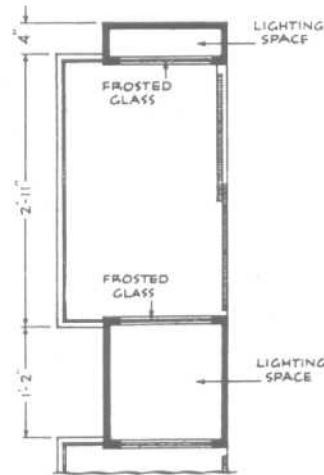
Half Elevation 1/2" SCALE



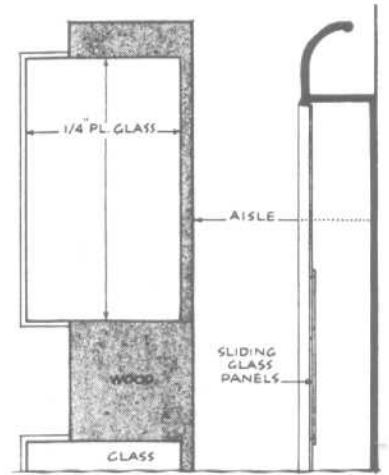
Section 1/2" SCALE



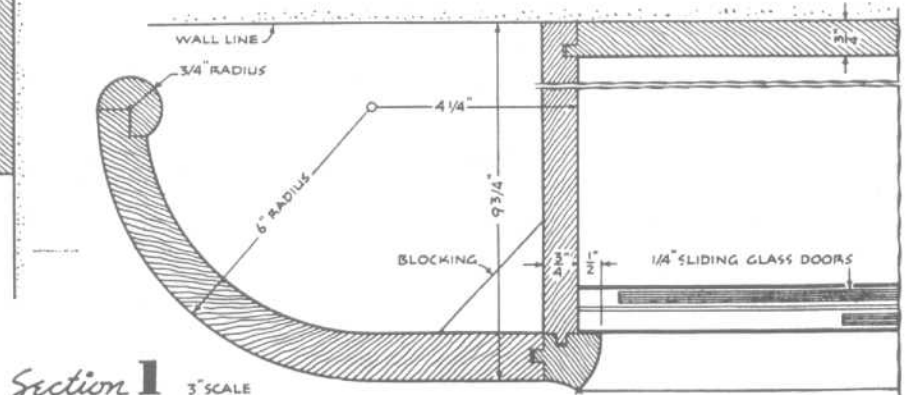
Section 2 3" SCALE



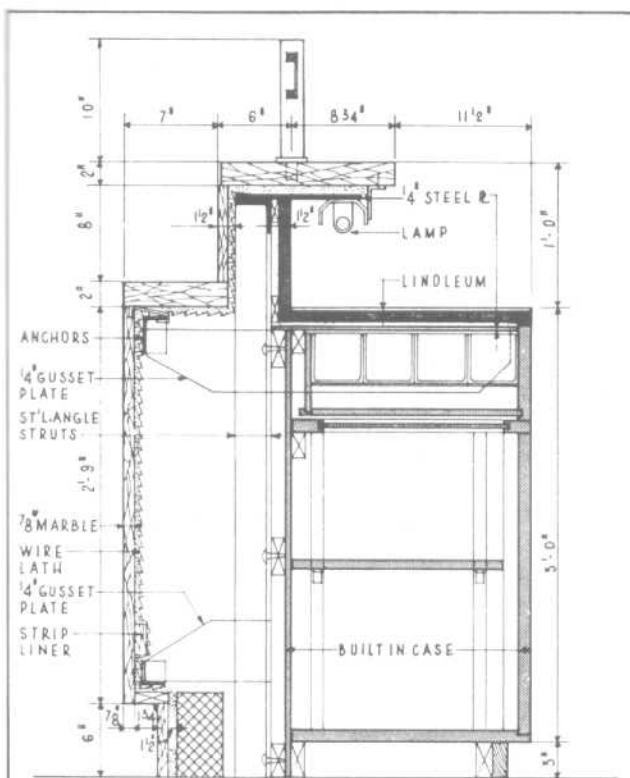
Plan thru Counter



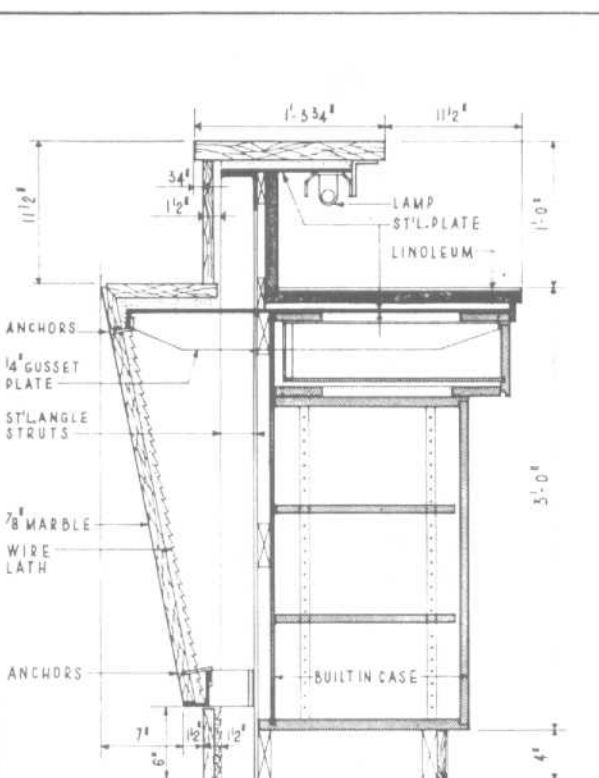
Plan above Counter



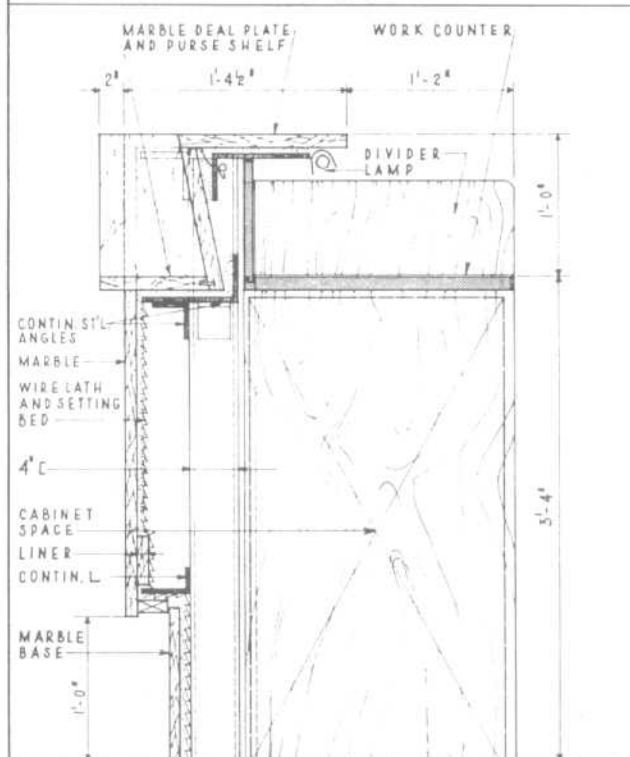
Section 1 3" SCALE



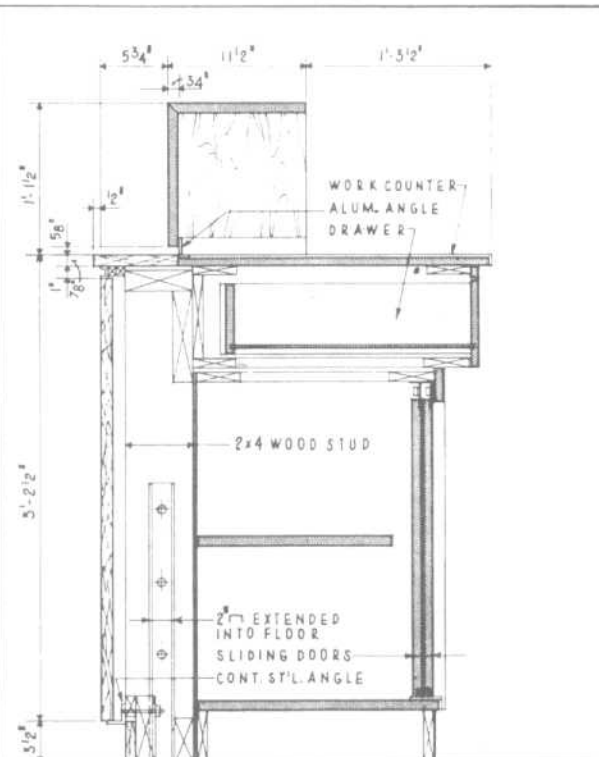
COUNTER WITH VERTICAL FRONT  
34"=1'-0"



COUNTER WITH SLOPING FRONT  
34"=1'-0"



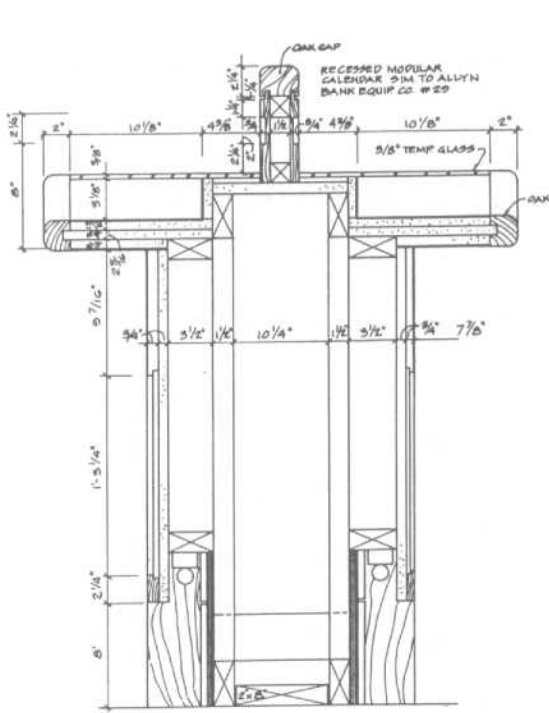
COUNTER WITH RECESSED PURSE SHELF  
34"=1'-0"



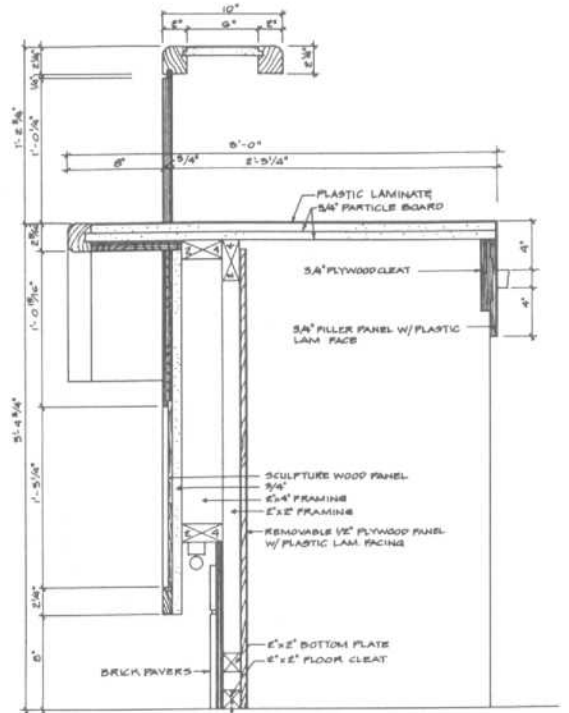
COUNTER ON WOOD FRAMING  
34"=1'-0"

**BANKS**

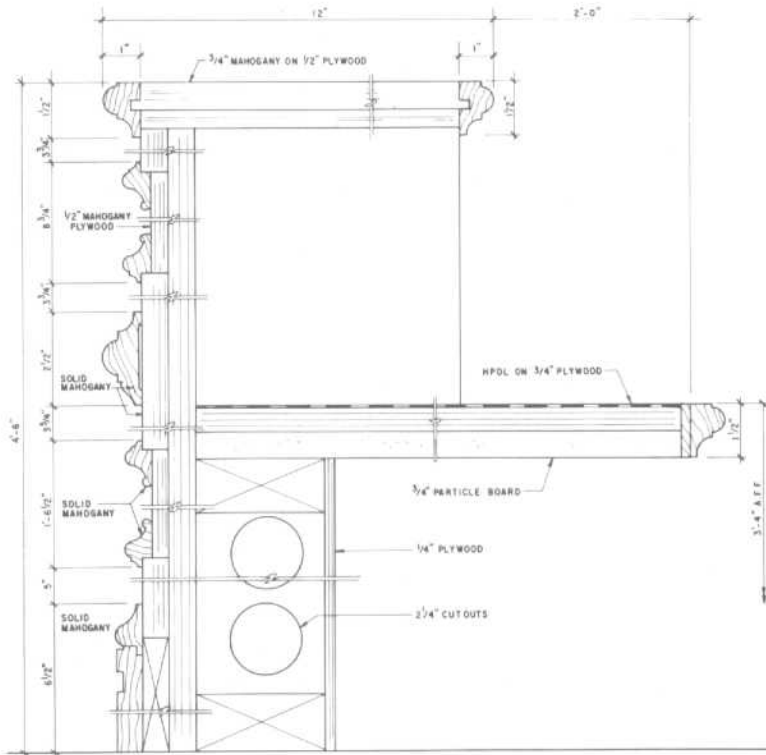
Teller's Counter



SECTION AT CHECK DESK  
(DEPOSIT SLIP AREA)



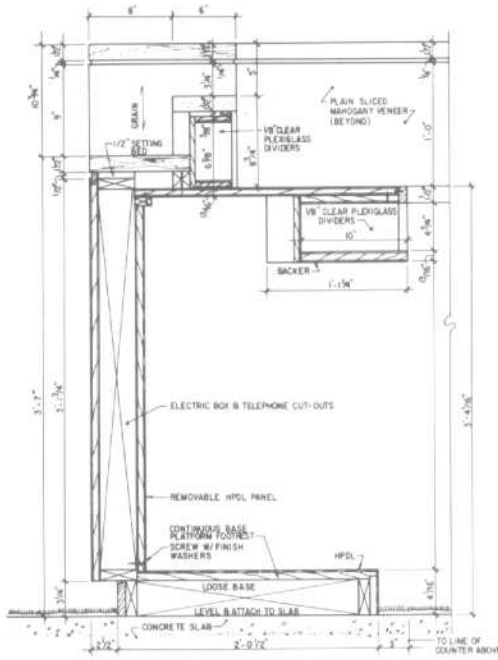
SECTION AT TELLER COUNTER



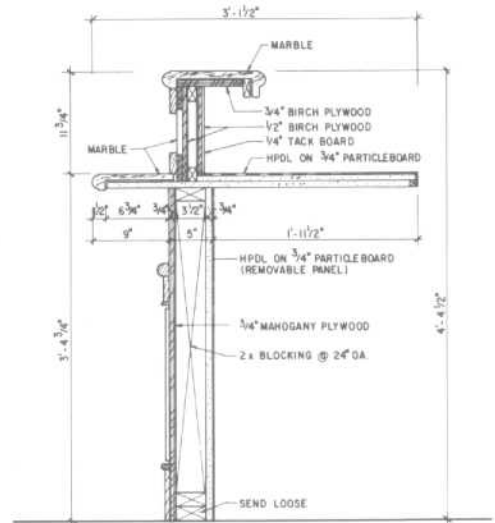
VERTICAL SECTION AT TELLERS COUNTER



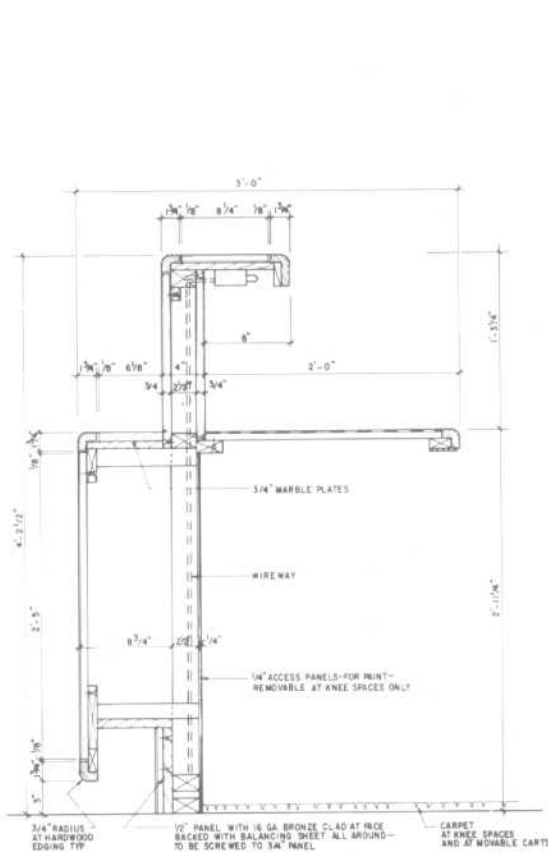




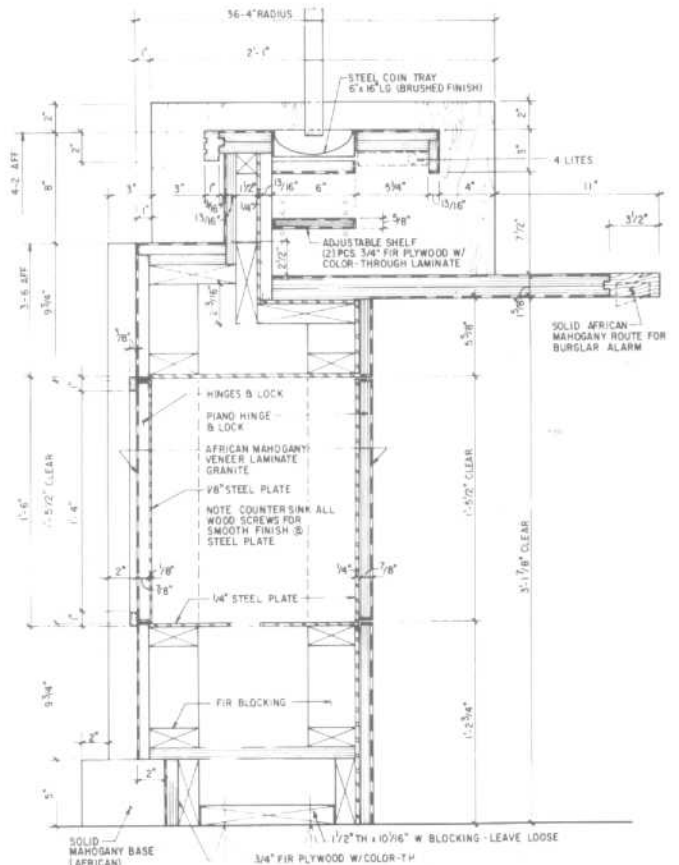
VERTICAL SECTION-TELLERS COUNTER



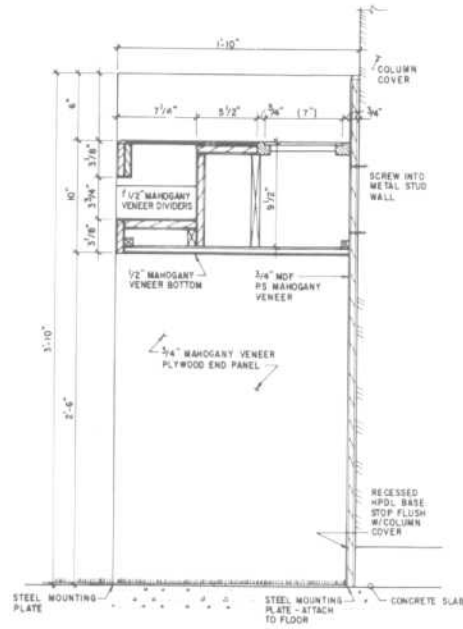
VERTICAL SECTION OF TELLERS COUNTER



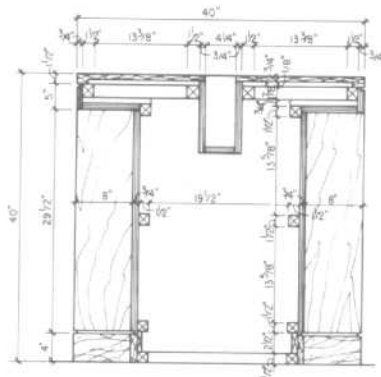
VERTICAL SECTION AT TELLERS COUNTER



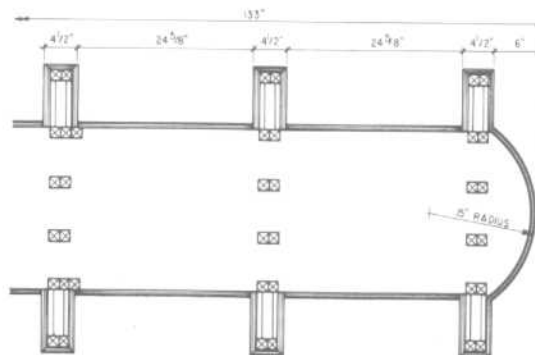
SECTION AT TELLERS COUNTER



VERTICAL SECTION AT CHECK STAND



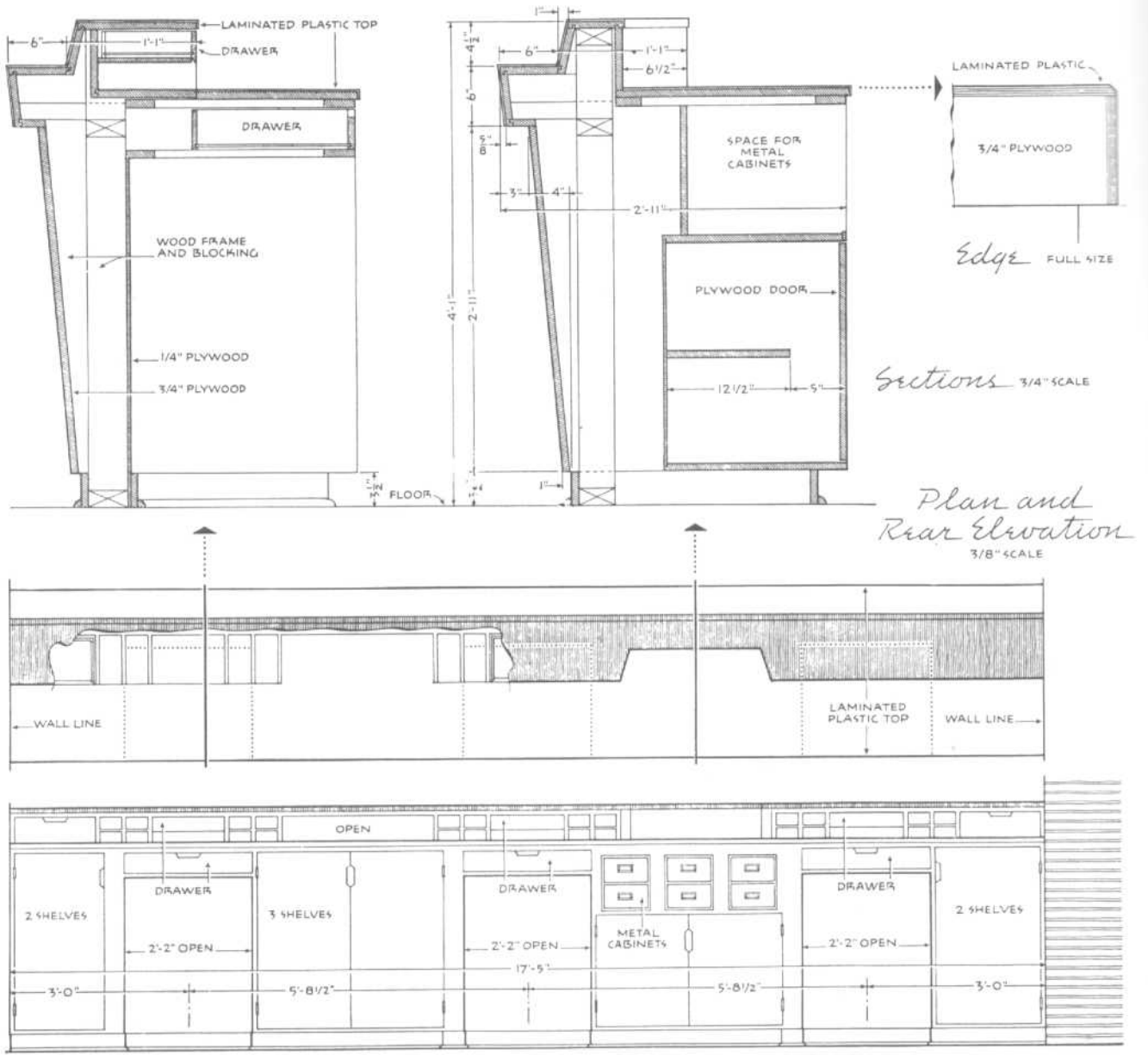
VERTICAL SECTION AT CHECK DESK

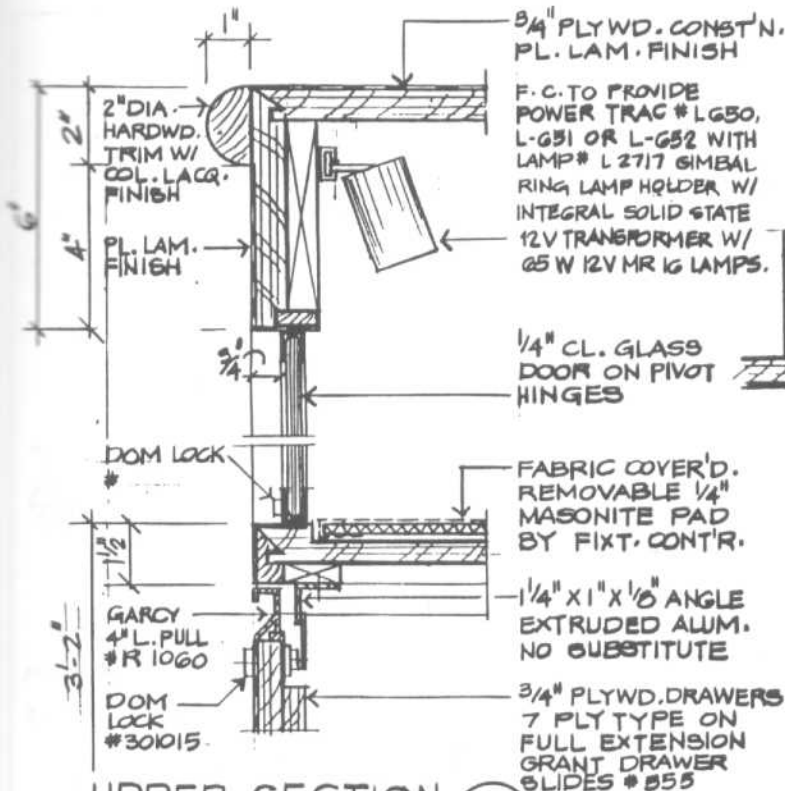


HALF PLAN THRU CHECK DESK

BANKS

Counter

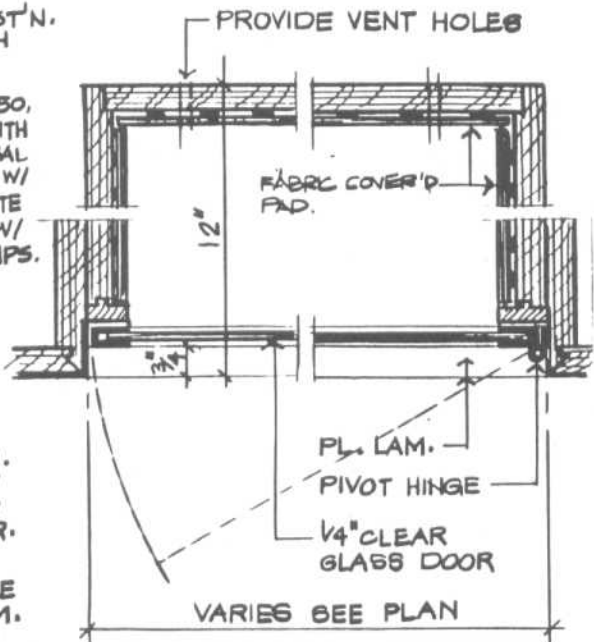




UPPER SECTION A

SCALE: 3" = 1'-0"

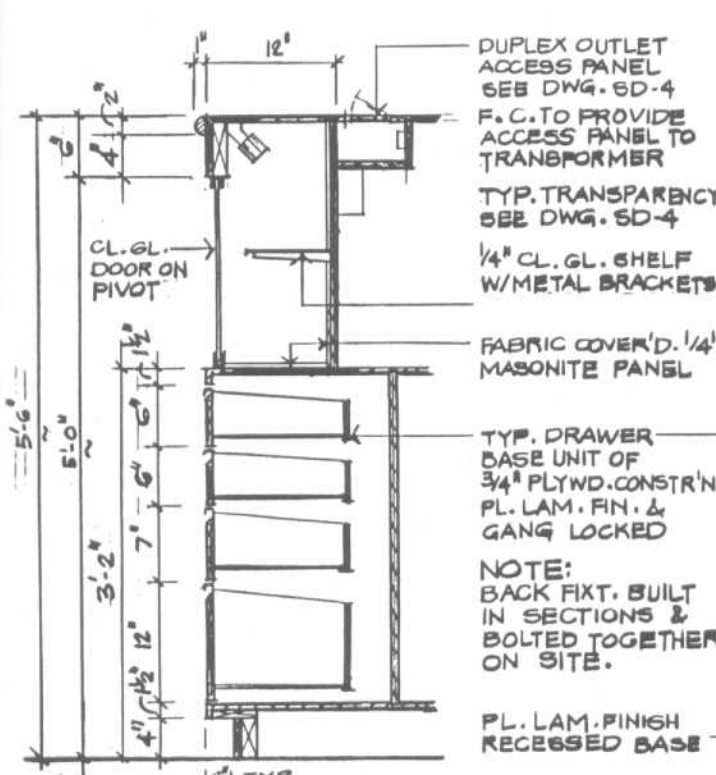
(A)



PLAN SECTION B

SCALE: 3" = 1'-0"

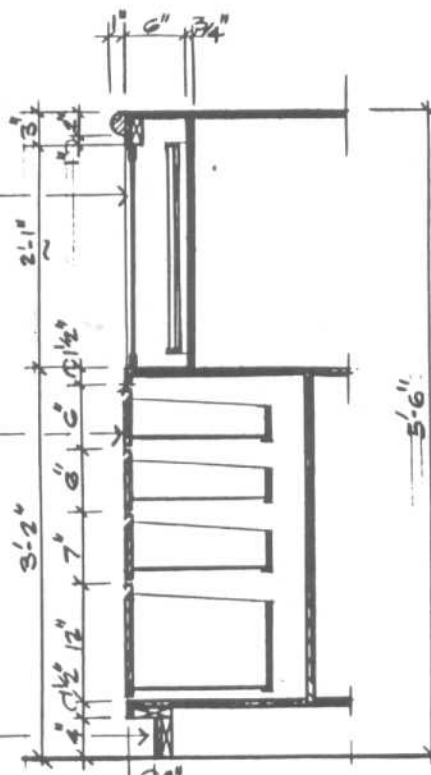
(B)



SECTION 1

SCALE: 3/4" = 1'-0"

(1)



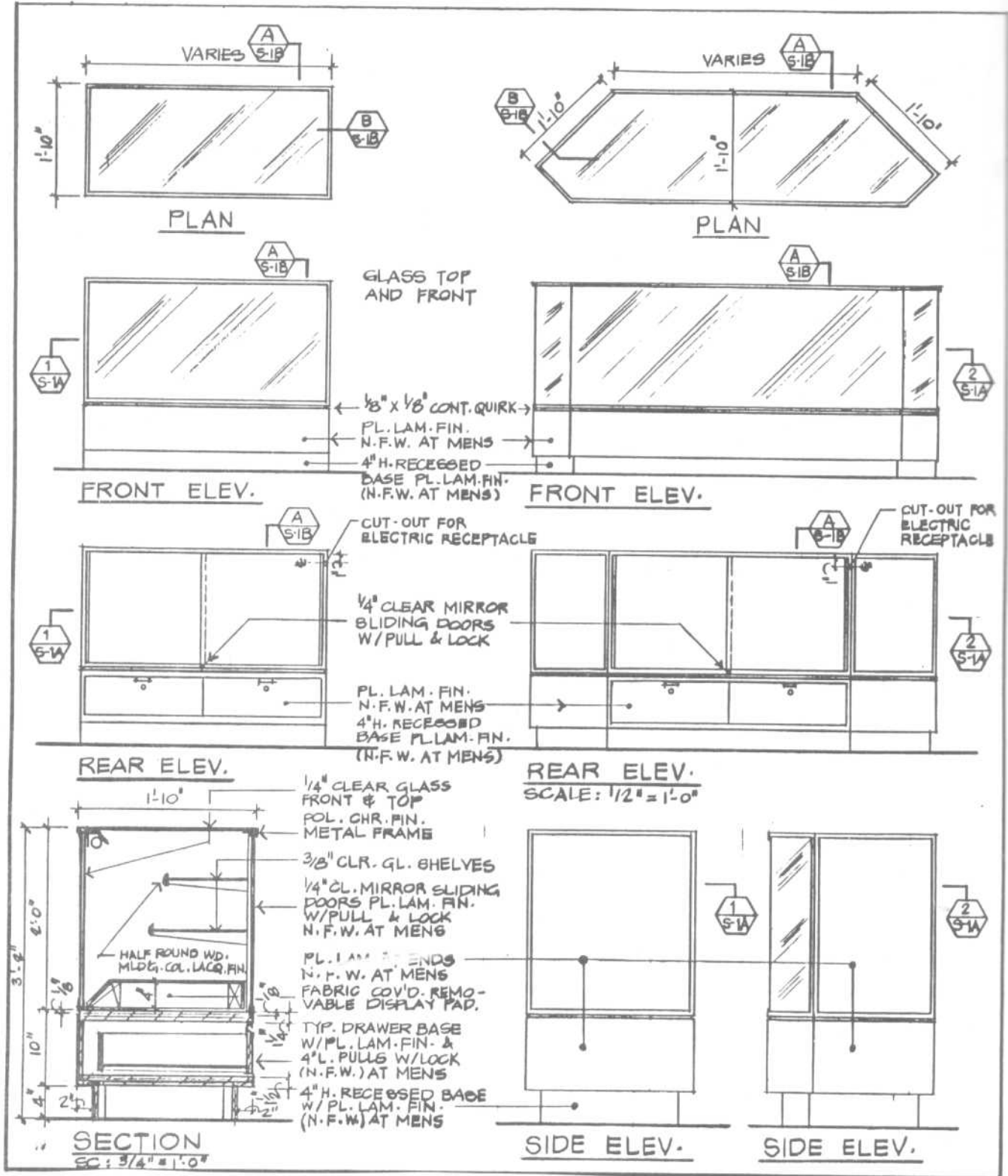
SECTION 2

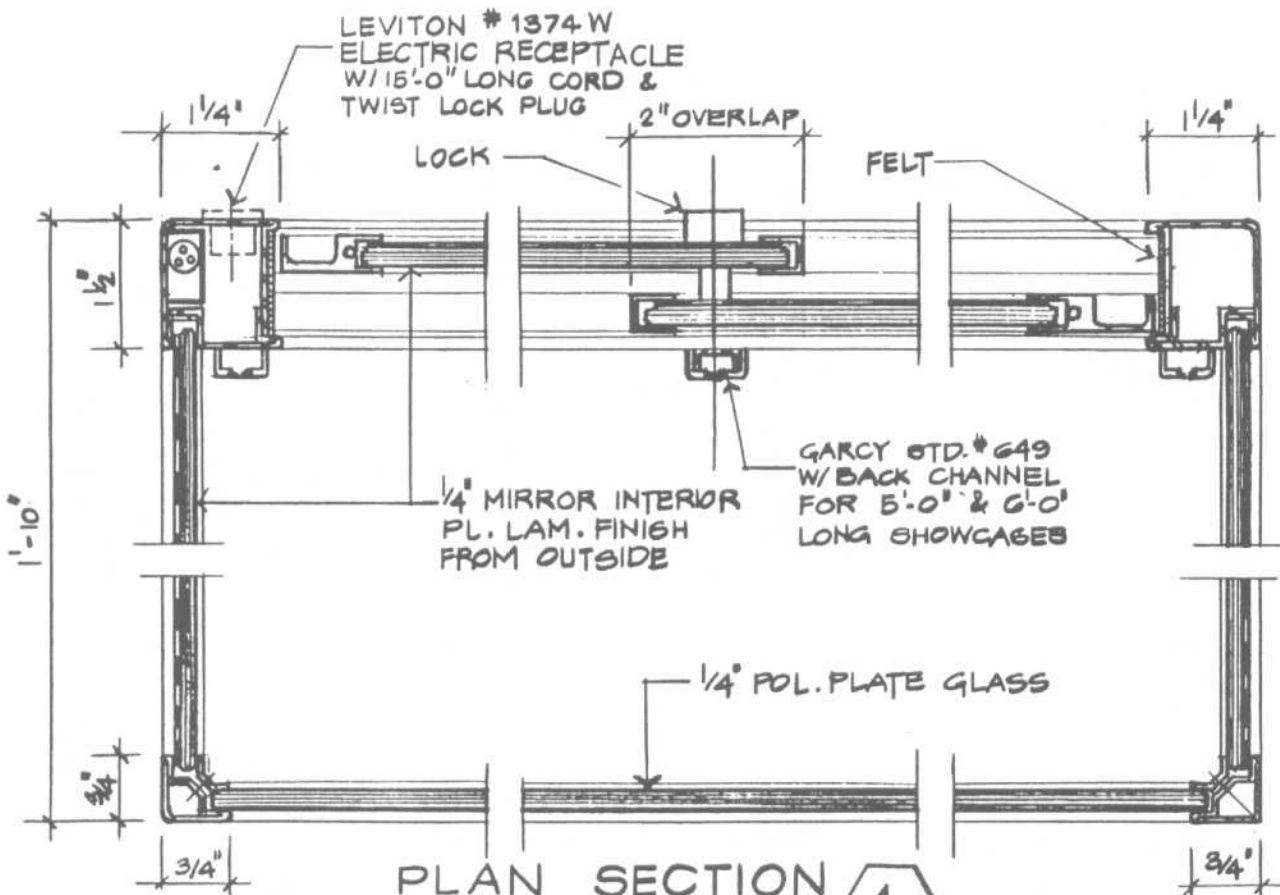
SCALE: 3/4" = 1'-0"

(2)

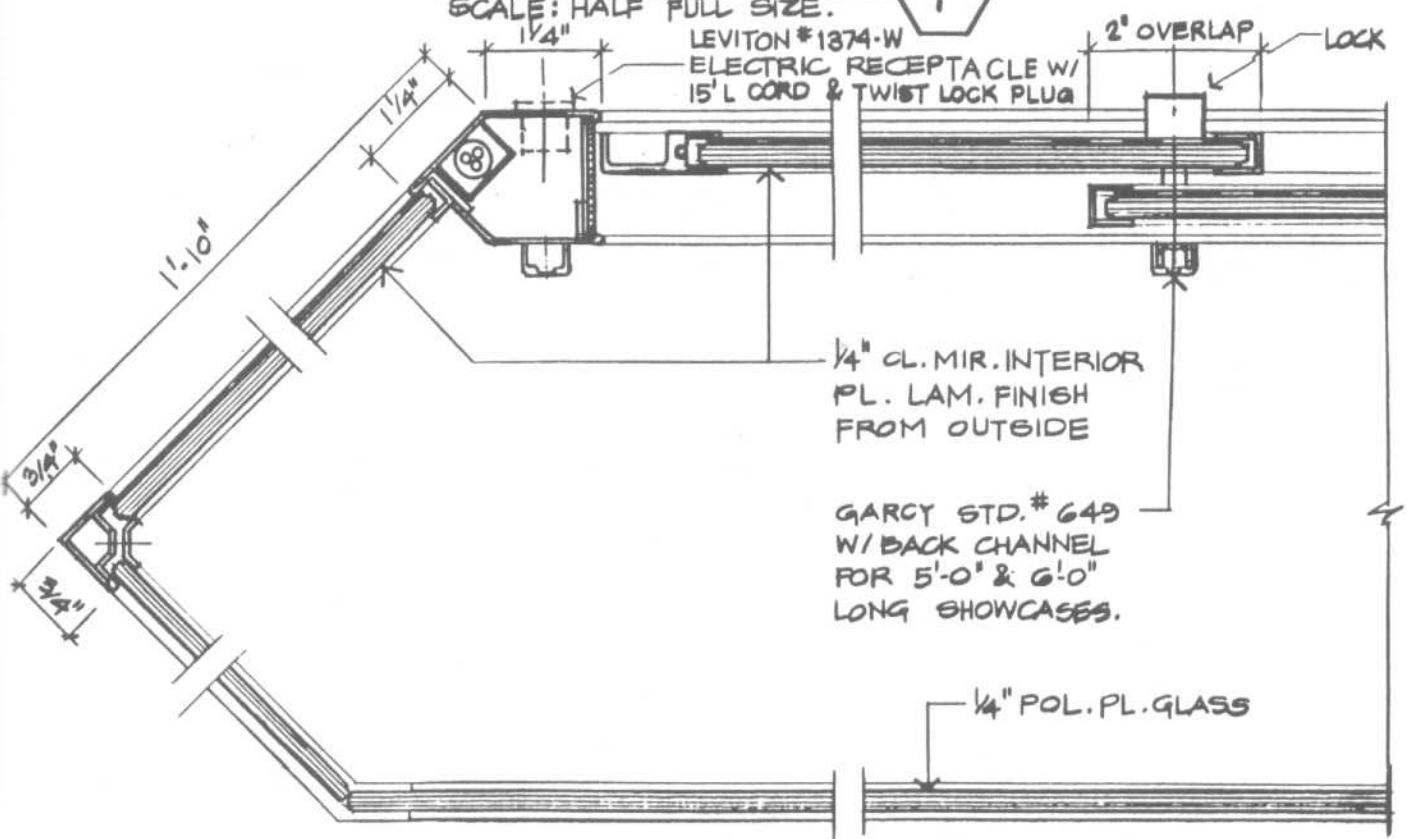
DEPARTMENT STORES

Showcase for Men's Cosmetics and Fragrances





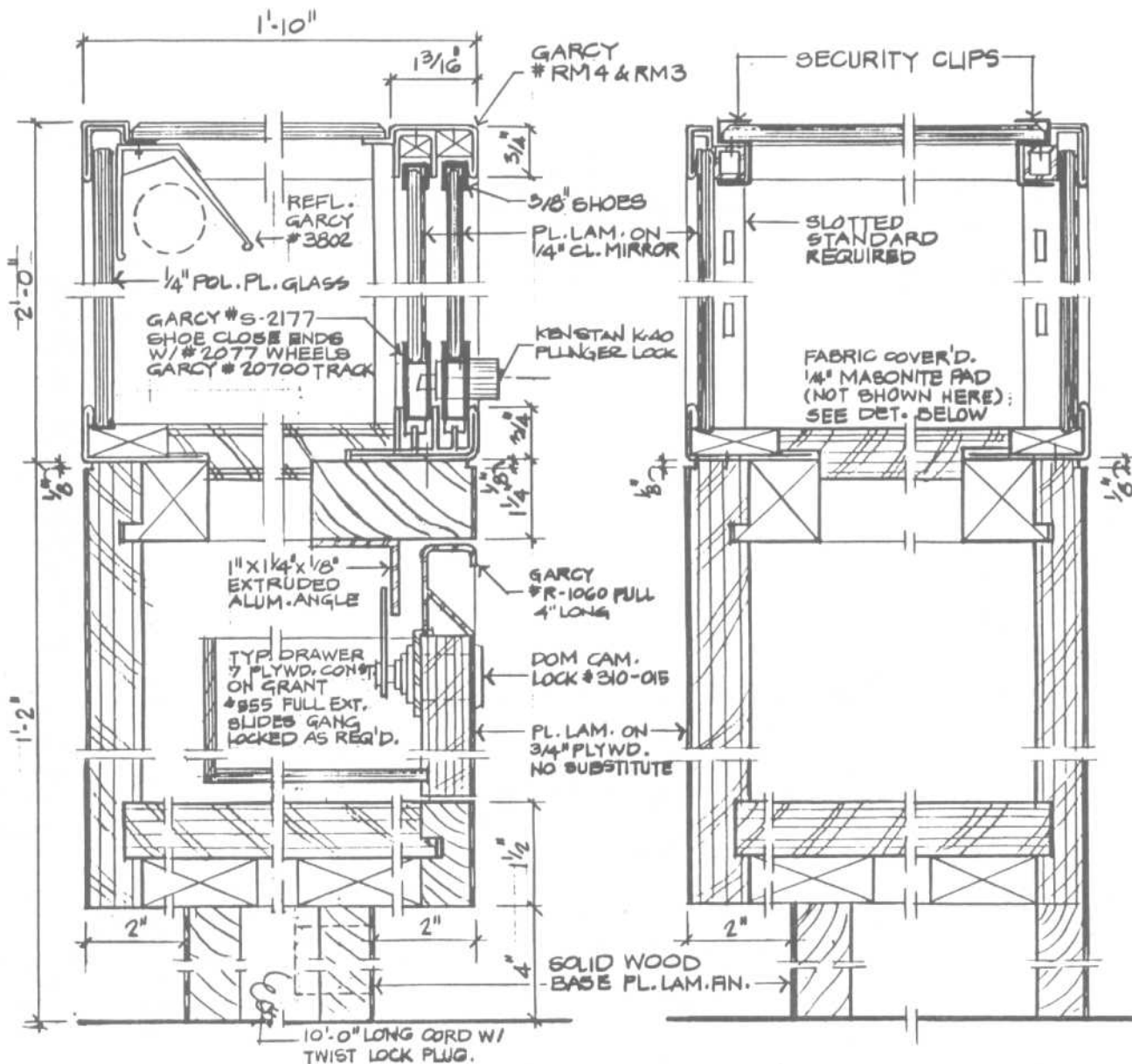
**PLAN SECTION 1**  
SCALE: HALF FULL SIZE.



**PLAN SECTION 2**  
SCALE: HALF FULL SIZE.

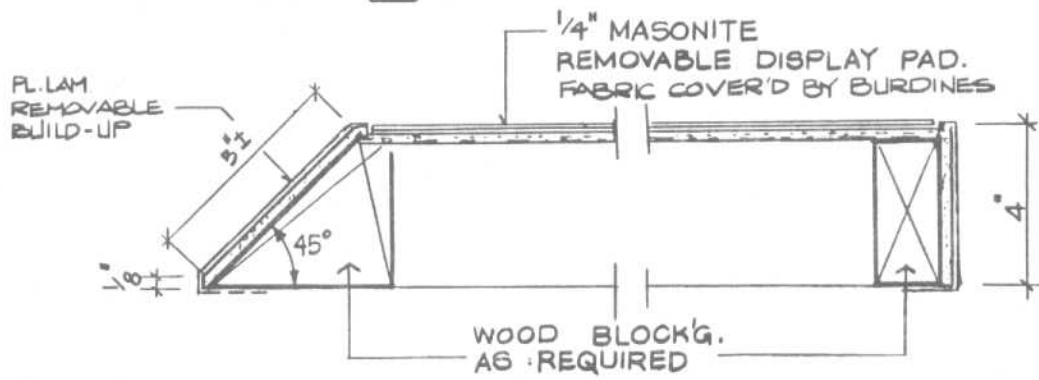
DEPARTMENT STORES

Showcase for Men's Cosmetics and Fragrances



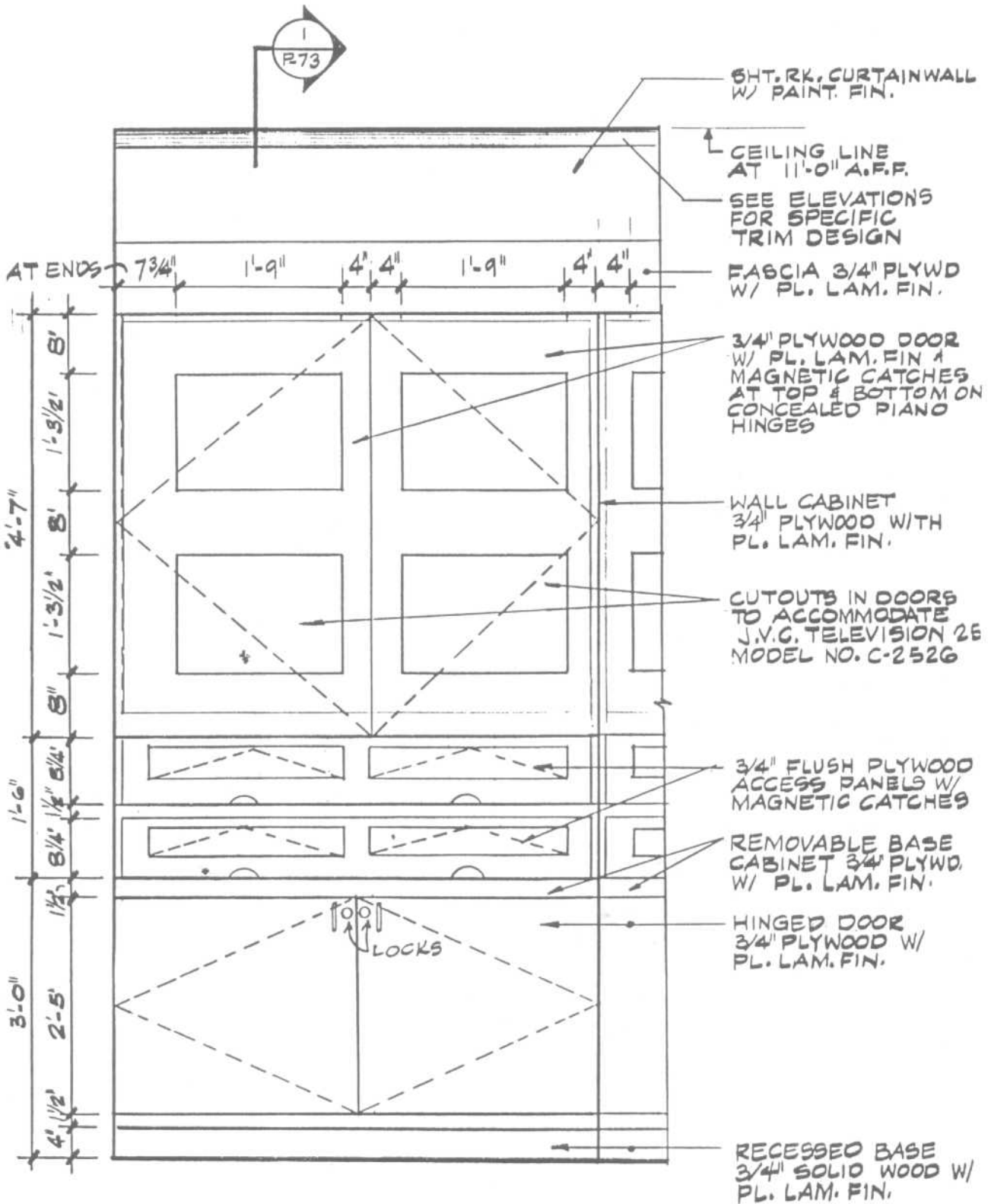
SECTION A  
SCALE: 3/4" = 1'-0"

LONG. SECT. B  
SCALE: 3/4" = 1'-0"



DISPLAY PAD DETAIL  
SCALE: 1/4" = ONE INCH



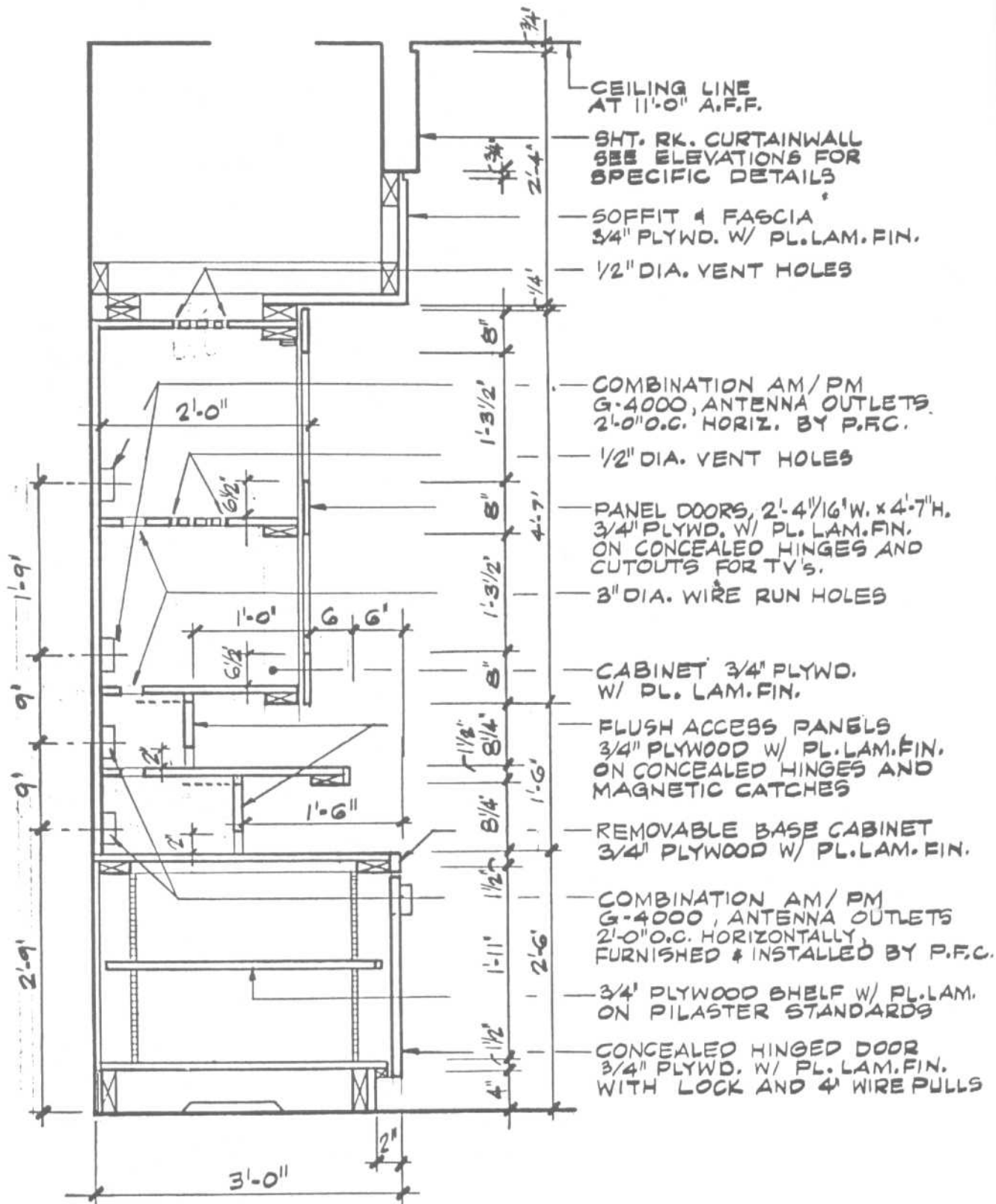


ELEVATION

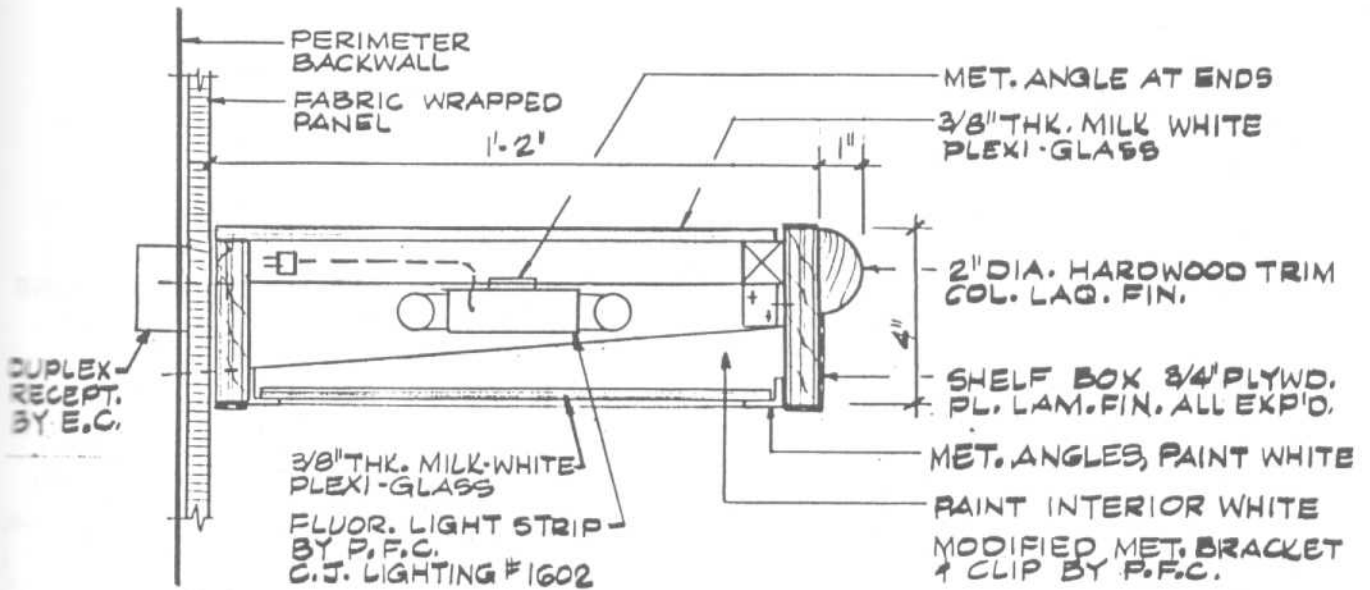
SCALE: 3/4" = 1'-0"

DEPARTMENT STORES

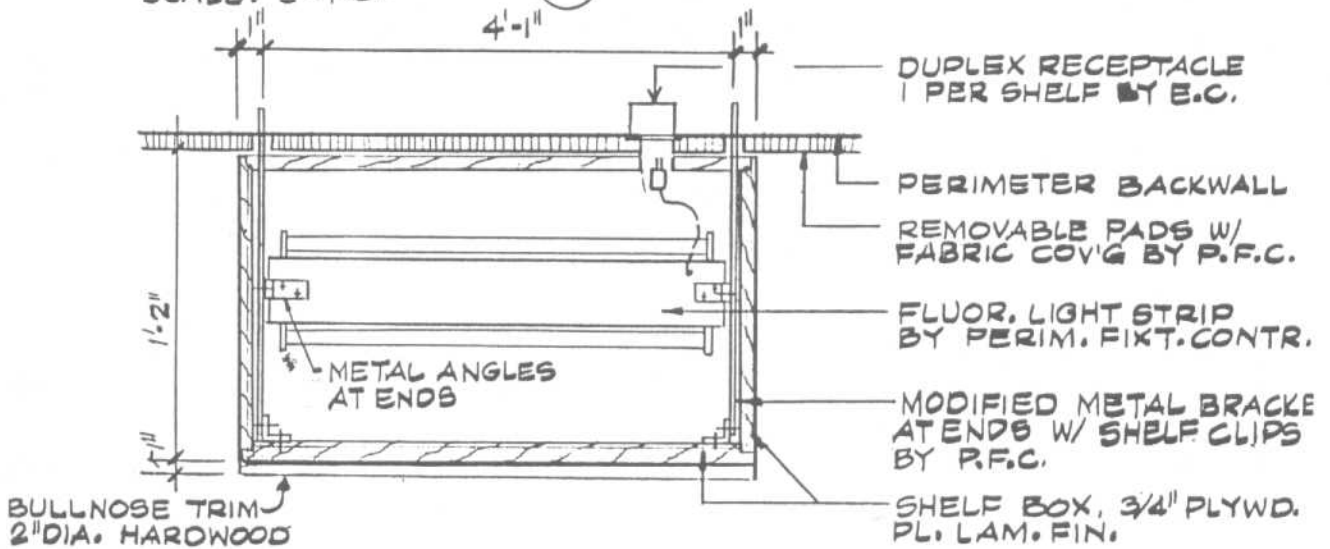
Television Cabinet Details



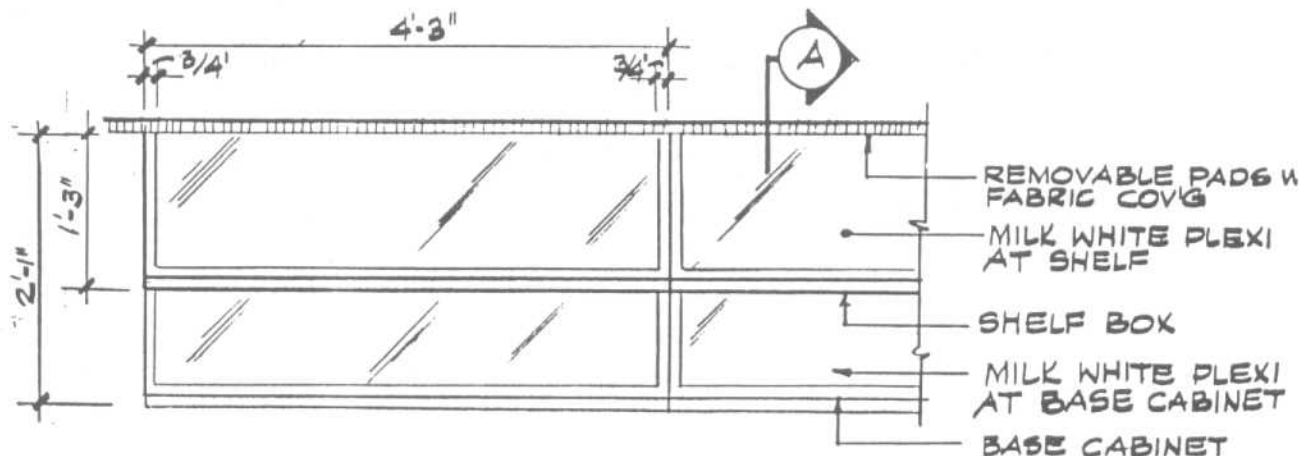
SECTION 1  
SCALE: 3/4"=1'-0"



**SHELF DETAIL (A)**  
SCALE: 3/8" = 1'-0"

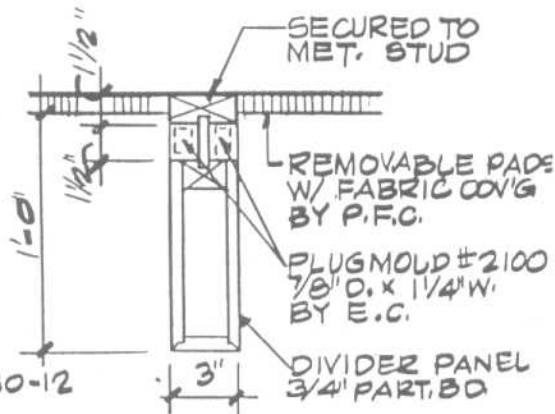
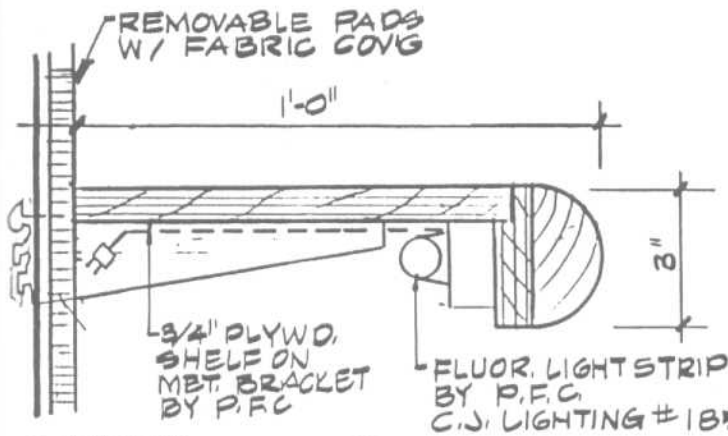


**PLAN SECTION @ SHELF (B)**  
SCALE: 1/2" = 1'-0"



**PLAN WHERE SHELVES ABUTT**  
SCALE: 3/4" = 1'-0"





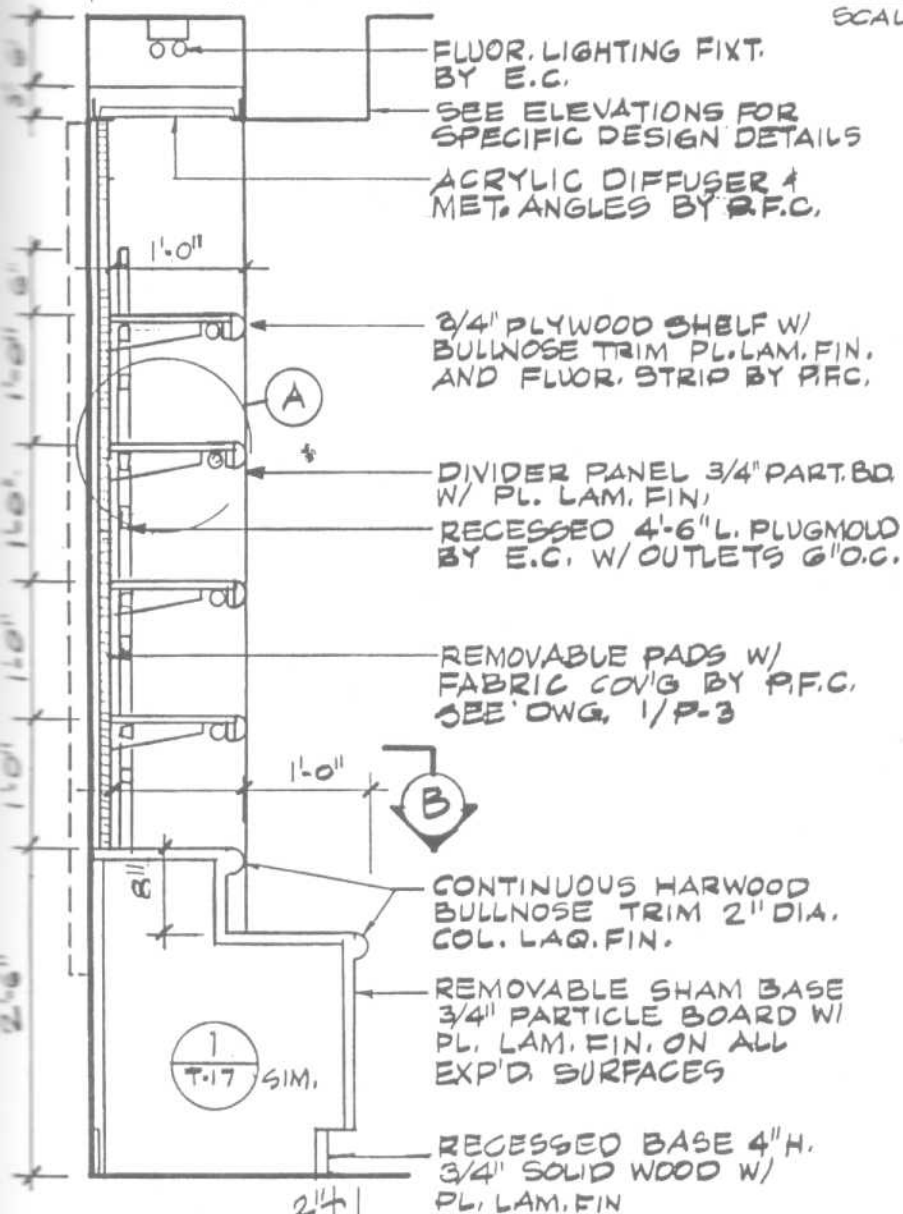
DETAIL

SCALE: 1/2" = 1'-0"



DETAIL

SCALE: 1/2" = 1'-0"

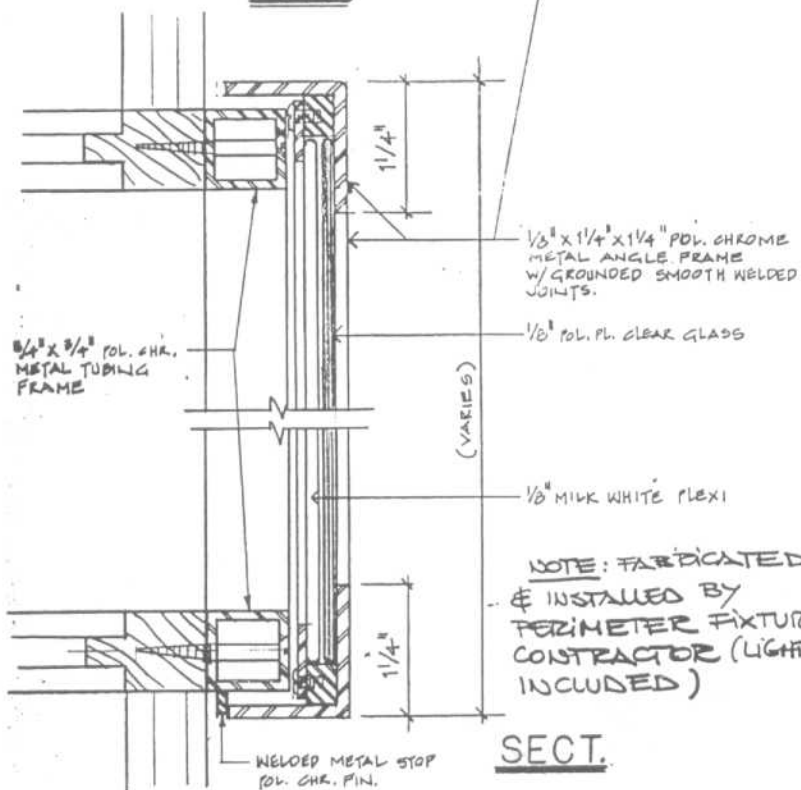
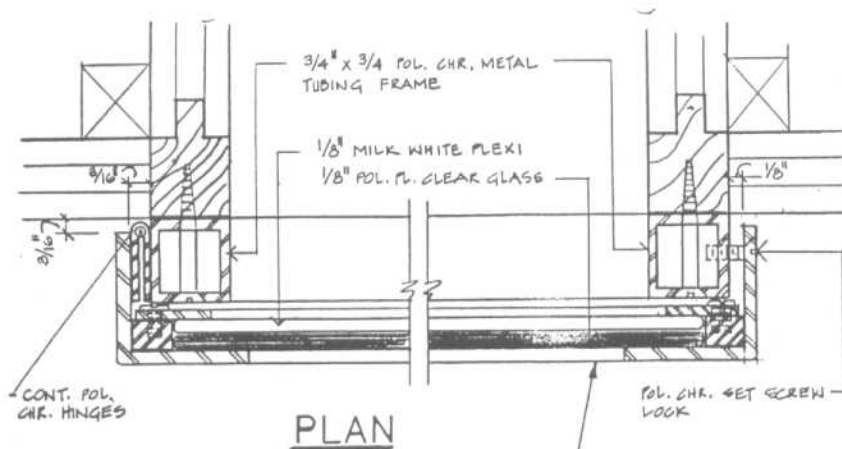


SECTION

SCALE: 3/4" = 1'-0"



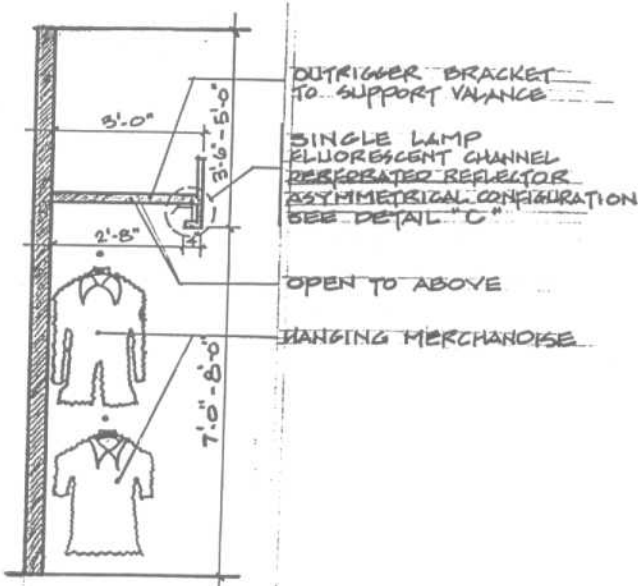




TYPICAL TRANSPARENCY DETAIL

DEPARTMENT STORES

Feature Wall Lighting



OUTRIGGER BRACKET TO SUPPORT VALANCE

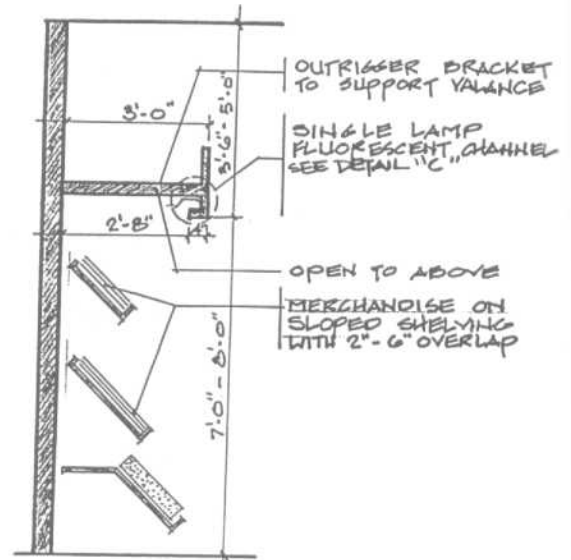
SINGLE LAMP FLUORESCENT CHANNEL PERFORATED REFLECTOR ASYMMETRICAL CONFIGURATION SEE DETAIL "C"

OPEN TO ABOVE

HANGING MERCHANDISE

SECTION

SINGLE/DOUBLE HANG-ROD WITH OPEN VALANCE



OUTRIGGER BRACKET TO SUPPORT VALANCE

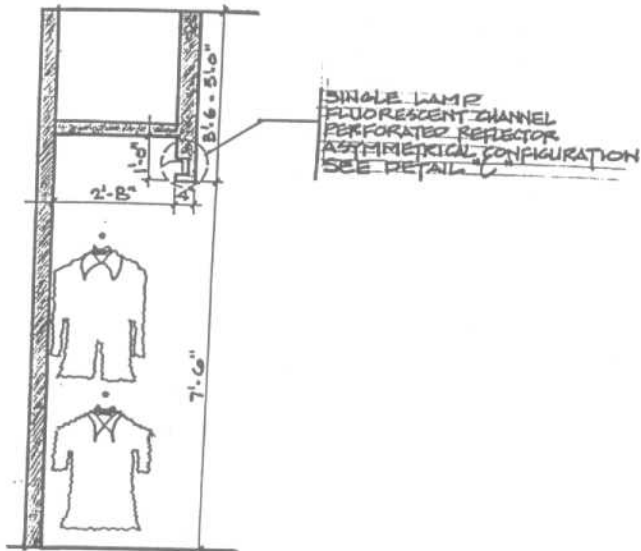
SINGLE LAMP FLUORESCENT CHANNEL SEE DETAIL "C"

OPEN TO ABOVE

MERCHANDISE ON SLOPED SHELVING WITH 2'-6" OVERLAP

SECTION

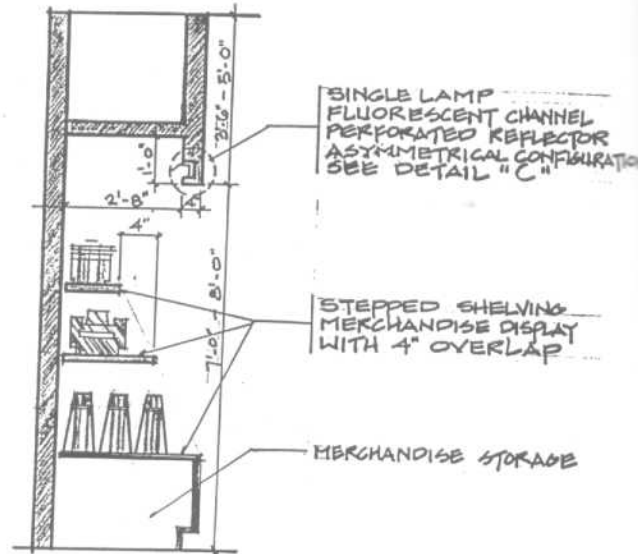
SLOPED SHELVING WITH OPEN VALANCE



SINGLE LAMP FLUORESCENT CHANNEL PERFORATED REFLECTOR ASYMMETRICAL CONFIGURATION SEE DETAIL "C"

SECTION

SINGLE/DOUBLE HANG-ROD



SINGLE LAMP FLUORESCENT CHANNEL PERFORATED REFLECTOR ASYMMETRICAL CONFIGURATION SEE DETAIL "C"

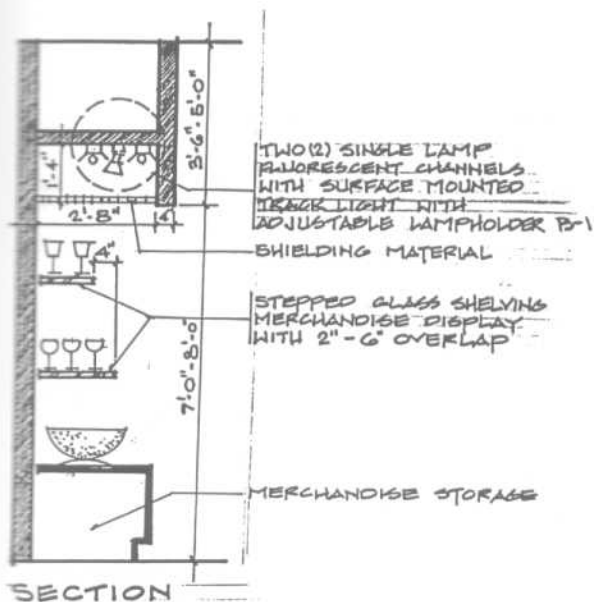
STEPPED SHELVING MERCHANDISE DISPLAY WITH 4" OVERLAP

MERCHANDISE STORAGE

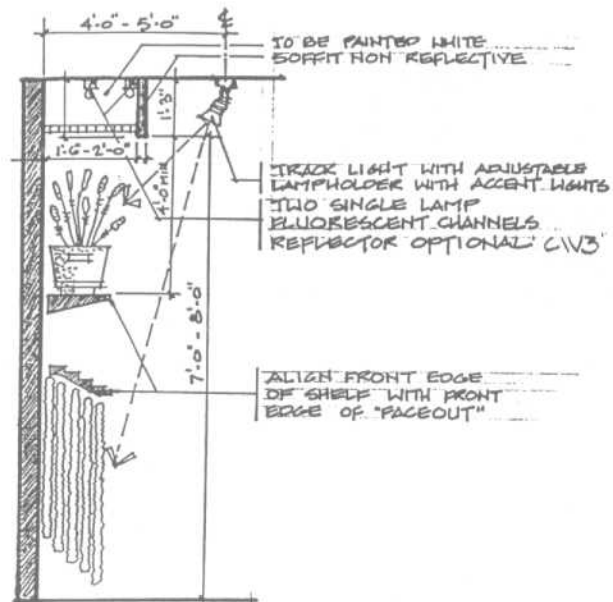
SECTION

STEPPED SHELVING MERCHANDISE DISPLAY

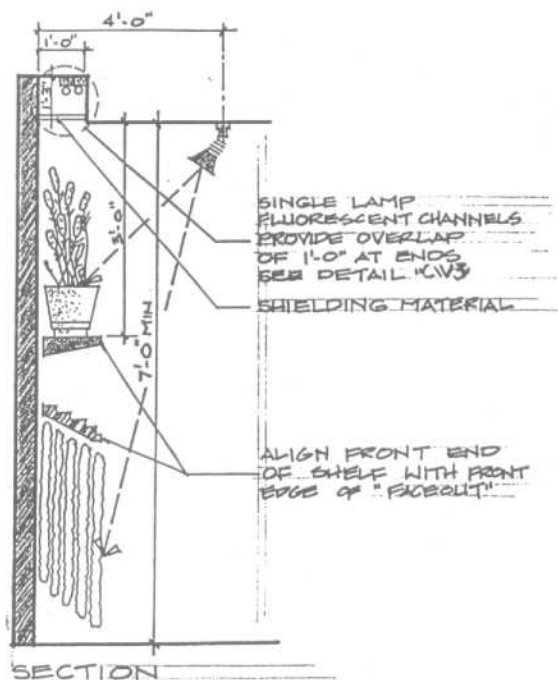




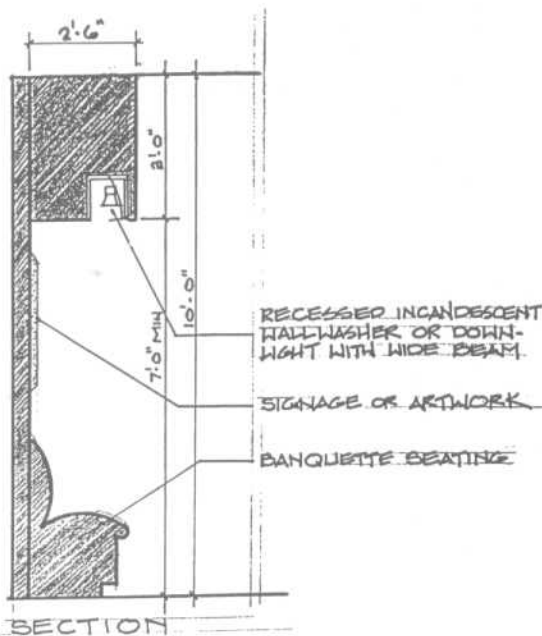
STEPPED SHELVING MERCHANDISE DISPLAY



FEATURE WALL DISPLAY WITH ILLUMINATED SOFFIT AND ACCENT LIGHT

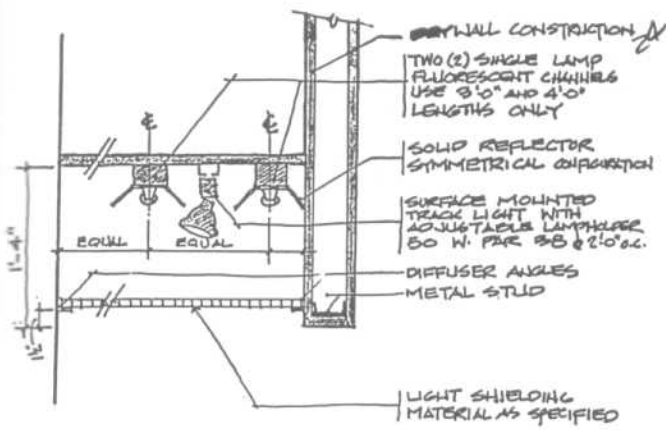


FEATURE WALL DISPLAY WITH RECESSED COVE IN SOFFIT AND TRACK LIGHT

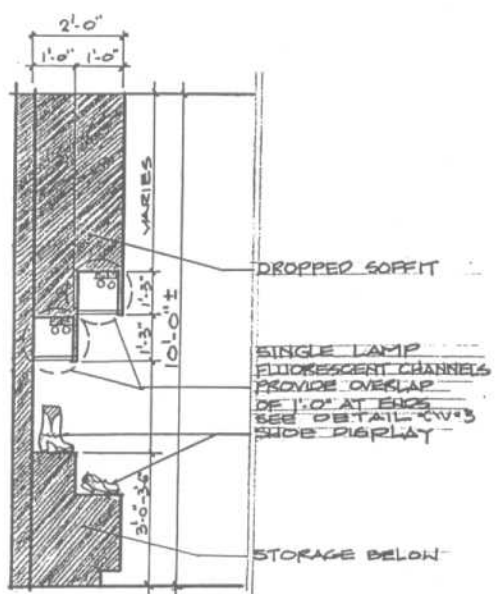


FEATURE WALL DISPLAY DROPPED SOFFIT ABOVE BANQUETTE SEATING

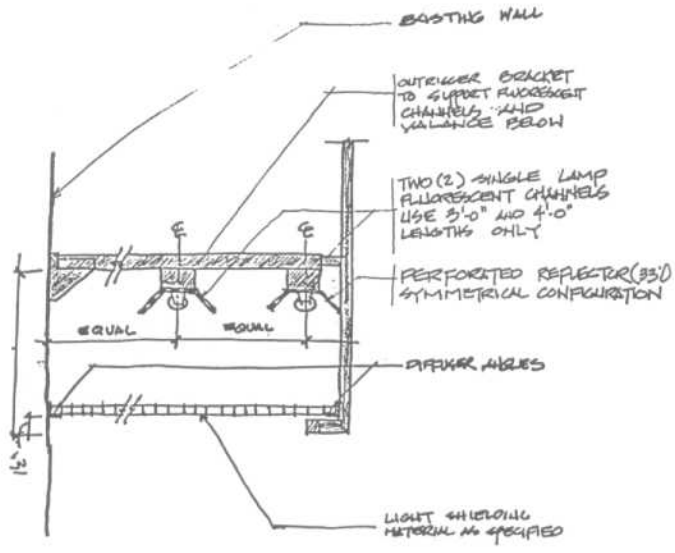




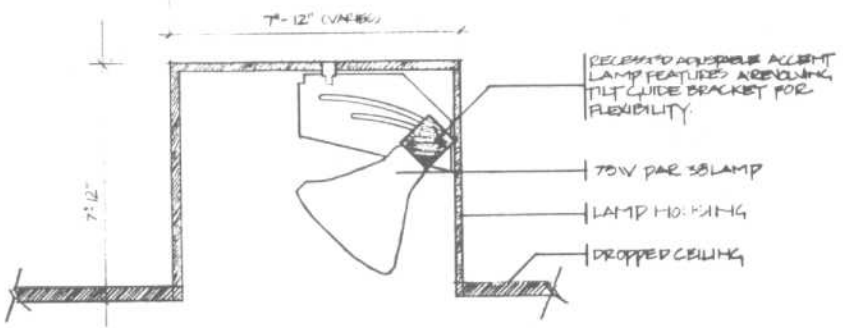
SHIELDED VALANCE WITH TWO (2) SINGLE LAMP FLUORESCENT CHANNELS AND TRACK LIGHT WITH INCANDESCENT 'CURTAIN WALL' TYPE



SECTION FEATURE WALL DISPLAY WITH DOUBLE COVE IN SOFFIT



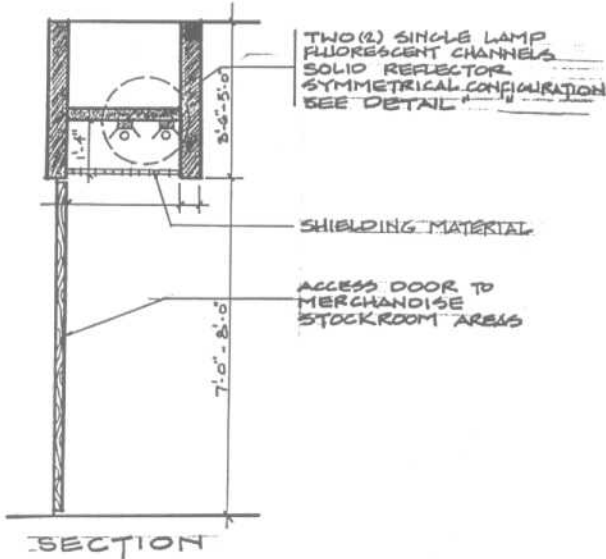
SHIELDED VALANCE WITH TWO (2) SINGLE LAMP FLUORESCENT CHANNELS



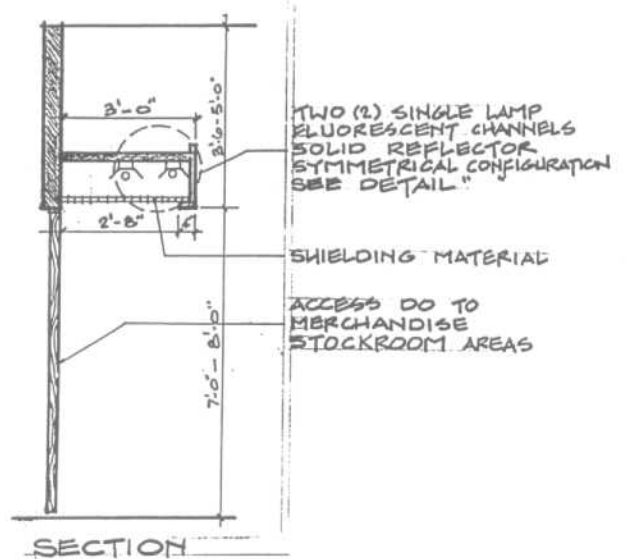
RECESSED ADJUSTABLE ACCENT LIGHT

DEPARTMENT STORES

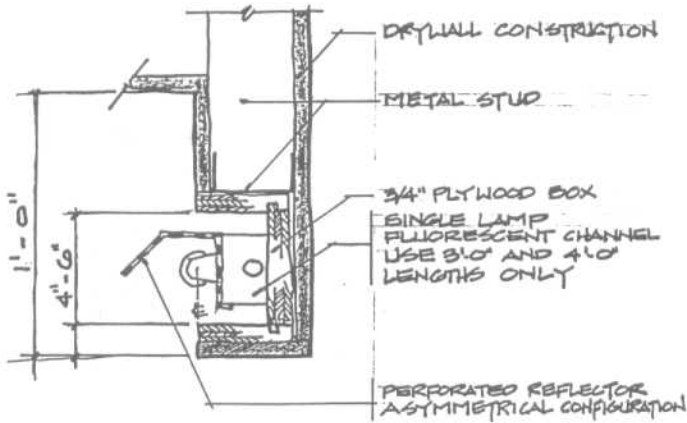
Valence and Cove Lighting Details



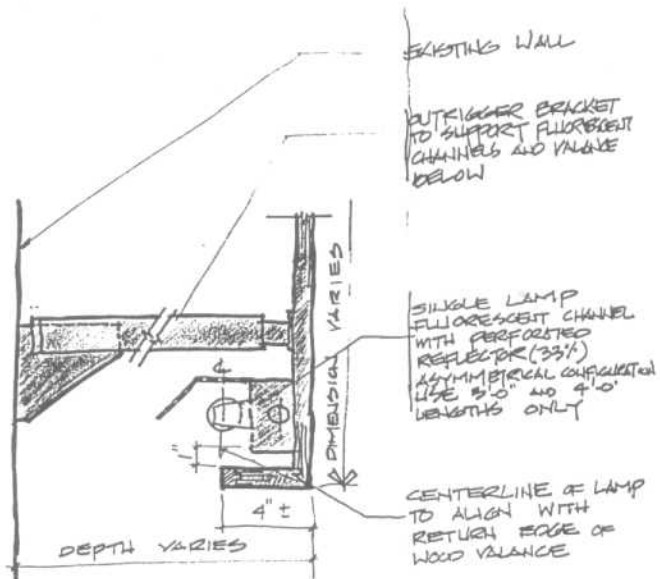
ACCESS DOOR THRU MERCHANDISE DISPLAY CURTAIN WALL



ACCESS DOOR THRU MERCHANDISE DISPLAY "OPEN VALANCE"



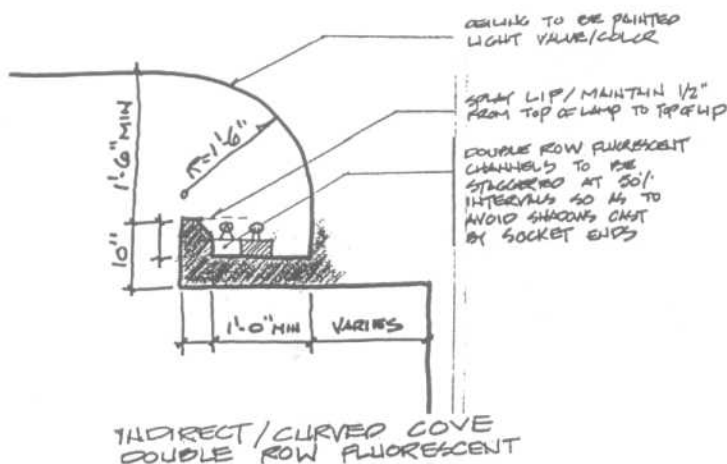
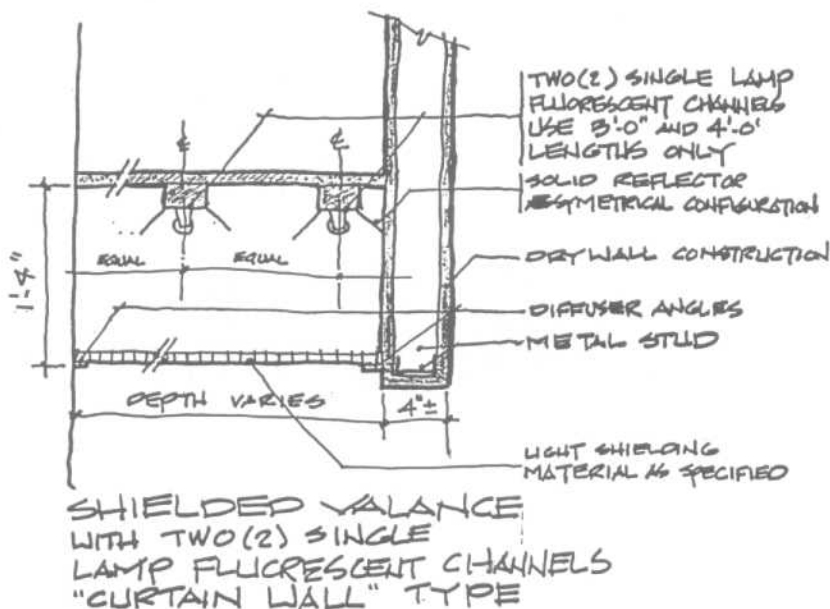
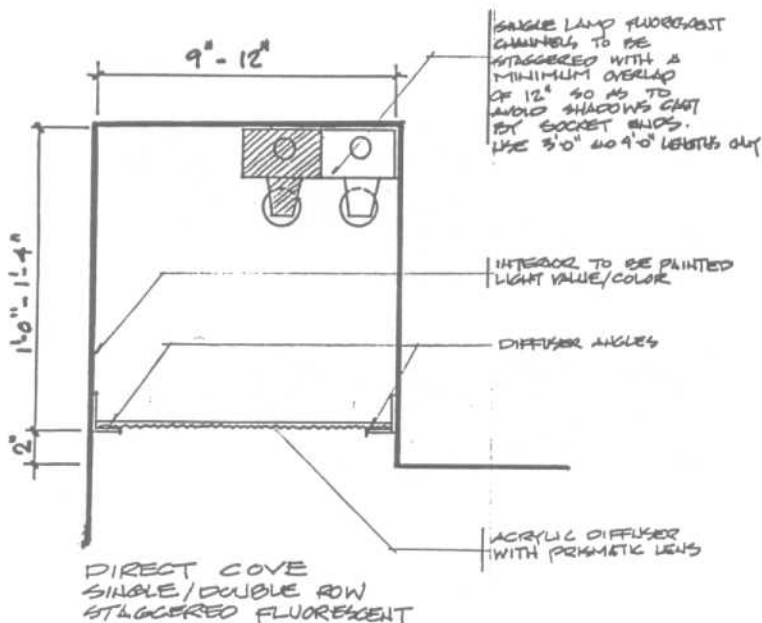
SHIELDED VALANCE WITH SINGLE LAMP FLUORESCENT CHANNEL CURTAIN WALL TYPE



VALANCE WITH SINGLE LAMP FLUORESCENT CHANNEL

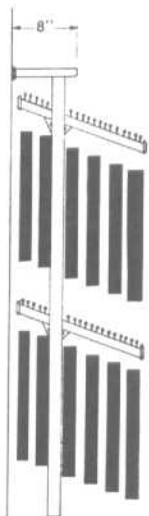
DEPARTMENT STORES

Valence and Cove Lighting Details

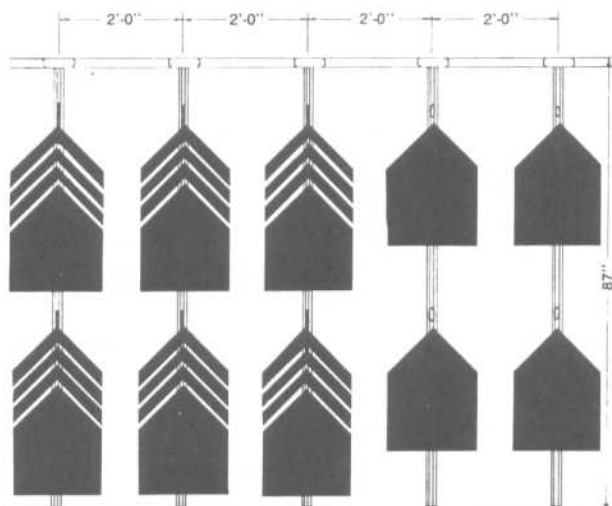


DEPARTMENT STORES

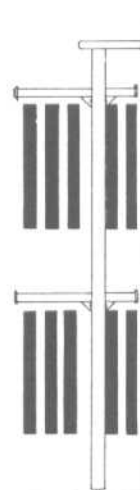
Wall Display Systems



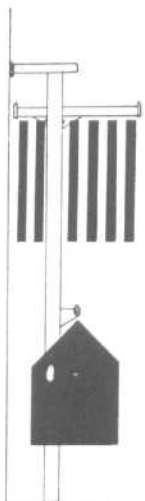
**WATERFALL**  
Average Quantity of  
Garments Per Post: 48



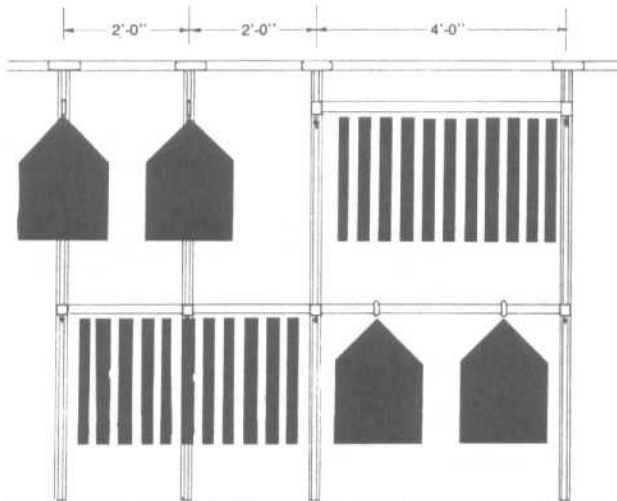
**FACE OUT & WATERFALL**



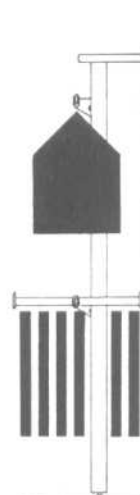
**FACE OUT**  
Average Quantity of  
Garments Per Post: 48



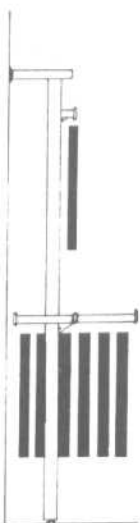
**POST FACE OUT WITH  
STRAIGHT HANGING**  
Average Quantity of  
Garments Per 4'-0" Section: 94



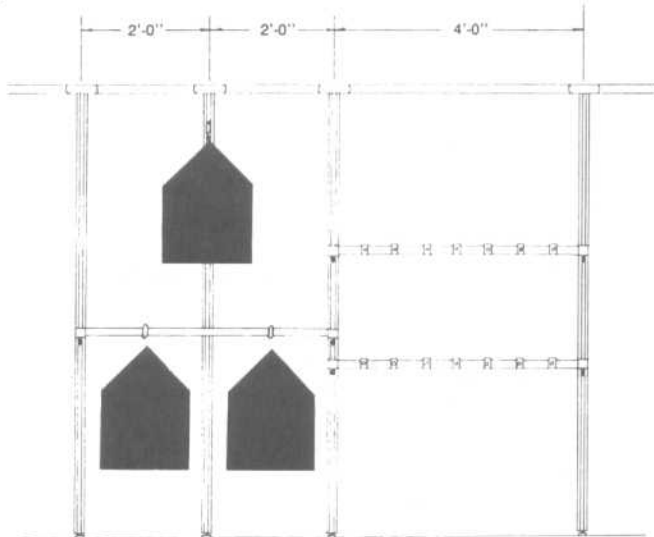
**STRAIGHT HANGING & FACE OUT**



**STRAIGHT  
WITH HANGRAIL FACE OUT**  
Average Quantity of Garments  
Per 4'-0" Section: 96



**FACE OUT WITH DISPLAY**  
Average Quantity of Garments  
Per 4'-0" Section: 49



- Compatible with universal 1/2" slotting
- Unique new oval hangrail

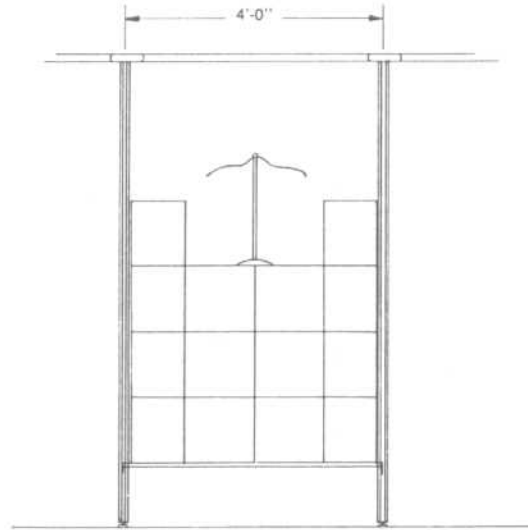


**ROD DISPLAYS**  
6 or 7 Rods Per  
4'-0" Section

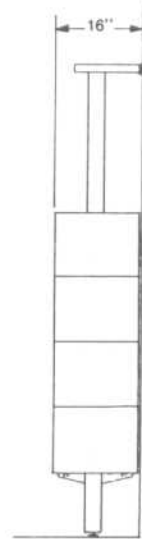
DEPARTMENT STORES

Wall Display Systems

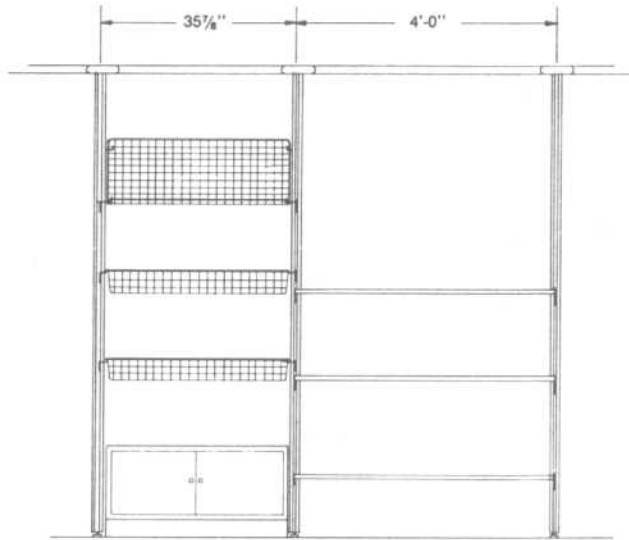
- Design continuity from wall to floor carries theme throughout the department or the store
- Designed for high volume merchandising
- Flexible merchandising
- Designed to be compatible with other Pam International Systems



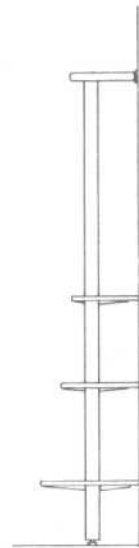
**BINNING SYSTEM**



**MULTI-NET SYSTEM**



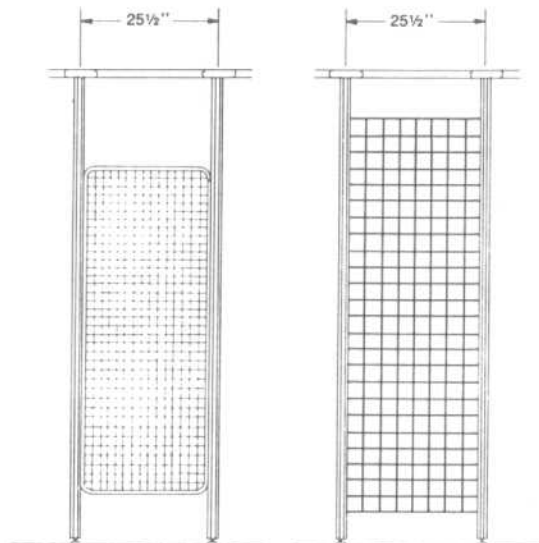
**BASKETS & SHELVES**



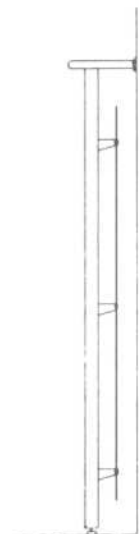
**WOOD OR GLASS SHELVES**



**MULTI-NET PANELS**



**MESH PANEL SYSTEMS**

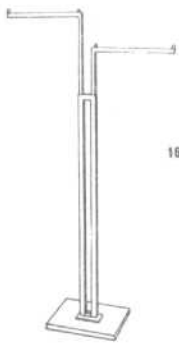


**GRID WALL PANELS**

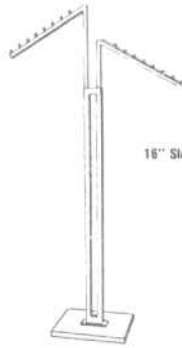
- All Multiples/Systems 2™ upright posts are engineered with easily changeable post covers (Pat. Pend.)
- All metal components are coated with a durable, long lasting, baked on epoxy powder finish.

DEPARTMENT STORES

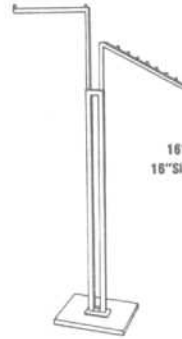
Rack Display Systems



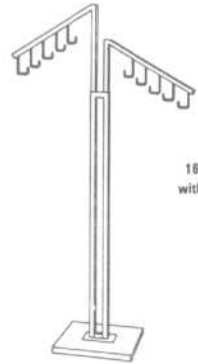
16" Straight Arms



16" Slant Arms with 8 balls

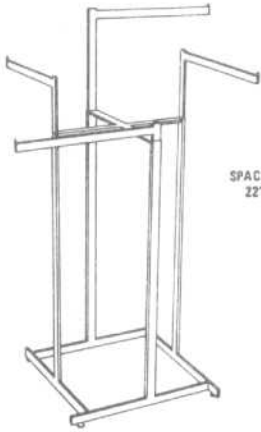


16" Straight Arm and 16" Slant Arm with 8 Balls

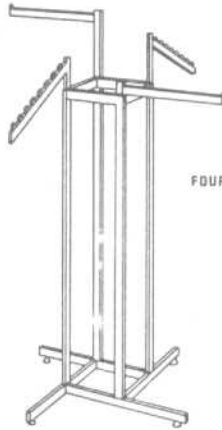


16" Slant Arms with 5 "J" Hooks

Two-arm costumers



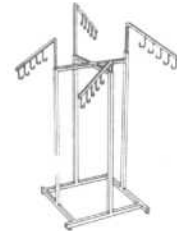
SPACE SAVER  
22" Arms



FOUR WAY RACK



18" Slant Arms with 8 Balls



18" Slant Arms with 5 "J" Hooks

Four-way racks



Rectangular Hangrail

36" Dia.  
42" Dia.



REVOLVING

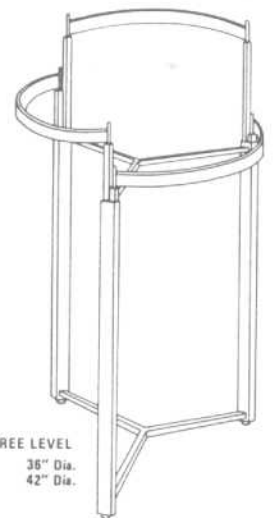
36" Dia.



14" Dia. Hangrail

36" Dia.  
42" Dia.

Circular racks

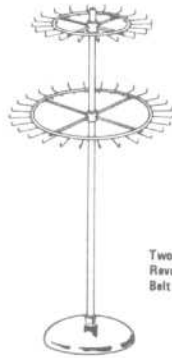


THREE LEVEL  
36" Dia.  
42" Dia.





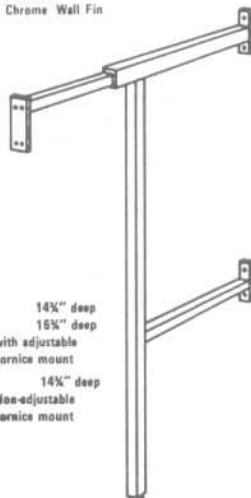
Single Tier Revolving Belt Rack



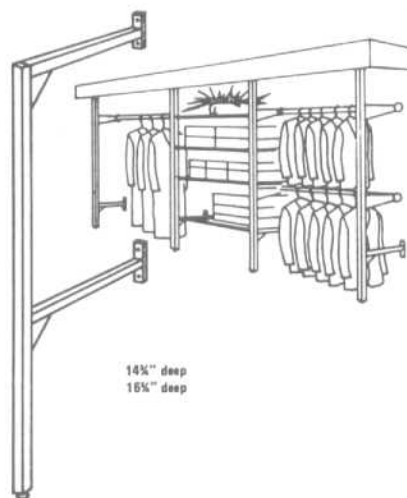
Two Tier Revolving Belt Rack

Specialty racks

OUTRIGGER All Chrome Wall Fin



14 1/2" deep  
15 1/2" deep  
with adjustable  
cornice mount  
14" deep  
Non-adjustable  
cornice mount



14" deep  
16 1/2" deep

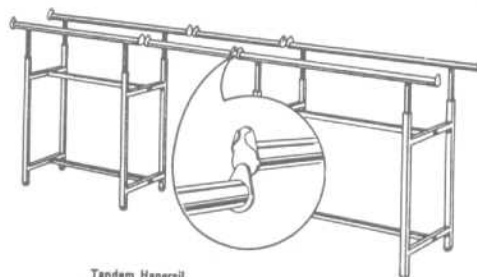
Outriggers, wall fins



60" Long



Double Hangrail



Tandem Hangrail

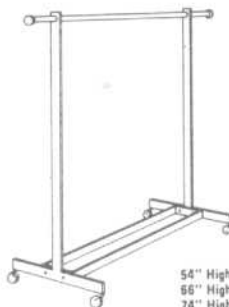
Rectangular racks



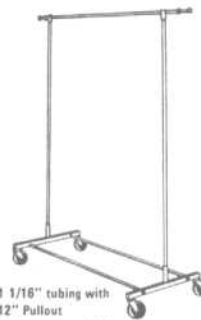
Folding-60" long  
w/15" Pullouts  
1" Square Tubing



60" Long  
All 1" Square Tubing 12" Pullout



54" High  
66" High  
74" High  
60" Long  
All Rectangular Tubing 1 1/2" Hangrail



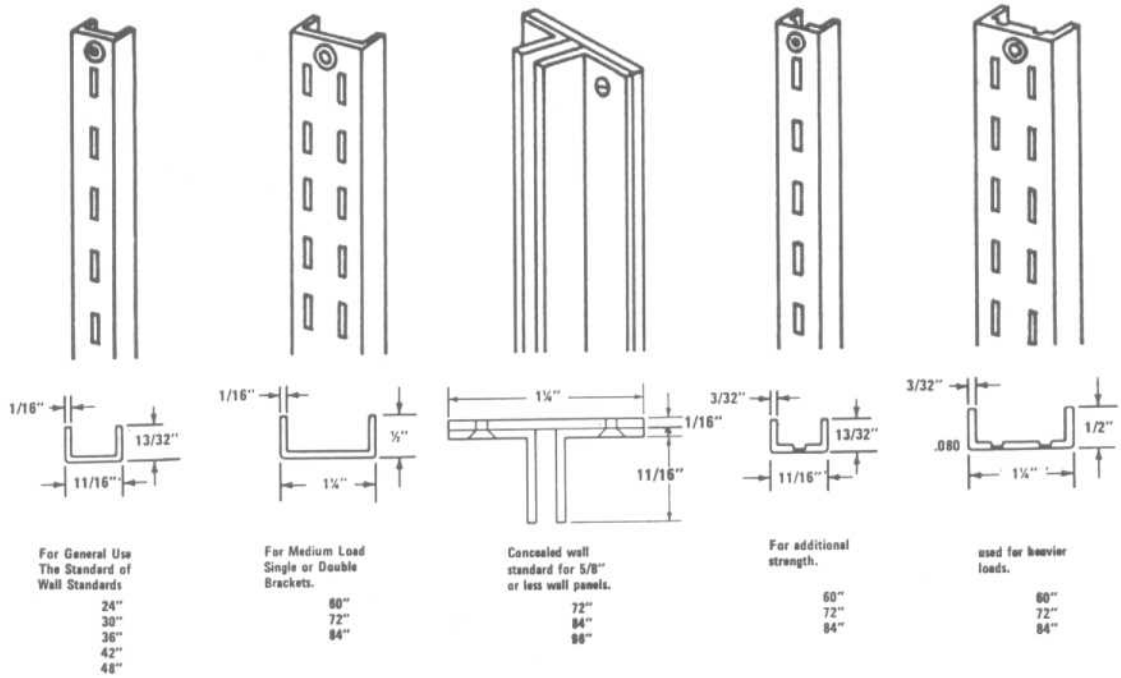
1 1/16" tubing with  
12" Pullout  
Uprights removable for storage.  
60" Long

Rolling racks

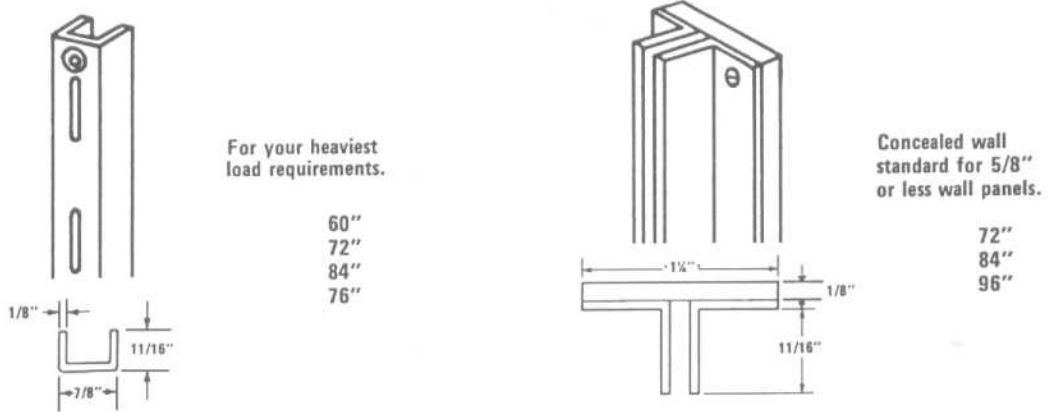
DEPARTMENT STORES

Display Systems Standards

MEDIUM DUTY-1/2" SLOTS 1" O.C.



HEAVY DUTY-1" SLOTS 2" O.C.



Regular Duty Brackets for use with 1" O.C. Slotting.  
1/2 hard steel .093 thickness



Polished chrome.  
Felt lined to prevent  
scratching of hangrail



Satin Zinc.

For 1" and 1 1/16" Tube

12"

14"

For 1 1/2" and 1 5/16" Tube

12"

14"



Satin Zinc.

12"

14"



Polished Chrome.  
Felt lined to prevent  
scratching hangrail



Satin Zinc.

For 1" and 1 1/16" Tube

12"

3"

For 1 1/2" and 1 5/16" Tube

12"

3"



Satin Zinc.

Heavy Duty Brackets for use with 2" O.C. Slotting  
1/2 hard steel .125 Thickness



Polished Chrome.  
Felt lines to prevent scratching of hang rail.



Satin Zinc.

12"

14"

# Public Restrooms, Toilets, and Coatrooms

Restrooms and toilets  
Coatrooms

425  
460



## RESTROOMS AND TOILETS

Plumbing Data

TABLE 1 Minimum Number of Plumbing Fixtures Required by Building Occupancy Type\*

Type of building occupancy	Type of fixture							
	Water closets		Urinals	Lavatories		Bathtubs or showers	Drinking fountains	Other fixtures
Assembly — places of worship†	1 for ea. sex for ea. 150 persons		Urinals may be provided in toilet rooms in lieu of water closets but for not more than ½ of the required number of water closets	1				
Assembly — other than places of worship (including but not limited to auditoriums, theaters, convention halls) and all spaces classified as F-4	No. of persons	No. of fixtures for each sex	Urinals may be provided in toilet rooms in lieu of water closets but for not more than ½ of the required number of water closets	No. of persons	No. of fixtures		1 for ea. 1,000 persons except that there shall be at least 1 fixture at each assembly floor level or tier	Where motion picture projection booths contain more than 2 projectors, at least 1 water closet and 1 lavatory shall be provided on the same level and within 20 ft. of the booth
	1-100	1		1-200	1			
	101-200	2		201-400	2			
	201-300	3		401-750	3			
	301-400	4		Over 750, add 1 fixture for ea. 500 persons				
Dormitories — school or labor, also institutional	1 for ea. sex for ea. 8 persons		Urinals may be provided in toilet rooms in lieu of water closets but for not more than ½ of the required number of water closets	1 for ea. 12 persons		1 for ea. 8 persons; for women's dormitories, 1 bathtub shall be substituted for 1 shower at the ratio of 1 for ea. 30 women		Laundry trays — 1 for ea. 50 persons
Single room occupancies for sleeping accommodations only	1 for ea. 6 persons			1 for ea. 6 persons		1 for ea. 6 persons		
Dwellings — one- and two-family	1 for each dwelling unit			1 for each dwelling unit		1 for each dwelling unit		Kitchen sink — 1 for each dwelling unit
Public buildings, offices, business mercantile, storage, warehouses, factories and institutional employees‡	No. of persons each sex	No. of fixtures	Urinals may be provided in toilet rooms in lieu of water closets but for not more than ½ of the required number of water closets when more than 35 persons	No. of persons	No. of fixtures		1 for ea. 75 persons	
	1-15	1		1-20	1			
	16-35	2		21-40	2			
	36-55	3		41-60	3			
	56-80	4		61-90	4			
	81-110	5		91-125	5			
	111-150	6		1 fixture for ea. additional 45 persons				
Public bathing	1 fixture for ea. sex for ea. 30 persons		Urinals may be provided in toilet rooms in lieu of water closets but for not more than ½ of the required number of water closets	1/60		1/40		
Schools: Elementary Secondary	1 fixture for ea. sex for ea. 35 students		Urinals may be provided in toilet rooms in lieu of water closets but for not more than ½ of the required number of water closets	1/50 pupils 1/50 pupils Over 300 pupils: 1/100 pupils		In gym or pool shower rooms, ½ pupils of a largest class using pool at any one time.	1/50 persons but at least 1 per floor	
Workers' portable facilities	1/30 workers		1/30 workers				At least 1 per floor equivalent for ea. 100 workmen	
Industrial — foundries only	No. of persons	No. of fixtures	Where more than 10 men are employed: No. of men      No. of urinals	No. of persons	No. of fixtures	1 shower for each 15 persons exposed to excessive heat or occupational hazard from poisonous, infectious, or irritating material.	1 for ea. 75 persons	
	1-10	1		1-8	1			
	11-25	2		9-16	2			
	26-50	3	11-29      1	17-30	3			
	51-80	4	30-79      2	31-45	4			
	81-125	5	1 additional fixture for each additional 80 males	46-65	5			
	1 additional fixture for each additional 45 persons		Urinals may be provided in toilet rooms in lieu of water closets but for not more than ½ of the required number of water closets	1 additional fixture for each additional 25 persons				
	Other fixtures							
Kitchens for public or employes dining				1 lavatory for the personal use of kitchen employees			One machine or a 3-compartment sink for the effective washing and sanitizing of all cutlery, dishes and glasses before re-use	
Dwellings — multiple or apartment	1 for each dwelling unit or apartment			1 for each dwelling unit or apartment		1 for each dwelling unit or apartment	Kitchen sink — 1 for each dwelling unit or apartment. Within each dwelling unit, not designed for use by transients, one laundry tray or automatic laundry washing machine; or in a readily accessible location within a general laundry room. 1 two-compartment tray for each 10 dwelling units or 1 automatic laundry washing machine for each 20 dwelling units.	

\*The population used in determining the number of fixtures required shall be based on the number of people to occupy the space but in no case shall the population be less than that determined by allowing 125 sq. ft. of net floor area per person.

†Such facilities may be in adjacent buildings under the same ownership or control, and shall be accessible during periods when the assembly space is occupied.

‡Facilities for employees in a storage building or warehouse may be located in an adjacent building, under the same ownership, where the maximum distance of travel from the working space to the toilet facilities does not exceed 500 ft. horizontally.

**RESTROOMS AND TOILETS**

Plumbing Fixture and Accessory Heights

While Fig. 1 provides specific vertical dimensions of both plumbing fixtures and accessories, the designer is cautioned that every plumbing fixture and accessory must be carefully analyzed in light of the users to be served. Plumbing contractors will follow the manufacturer's recommendations or their own standards unless the designer provides this information on the working drawings. In large-scale projects, it is suggested that the designer carefully provide all fixture mounting heights on all interior elevations or on a separate diagrammatic drawing, such as is shown in Fig. 1.

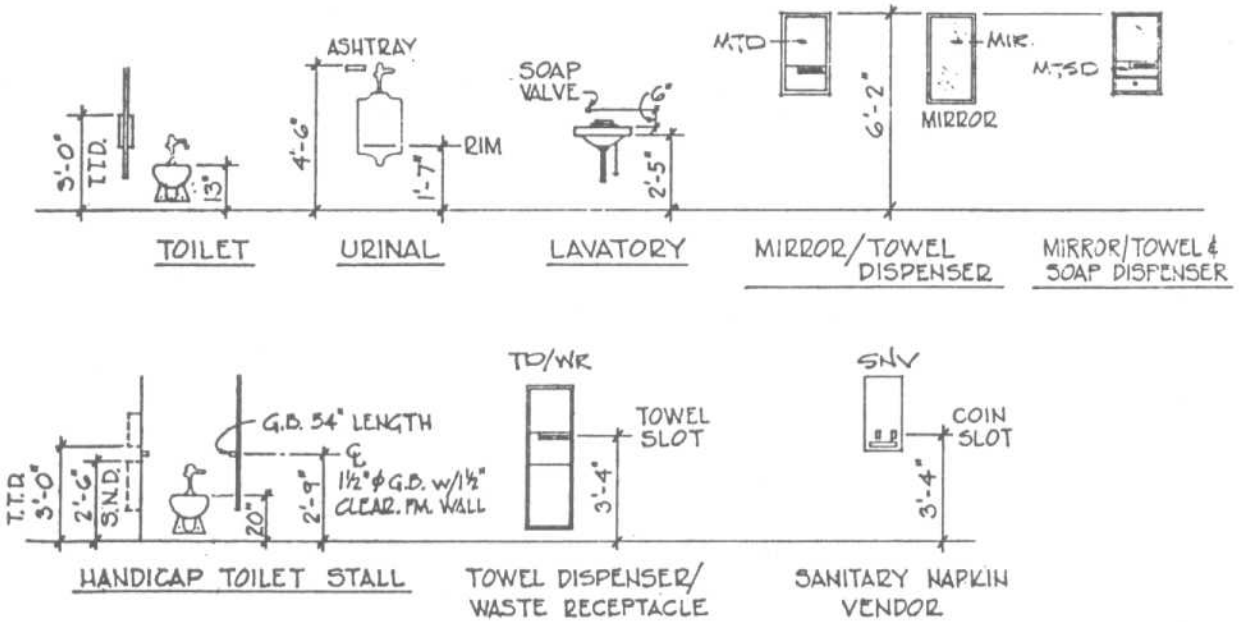


Fig. 1 Fixture heights.



Fig. 2 Suggested mounting heights for various bathroom accessories.

**Partition Mounted Units**

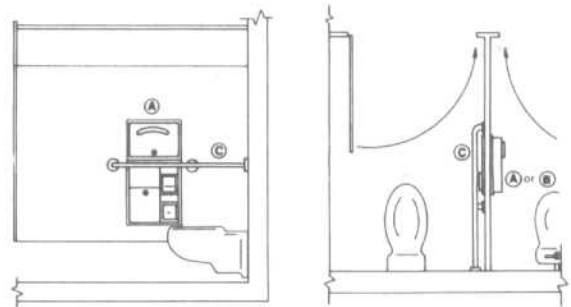


Fig. 3 Typical back to back male/female washroom stalls using partition mounted units to accommodate a handicapped stall and one standard stall. If room permits, grab bars should be placed on all three sides, resulting in a "U"-shaped configuration. Most codes require toilet stall doors to open outward.

## RESTROOMS AND TOILETS

Plumbing Fixture and Accessory Heights

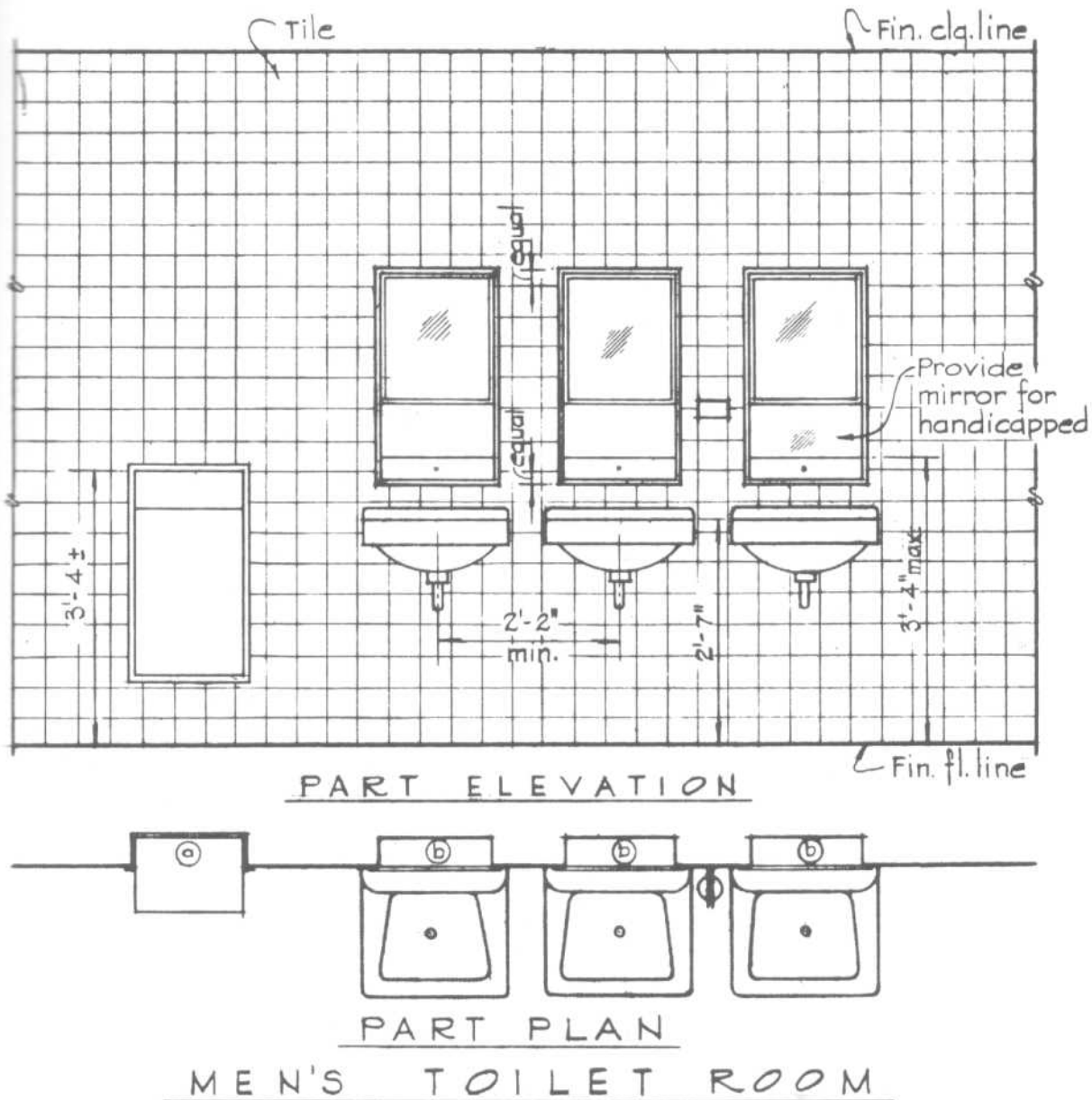
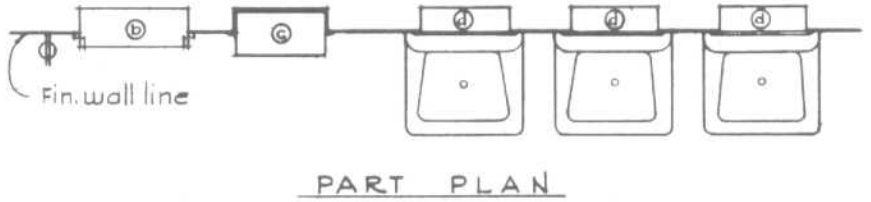
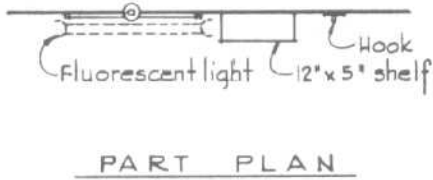
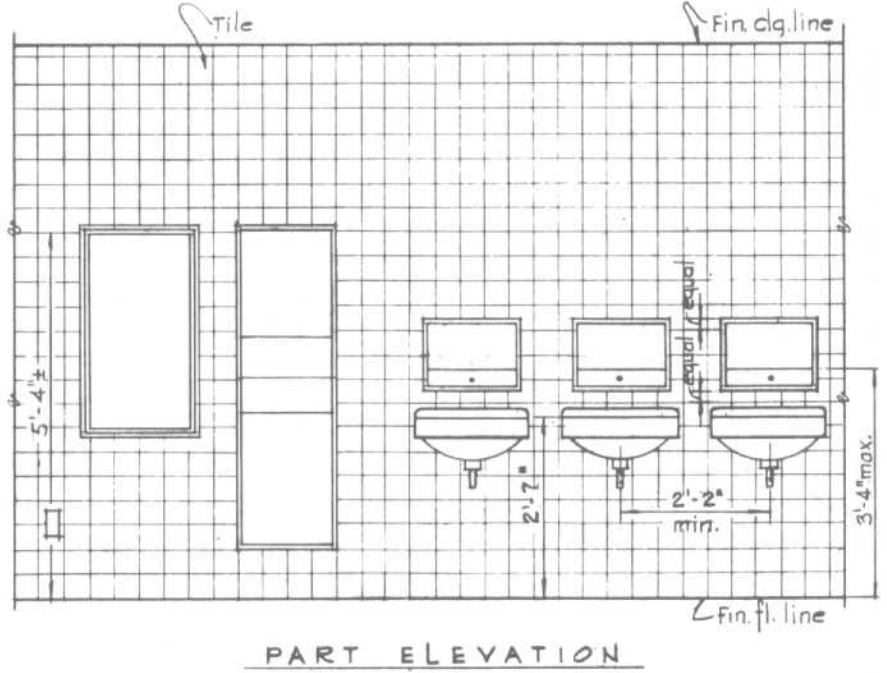
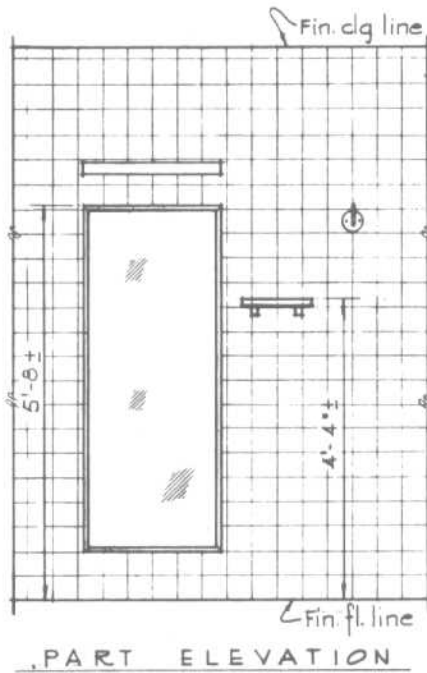


Fig. 4 This drawing of a part plan and part elevation of a men's toilet room demonstrates how mounting heights of plumbing fixtures and accessories are indicated. In addition, spacing of plumbing fixtures is indicated by use of a horizontal dimension from centerline to centerline of the lavatories. Many designers prefer to show horizontal dimensions on the plan. a=recessed waste receptacle, b=recessed towel dispenser and soap dispenser with shelf.

RESTROOMS AND TOILETS

Plumbing Fixture and Accessory Heights



WOMEN'S TOILET ROOM

Fig. 5 Mounting heights or vertical dimensions are always taken from the finished floor. When installing accessories on tile walls, the tile module and dimensions should be taken into consideration. a = full length mirror, b = recessed feminine napkin dispenser, c = recessed towel cabinet and waste receptacle, d = recessed soap dispenser with shelf.



## RESTROOMS AND TOILETS

Plumbing Fixture and Accessory Heights

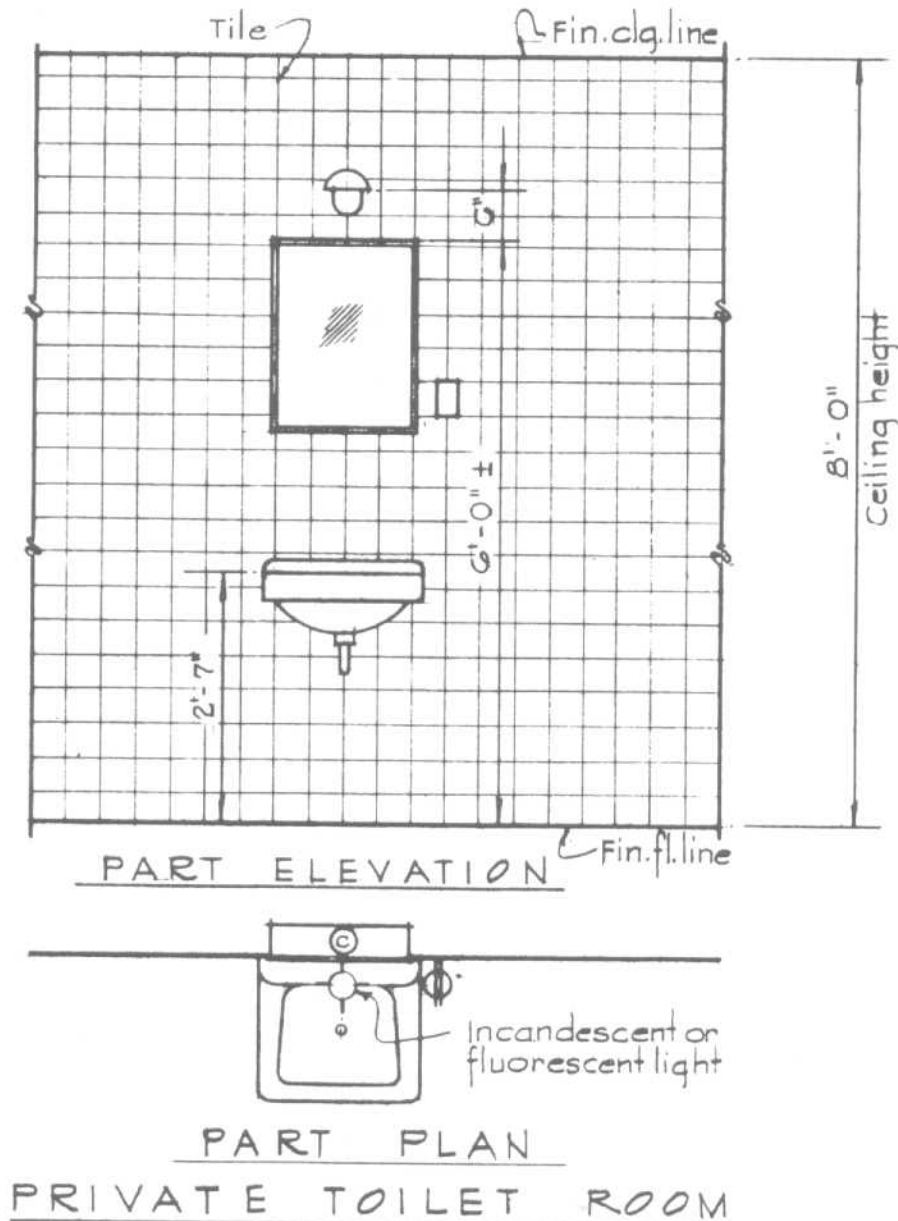


Fig. 6 The mounting heights of plumbing fixtures and accessories for a private toilet are, in many instances, determined by the physical characteristics of the primary user. A person 6'6" tall might require the mounting height of a lavatory, mirror, or shower head to be higher than usual. Note that any electrical outlets near a lavatory or shower must be specified with a ground fault interrupter. c = first aid cabinet and medicine cabinet.

RESTROOMS AND TOILETS

Plans

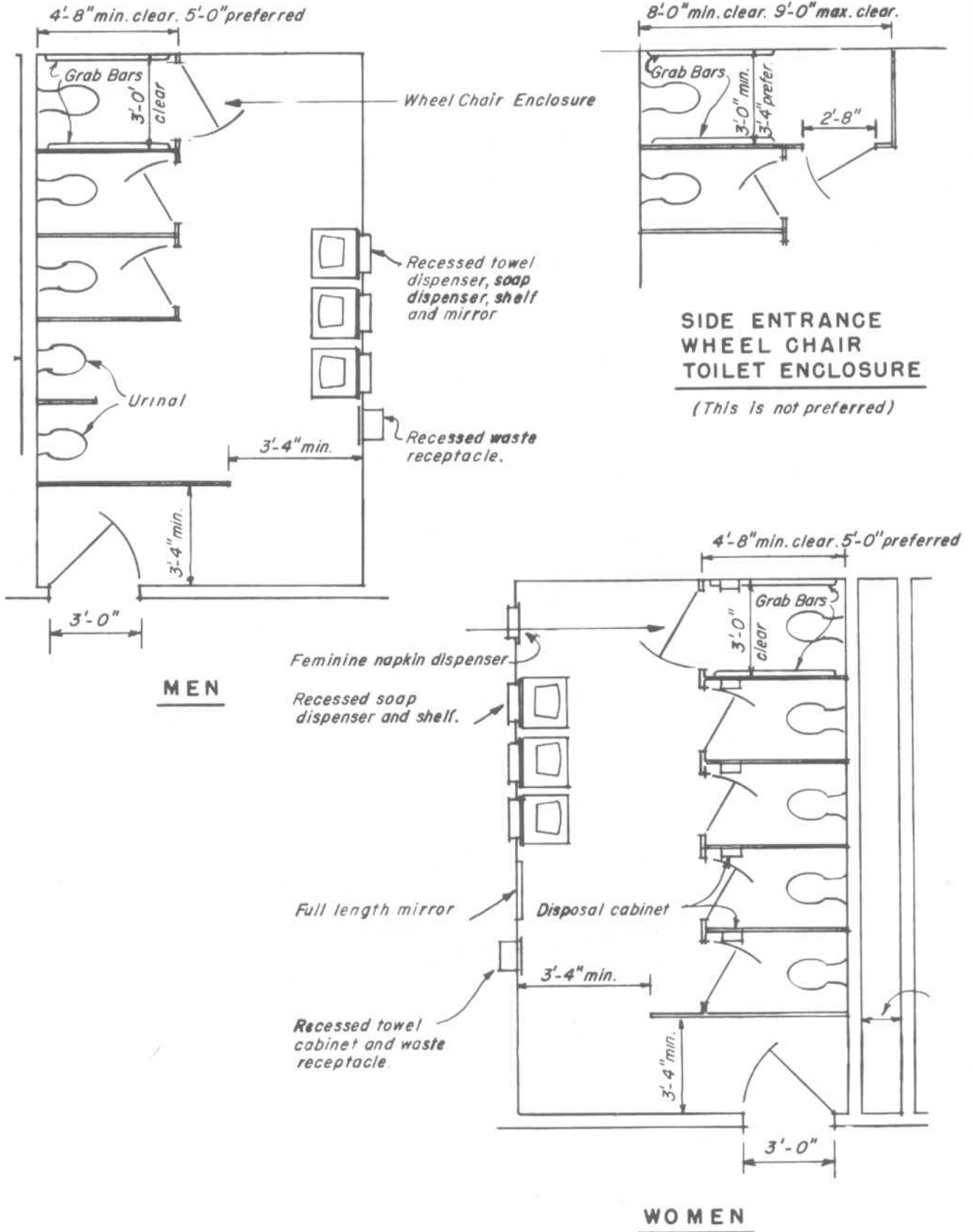
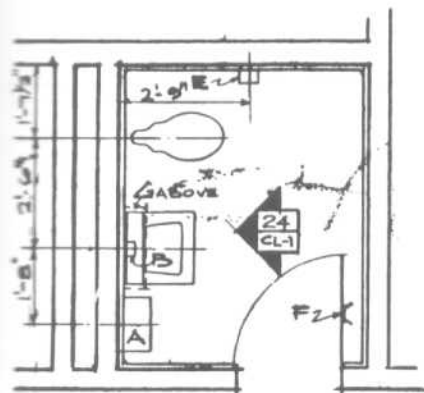


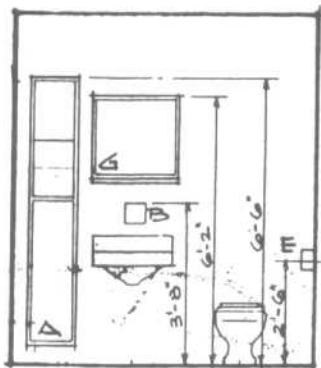
Fig. 7 These drawings show minimum dimensions both for toilet enclosures and between partitions and walls. These layouts are recommendations provided by the General Services Administration, but they may not be in conformity with other codes or desired bathroom layouts, especially in regard to accessibility. Remember, too, that codes provide minimum, not optimal, standards.

## RESTROOMS AND TOILETS

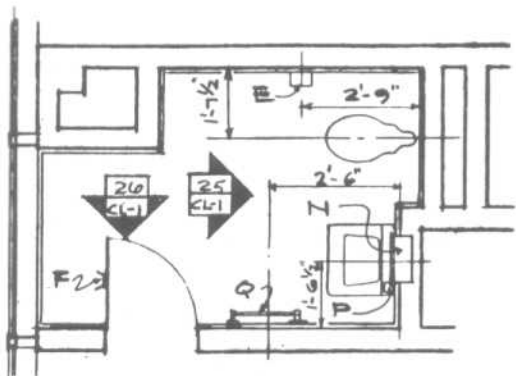
Plans and Elevations



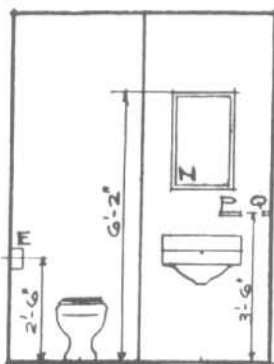
LAVATORY



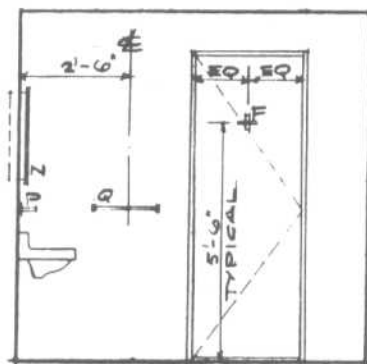
24



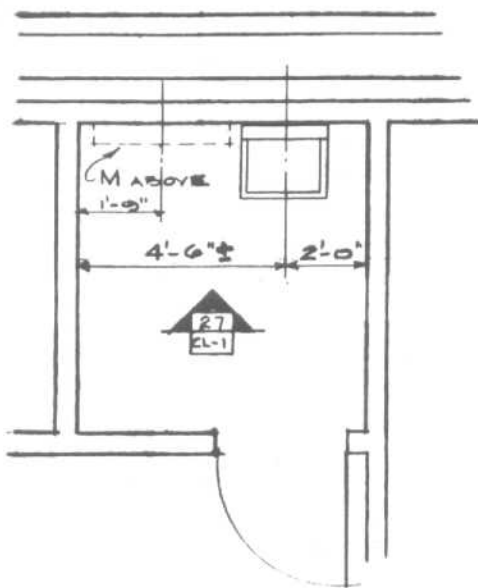
LAVATORY



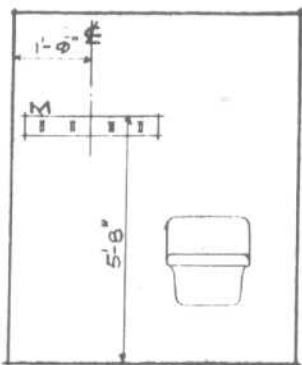
25



26



JAN. CLOSET



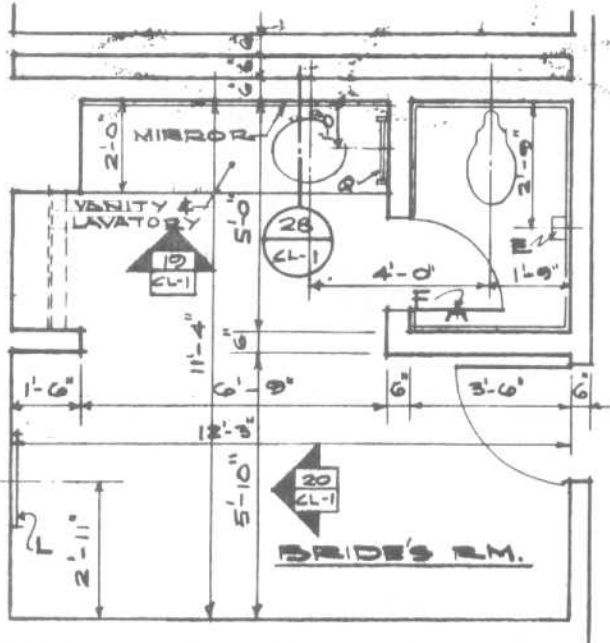
27

Fig. 8 These working drawings provide both vertical and horizontal dimensions for placement of plumbing fixtures and accessories. Note that accessories are identified or "called out" through the use of letters, which would be coordinated with either a legend or a schedule.

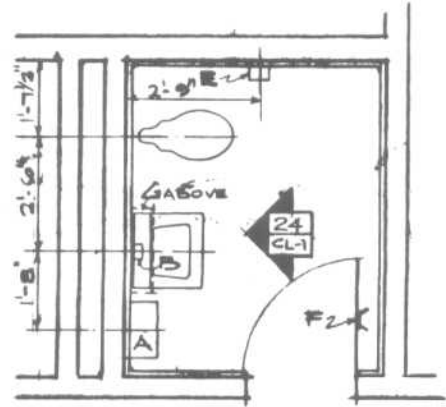
RESTROOMS AND TOILETS

Plans

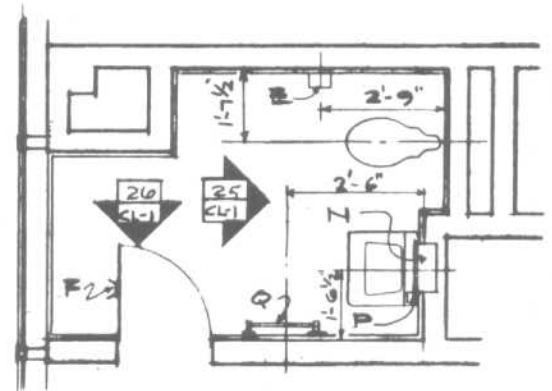
In multiple-fixtured public toilets, at least one watercloset and lavatory must be designed to conform to barrier-free or accessibility standards.



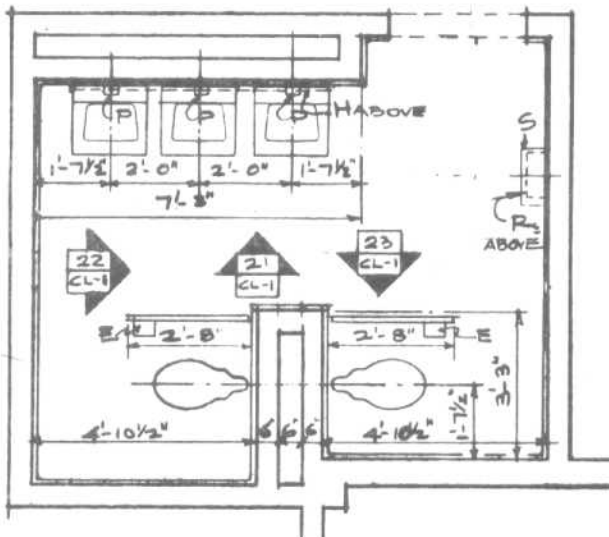
BRIDE'S ROOM LAVATORY



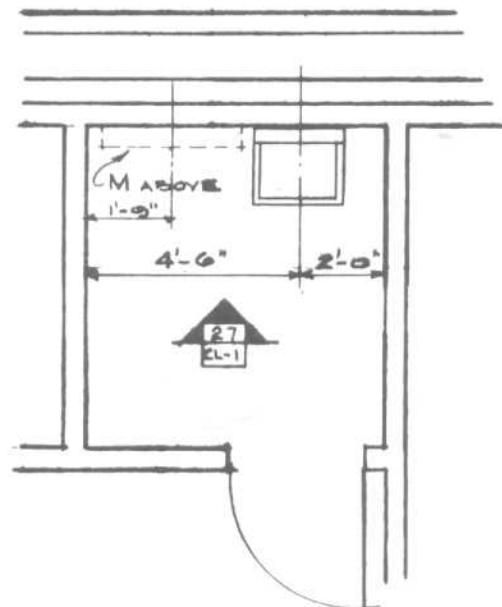
LAVATORY



LAVATORY



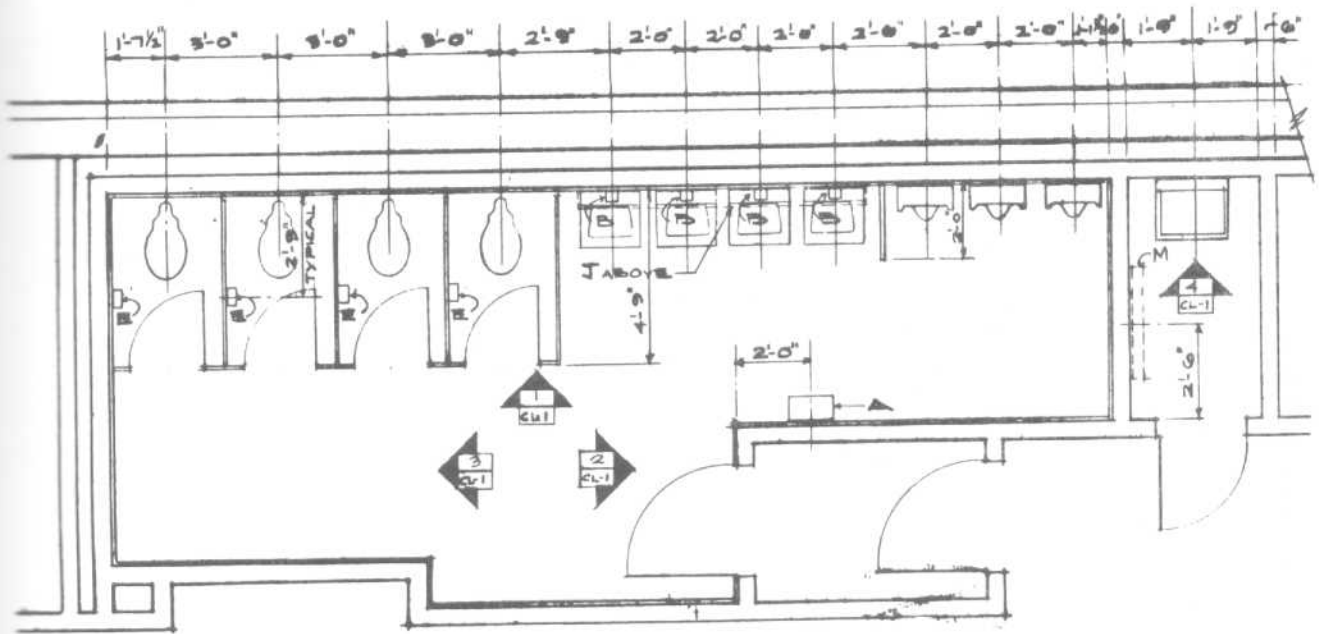
LAVATORY



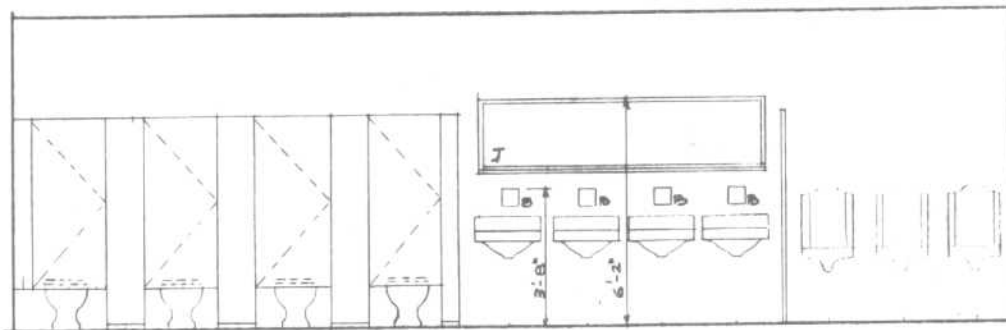
JAN. CLOSET

RESTROOMS AND TOILETS

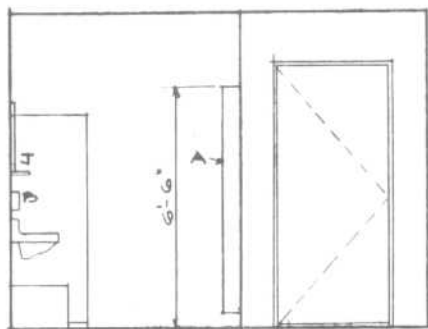
Plans and Elevations



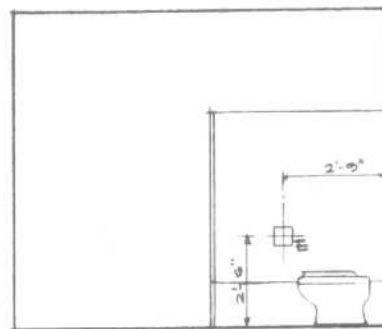
MENS TOILET



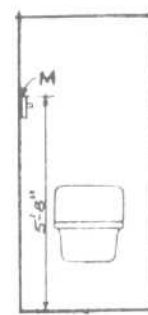
1



2



3



4

## RESTROOMS AND TOILETS

## Plans and Elevations

The women's room shown in Fig. 9 requires approximately 250 ft<sup>2</sup> for the toilet area and about the same for the vanity area. Wall elevations for the two areas are shown in Fig. 10. The designer should carefully analyze the number of lavatories and water-closets specified for a given facility. Research suggests that most "fixture counts" pro-

vided by city or state codes are too low and do not adequately reflect the amount of time that women require. As a result, it is not unusual to see long lines in front of women's rooms, particularly those that service places of public assembly. Note that the plan in Fig. 9 provides supplemental vanity or counter surfaces.

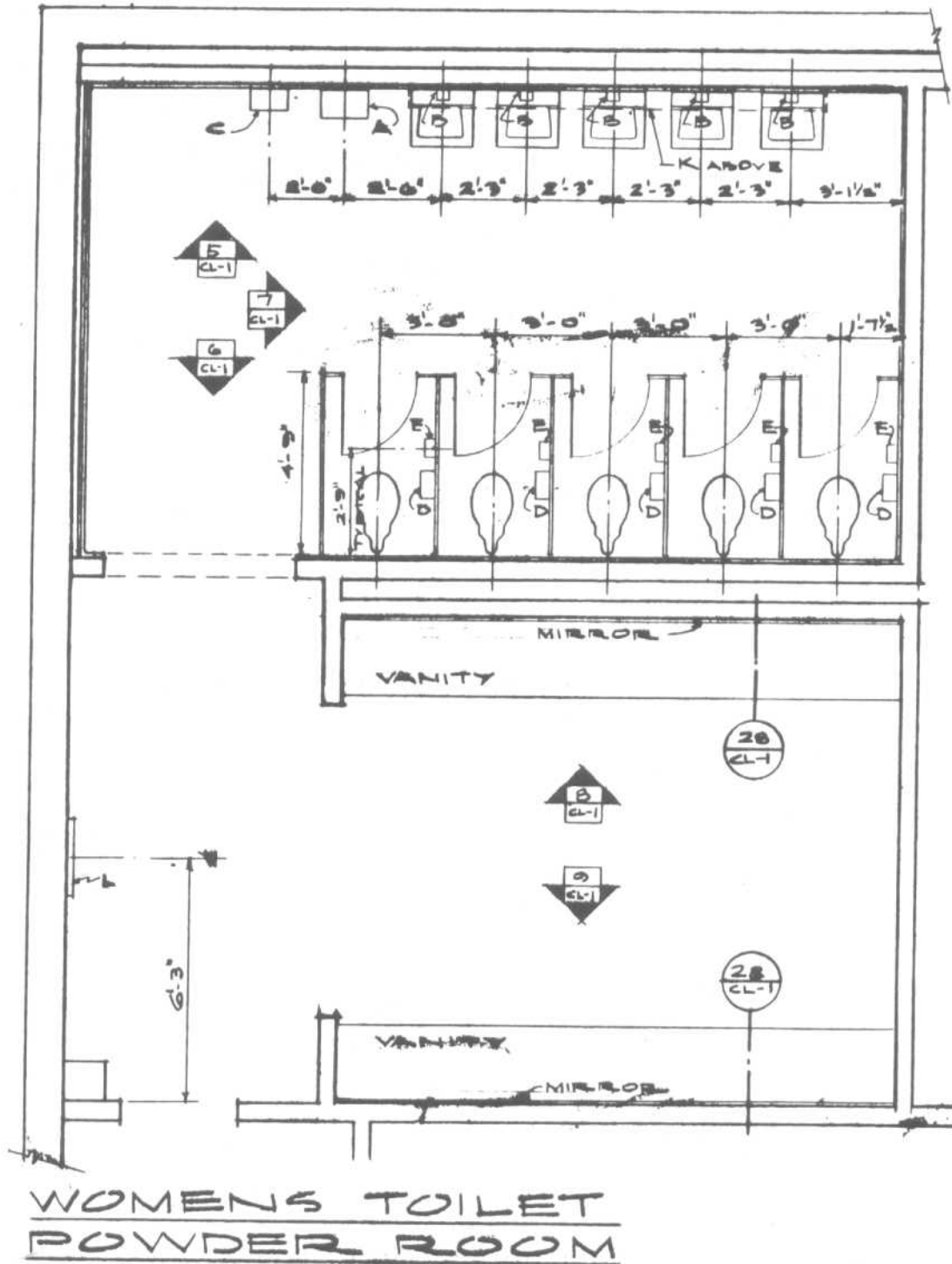
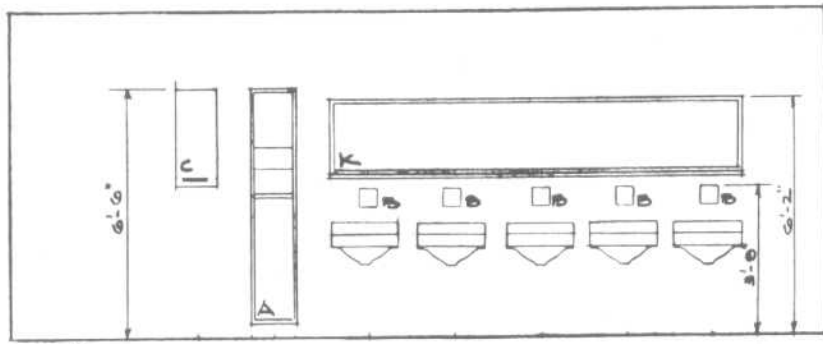


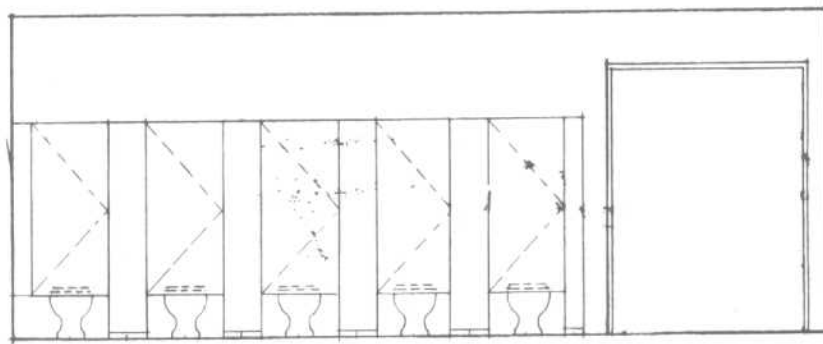
Fig. 9

RESTROOMS AND TOILETS

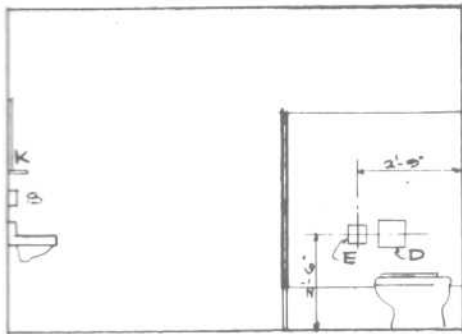
Plans and Elevations



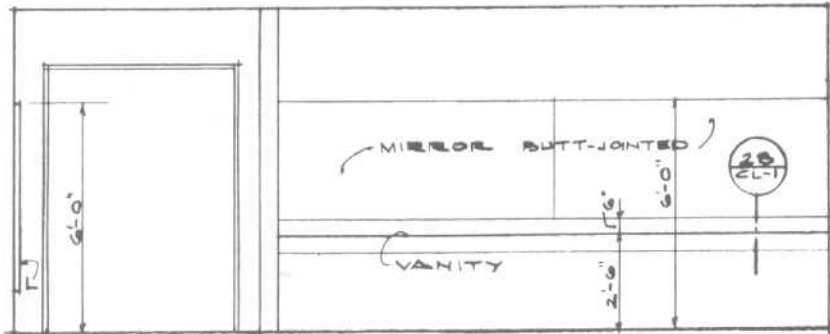
5



6



7



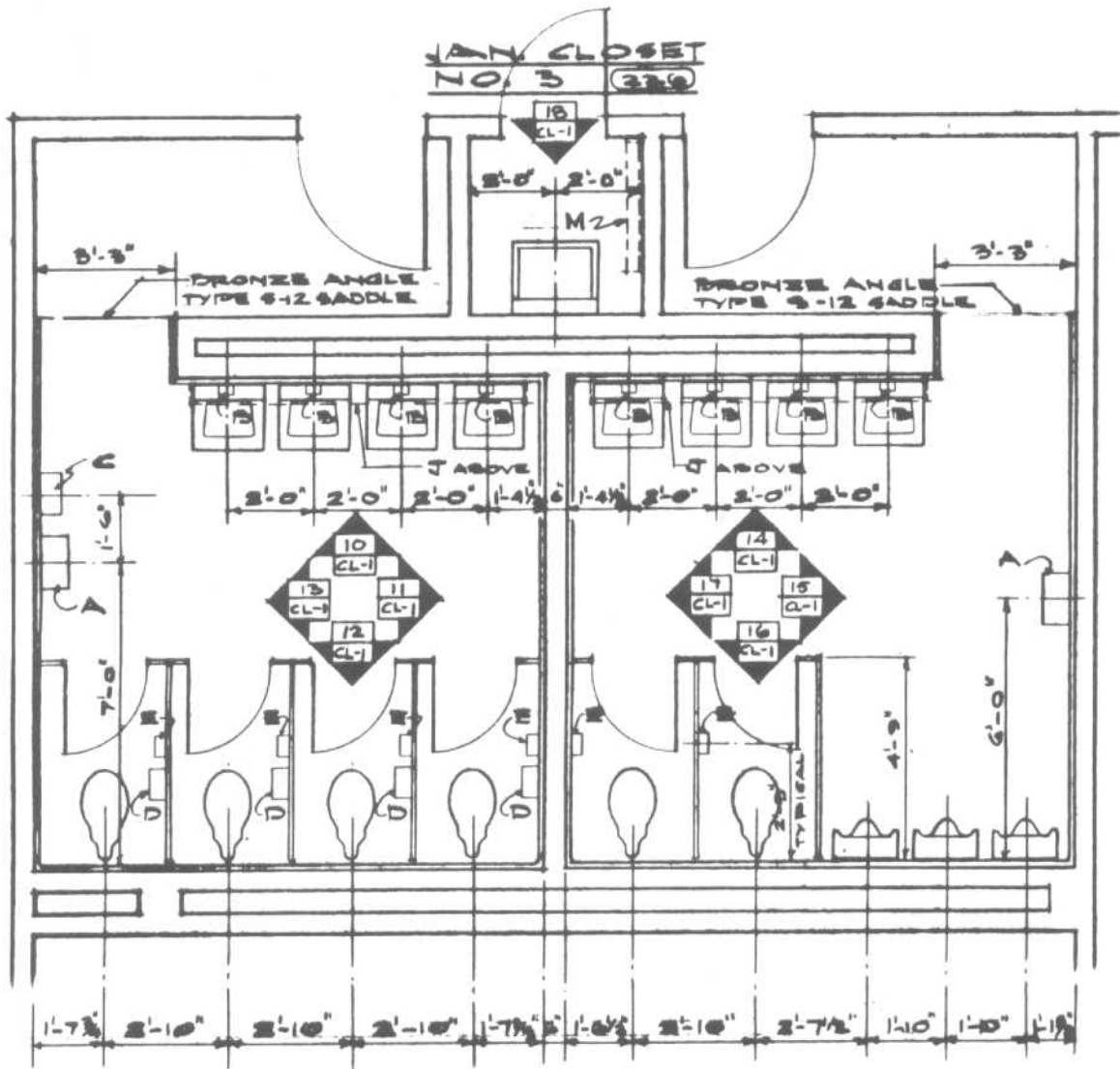
8 9

NOTE: ELEV. 8 IS SIMILAR TO ELEV. 5

Fig. 10 Wall elevations for the women's room plan in Fig. 9.

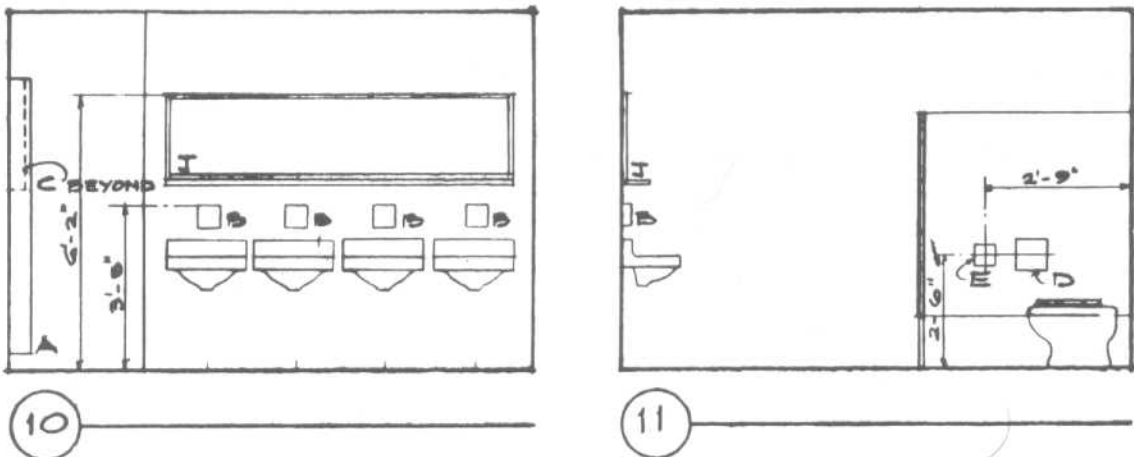
RESTROOMS AND TOILETS

Plans and Elevations



WOMENS TOILET  
MENS TOILET

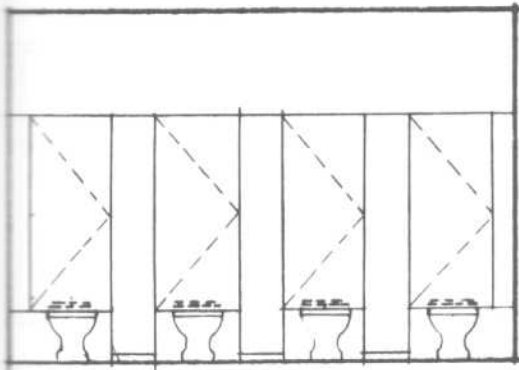
Fig. 11 This men's room and women's room complex, including a janitor's closet, requires slightly more than 400 ft<sup>2</sup> of floor area. Corresponding wall elevations are shown in Fig. 12.



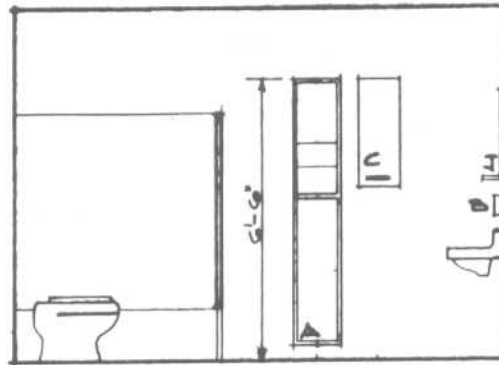


RESTROOMS AND TOILETS

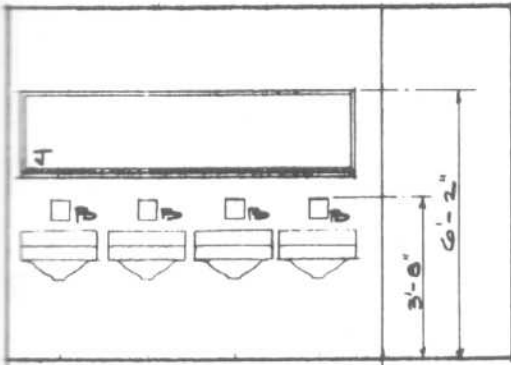
Plans and Elevations



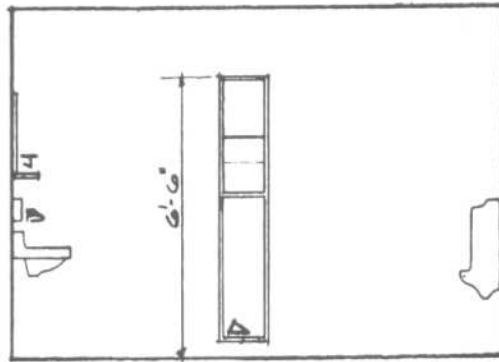
12



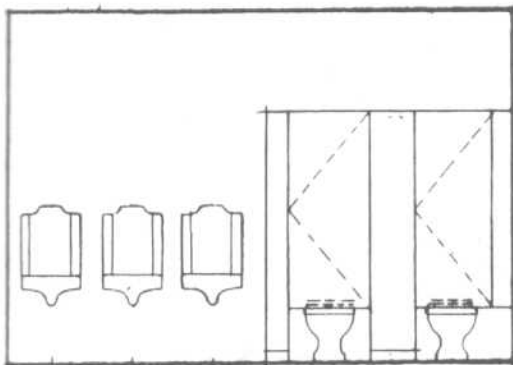
13



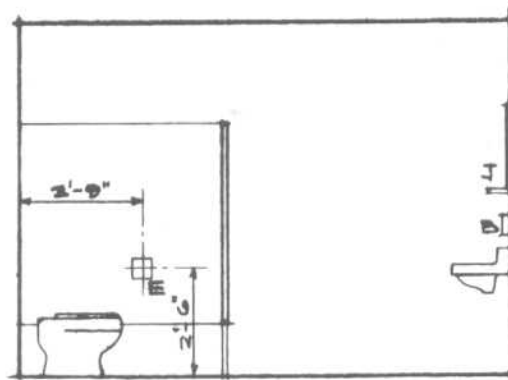
14



15



16



17

Fig. 12 (Continued)

RESTROOMS AND TOILETS

Miscellaneous Elevations

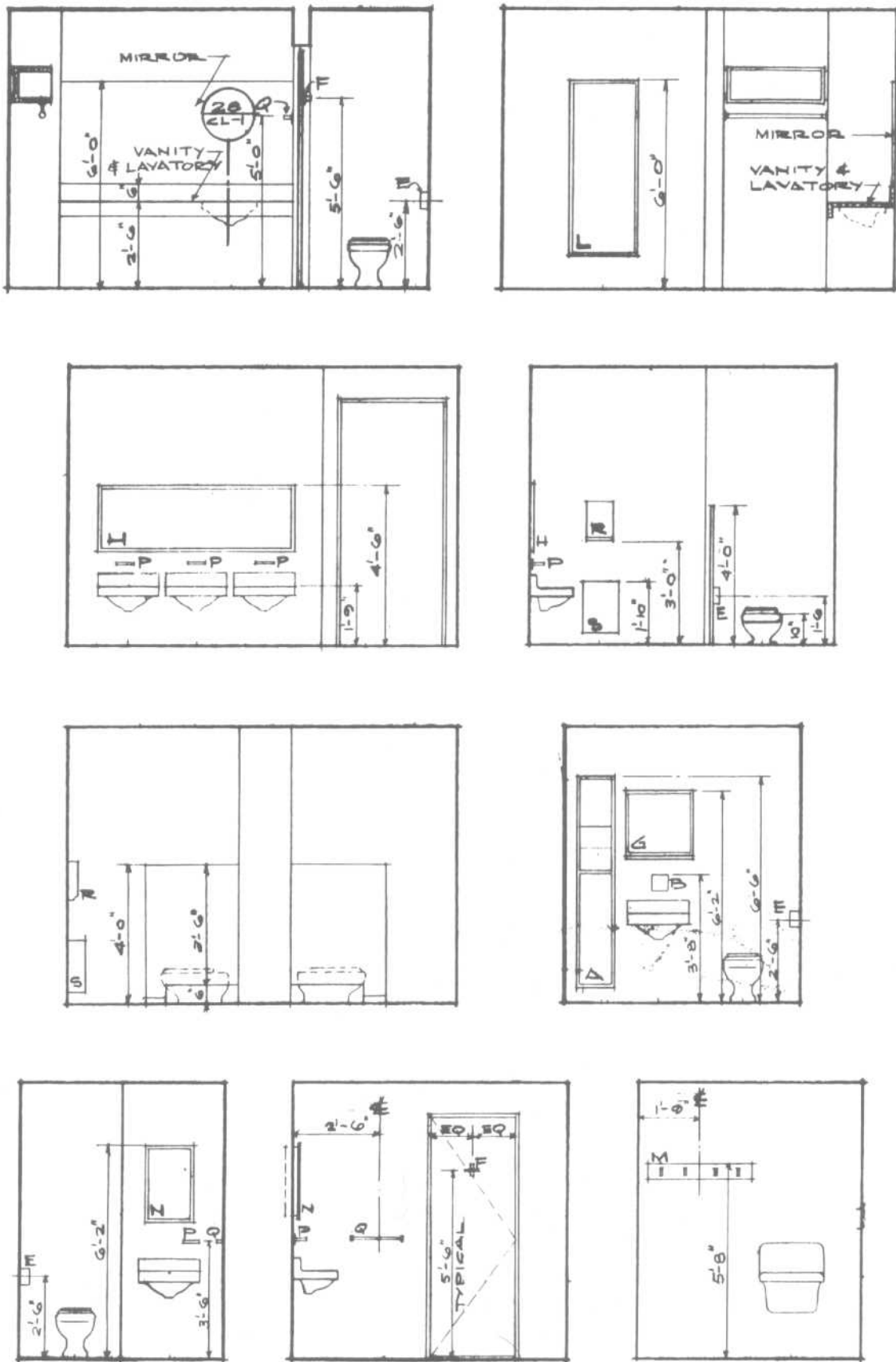
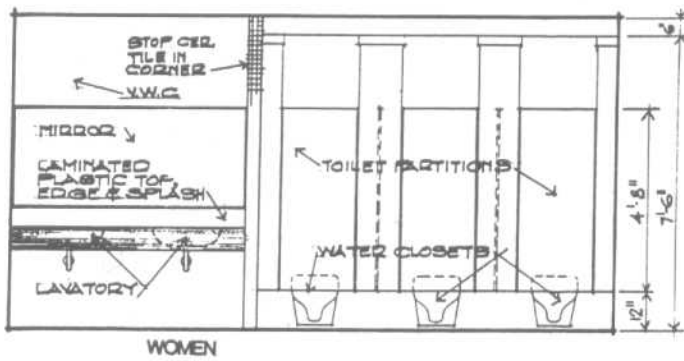
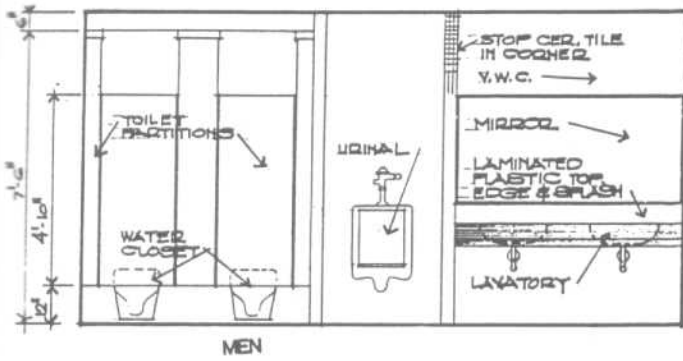
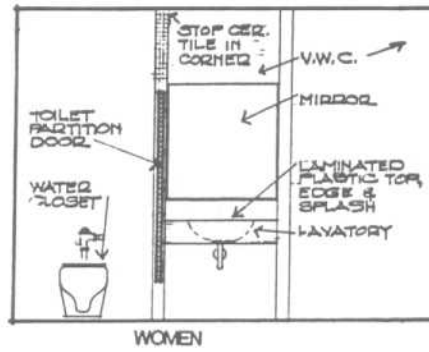
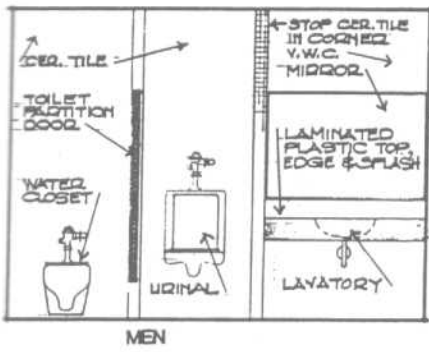
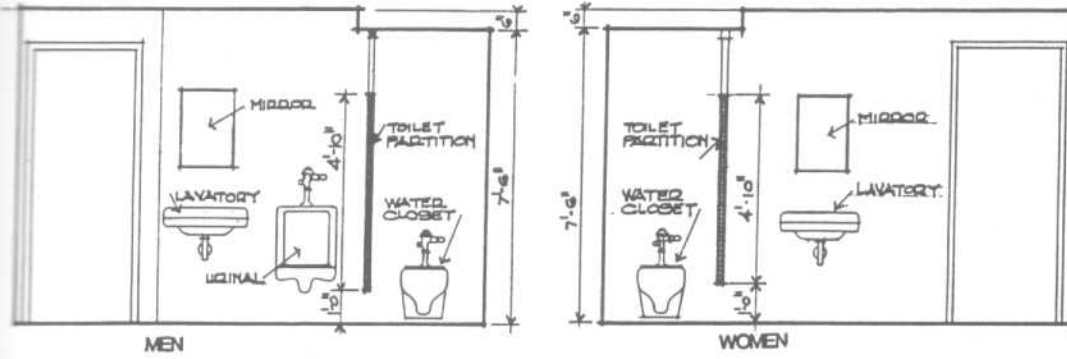


Fig. 13 These drawings show how some designers indicate the heights of certain fixtures and bathroom accessories.

RESTROOMS AND TOILETS

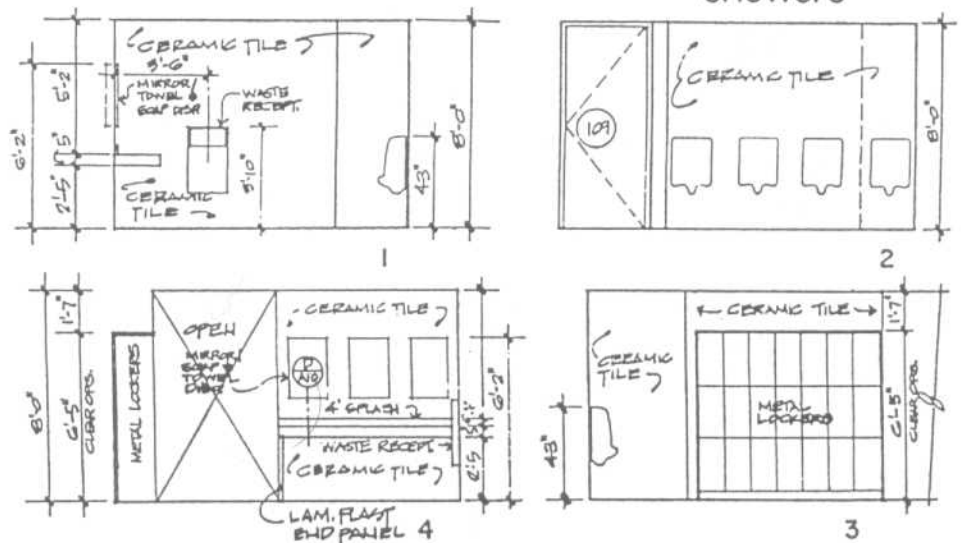
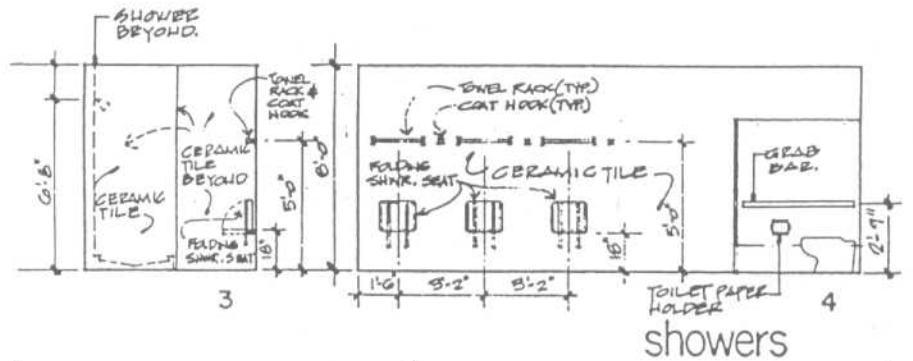
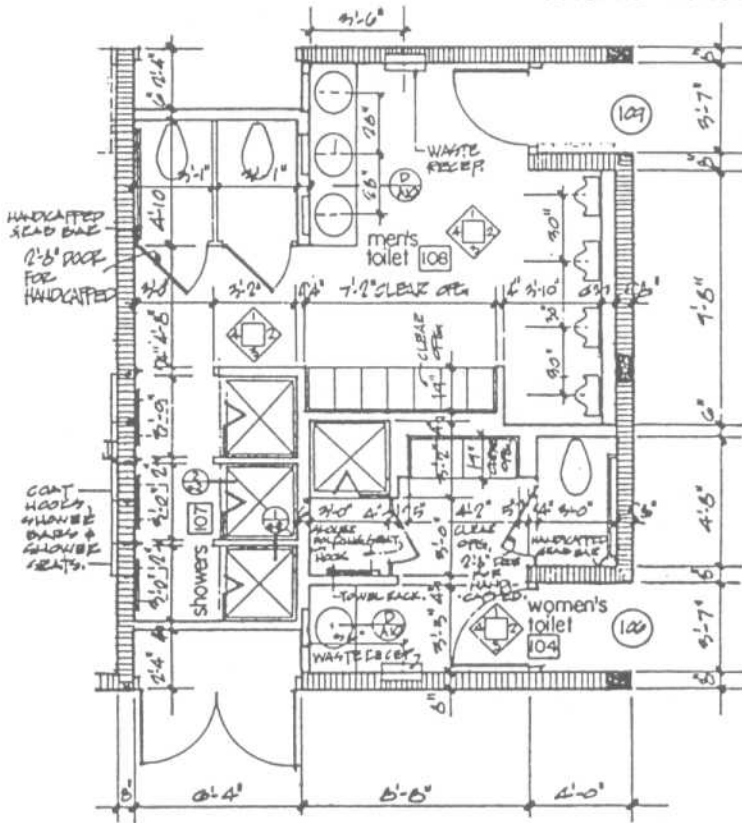
Miscellaneous Elevations



RESTROOMS AND TOILETS

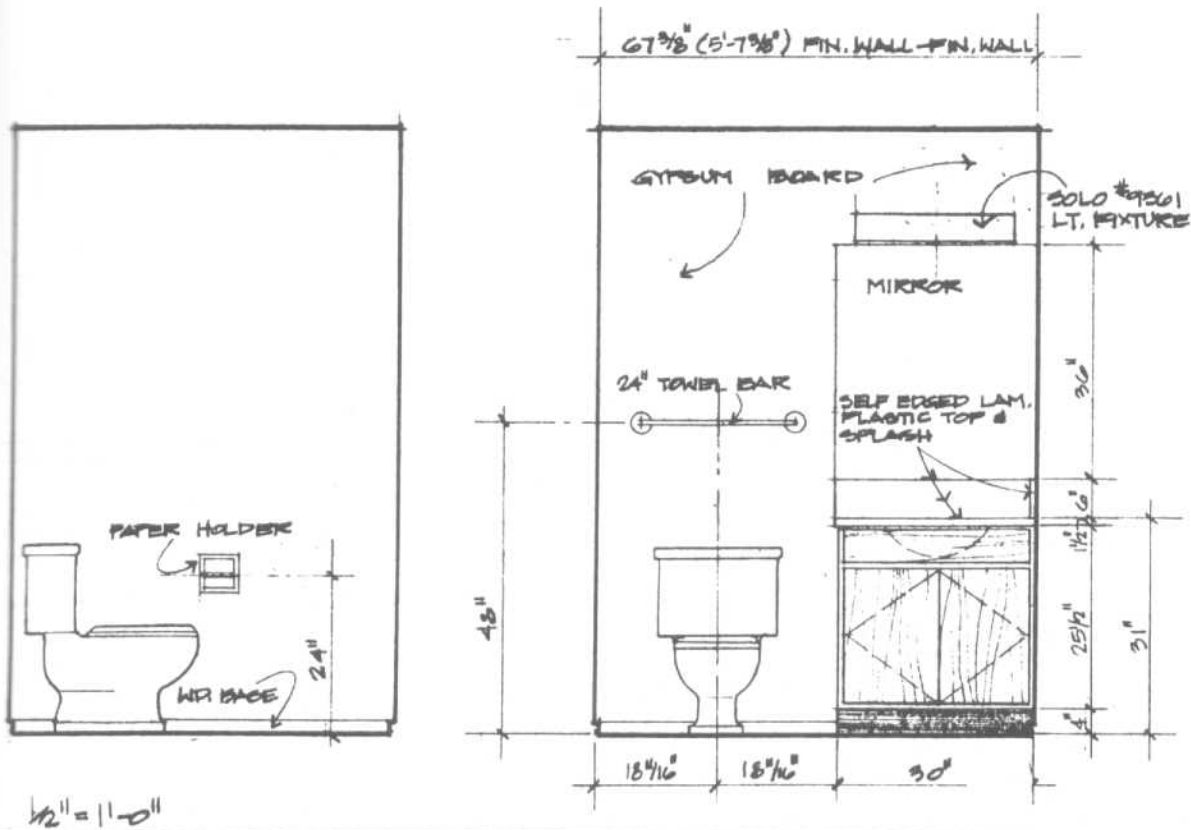
Plans and Elevations

men's toilet



RESTROOMS AND TOILETS

Plans and Elevations



1/2" = 1'-0"  
**TOILET ROOM ELEVATIONS**

Fig. 14 Detailed large-scale wall elevations such as this are required to show materials, accessory mounting heights, the coordination and placement of plumbing fixtures, and even manufacturer's model numbers.

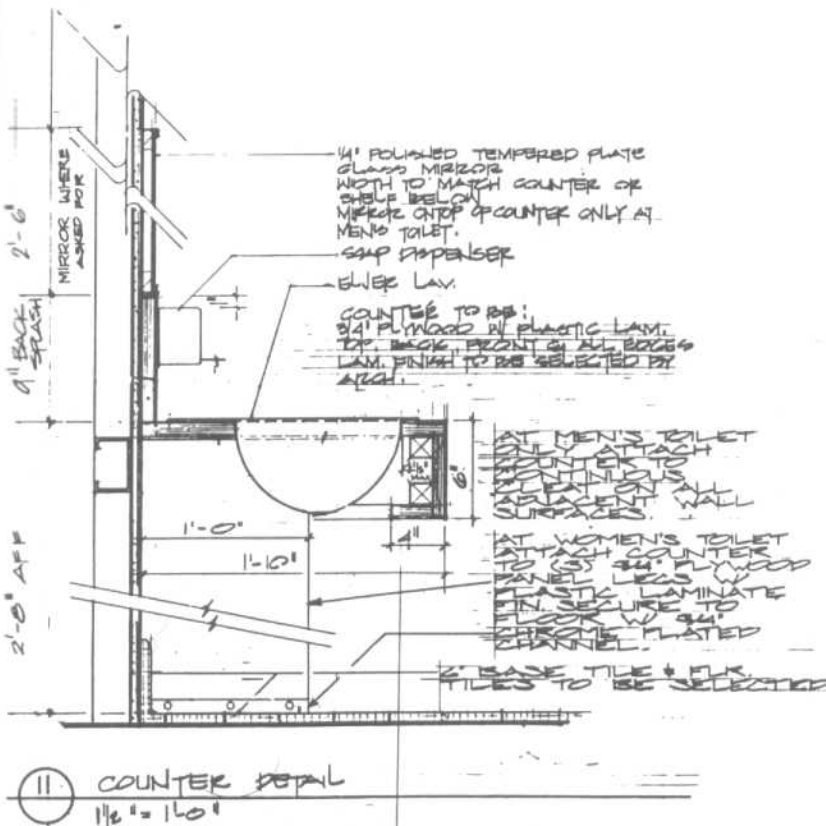
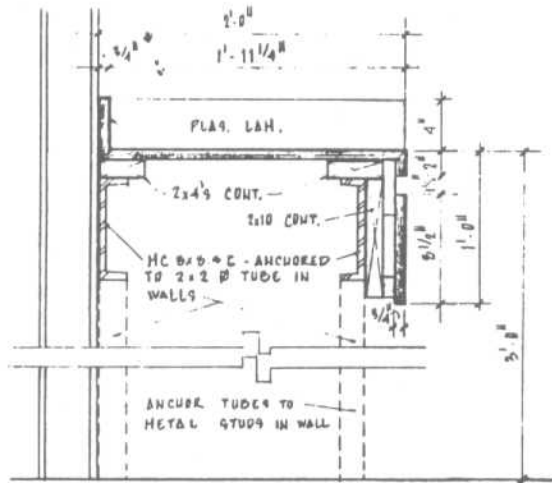


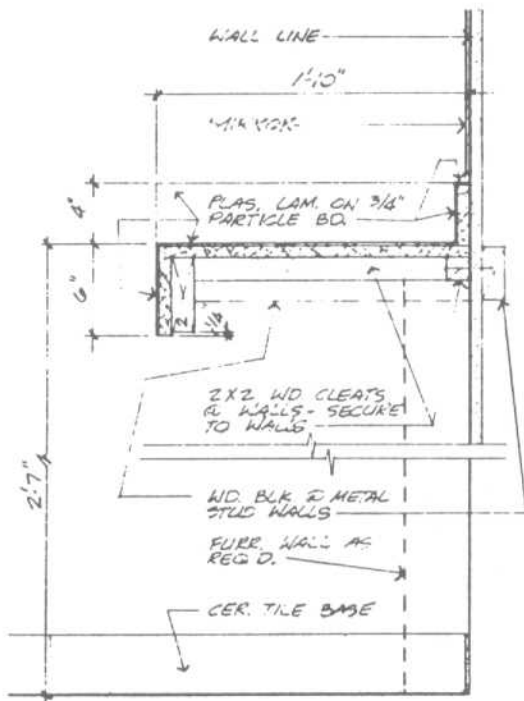
Fig. 15 The large-scale counter detail shown here provides all the information needed to construct this essential bathroom element. Not only are the construction details carefully defined and described, but all the other design relationships are clearly shown. Note the relationships of the mirror, soap dispenser, and lavatory to the plastic laminate counter. Other lavatory counter details are shown in Figs. 16 to 19.

RESTROOMS AND TOILETS

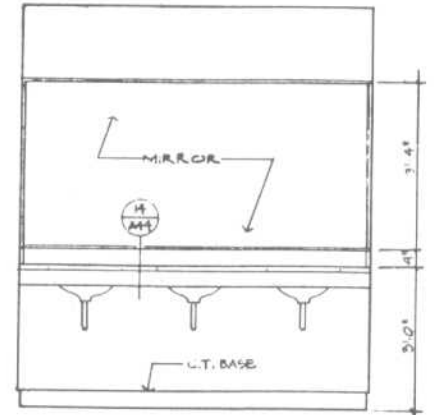
Lavatory Counter Details



SECTION

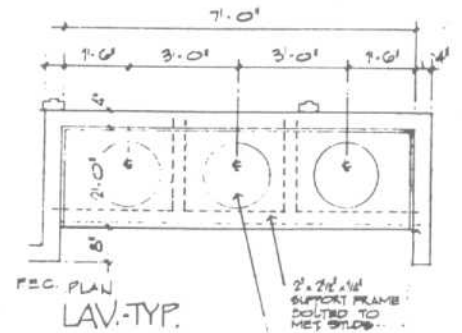


SECTION - LAV. COUNTER

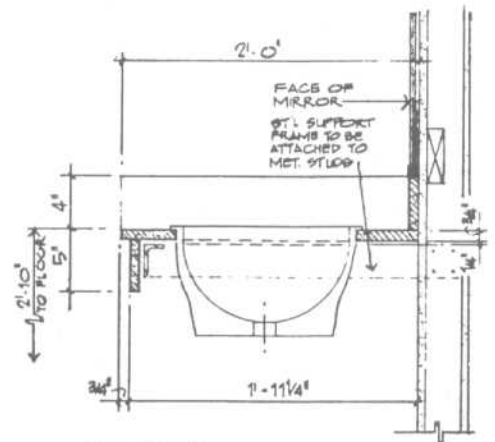


TOILET LAVATORY-TYP

SEE FLOOR PLAN FOR LOCATION AT SLOES TOILETS - 103, 104, 132, 136, 26, 297



P.C. PLAN LAV.-TYP

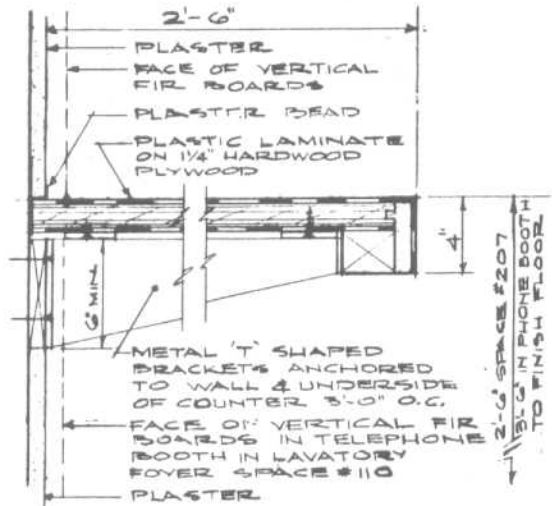
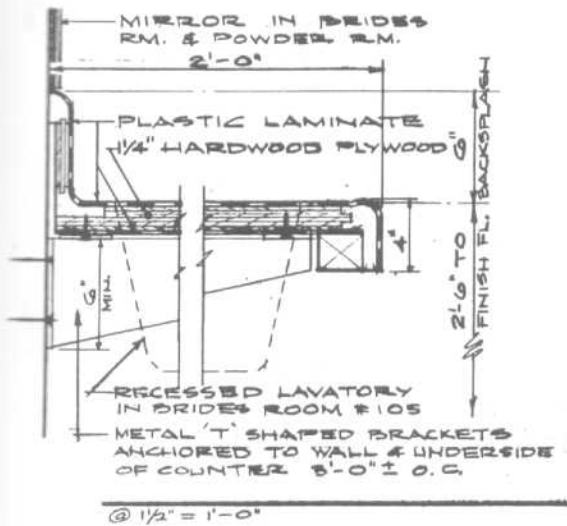


SECT/DETAIL SLO LAVATORIES

Fig. 16

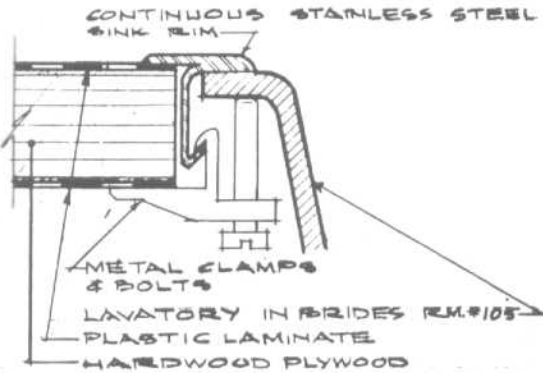
RESTROOMS AND TOILETS

Lavatory Counter Details



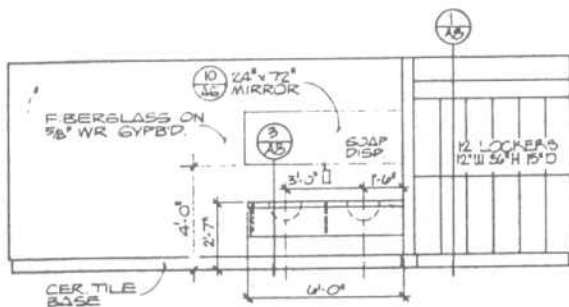
COUNTER DETAILS

@ 1/2" = 1'-0"

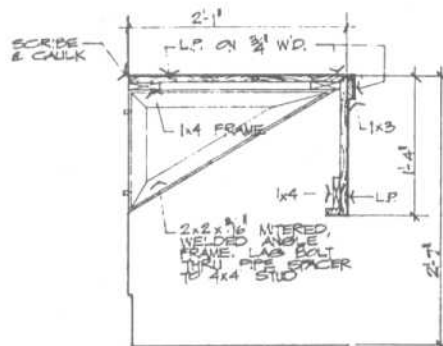


@ FULL SIZE

VANITY DETAILS



223-224 - WEST

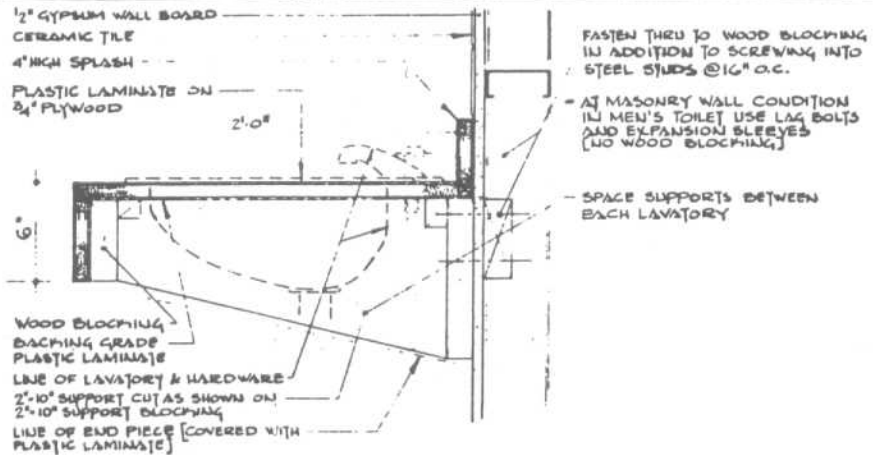
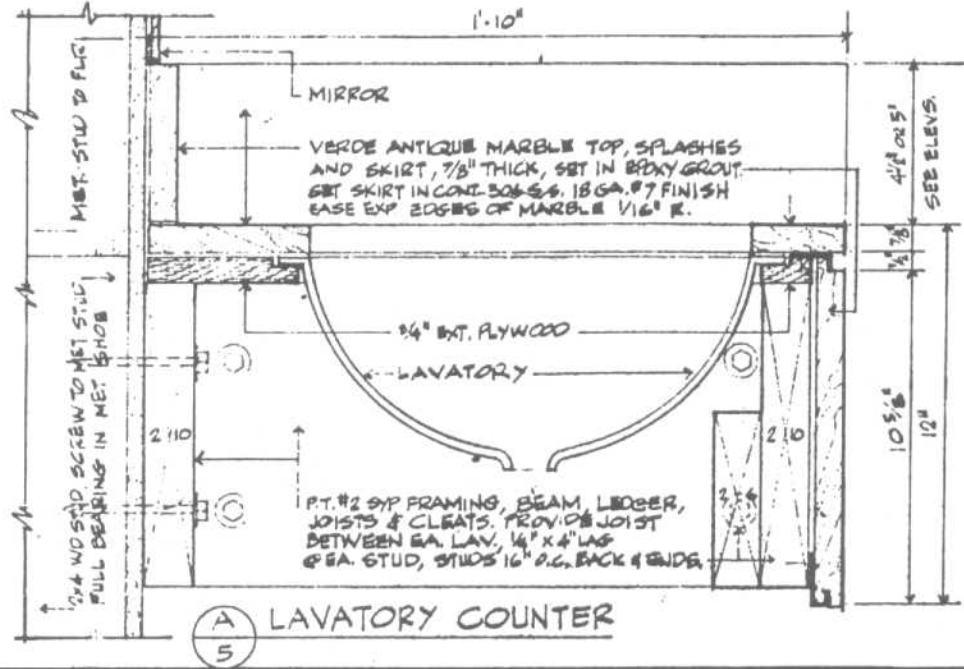


@ 3/16" = 1'-0"

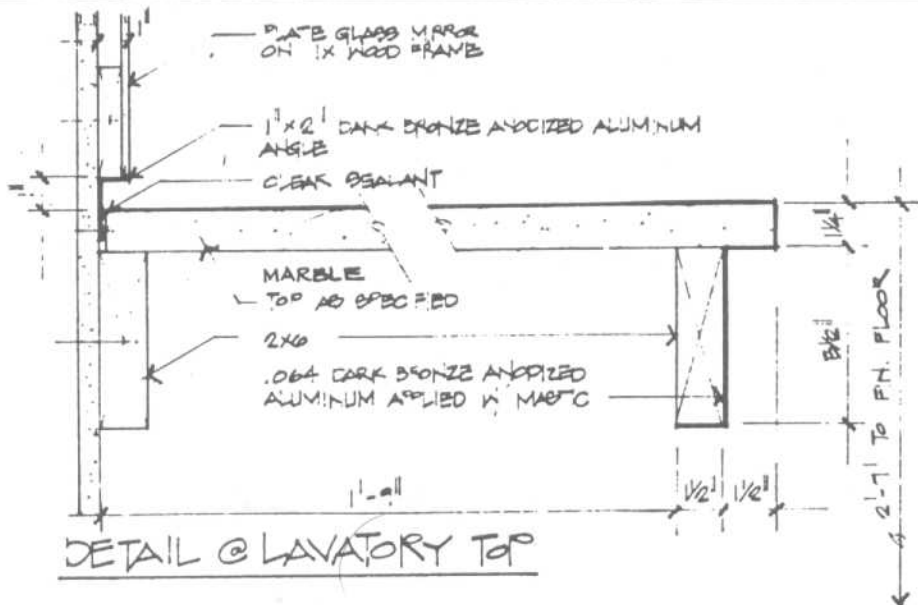
Fig. 17

RESTROOMS AND TOILETS

Lavatory Counter Details



DETAIL @ LAVATORY

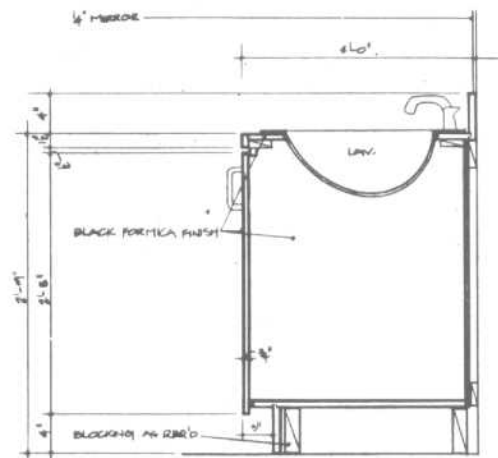




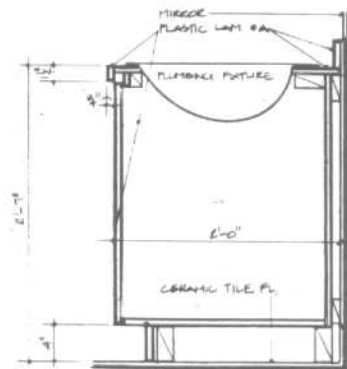


RESTROOMS AND TOILETS

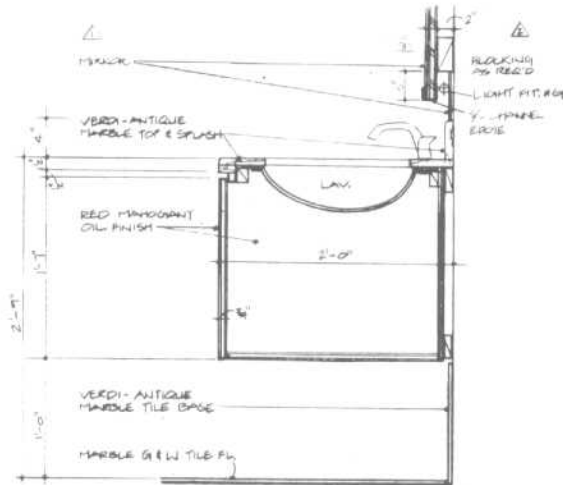
Lavatory Cabinet Details



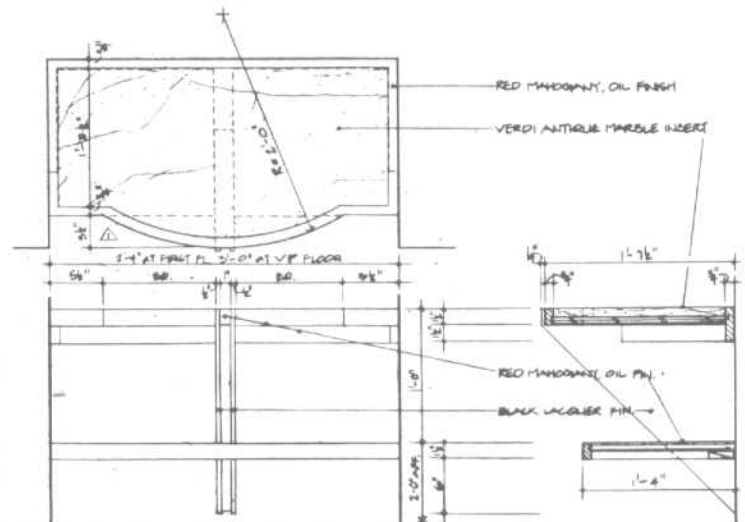
11 CABINET DETAIL AT POWDER ROOM  
SCALE: 1/8" = 1'-0"



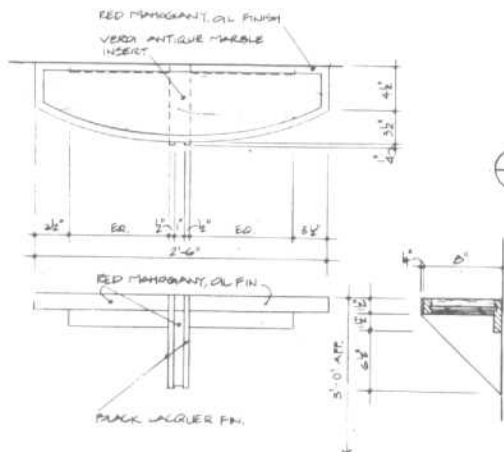
17 DET. OF BATHRM. CABINET  
SCALE: 1/8" = 1'-0"



10 CABINET DETAIL AT WOMEN  
SCALE: 1/8" = 1'-0"



10 PLAN, ELEV. & SECT. OF SHELF AT TELEPHONE NICHE  
SCALE: 1/4" = 1'-0"



17 PLAN, ELEV. & SECT. OF SHELF AT WOMEN  
SCALE: 1/8" = 1'-0"

Fig. 20 Elegantly detailed lavatory cabinets are shown here. Note the use of an exposed oil-finished red mahogany frame or edge surrounding a verdi antique marble top. Complementary telephone shelf details in plan, elevation, and large-scale detail are also shown.

RESTROOMS AND TOILETS

Toilet Stall Details

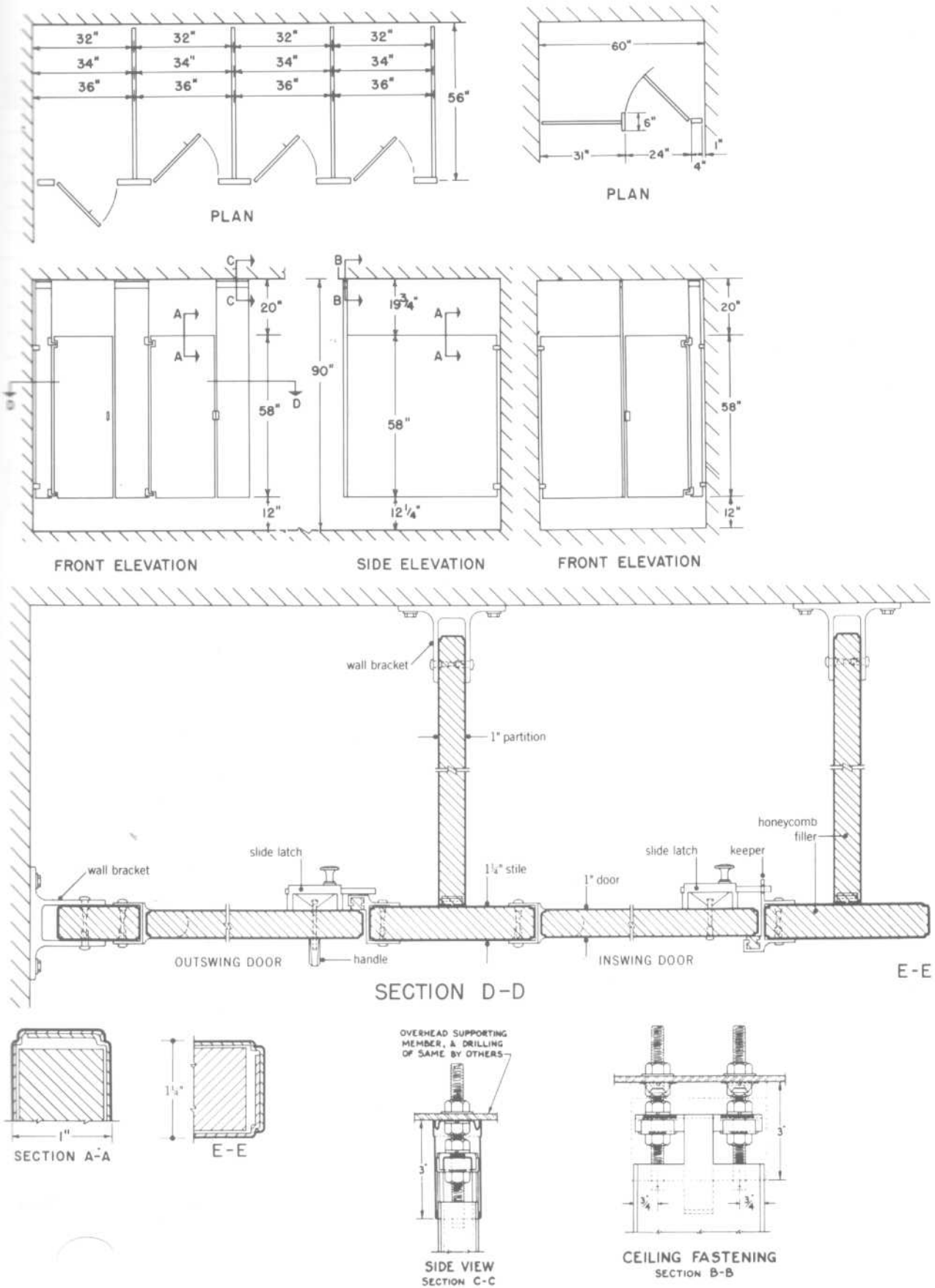


Fig. 21

RESTROOMS AND TOILETS

Toilet Stall Details

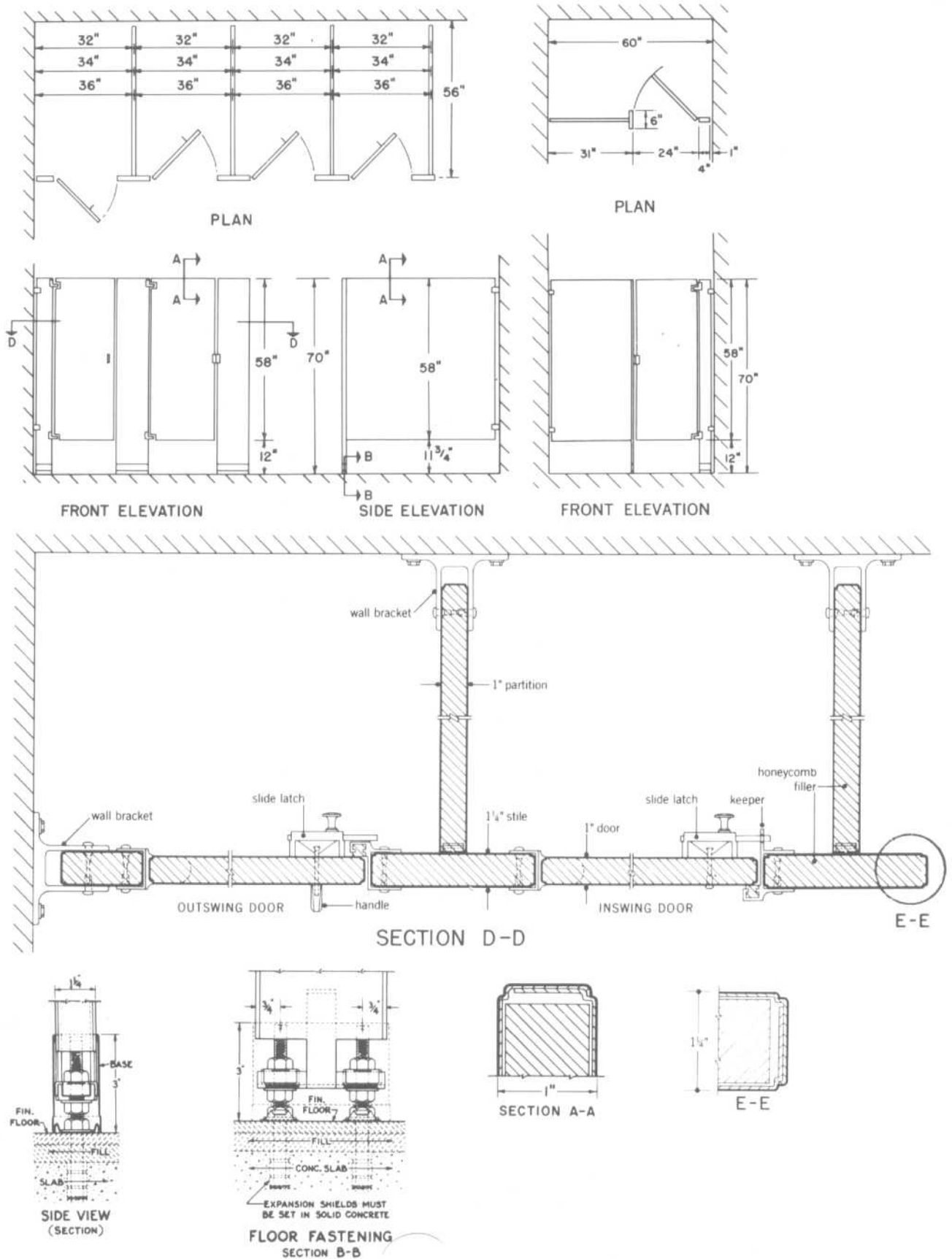
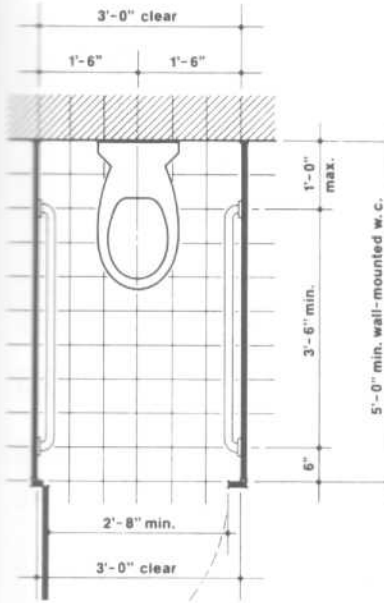


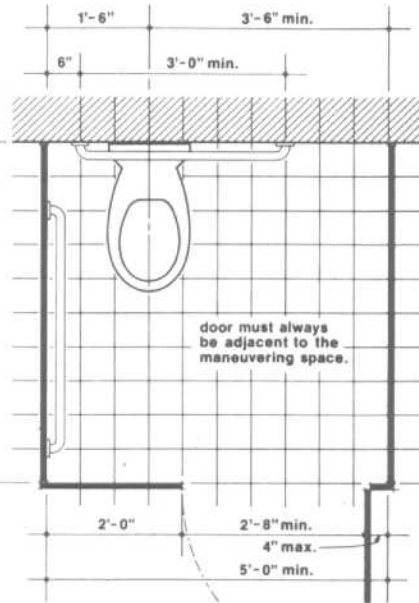
Fig. 22

**RESTROOMS AND TOILETS**

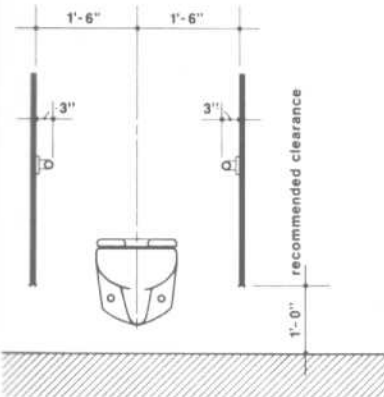
Wheelchair Accessible Design



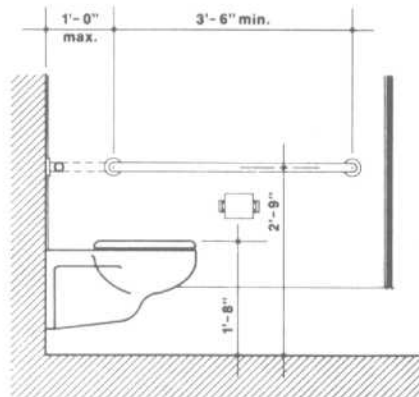
**front transfer** (a)  
scale: 3/8" = 1'-0"



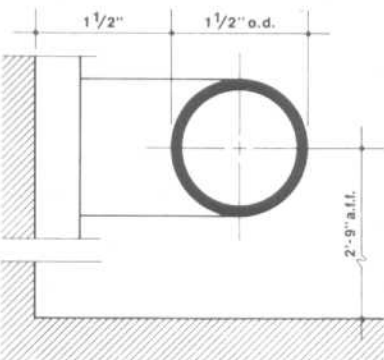
**side transfer** (b)  
scale: 3/8" = 1'-0"



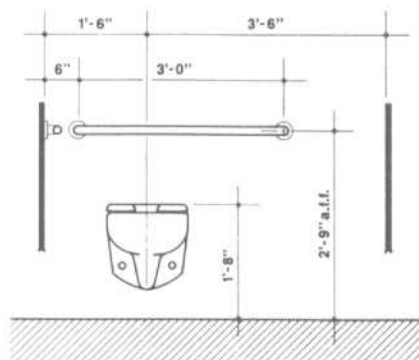
**front transfer** (c)  
scale: 3/8" = 1'-0"



**side elevation** (d)  
scale: 3/8" = 1'-0"



**grab bars** (e)  
scale: half



**section** (f)  
scale: 3/8" = 1'-0"

**TOILET AND RESTROOM DESIGN**

The design data contained on the following pages are intended to illustrate functional accessibility concepts. Some examples illustrate minimum federal requirements, while others are culled from among the various state standards. Designers are cautioned to consult local standards in their respective jurisdictions.

The current minimum federal standard is ANSI A117.1-1986, published by the American National Standards Institute, Inc. It specifies a stall typified by detail a/3. This "front transfer" type stall requires a watercloset mounted at 1'8" a.f.f., preferably wall hung. Stall doors must be outswinging.

Because a significant portion of people using wheelchairs cannot transfer in this manner, the side transfer stall (b/3) has been developed. Clear stall dimensions and seat heights vary somewhat with jurisdiction. Most standards that address side transfer stalls require lower seat heights with 15"-17" mounting heights being typical.

We recommend locking devices for doors that do not require twisting and grasping motions, avoidance of foot operated flush valves, installation of ceiling or wall-hung partitions as practical, and avoidance of curtains in lieu of doors.

Federal standards mandate grab bars of 1 1/2" o.d. The bars must be securely mounted 1 1/2" clear from the wall or partition. This mounting distance is critical, as it provides a "cradle" for a forearm during transfer or if a user loses her or his grip.

**RESTROOMS AND TOILETS**

**Wheelchair Accessible Design**

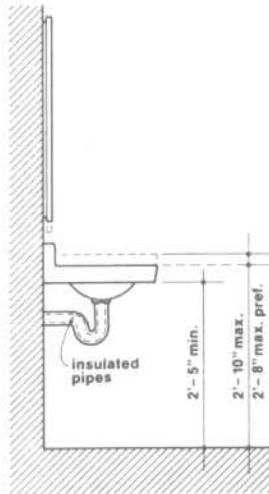
Lavatories need not be specialized designs to be accessible. Utilization of clearances shown will do much to make lavatories accessible. Because persons with loss of sensation in their legs cannot feel pain (and because they heal at a slower rate), hot water lines and drains must be insulated. Also, under several state codes, faucets are required to be lever, blade, or multi-arm handle operated.

Single lever controls are preferable. Spring-operated faucets must have time delay devices.

At least one mirror must be located with the reflecting surface mounted at 3'4" a.f.f. (3'2" or lower preferable). Where possible, full-length mirrors are preferable.

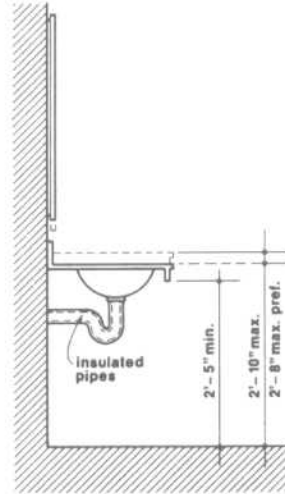
At least one of each type of toilet accessory must also be located at 3'4" a.f.f. or less. Note that this dimension is measured to the highest control required for operation. Controls that require twisting and grasping motions should be avoided.

Because people that use wheelchairs require increased fluid intake, drinking fountains become more than convenience items. While there is not space here to address all configurations, the following concerns are typical to all: controls should be operable without the need for precise grasping; the faucet should not direct spray away from the user and must be located as near the front edge as practical; the units must be free of sharp edges and corners and overhead obstructions.



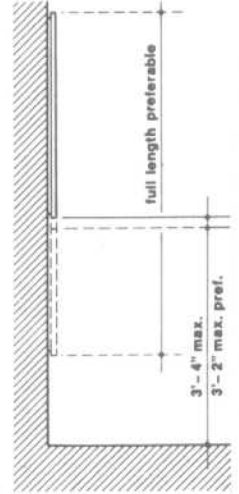
**lavatory**

scale: 3/8" = 1'-0"

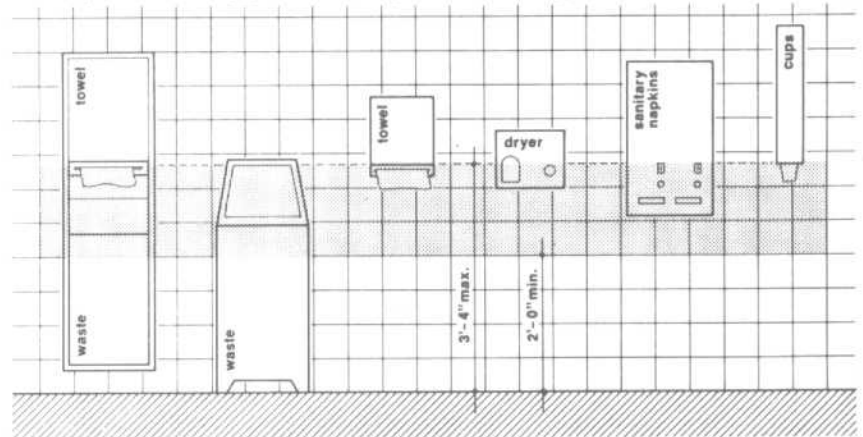


**lavatory**

scale: 3/8" = 1'-0"

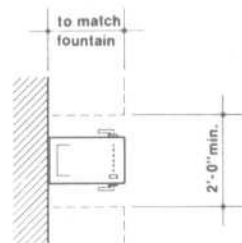


**mirrors**



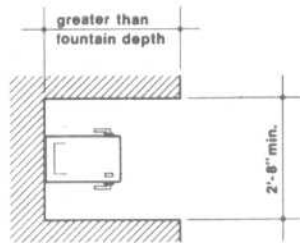
**accessory**

scale: 3/8" = 1'-0"



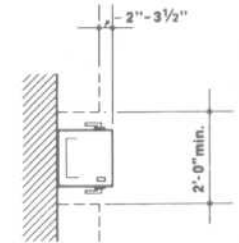
**d.f.**

scale: 1/4" = 1'-0"

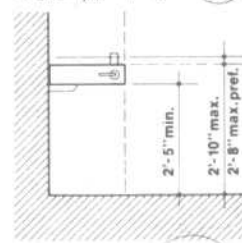


**alcove**

scale: 1/4" = 1'-0"

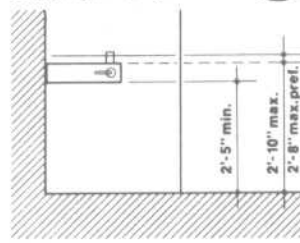


**e.w.c.**



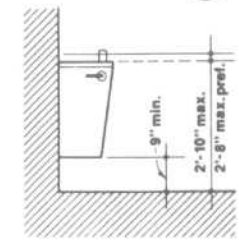
**d.f.**

scale: 1/4" = 1'-0"



**alcove**

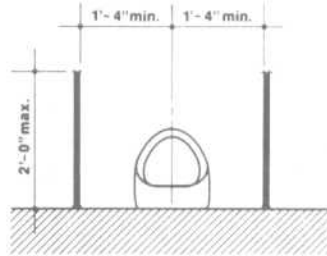
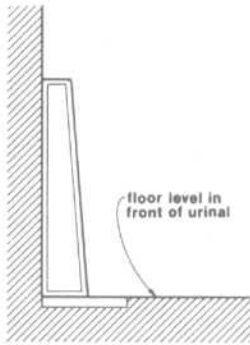
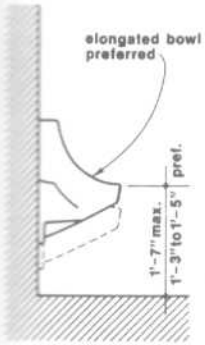
scale: 1/4" = 1'-0"



**e.w.c.**

RESTROOMS AND TOILETS

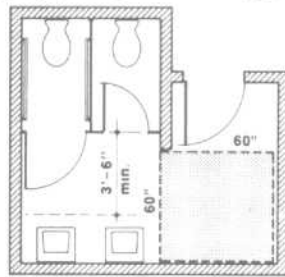
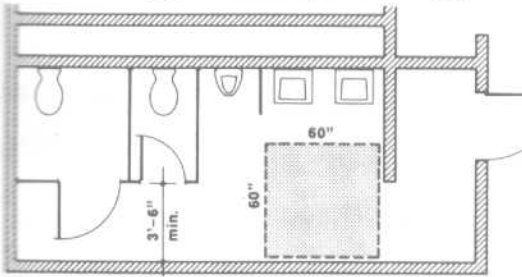
Wheelchair Accessible Design



**urinal** g  
3

**urinal** h  
3  
scale: 3/8" = 1'-0"

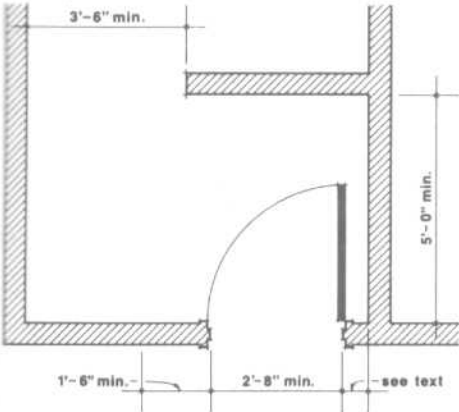
**urinal** i  
3  
scale: 3/8" = 1'-0"



**clearances**

scale: 1/8" = 1'-0"

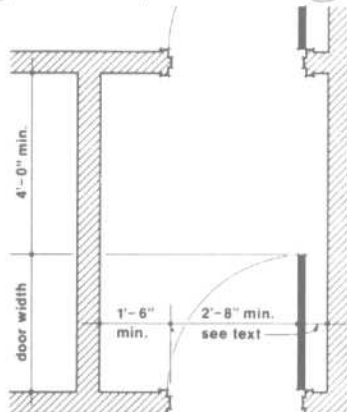
j  
3



**clear.**

scale: 1/8" = 1'-0"

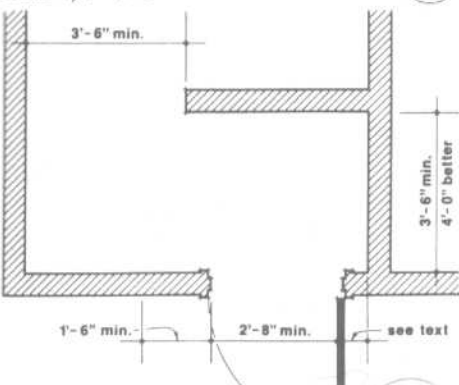
k  
3



**clearances**

scale: 1/4" = 1'-0"

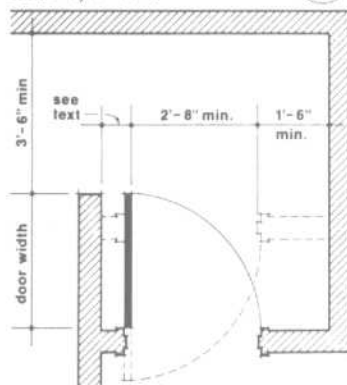
l  
3



**clearances**

scale: 1/4" = 1'-0"

m  
3



**clearances**

scale: 1/4" = 1'-0"

n  
3



**clearances**

scale: 1/4" = 1'-0"

o  
3



Urinals, if provided, should have elongated bowls with the opening of the basin located at 19" a.f.f. or less, or mounted level with the main floor. Many state standards specify maximum mounting heights of 15"-16" a.f.f. These lower dimensions are preferable.

The toilet room itself should provide a clear floor area with minimum dimensions of 60" x 60" to facilitate maneuvering wheelchairs. Additionally, provide a minimum of 3'6" clearance in front of accessible toilet stalls to facilitate entry.

Similarly, adequate clearances must be provided at entrances. The spaces shown in details l/3 to o/3 represent typical dimensions specified in state codes. Note, however, that federal and many state standards require 12" clear jamb areas adjoining both sides of all doors. A clearance of 18" or more on the strike side of a door is more effective. In vestibules having doors in series, there must be space for a wheelchair to clear one door prior to opening another.

RESTROOMS AND TOILETS

Wheelchair Accessible Design

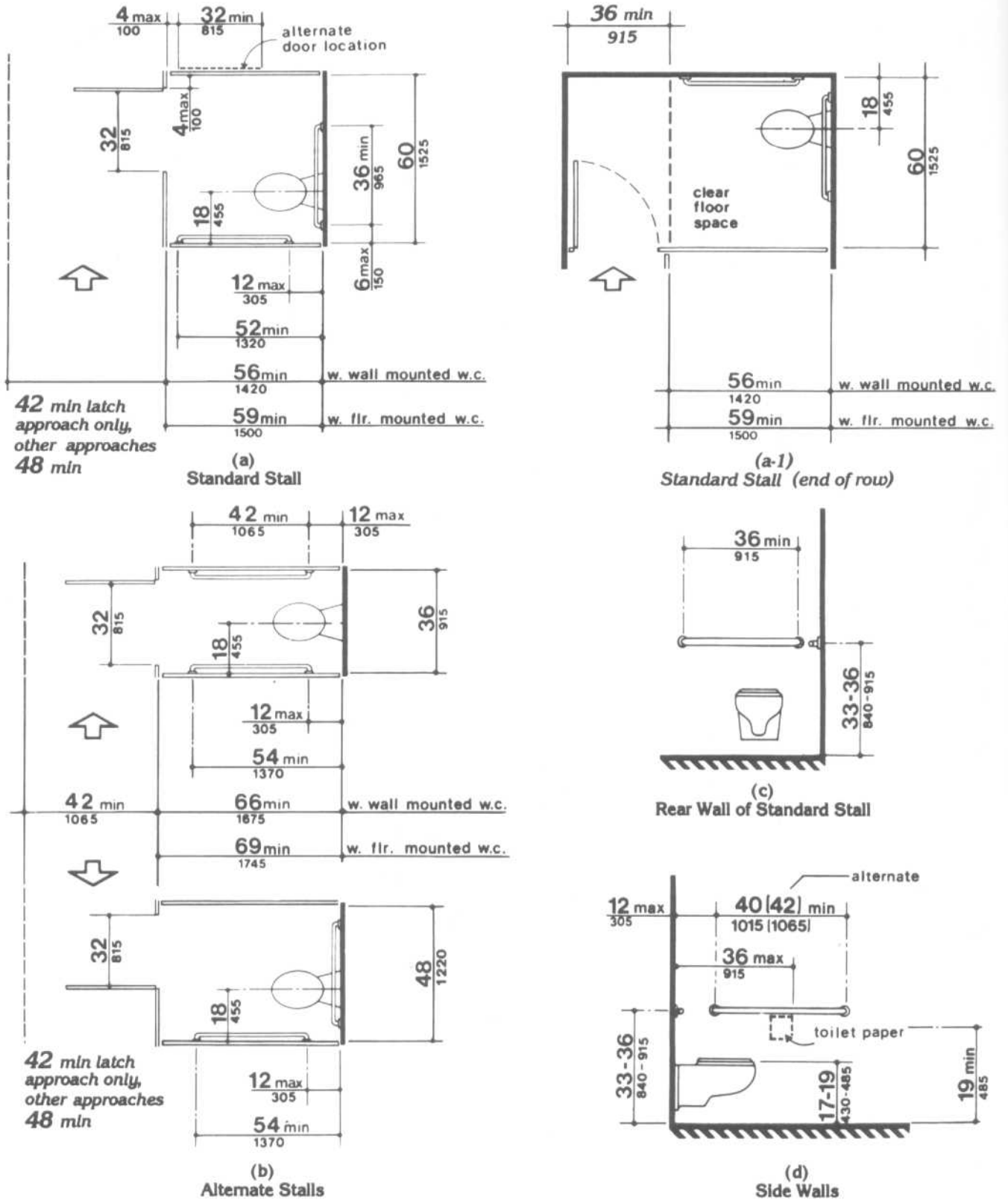


Fig. 23 Toilet stalls.



RESTROOMS AND TOILETS

Toilet Accessories

In Figs. 24 to 30, various generic toilet accessories and grab bar configurations are illustrated. While most manufacturers have similar accessories and grab bars within their catalogs, overall dimensions and methods of

installation vary greatly. Placement of accessories in relationship to plumbing fixtures, door swings, and interior circulation is to be carefully studied by the designer.

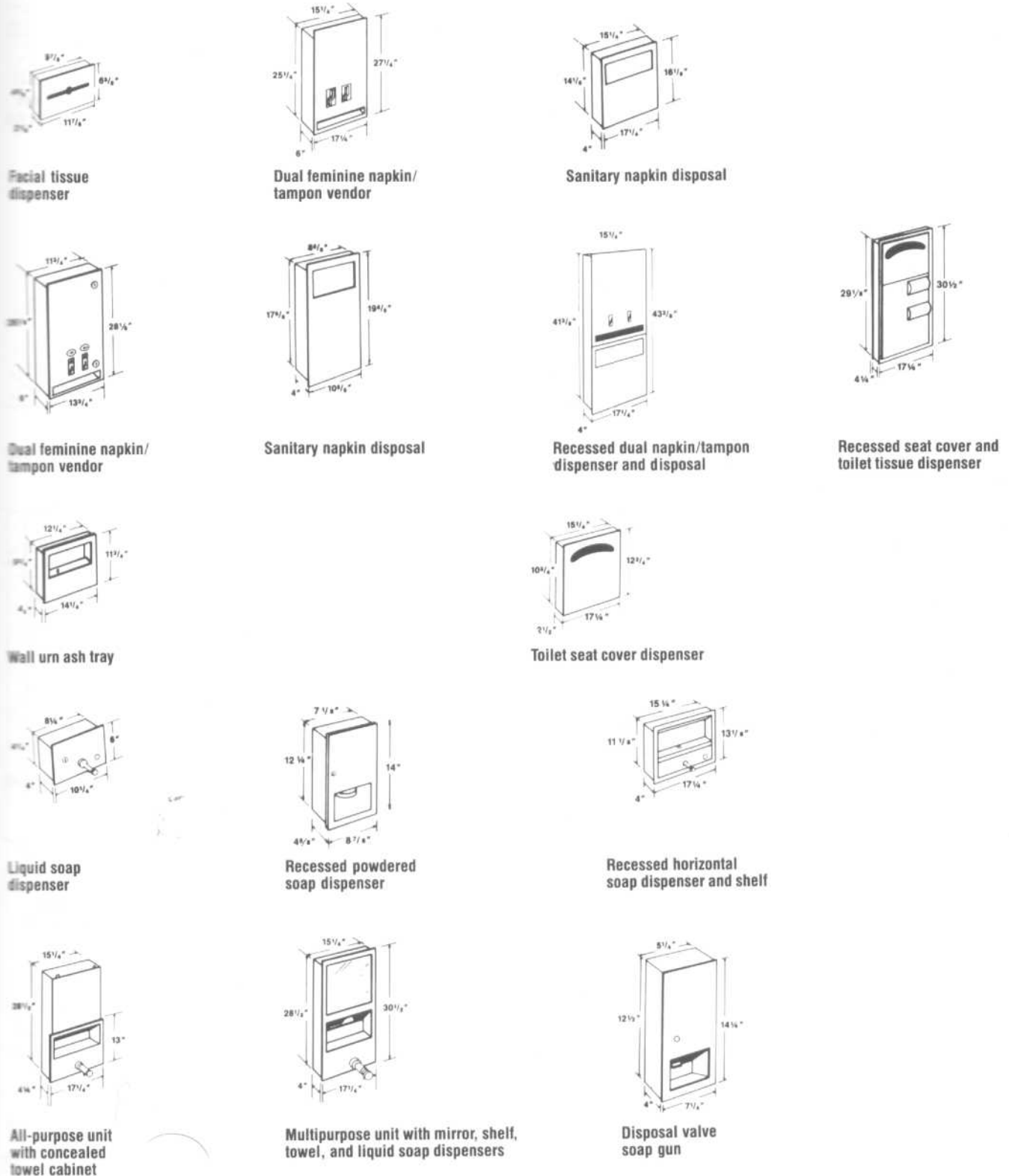
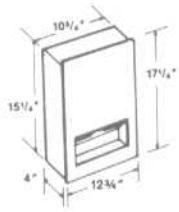


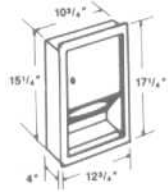
Fig. 24

RESTROOMS AND TOILETS

Toilet Accessories



Paper towel dispenser



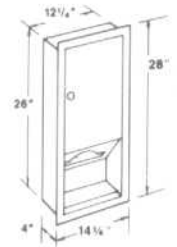
Paper towel dispenser



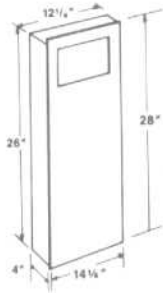
Paper towel dispenser and disposal



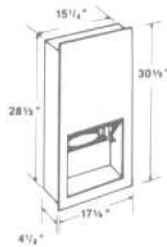
Paper towel dispenser



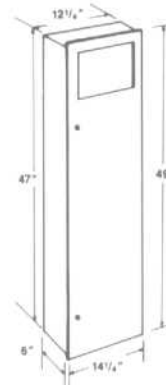
Paper towel dispenser



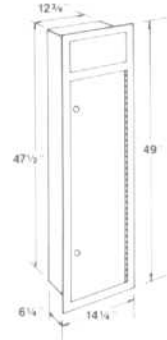
Paper towel disposal



Towel dispenser and Disposa-Valve soap gun



Paper towel disposal



Paper towel disposal



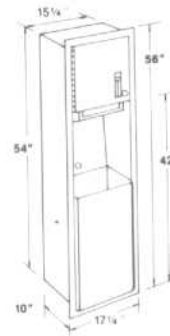
Paper towel dispenser and disposal



Paper towel dispenser and covered disposal



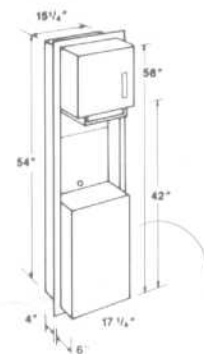
Paper towel dispenser and disposal



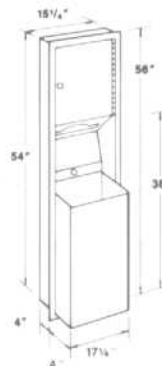
Roll paper towel dispenser and disposal



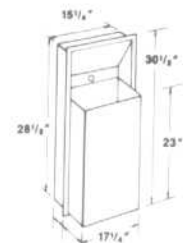
Paper towel dispenser and disposal



Roll paper towel dispenser and disposal



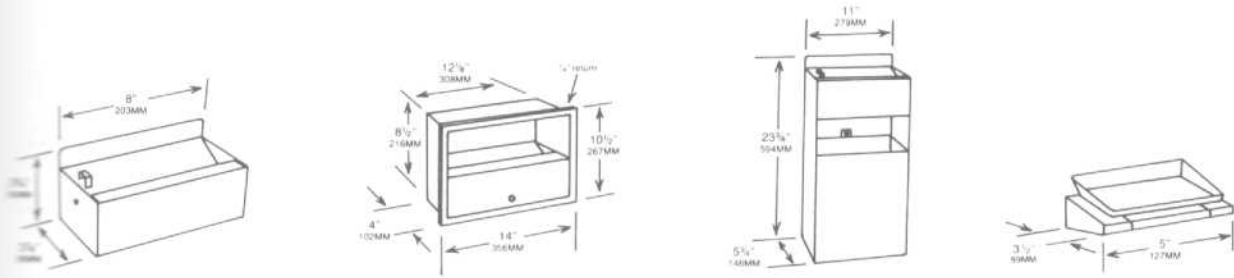
Paper towel dispenser and disposal



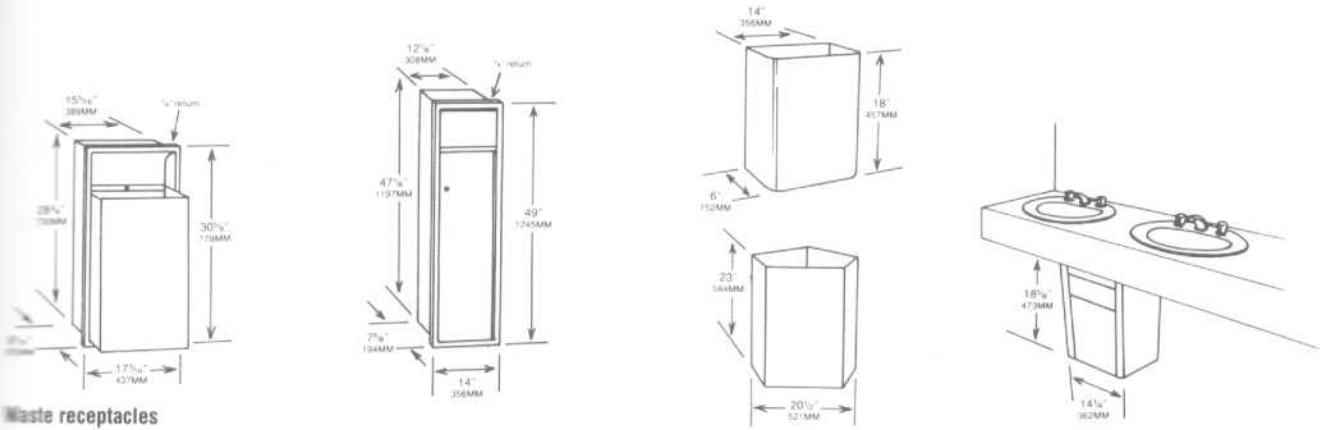
Semirecessed waste receptacle

RESTROOMS AND TOILETS

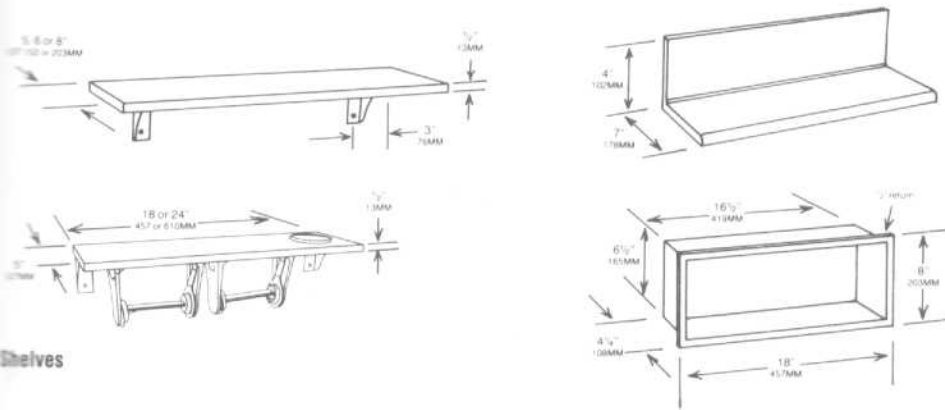
Toilet Accessories



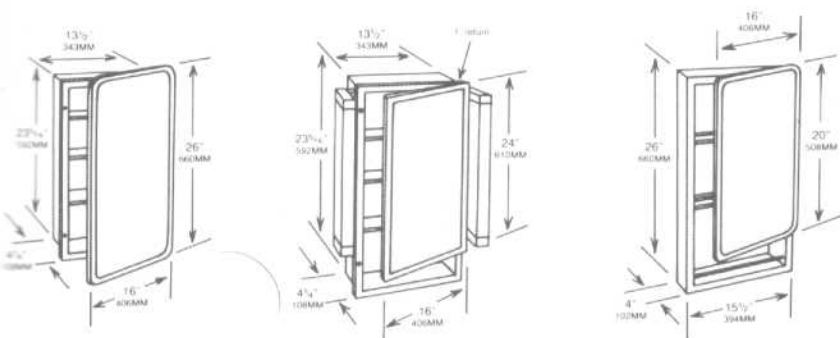
Bath trays



Waste receptacles



Shelves

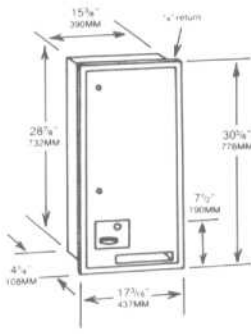


Medicine cabinets

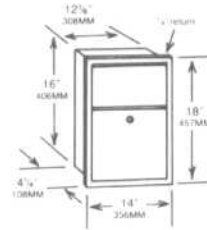
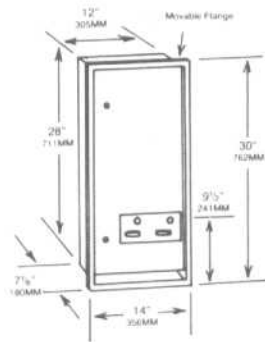
Fig. 26

RESTROOMS AND TOILETS

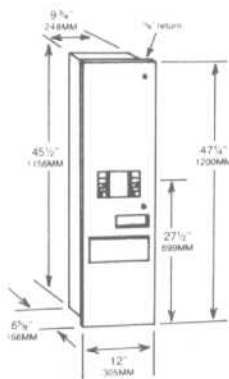
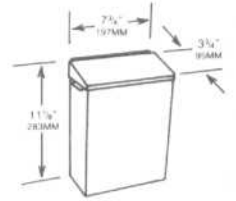
Toilet Accessories



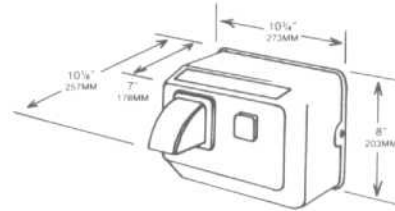
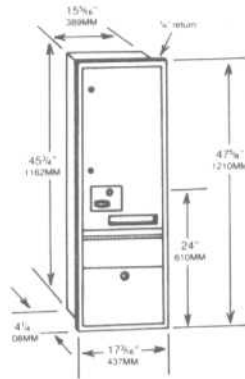
Sanitary napkin dispensers



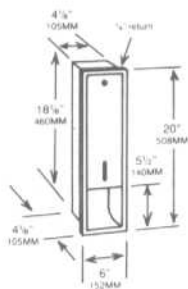
Sanitary napkin disposals



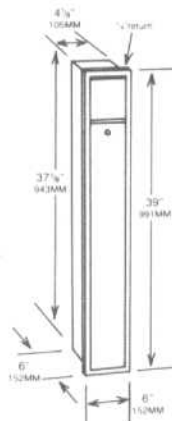
Combined sanitary napkin dispenser and disposal



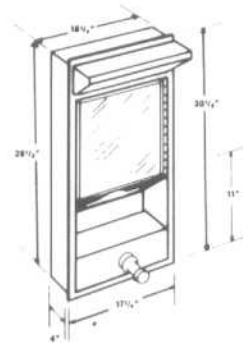
Hand and hair dryers



Paper cup dispenser



Paper cup disposal



Multipurpose cabinet

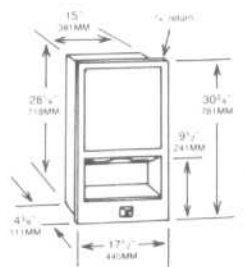
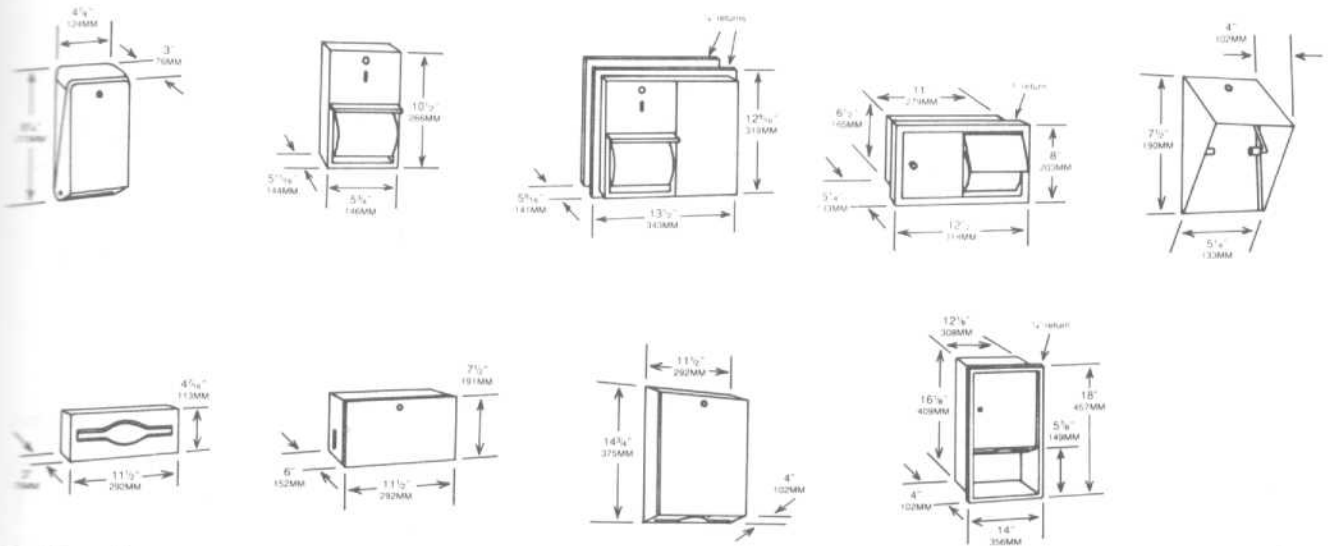


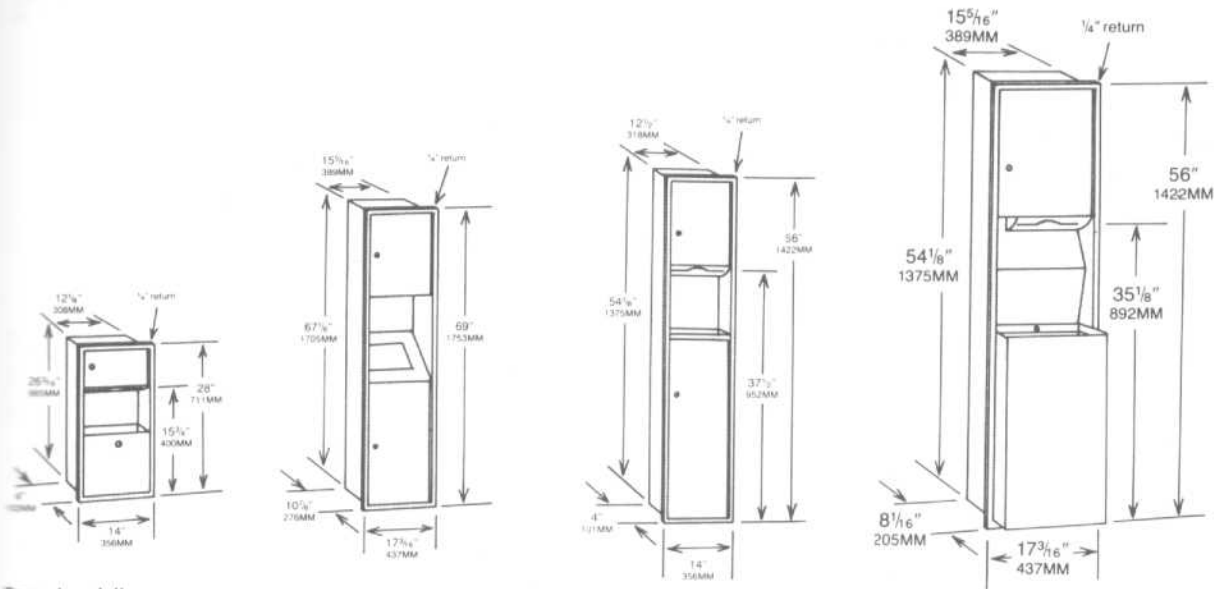
Fig. 27

RESTROOMS AND TOILETS

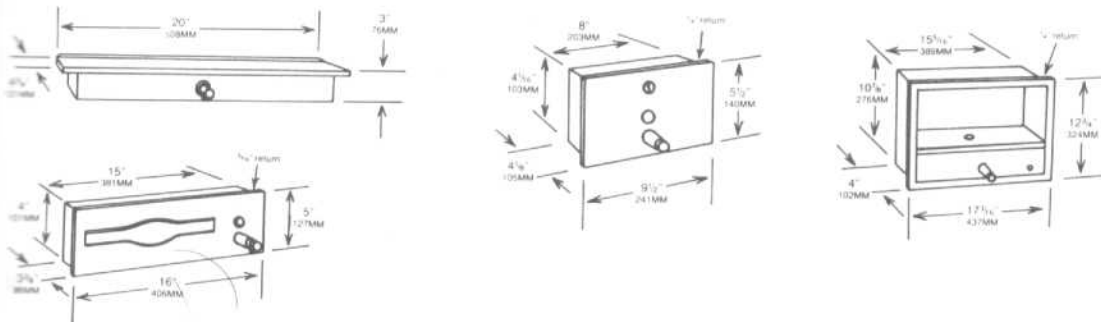
Toilet Accessories



Toilet tissue dispensers



Paper towel dispensers

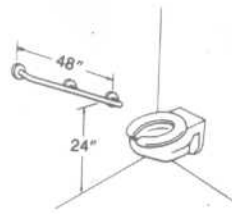
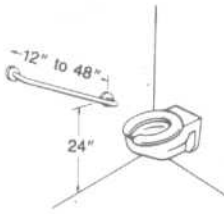


Soap dispensers

Fig. 28

RESTROOMS AND TOILETS

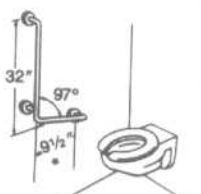
Grab Bar Configurations



left hand shown  
right hand opp.



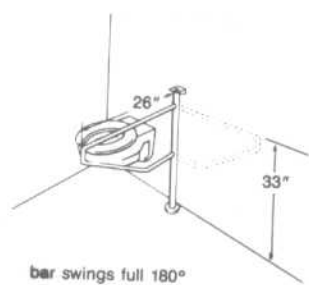
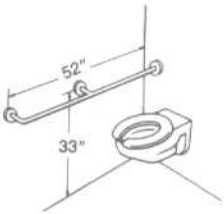
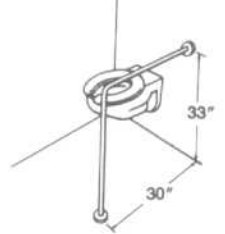
\*This dimension 11" when  
1 1/2" O.D. tubing specified.  
left hand shown  
right hand opp.



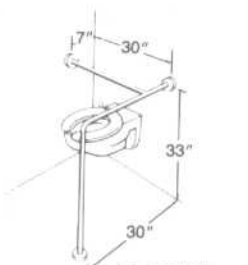
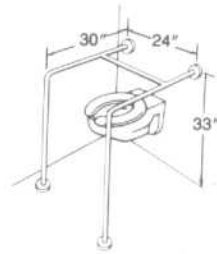
\*This dimension 11" when  
1 1/2" O.D. tubing specified.  
left hand shown  
right hand opp.



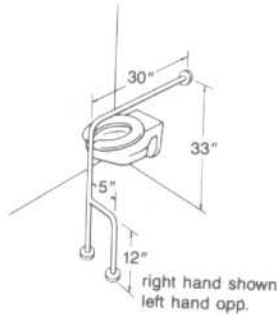
Projects 3" below finished floor,  
has slip flange at floor.



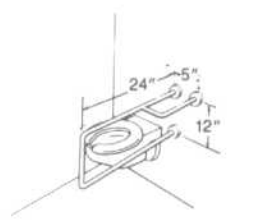
bar swings full 180°



left hand shown  
right hand opp.



right hand shown  
left hand opp.

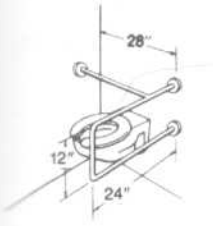


right hand shown  
left hand opp.

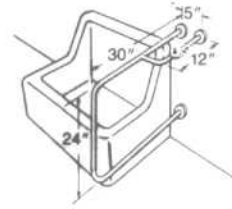
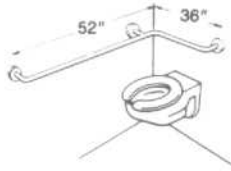
Fig. 29

RESTROOMS AND TOILETS

Grab Bar Configurations



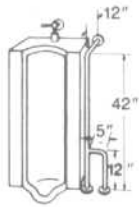
right hand shown  
left hand opp.



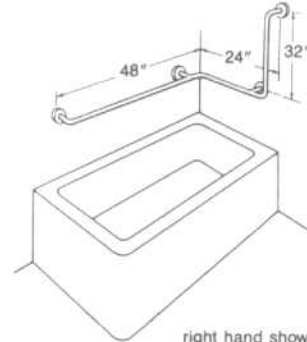
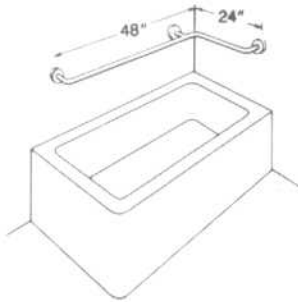
right hand shown  
left hand opp.



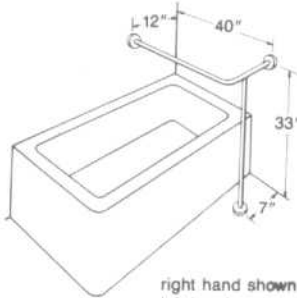
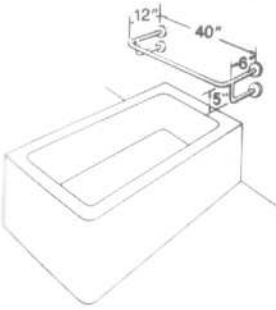
right hand shown  
left hand opp.



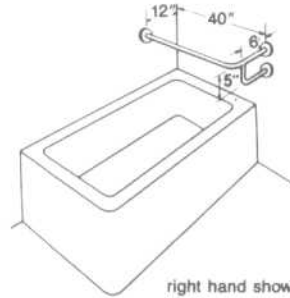
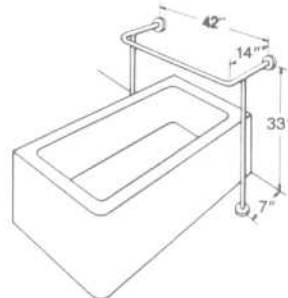
right hand shown  
left hand opp.



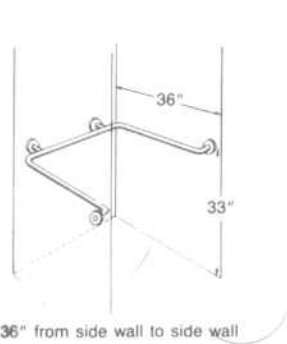
right hand shown  
left hand opp.



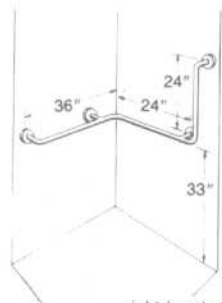
right hand shown  
left hand opp.



right hand shown  
left hand opp.



36" from side wall to side wall



right hand shown  
left hand opp.

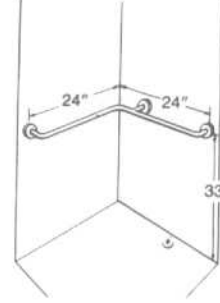
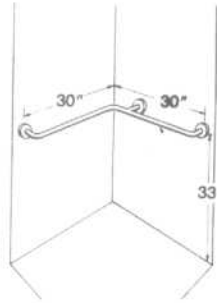


Fig. 30

## COATROOMS

## Floor Area Requirements

Coatrooms typically fall into two categories: those that are self-service and those that are controlled by one or more attendants. The latter category of coatroom can be more compact because only one, or perhaps two, attendants have access to the coats. A self-service coatroom must have more space between rows of coats so that several persons can enter and get their coats.

Self-service coatrooms are susceptible to theft of property, particularly expensive outerwear. Therefore, it is desirable that these coatrooms be visible to someone at all times, such as a maitre d' in a restaurant or a receptionist in an office. In those situations where a supervised self-service coatroom is inappropriate or cannot be provided, self-service keyed locks offer a viable alternative. In addition to being able to provide secure coat storage, lockers can also store briefcases, packages, or other encumbrances.

TABLE 1 Floor Area Requirements for Public Coatrooms

Number of coats (capacity)	Floor area (with attendant)		Floor area (without attendant)	Floor area (electric conveyor)		
	Min	Max				
50	35	50	40	60	N/A	N/A
100	65	85	80	100	80	100
150	90	120	110	145	110	125
200	125	150	150	180	140	150
250	150	190	180	230	100	110
300	180	225	215	270	125	140
350	200	260	240	300	135	150
400	225	275	270	330	150	160
450	260	320	310	370	160	175
500	300	365	425	430	175	190
750	450	500	540	600	250	275
1000	600	650	720	780	325	350
1500	800	900	950	1080	450	480
2000	1000	1250	1200	1500	600	675
3000	1600	1850	1900	2200	1000	1150

*Note:* The above floor areas are approximate and should only be used for preliminary space planning requirements.

Since the number of coats per linear foot of hanging can vary from 4 to 8, the floor area can vary dramatically. A lightweight overcoat, for example, can measure 1–1.5 inches in width. A medium weight to heavyweight coat might measure from 2 to 4 inches. A fur coat might require a minimum of 4–6 in. The designer must consider the overall size of coatroom based upon the following critical factors: (1) geographic location/climate; (2) attendants required or not required; (3) aisle clearance; (4) peak entry/exit loads for coat retrieval; (5) assumed garment thickness or garments per linear foot; (6) linear feet of counter surface and overhead shelving; and (7) other storage components, i.e., hats, umbrellas, briefcases, packages, etc.



## COATROOMS

## Types of Checkroom Systems

Three basic types of manufactured or prefabricated coat storage units are shown in Figs. 1 to 3. Exact coat storage capacities are provided by the manufacturer. All units can be customized to suit various room configurations. Note the adjoining counter space to speed operations. Coat capacities relative to length are listed in Table 2.

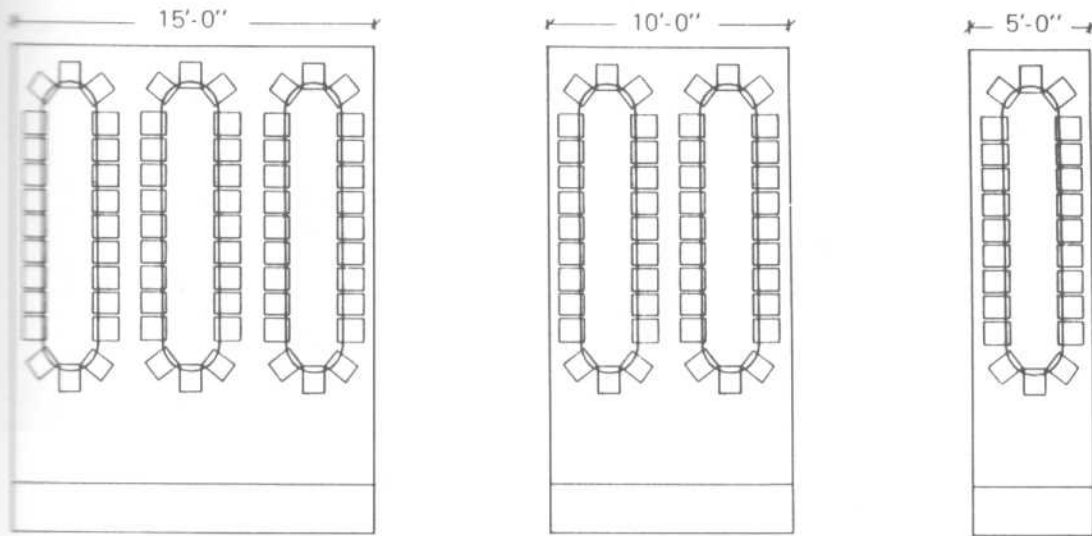


Fig. 1 Electric carousel coat storage.

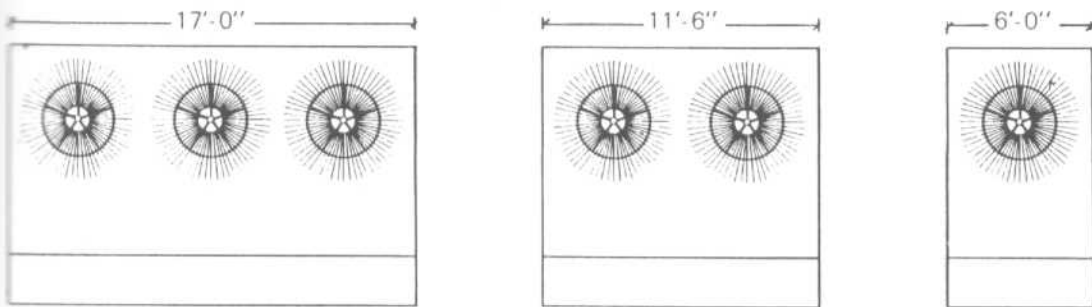


Fig. 2 Rotating reels coat storage.

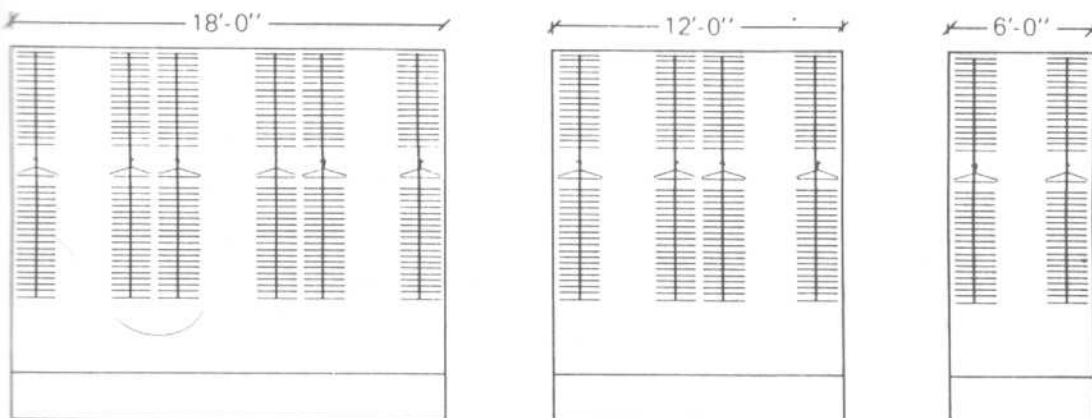


Fig. 3 Stationary coat storage.

**COATROOMS**

Electric Checkroom Systems

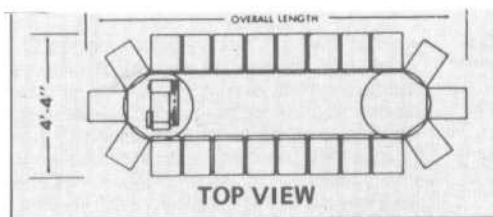


Fig. 4

TABLE 2

Overall length with garments*	Length of hanging capacity	Coat capacity: no. of slots†
7' 5"	13' 0"	144
7' 11 1/2"	14' 1"	156
8' 6"	15' 2"	168
9' 1"	16' 3"	180
9' 7"	17' 4"	192
10' 1 1/2"	18' 5"	204
10' 8"	19' 6"	216
11' 2 1/2"	20' 7"	228
11' 9"	21' 8"	240
12' 3 1/2"	22' 9"	252
12' 10"	23' 10"	264
13' 4 1/2"	24' 11"	276
13' 11"	26' 0"	288
14' 5 1/2"	27' 1"	300
15' 0"	28' 2"	312
15' 6 1/2"	29' 3"	324
16' 1"	30' 4"	336
16' 7 1/2"	31' 5"	348
17' 2"	32' 6"	360
17' 8 1/2"	33' 7"	372
18' 3"	34' 8"	384
18' 9 1/2"	35' 9"	396
19' 4"	36' 10"	408
19' 10 1/2"	37' 11"	420
20' 5"	39' 0"	432
20' 11 1/2"	40' 1"	444
21' 6"	41' 2"	456
22' 0 1/2"	42' 3"	468
22' 7"	43' 4"	480
23' 1 1/2"	44' 5"	492
23' 8"	45' 6"	504
24' 2 1/2"	46' 7"	516
24' 9"	47' 8"	528
25' 3 1/2"	48' 9"	540
25' 10"	49' 10"	552
26' 4 1/2"	50' 11"	564
26' 11"	52' 0"	576
27' 5 1/2"	53' 1"	588
28' 0"	54' 2"	600

\*Add 4" minimum clearance to each end and each side when adjacent to walls, columns, obstructions, or other machines.

†This provides 1.1" per coat. In areas or facilities where bulky coats are customary, the actual capacity may be reduced one-third.

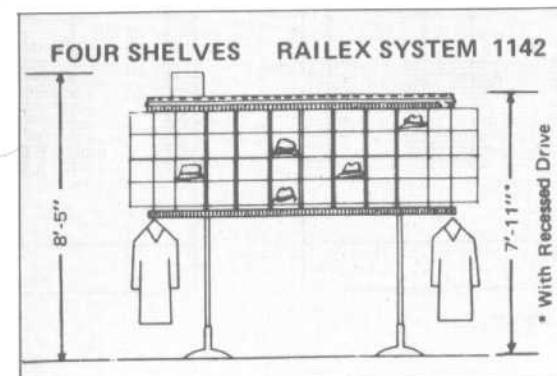
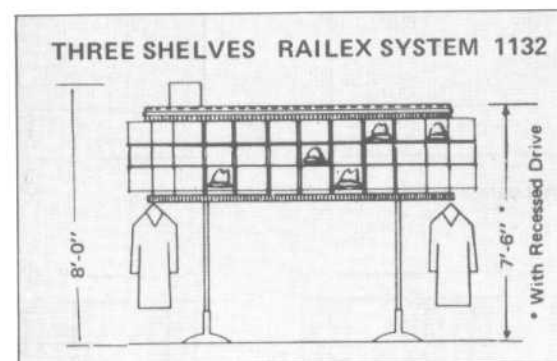
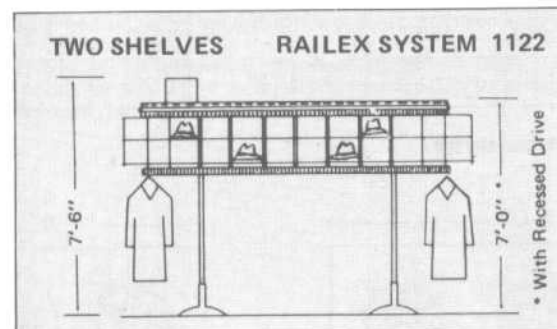
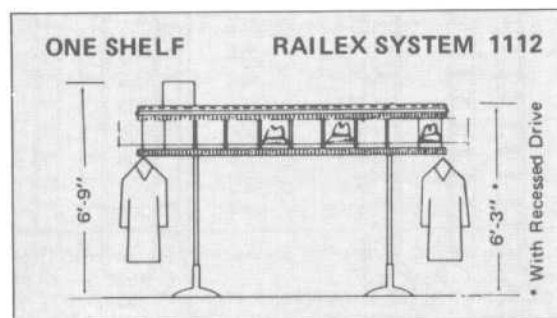
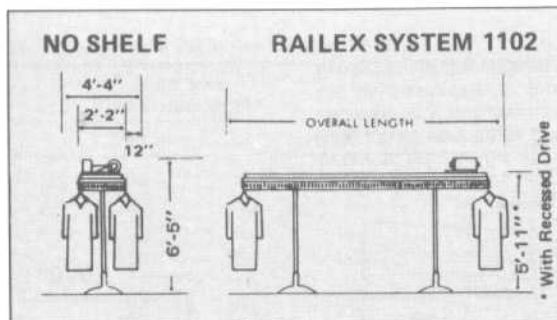
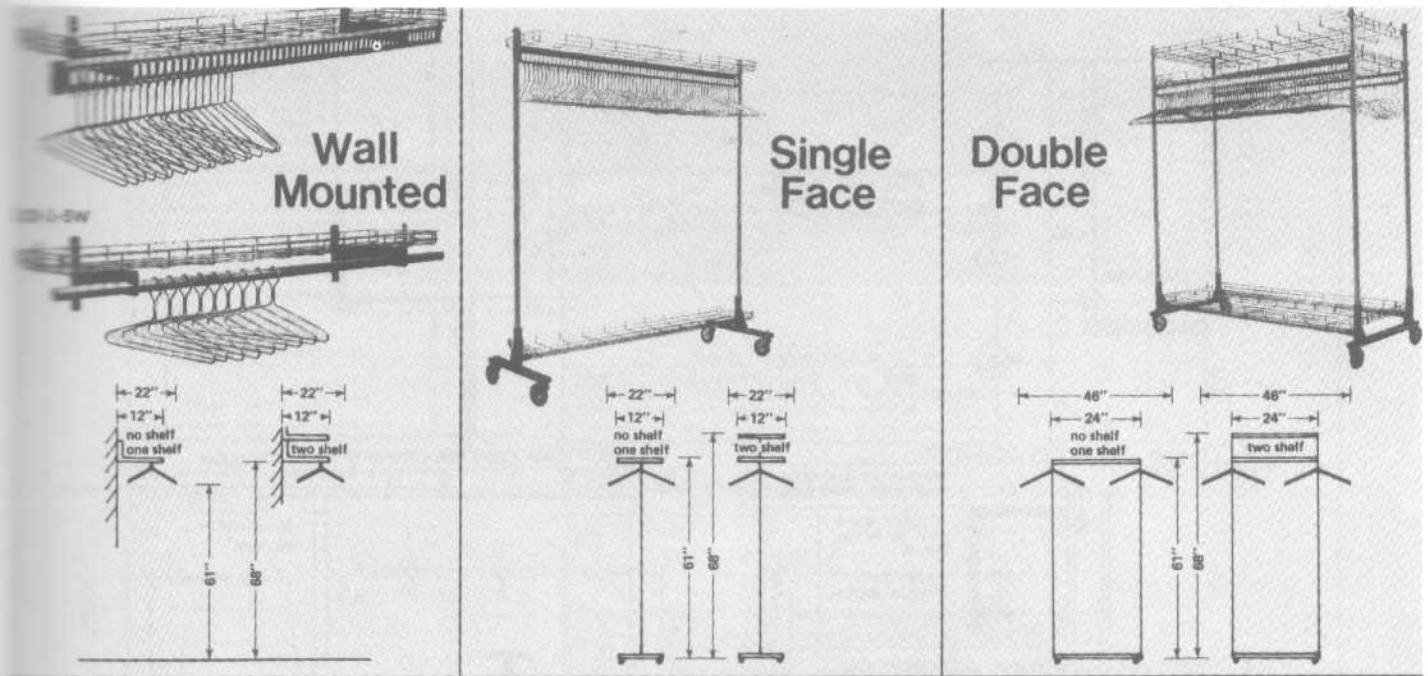


Fig. 5

**COATROOMS**

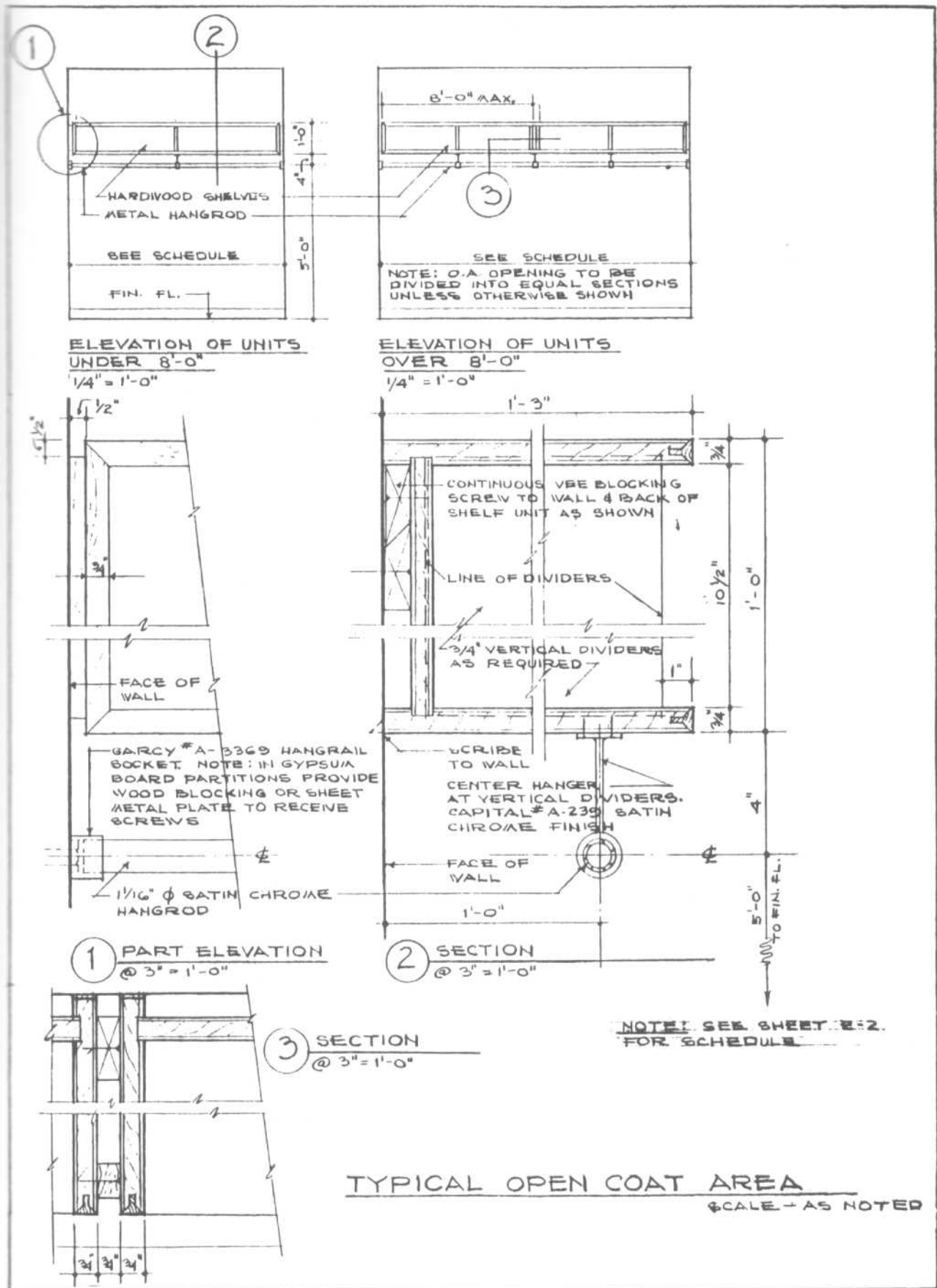
Stationary Checkroom Systems



	Length	Number of Coats	Number of Shelves
<b>Wall Mounted</b>	3'-0"	36	0 1 2
	4'-0"	48	0 1 2
	5'-0"	60	0 1 2
<b>Single Face</b>	3'-4"	36	0 1 2
	4'-4"	48	0 1 2
	5'-4"	60	0 1 2
<b>Double Face</b>	3'-4"	72	0 1 2
	4'-4"	96	0 1 2
	5'-4"	120	0 1 2



**COATROOMS**  
Coatroom Shelves Details





# 2

## Construction Details and Finishes

Partitions and wall finishes	469
Floors and floor finishes	516
Doors	566
Ceilings	641
Stairs	660
Fireplaces	724
Lighting	743





Selecting the appropriate partition or wall type is both a science and an art. In fact, there are so many options available to the designer that it is not unusual to refer to the partition or wall as a system, a combination of framing, sheathing, and finish elements, all working together to meet aesthetic, functional, code, and economic requirements.

In that regard, this section explores the great variety of wall and partition types, examining all of their characteristics with the exception of load bearing capacity and cost of labor and materials. With respect to load bearing or structural capacities, while many of the wall and partition types are able to carry superimposed loads, it is not the intent of this book to discuss structural issues. With respect to cost, too many factors and variables make this a topic that is difficult to analyze with any precision.

Information on both traditional and contemporary partitions and wall types is provided. Many traditional materials and methods of construction, such as solid gypsum plaster and plaster on clay tile, are cited, thus providing information to the designer who is redesigning or altering older structures.

A large portion of this section is devoted to the detailing of contemporary partition systems. In addition to providing examples of partition types, these pages place great emphasis on the detailing of unusual interface conditions that many designers often leave to the contractor to work out in the field. It should be noted that most, if not all, of these details have been selected from the working drawings of outstanding architectural and interior design firms.

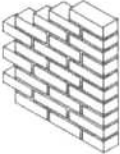
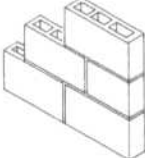
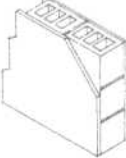
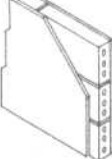

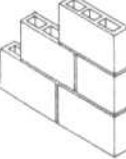

While general information has also been provided about acoustics, sound transmission, and fire ratings of various walls and partitions, the designer is cautioned to verify all such information with manufacturers' certified test results, as well as with those building and fire codes having jurisdiction. It also should be noted that while test results may demonstrate a certain fire rating or sound transmission classification, it is important to determine if the results have been accepted by the local building or fire department.

It is often necessary to apply a finish to a wall or partition. Again, both traditional and contemporary methods to apply wood paneling, ceramic tile, and stone are clearly illustrated through the use of architectural details.

Finally, walls and partitions must ultimately meet floors and ceilings, and, of course, have doors and openings penetrate them. While some examples are provided in this section, the designer will also find important information in the sections Floors and Floor Finishes; Doors; and Ceilings, which follow.

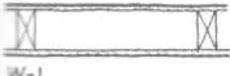
**PARTITIONS AND WALL FINISHES**

Characteristics of Interior Partitions

DRAWING AND DESCRIPTION	FIRE-RATING	SOIL AND DAMAGE RESISTANCE	ACOUSTICS	REMARKS	COST COMPARISON
 <p>4 inch face brick, tooled joints; Actual thickness, 3<math>\frac{5}{8}</math> inches; Weight, 40 lbs. per square foot of wall surface</p>	Incombustible, with one hour fire-rating	Good	Very good; transmission loss, 45 decibels	Low maintenance, but limited flexibility; a good-looking wall, but poor light reflection	installation cost  maintenance and insurance cost for 20 years
 <p>4 inch concrete block, tooled joints, two coats of paint on each side; Actual thickness, 3<math>\frac{5}{8}</math> inches; Weight, 30 lbs. per square foot</p>	Incombustible, with one hour fire-rating	Good	Good; transmission loss, 40 decibels	Inexpensive; attractive if constructed neatly; frequently used for corridors, gyms, assembly rooms, etc.; no flexibility	
 <p>4 inch cinder block, <math>\frac{3}{4}</math> inch layer of plaster on each side, 2 coats of paint on each side; Actual thickness, 5<math>\frac{1}{4}</math> inches; Weight, 30 lbs. per square foot</p>	Incombustible, with two hour fire-rating	Poor	Good; transmission loss, 43 decibels	A smooth, dense finish; a good light reflector if painted a light color; no flexibility	
 <p>3 inch cinder block, <math>\frac{3}{4}</math> inch layer of plaster on each side, 2 coats of paint on each side; Thickness, 4<math>\frac{1}{2}</math> inches; Weight, 21 lbs. per square foot</p>	Incombustible, with two hour fire-rating	Poor	Good; transmission loss, 39 decibels	A smooth, dense finish; a good light reflector if painted a light color; no flexibility	
 <p>4 inch structural facing tile, glazed on each side; Actual thickness, 3<math>\frac{3}{4}</math> inches; Weight, 40 lbs. per square foot</p>	Incombustible, with a fire-rating of less than one hour	Very good	Good; transmission loss, 35 decibels	Used well in classrooms, corridors, also in toilets and showers; care must be taken with the design to avoid bright reflectivity; no flexibility	
 <p>4 inch concrete block, 2 coats of vinyl plastic spray over entire surface of each side; Actual thickness, 3<math>\frac{3}{4}</math> inches; Weight, 38 lbs. per square foot</p>	Incombustible, with one hour fire-rating	Good	Good; transmission loss, 40 decibels	Sleek finish, but no flexibility	
 <p>2 by 4 inch wood studs, spaced 16 inches apart; metal lath and plaster, 2 coats of paint on each side; Thickness, 4<math>\frac{3}{4}</math> inches; Weight, 20 lbs. per square foot</p>	Combustible	Poor	Good; transmission loss, 39 decibels	Good light reflector, not much flexibility	

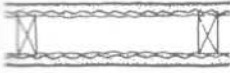
**PARTITIONS AND WALL FINISHES**

Partition and Wall Types



WOOD STUDS - 16" O.C.  
3/8" 3-PLY PLYWOOD  
NAILED BOTH SIDES

W-1



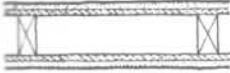
WOOD STUDS - 16" O.C., METAL  
LATH, GYPSUM SCRATCH & BROWN,  
WHITE FINISH BOTH SIDES

W-2



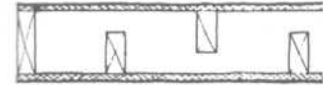
WOOD STUDS - 16" O.C.  
1/2" FIBERBOARD, JOINTS  
FILLED, BOTH SIDES

W-3



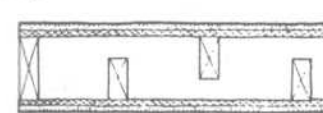
SAME AS W-3, WITH  
1/2" SCRATCH, BROWN & WHITE,  
GYPSUM BOTH SIDES

W-4



2" x 4" WOOD STUDS,  
STAGGERED, 8" O.C.  
2" x 6" STUD AT EDGES  
1/2" FIBERBOARD  
NAILED BOTH SIDES

W-5



SAME AS W-5,  
WITH 1/2" SCRATCH,  
BROWN, & WHITE  
GYPSUM,  
BOTH SIDES

W-6



WOOD STUDS - 16" O.C.  
GYPSUM LATH, ATTACHED  
WITH STIFF CLIPS  
3/8" SCRATCH, BROWN, WHITE  
GYPSUM PLASTER BOTH SIDES

W-7



SAME AS W-7, EXCEPT  
ATTACHED WITH SPRING  
CLIPS  
1/2" PLASTER BOTH SIDES

W-8



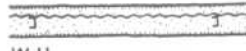
2" SOLID GYPSUM PLASTER ON PER-  
FORATED GYP LATH, 3/4" CHANNEL  
STUDS, SMOOTH WHITE BOTH SIDES

W-9



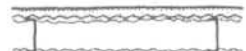
2" SOLID GYPSUM PLASTER  
SAME AS W-9 EXCEPT  
EXPANDED METAL LATH

W-10



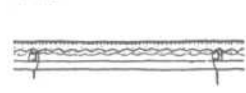
2 1/2" SOLID GYPSUM PLASTER  
SAME AS W-10

W-11



3" METAL STUDS - 16" O.C., METAL  
LATH, 1/2" SCRATCH, BROWN, WHITE  
GYPSUM PLASTER BOTH SIDES

W-12



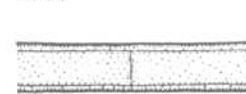
TWO PANELS, NOT JOINED;  
3/4" CHANNEL STUDS,  
EXPANDED METAL LATH,  
SCRATCH, BROWN & WHITE  
GYPSUM PLASTER BOTH SIDES  
FACE TO FACE = 10"

W-13



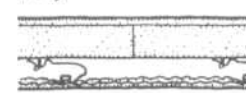
SAME AS W-13, EXCEPT  
FACE TO FACE = 4 1/2"

W-14



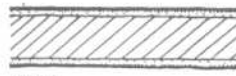
3" x 12" x 30" GYPSUM TILE  
1/2" BROWN, WHITE  
GYPSUM PLASTER BOTH SIDES

W-15



3" x 12" x 30" GYPSUM TILE, RESILIENT  
CLIP METAL LATH, 3 COATS  
GYPSUM PLASTER, 2 COATS  
GYPSUM PLASTER ON TILE,  
OTHER SIDE (WHITE FIN BOTH SIDES)

W-16



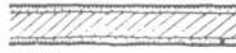
4" BRICK PARTITION,  
1/2" BROWN, WHITE FINISH  
GYPSUM PLASTER BOTH SIDES

W-17



SAME AS W-17, EXCEPT  
8" BRICK PANEL

W-18



SAME AS W-17, EXCEPT ONE LAYER  
OF BRICK LAID ON EDGE

W-19



BRICK LAID ON EDGE,  
1" x 2" FURRING, WIRED, &  
GYPSUM LATH PLUS  
1/2" BROWN & WHITE  
GYPSUM PLASTER BOTH SIDES

W-20



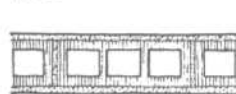
3" x 12" x 12" - 3 CELL CLAY TILE,  
1/2" BROWN & WHITE  
GYPSUM PLASTER BOTH SIDES

W-21



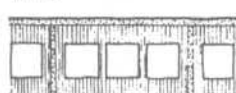
ANOTHER PANEL BUILT AS NEARLY  
LIKE W-21 AS POSSIBLE

W-22



SAME AS W-21 EXCEPT  
4" x 12" x 12" 3-CELL TILE

W-23



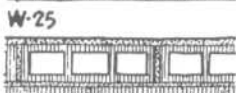
SAME AS W-21 EXCEPT  
6" x 12" x 12" 3-CELL TILE

W-24



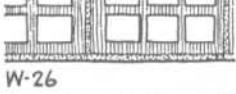
SAME AS W-21 EXCEPT  
8" x 12" x 12" 3-CELL TILE

W-25



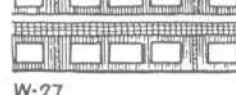
DOUBLE CLAY TILE: 3 3/4" x 12" x 12"  
8" x 12" x 12" 1/2" BROWN AND  
WHITE GYPSUM PLASTER  
BOTH SIDES

W-26



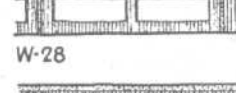
DOUBLE PARTITION WITH AIR SPACE  
TWO WALLS OF 3" x 12" x 12" 3-CELL  
CLAY TILE 1" FLAXLINUM BUTTED  
TIGHT BETWEEN TILE. NO  
PLASTER. 1" x 4" FLAXLINUM STRIP  
AT BOTTOM, SIDES & TOP  
OF ONE PARTITION

W-27



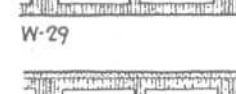
PUMICE & PORTLAND CEMENT  
2-CELL TILE 4" x 8" x 16"  
NO PEASTER (VERY POROUS)

W-28



SAME AS W-28, BUT  
1/2" GYPSUM PLASTER ON  
ONE SIDE ONLY

W-29



SAME AS W-28, BUT  
1/2" GYPSUM PLASTER ON  
BOTH SIDES

W-30

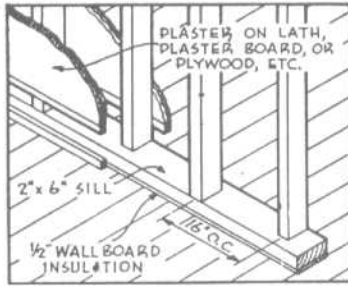


GLASS BRICK 3 3/4" x 4 7/8" x 8"

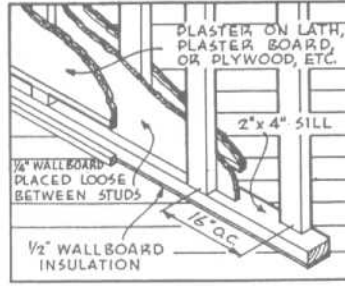
W-31

PARTITIONS AND WALL FINISHES

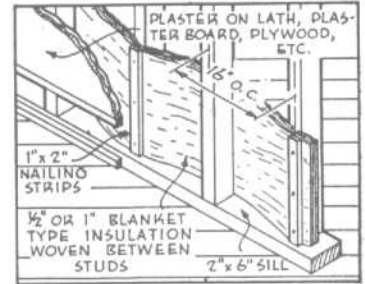
Partition and Wall Types



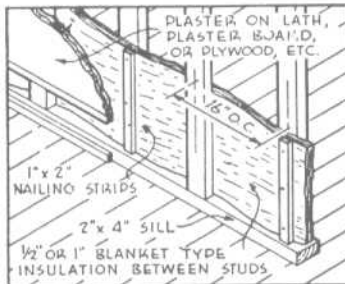
SOUND CONTROL BY STAGGERED STUDS



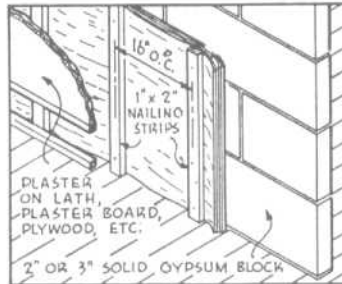
SOUND CONTROL - STAGGERED STUDS AND WALL BOARD



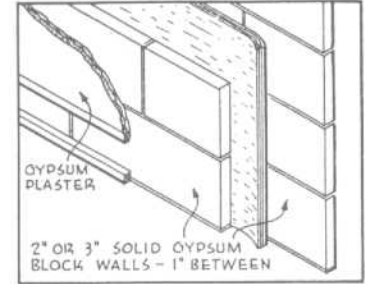
SOUND CONTROL - STAGGERED STUDS AND BLANKET CENTER



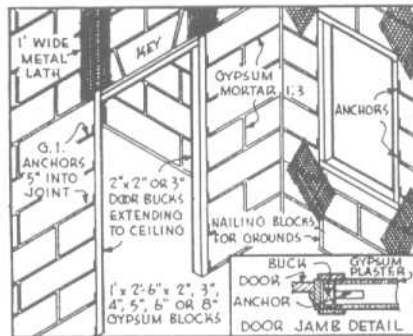
SOUND CONTROL - SIDEWISE STUDS AND BLANKET CENTER



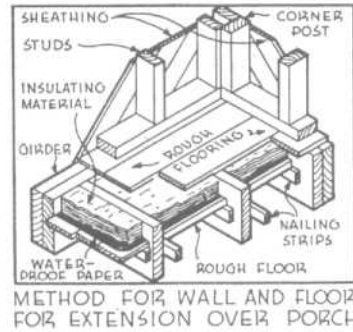
SOUND CONTROL - BLANKET OVER GYPSUM BLOCK



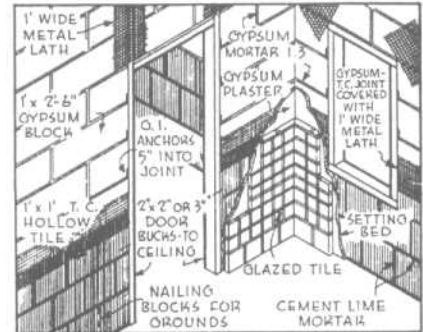
SOUND CONTROL - BLANKET BETWEEN GYPSUM BLOCK



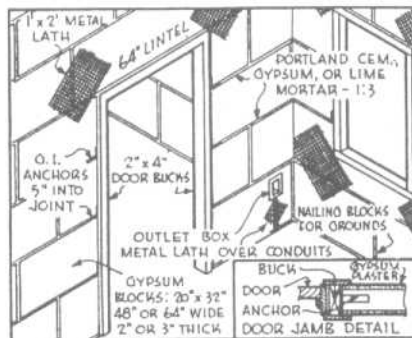
GYPSUM SOLID OR HOLLOW PARTITION TILE-1



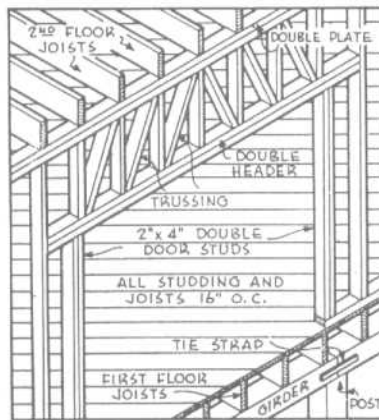
METHOD FOR WALL AND FLOOR FOR EXTENSION OVER PORCH



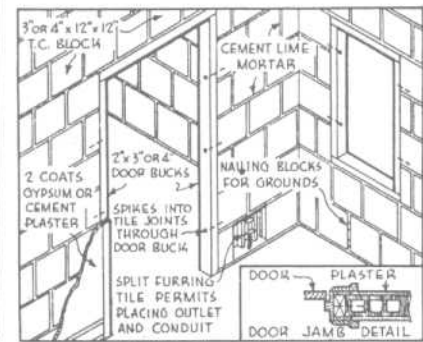
TERZA COTTA BLOCK PARTITION TO HEIGHT OF GLAZED TILE



GYPSUM SOLID OR HOLLOW PARTITION TILE-2



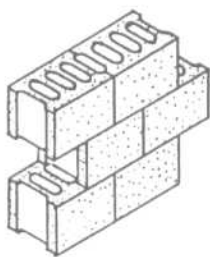
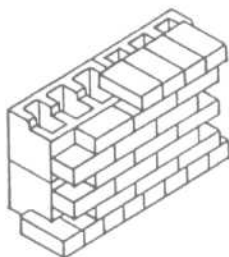
FRAMING FOR WIDE OPENING ABOVE SUB-STRUCTURE



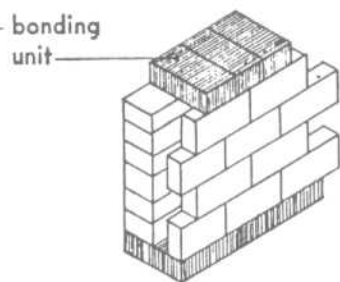
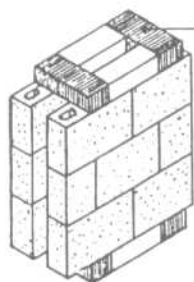
TERZA COTTA HOLLOW PARTITION TILE

PARTITIONS AND WALL FINISHES

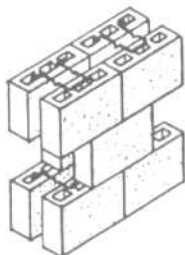
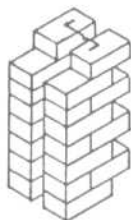
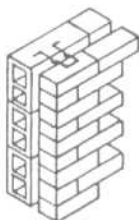
Types of Masonry Walls and Piers



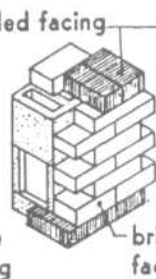
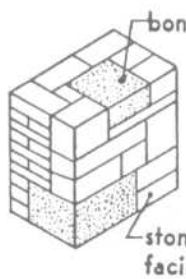
HOLLOW MASONRY UNITS



HOLLOW WALLS



CAVITY WALLS

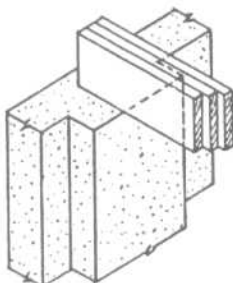


bonded facing

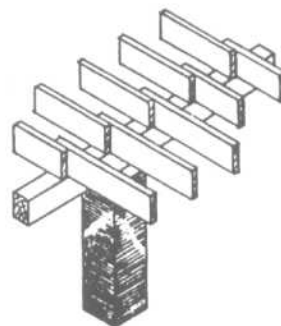
stone facing

brick facing

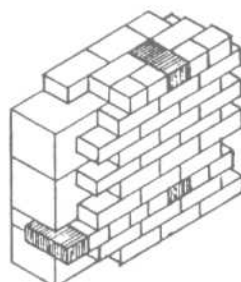
FACED WALLS



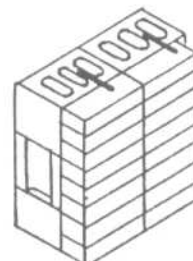
COLUMN OF MASONRY INTEGRAL WITH WALL



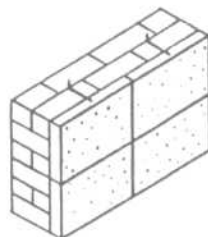
ISOLATED COLUMN OF MASONRY PIERS



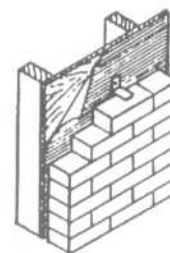
MASONRY TIES; MASONRY BACKING



METAL TIES; MASONRY BACKING



METAL TIES; MASONRY BACKING



METAL TIES; FRAME BACKING

VENEERED WALLS

PARTITIONS AND WALL FINISHES

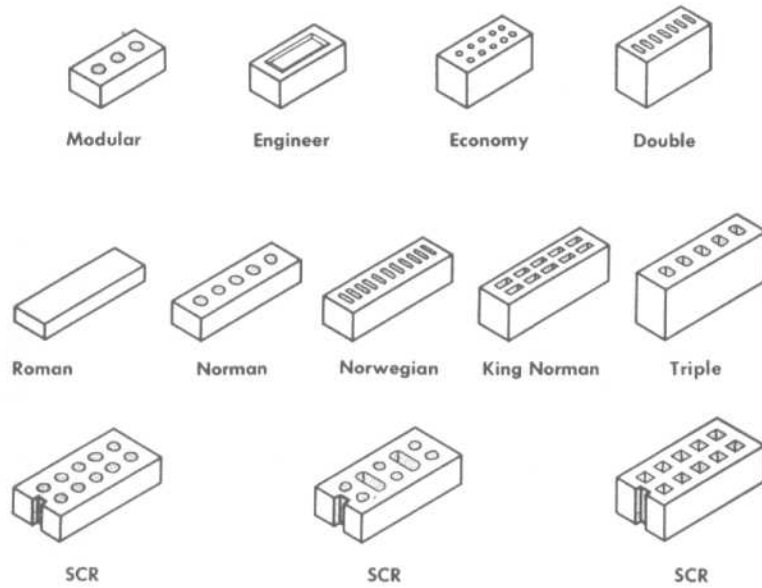


Fig. 1 Typical clay brick.

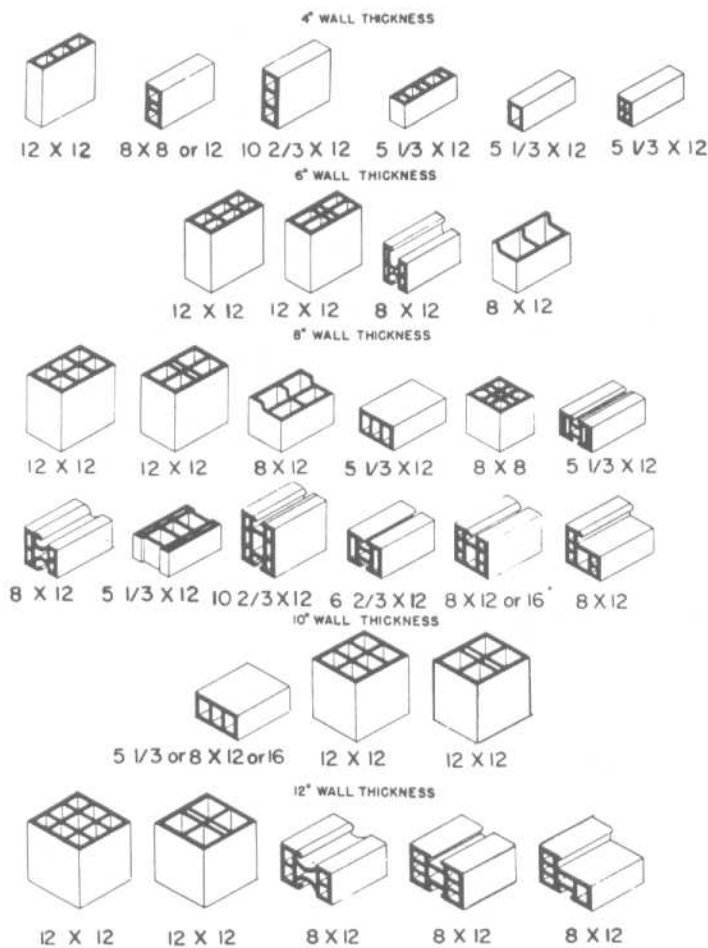


Fig. 2 Structural clay tile.

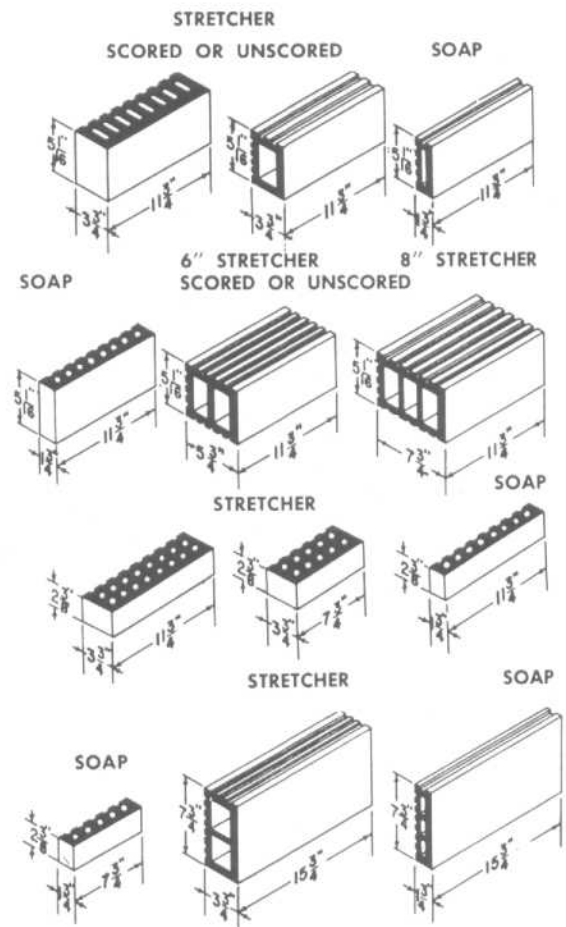


Fig. 3 Structural facing tile.

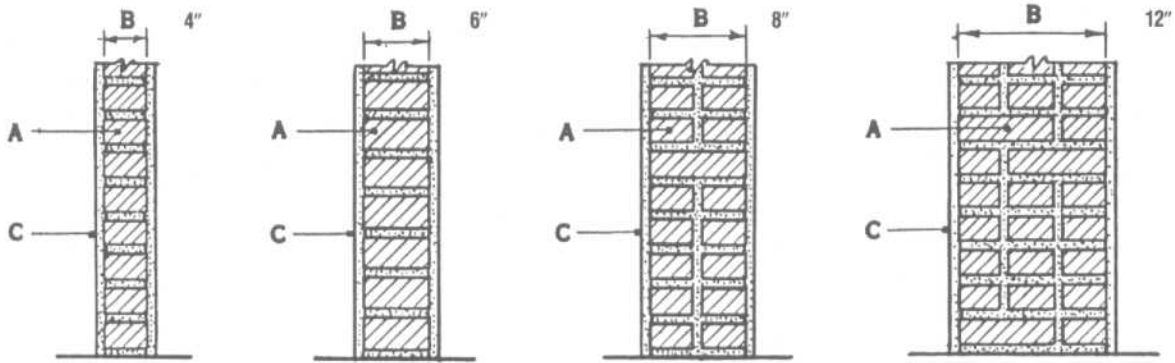


Fig. 4 Solid brick: bearing or nonbearing (sections). A = brick, B = nominal wall thickness, C = finish.

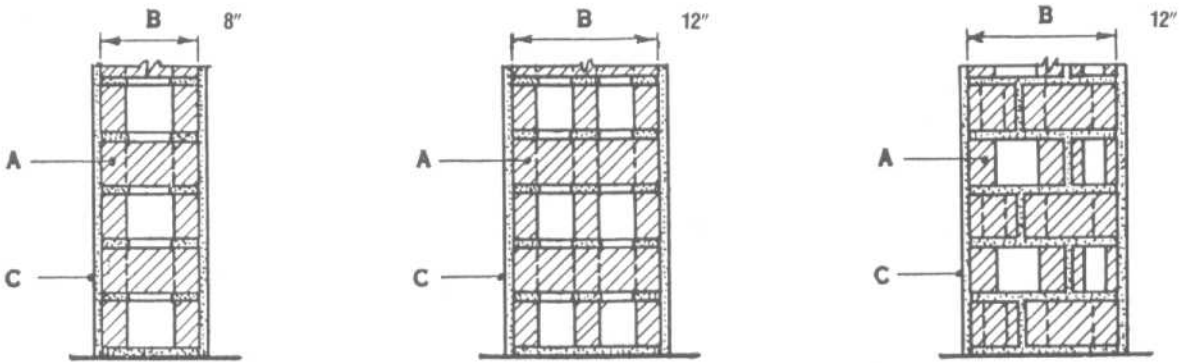


Fig. 5 Hollow brick units: bearing or nonbearing (sections). A = brick, B = nominal wall thickness, C = finish.

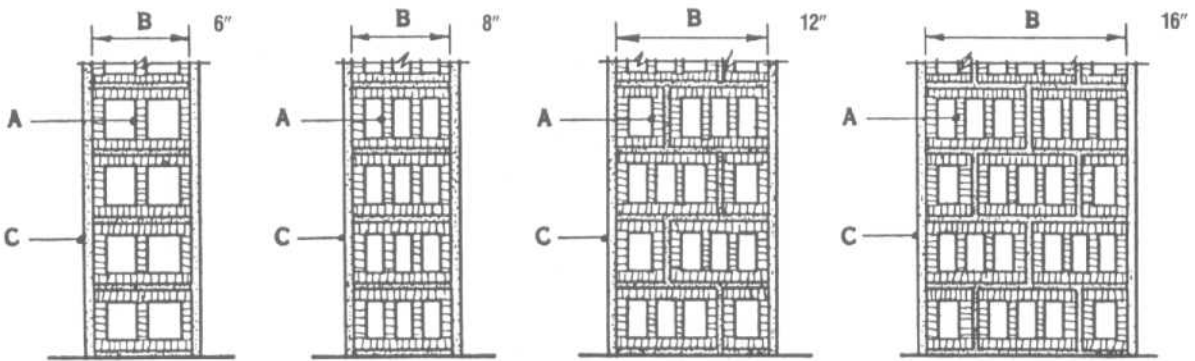


Fig. 6 Structural clay tile: bearing (sections). A = structural clay tile, B = nominal wall thickness, C = finish.



PARTITIONS AND WALL FINISHES

Types of Masonry

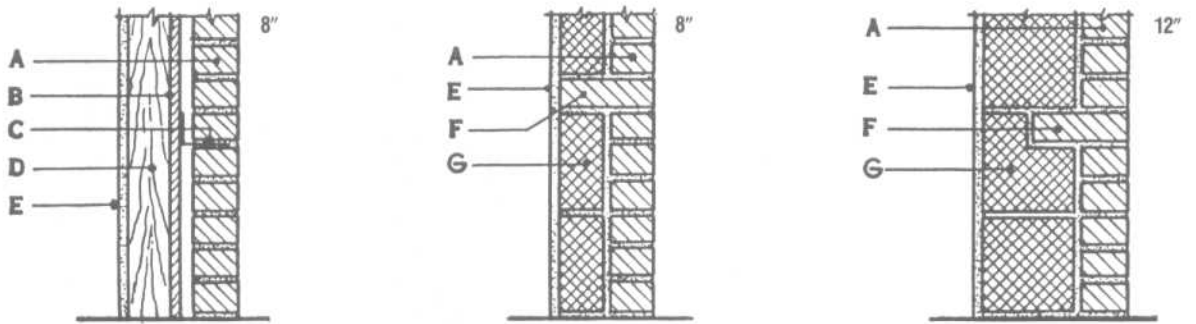


Fig. 7 Faced or veneered construction: bearing (sections). A=brick; B= sheathing; C=corrosion-resistant metal ties spaced 24 in on centers, vertically and horizontally; D=wood or steel studs; E=plaster or gypsum wallboard; F=masonry bond; G=masonry backing unit.

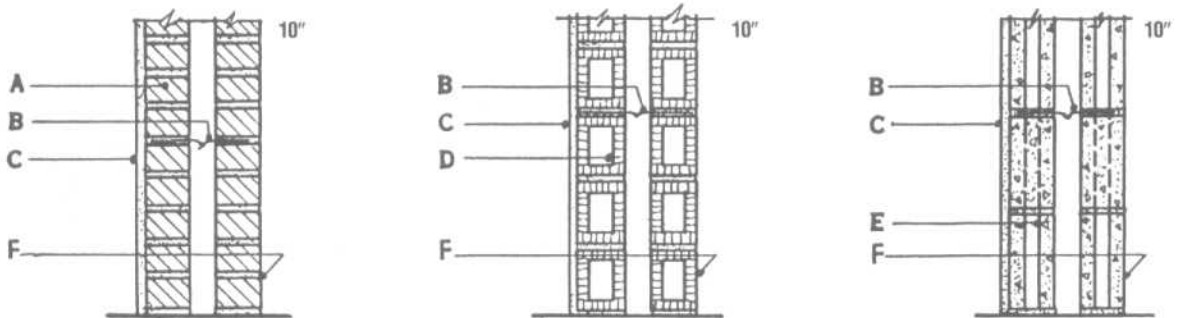


Fig. 8 Cavity type: bearing (sections). A=clay brick, B=corrosion-resistant metal ties spaced to provide one tie to each 3 ft<sup>2</sup> of wall surface, C=gypsum plaster, D=structural clay load-bearing tile, E=concrete masonry units of load-bearing grade, F=exterior face of wall.

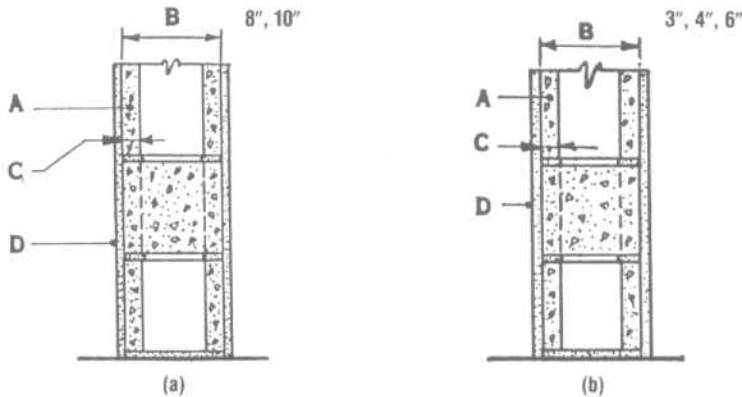


Fig. 9 Hollow concrete masonry units (sections). (a) Bearing, (b) Non-bearing. A=concrete masonry units conforming to ASTM, *Standard Specifications for Hollow Load-Bearing Concrete Masonry Units*; B=nominal wall thickness, C=nominal shell thickness, D=gypsum plaster.



PARTITIONS AND WALL FINISHES

Types of Masonry

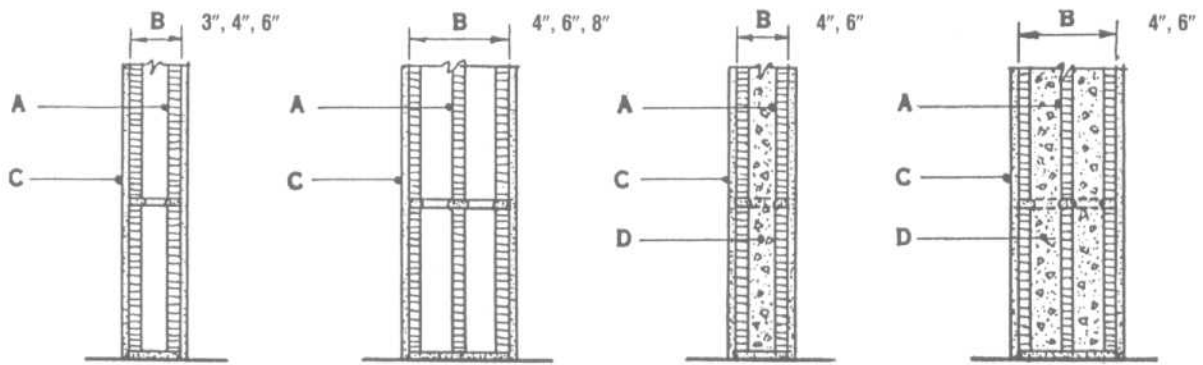


Fig. 10 Structural clay tile: nonbearing (sections). A = structural clay tile, B = nominal wall thickness, C = finish, D = fill.

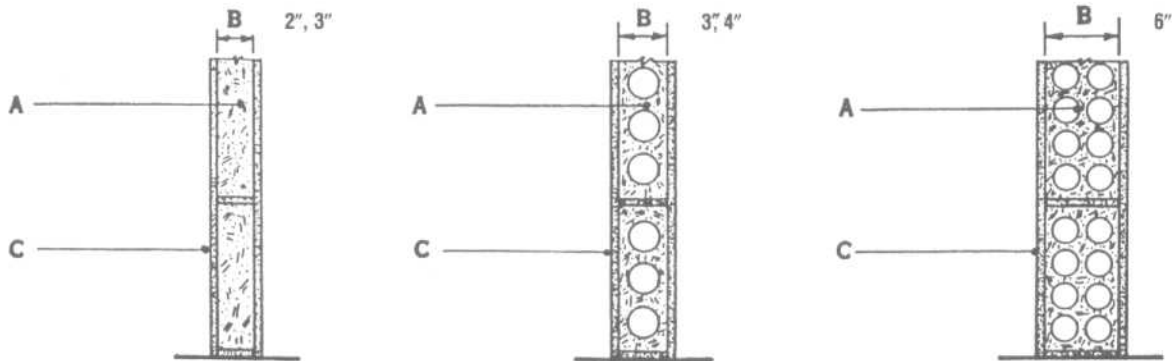


Fig. 11 Gypsum tile or block: nonbearing (sections). A = gypsum block, B = nominal wall thickness, C = finish.

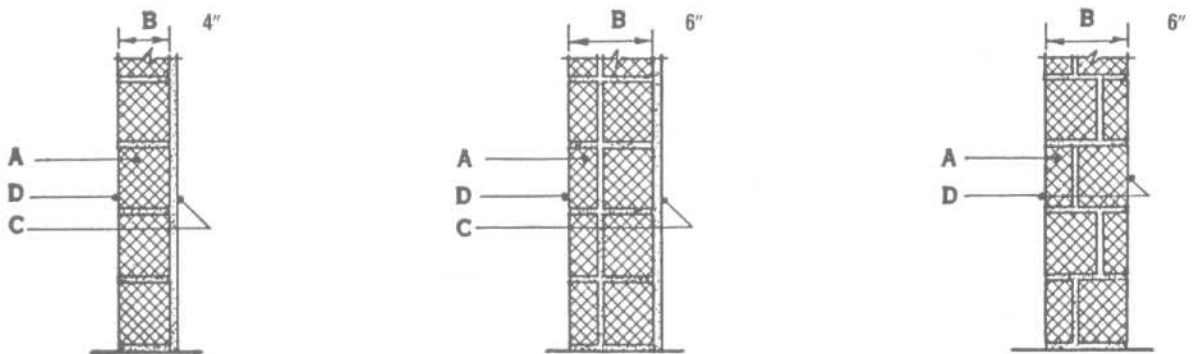
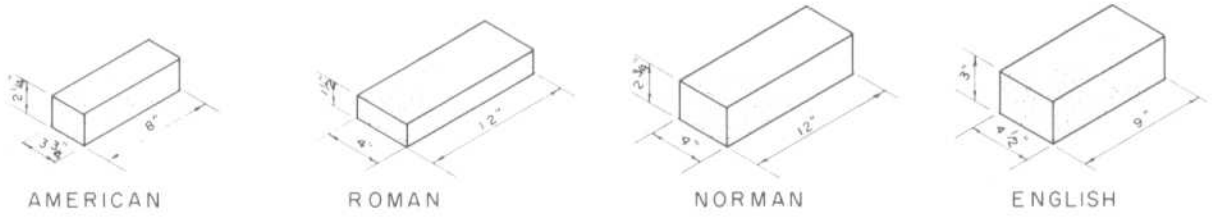


Fig. 12 Structural clay facing tile: nonbearing (sections). A = clay tile, B = nominal wall thickness, C = plaster, D = glazed or smooth-surfaced side of tile.

**PARTITIONS AND WALL FINISHES**

Brick Types and Bonds

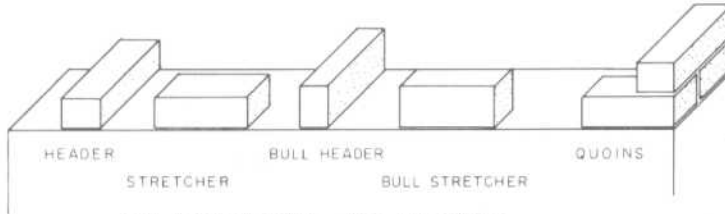


AMERICAN

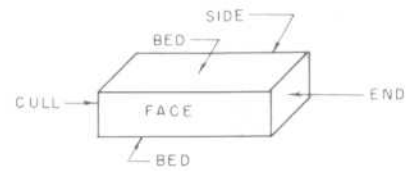
ROMAN

NORMAN

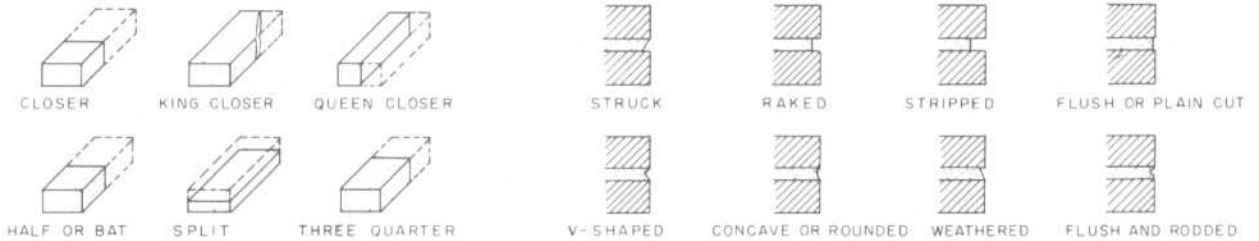
ENGLISH



PLACEMENT OF BRICK

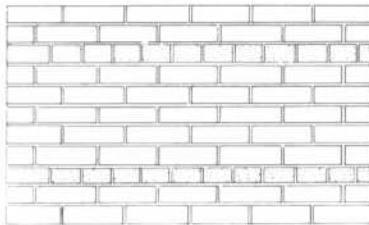


SIX FACES OF BRICK

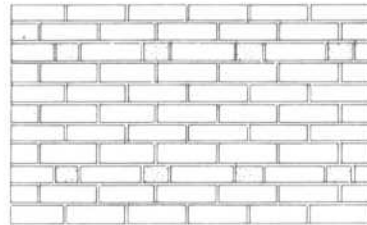


METHODS OF CUTTING BRICK

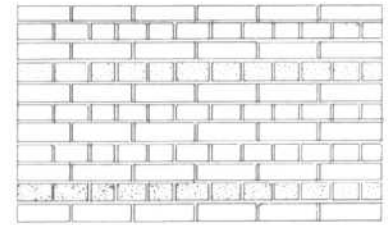
BRICK JOINTS



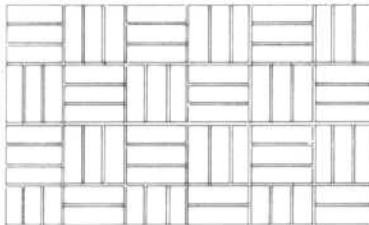
**COMMON HEADER BOND**  
HEADER COURSE EVERY 6<sup>TH</sup> COURSE  
7.88 BRICK PER SQ. FT.



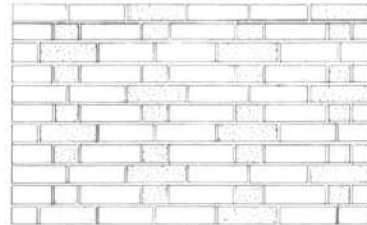
**COMMON FLEMISH BOND**  
ALTERNATE FULL HEADERS EVERY 6<sup>TH</sup> COURSE  
7.15 BRICK PER SQ. FT.



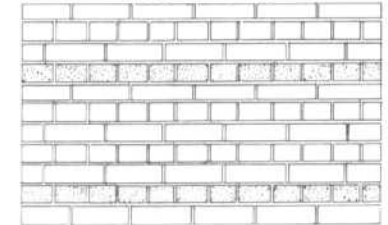
**ENGLISH BOND**  
HEADER EVERY 6<sup>TH</sup> COURSE - HALF BRICK  
USED FOR HEADER COURSE EXCEPT EVERY 6<sup>TH</sup>  
7.88 BRICK PER SQ. FT.



**BASKET PATTERN**  
6.75 BRICK PER SQ. FT.



**FLEMISH CROSS BOND**  
ALTERNATE FULL HEADER EVERY 6<sup>TH</sup> COURSE  
7.15 BRICK PER SQ. FT.



**ENGLISH CROSS BOND**  
CONTINUOUS FULL HEADERS EVERY 6<sup>TH</sup> COURSE  
7.88 BRICK PER SQ. FT.

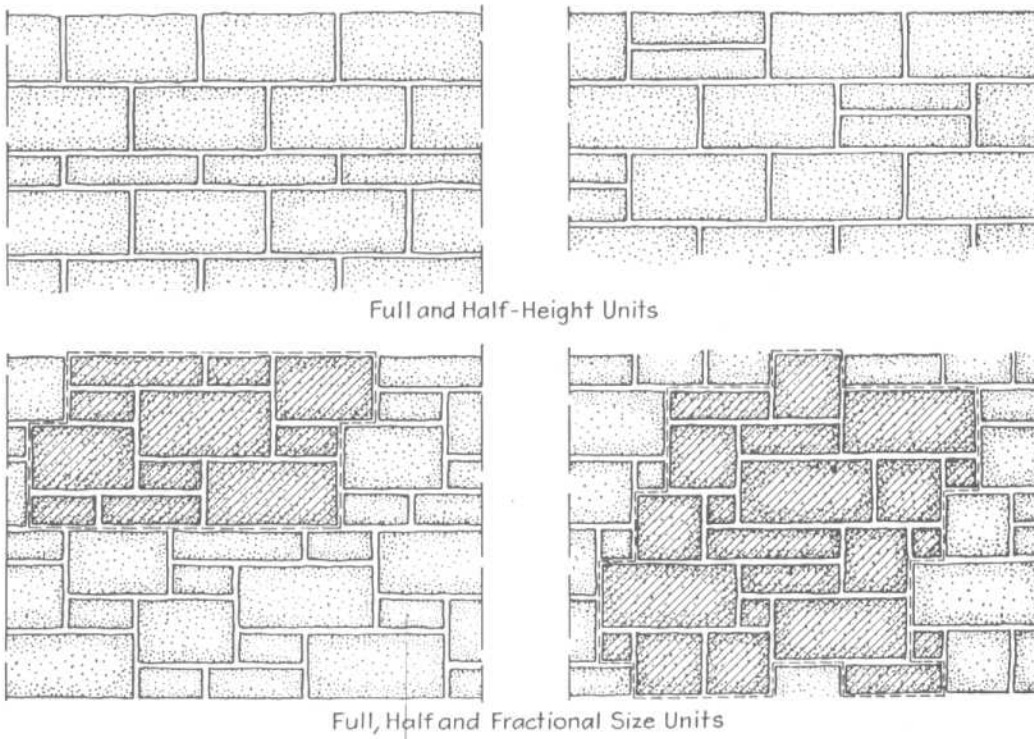


Fig. 13 Designs of standard-size hollow concrete-masonry units.

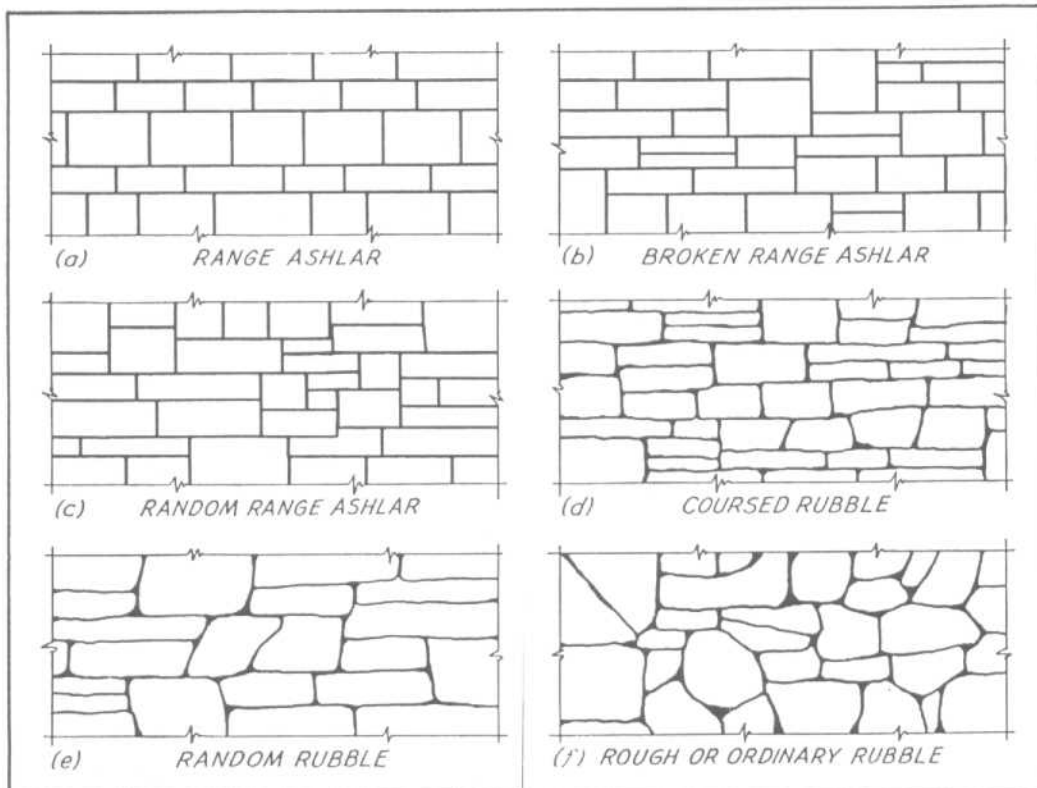
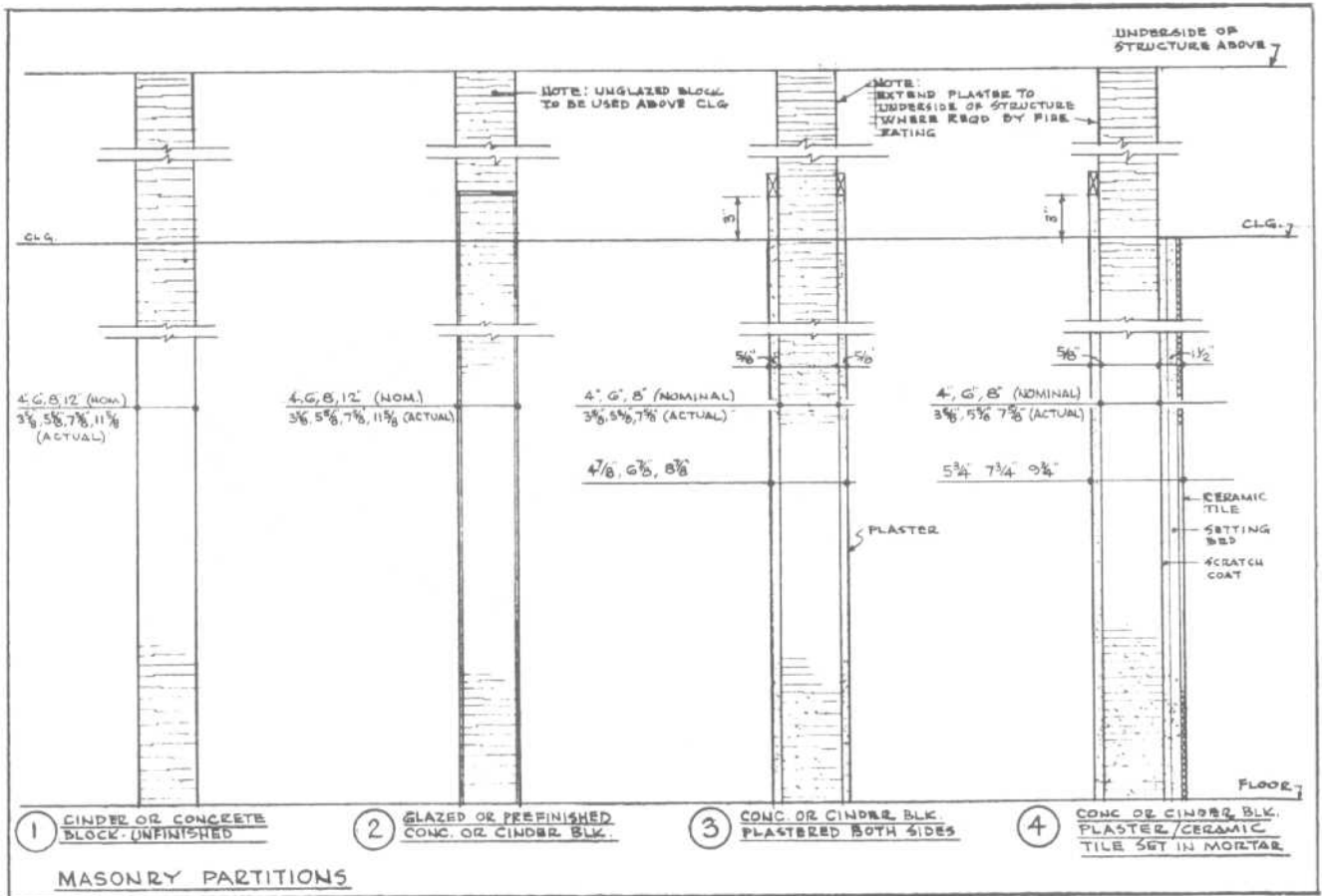


Fig. 14 Stone ashlar and rubble masonry.

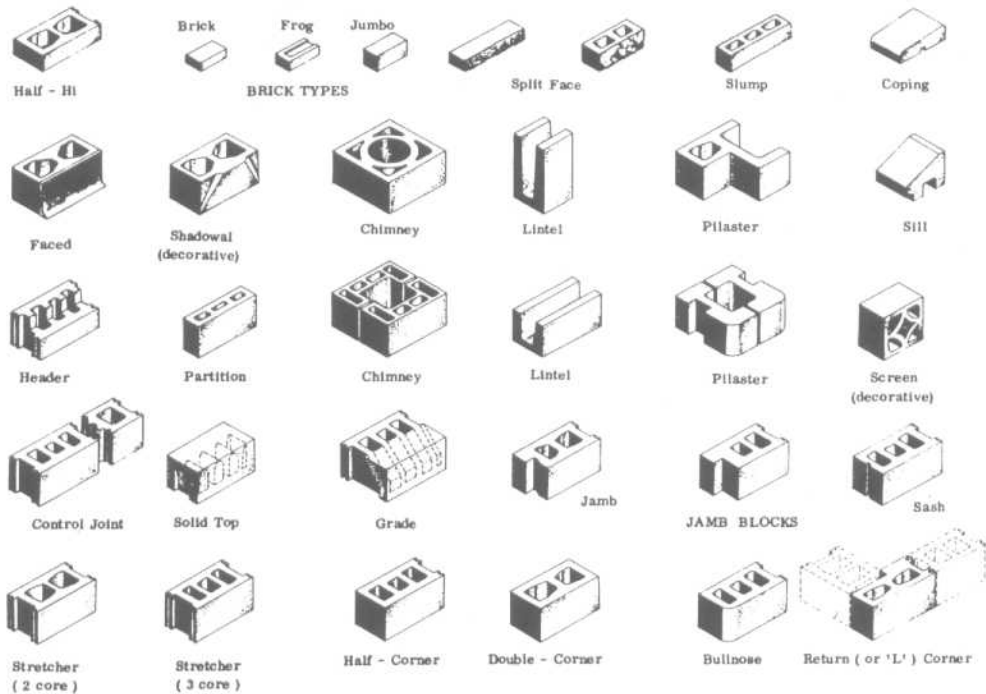
PARTITIONS AND WALL FINISHES

Masonry Partitions



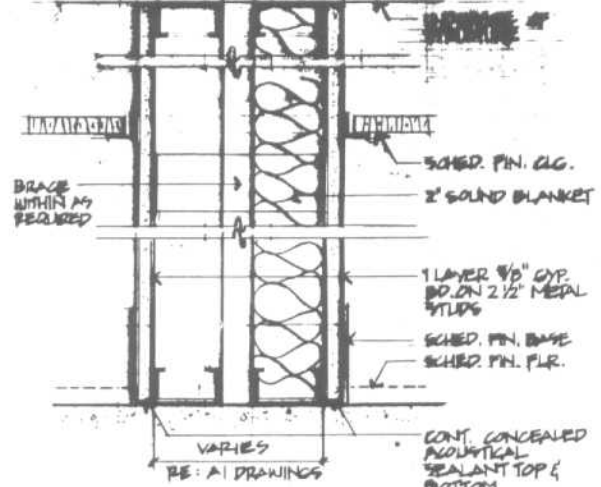
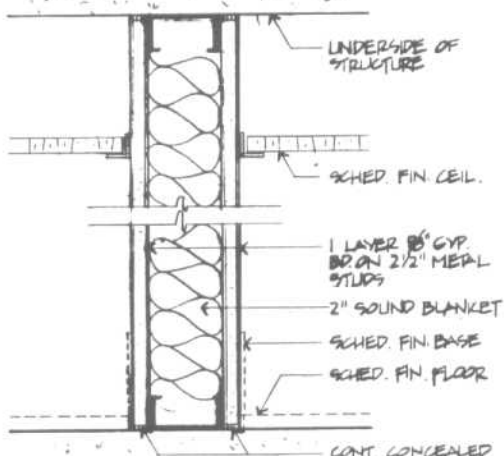
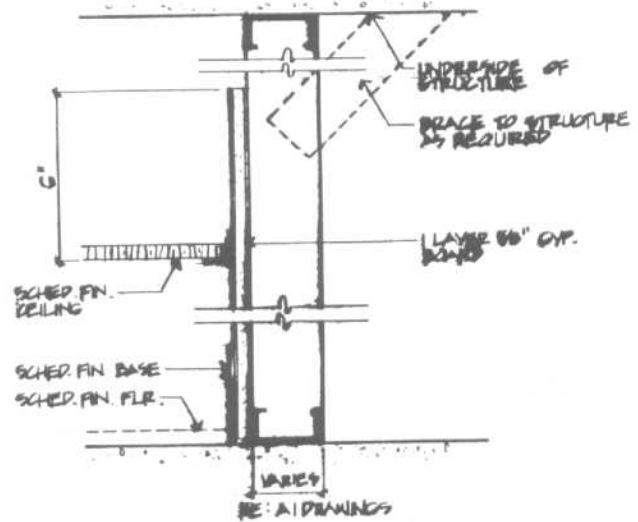
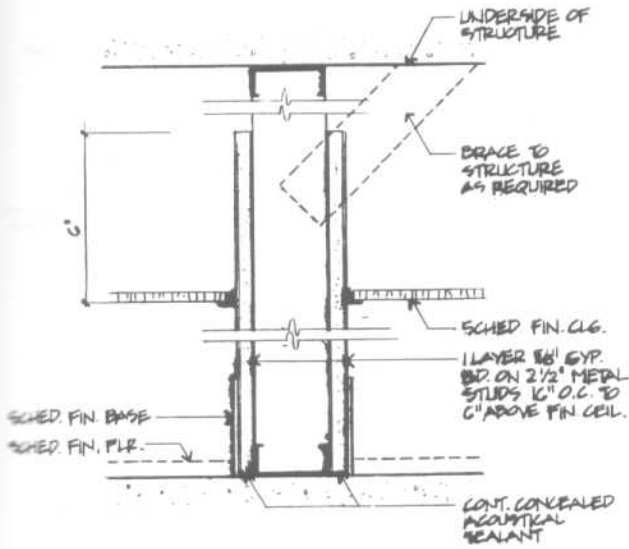
MASONRY PARTITIONS

TYPICAL SIZES AND SHAPES OF CONCRETE BLOCK



PARTITIONS AND WALL FINISHES

Metal Stud and Gypsum Board



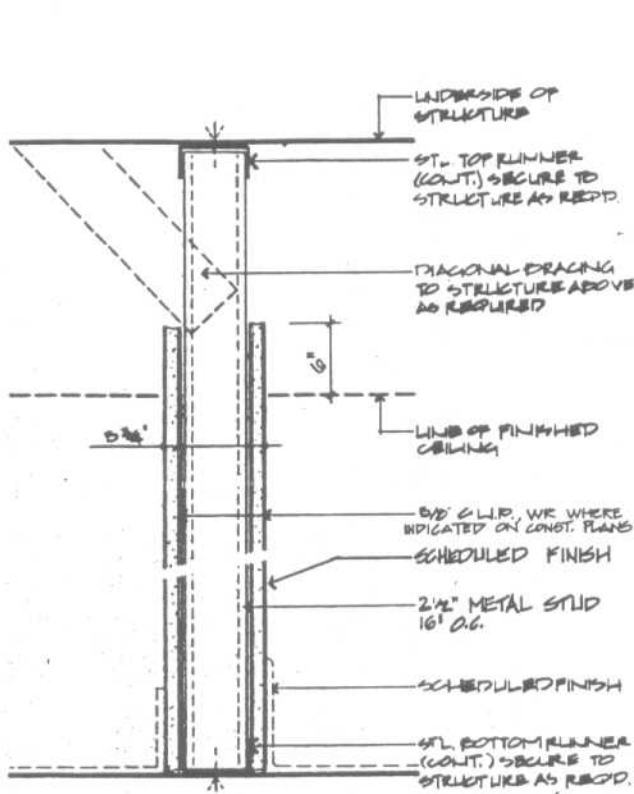
D<sub>1</sub> - CONTINUOUS VAPOR BARRIER @ COMPUTER ROOM  
 D<sub>2</sub> - WATER RESISTANT GYP. BD. ON SHOWER RM. SIDE

C<sub>1</sub> - WATER RESISTANT GYP. BD.

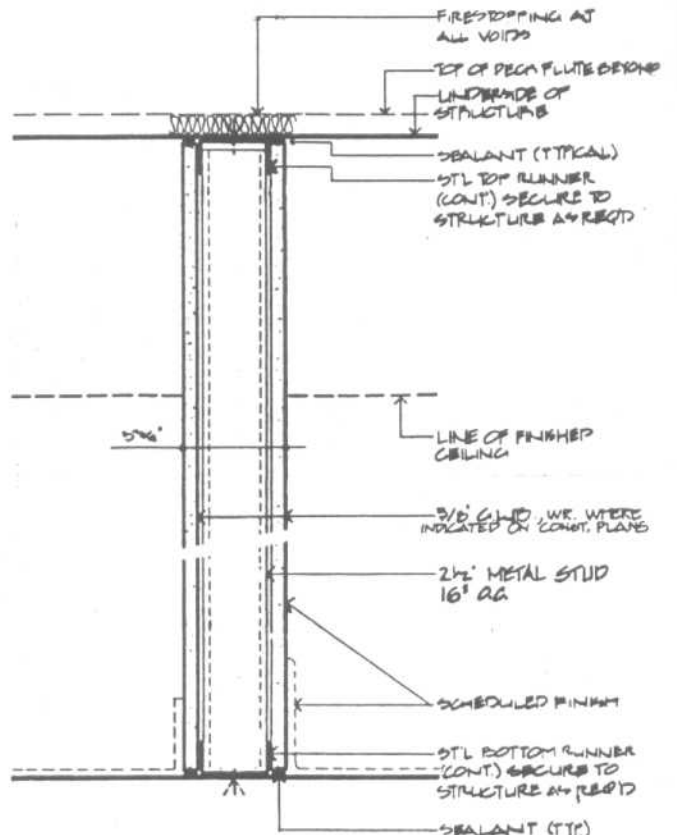
ACOUSTICAL PARTITION

PARTITIONS AND WALL FINISHES

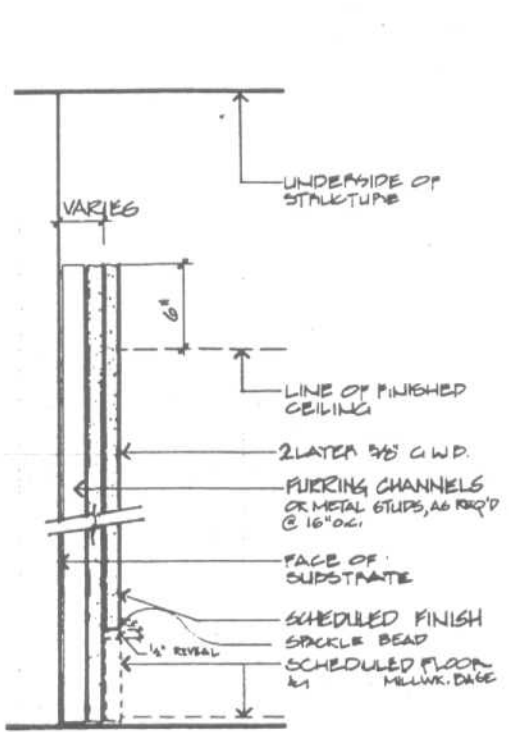
Metal Stud and Gypsum Board



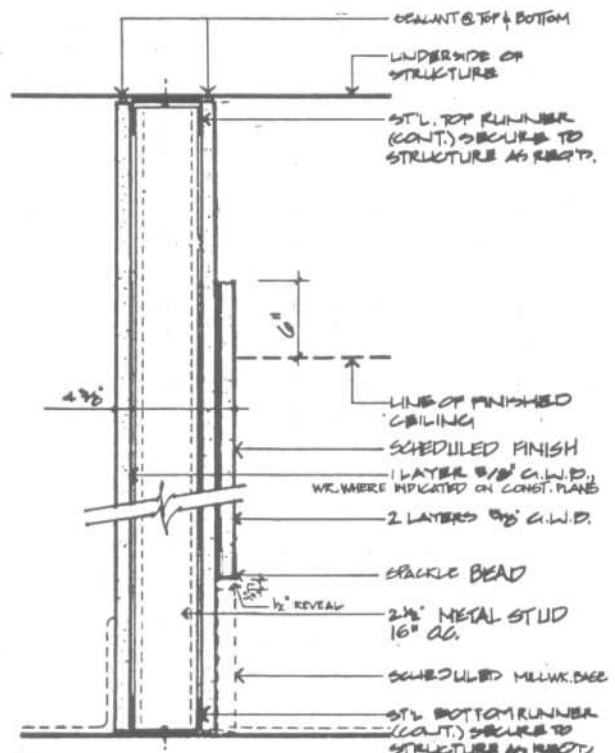
Metal stud and gypsum board: braced to slab



Metal stud and gypsum board partition: floor to slab



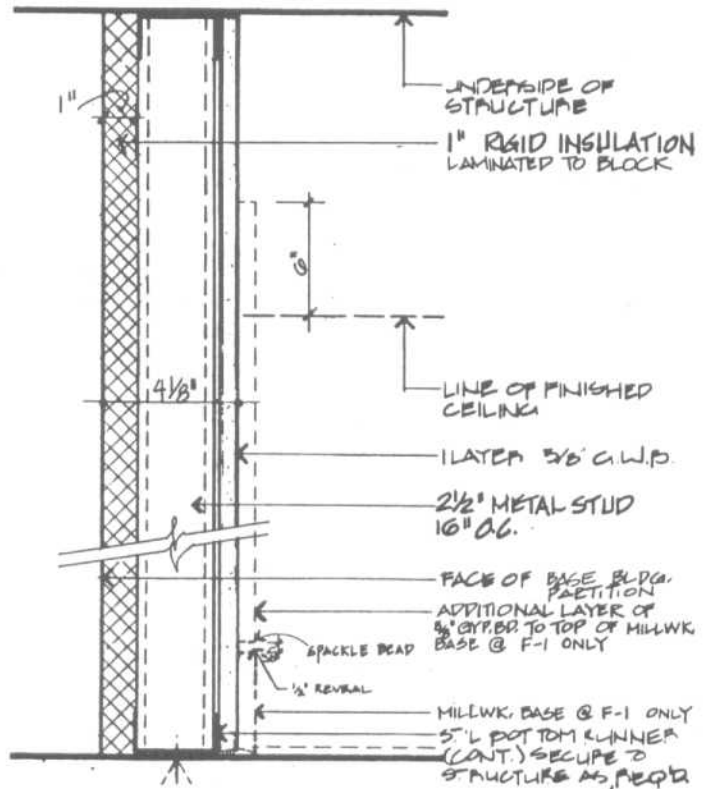
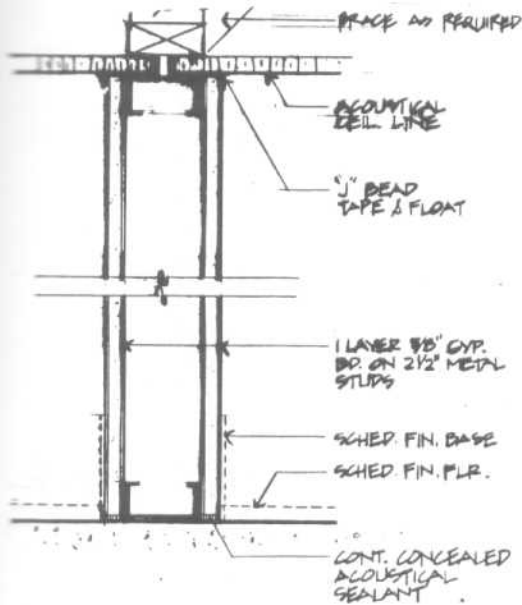
Metal channels and gypsum board: wall furring



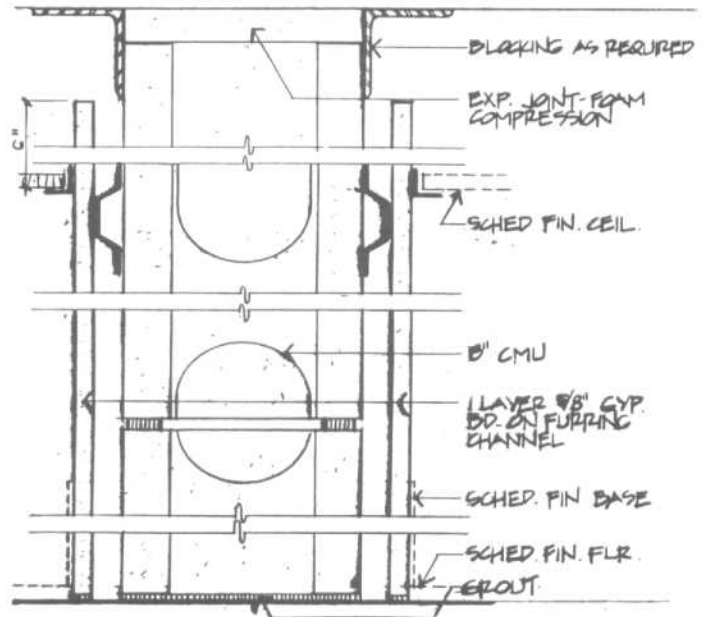
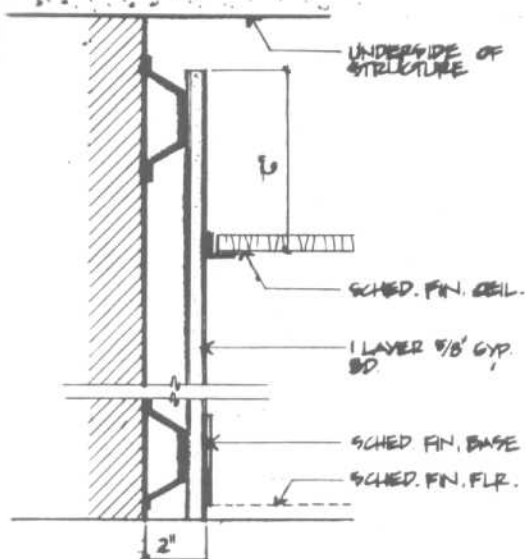
Metal stud and gypsum board partition: floor to slab

PARTITIONS AND WALL FINISHES

Metal Stud and Gypsum Board



Metal stud and gypsum board: underside of ceiling



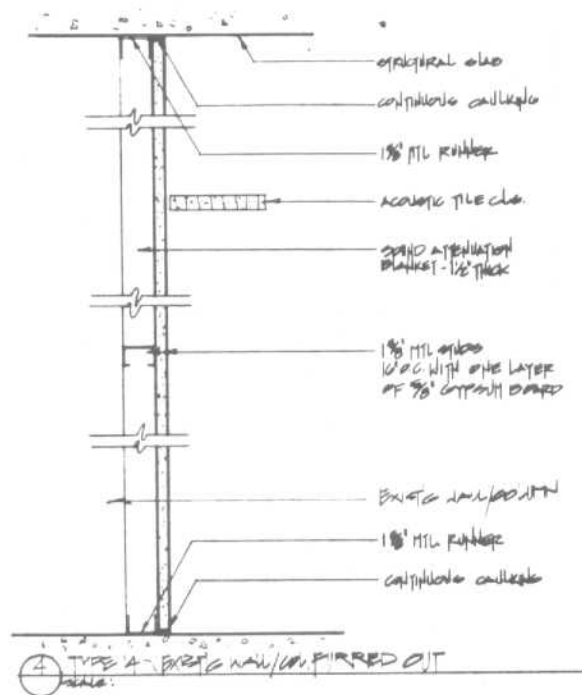
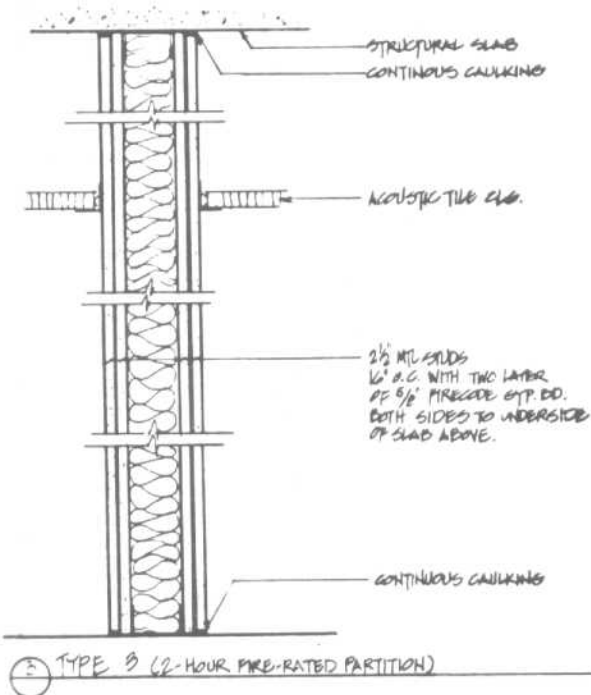
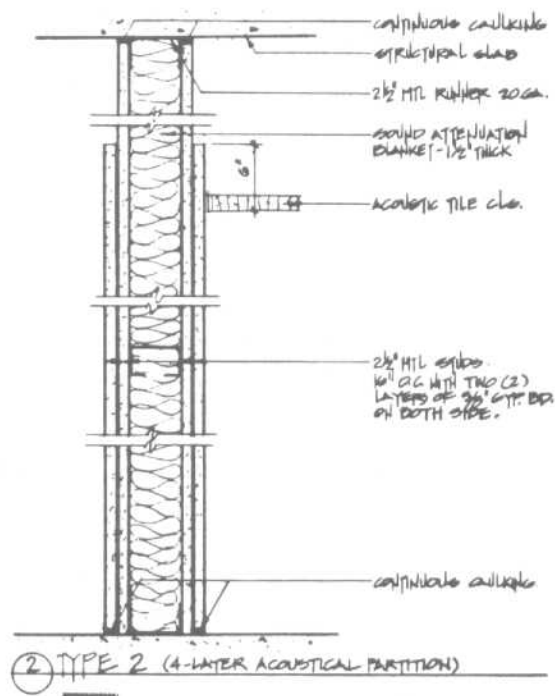
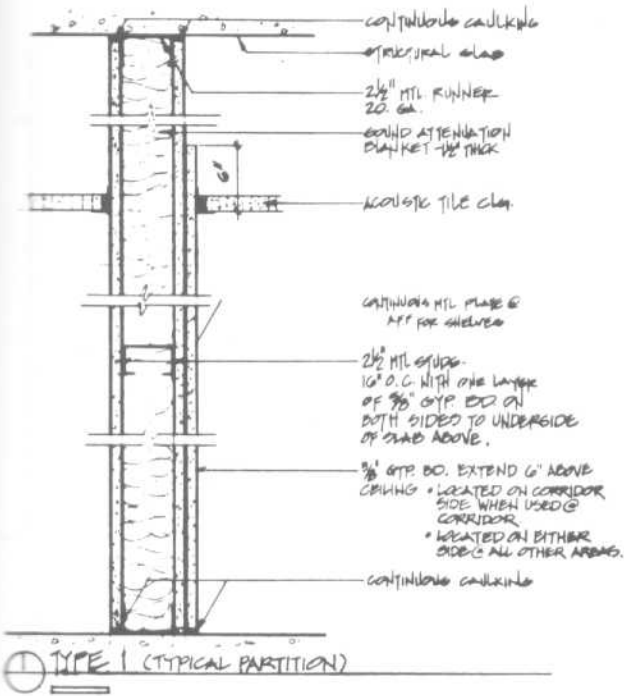
Metal channels and gypsum board: wall furring





PARTITIONS AND WALL FINISHES

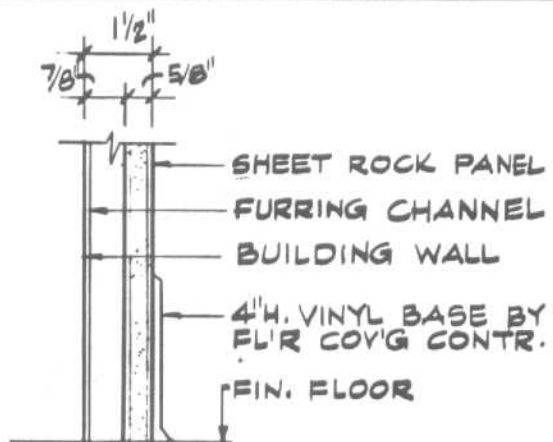
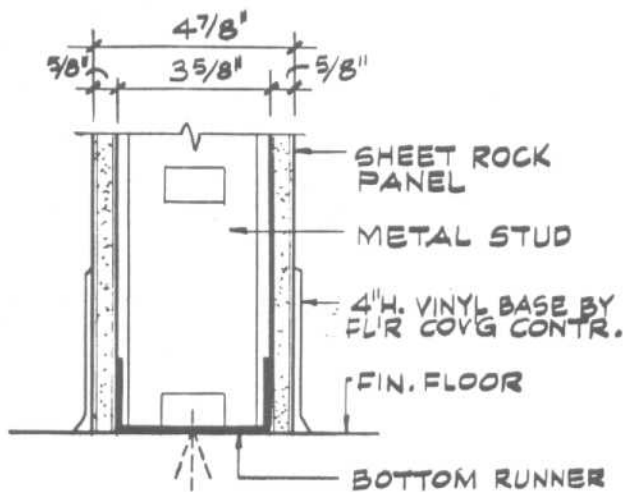
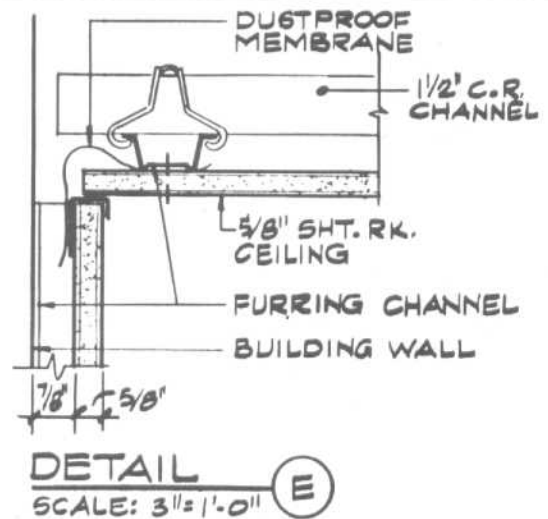
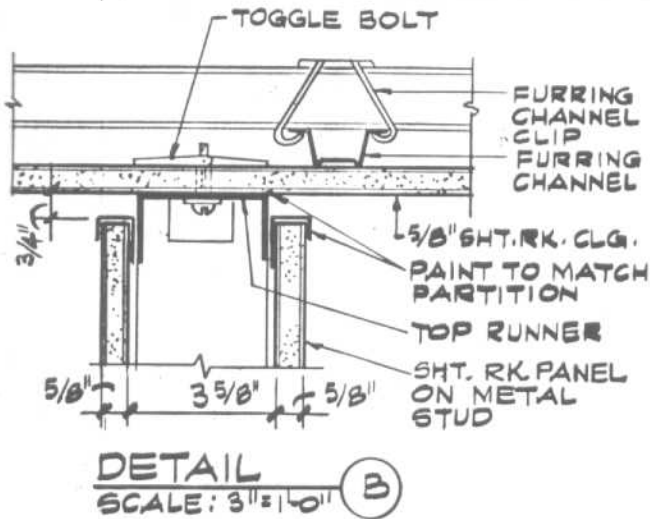
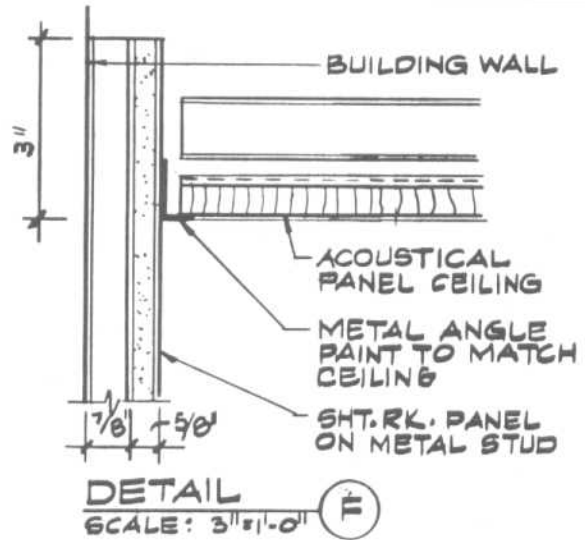
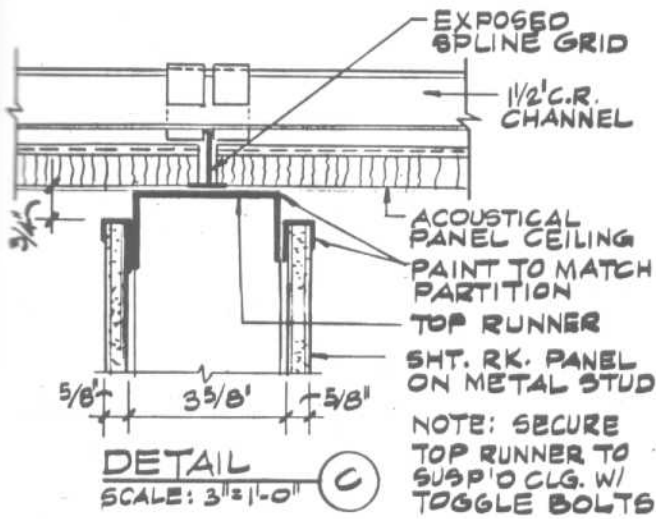
Metal Stud and Gypsum Board





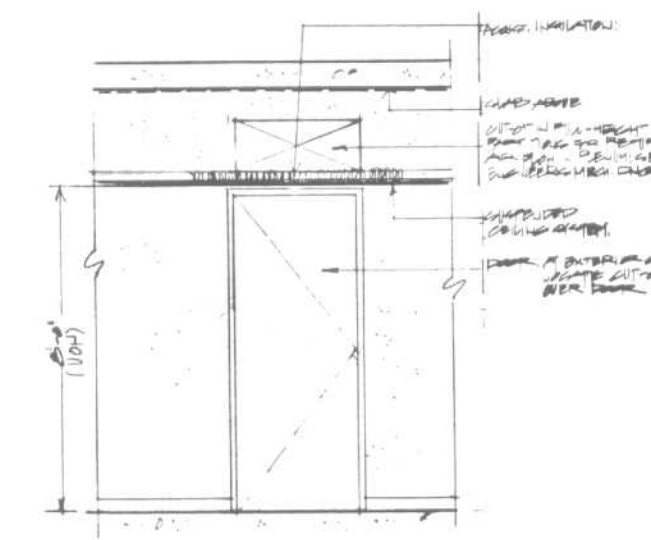
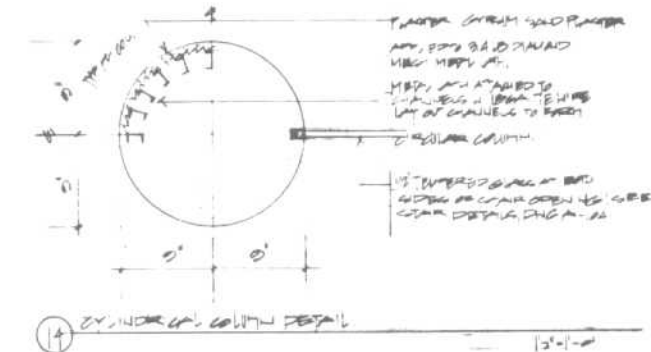
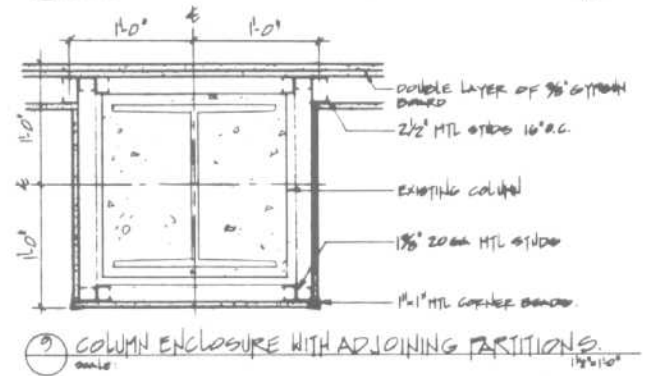
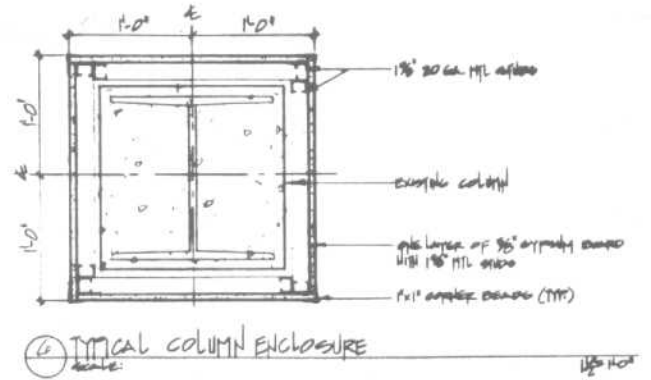
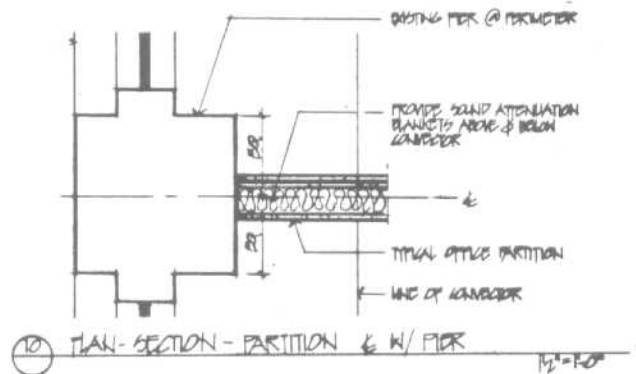
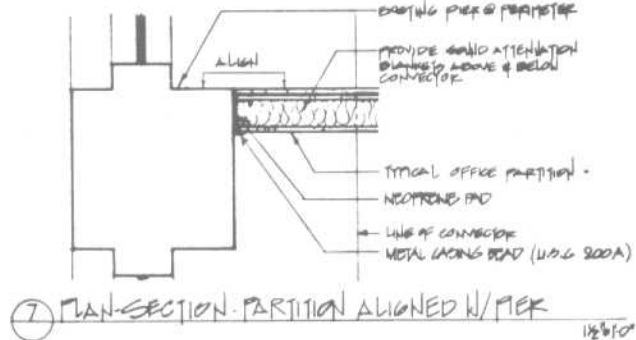
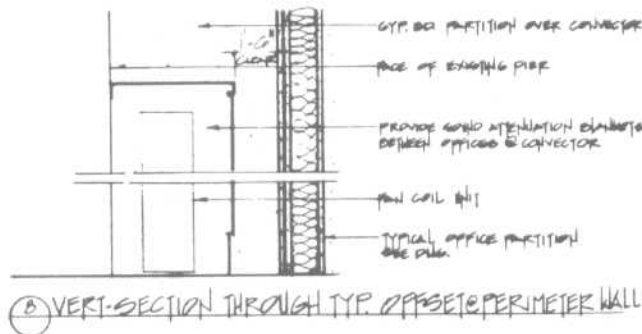
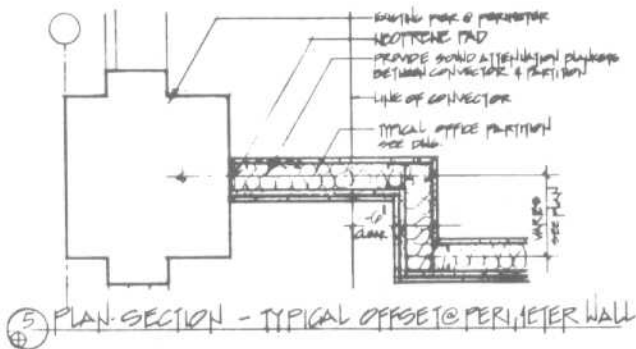
PARTITIONS AND WALL FINISHES

Metal Stud and Gypsum Board Details



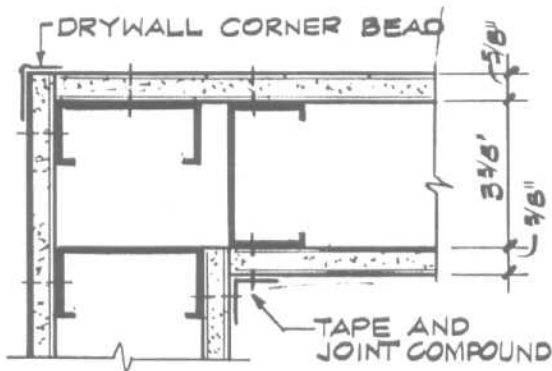
PARTITIONS AND WALL FINISHES

Metal Stud and Gypsum Board Details

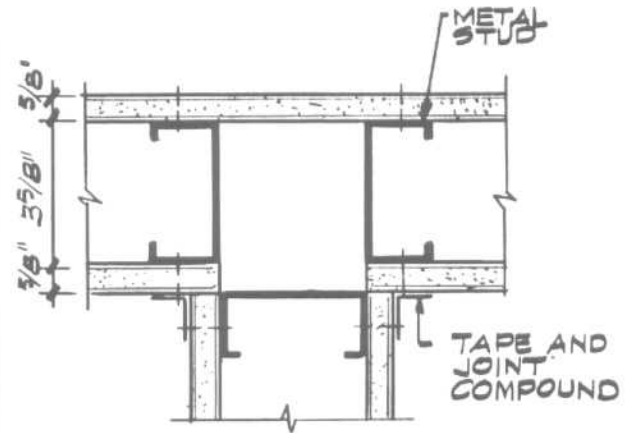


PARTITIONS AND WALL FINISHES

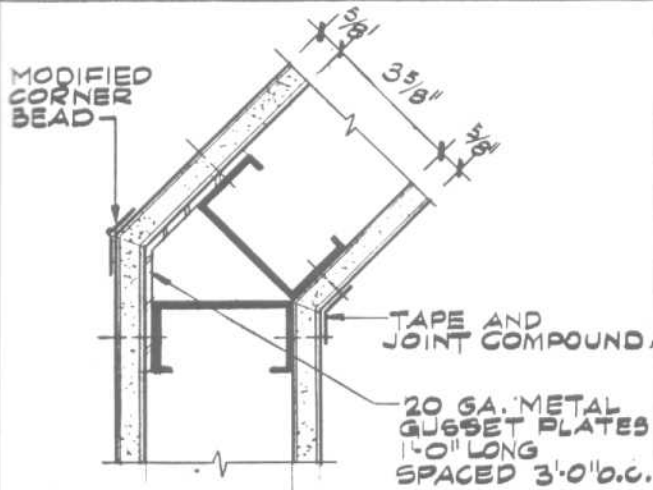
Metal Stud and Gypsum Board Corner and End Conditions



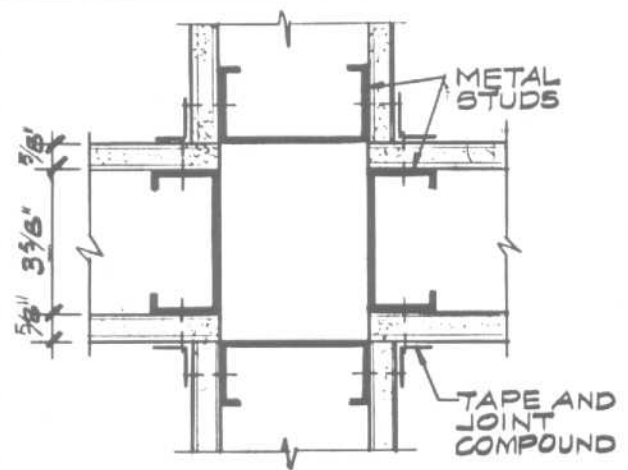
C 90° CORNER



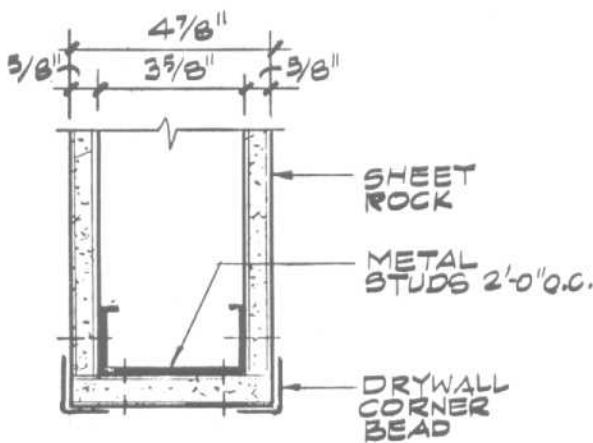
F "T" CORNER



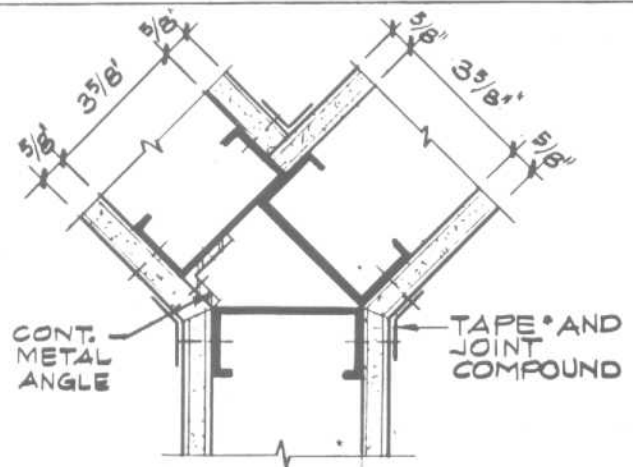
B 45° CORNER



E "CROSS" CORNER



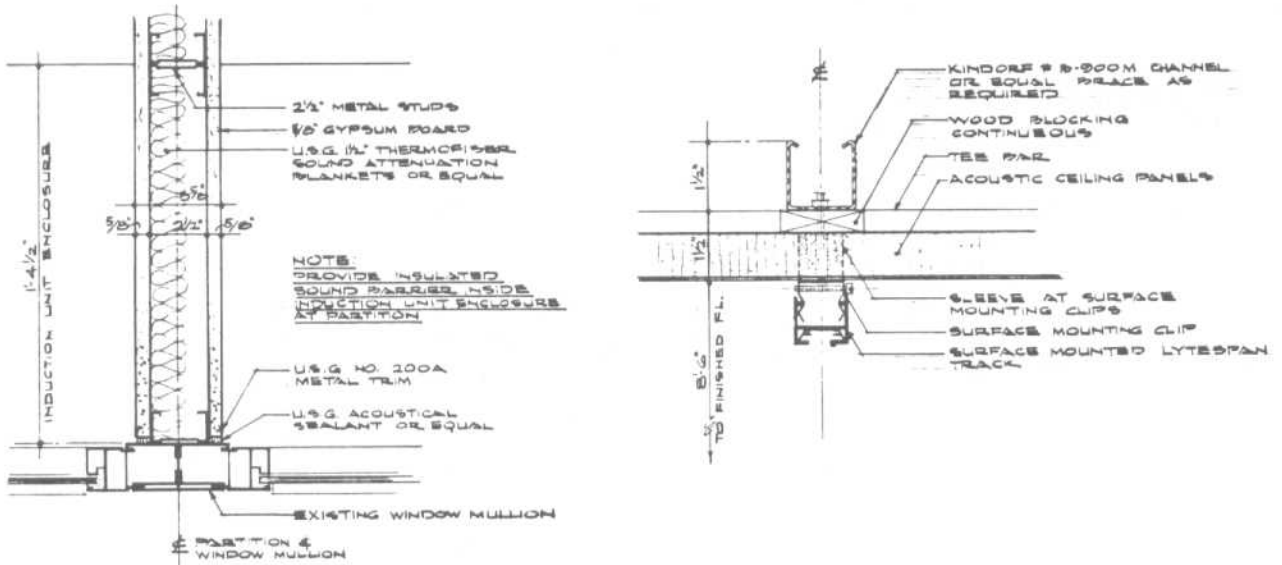
A PARTITION END DETAIL



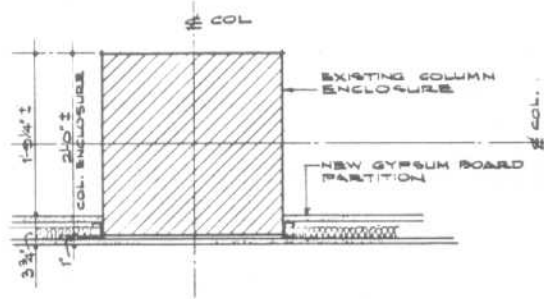
D "Y" CORNER

PARTITIONS AND WALL FINISHES

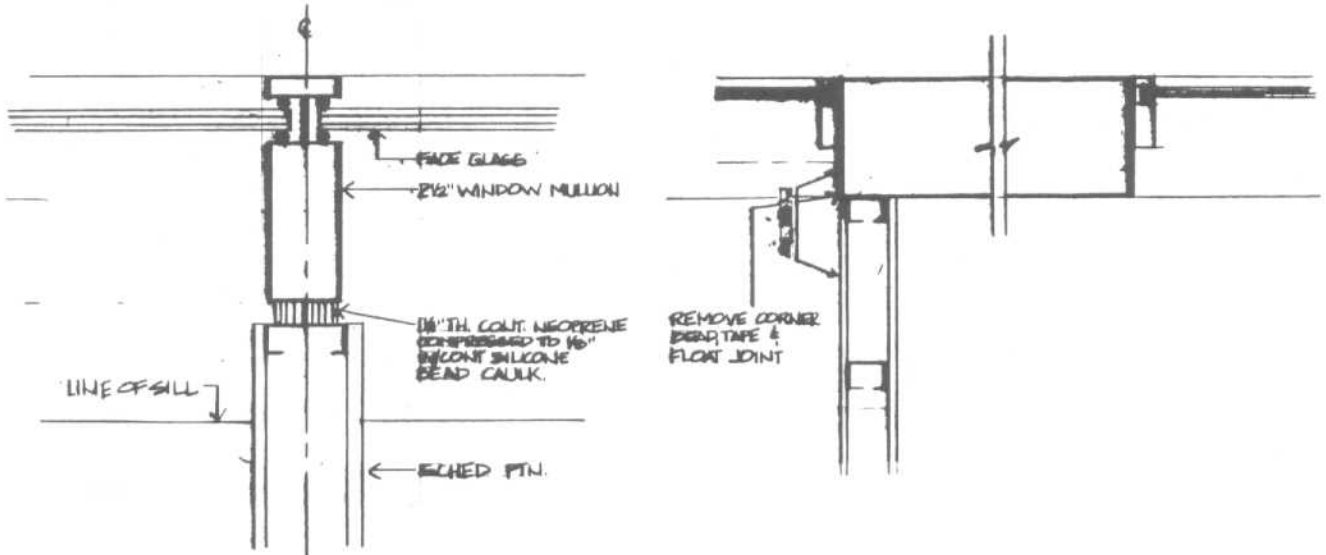
Metal Stud and Gypsum Board: Partition Conditions



Metal stud and gypsum board: partition to mullion detail



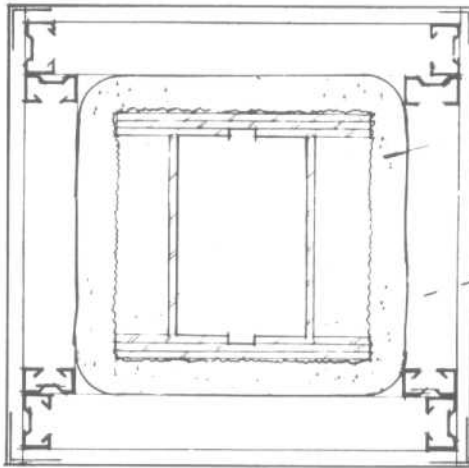
Metal stud and gypsum board: partition to column detail



Metal stud and gypsum board: partition to mullion detail

PARTITIONS AND WALL FINISHES

Metal Stud and Gypsum Board: Column Enclosures and Fireproofing

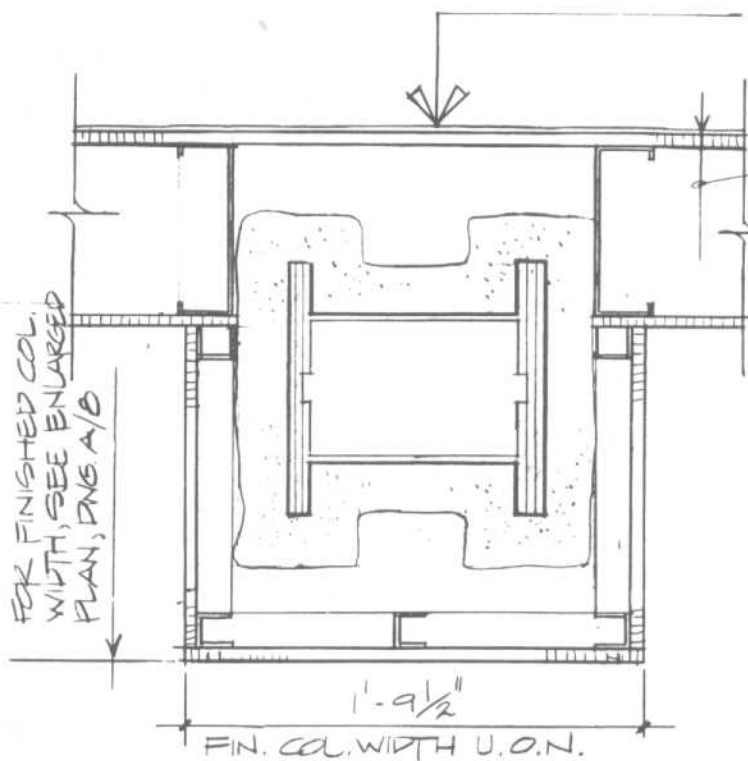


→ SPRAY ON FIREPROOFING

5/8" GYP. BR. ON 2 1/2" METAL STUDS @ 24" O.C. MAX. TO UNDERSIDE OF SLAB.

NOTE: WHEN COLUMN IS ENGAGED BY A 2 HR. RATED PARTITION - GYP. BR. TO BE 2 LAYERS W/ CAULK @ PERIMETER.

8 FIREPROOFING @ COL'S - 3HR RATED  
 A.27 1 1/2" x 1'-0" U.L. # X 709  
 NOTE: SIZE OF COLUMNS VARY. ON COLUMNS W/ LACING PROVIDE METAL LATH SEE NOTE 4a/b/A.27

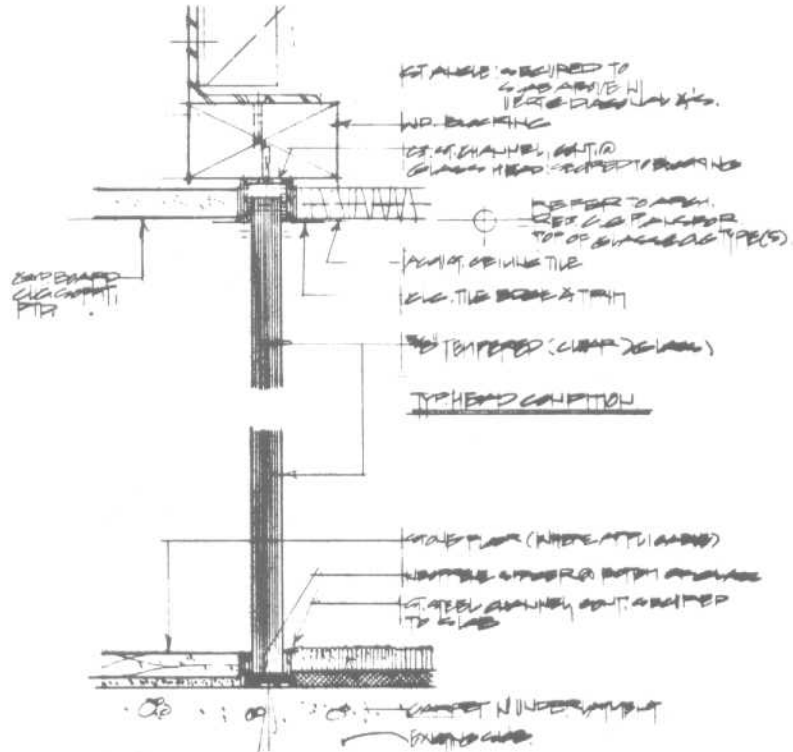


FOR FINISHED COL. WIDTH, SEE ENLARGED PLAN, PNG A/B

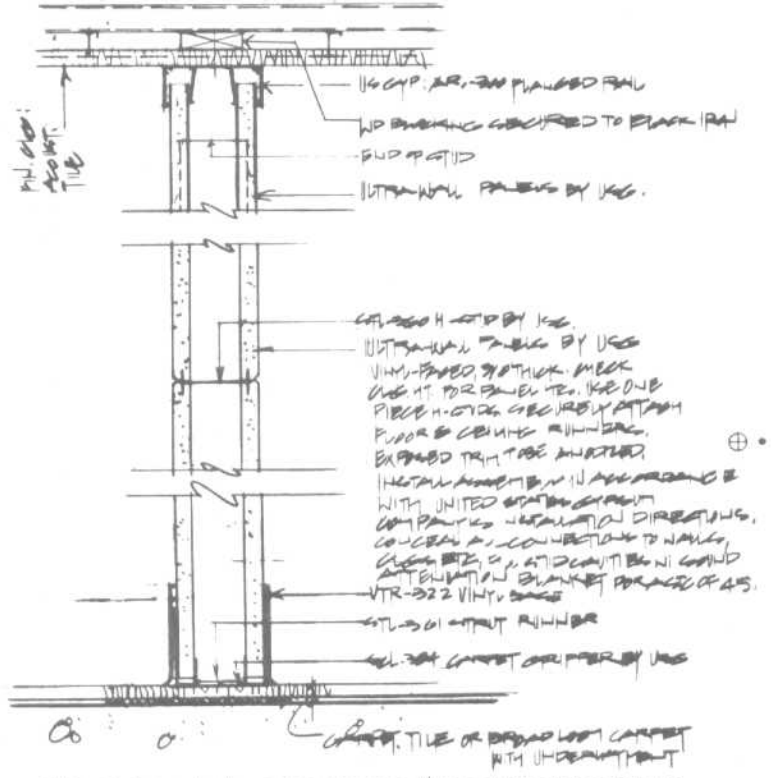
ONE LAYER 5/8" FIRECODE 'C' GYP BR BOTH SIDES ON 8" 16 GA. METAL FRAMING @ 16" O.C.  
 1/2" CEMENTITIOUS FIREPROOFING SPRAY APPLIED TO 3.4 LB/SQ. YD. METAL LATH - TIE LATH TO COL. W/ #18 SWG GALV. ST'L. WIRE U.L. DESIGN # X 709  
 1 1/2" METAL FRAMING W/ ONE LAYER 5/8" FIRECODE GYP BR.

9 TYPICAL COL. FIREPROOFING @ PERIMETER OF ATRIUM  
 A.27

PARTITIONS AND WALL FINISHES



12 TYPE D PARTIAL: FULL HEIGHT TEMPERED GLASS  
1/2" FLOOR  
Tempered glass

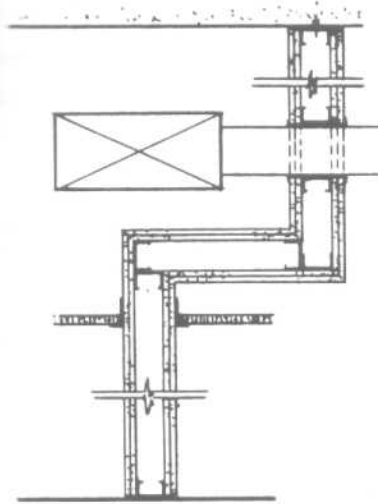


11 TYPE S PARTIAL: DEMOUNTABLE PARTITION  
S1-1-01  
PURCHASER SHOULD USE SYSTEM ULTRAWALL DEMOUNTABLE PARTITIONS WHERE INDICATED IN PLANS. PARTITIONS TO BE SUCH TYPE PANELS 3" THICK. ALL PARTS AND SUPPLIES SHOWN BY ARCHITECT SHALL BE APPROVED BY MANUFACTURER. PARTITION SHALL BE ASSEMBLED BY MANUFACTURER.

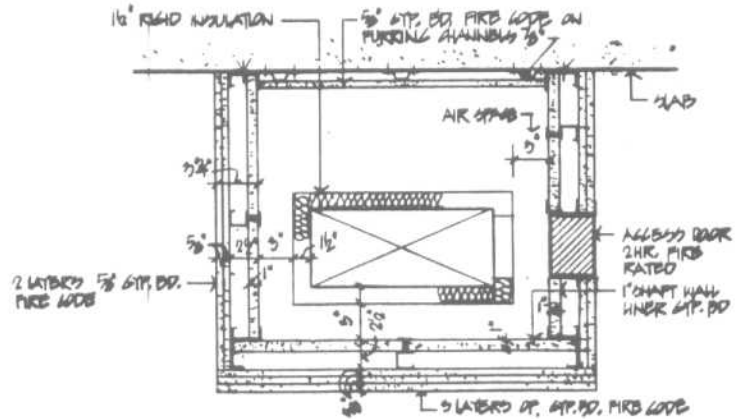


**PARTITIONS AND WALL FINISHES**

Miscellaneous Metal Stud and Gypsum Board Details



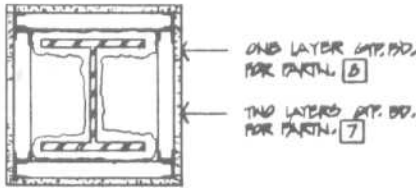
1 **DETAIL FOR FIRE RATED PART'N. & A.C. DUCT ABOVE**



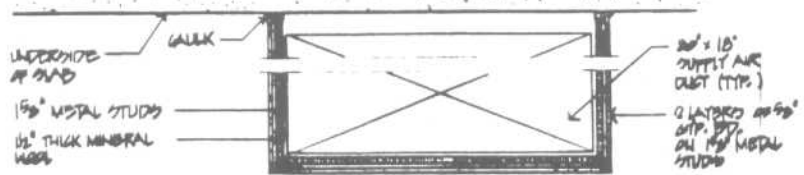
2 **SECTION @ METAL DUCT ENCLOSURE**

**NOTES**

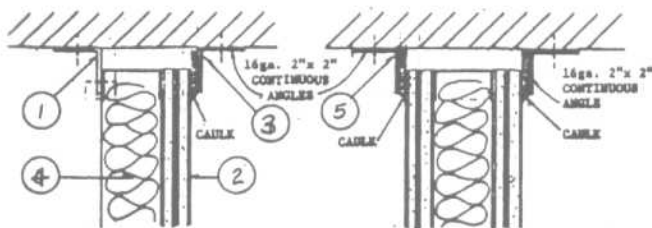
1. DUCT ENCLOSURE TO EXTEND FOR 20' DISTANCE FROM PAU ROOM
2. MAINTAIN 1/2" MIN. CLEARANCE BETWEEN DUCT AND 1 1/2" METAL STUDS.



3 **COLUMN FURRING**



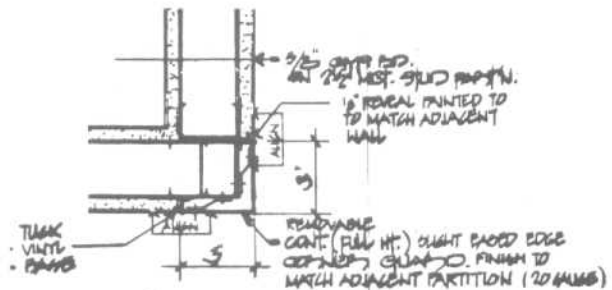
4 **SECTION AT SUPPLY AIR DUCT ENCLOSURE**



**SEQUENCE OF CONSTRUCTION**

- STEP 1 FASTEN TEMPORARY 2" x 2" ANGLE TO SLAB. FASTEN TOP RIBBER OF PARTITION TO TEMPORARY ANGLE AND ERRECT STUDS. (MAINTAIN 1" AIR SPACE BETWEEN RIBBER AND SLAB.)
- STEP 2 APPLY GYPSUM BOARD LAYER(S) TO ONE SIDE OF STUDS.
- STEP 3 FASTEN 2" x 2" CONTINUOUS ANGLE (WITH 1/4" FELT GLUED TO SIDE) TO SLAB ONLY (DO NOT SECURE STUDS TO THIS ANGLE).
- STEP 4 INSTALL USE SAN MINERAL WOOL BETWEEN STUDS.
- STEP 5 REMOVE TEMPORARY ANGLE AND REPLACE WITH 2" x 2" CONTINUOUS ANGLE (WITH 1/4" FELT GLUED TO SIDE). FASTEN THIS ANGLE TO SLAB ONLY.

5 **"SOFT" TERMINATION OF PARTITIONS**



6 **TYP. PAINT COPINGS DET'L.**

**PARTITIONS AND WALL FINISHES**

**Sound Insulation and Transmission**

The resistance of a building element, such as a wall, to the passage of airborne sound is rated by its *sound transmission class* (STC). Thus, the higher the number, the better the sound barrier. The approximate effectiveness of walls with varying STC numbers is shown in the following tabulation:

STC No.	Effectiveness
25	Normal speech can be understood quite easily
35	Loud speech audible but not intelligible
45	Must strain to hear loud speech
48	Some loud speech barely audible
50	Loud speech not audible

Sound travels readily through the air and also through some materials. When airborne sound strikes a conventional wall, the studs act as sound conductors unless they are separated in some way from the covering material.

**Wall Construction**


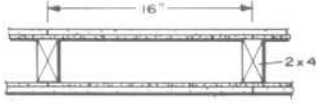

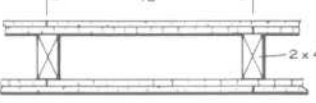
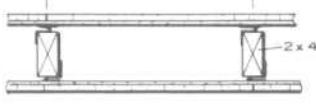
As the preceding STC tabulation shows, a wall providing sufficient resistance to airborne sound transfer likely has an STC rating of 45 or greater. Thus, in construction of such a wall between the rooms of a house, its cost as related to the STC rating should be considered. As shown in Fig. 5, details A, with gypsum wallboard, and B, with plastered wall, are those commonly used for partition walls. However, the hypothetical rating of 45 cannot be obtained in this construction.

Good STC ratings can be obtained in a wood-frame wall by using the combination of materials shown in Fig. 5D and E. One-half-inch sound-deadening board nailed to the studs, followed by a lamination of 1/2-in gypsum wallboard, will provide an STC value of 46 at a relatively low cost. A slightly better rating can be obtained by using 5/8-in gypsum wallboard rather than 1/2-in. A very satisfactory STC rating of 52 can be obtained by using resilient clips to fasten gypsum backer boards to the studs, followed by adhesive-laminated 1/2-in fiberboard (Fig. 5E). This method further isolates the wall covering from the framing.

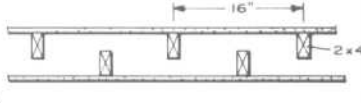
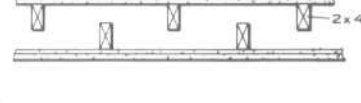
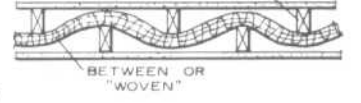
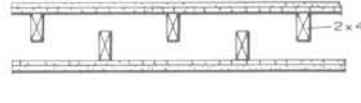
A similar isolation system consists of resilient channels nailed horizontally to 2- by 4-in studs spaced 16 in on center. Channels are spaced 24 in apart vertically and 5/8-in gypsum wallboard is screwed to the channels. An STC rating of 47 is thus obtained at a moderately low cost.

Thus use of a double wall, which may consist of a 2 by 6 or wider plate and staggered 2- by 4-in studs, is sometimes desirable. One-half-inch gypsum wallboard on each side of this wall (Fig. 6A) results in an STC value of 45. However, two layers of 5/8-in gypsum wallboard add little, if any, additional sound-transfer resistance (Fig. 6B). When 1 1/2-in blanket insulation is added to this construction (Fig. 6C), the STC rating increases to 49. This insulation may be installed as shown or placed between studs on one wall. A single wall with 3 1/2 in of insulation will show a marked improvement over an open stud space and is low in cost.

The use of 1/2-in sound-deadening board and a lamination of gypsum wallboard in the double wall will result in an STC rating of 50 (Fig. 6D). The addition of blanket insulation to this combination will likely provide an even higher value, perhaps 53 or 54.

WALL DETAIL	DESCRIPTION	STC RATING
	1/2" GYPSUM WALLBOARD	32
	5/8" GYPSUM WALLBOARD	37
A		
	3/8" GYPSUM LATH (NAILED) PLUS 1/2" GYPSUM PLASTER WITH WHITECOAT FINISH (EACH SIDE)	39
B		
	8" CONCRETE BLOCK	45
C		
	1/2" SOUND DEADENING BOARD (NAILED) 1/2" GYPSUM WALLBOARD (LAMINATED) (EACH SIDE)	46
D		
	RESILIENT CLIPS TO 3/8" GYPSUM BACKER BOARD 1/2" FIBERBOARD (LAMINATED) (EACH SIDE)	52
E		

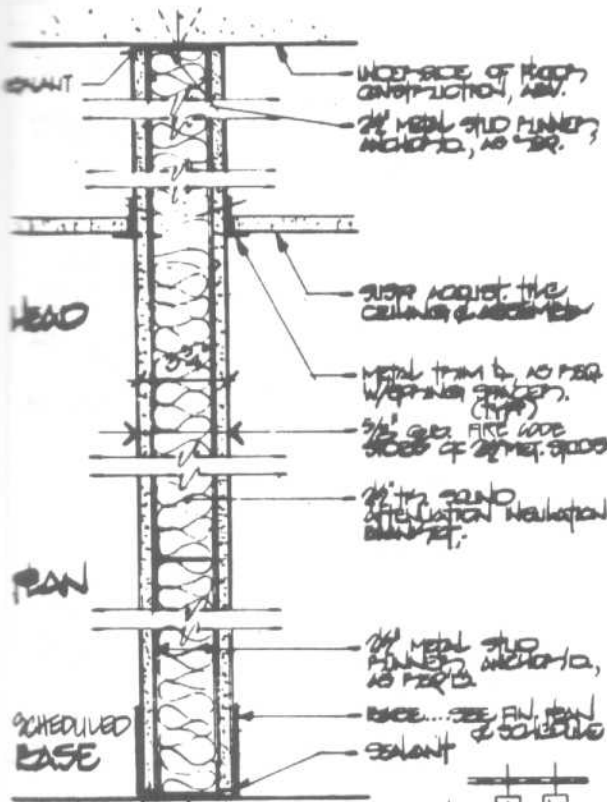
**Fig. 5 Sound insulation of single walls.**

WALL DETAIL	DESCRIPTION	STC RATING
	1/2" GYPSUM WALLBOARD	45
A		
	5/8" GYPSUM WALLBOARD (DOUBLE LAYER EACH SIDE)	45
B		
	1/2" GYPSUM WALLBOARD 1 1/2" FIBROUS INSULATION	49
C		
	1/2" SOUND DEADENING BOARD (NAILED) 1/2" GYPSUM WALLBOARD (LAMINATED)	50
D		

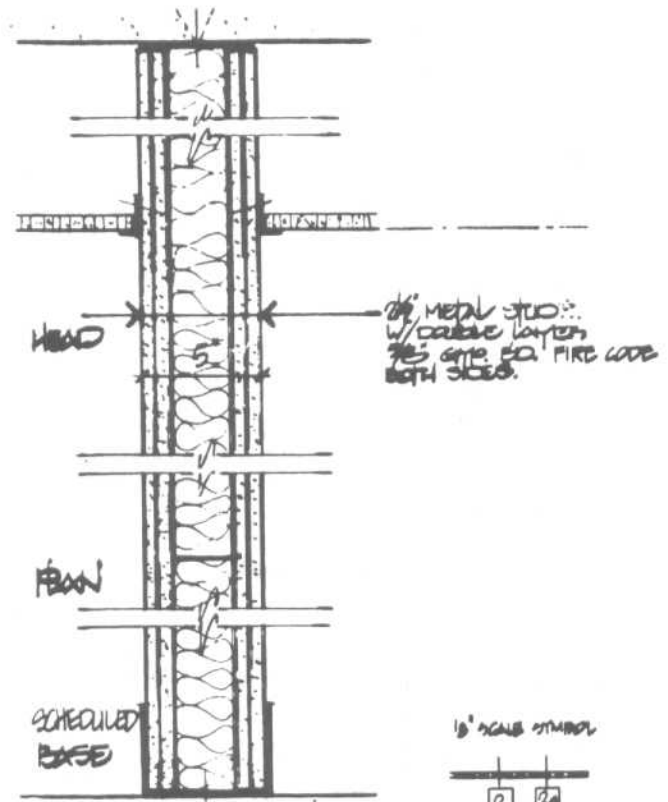
**Fig. 6 Sound insulation of double walls.**

PARTITIONS AND WALL FINISHES

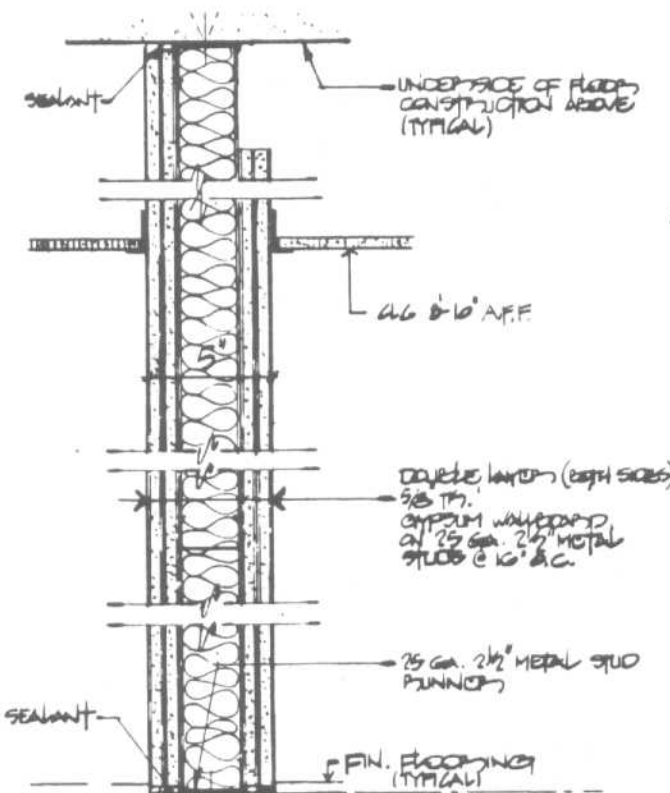
Acoustical and Fire-Rated Metal Stud and Gypsum Board



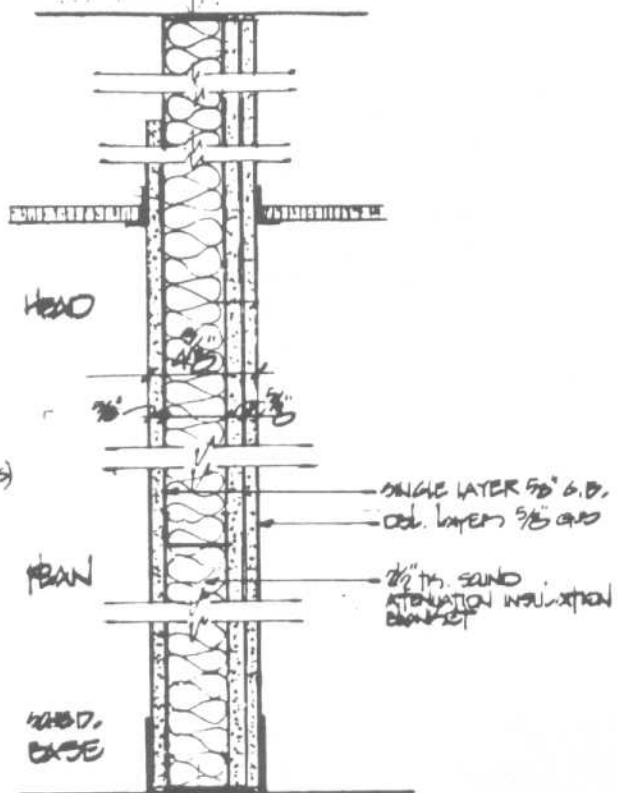
**1** ONE HOUR FIRE RATED PARTITION  
**1a** SAME AS **1** BUT WITH SOUND ATTENUATION BLANKET



**2** TWO HOUR FIRE RATED PARTITION  
**2a** SAME AS **2** BUT WITH SOUND ATTENUATION BLANKET



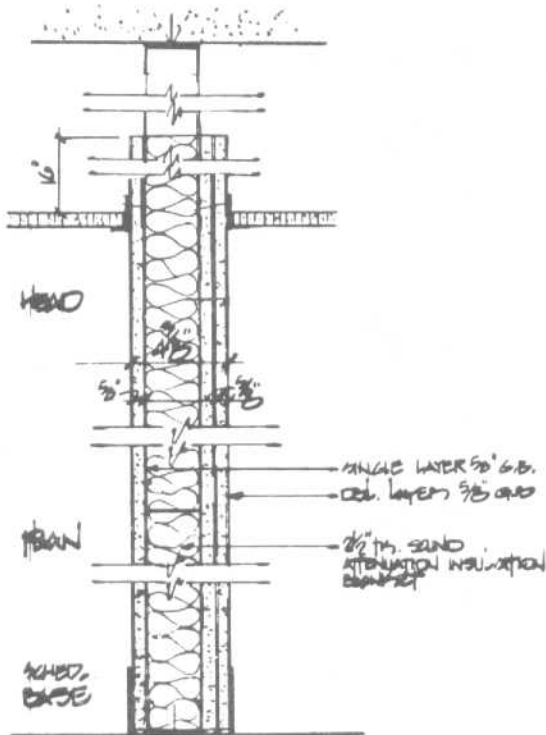
**3a** SOUND PARTITION / 'CLASS A' /



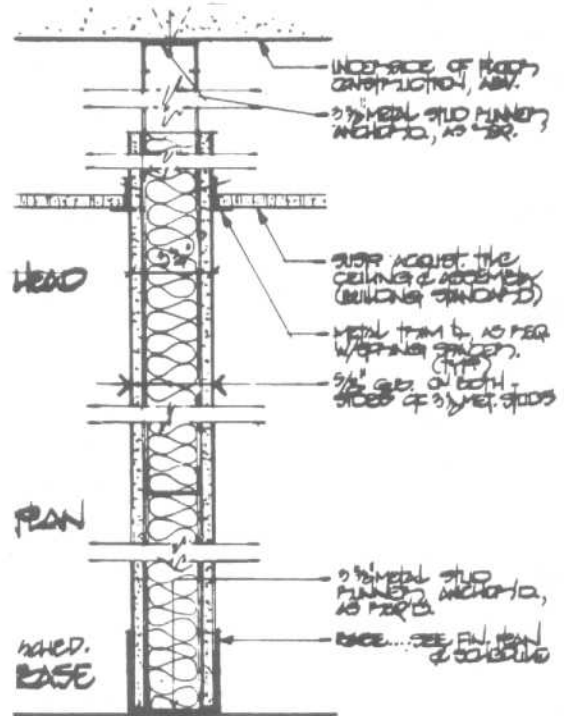
**4a** SOUND PARTITION / 'CLASS B' /

PARTITIONS AND WALL FINISHES

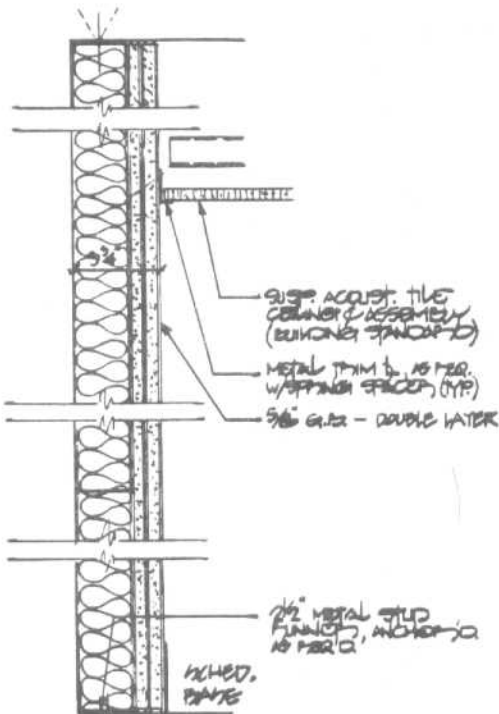
Acoustical and Fire-Rated Metal Stud and Gypsum Board



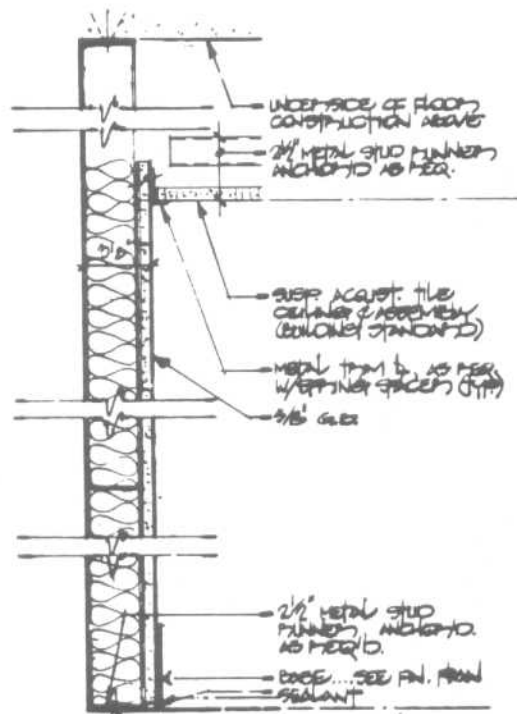
**5** DRYWALL PARTITION, USE TO ALIGN WITH PARTITION **2** @ NON-FIRE RATED AREA.  
**5a** SAME AS **5** BUT WITH SOUND ATTENUATION BLANKET USE TO ALIGN WITH PARTITION **2a** & **3a** @ NON-FIRE RATED AREA



**6** DRYWALL PARTITION TO 6" ABOVE CEILING  
**6a** SAME AS **6** BUT WITH SOUND ATTENUATION BLANKET 7" CLASS C7

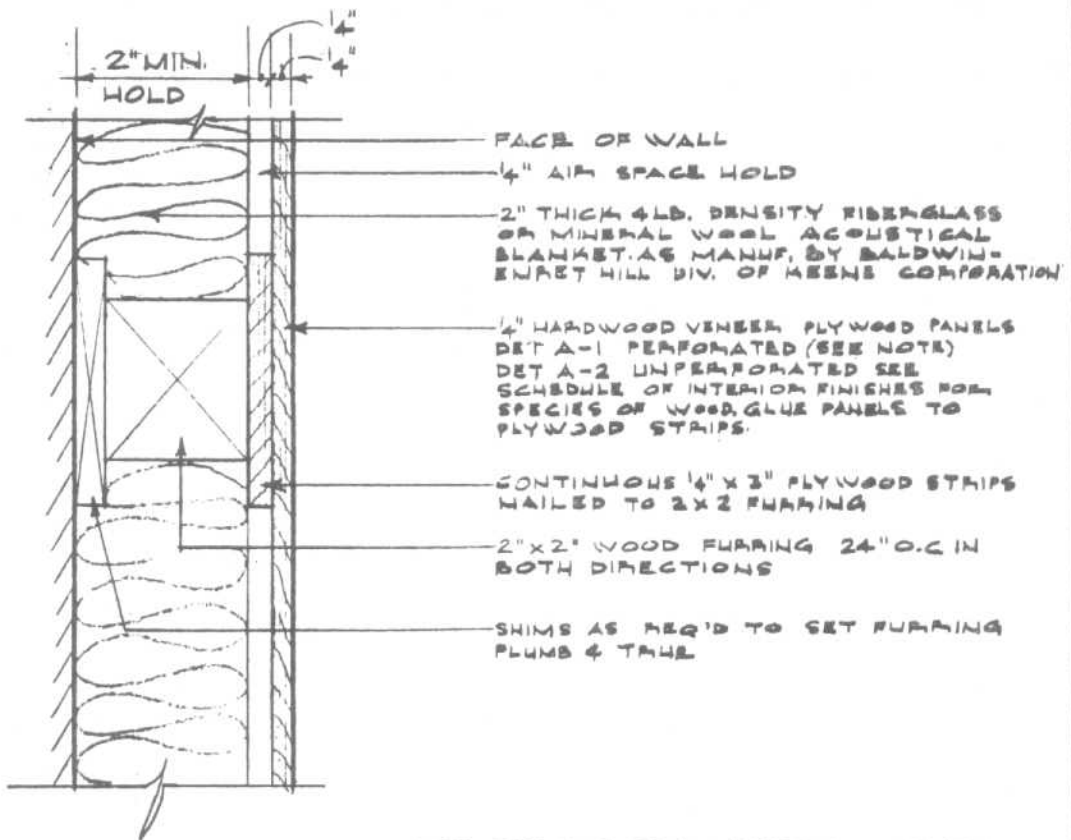


**7** FUR-OUT PARTITION / USE WITH PARTITIONS **2** @ COLUMN ENCLOSURE  
**7a** SAME AS **7** BUT WITH SOUND ATTENUATION BLANKET



**8** FUR-OUT GYPSUM B'D, ON METAL STUDS, CHASE PARTITION & COLUMN ENCLOSURE  
**8a** SAME AS **8** BUT WITH SOUND ATTENUATION BLANKET

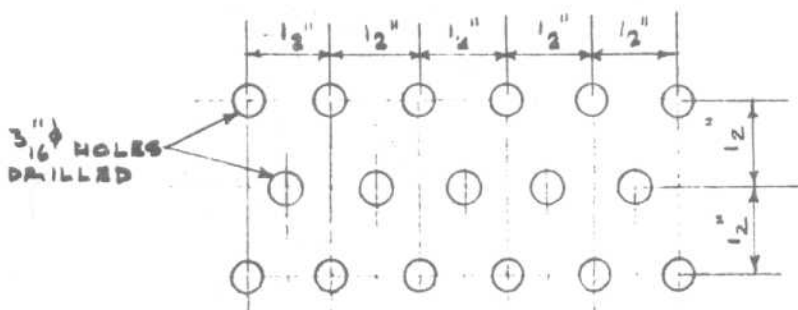
**PARTITIONS AND WALL FINISHES**  
Acoustical Wood Veneer Plywood Wall Paneling



**NOTE:** PERFORATED HARDWOOD VENEER PANELS SHALL HAVE 3/16" DIA. HOLES 1/2" O.C. HOLES SHALL BE DRILLED NOT PUNCHED OPEN AREA TO BE AT LEAST 11%

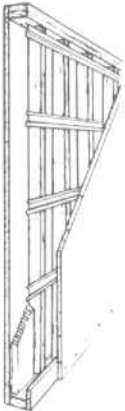
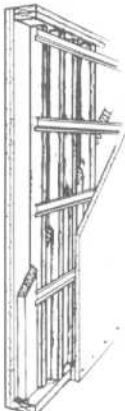
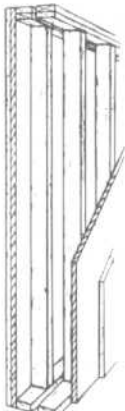
- (A-1) PERFORATED HARDWOOD VENEER PLYWOOD FINISH
- (A-2) UNPERFORATED HARDWOOD VENEER PLYWOOD FINISH

**ACOUSTIC WALL TREATMENT DETAILS**



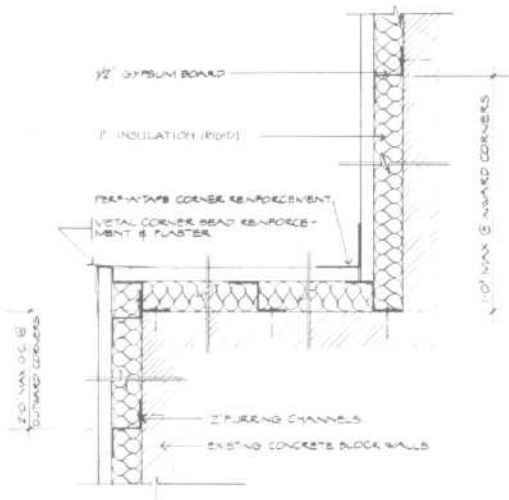
**PATTERN FOR PERFORATED PLYWOOD**

# wood frame partition systems for sound control

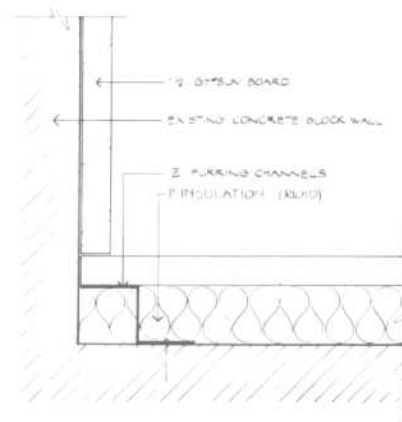
PARTITION SYSTEM	WALL NUMBER	WALL FACE	STC
<p><b>single stud walls</b></p> <p>Basic construction is 2" x 4" studs 16" o.c. with double top plate and single or double bottom plate. Faces are 5/8" thick fire resistive type gypsum board applied, taped and finished in accordance with manufacturer's recommendations. Resilient channels are applied to studs 24" o.c. as shown with a 1/2"x3" gypsum nailing strip at the bottom. Absorptive material is paper-backed glass fiber or mineral wool batts stapled in the stud space as illustrated. Sound deadening board is sound-rated organic fiber board with a 15-18 pcf density.</p> <p><b>no. 3</b></p> 	1	Single gypsum board each side, applied with screws; no resilient channels	34
	2	Single gypsum board laminated and nailed <sup>2</sup> over sound board each side; no channels	45
	3	Single gypsum board applied with screws 1 side; opposite side on resilient channels	50
	4	Single gypsum board laminated and nailed <sup>2</sup> over sound board, opposite side on resilient channels	52
	5	Single gypsum board on resilient channels each side	53
	6	Double 1/2" gypsum board, base sheet vertical; face sheet horizontal; applied on resilient channels one side	59
<p><b>double stud walls with a common plate</b></p> <p>basic construction is a double row of 2"x3" or 2"x4" studs, each row 16" o.c. and each row aligned with an opposite edge of the 2"x6" top and bottom plates. The rows of studs are offset 2" to 8" to prevent any chance contact. Other details and materials are as described for single stud walls.</p> <p><b>no. 11</b></p> 	7	Single gypsum board each side, applied with screws (2x3 studs—16" o.c.); no resilient channels	49
	8 <sup>1</sup>	Single gypsum board laminated and nailed <sup>2</sup> over sound deadening board each side (2x4 studs—16" o.c.); no resilient channels	49
	9 <sup>1</sup>	Single gypsum board nailed one side. Single gypsum on resilient channels opposite	50
	10	Single gypsum board laminated and nailed <sup>2</sup> over sound deadening board 1 side. Single gypsum board on resilient channels opposite (2x3 studs—16" o.c.)	53
	11	Double gypsum board (1/2" over 5/8") nailed one side; single gypsum board on resilient channels opposite (2x4 studs—24" o.c.)	56
<p><b>double stud walls on separate plates</b></p> <p>Basic construction is a double wall of 2"x3" studs on separate plates about 1" apart. Studs of each frame are 16" o.c. with the studs in one frame offset 2" to 8" from those of the other. Other details and materials are as described for single stud walls.</p> <p><b>no. 13</b></p> 	12	Single gypsum board each side applied with screws	51
	13	Single gypsum board laminated and nailed <sup>2</sup> over sound board each side	53
	14	Same as wall 13	60
	15	Single gypsum board laminated and nailed <sup>2</sup> over sound board 1 side; single gypsum board on resilient channels opposite	58
	16	Double gypsum board; nailed each side	51
	17	Double gypsum board each side; outer layer laminated and nailed <sup>2</sup> ; base layer nailed	59
	18	Double gypsum board laminated and nailed <sup>2</sup> one side. Single gypsum board on resilient channels opposite	57

<sup>1</sup> Design No. 5—1 Hr. combustible (bearing wall) Underwriters' Lab, Inc. (10)  
<sup>2</sup> Face laminated vertically with three 6-inch wide strips of construction adhesive and nailed with about half the usual number of nails.

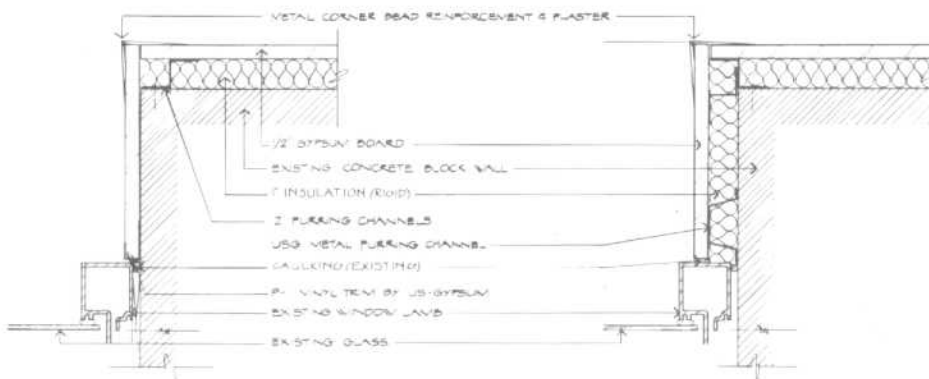
PARTITIONS AND WALL FINISHES



1 OUTWARD & INWARD CORNER DETAIL (TYPICAL)  
SCALE: 1/2" = 1'-0"



4 FURRING AT INTERIOR CORNERS  
FULL SCALE

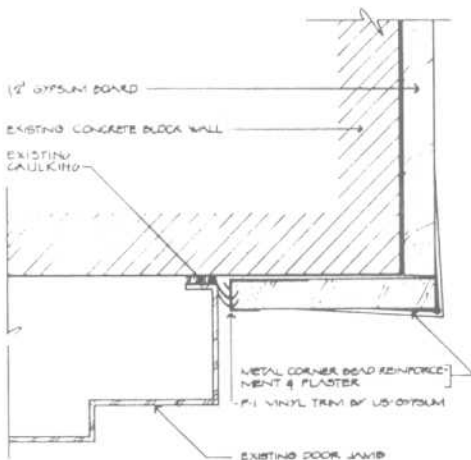


NOTE: THE ABOVE DETAILS ARE SOLUTIONS FOR THE SAME CONDITION.

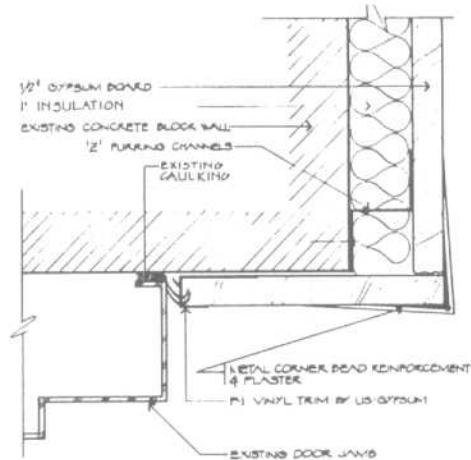
2 FURRING AT WINDOW JAMB  
SCALE: 1/2" = 1'-0"

3 FURRING AT WINDOW JAMB  
SCALE: 1/2" = 1'-0"

Metal "Z" furring and gypsum board: exterior walls



5 FURRING AT DOOR JAMB (TYPICAL & INTERIOR WALLS)  
FULL SCALE



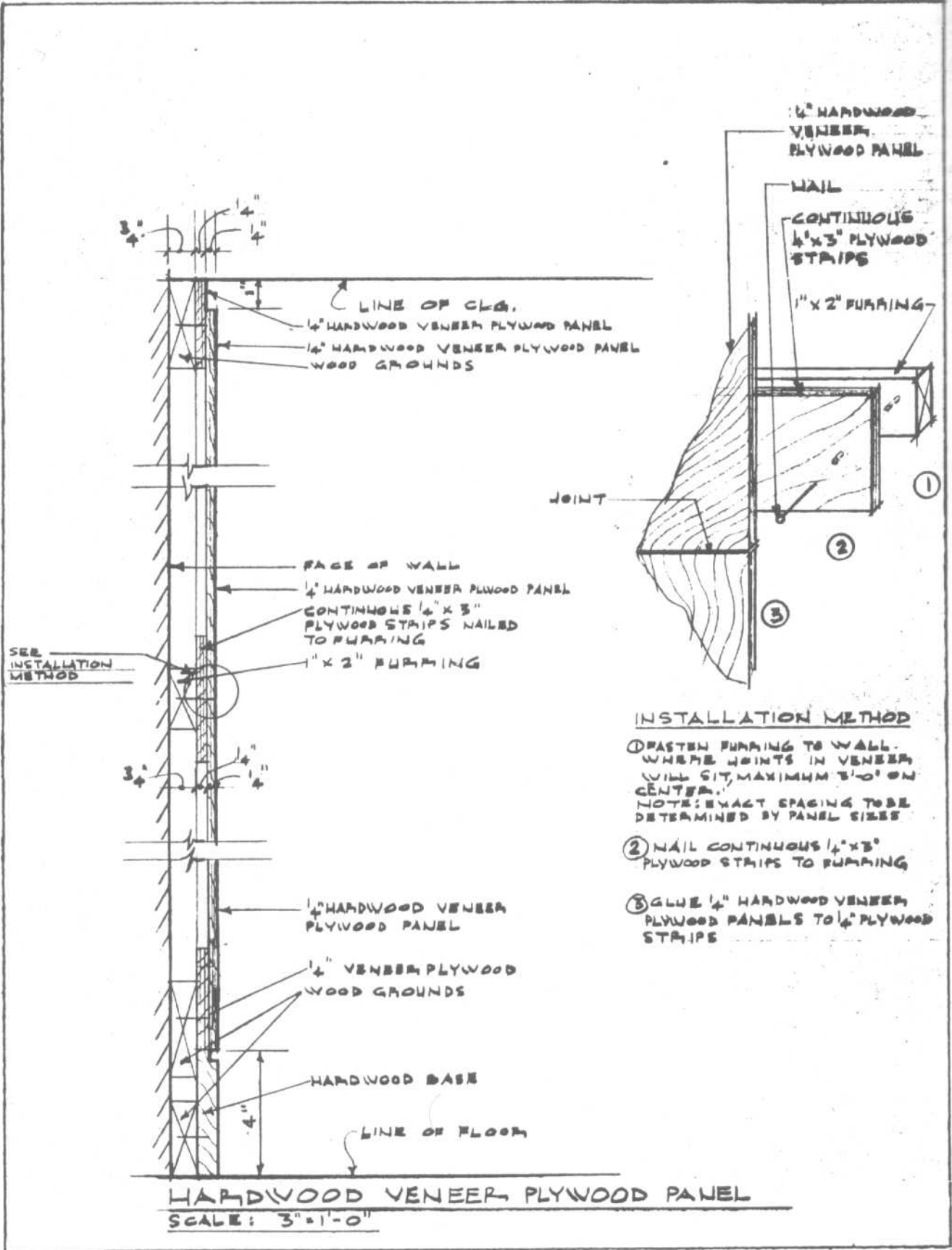
6 FURRING AT DOOR JAMB (TYPICAL & EXTERIOR WALLS)  
FULL SCALE

Metal "Z" furring and gypsum board: door jamb details



PARTITIONS AND WALL FINISHES

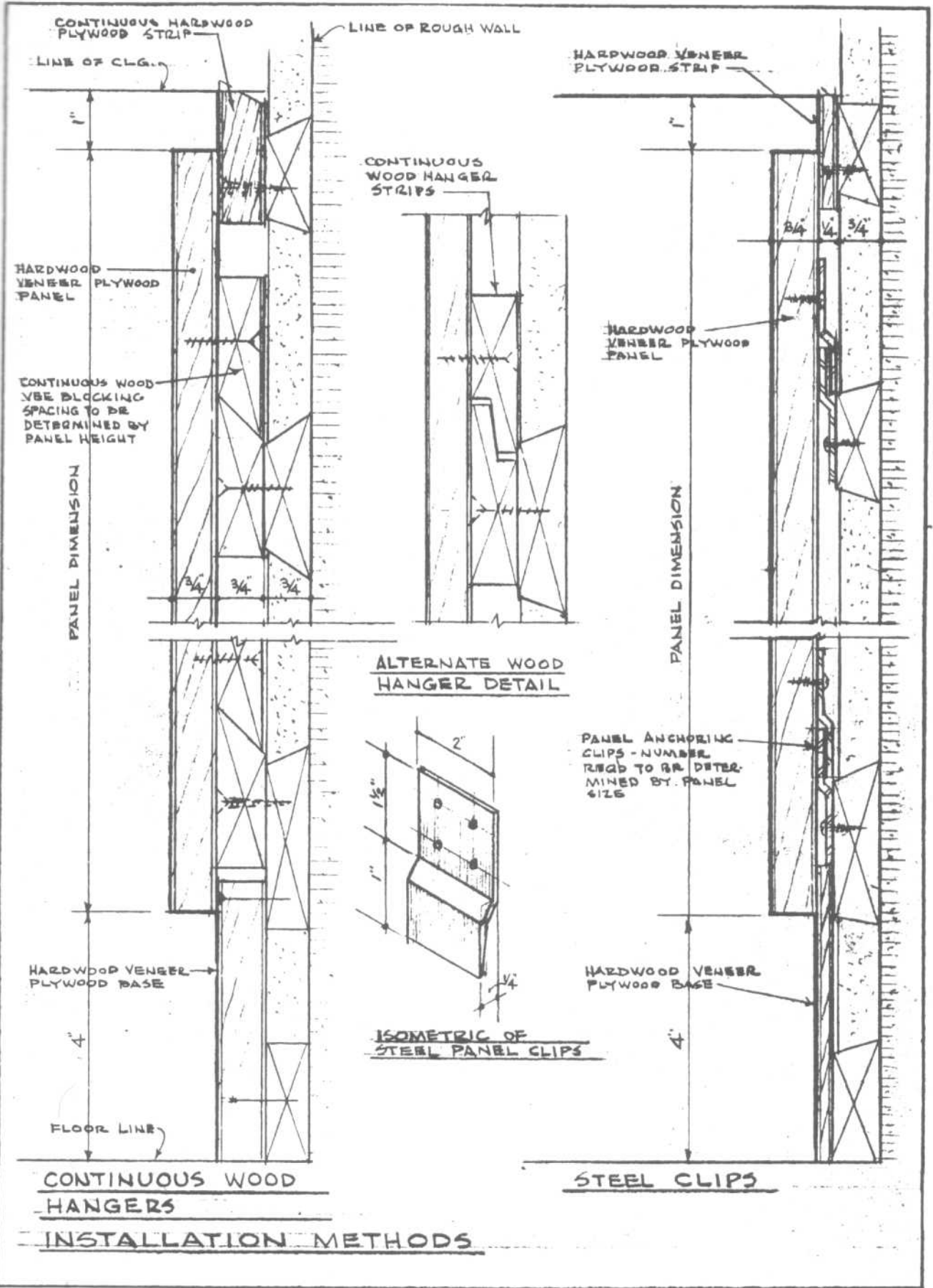
Wood Veneer Plywood Wall Paneling





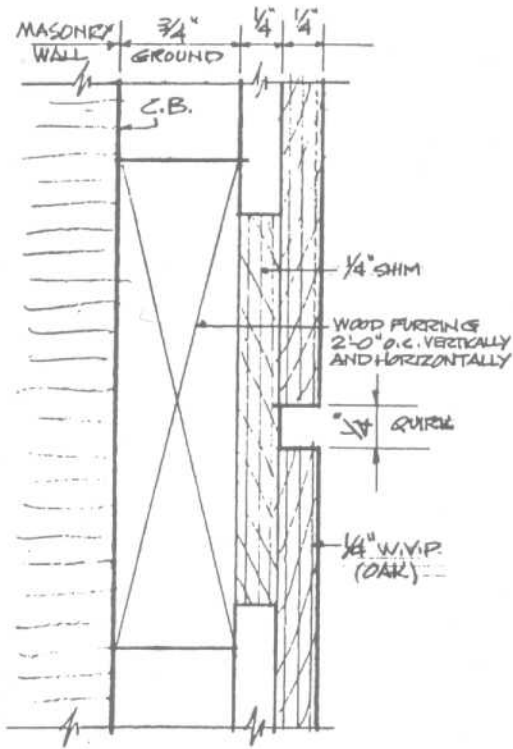
PARTITIONS AND WALL FINISHES

Wood Veneer Plywood Wall Paneling

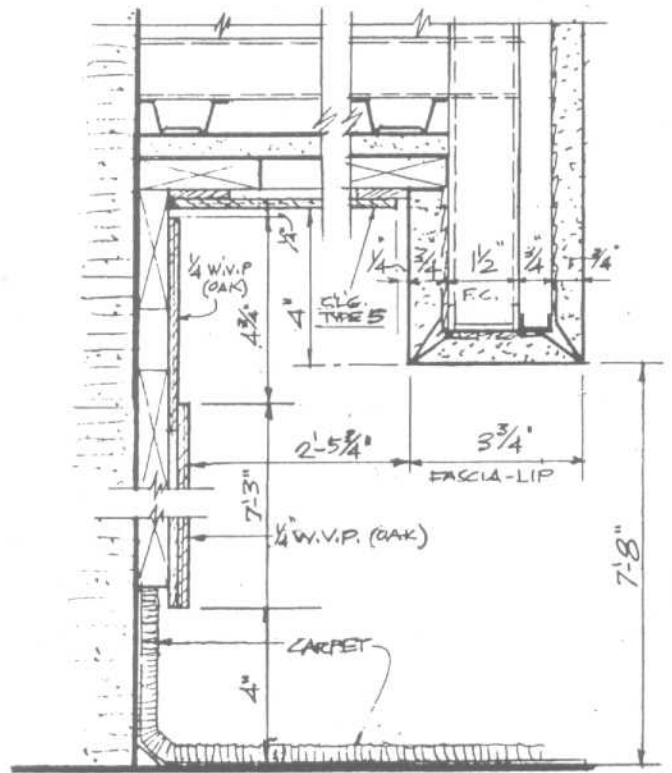


PARTITIONS AND WALL FINISHES

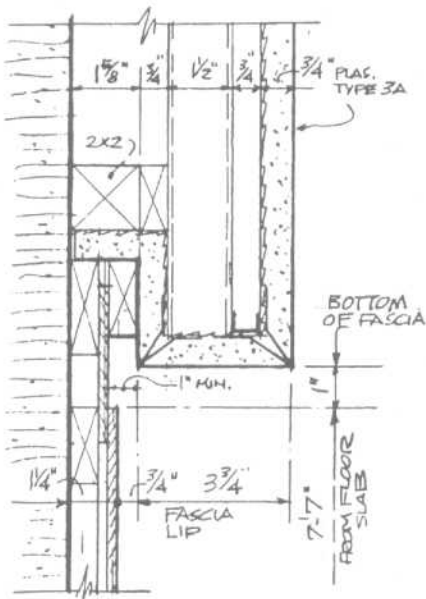
Wood Wall Paneling Details and Conditions



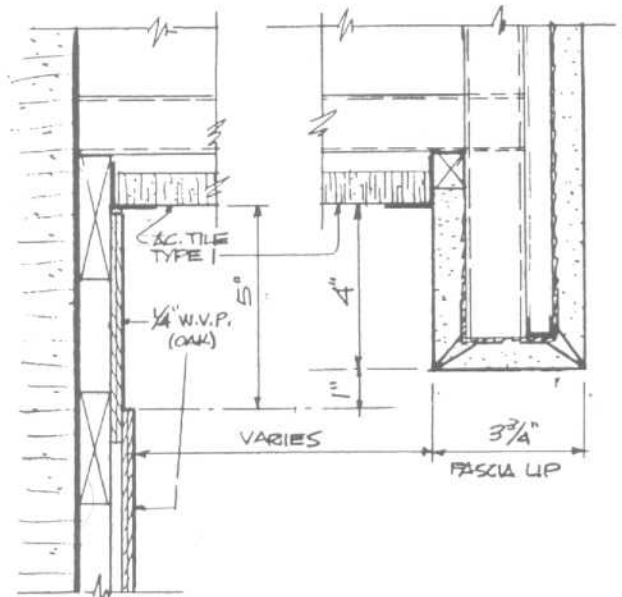
**2A** TYPICAL JOINT FOR  
W.V.P. WALLS



**2B** (TYPE 5)  
WALL/CEILING/FASCIA  
INTERSECTIONS IN  
SANTUARY/FOYER



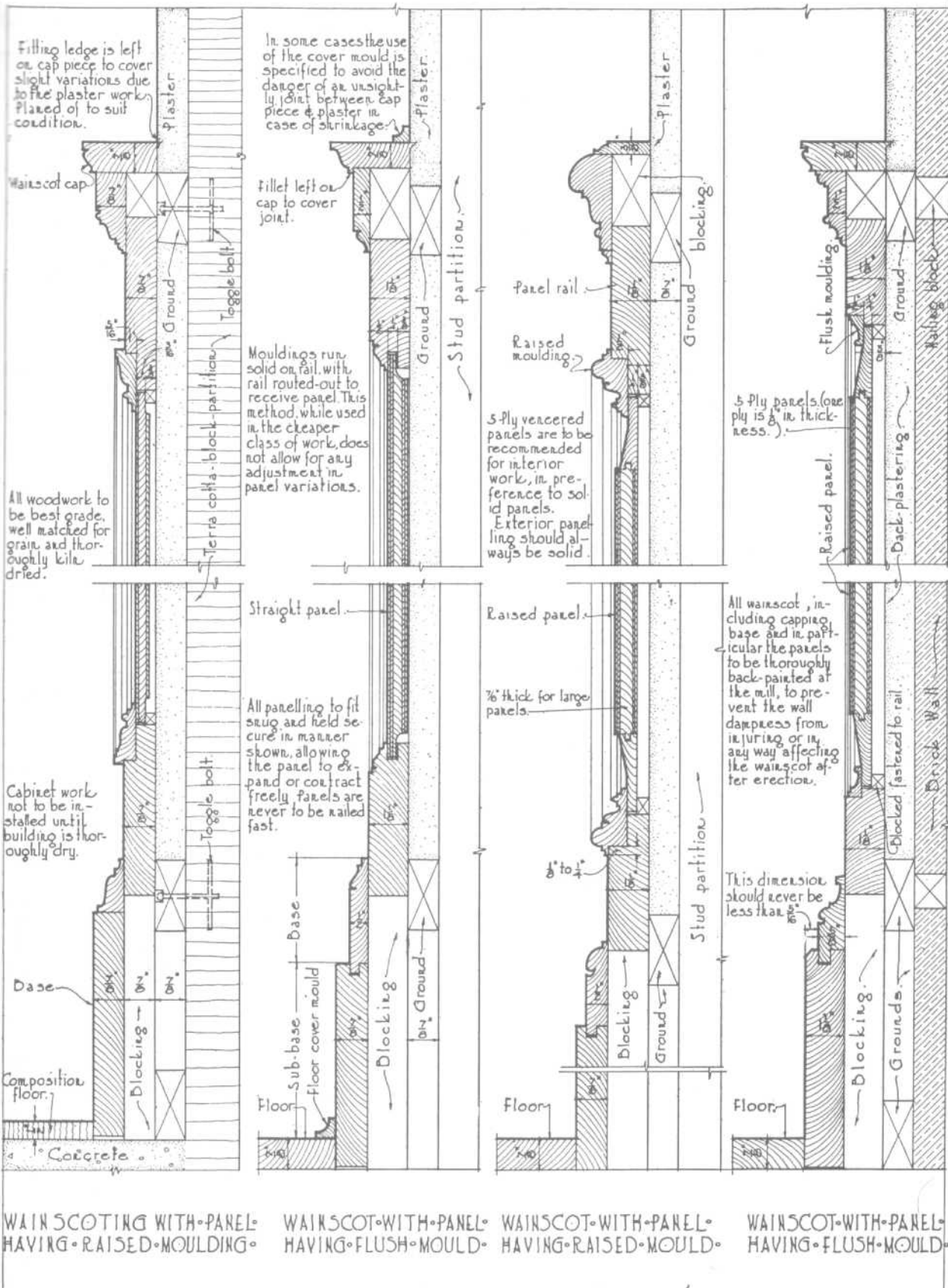
**2C** WALL/FASCIA  
INTERSECTION  
(WITH NO SOFFIT)



**2D** (TYPE 1)  
W.V.P. WALL / AC. TILE CEILING/  
FASCIA INTERSECTIONS

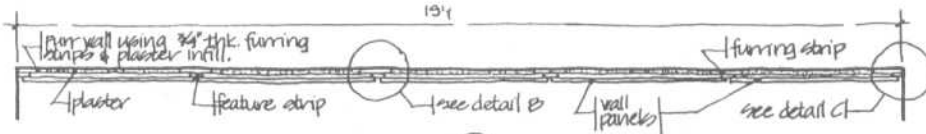
PARTITIONS AND WALL FINISHES

Wood Wall Paneling and Wainscoting Details and Conditions

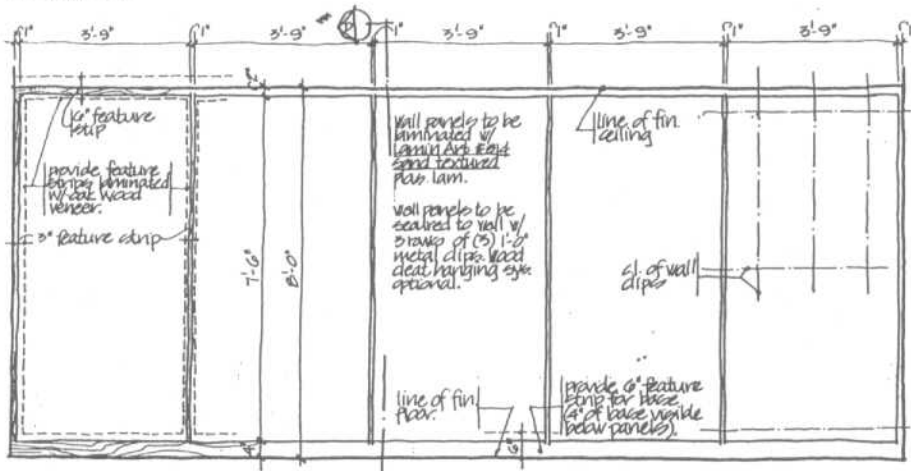


PARTITIONS AND WALL FINISHES

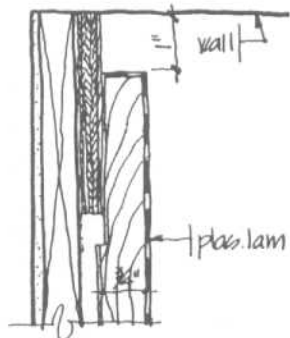
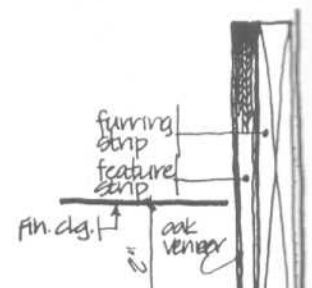
Wall Paneling Elevation



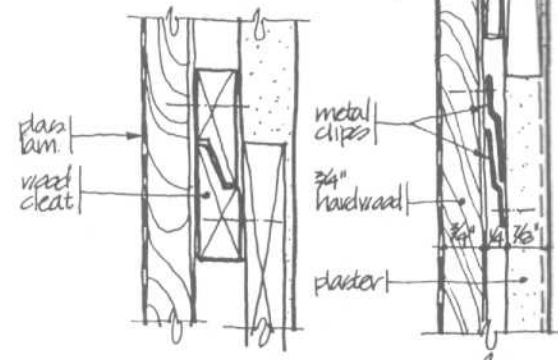
PLAN OF WALL  
SCALE 1/8"=1'-0"



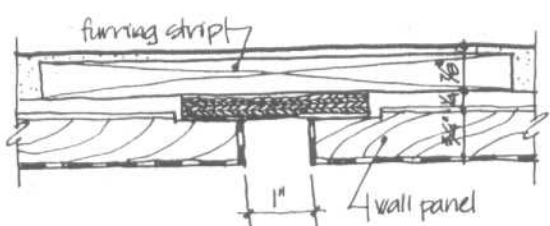
WALL ELEVATION A  
SCALE 1/8"=1'-0"



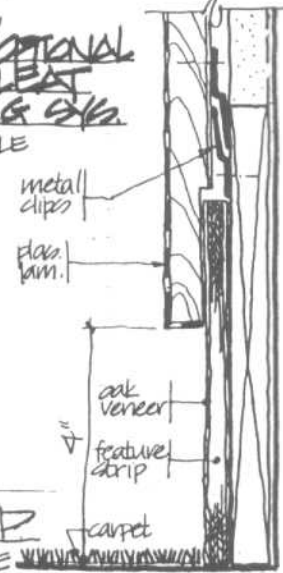
SECTION DETAIL C  
1/2 FULL SCALE



DETAIL/OPTIONAL  
WOOD CLEAT  
HANGING EYE  
1/2 FULL SCALE



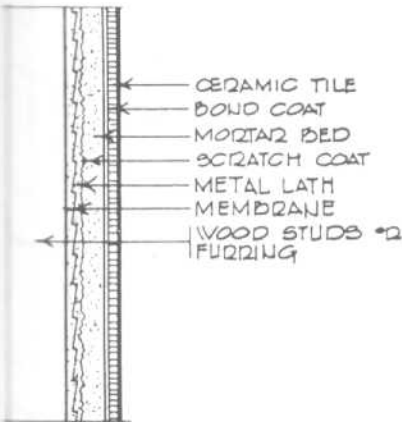
DETAIL A  
1/2 FULL SCALE



SECTION D-P  
SCALE: 1/2 FULL SCALE

### Wood Studs or Furring

Cement Mortar

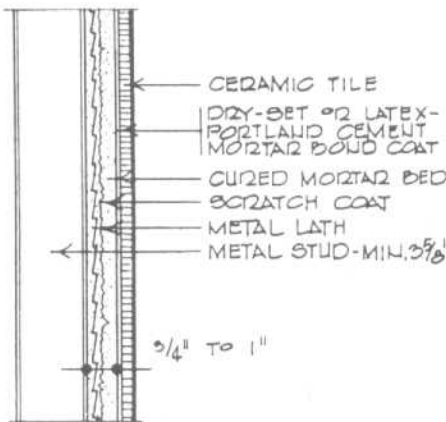


**Recommended uses**

- over dry, well-braced wood studs or furring
- preferred method of installation over wood studs in showers and tub enclosures

### Metal Studs

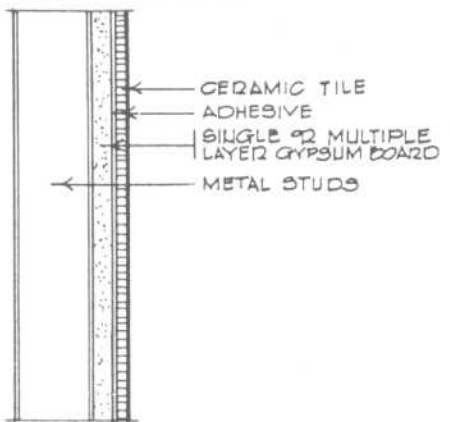
Cement Mortar



**Recommended use**

- over metal studs

### Gypsum Board Organic Adhesive

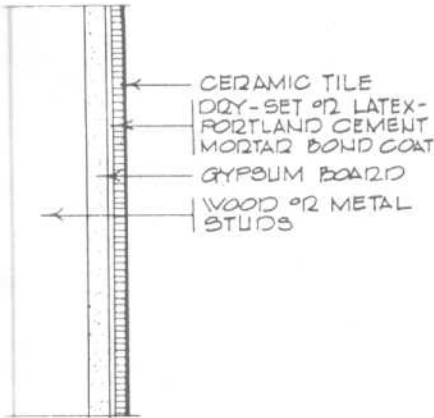


**Recommended uses**

- over gypsum board screwed to metal studs, single or double layer installed in accordance with GA-216
- where a gypsum board, non-load-bearing partition is desired with durable, low-maintenance finish
- for fire-resistant, sound-insulated, ceramic-tiled walls (fire-resistance and sound-insulation ratings calculated on partitions before tiling)
- for dry areas in schools, institutions, and commercial buildings

### Wood or Metal Studs Gypsum Board

Dry-Set Mortar or Latex  
Portland Cement Mortar

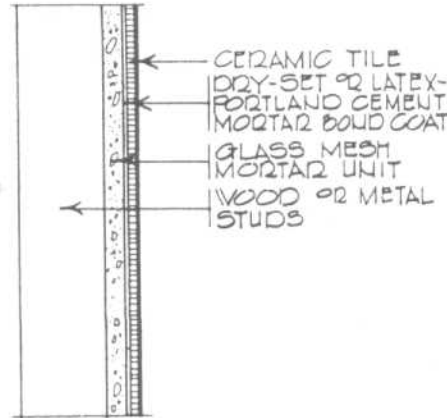


**Recommended uses**

- dry interiors over gypsum wall board
- for dry areas in schools, institutions, and commercial buildings

### Glass Mesh Mortar Unit

Dry-Set Mortar or Latex  
Portland Cement Mortar



**Recommended uses**

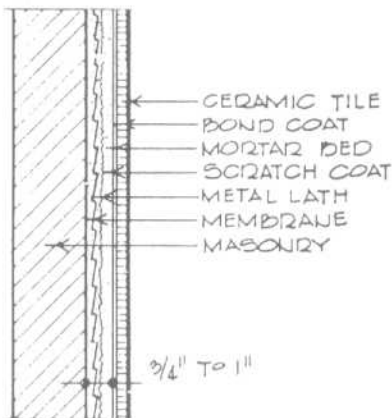
- in wet areas
- over dry, well-braced wood studs or furring
- over well-braced metal studs

PARTITIONS AND WALL FINISHES

Ceramic Tile Wall Finishes

Masonry

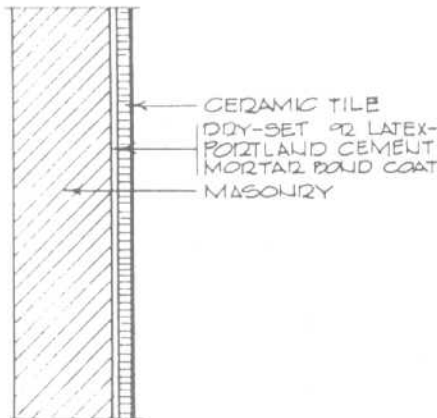
Cement Mortar



Recommended use

- over masonry or concrete on exteriors

Dry-Set Mortar or Latex-Portland Cement Mortar

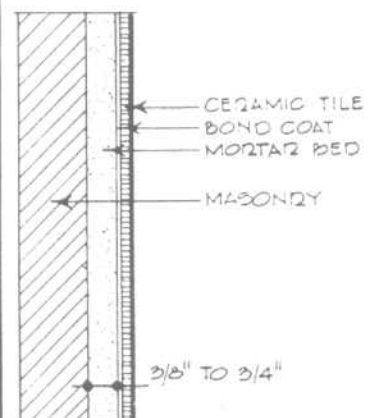


Recommended use

- over clean, sound, dimensionally stable masonry or concrete

Masonry or Concrete

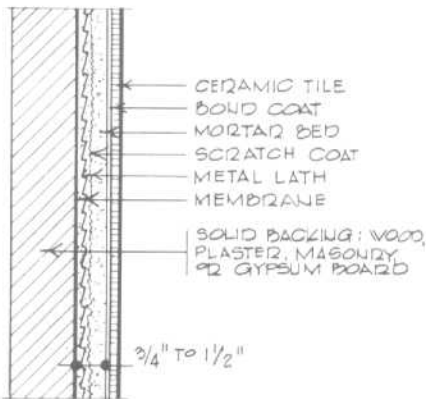
Cement Mortar Bonded



Recommended use

- over clean sound, dimensionally stable masonry or concrete

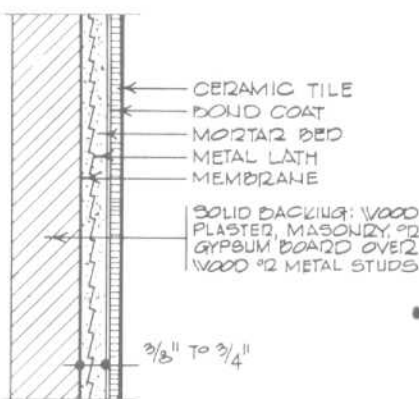
Cement Mortar



Recommended uses

- over masonry, plaster, or other solid backing that provides firm anchorage for metal lath
- ideal for remodeling or on surfaces that present bonding problems

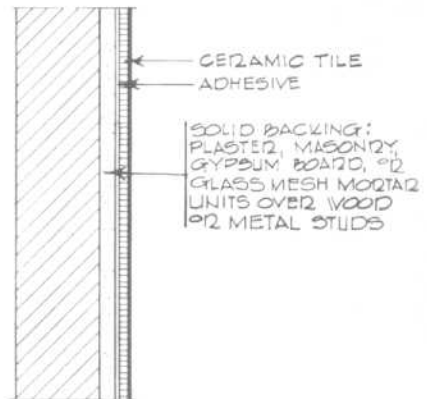
One Coat Method



Recommended uses

- over masonry, plaster, or other solid backing that provides firm anchorage for metal lath
- ideal for remodeling or on surfaces that present bonding problems
- ideal for remodeling where space limitations exist
- preferred method of applying tile over gypsum plaster or gypsum board in showers and tub enclosures

Organic Adhesive

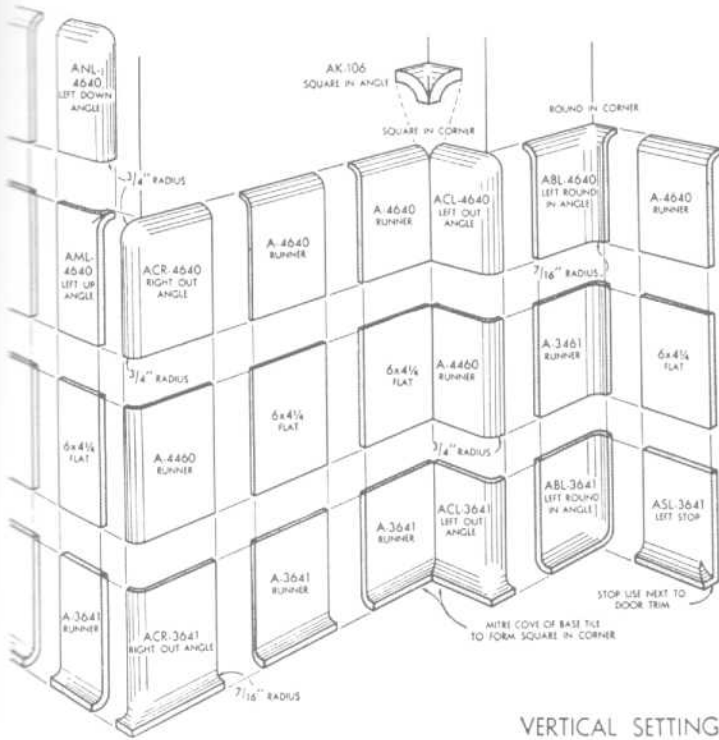


Recommended use

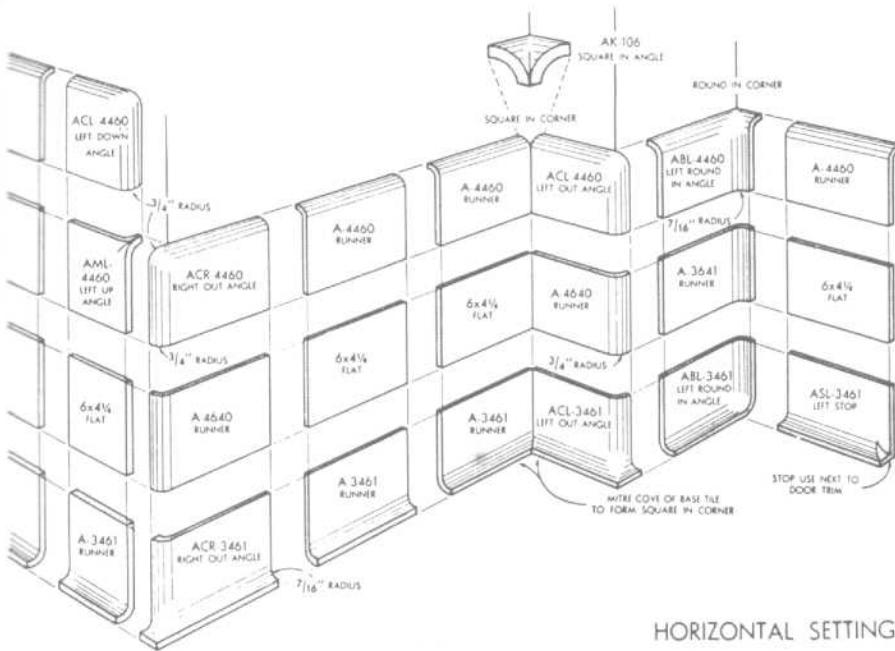
- interiors over gypsum board, plaster, dimensionally stable masonry, or other smooth surfaces

PARTITIONS AND WALL FINISHES

Ceramic Tile Wall Finishes



VERTICAL SETTING



HORIZONTAL SETTING

Fig. 15 Standard trim shapes and designs (6 by 3/4 in wall tile set in conventional mortar bed).

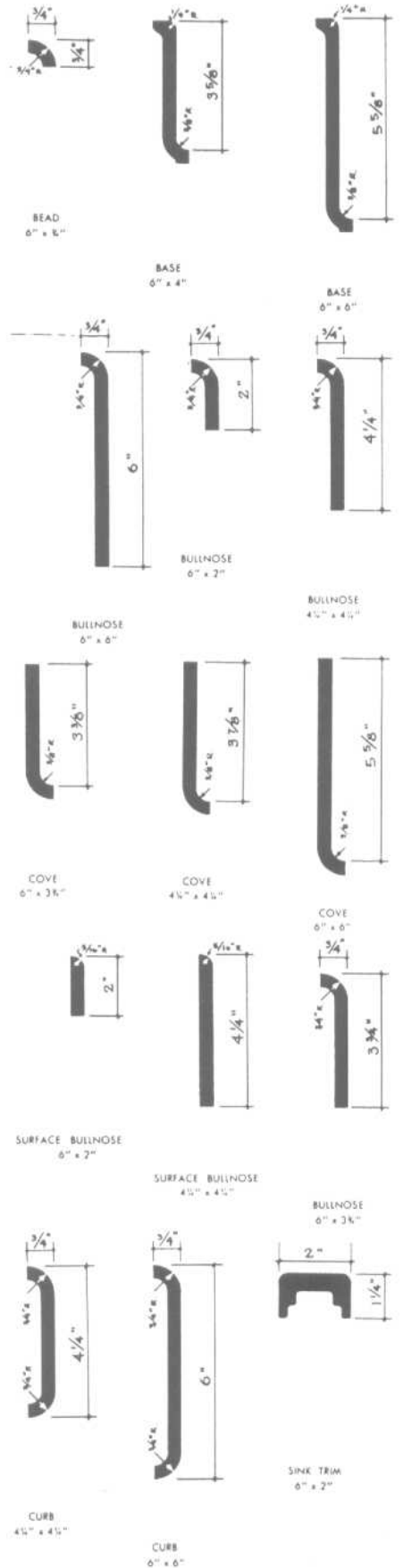


Fig. 16 Standard trim shapes and sizes.



PARTITIONS AND WALL FINISHES

Marble Veneer Wall Finishes

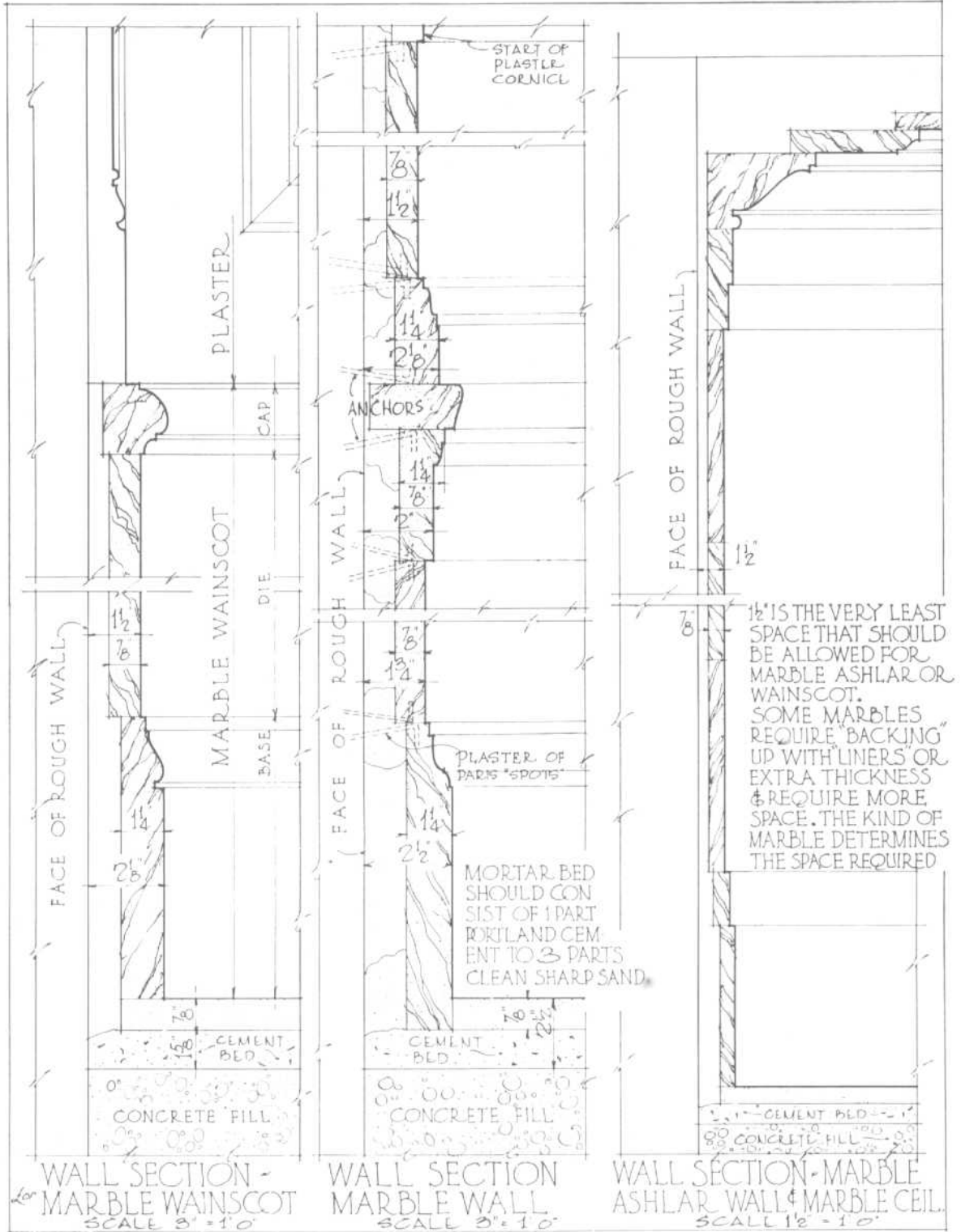


Fig. 17 Marble treatment for walls and wainscots.



PARTITIONS AND WALL FINISHES

Marble Veneer Wall and Ceiling Finishes

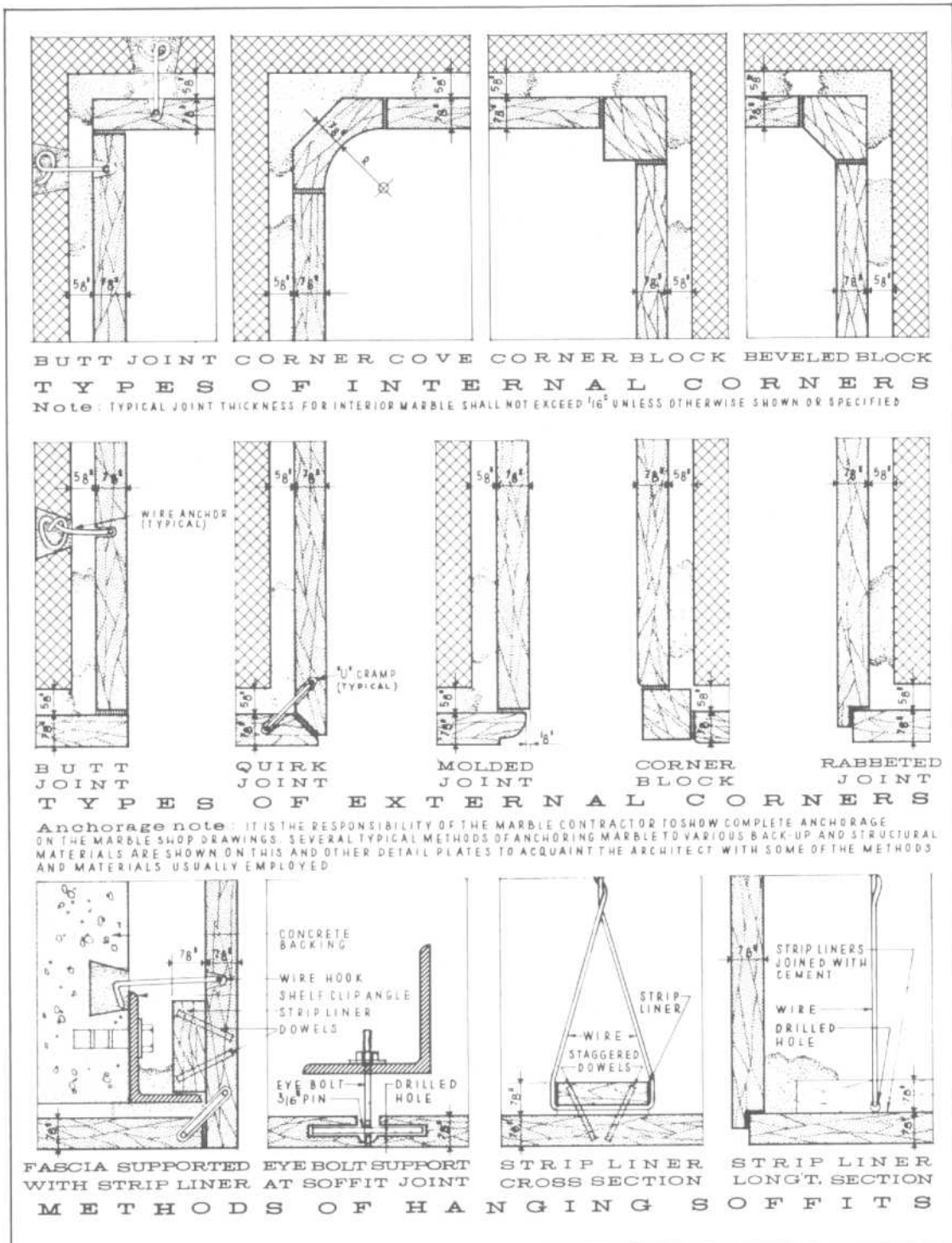
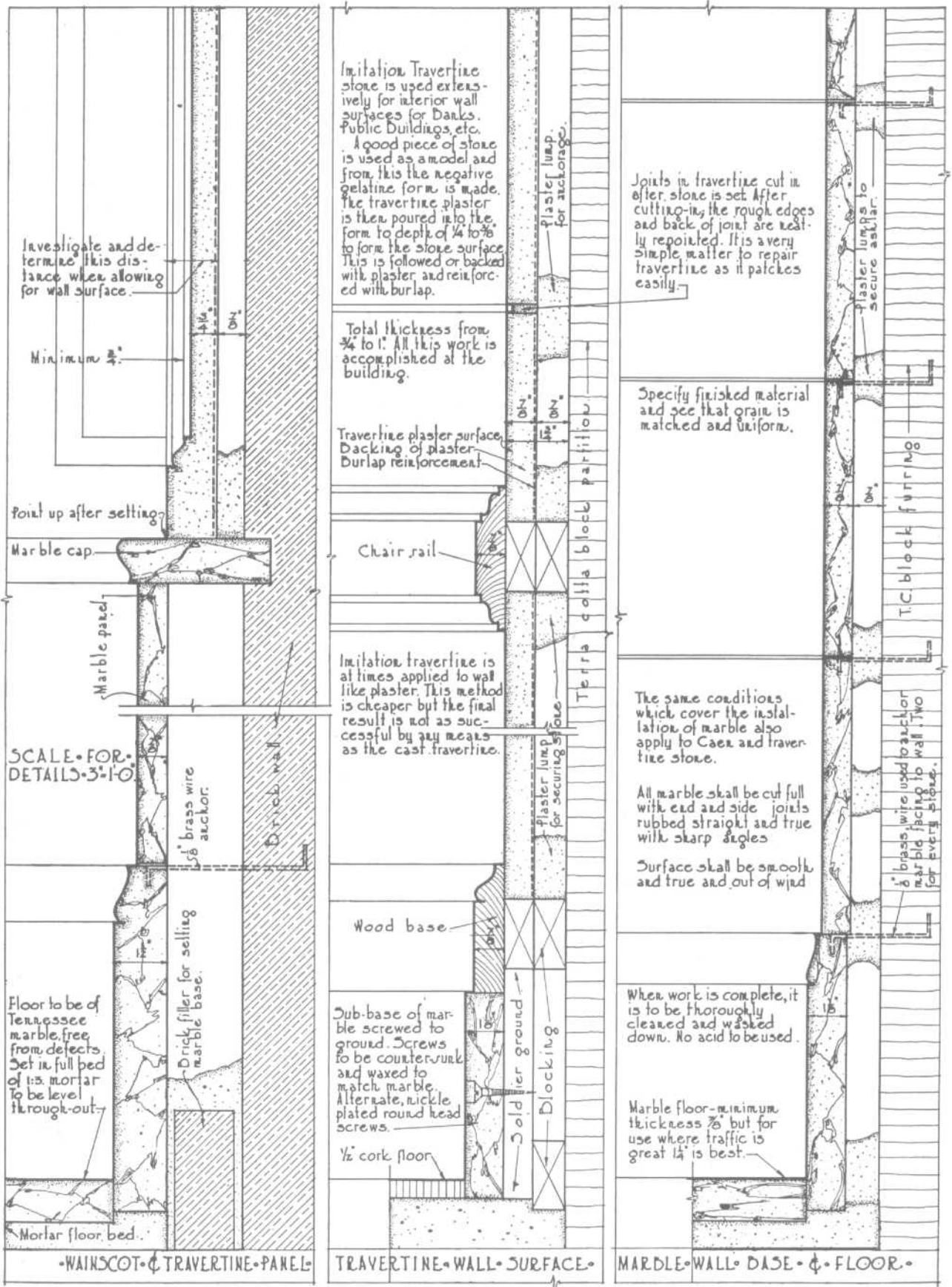


Fig. 18 Anchorage details.

PARTITIONS AND WALL FINISHES

Marble and Travertine Veneer Wall Finishes



PARTITIONS AND WALL FINISHES

Slate Panel Veneer

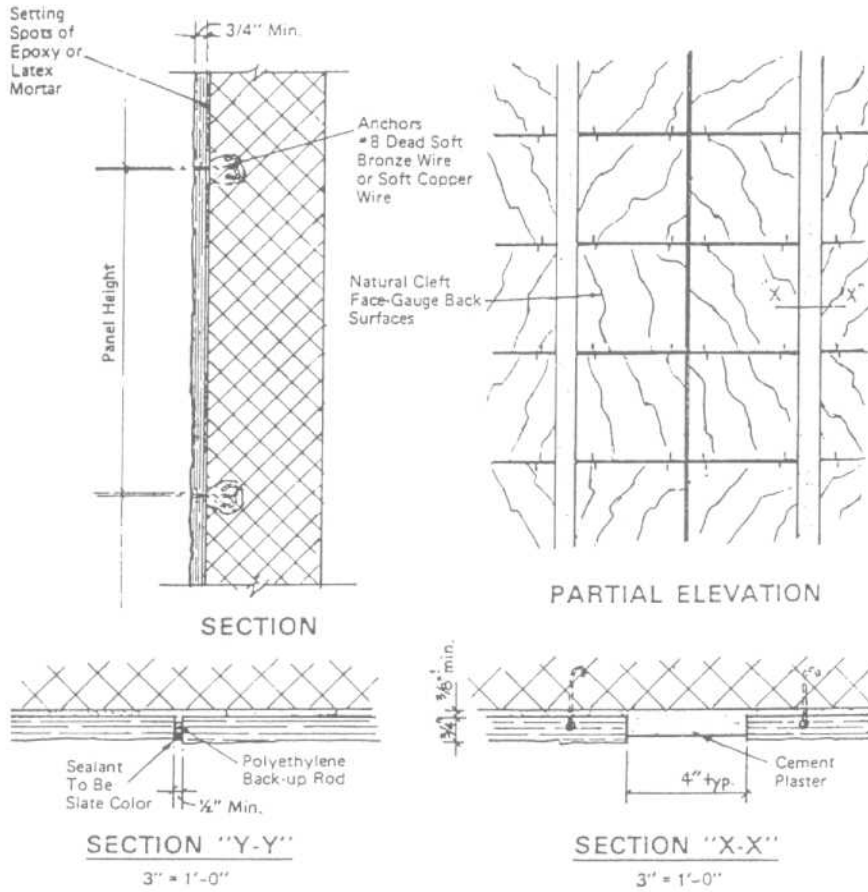


Fig. 19 Slate panel veneer.

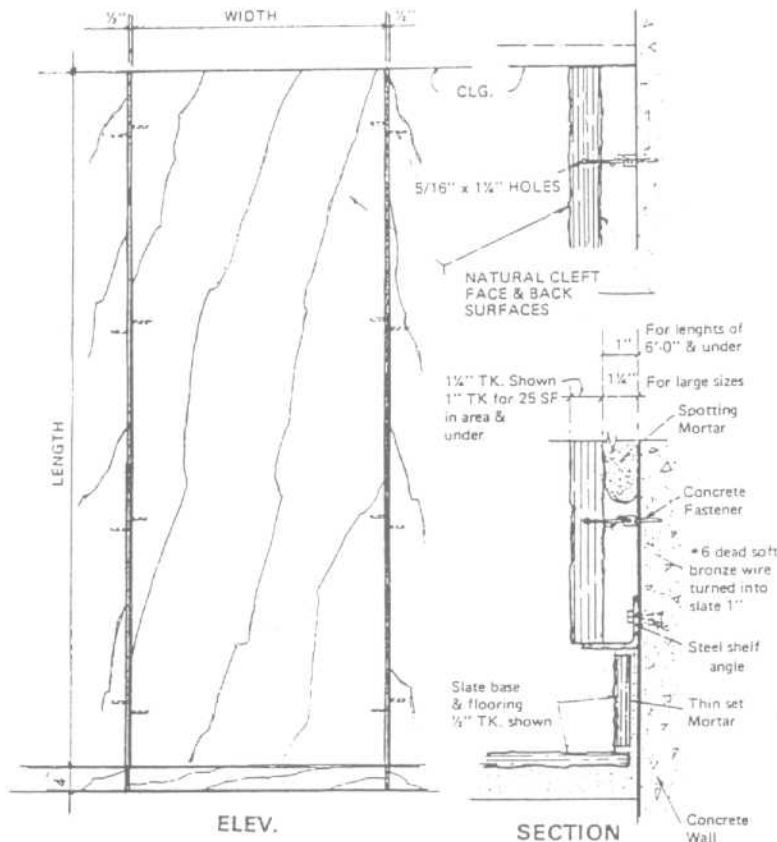
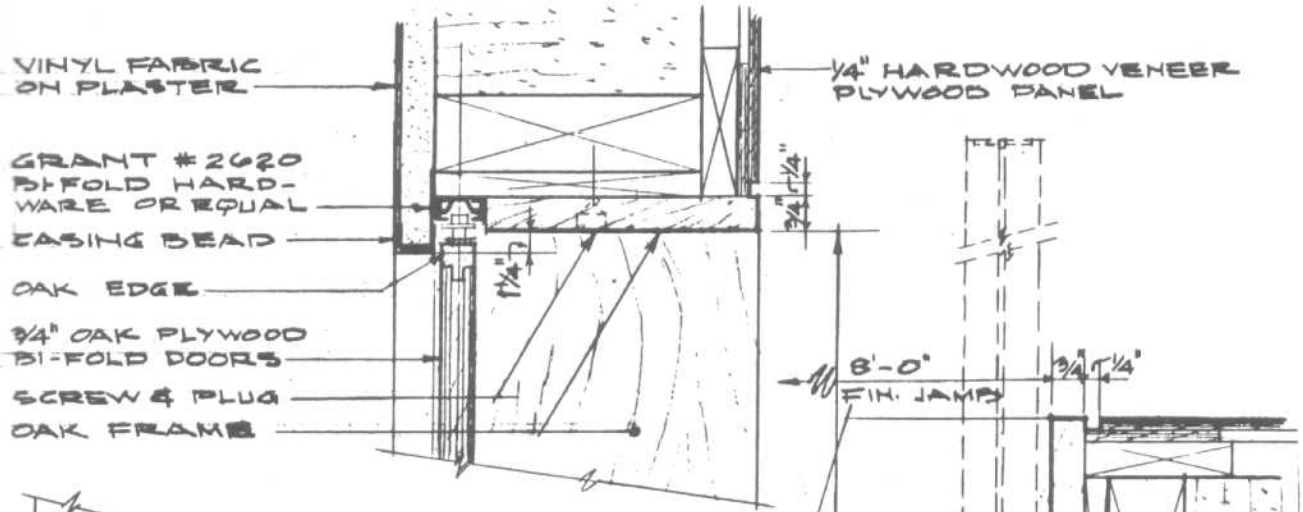


Fig. 20 Slate panels applied to concrete wall.

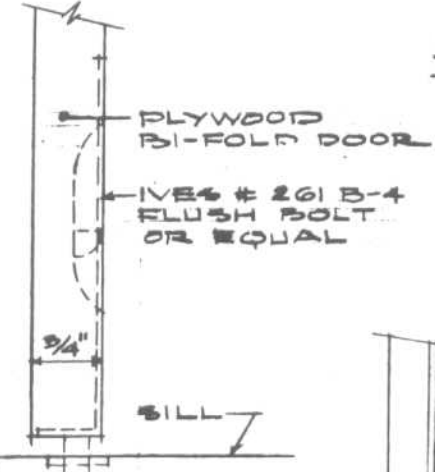


PARTITIONS AND WALL FINISHES

Bi-Fold Door Details

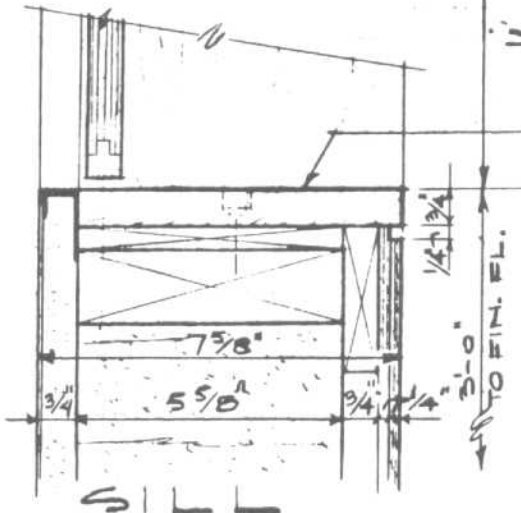


HEAD



FLUSH BOLT  
DETAIL  
@ 1/2 FULL SIZE

CHAPEL



SILL

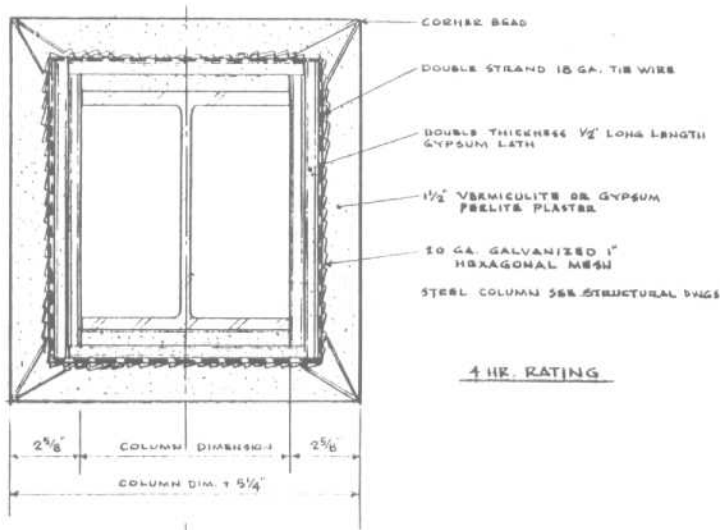
OAK SILL  
NOTE:  
BI-FOLD DOOR SHALL  
BE PAINTED (ON CHAPEL  
SIDE ONLY) TO MATCH  
COLOR OF VINYL FABRIC

FAMILY ALCOVE

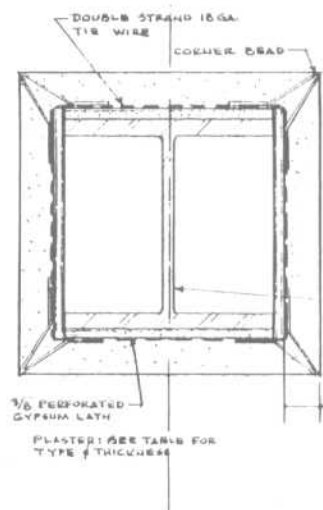
30 BI-FOLD DOOR DETAILS  
@ 3/8" = 1'-0"

**PARTITIONS AND WALL FINISHES**

Column Fireproofing Details



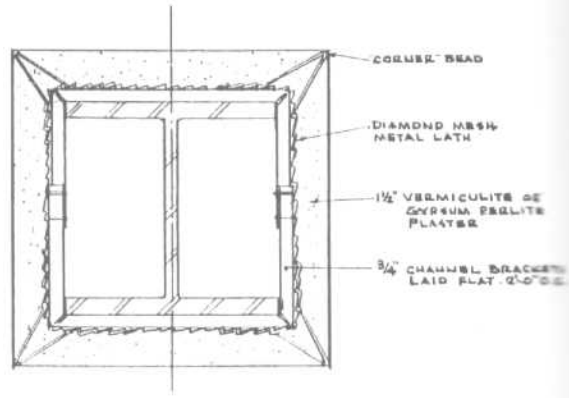
4 HR. RATING



GYPHUM LATH & PLASTER FIREPROOFING

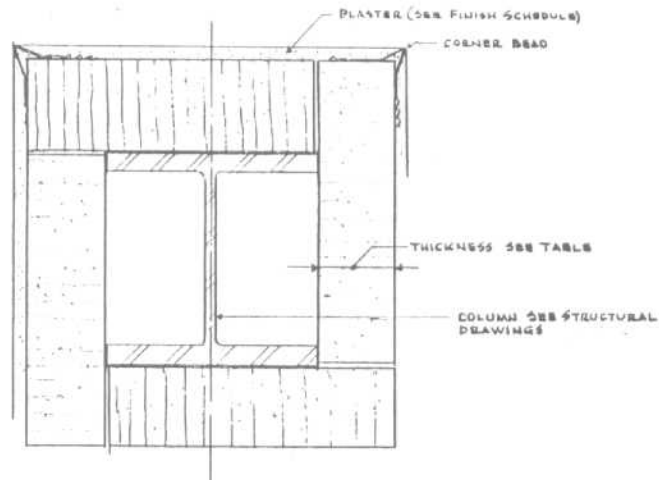
**PLASTER THICKNESS & TYPE**

RATING	THICK.	TYPE
3HR	1 3/8"	VERMICULITE OR GYPSUM PERLITE
3HR	2"	GYPSUM SAND
2HR	1 1/8"	↓
1HR	1/2"	



4 HR. RATING

METAL LATH & PLASTER FIREPROOFING



MATERIAL	THICKNESS TO OBTAIN			
	1 HR	2 HR	3 HR	4 HR
BRICK (BURNED CLAY OR SHALE)	2 1/4"	2 1/4"	3 1/4"	3 3/4"
BRICK (SAND LIME)	2 1/4"	2 1/4"	3 1/4"	3 3/4"
CONCRETE BLOCK, BRICK, OR TILE EXCEPT CINDER CONCRETE UNITS	2 1/4"	2 1/4"	3 1/4"	3 1/4"
HOLLOW CINDER OR CONCRETE BLOCK & TILE HAVING A COMPRESSIVE STRENGTH OF AT LEAST 700#/SQIN. OF GROSS AREA	1 1/2"	2"	2"	2 1/2"
SOLID GYPSUM BLOCK PROVIDED THAT TO OBTAIN 4-HR RATING, BLOCKS SHALL BE PLASTERED WITH AT LEAST 1/2" GYPSUM PLASTER	1"	1 1/2"	2"	2"
HOLLOW OR SOLID BURNED CLAY TILE OR COMBINATION OF TILE & CONCRETE	1 1/2"	2"	2"	2 1/2"
HOLLOW GYPSUM BLOCK, PROVIDED THAT TO OBTAIN A 4-HR RATING, BLOCKS SHALL BE PLASTERED WITH AT LEAST 1/2" GYPSUM PLASTER	3"	3"	5"	5"

MASONRY FIREPROOFING



## FLOORS AND FLOOR FINISHES

The designer must be familiar with the great variety of floor types, finishes, and patterns in order to specify and detail architectural flooring properly. While some examples of “soft finishes” such as carpeting and resilient flooring are shown, this section explores in depth the installation and detailing of “hard” or architectural finishes.

It is important for the designer to research the various characteristics of the floor finish being specified. While aesthetics and color are obviously important considerations, the designer must also analyze other factors. Among these factors are wear resistance and durability, soil resistance, maintenance, resiliency, flammability, costs of installation, and life cycle cost. Once these factors have been analyzed, the final specification and detailing of the architectural finish must be developed.

Examples of standard patterns are provided, but the designer must become familiar with the infinite number of pattern possibilities. The inherent limitations of materials control their sizes and thicknesses. The patterns of certain materials are dictated by both the thickness of the material and the weight or “dead load” of the material superimposed upon the structure. For example, a large pattern of marble or granite will necessitate a slab of material that will weigh much more per square foot than that of a smaller pattern. This greater weight might have structural consequences, as well as make floor transitions more significant.

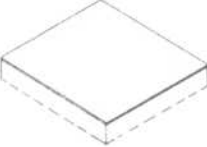

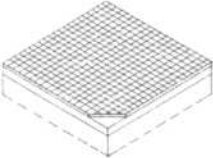
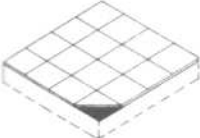

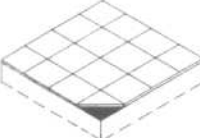
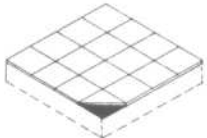
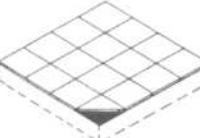
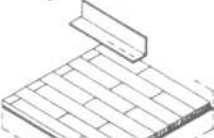
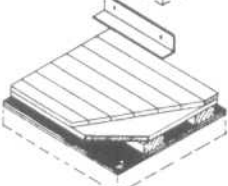
Transitions between flooring materials, particularly under doors or at entrances, and transitions between flooring and walls are some of the key material interfaces that have to be detailed. Again, this section provides such information using both traditional and contemporary approaches.

Finally, a portion of this section is devoted to the detailing of raised computer room floors. While not traditionally a floor finish, raised computer room floors seem appropriate for this section. While generic architectural details are provided, the designer should always develop final details in conjunction with the manufacturer(s) being specified.



## FLOORS AND FLOOR FINISHES

## Typical Characteristics of Floor Finishes

DRAWING AND DESCRIPTION	WEAR RESISTANCE	SOIL RESISTANCE, CLEANING AND MAINTENANCE	RESILIENCY	REMARKS	COST COMPARISON
	1/8 inch hardened cement finish on concrete slab Good	Poor; frequent cleaning needed; must be refinished every ten years	Very hard	Cement base costs little, is too hard a floor to be comfortable; infrequently used in classrooms, sometimes used in corridors, shops and inexpensive toilet rooms	installation cost  maintenance and insurance cost for 20 years
	3/4 inch terrazzo finish, with 3/4 inch cement underbed on a concrete slab Very good	Very good; needs cleaning once a week with detergent and water	Very hard	Terrazzo base is easy to clean and sanitary, but not resilient and sometimes noisy; seldom used in classrooms, often used in corridors, vestibules, toilets and shower rooms	
	Ceramic mosaic tile, 3/4 inch setting bed on concrete slab Very good	Very good	Very hard	Used in toilet rooms, showers, food service areas, but seldom used in classrooms	
	1/8 inch asphalt tile finish installed in mastic on concrete slab Poor, usually needs replacing every ten years	Fair; must be cleaned and waxed once a week	Fair	Low first cost; finish requires careful maintenance	
	1/8 inch linoleum finish installed in mastic on concrete slab Good	Fair; must be cleaned and waxed once a week	Fair	Serviceable; a sanitary floor for classrooms, corridors, assembly and administration rooms	
	1/8 inch cork tile floor installed in mastic on concrete slab Good	Fair; needs frequent cleaning and waxing	Very good	Used primarily in libraries and kindergartens; floor is subject to indentations by chair legs; acoustically good	
	1/8 inch rubber tile finish installed in mastic on concrete slab Good	Fair; needs cleaning and waxing once a week	Very good	Subject to slight indentation by chair legs	
	1/8 inch vinyl tile finish installed in mastic on concrete slab Good	Fair; needs a weekly cleaning and waxing	Very good	Subject to indentation	
	25/32 inch maple strip flooring set in 1/8 inch hot asphalt mastic on concrete slab Very good	Good; requires monthly cleaning with steelwool and a wax finish	Fair	Steel angles necessary to cover expansion joint; used in gymnasiums and playrooms; not suitable for damp areas or climates	
	25/32 inch maple finish; 1 by 4 inch cypress sub-floor laid diagonally; 2 by 6 inch cypress sleepers, 12 inches apart, set in two 1/8 inch layers of hot asphalt mastic Very good	Good; requires a monthly cleaning with steelwool and a wax finish; sand and re-finish every 2 years	Excellent	A deluxe gymnasium floor	

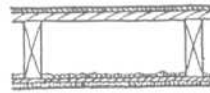
FLOORS AND FLOOR FINISHES

Floor Construction Details



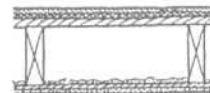
2" x 8" JOISTS - 16" O.C.,  
1/4" OAK FLOORING,  
SUB-FLOOR, METAL LATH,  
1/2" GYPSUM PLASTER

F-1



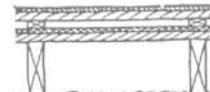
3/8" HARD WOOD FLOOR,  
SUB-FLOOR,  
2" x 6" WOOD JOISTS,  
WOOD LATH,  
1/2" PLASTER

F-2



SAME AS F-2,  
EXCEPT 1/2" FIBERBOARD  
BETWEEN ROUGH &  
FINISH FLOOR

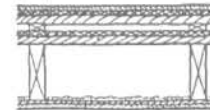
F-3



3/8" HARDWOOD FLOOR, SUB-FLOOR,  
3/4" x 2" NAILING STRIPS (SEE NOTE)  
1/2" FIBERBOARD, SUB-FLOOR,  
2" x 6" WOOD JOISTS,  
WOOD LATH, 1/2" PLASTER.

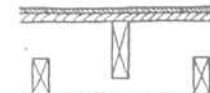
NOTE - ROUGH & FINISH FLOOR NAILED TO NAILERS; NAILERS NOT NAILED THROUGH FIBERBOARD; MERELY RESTING THEREON.

F-4



SAME AS F-4,  
EXCEPT 1/2" FIBERBOARD  
BETWEEN ROUGH &  
FINISH FLOOR

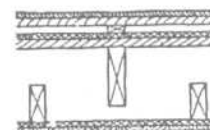
F-5



1/8" HARD WOOD FLOOR,  
SUB-FLOOR,  
2" x 6" WOOD JOISTS - 16" O.C.  
SUSPENDED CEILING -  
2" x 4" JOISTS - 16" O.C.  
1/2" FIBERBOARD, 1/2" PLASTER

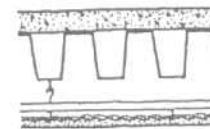
NOTE - COMMON END SUPPORT FOR BOTH JOIST SYSTEMS; NO INTERMEDIATE CONNECTIONS BETWEEN 2x6s & 2x4s.

F-6



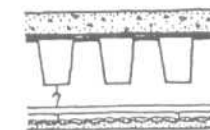
SAME AS F-6,  
EXCEPT 1/2" FIBERBOARD  
ON PRIMARY SUB-FLOOR.  
3/4" x 2" NAILERS (SEE NOTE WITH F-4)  
PLUS ROUGH & FINISH FLOOR.

F-7



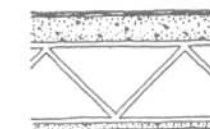
2" CONCRETE FILL,  
STEEL FLOOR SECTION,  
SUSPENDED METAL LATH,  
1/2" PLASTER

F-8



SAME AS F-8, EXCEPT  
1/2" EMULSIFIED ASPHALT  
APPLIED BEFORE  
2" CONCRETE FILL.

F-9



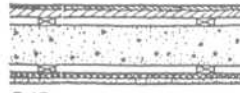
BATTLESHIP LINOLEUM,  
2 1/2" CONCRETE FILL ON  
HIGH-RIB METAL LATH,  
8" MAC-MAR JOISTS,  
HIGH-RIB METAL LATH,  
3 COATS GYPSUM PLASTER

F-10



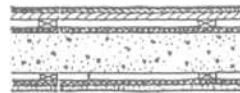
4" REINF CONCRETE SLAB,  
3/4" x 2" FURRING,  
1/2" FIBERBOARD LATH,  
1/2" GYPSUM PLASTER

F-11



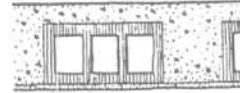
SAME AS F-11,  
EXCEPT 1/4" x 2" SLEEPERS  
PLUS ROUGH & FINISH  
FLOOR ADDED, TOP

F-12



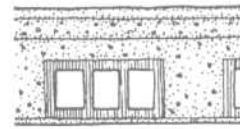
SAME AS F-12,  
EXCEPT 1/2" FIBERBOARD  
PLACED UNDER SLEEPERS

F-13



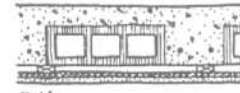
8" COMBINATION FLOOR,  
6" x 12" x 12" 3-CELL TILE,  
1/2" TWO-COAT  
GYPSUM PLASTER CEILING

F-14



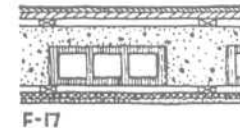
SAME AS F-14, EXCEPT  
2" CINDER CONCRETE FILL  
PLUS 1" CEMENT TOPPING  
ADDED FOR FLOOR

F-15



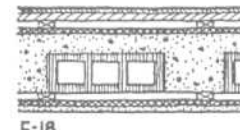
4" COMBINATION FLOOR,  
4" x 12" x 12" 3-CELL TILE,  
3/4" x 2" FURRING - 16" O.C.,  
1/2" FIBERBOARD LATH,  
1/2" GYPSUM PLASTER

F-16



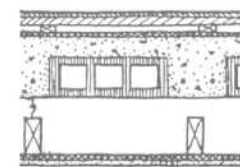
SAME AS F-16,  
EXCEPT 1/4" x 2" SLEEPERS  
PLUS ROUGH & FINISH  
FLOOR ADDED, TOP

F-17



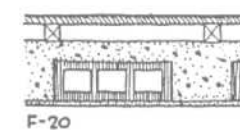
SAME AS F-17,  
EXCEPT 1/2" FIBERBOARD  
PLACED UNDER SLEEPERS

F-18



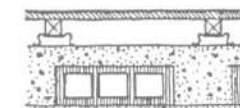
FINISH & ROUGH FLOOR  
ON 1/4" x 2" SLEEPERS - 16" O.C.,  
RESTING ON 1/2" FIBERBOARD,  
4" COMBINATION FLOOR,  
4" x 12" x 12" 3-CELL TILE,  
SUSPENDED 2" x 4" JOISTS,  
PLUS 1/2" FIBERBOARD LATH,  
1/2" GYPSUM PLASTER

F-19



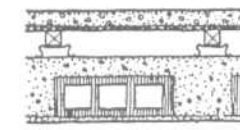
1 3/8" OAK FLOORING NAILED  
TO 2" x 2" SLEEPERS - 16" O.C.,  
SLEEPERS GROUTED ON 4"  
COMBINATION FLOOR (SIMI-  
LAR TO F-19), 1/2" TWO-COAT  
GYPSUM PLASTER CEILING

F-20



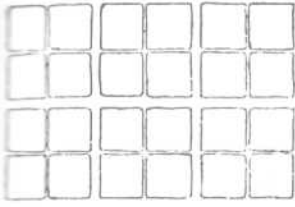
SAME AS F-20,  
EXCEPT 2" x 2" SLEEPERS  
CARRIED ON  
RESILIENT STEEL CLIPS

F-21

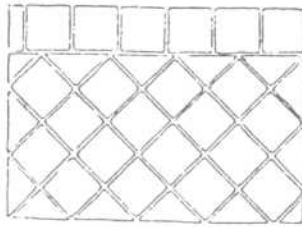


1 1/2" HYDROCAL ON  
1/2" GYPSUM PLASTERBOARD,  
2" x 2" SLEEPERS - 16" O.C.  
ON RESILIENT STEEL CLIPS,  
4" COMBINATION FLOOR  
(SIMILAR TO F-20) 1/2" TWO-  
COAT GYPSUM PLASTER CEILING

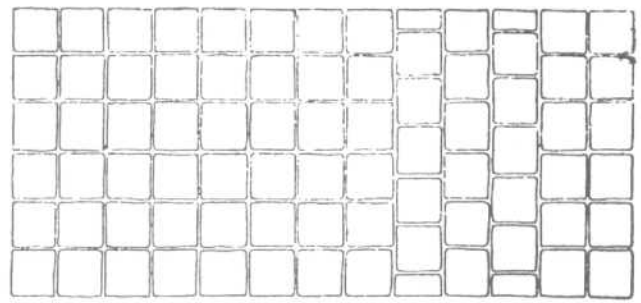
F-22



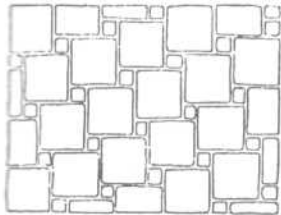
By groups of four squares as a unit separated by wider joints, the scale is increased.



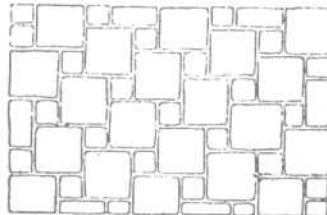
A diagonal pattern of square tiles is emphasized by a border.



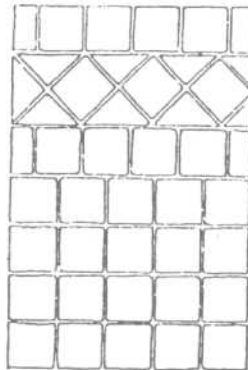
By a few rows of broken joints, an effect of border is produced in a field of square tiles.



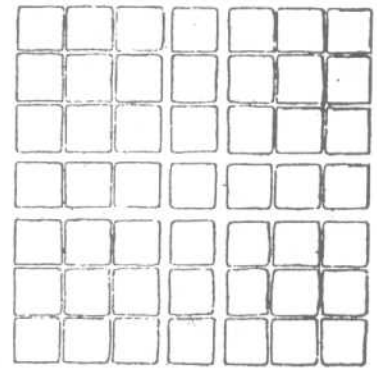
When the small squares are less than one-quarter of the area of the large squares, the pattern runs off at the side.



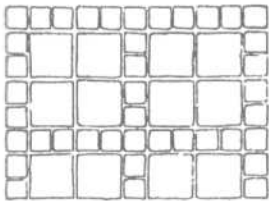
When the small squares are one quarter of the area of the large squares, the pattern has more repose.



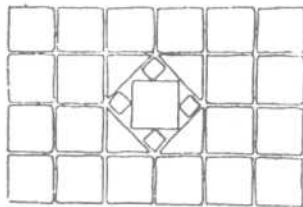
By breaking joints in one course, the border is made wide.



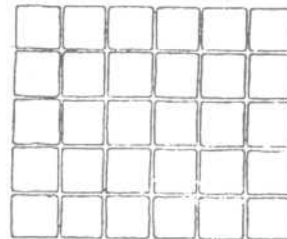
An arrangement adapted to large rooms.



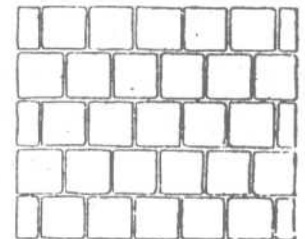
Another way to increase the scale with small tiles.



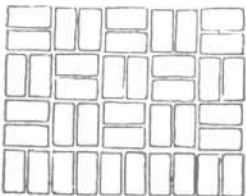
A decorative pattern that can be made on the job.



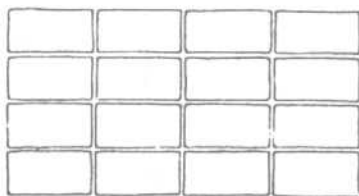
The simplest floor of square tiles is interesting if the joints are in scale.



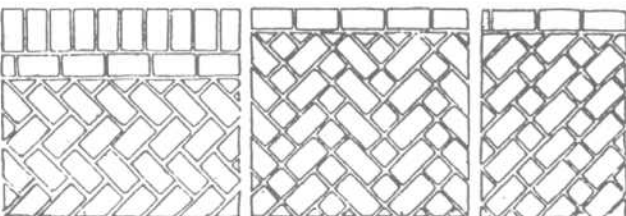
When square tiles are laid with broken joints, long lines in one direction are the result.



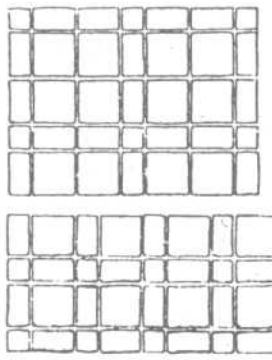
When double squares are laid "basket pattern," the necessary allowance for joints adds interest.



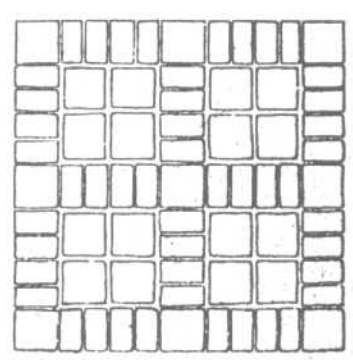
A good pattern for corridors.



Varieties of "herringbone."



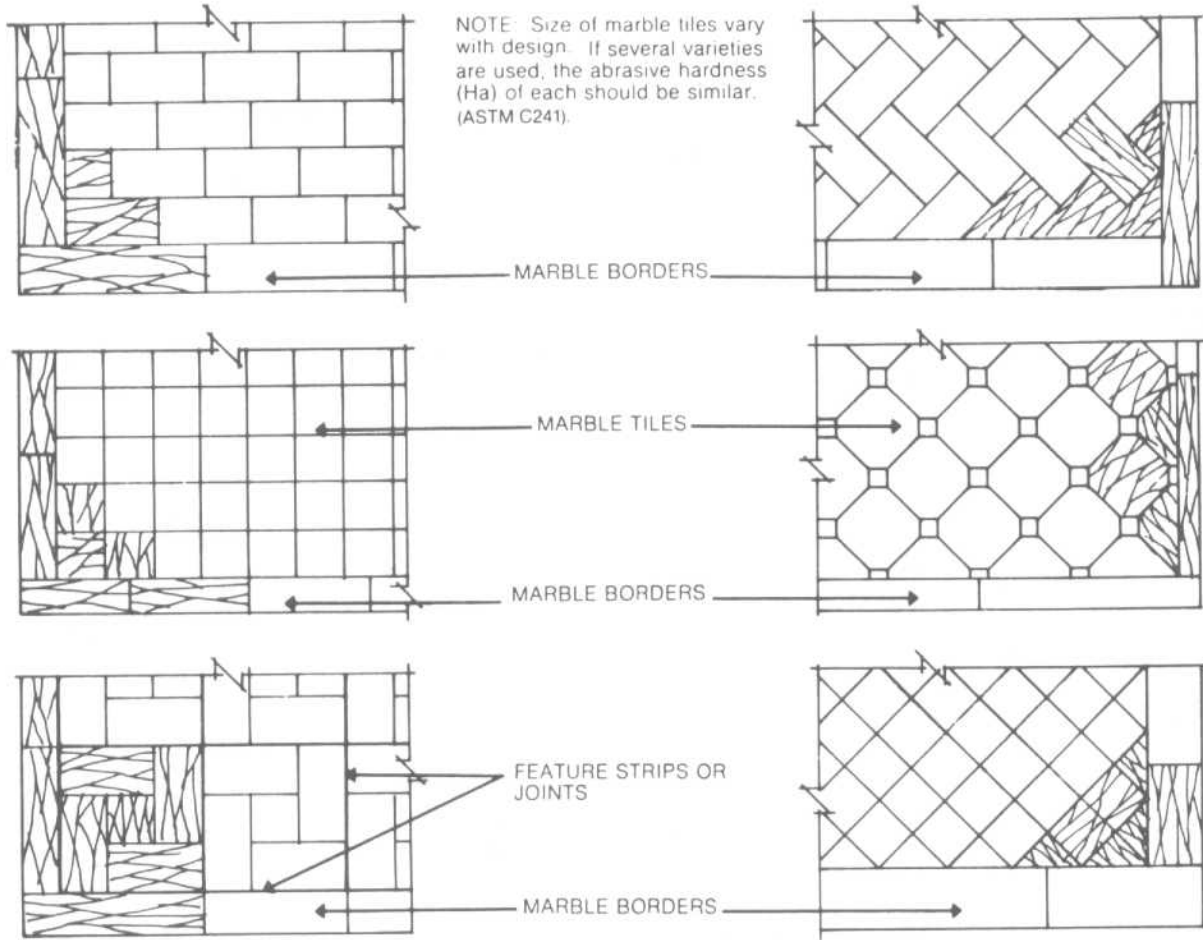
Two combinations suggesting plaids.



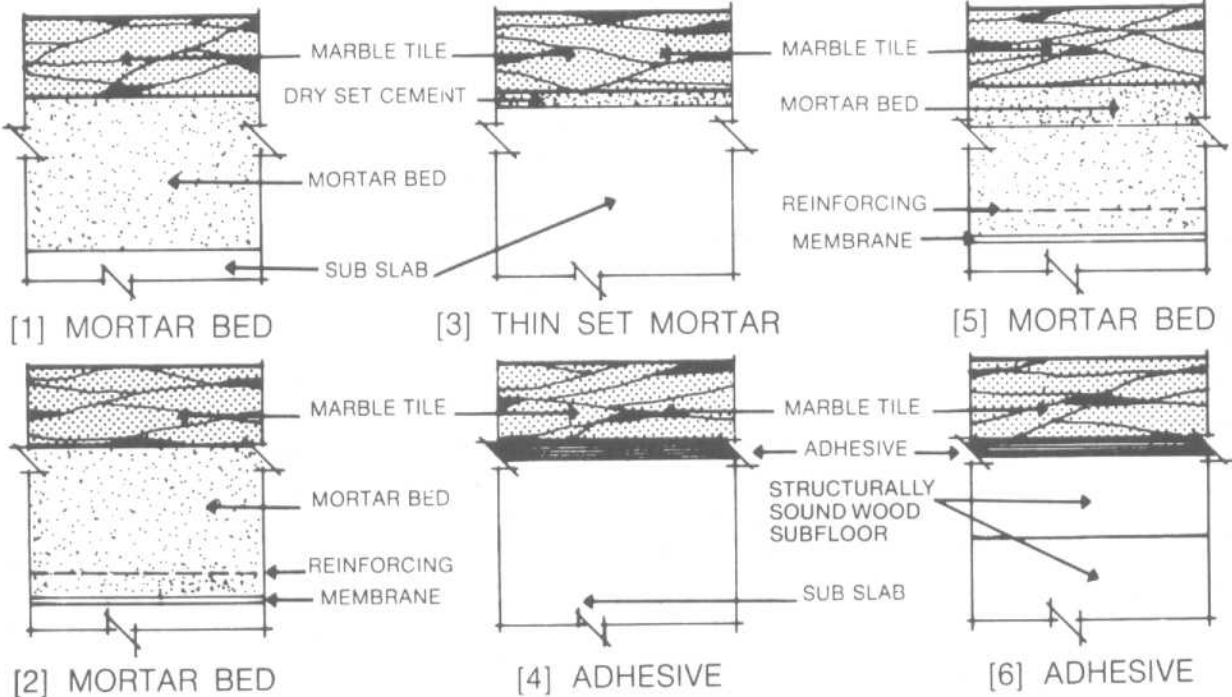
A simple device for a panel or a floor for a large room.

FLOORS AND FLOOR FINISHES

Marble Floor Patterns and Details



TYPICAL MARBLE FLOORING DESIGNS 3/8"=1'-0"



METHODS OF INSTALLATION HALF SIZE

Fig. 1 Marble flooring details.

FLOORS AND FLOOR FINISHES

Marble Floor Patterns and Details

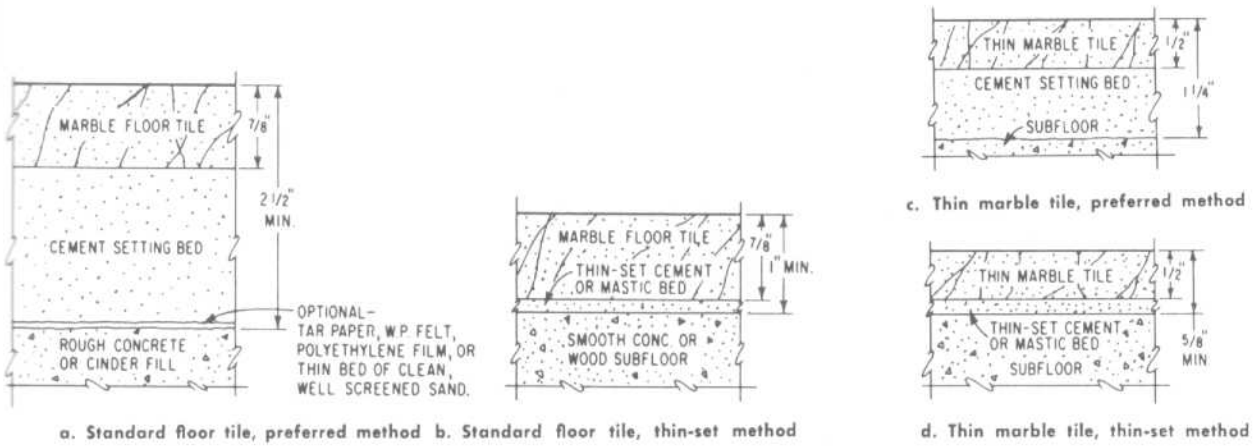


Fig. 2 Marble floor setting methods.

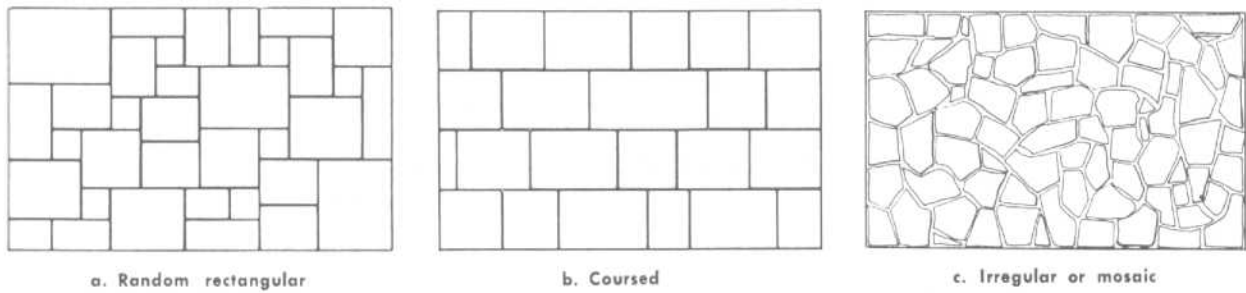
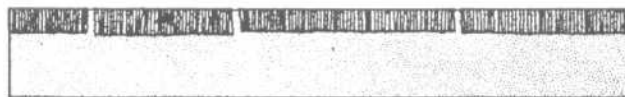
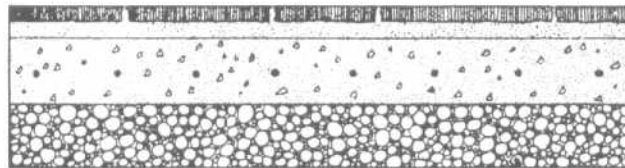


Fig. 3 Flagging patterns.



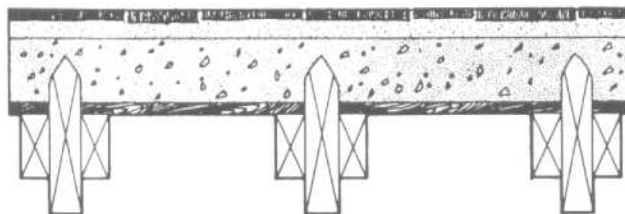
a. On sand bed

Flagging 1 to 1½ in.  
Sand bed 4 in.



b. On concrete slab on grade

Flagging ¾ to 1 in.  
Setting bed 1 to 1½ in.  
Reinforced concrete slab 4 in.  
Gravel or cinders 4 in.



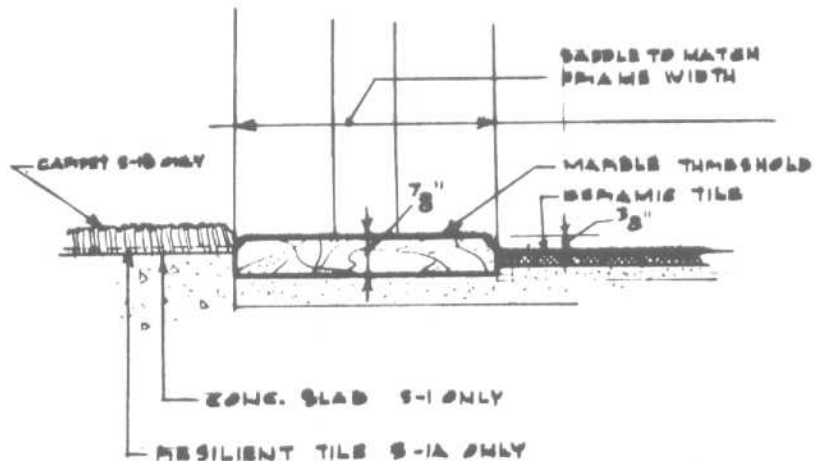
c. On wood joist construction

Flagging ¾ to 1 in.  
Setting bed 1 to 1½ in.  
Reinforced concrete slab 4 in.  
Wood subfloor ¾ in.

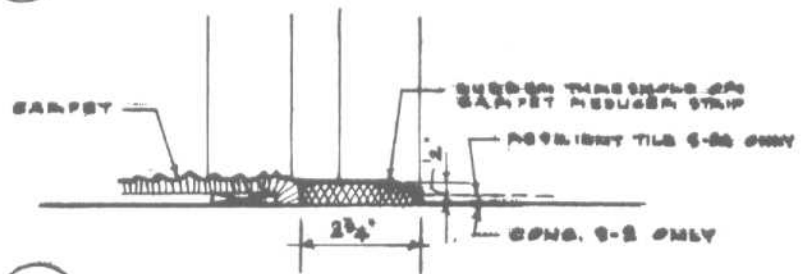
Fig. 4 Flagstone setting methods.

FLOORS AND FLOOR FINISHES

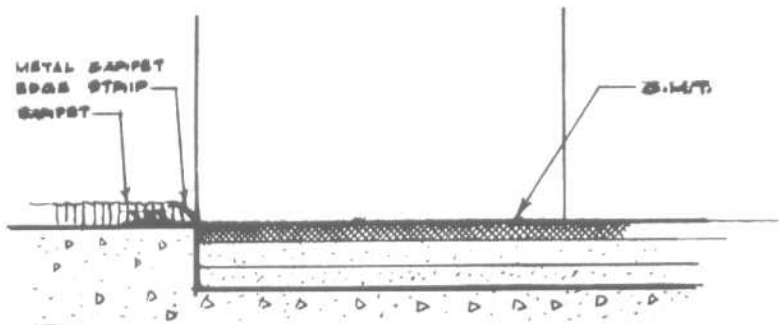
Saddles/Floor Transitions



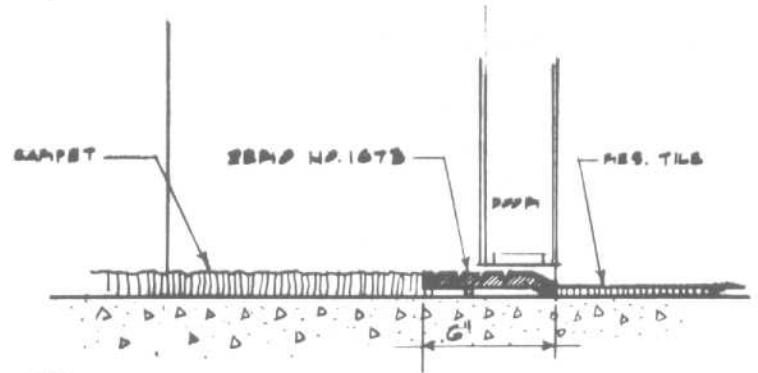
**S-1** CONG. FLOOR @ 3" x 1 1/2"



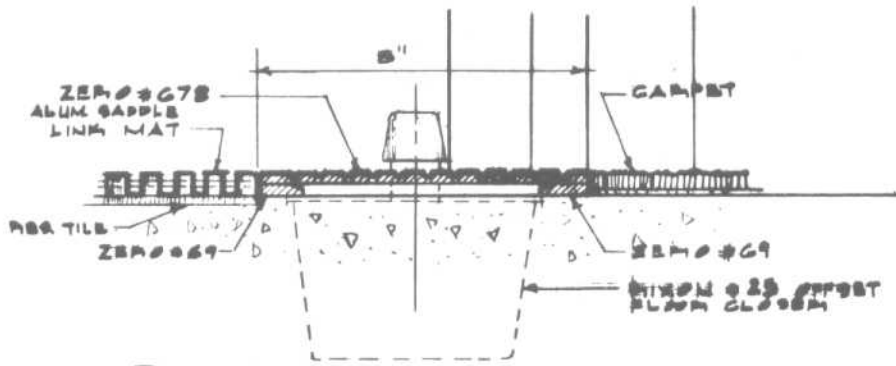
**S-2** CONG. @ 3" x 1 1/2"



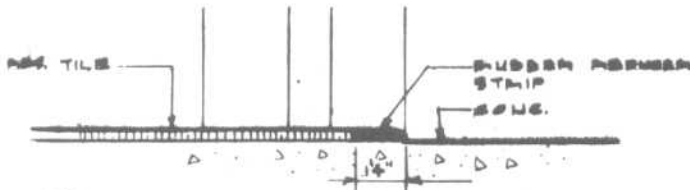
**S-13** @ 3" x 1 1/2"



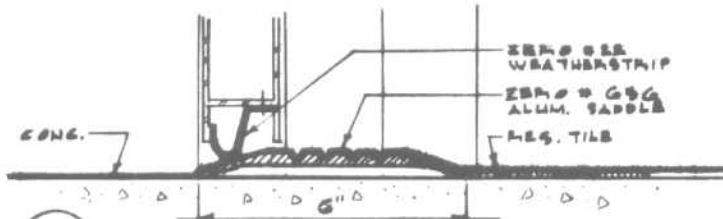
**S-14** @ 3" x 1 1/2"



S-4 @ 3" = 1'-0" NOTE: SEE DETAILS IN THIS SHEET

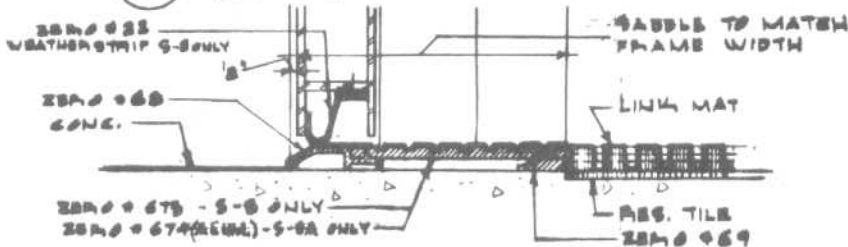


S-6 @ 3" = 1'-0"



S-7 RES. TILE @ 3" = 1'-0"

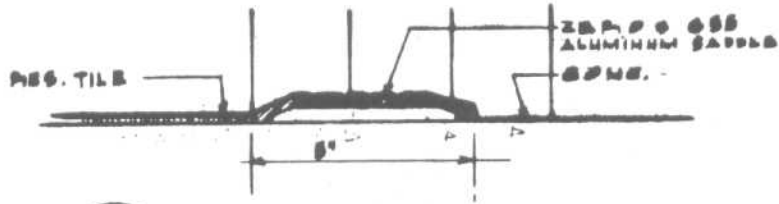
S-7A CONC. ON QUARRY TILE @ 3" = 1'-0"



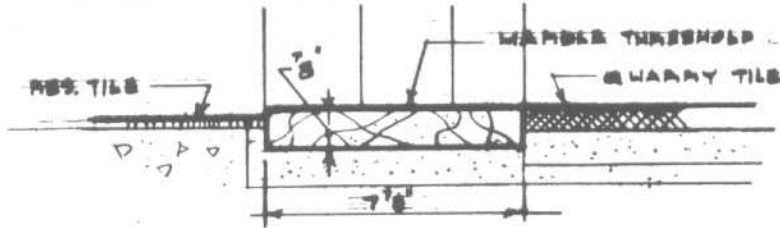
S-8 @ 3" = 1'-0"

FLOORS AND FLOOR FINISHES

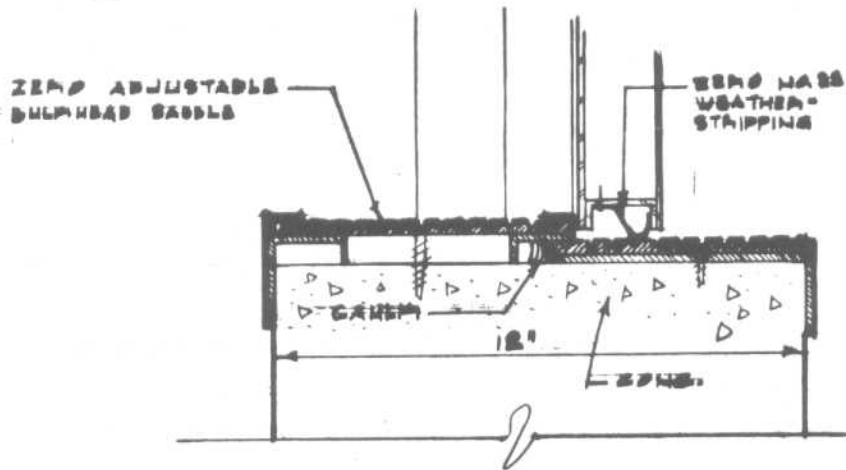
Saddles/Floor Transitions



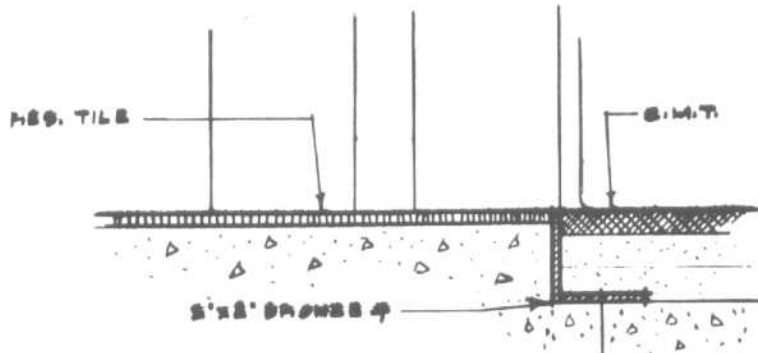
S-9 @ 3" = 1'-0"



S-10 @ 3" = 1'-0"

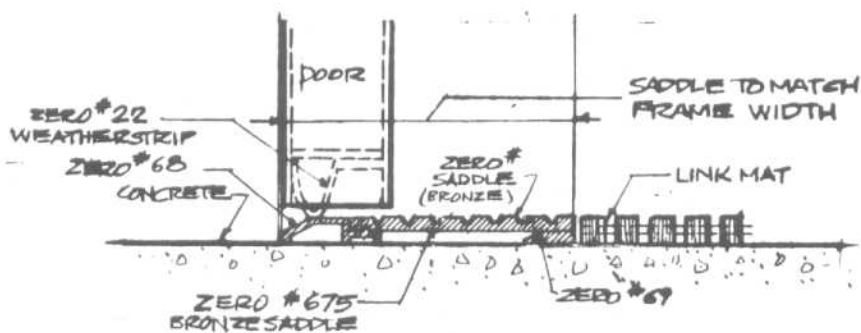


S-11 @ 3" = 1'-0"

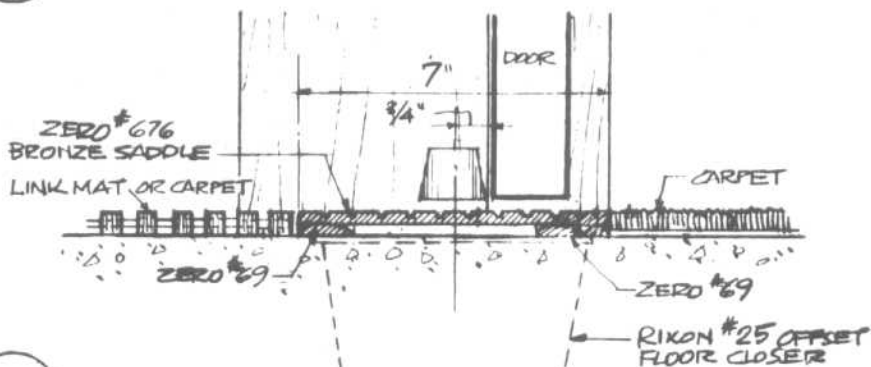


S-12 @ 3" = 1'-0"

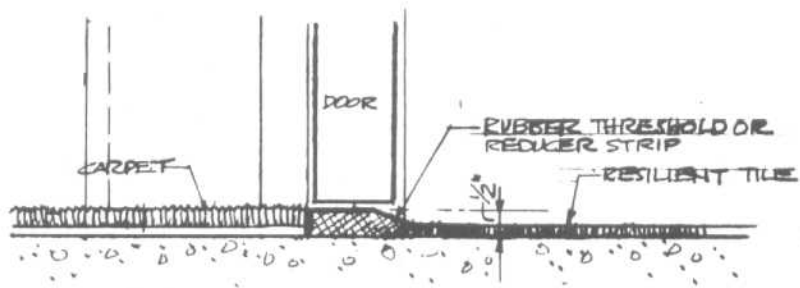




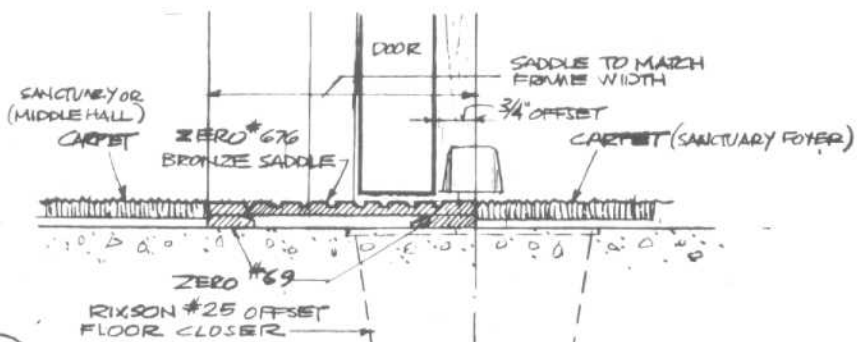
S-1 3"=1'-0"



S-2 3"=1'-0"



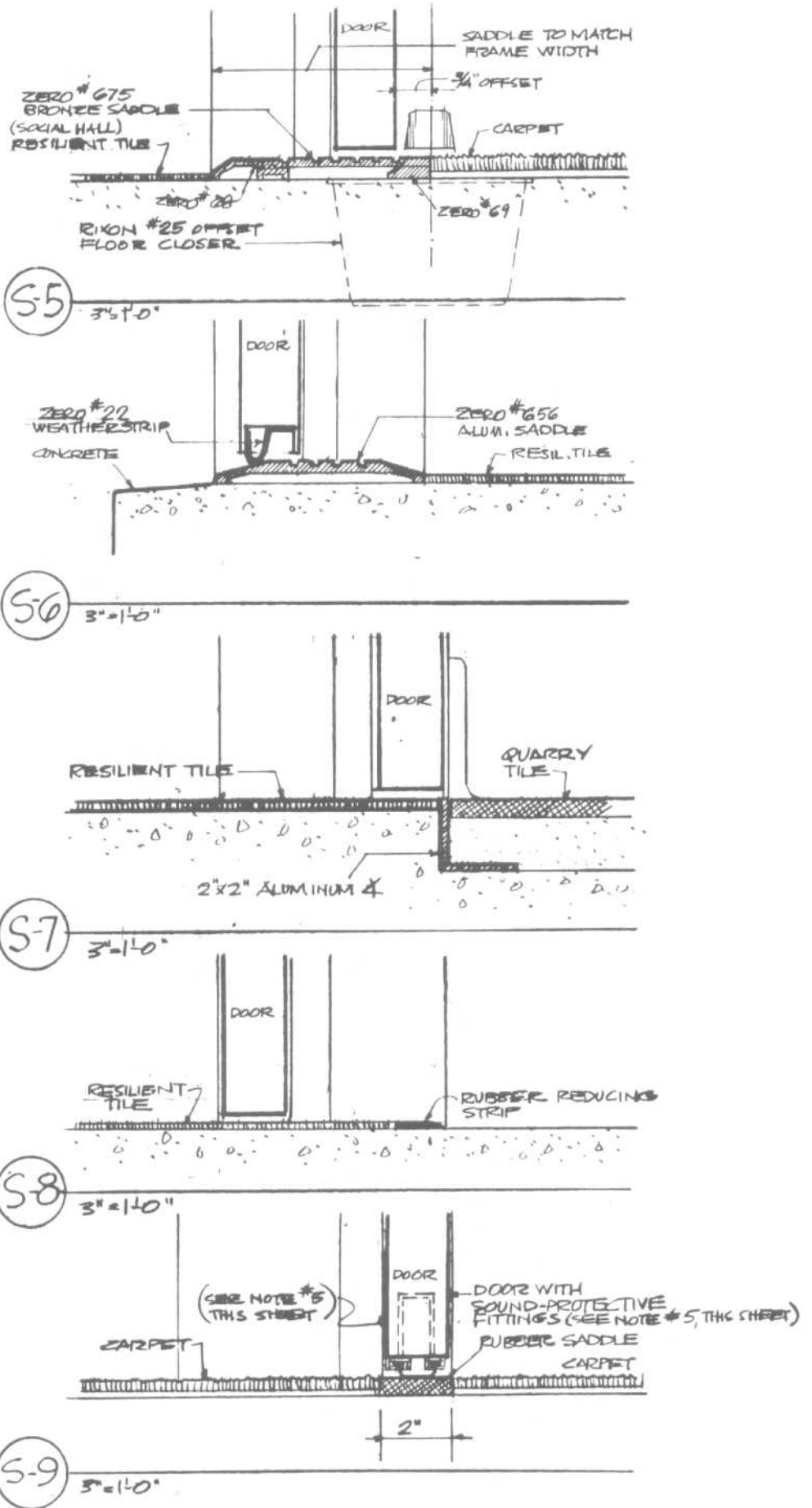
S-3 3/4"=1'-0"



S-4 3"=1'-0"

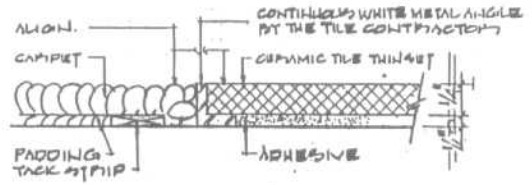
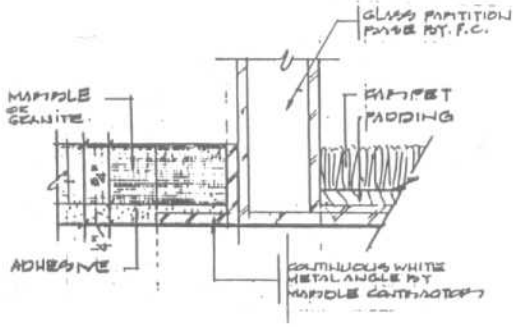
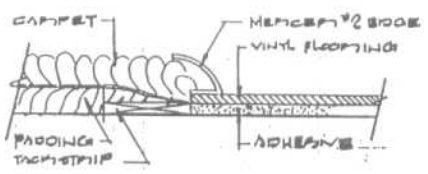
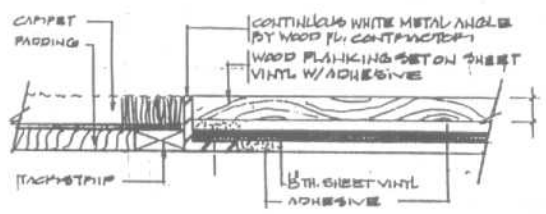
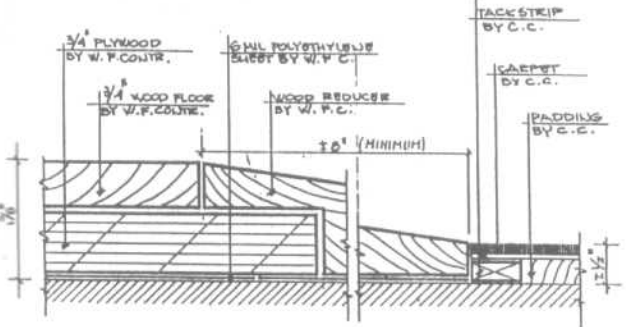
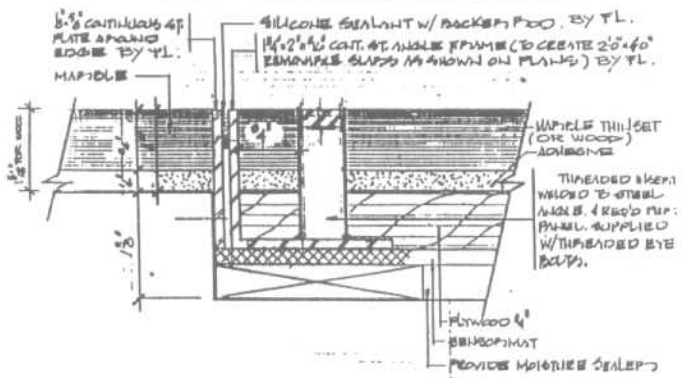
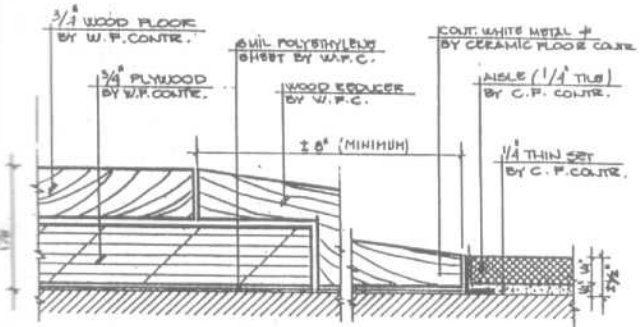
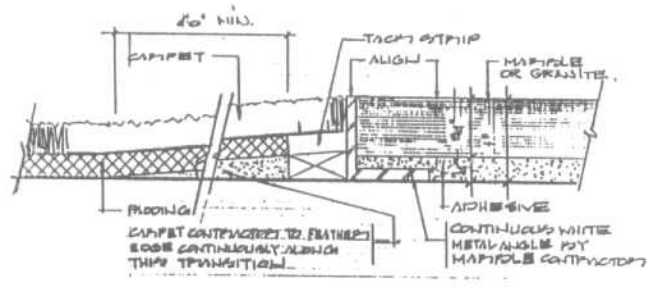
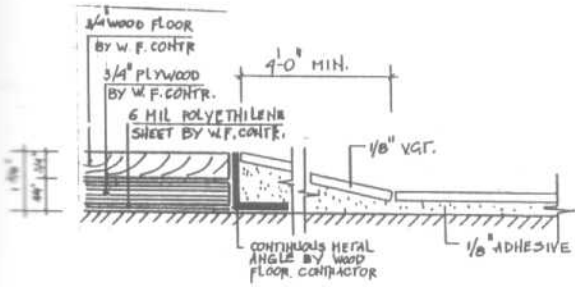
FLOORS AND FLOOR FINISHES

Door Saddles



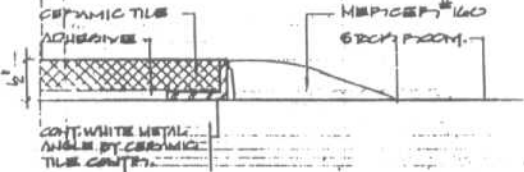
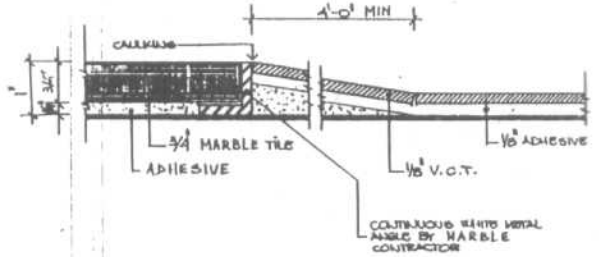
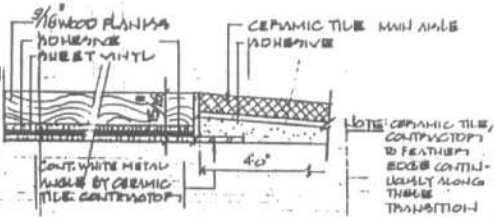
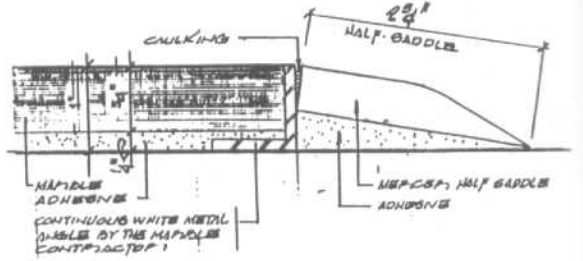
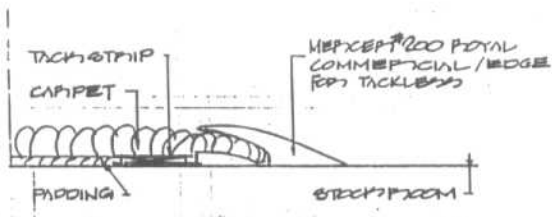
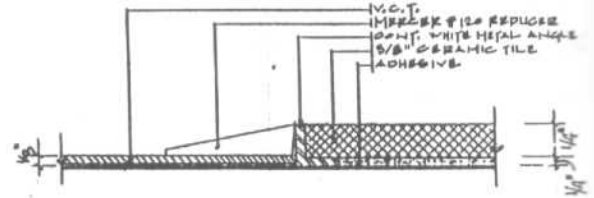
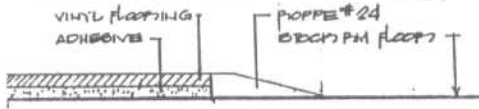
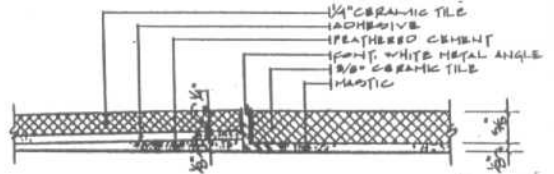
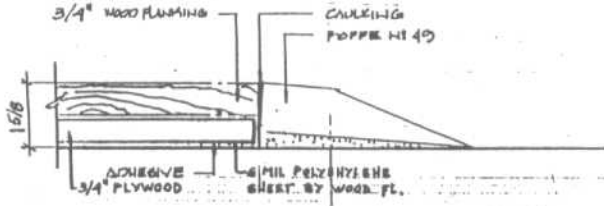
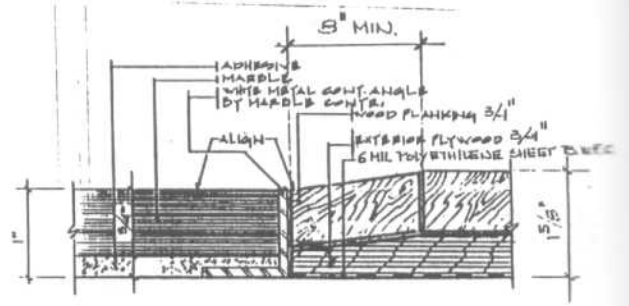
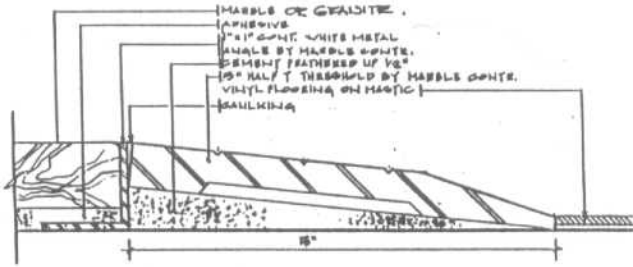
FLOORS AND FLOOR FINISHES

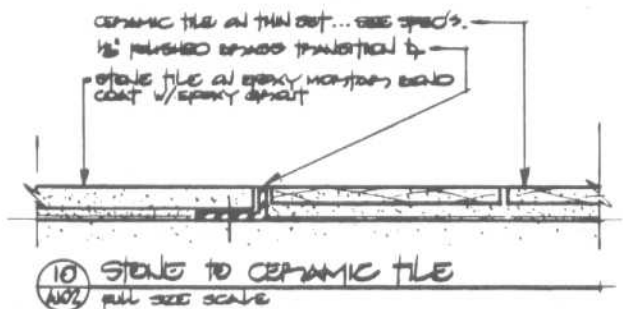
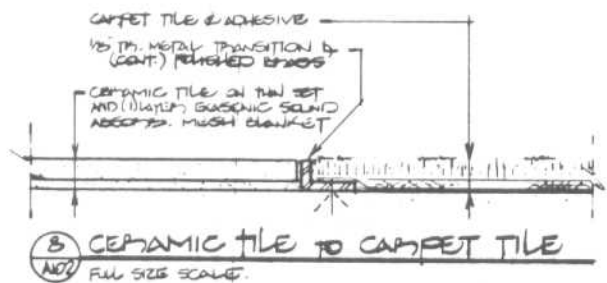
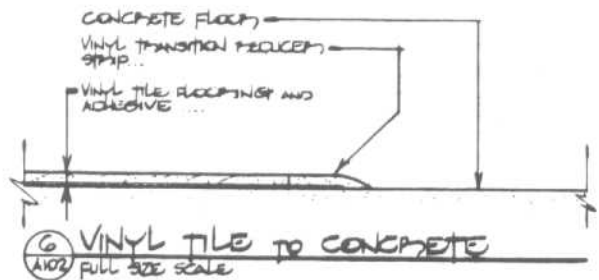
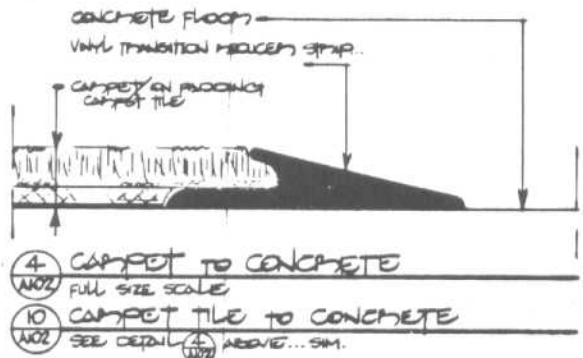
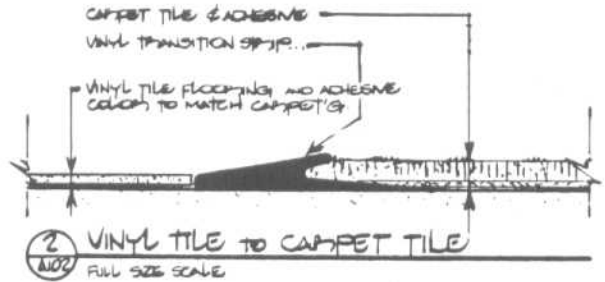
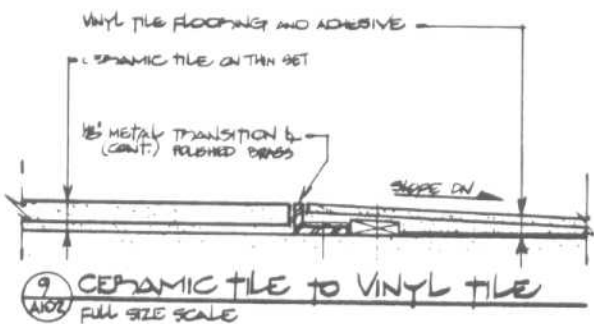
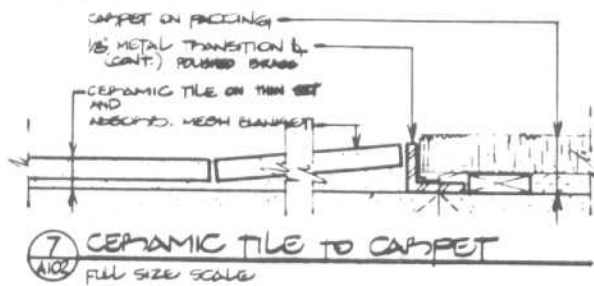
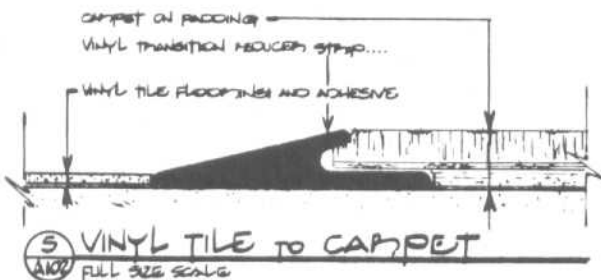
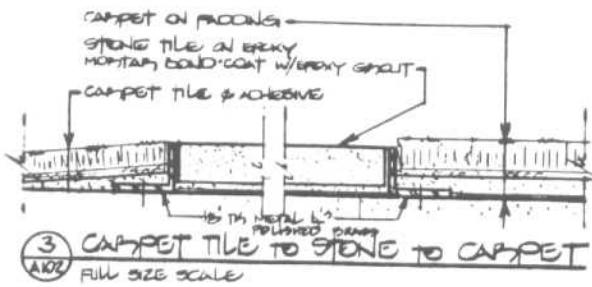
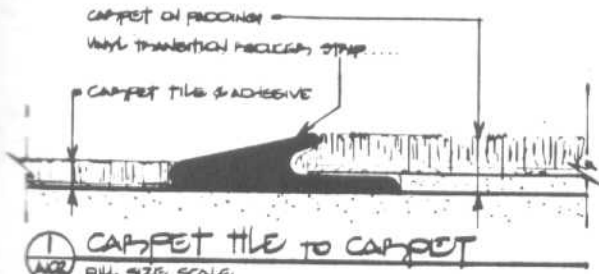
Saddles/Floor Transitions



FLOORS AND FLOOR FINISHES

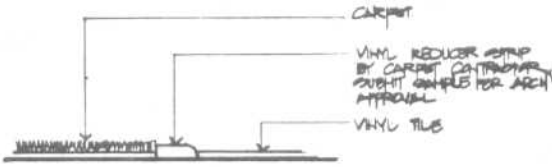
Saddles/Floor Transitions



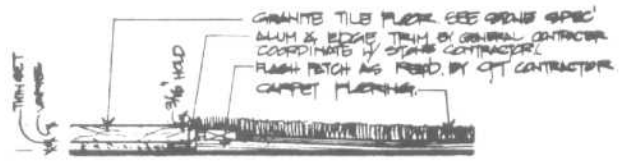


FLOORS AND FLOOR FINISHES

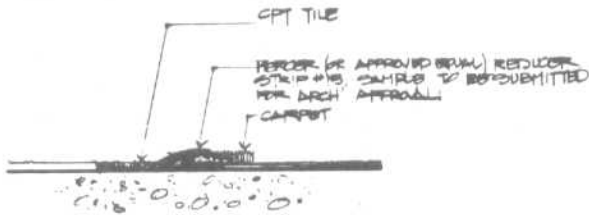
Floor Finish Transition Details



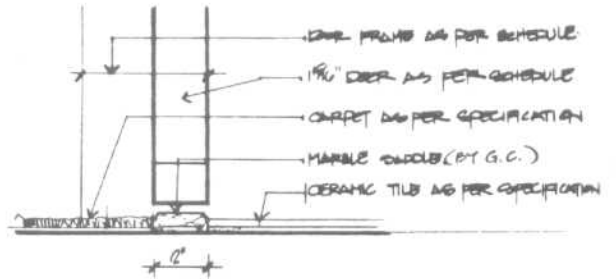
② SECTION @ FLOOR TRANSITION CARPET/VAT  
NTS



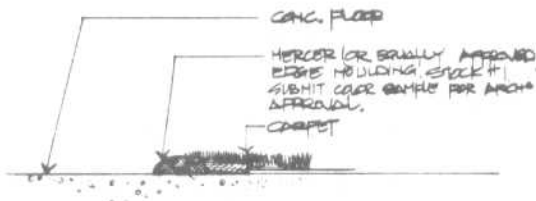
① SECTION @ FLOOR TRANSITION. STONE/CPT'  
1/2 F.S.



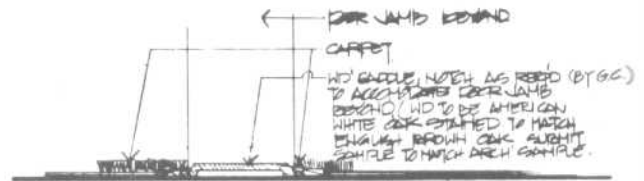
④ SECTION @ FLOOR TRANSITION CPT TILE/CPT'  
NTS



③ SECT ② FLOOR TRANSITION: CPT/C.TILE.  
3'-1'-0"



⑥ SECT ② FLOOR TRANSITION CPT/CONC.  
NTS



⑤ SECT ② WD SADDLE.  
NTS

FLOORS AND FLOOR FINISHES

Edgings; Tile/Carpet Joiners; Reducer Strips



**Vinyl Snap Down Divider**  
 ■ 3/4" wide removable section for joining carpets



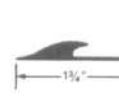
**Vinyl Tile Carpet Joiner**  
 ■ Provides smooth carpet/tile transition



**Vinyl Corner Guard**  
 ■ Protects corners and columns from bumps, abrasion, wear



**Vinyl Snap Down Divider**  
 ■ 1 3/8" wide removable section for joining carpets



**Vinyl 3/16" Glue Down Reducer**  
 ■ Undercut, flange, and transition combined  
 ■ Undercut 3/16" smooth transition




**Vinyl Fillet Strip**  
 ■ Superb backing for flashing up the wall  
 ■ Black only



**Vinyl Snap Down Edging**  
 ■ 1" wide removable section for joining carpet to tile



**Vinyl Carpet Cove Cap**  
 ■ Trim for coved carpet  
 ■ Undercut 3/16" (flexible)



**Vinyl Underlayment Reducer**  
 ■ Binder-bar type edging for resilient flooring  
 ■ Undercut .105" for use with 1/16" to 1/8" material



**Vinyl Snap Down Edging**  
 ■ 1 1/4" wide removable section for joining carpet to tile



**Vinyl 9/32" Cap**  
 ■ For capping coved carpets, ceramics, and paneling



**Vinyl 1/4" Glue Down Reducer**  
 ■ 1/4" butting gauge undercut  
 ■ Long flange, smooth taper



**Vinyl Single Flange Track**



**Vinyl Tackless Carpet Bar**  
 ■ 1/4" butting edge to accept tackless strip  
 ■ Deep undercut



**Vinyl 1/16" Tile Reducer**  
 ■ Beveled edge for resilient flooring material  
 ■ 1/16" (.063") butting gauge



**Vinyl 5/16" Glue Down Reducer**  
 ■ 5/16" butting gauge undercut  
 ■ Long flange, smooth taper



**Vinyl Tackless Carpet Bar Reducer**  
 ■ 1/4" butting edge to accept tackless strip



**Vinyl 3/32" Tile Reducer**  
 ■ Beveled edge for resilient flooring material  
 ■ 3/32" (.094") butting gauge



**Vinyl Custom Edge**  
 ■ For sponge backs  
 ■ General purpose edge and cap



**Vinyl 1/8" Tile Reducer**  
 ■ Beveled edge for resilient flooring material  
 ■ 1/8" (.125") butting gauge



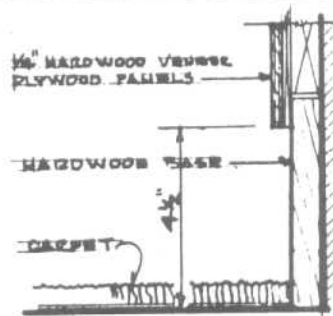
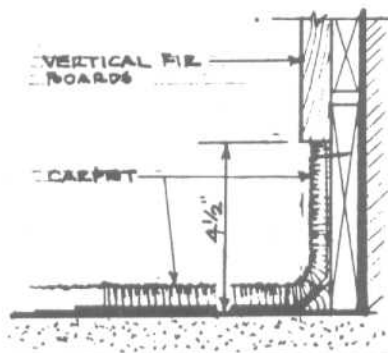
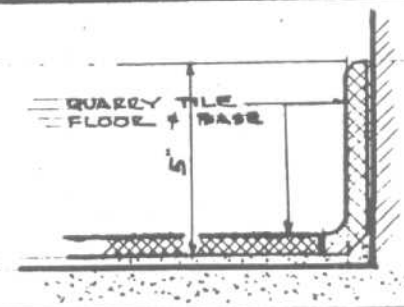
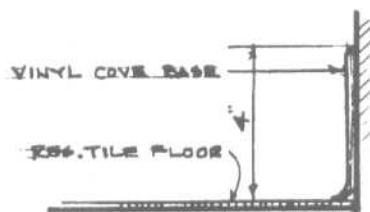
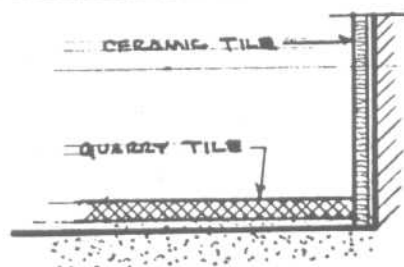
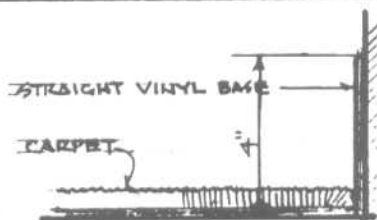
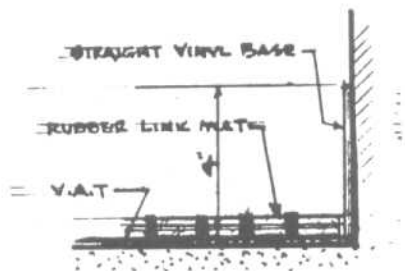
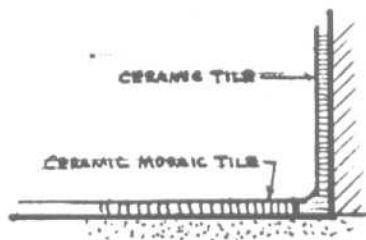
**Vinyl 1/4" Square Cove Cap**  
 ■ Undercut 1/4"  
 ■ Cap for coved carpets and wall paneling



**Vinyl 1/8" Square Cove Cap**  
 ■ Undercut 1/8"  
 ■ Cap for coved sheet vinyl

FLOORS AND FLOOR FINISHES

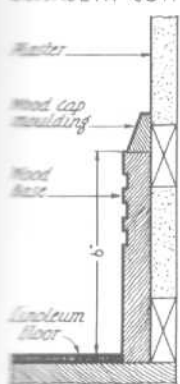
Base Details



BASE TYPES

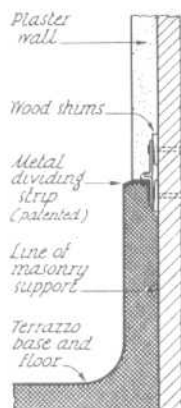
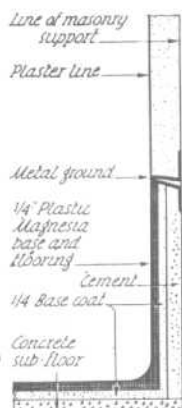
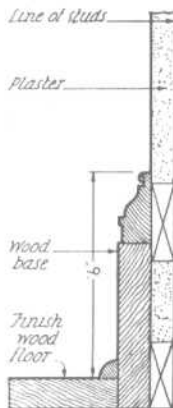
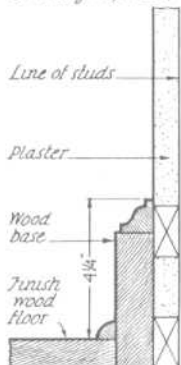


ELISABETH COIT

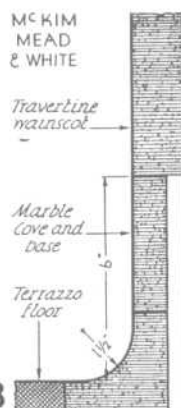


4

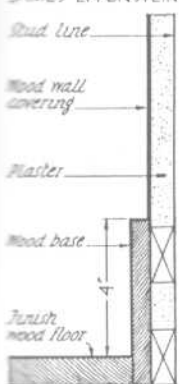
(Cowles Lewis House, Farmington, Conn.)



8

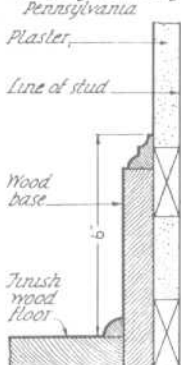


JAMES EPPENSTEIN

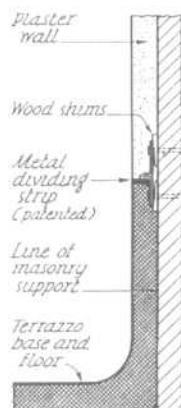
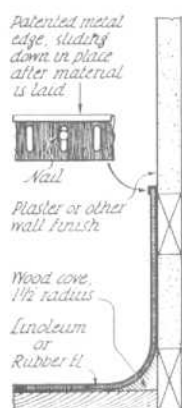
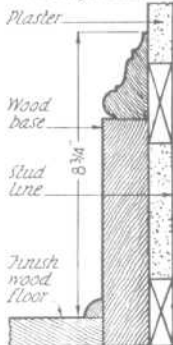


5

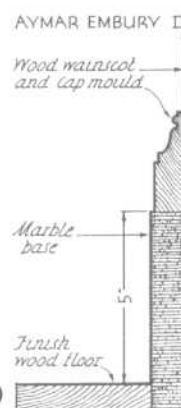
(Le Moyne House) Washington County, Pennsylvania



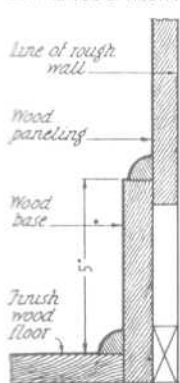
(Dorsey House) Washington County, Pennsylvania



9

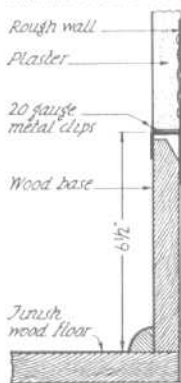


LAWRENCE J. KLEIN



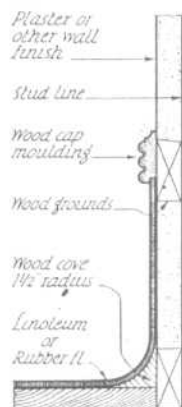
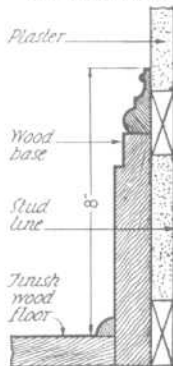
6

N. CHESTER SORENSON

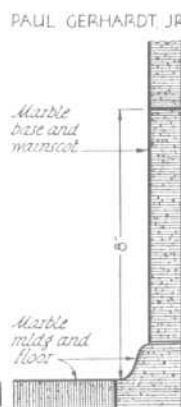


7

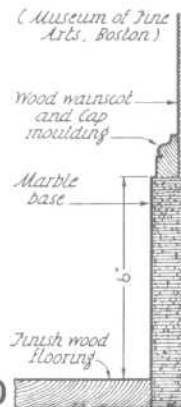
(Kingsley House) New Haven, Conn.



11

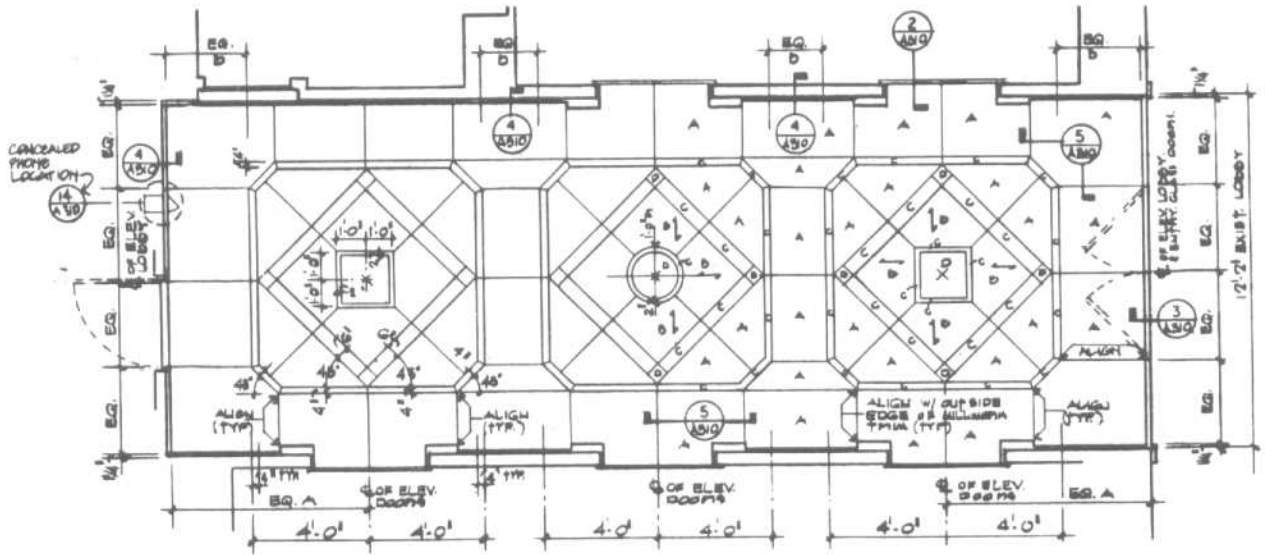


10



FLOORS AND FLOOR FINISHES

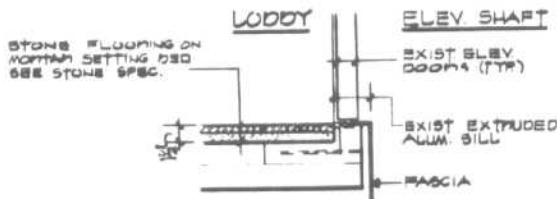
Stone Floor Patterns and Details



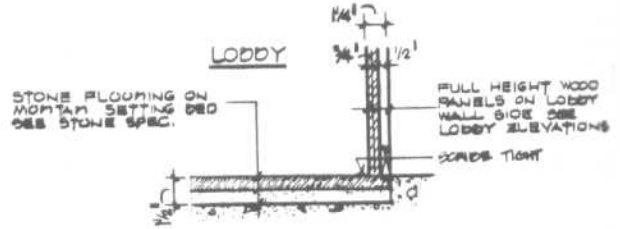
COLONS SEE SPEC. ON DRG A-20

- A - VENDE AVENI POLISHED
- B - CIPOLINO POLISHED
- C - ANDER BLACH GRANITE POLISHED
- D - MOSSO LEVANTO POLISHED WITHOUT GRANULE

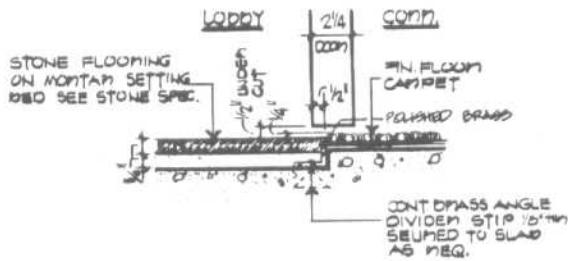
1 STONE FLOORING PATTERN DETAIL TYP. FLOORS 37" THRU 45" FL.  
1/4" = 1'-0"



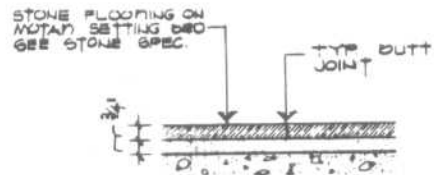
2 STONE DET. @ ELEV. DOOR SILL  
1/2" = 1'-0"



4 TYP. STONE FLOORING DET. @ LOBBY PANEL WALL  
3/8" = 1'-0"



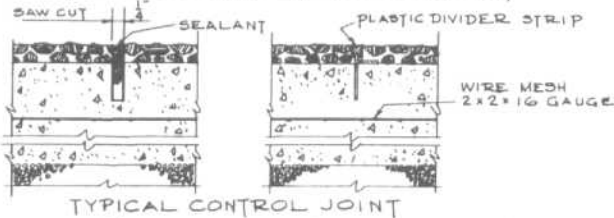
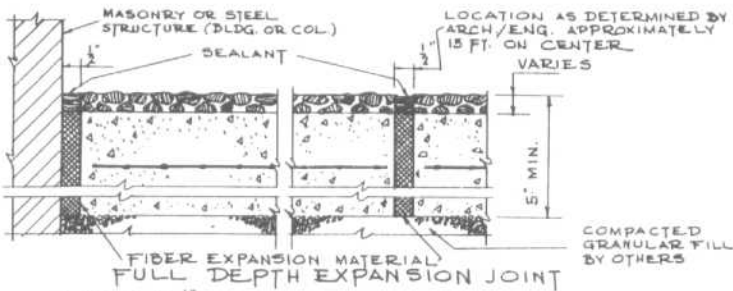
3 STONE FLOORING DET. @ ENTRY DOORS  
3/8" = 1'-0"



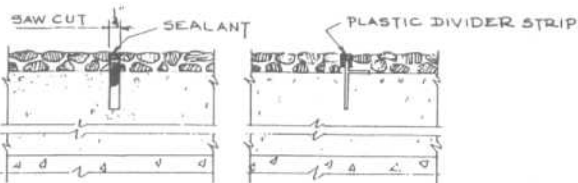
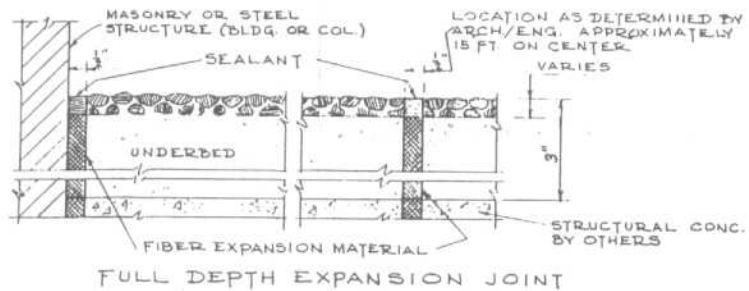
5 TYP. STONE BUTT JOINT DETAIL  
3/8" = 1'-0"

FLOORS AND FLOOR FINISHES

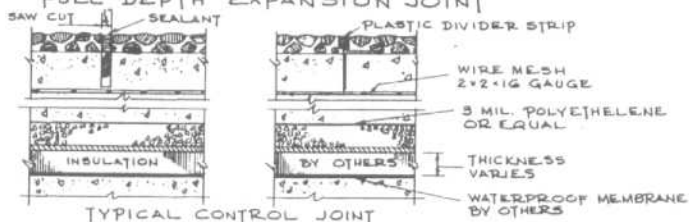
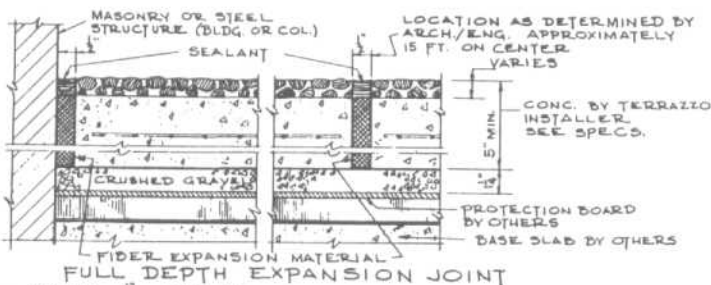
Terrazzo Floor Construction Details



TYPICAL CONTROL JOINT  
RUSTIC TERRAZZO-STRUCTURAL SYSTEM.  
OVER GRANULAR FILL



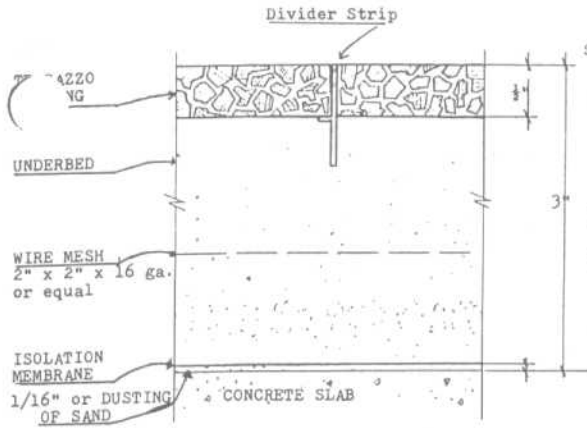
TYPICAL CONTROL JOINT  
RUSTIC TERRAZZO-BONDED SYSTEM WITH  
SETTING BED-OVER STRUCTURAL CONCRETE



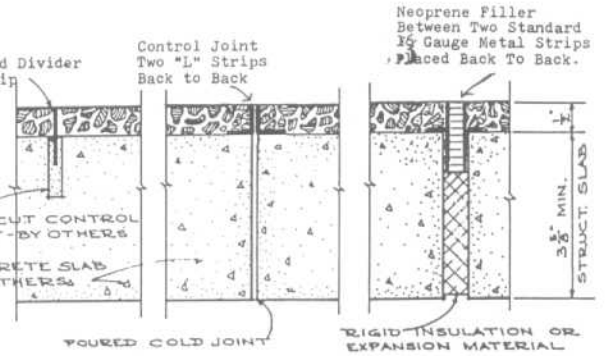
TYPICAL CONTROL JOINT  
RUSTIC TERRAZZO OVER SLABS WITH HEATED SPACE  
BELOW & OVER INSULATED & WATERPROOFED SLABS

FLOORS AND FLOOR FINISHES

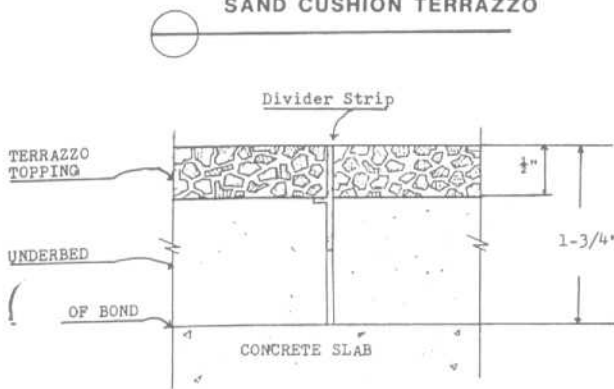
Terrazzo Floor Construction Details



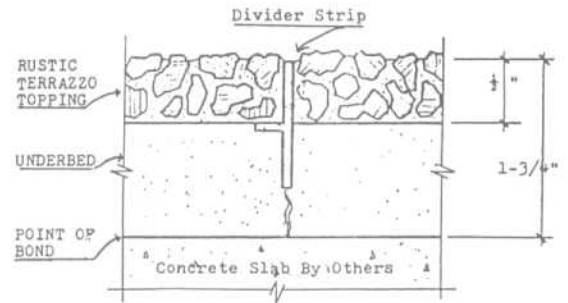
Monolithic Terrazzo



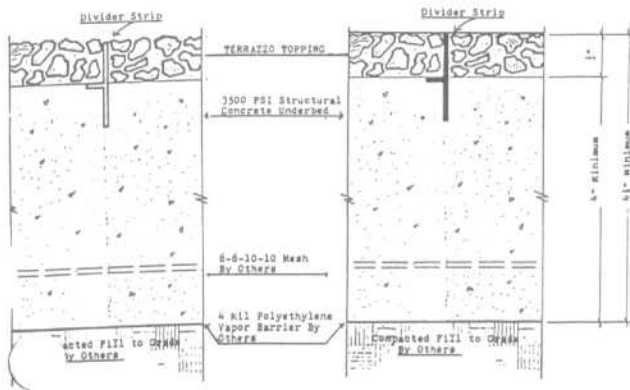
SAND CUSHION TERRAZZO



BONDED TO CONCRETE



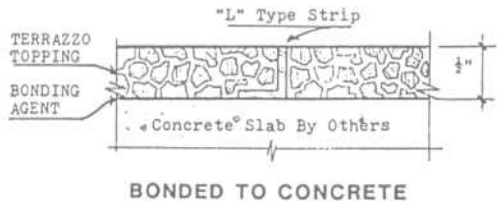
RUSTIC TERRAZZO  
Bonded to Concrete



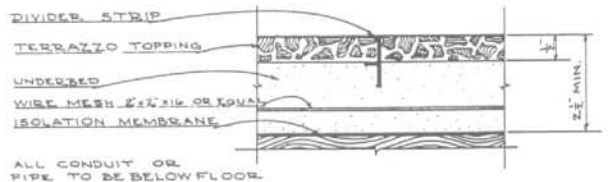
RUSTIC TERRAZZO

POLISHED TERRAZZO

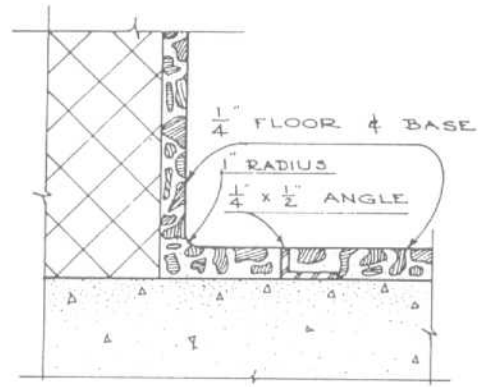
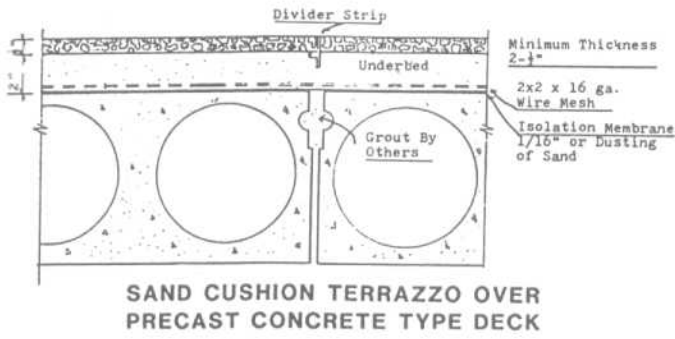
STRUCTURAL TERRAZZO SYSTEMS



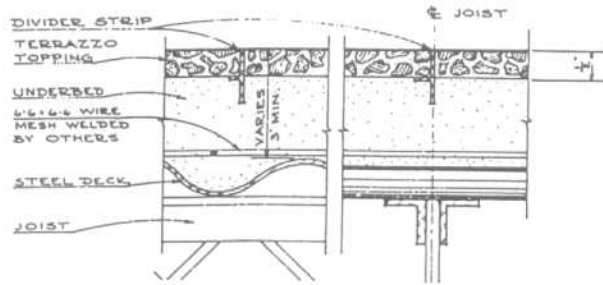
BONDED TO CONCRETE



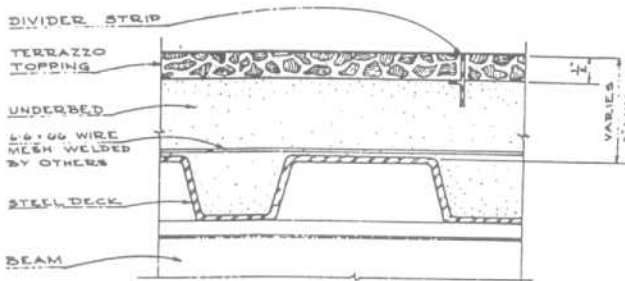
Terrazzo Over Wood



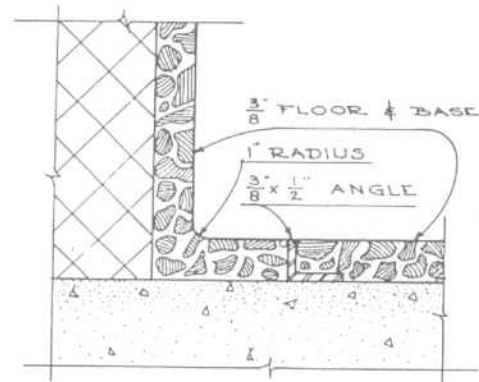
EPOXY, POLYESTER, TERRAZZO FLOOR & BASE



TERRAZZO OVER CORRUGATED METAL TYPE FLOOR



TERRAZZO OVER CELL TYPE FLOOR



POLYACRYLATE TERRAZZO FLOOR & BASE

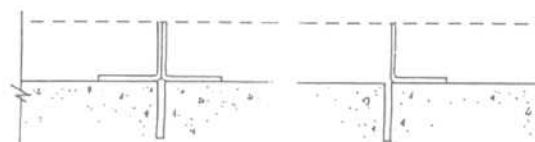
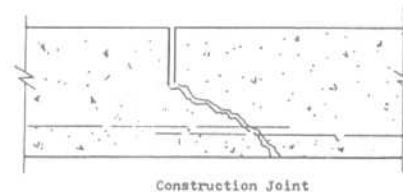
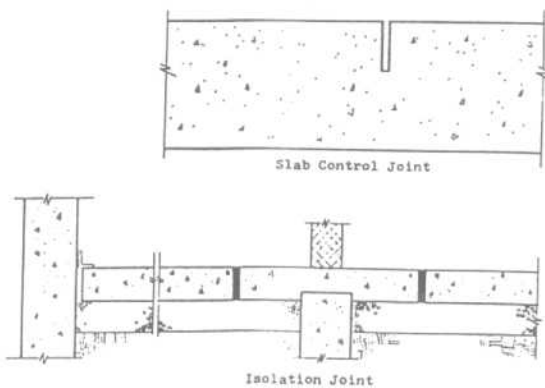
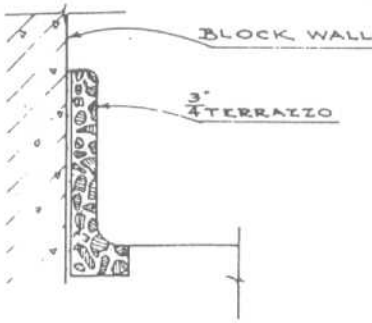


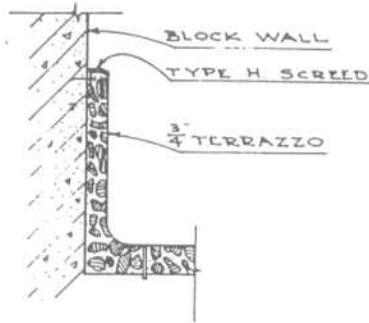
Fig. 5 Angle or "L" Strips Single Angle Strip  
Two Strips Positioned Back to Back Directly over saw cuts

FLOORS AND FLOOR FINISHES

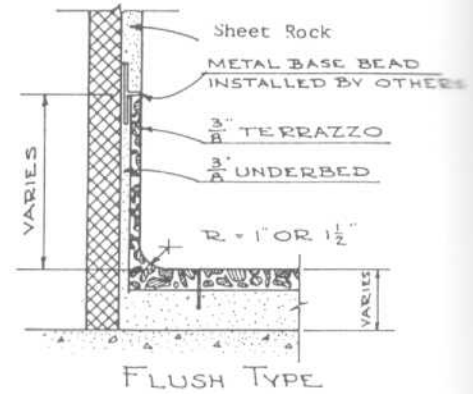
Terrazzo Base Details



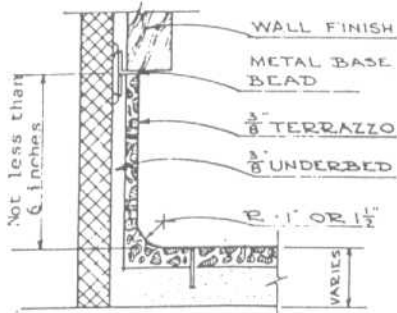
PRECAST TERRAZZO BASE



POURED TERRAZZO BASE

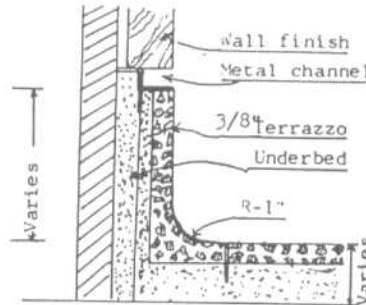


FLUSH TYPE

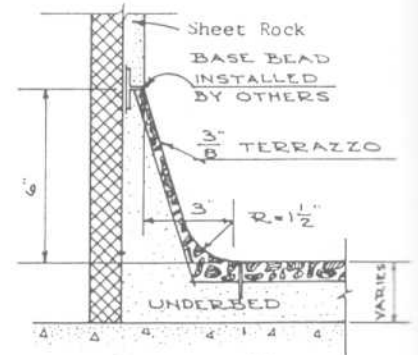


SHADOW TYPE

The Terrazzo base height should be 6 inches or more to use this detail.

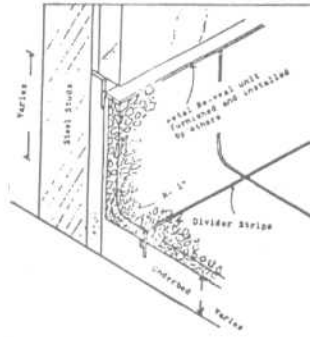


RE-VEAL TYPE

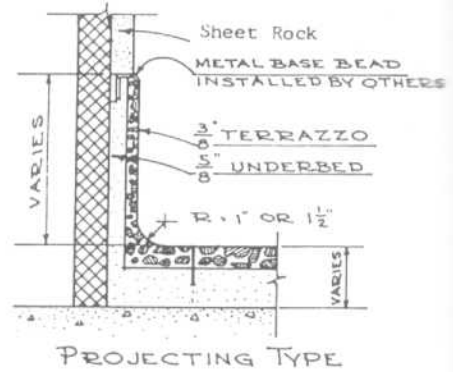


SPLAY TYPE

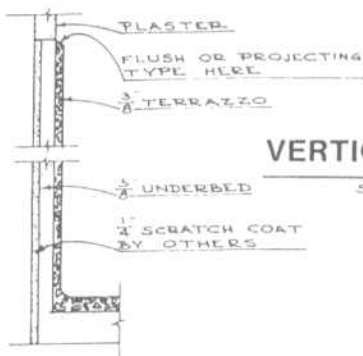
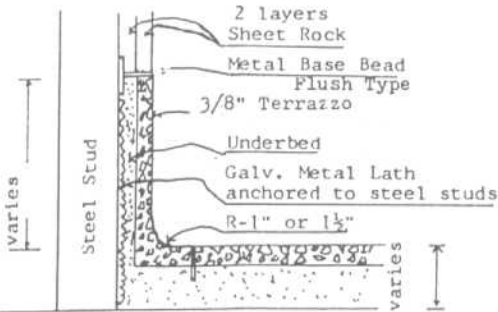
TERRAZZO BASE



Note: Provide Dimension in Space Indicated "Varies"

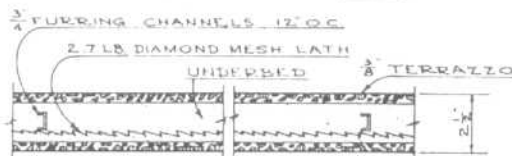


PROJECTING TYPE



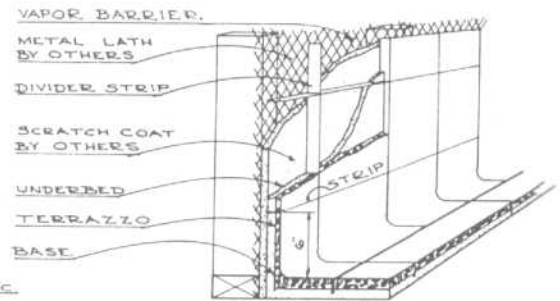
VERTICAL TERRAZZO

SCALE 3" = 1'-0"



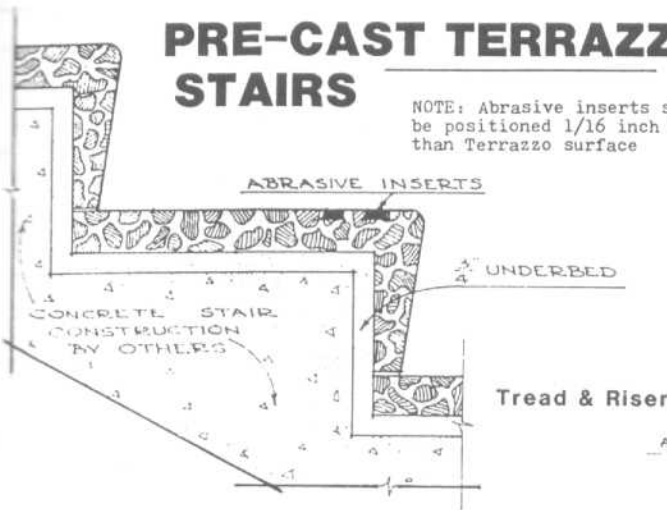
SOLID PARTITIONS

SCALE 3" = 1'-0"

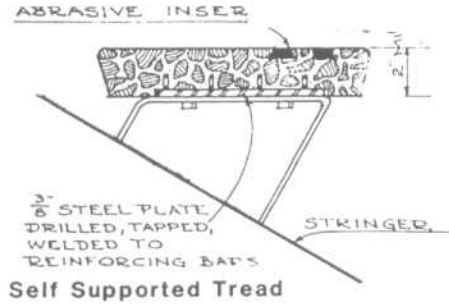


# PRE-CAST TERRAZZO STAIRS

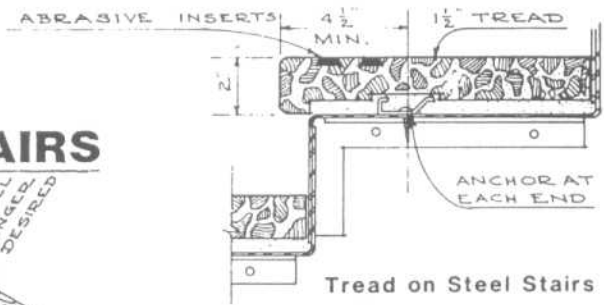
NOTE: Abrasive inserts should be positioned 1/16 inch higher than Terrazzo surface



Tread & Riser

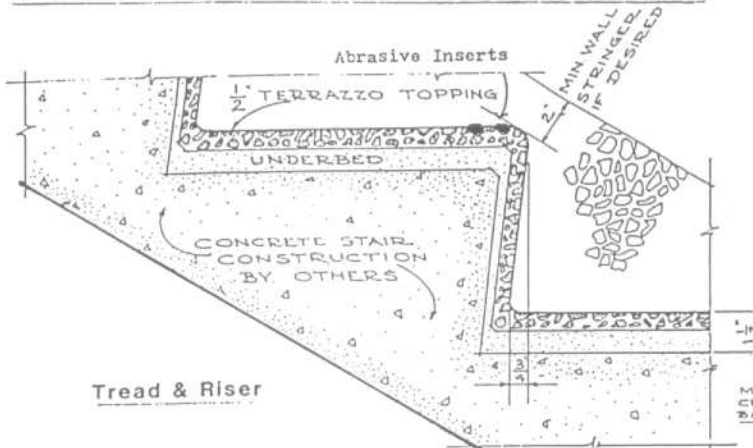


Self Supported Tread

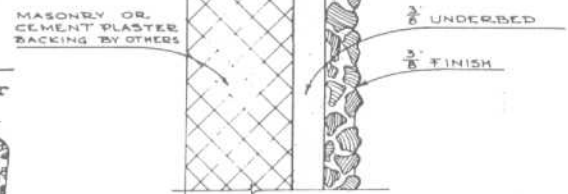


Tread on Steel Stairs

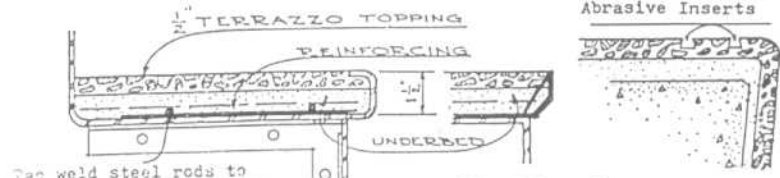
# POURED TERRAZZO STAIRS



Tread & Riser



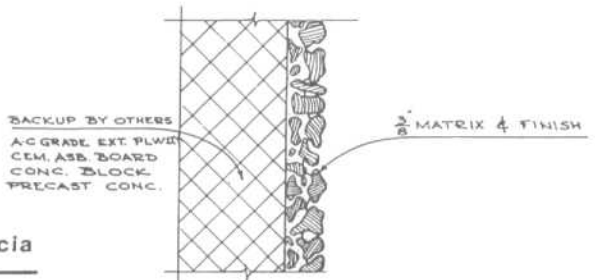
VERTICAL RUSTIC TERRAZZO



Steel Pan-Type



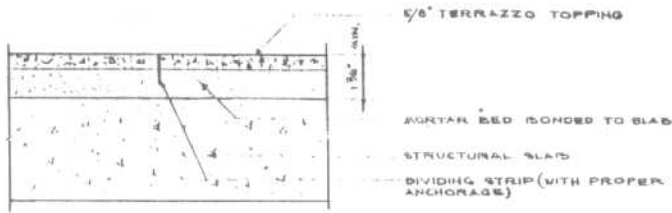
Terrazzo Stringer, Curb & Fascia



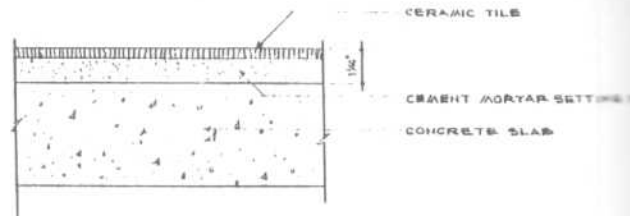
TEXTURED MOSAIC  
Epoxy, Polyester or Polyacrylate

FLOORS AND FLOOR FINISHES

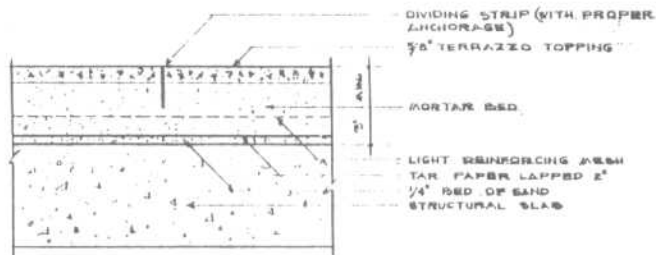
Ceramic Tile, Terrazzo, and Brick



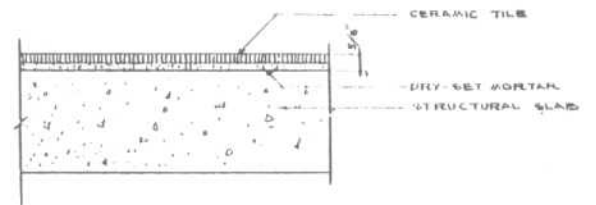
BONDED TERRAZZO



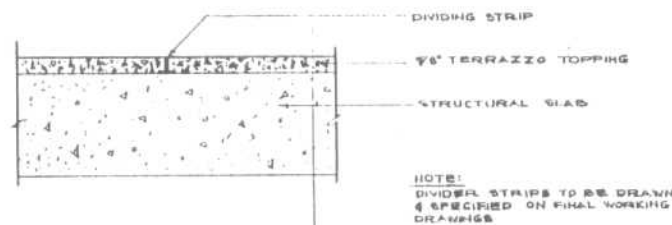
CERAMIC TILE SET IN MORTAR



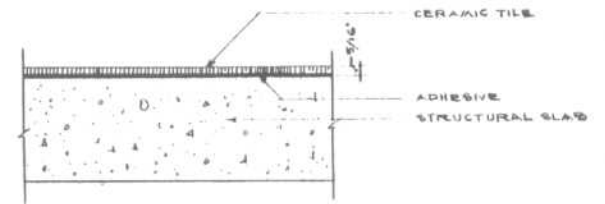
SAND-CUSHION TERRAZZO



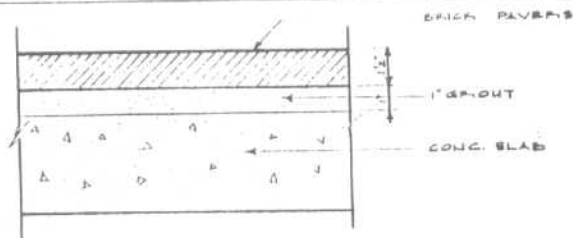
CERAMIC TILE IN DRY-SET MORTAR



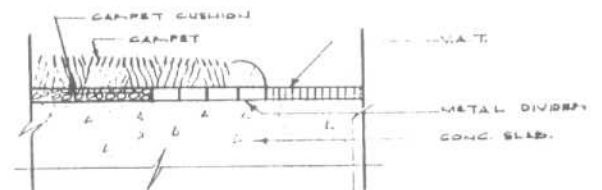
MONOLITHIC TERRAZZO



CERAMIC TILE SET IN ADHESIVE



BRICK PAVERS

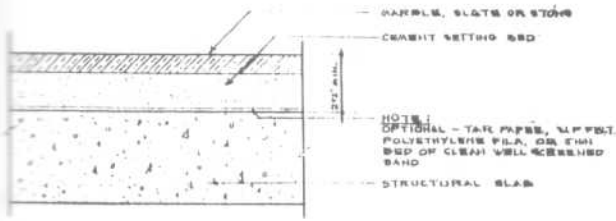


CARPET

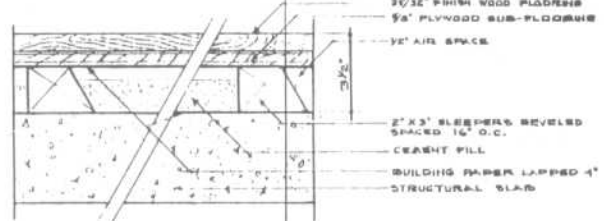


FLOORS AND FLOOR FINISHES

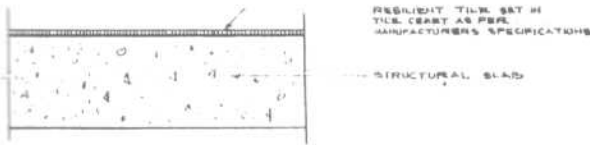
Marble, Resilient Tile, Slate, Wood, and Quarry Tile



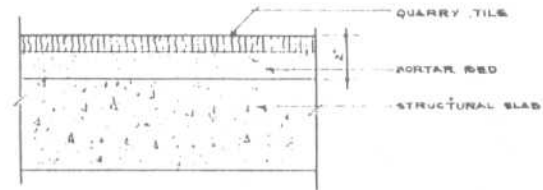
STONE FLOORING



WOOD FLOORING

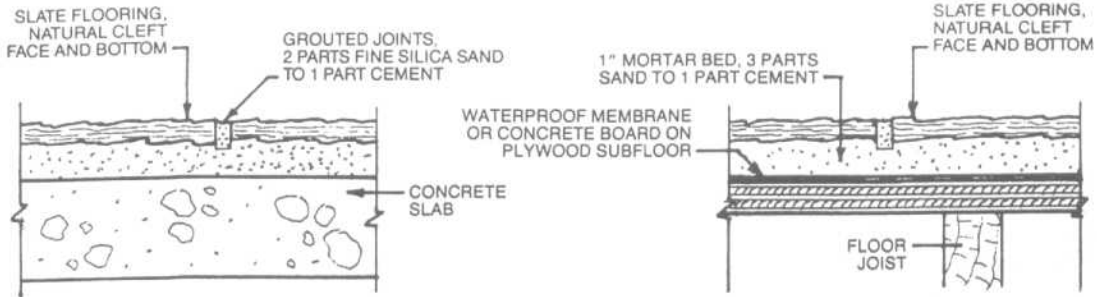


RESILIENT FLOORING

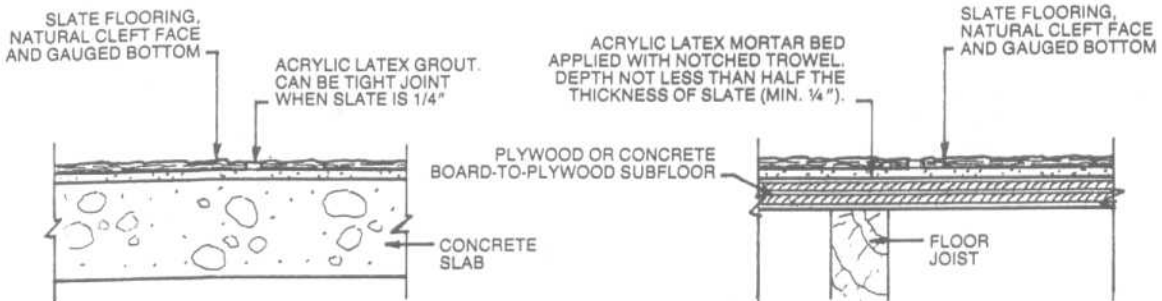


QUARRY TILE

MORTAR BED METHOD

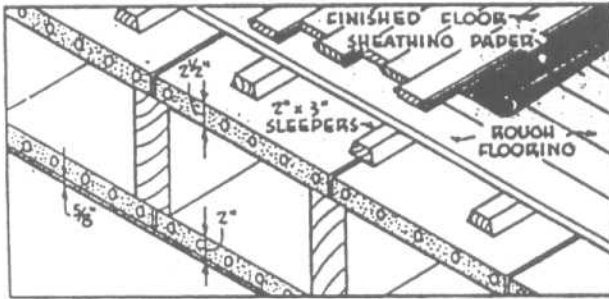


THINSET METHOD

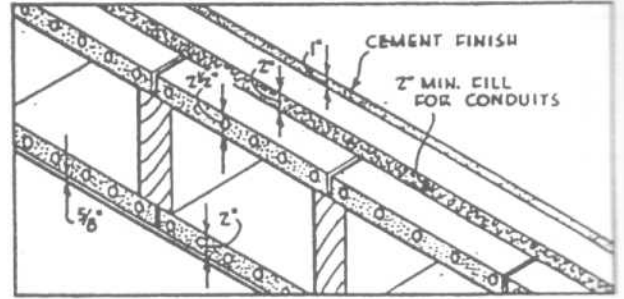


FLOORS AND FLOOR FINISHES

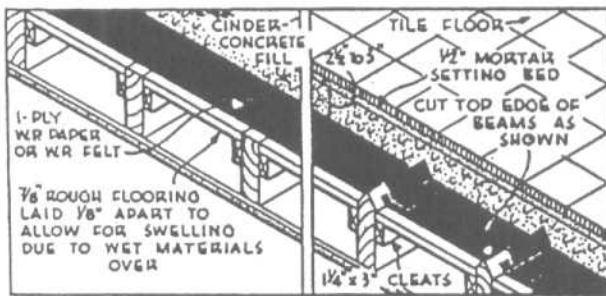
Wood Floor Construction Details



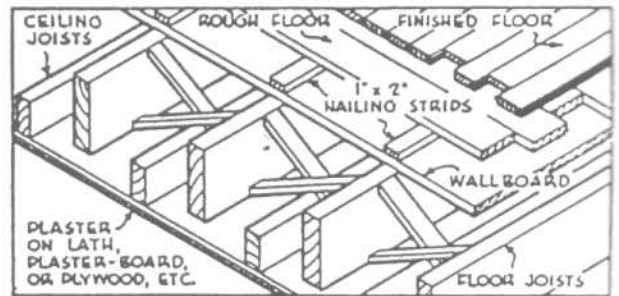
WOOD FLOOR OVER PRE-CAST GYPSUM BASE AND CEILING — WOOD JOISTS



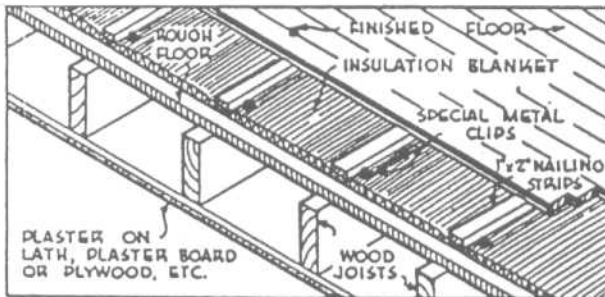
CEMENT FLOOR OVER PRE-CAST GYPSUM BASE AND CEILING — WOOD JOISTS



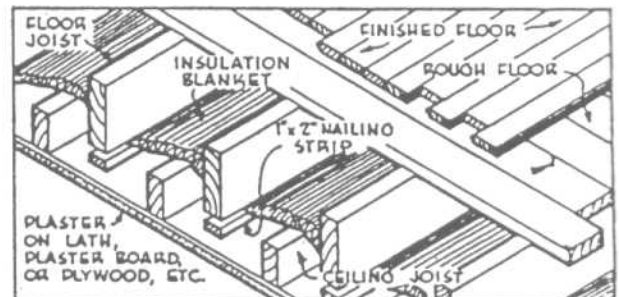
TILE FLOOR ON FLAT-TOP AND BEVELLED WOOD JOISTS



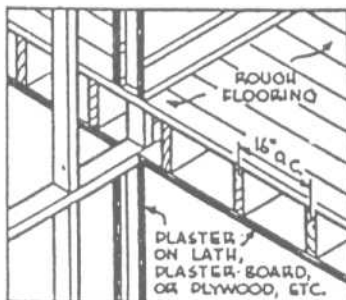
SOUND-CONTROL WITH STAGGERED JOISTS AND SUB-FLOORING



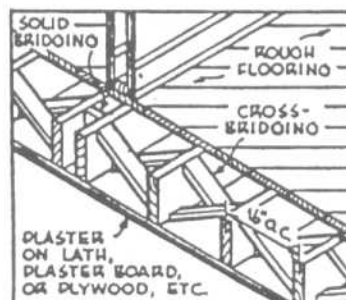
SOUND-CONTROL WITH INSULATION BLANKET BETWEEN ROUGH AND FINISHED FLOORING



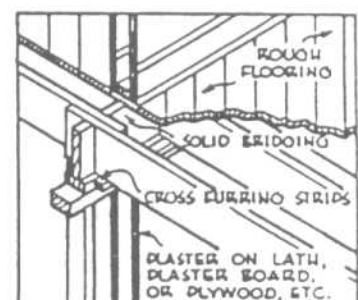
SOUND-CONTROL WITH STAGGERED JOISTS AND INSULATION BLANKET



PARTITION OVER PARTITION PARALLEL WITH JOISTS



PARTITION NOT OVER PARTITION — ON DOUBLE JOISTS



PARTITION OVER PARTITION AT RIGHT ANGLES TO JOISTS

## FLOORS AND FLOOR FINISHES

## Wood Strip Floor Construction Details

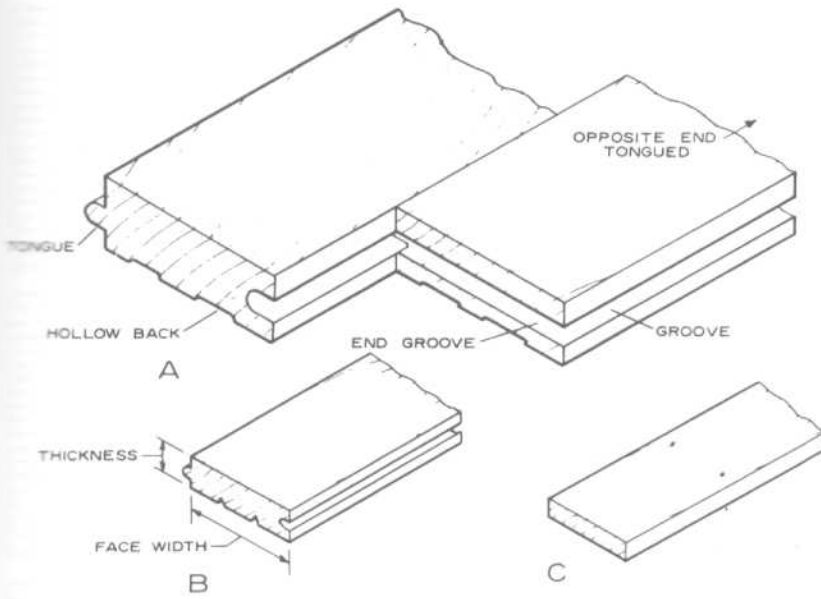


Fig. 6 Types of strip flooring: A, side- and end-matched —  $\frac{25}{32}$ -in; B, thin flooring strips — matched; C, thin flooring strips — square-edged.

Perhaps the most widely used pattern is a  $\frac{25}{32}$ -by  $2\frac{1}{4}$ -in strip flooring. These strips are laid lengthwise in a room and normally at right angles to the floor joists. Some type of a subfloor of diagonal boards or plywood is normally used under the finish floor. Strip flooring of this type is tongued-and-grooved and end-matched (Fig. 6). Strips are random length and may vary from 2 to 16 ft or more. End-matched strip flooring in  $\frac{25}{32}$ -in thickness is generally hollow backed (Fig. 6A). The face is slightly wider than the bottom so that tight joints result when flooring is laid. The tongue fits tightly into the groove to prevent movement and floor "squeaks." All of these details are designed to provide beautiful finished floors that require a minimum of maintenance.

Another matched pattern may be obtained in  $\frac{3}{8}$ -by 2-in size (Fig. 6B). This is commonly used for remodeling work or when subfloor is edge-blocked or thick enough to provide very little deflection under loads.

Square-edged strip flooring (Fig. 6C) might also be used occasionally. It is usually  $\frac{3}{8}$ -by 2 inches in size and is laid up over a substantial subfloor. Facenailing is required for this type.

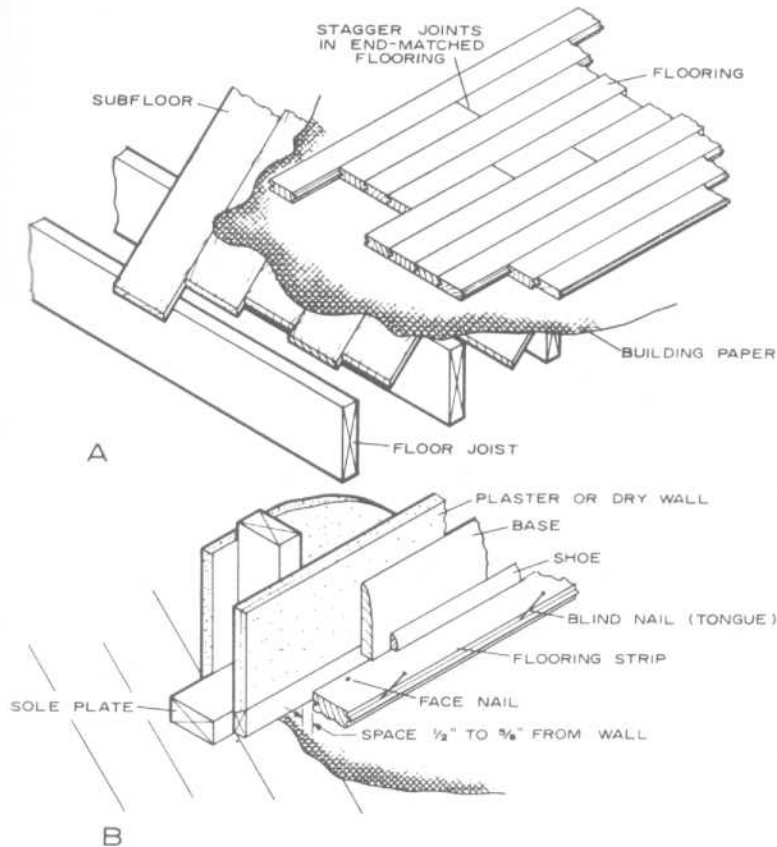


Fig. 7 Application of strip flooring: A, general application; B, starting strip.

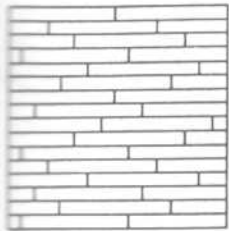
FLOORS AND FLOOR FINISHES

Wood Parquet Floor Patterns

PRODUCT DESCRIPTION AND PATTERN	PANEL SIZE	GRADE	*SPECIES
	5/16" x 19" x 19" 16 equal alternating squares 5/16" x 12" x 12" 4 equal alternating squares	Select & Better Rustic	Cherry, Maple, Red Oak, White Oak, Cedar, Pecan, Walnut, Rhodesian Teak, Angelique (Guiana Teak)
	5/16" x 19" x 19" 16 equal alternating squares 5/16" x 11" x 11" 4 equal alternating squares	Select & Better Rustic Select & Better (Par & Better) Rustic	Red Oak, White Oak, Pecan Pecan Red and White Oak
	5/16" x 19" x 19" 16 equal alternating squares 9/16" x 19" x 19" 16 equal alternating squares	Select & Better (Par & Better) Select Rustic & Better Rustic	Maple, Red Oak White Oak Pecan
	11/16" x 11" x 11" 4 equal alternating squares 3/4" x 12-11/16" x 12-11/16" 4 equal alternating squares	Select & Better (Par & Better) Select & Better (Rustic & Better)	Red Oak, Maple White Oak
	5/16" x 6-11/32" x 6-11/32" 5/16" x 2" x 12" (slats) 5/16" x 6" x 6" 5/16" x 6 3/4" x 6 3/4" 5/16" x 6 1/2" x 6 1/2" individual unit	Select & Better Natural & Better Fireside Rustic Cabin & Better Cabin	Oak, Walnut Pecan, Maple White Oak, Ash
	5/16" x 6 1/2" x 6 1/2" individual units 3/8" foam, 2 lb. density	Natural & Better Cabin & Better Cabin	Oak, Pecan Maple
	5/16" x 6" x 6" individual squares 5/16" x 6 3/4" x 6 3/4" individual squares 5/16" x 6 1/2" x 6 1/2" individual squares 5/16" x 11" x 11" 4 equal alternating squares	Select Natural & Better Select & Better (Par & Better) Rustic Fireside	Red Oak & White Oak Red Oak & White Oak
	5/16" x 6 3/4" x 6 3/4" 5/16" x 6 1/2" x 6 1/2" individual squares	Natural & Better Cabin	Oak
	5/16" x 6" x 6" individual squares used with 5/16" x 3/4" x 8" pickets 5/16" x 13 1/4" x 13 1/4" 4 equal alternating squares 5/16" x 13 1/4" x 13 1/4" (Factory Finished)	Select & Better (Par & Better) Rustic Natural & Better	Angelique (Guiana Teak) Red Oak, White Oak Black Walnut Ash, Maple
	5/16" x 14 1/4" x 14 1/4" 5/16" x 13 1/4" x 13 1/4" 4 equal squares 5/16" x 13 1/4" x 13 1/4" (Factory Finished)	Select & Better (Par & Better) Rustic Natural & Better	Angelique (Guiana Teak) Red Oak, White Oak Black Walnut
	5/16" x 2" x 12" individual slats 5/16" x 14 1/4" x 18 1/4" (Approximate overall) 2 - "V" shape courses wide and 11 slats long	Select & Better (Par & Better)	Angelique (Guiana Teak) Red Oak, White Oak Black Walnut
	5/16" x 19" x 19" 4 equal squares on diagonal and 8 equal half squares	Select & Better (Par & Better)	Angelique (Guiana Teak) Red Oak, White Oak
	5/16" x 13 1/4" x 13 1/4" 4 equal alternating squares with diagonal center slats 5/16" x 13 1/4" x 13 1/4"	Select & Better (Par & Better) Natural & Better	Angelique (Guiana Teak) Red Oak, White Oak Black Walnut
	Hexagonal Shape 5/16" x 15 1/4" x 15 1/4" 12 equal Rhomboids	Select & Better (Par & Better) Rustic	Red Oak & White Oak Angelique (Guiana Teak) Black Walnut
	5/16" x 15-1/5" x 19" 4 runs of 3 slats and 5 slats alternating	Select & Better (Par & Better)	Angelique (Guiana Teak) Red Oak, White Oak Black Walnut
	5/16" x 19" x 19" 400 equal size pieces butt-jointed	Select & Better (Par & Better)	Black Walnut Angelique (Guiana Teak) Maple, Red Oak White Oak

FLOORS AND FLOOR FINISHES

Wood Floor Patterns



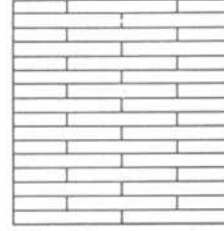
Pattern #1  
Same length of any size



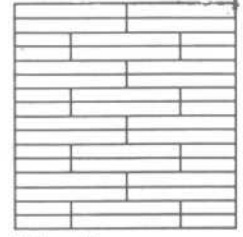
Pattern #2  
Same length of any size



Pattern #3  
Same length of any size



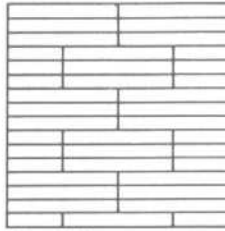
Pattern #4  
Same length of any size



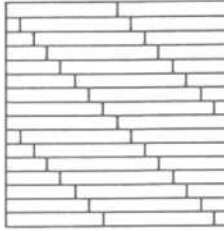
Pattern #5  
Same length of any size



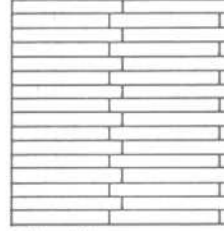
Pattern #6  
Same length of any size



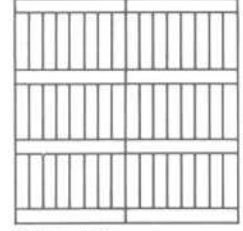
Pattern #7  
Same length of any size



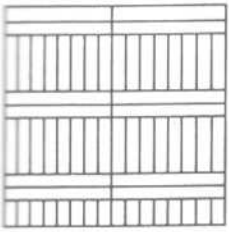
Pattern #8  
Same length of any size



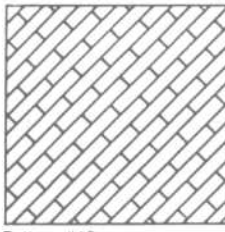
Pattern #9  
Same length of any size



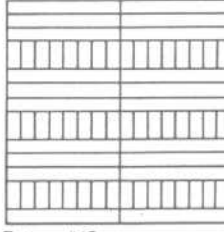
Pattern #10  
36" and 18" lengths



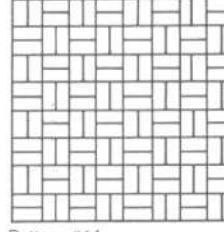
Pattern #11  
36" and 18" lengths



Pattern #12  
Same length of any size



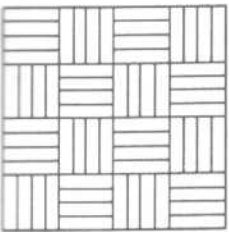
Pattern #13  
36" and 9" lengths



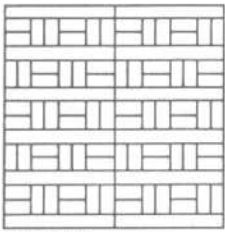
Pattern #14  
9" lengths



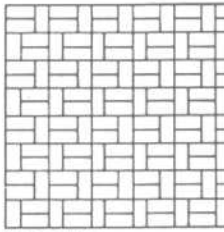
Pattern #15  
18" and 9" lengths



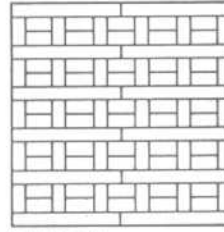
Pattern #16  
18" lengths



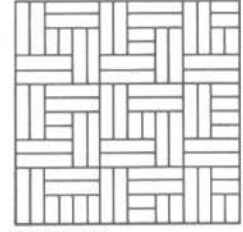
Pattern #17  
36" and 9" lengths



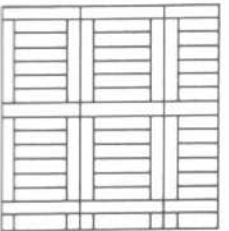
Pattern #18  
9" lengths



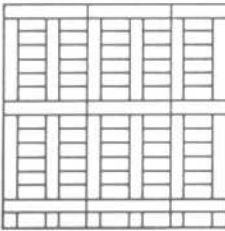
Pattern #19  
36" and 9" lengths



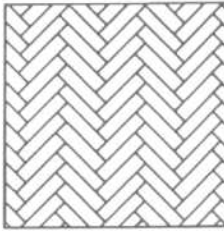
Pattern #20  
18" and 9" lengths



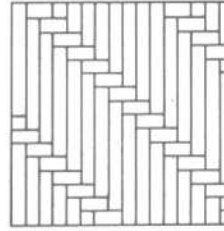
Pattern #21  
36" and 27" lengths



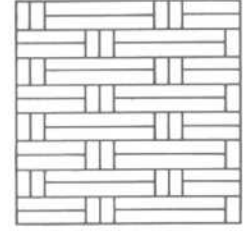
Pattern #22  
27" and 9" lengths



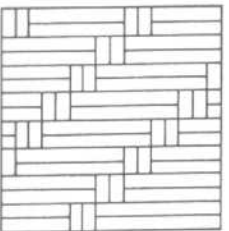
Pattern #23  
Same length of any size



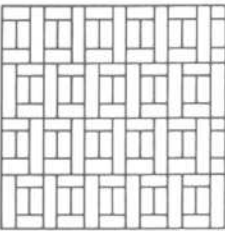
Pattern #24  
36" and 9" lengths



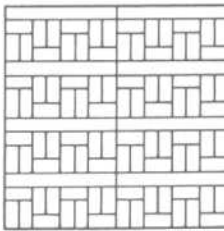
Pattern #25  
36" and 9" lengths



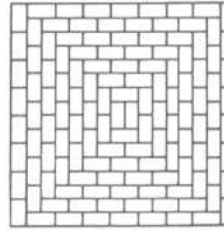
Pattern #26  
36" and 9" lengths



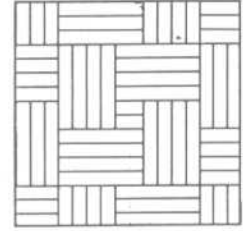
Pattern #27  
18" and 9" lengths



Pattern #28  
36" and 9" lengths



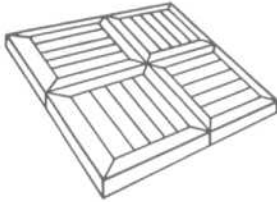
Pattern #29  
9" lengths



Pattern #31  
27" and 9" lengths

FLOORS AND FLOOR FINISHES

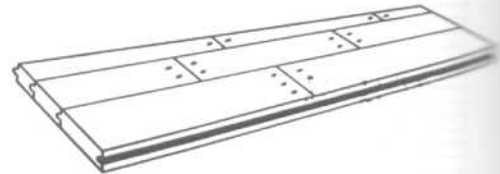
Wood Parquet and Plank Floor Patterns



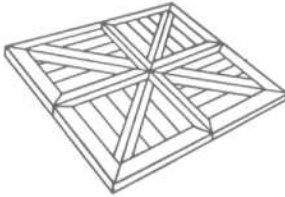
5/16" x 13-1/4" x 13-1/4"



5/16" x 19" x 19"

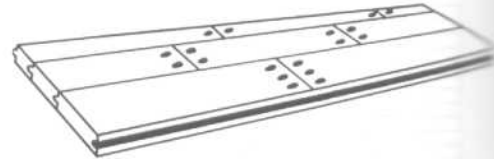


3/4" x 3", 5", & 7"

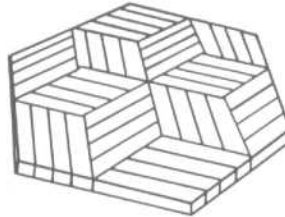


5/16" x 13-1/4" x 13-1/4"

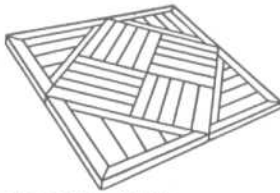
5/16" x 11" x 11"



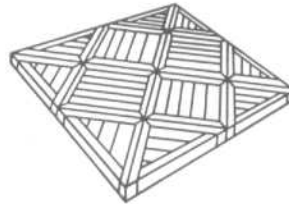
3/4" x 3", 5", & 7"



5/16" x 15-1/8" x 15-1/8"

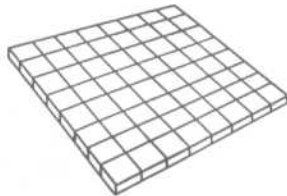


5/16" x 13-7/16" x 13-7/16"



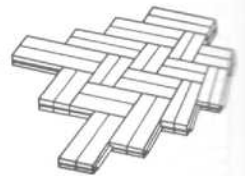
5/16" x 19" x 19"

3/4" thick design formed with 6" x 6" blocks and 2-1/4" x 14-1/4" pickets

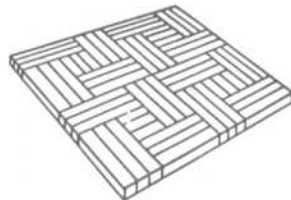


5/16" x 18" x 18"

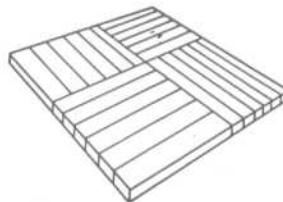
3/4" x 2-1/4" single slat. Lengths: 6-3/4", 9", 11-1/4", 13-1/2", 15-3/4", 18"



3/4" x 3" single slat. Lengths: 6", 9", 12", 15", 18"

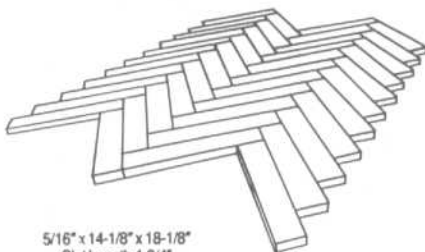
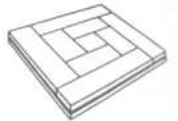


5/16" x 14-1/4" x 14-1/4"



5/16" x 19" x 19"

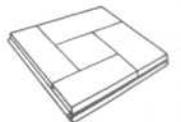
3/4" x 15" x 15"



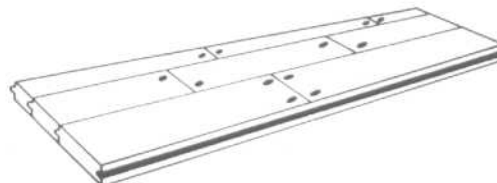
5/16" x 14-1/8" x 18-1/8" Slat Length 4-3/4"

5/16" x 11" x 16-1/2"

3/4" x 16" x 16" Units



5/16" x 16-1/4" x 18-1/8" Slat Length 5-1/2"

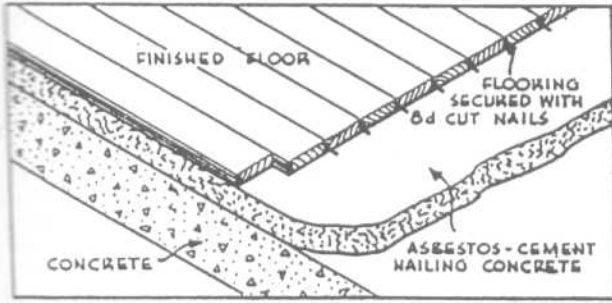


3/4" x 3", 5", & 7"

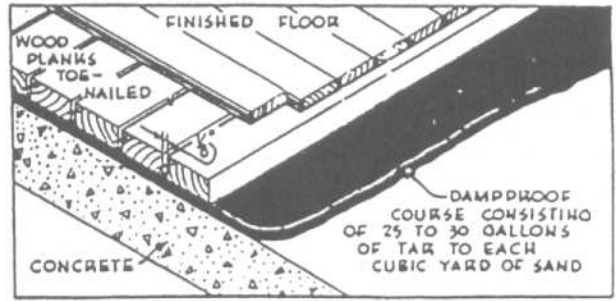


FLOORS AND FLOOR FINISHES

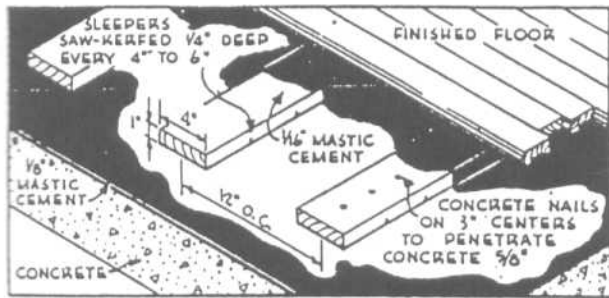
Wood on Concrete Slab Floor Construction Details



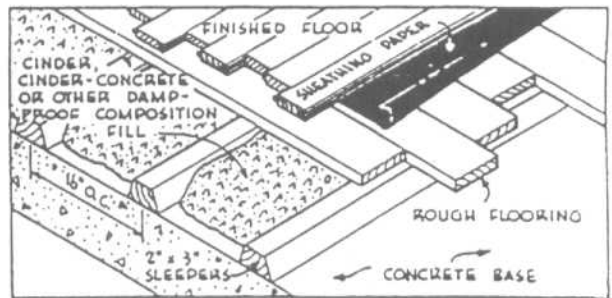
WOOD FLOOR OVER CONCRETE WITH UNDERLAYER OF NAILING CONCRETE



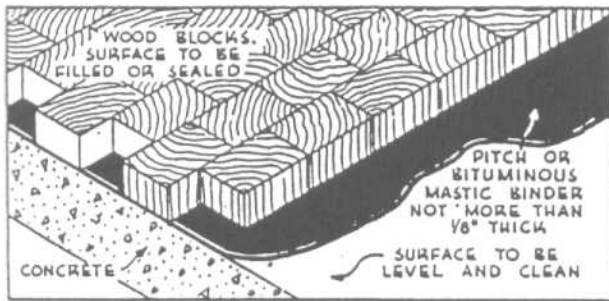
WOOD FLOOR OVER CONCRETE



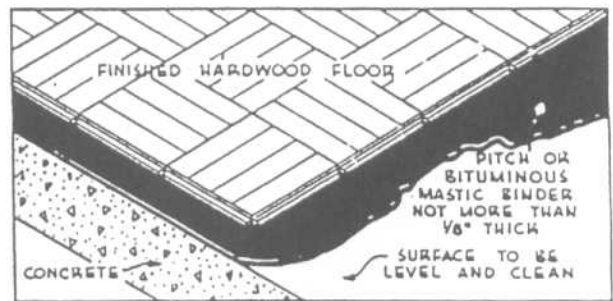
FINISHED FLOOR DIRECTLY ON SLEEPERS SET IN MASTIC CEMENT & NAILED TO CONCRETE



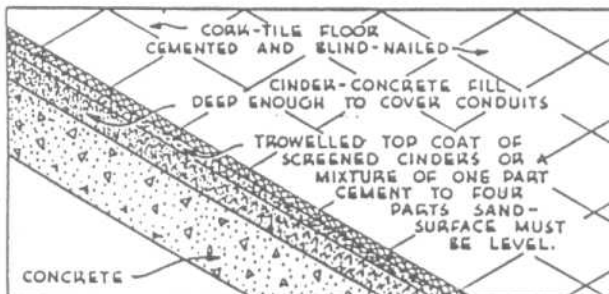
WOOD FLOOR OVER CONCRETE WITH SUB-BASE OF SLEEPERS & SLEEPER FILL



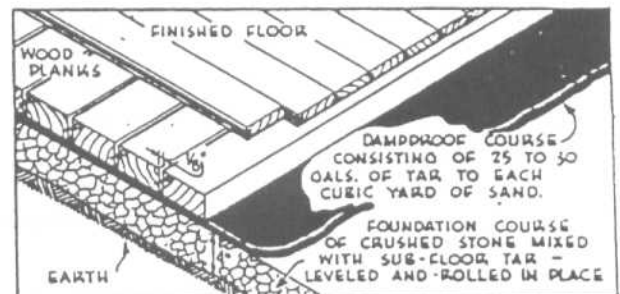
WOOD BLOCK FLOOR OVER CONCRETE



WOOD FLOOR OVER CONCRETE IN MASTIC



CORK TILE FLOOR OVER CONCRETE



WOOD FLOOR APPLIED OVER EARTH

**FLOORS AND FLOOR FINISHES**

**Floor Construction Sound Insulation**

Sound insulation between an upper floor and the ceiling of a lower floor not only involves resistance of airborne sounds but also that of impact noises. Thus, impact noise control must be considered as well as the STC value. Impact noise is caused by an object striking or sliding along a wall or floor surface, such as by dropped objects, footsteps, or moving furniture. It may also be caused by the vibration of a dishwasher, bathtub, food-disposal apparatus, or other equipment. In all instances, the floor is set into vibration by the impact or contact and sound is radiated from both sides of the floor.

A method of measuring impact noise has been developed and is commonly expressed as the *impact noise ratings (INR)*. The greater the positive value of the INR, the more

resistant is the floor to impact noise transfer. For example, an INR of -2 is better than one of -17, and one of +5 INR is a further improvement in resistance to impact noise transfer.

Figure 8 shows STC and approximate INR(db) values for several types of floor constructions. Figure 8A, perhaps a minimum floor assembly with tongued-and-grooved floor and 3/8-in gypsum board ceiling, has an STC value of 30 and an approximate INR value of -18. This is improved somewhat by the construction shown in Fig. 8B, and still further by the combination of materials in Fig. 8C.

The value of isolating the ceiling joists from a gypsum lath and plaster ceiling by means of spring clips is illustrated in Fig. 9A. An STC

value of 52 and an approximate INR value of -2 result.

Foam-rubber padding and carpeting improve both the STC and the INR values. The STC value increases from 31 to 45 and the approximate INR from -17 to +5 (Fig. 9B and C). This can likely be further improved by using an isolated ceiling finish with spring clips. The use of sound-deadening board and a lamination of gypsum board for the ceiling would also improve resistance to sound transfer.

An economical construction similar to (but an improvement over) Fig. 9C, with a STC value of 48 and an approximate INR of +18, consists of the following: (a) a pad and carpet over 3/8-in tongued-and-grooved plywood underlayment, (b) 3-in fiberglass insulating

DETAIL	DESCRIPTION	ESTIMATED VALUES	
		STC RATING	APPROX. INR
<p>A</p>	<p>FLOOR 7/8" T. &amp; G. FLOORING</p> <p>CEILING 3/8" GYPSUM BOARD</p>	30	-18
<p>B</p>	<p>FLOOR 3/4" SUBFLOOR 3/4" FINISH FLOOR</p> <p>CEILING 3/4" FIBERBOARD</p>	42	-12
<p>C</p>	<p>FLOOR 3/4" SUBFLOOR 3/4" FINISH FLOOR</p> <p>CEILING 1/2" FIBERBOARD LATH 1/2" GYPSUM PLASTER 3/4" FIBERBOARD</p>	45	-4

Fig. 8 Relative impact and sound transfer in floor-ceiling combinations (2- by 8-in joists).



batts between joists, (c) resilient channels spaced 24 in apart, across the bottom of the joists, and (d)  $\frac{5}{8}$ -in gypsum board screwed to the bottom of the channels and finished with taped joints.

The use of separate floor joists with staggered ceiling joists below provides reasonable values but adds a good deal to construction costs. Separate joists with insulation between and a soundboard between sub-floor and finish provide an STC rating of 53 and an approximate INR value of -3.

**Sound absorption** Design of the "quiet" house can incorporate another system of sound insulation, namely, sound absorption. Sound-absorbing materials can minimize the

amount of noise by stopping the reflection of sound back into a room. Sound-absorbing materials do not necessarily have resistance to airborne sounds. Perhaps the most commonly used sound-absorbing material is acoustic tile. Wood fiber or similar materials are used in the manufacture of the tile, which is usually processed to provide some fire resistance and designed with numerous tiny sound traps on the tile surfaces. These may consist of tiny drilled or punched holes, fissured surfaces, or a combination of both.

Acoustic tile is most often used in the ceiling and areas where it is not subjected to excessive mechanical damage, such as above a wall wainscoting. It is normally manufactured in sizes from 12 by 12 by

48 in. Thicknesses vary from  $\frac{1}{2}$  to  $\frac{3}{4}$  in, and the tile is usually factory finished ready for application. Paint or other finishes which fill or cover the tiny holes or fissures for trapping sound will greatly reduce its efficiency.

Acoustic tile may be applied by a number of methods - to existing ceilings or any smooth surface with a mastic adhesive designed specifically for this purpose, or to furring strips nailed to the underside of the ceiling joists. Nailing or stapling tile is the normal application method in this system. It is also used with a mechanical suspension system involving small "H," "Z," or "T" members. Manufacturers' recommendations should be followed in application and finishing.

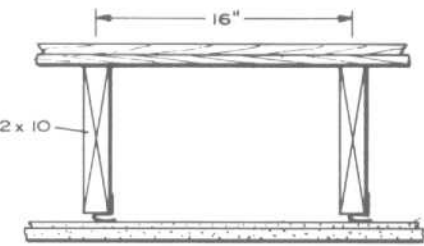
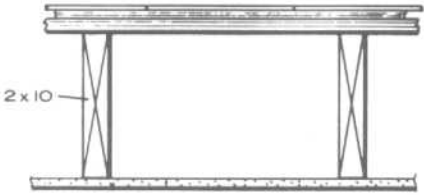
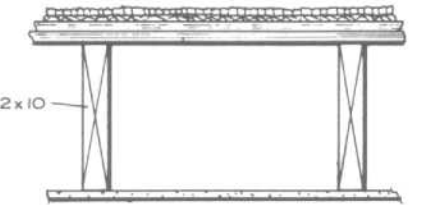
DETAIL	DESCRIPTION	ESTIMATED VALUES	
		STC RATING	APPROX. INR
 <p>A</p>	<p>FLOOR  <math>\frac{3}{4}</math>" SUBFLOOR            (BUILDING PAPER)  <math>\frac{3}{4}</math>" FINISH FLOOR</p> <p>CEILING            GYPSUM LATH AND            SPRING CLIPS  <math>\frac{1}{2}</math>" GYPSUM PLASTER</p>	52	-2
 <p>B</p>	<p>FLOOR  <math>\frac{5}{8}</math>" PLYWOOD SUBFLOOR  <math>\frac{1}{2}</math>" PLYWOOD            UNDERLAYMENT  <math>\frac{1}{8}</math>" VINYL-ASBESTOS            TILE</p> <p>CEILING  <math>\frac{1}{2}</math>" GYPSUM WALLBOARD</p>	31	-17
 <p>C</p>	<p>FLOOR  <math>\frac{5}{8}</math>" PLYWOOD SUBFLOOR  <math>\frac{1}{2}</math>" PLYWOOD            UNDERLAYMENT            FOAM RUBBER PAD  <math>\frac{3}{8}</math>" NYLON CARPET</p> <p>CEILING  <math>\frac{1}{2}</math>" GYPSUM WALLBOARD</p>	45	+5

Fig. 9 Relative impact and sound transfer in floor-ceiling combinations (2- by 10-in joists).

FLOORS AND FLOOR FINISHES

Floor Construction Sound Insulation

# conventional wood joist systems for sound control

FLOOR SYSTEM	FLOOR NUMBER	FLOOR COVERING
<p><b>conventional</b></p> <p>The basic construction is illustrated by floor No. 3 although floors 4 and 5 have 2"x10" joists and 1/2" subfloor. Except in floor No. 1, the ceiling is fire-resistive type gypsum board applied with screws to resilient channels 24" o.c. Standard carpet is 44-ounce (sq. yd.) groppoint over 40-ounce hair pad.</p>	1	3/8" vinyl asbestos tile on 3/8" plywood underlayment
	2	.075" vinyl sheet on 3/8" plywood underlayment
	3	Carpet and pad directly over subfloor
	4	2 5/32" oak strip floor over subfloor
	5	Carpet and pad added to No. 4
<p><b>conventional</b> With Floated Floor Over</p> <p>The basic construction is illustrated. Sound deadening board (15-18 p.c.f.) is laid over a 5/8" plywood subfloor, with or without stapling, and 1/2" T&amp;G underlayment grade plywood glued over the sound board. The ceiling is 5/8" fire-resistive type gypsum board on resilient channels; absorptive material is 3-inch thick glass fiber batts</p>	6	Wood block (3/8") laminated to underlayment
	7	Carpet and pad
	8	Vinyl flooring laminated to underlayment applied over sound board with 4-inch circular globs of glue
	9	Vinyl covering like 8 with sleepers glued between sound board and underlayment
	10	Oak strip flooring (2 5/32") nailed to 2x3 sleepers glued over sound board strips 1 7/8" glass fiber between sleepers
	11	Vinyl flooring (0.07") on 5/8" T&G plywood underlayment glued to 2x2 sleepers glued to subfloor 16" o.c. Sand fill over subfloor to depth of sleepers (1 1/2"). Balance as in basic construction
<p><b>conventional</b> With lightweight Concrete or Gypsum Cement Added</p> <p>FLOOR NO. 14</p> <p>The basic construction is illustrated by floor No. 14. The floor topping is 1 1/2" thick cellular (foamed) concrete (100 p.c.f.). Ceilings are fire-resistive type gypsum board on resilient channels, 24 inches o.c. Absorptive material is 3" thick mineral wool batts. Floor coverings for impact tests are 44-ounce carpet over 40-ounce hair pad or vinyl floor covering, approximately 0.07 inches thick. Note variations from basic construction drawn in plans 12-16.</p>	12	Ceiling nailed to joists; no absorptive material; with carpet and pad.....
	13	Ceiling nailed to joists; 3" glass fiber with carpet and pad.....
	14	<b>Basic construction</b> —(no floor covering) with carpet and pad.....
	15	Add 1/2" sound board between concrete and subfloor with vinyl tile..... with carpet and pad.....
	16	Basic construction—but with 3/4" thick gypsum concrete in place of 1 1/2" thick cellular concrete; 1/2" gypsum ceiling without floor covering.....

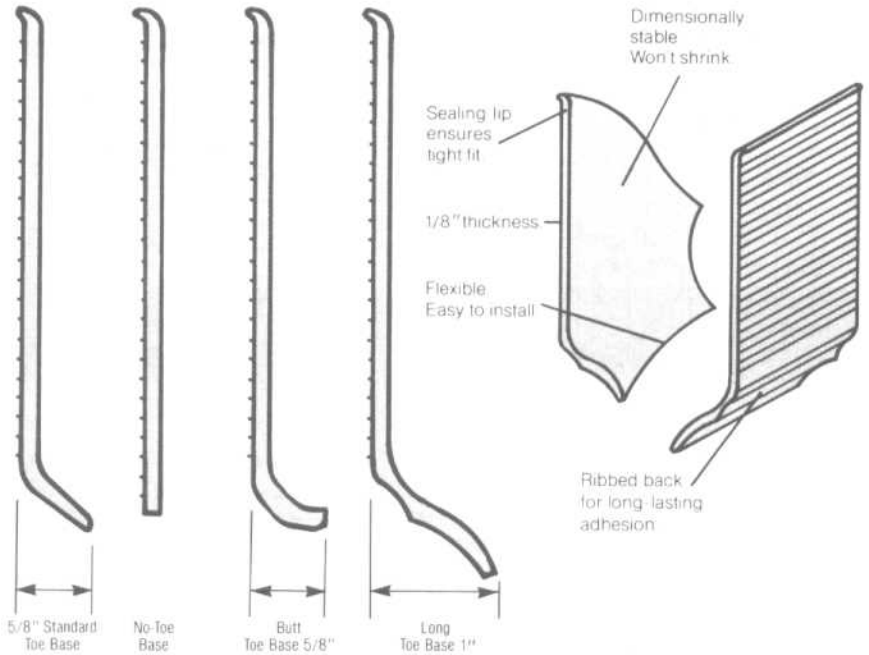
The improved resistance to airborne sound transmission gained by isolating the ceiling with resilient channels and adding absorptive material is evident by comparing floors 2 to 5 with No. 1. A 10-point increase in STC reduces the loudness of transmitted noise by one-half. Improved resistance to impact noise transmission is gained by adding carpet and pad as is evident by comparing floor No. 3 with No. 2 or floor No. 5 with 4. An IIC of 51 is often recommended as an acceptable level of impact insulation.

**Standard toe base**

**No-toe base:** Adds a decorative touch to carpeted interiors.

**Butt toe base:** Engineered to butt precisely to 1/8" floor coverings.

**Long toe base:** For special applications. Features a longer toe extending 1" to cover wide irregularities between floor and wall.



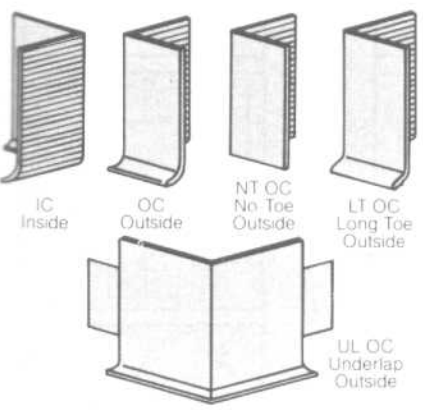
**TABLE 1 Cove Base Specifications**

Type	Sizes available
Standard toe base	2 1/2" 4" 6"
No-toe base	2 1/2" 4" 6"
Butt toe base	4" 6"
Long toe base	4"

Length: 48"

**TABLE 2 Corner Specifications**

Type	Length of return	Sizes available
Inside/outside	2 1/4"	2 1/2" 4" 6"
Underlap outside	3" (with underlap)	4"
No-toe outside	2 1/4"	2 1/2" 4"
Long toe outside	2 1/4"	4"



FLOORS AND FLOOR FINISHES

Ceramic Tile Patterns

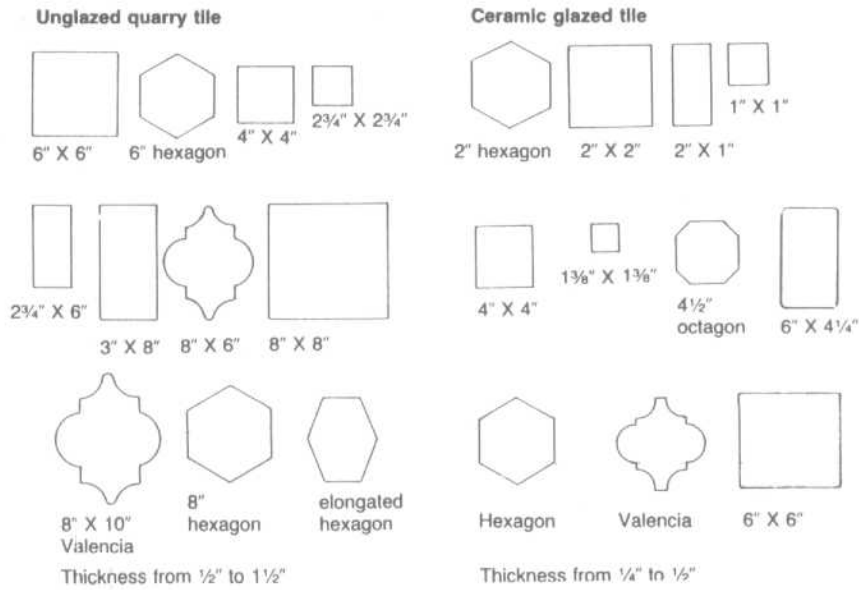


Fig. 10 Ceramic tile shapes.

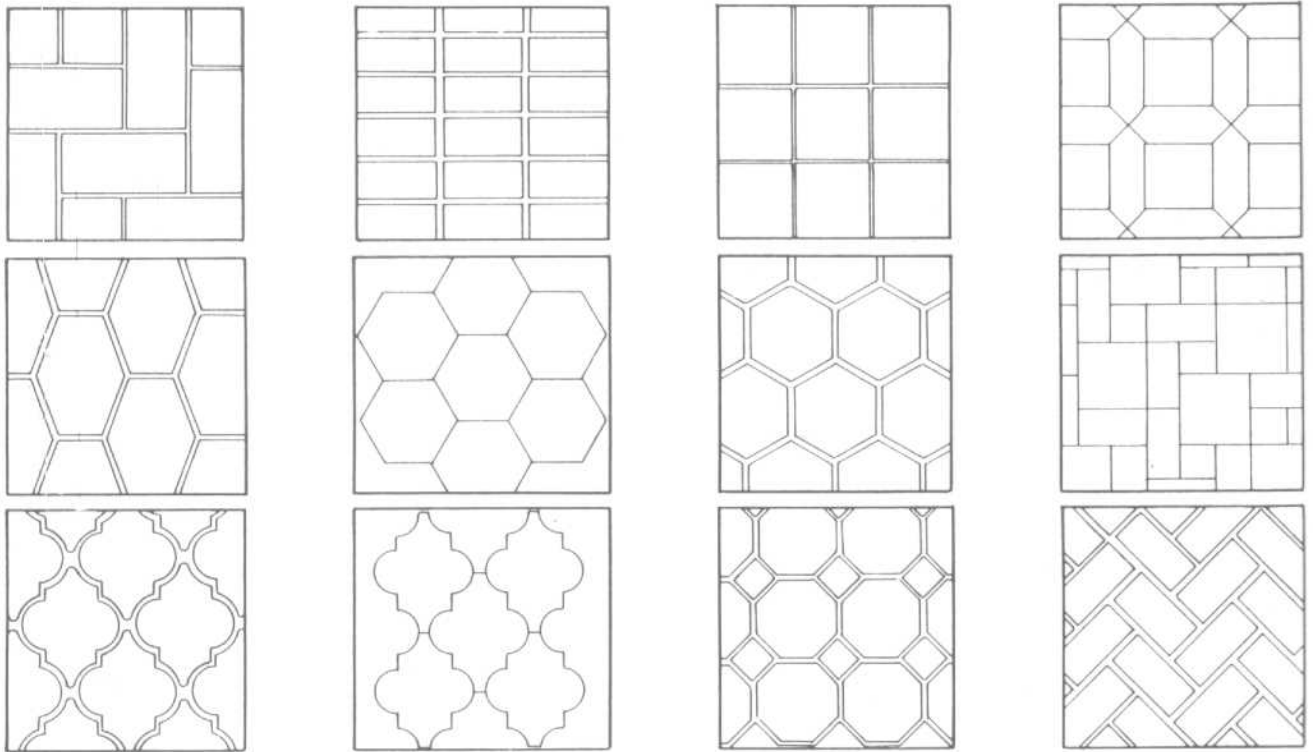
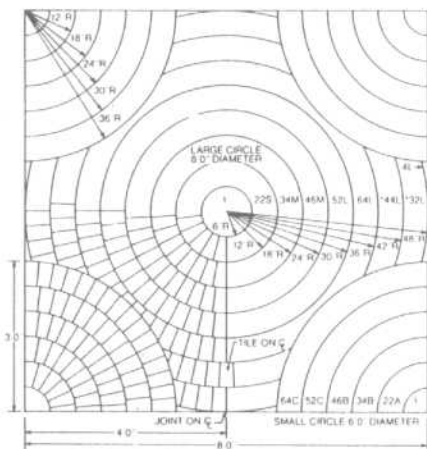
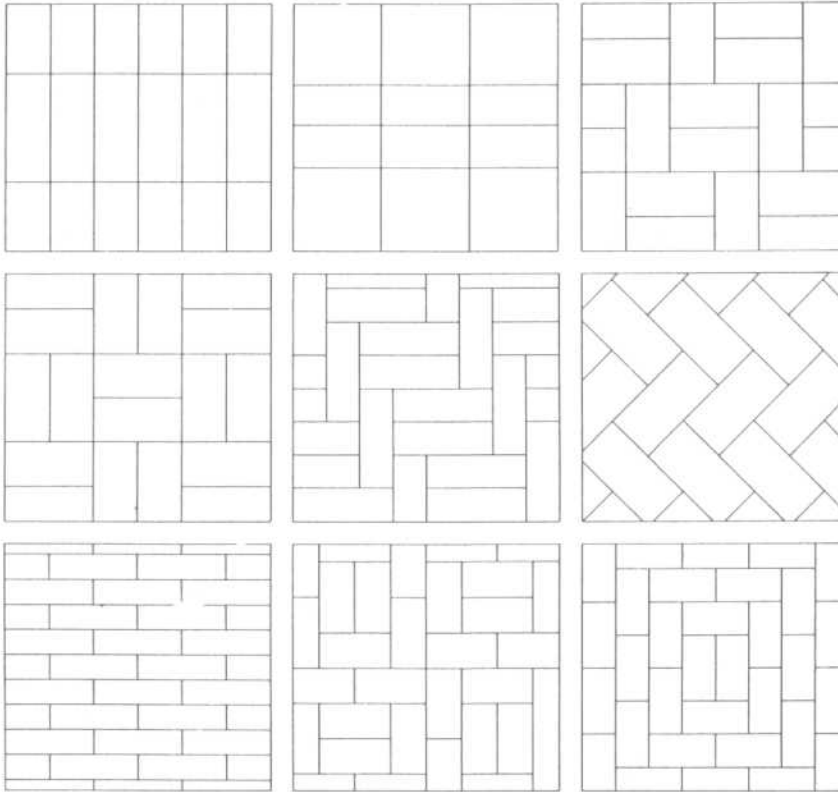
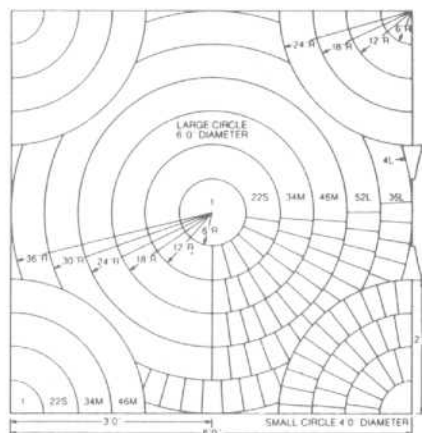
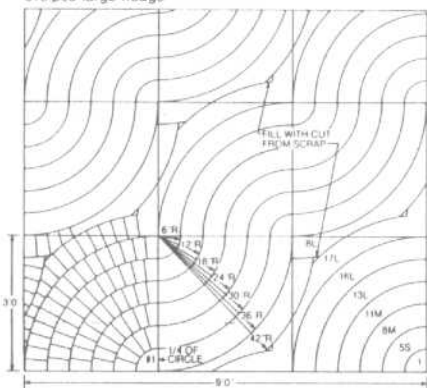


Fig. 11 Ceramic tile patterns.



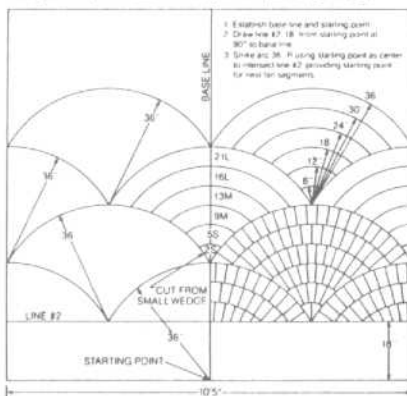
**Serpentine Circles (8 Ft. Module)** Quantity for 100 sq. feet: 3.2 pcs circle, 70 pcs small wedge, 256 pcs medium wedge, 500 pcs large wedge

**Meandering Serpentine** Quantity for 100 sq. feet: 3 pcs circle, 58 pcs small wedge, 220 pcs medium wedge, 610 pcs large wedge



**Serpentine Circles (6 Ft. Module)** Quantity for 100 sq. feet: 5.7 pcs circle, 126 pcs small wedge, 460 pcs medium wedge, 280 pcs large wedge

**Serpentine Fan** Quantity for 100 sq. feet: 106 pcs small wedge, 290 pcs medium wedge, 484 pcs large wedge



FLOORS AND FLOOR FINISHES

Ceramic Tile Patterns

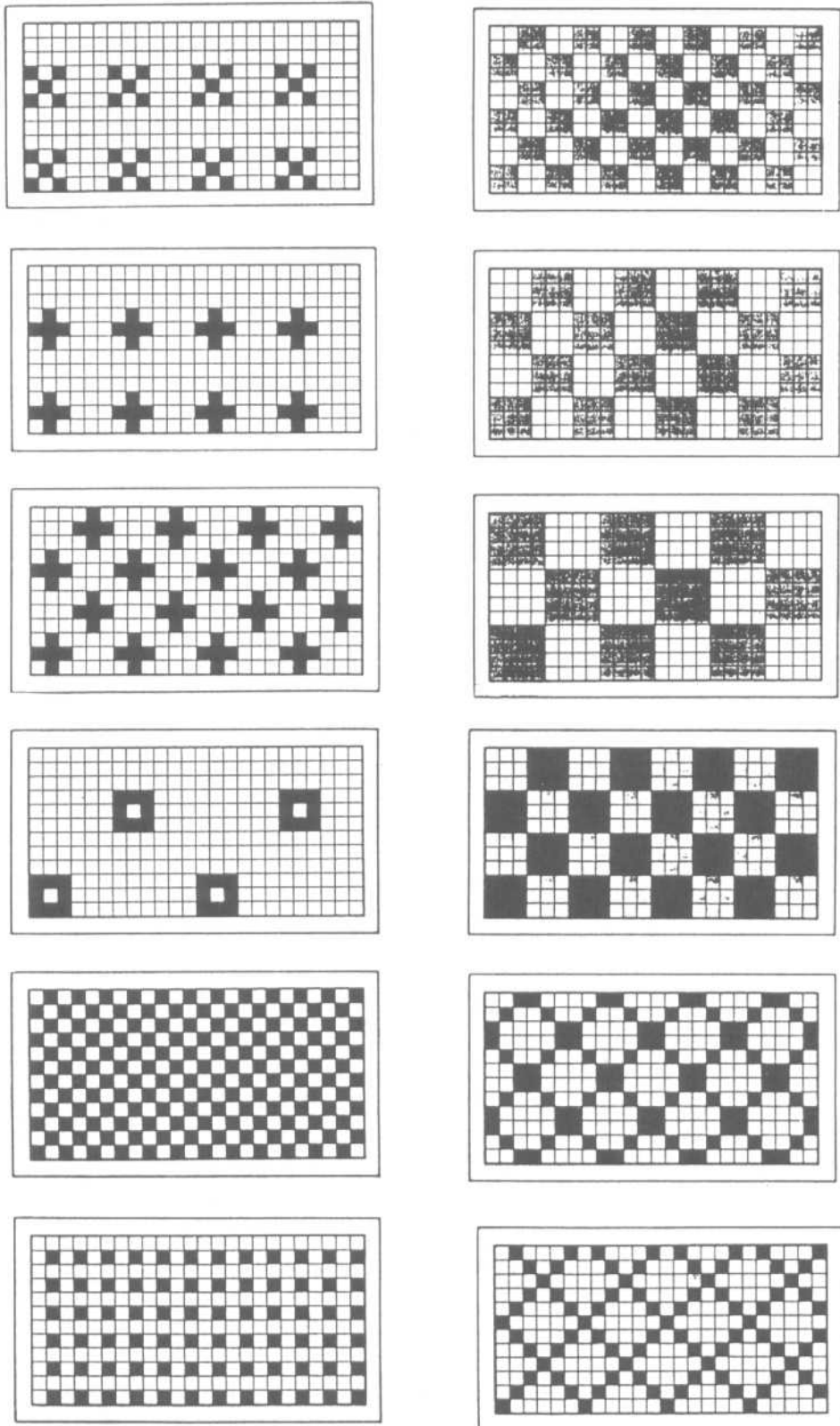


Fig. 12 1x1 overall patterns.

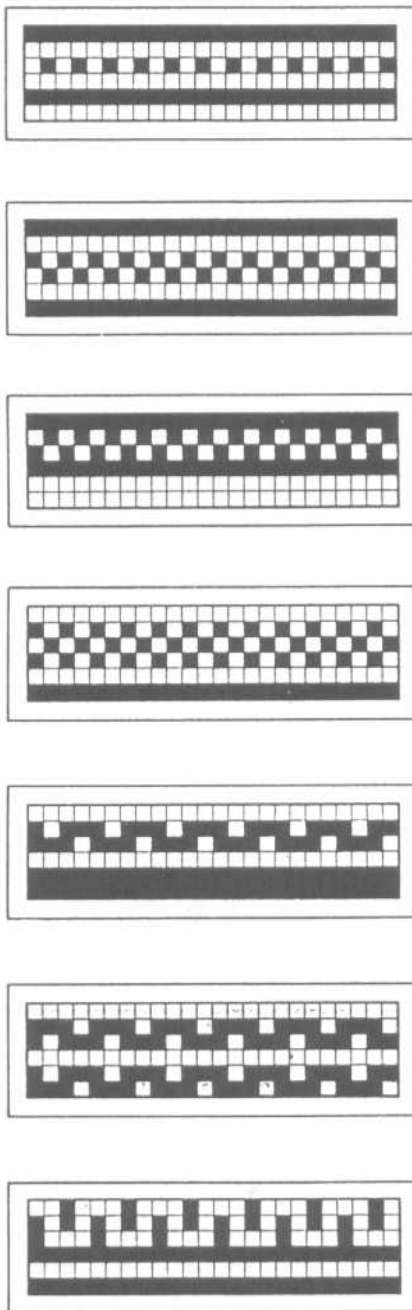


Fig. 13 1×1 six-inch borders.

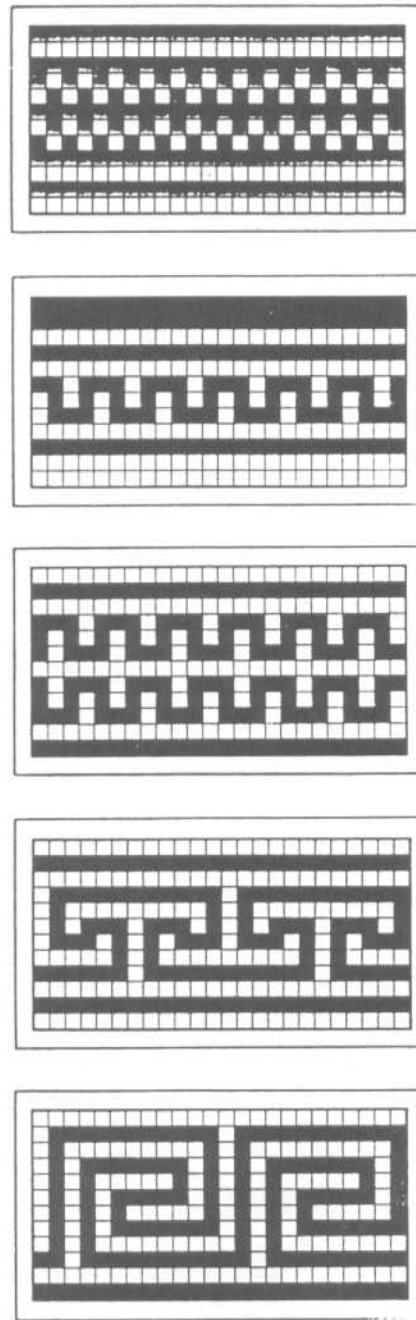


Fig. 14 1×1 twelve-inch borders.

FLOORS AND FLOOR FINISHES

Ceramic Tile Patterns

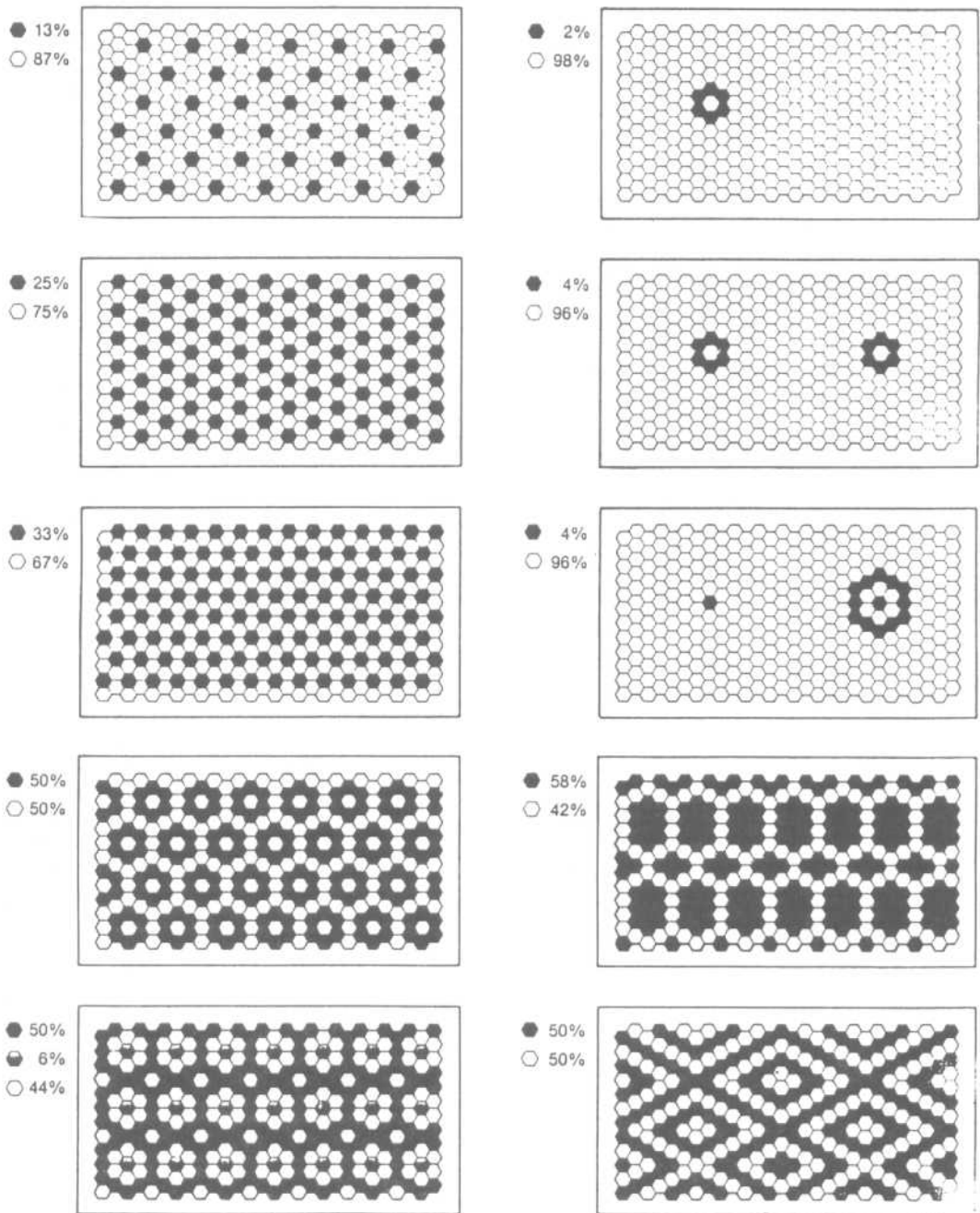
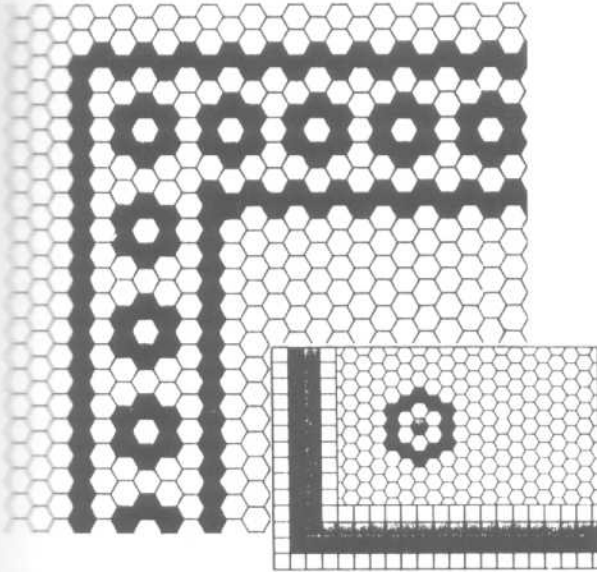


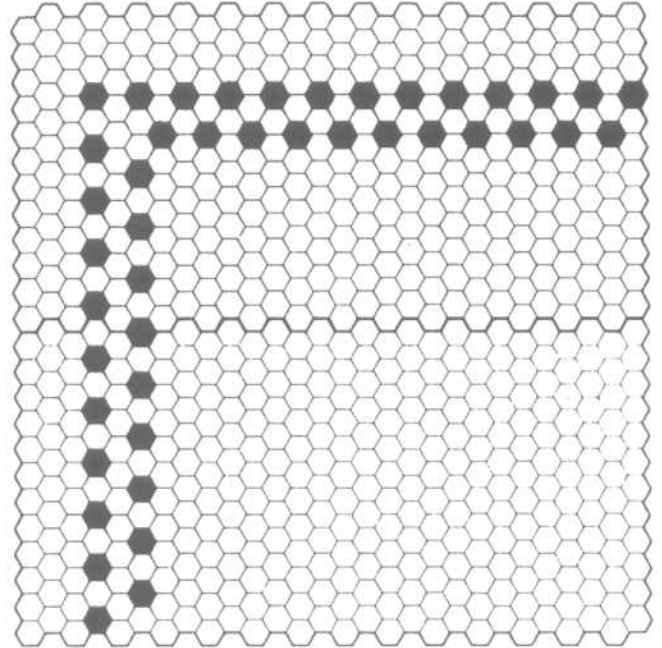
Fig. 15 1" hex overall patterns. All patterns master-set 12" x 24" sheets.



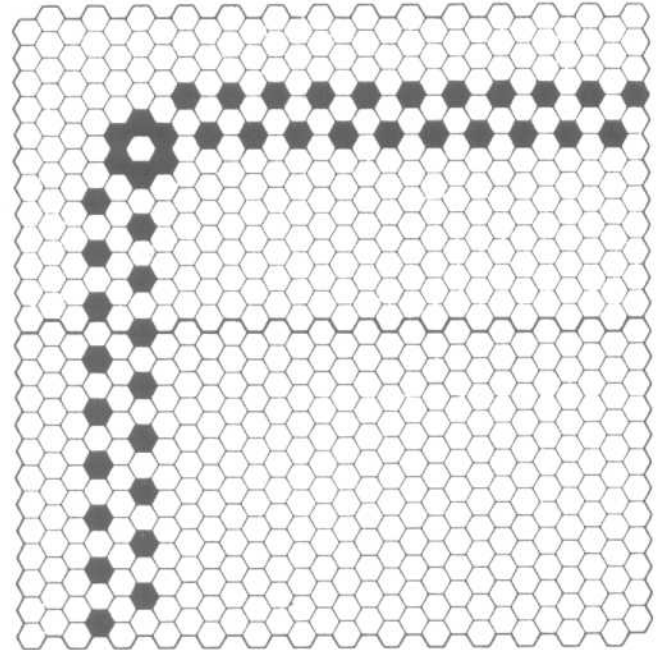
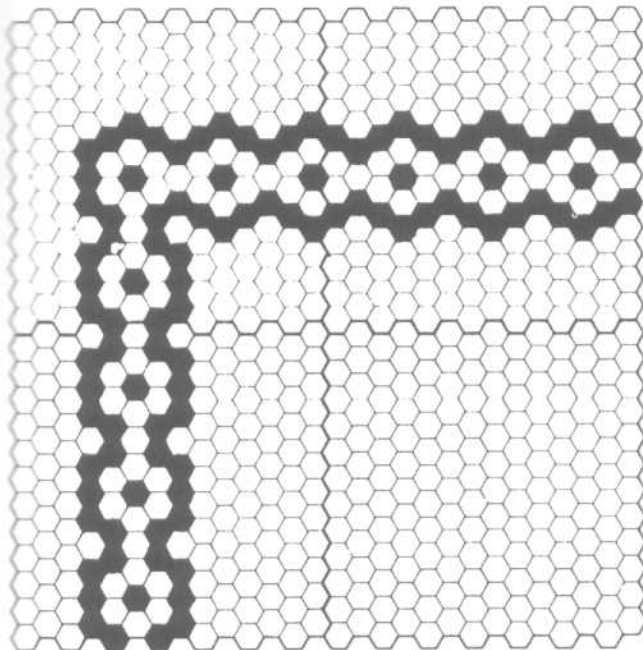


1" Square Border with  
Hexagon Field

Due to the complexity of mounting 1" Hexagon border pattern corners which require a number of special sheets on smaller jobs, a premium charge is made. To avoid this, it is suggested that on smaller jobs the border be formed using 1" squares with a hexagon field.



If a Hexagon border is required, you must provide a plan of the area with dimensions because the Hexagon configuration precludes interchanging sheets. We will provide specific sheets for those areas and setting plans.

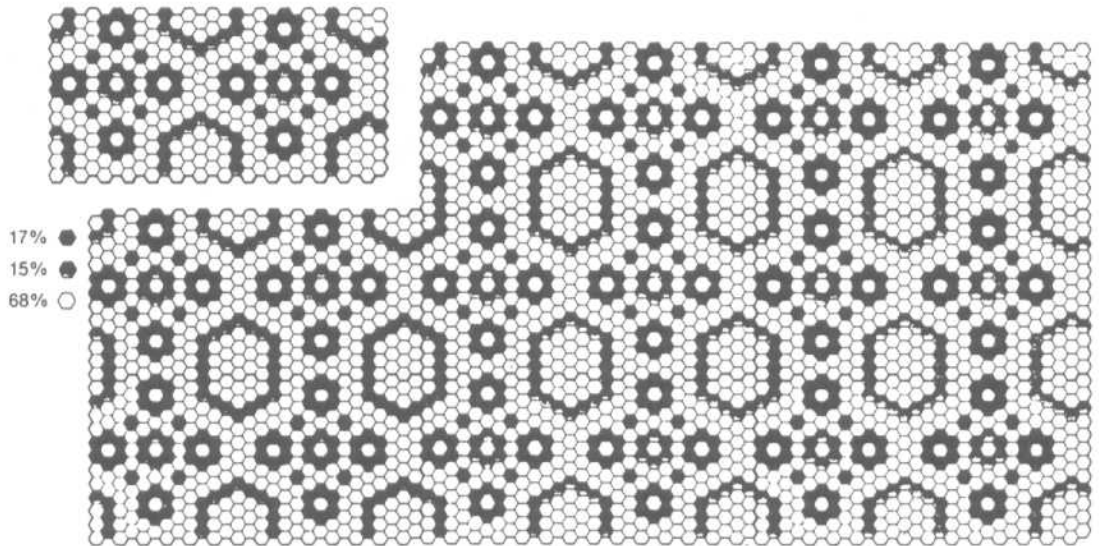


Note that on three of these border patterns a full sheet is used for the corner. Some designs, however, will require a half sheet for the corner as shown in SB-1404. In this case a right and left corner will be on one sheet and the sheet is cut in half before placement.

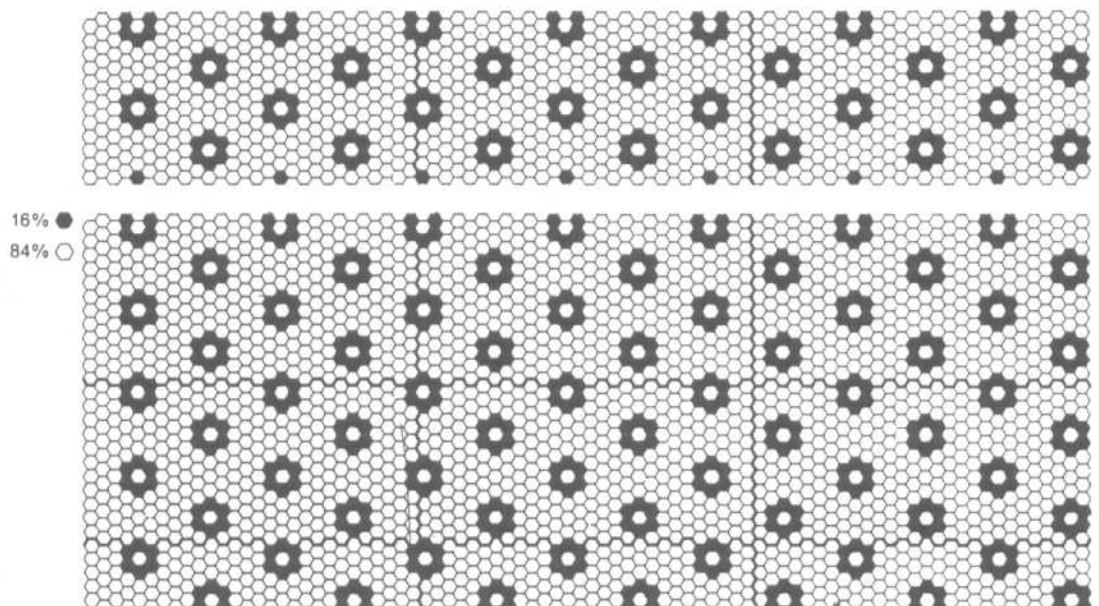
Fig. 16 1" hex border patterns. All patterns master-set 12" x 24" sheets.

FLOORS AND FLOOR FINISHES

Ceramic Tile Patterns



Single sheet repeat pattern. Repeat for overall pattern.

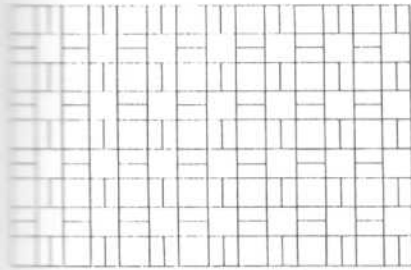


Three sheet repeat pattern. Three different sheets complete the pattern, then repeat throughout.

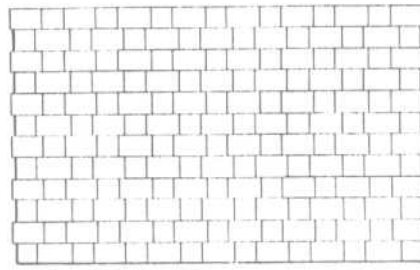
Fig. 17 1" hex overall patterns. All patterns master-set 12" x 24" sheets.

FLOORS AND FLOOR FINISHES

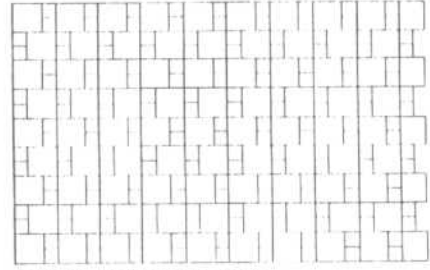
Basic Quarry Tile Patterns



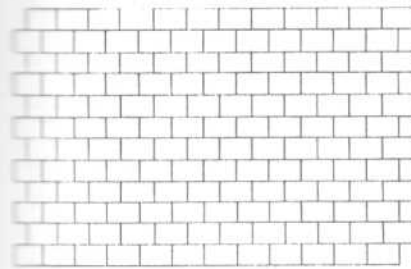
QP-6101 ALTERNATING CHECKERBOARD  
Shown: 3 1/2" x 8" (50%), 8" x 8" (50%)



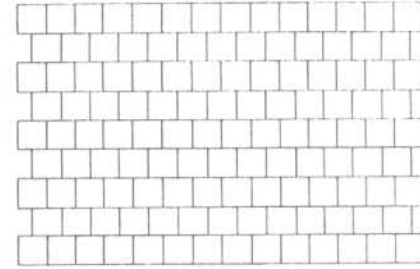
QP-6102 FLEMISH BOND  
Shown: 6" x 6" (40%), 6" x 9" (60%)  
Also Use: 3 1/2" x 3 1/2", 3 1/2" x 8", or 6" x 6", 6" x 12 1/2"



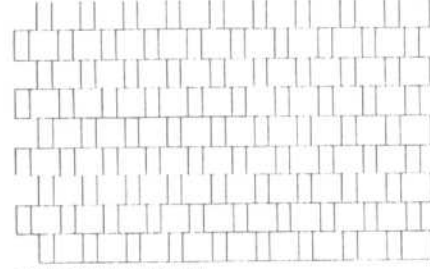
QP-6103 FLEMISH SQUARE BOND  
Shown: 3 1/2" x 3 1/2" (33 1/3%), 8" x 8" (66 2/3%)



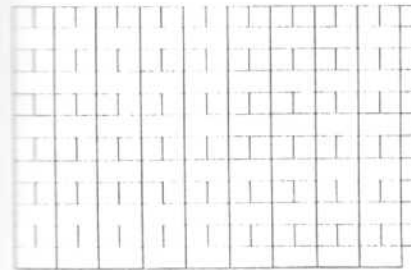
QP-6104 BROKEN JOINT  
Shown: 6" x 9" (100%)  
Also Use: 3 1/2" x 8" or 6" x 12 1/2"



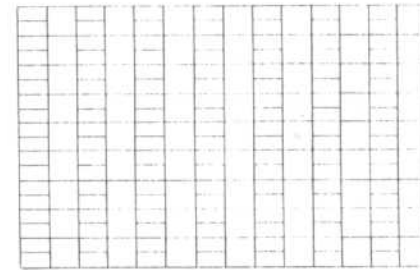
QP-6105 BROKEN JOINT SQUARE  
Shown: 8" x 8" (100%)  
Also Use: 6" x 6"



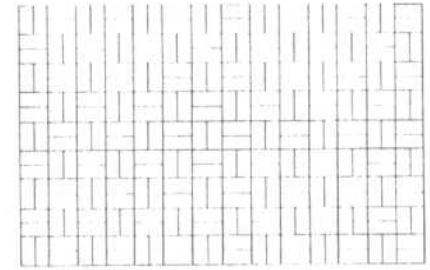
QP-6106 BARRED SQUARE  
Shown: 3 1/2" x 8" (33 1/3%), 8" x 8" (66 2/3%)



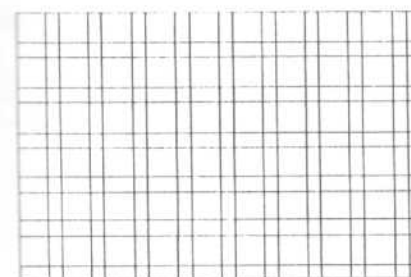
QP-6107 ALTERNATING STRIPE VARIATION  
Shown: 6" x 6" (50%), 6" x 12 1/2" (50%)  
Also Use: 3 1/2" x 3 1/2", 3 1/2" x 8"



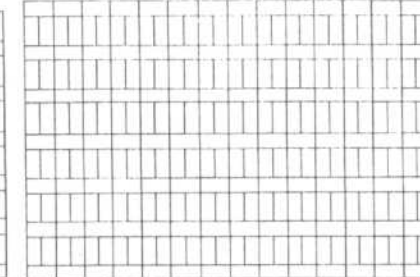
QP-6108 ALTERNATING STRIPE  
Shown: 3 1/2" x 8" (50%), 8" x 8" (50%)



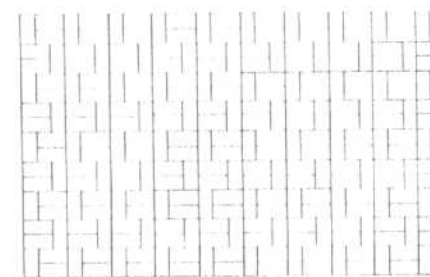
QP-6109 BASKETWEAVE  
Shown: 3 1/2" x 8" (100%)  
Also Use: 6" x 12 1/2"



QP-6110 FORMAL RANDOM  
Shown: 3 1/2" x 3 1/2" (11.2%), 3 1/2" x 8" (44.4%),  
8" x 8" (44.4%)



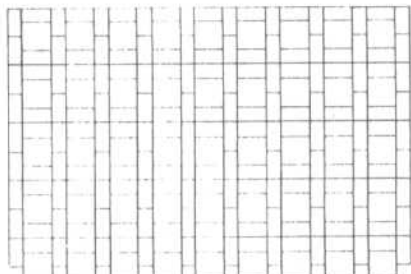
QP-6111 RAIL ROAD BOND  
Shown: 3 1/2" x 8" (100%)  
Also Use: 6" x 12 1/2"



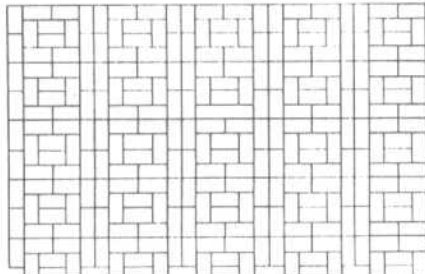
QP-6112 BASKETWEAVE VARIATION  
Shown: 3 1/2" x 8" (100%)  
Also Use: 6" x 12 1/2"

FLOORS AND FLOOR FINISHES

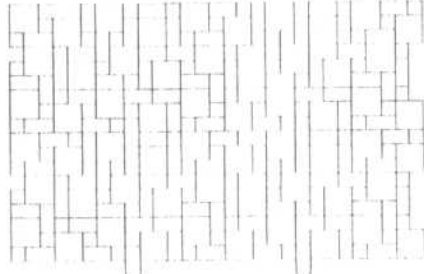
Basic Quarry Tile Patterns



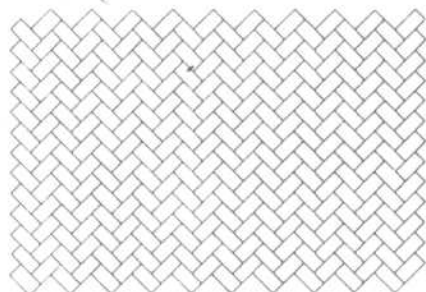
QP-6221 SPIRAL  
Shown:  $3\frac{1}{2}'' \times 8''$  (66 $\frac{2}{3}\%$ ),  $8'' \times 8''$  (33 $\frac{1}{3}\%$ )



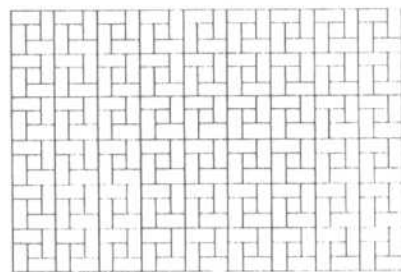
QP-6222 INTERLOCKING SPIRAL  
Shown:  $3\frac{1}{2}'' \times 8''$  (100%)  
Also Use:  $6'' \times 12\frac{1}{2}''$



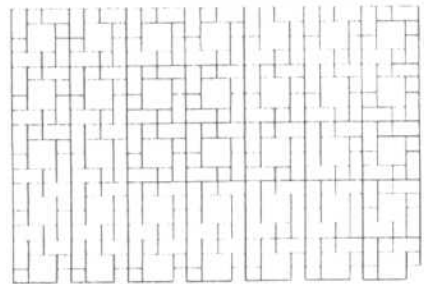
QP-6223 BLOCK RANDOM  
Shown:  $3\frac{1}{2}'' \times 3\frac{1}{2}''$  (15%),  $3\frac{1}{2}'' \times 8''$  (41%),  
 $8'' \times 8''$  (44%)



QP-6224 VERTICAL HERRINGBONE  
Shown:  $3\frac{1}{2}'' \times 8''$  (100%)  
Also Use:  $6'' \times 12\frac{1}{2}''$



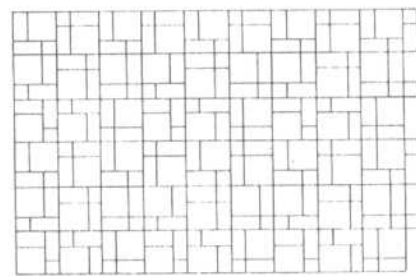
QP-6225 PINWHEEL  
Shown:  $3\frac{1}{2}'' \times 3\frac{1}{2}''$  (11.1%),  $3\frac{1}{2}'' \times 8''$  (88.9%)  
Also Use:  $6'' \times 6''$ ,  $6'' \times 12\frac{1}{2}''$



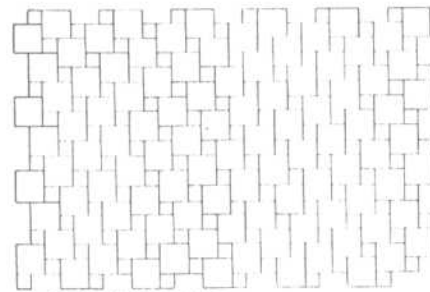
QP-6226 BLOCK RANDOM SQUARE  
Shown:  $3\frac{1}{2}'' \times 3\frac{1}{2}''$  (125%),  $3\frac{1}{2}'' \times 8''$  (50%),  
 $8'' \times 8''$  (25%)



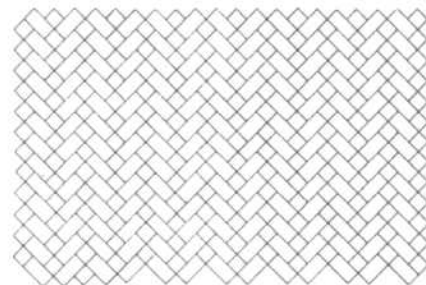
QP-6227 DOUBLE HERRINGBONE  
Shown:  $3\frac{1}{2}'' \times 8''$  (100%)  
Also Use:  $6'' \times 12\frac{1}{2}''$



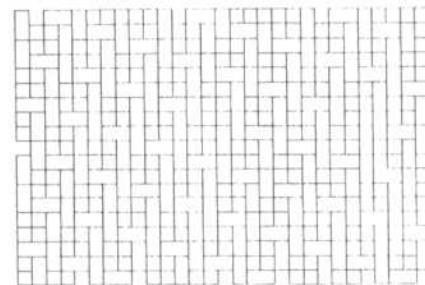
QP-6228 BLOCK RANDOM VARIATION  
Shown:  $3\frac{1}{2}'' \times 3\frac{1}{2}''$  (11.2%),  $3\frac{1}{2}'' \times 8''$  (44.4%),  
 $8'' \times 8''$  (44.4%)



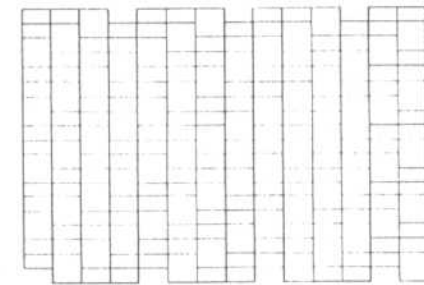
QP-6229 RANDOM SQUARE  
Shown:  $3\frac{1}{2}'' \times 3\frac{1}{2}''$  (19 $\frac{1}{2}\%$ ),  $8'' \times 8''$  (80 $\frac{1}{2}\%$ )



QP-6230 DIAMOND HERRINGBONE  
Shown:  $3\frac{1}{2}'' \times 3\frac{1}{2}''$  (33 $\frac{1}{3}\%$ ),  $3\frac{1}{2}'' \times 8''$  (66 $\frac{2}{3}\%$ )  
Also Use:  $8'' \times 6''$ ,  $6'' \times 12\frac{1}{2}''$



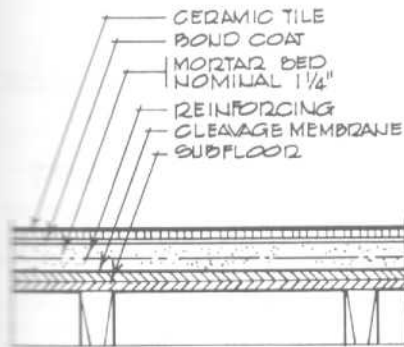
QP-6231 RAMBLING SQUARES  
Shown:  $3\frac{1}{2}'' \times 3\frac{1}{2}''$  (40%),  $3\frac{1}{2}'' \times 8''$  (60%)  
Also Use:  $6'' \times 6''$ ,  $6'' \times 12\frac{1}{2}''$



QP-6232 DIAGONAL STRIPE  
Shown:  $3\frac{1}{2}'' \times 8''$  (50%),  $8'' \times 8''$  (50%)

FLOORS

Cement Mortar

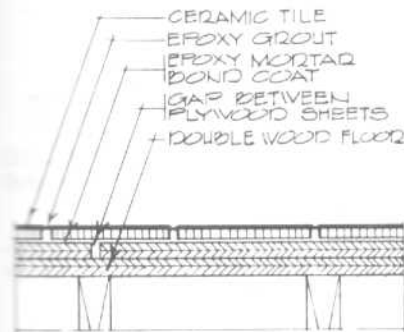


Recommended use

- over all wood floors that are structurally sound

Wood Subfloor

Epoxy Mortar and Grout

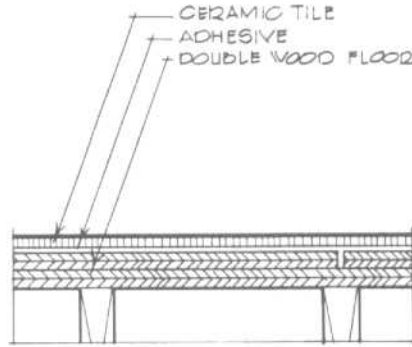


Recommended uses

- over wood floors where resistance to foot traffic in better residential, normal commercial, and light institutional use is desired with thin-set construction
- where water, chemical, and stain resistance is desired
- for tilework exposed to prolonged high temperatures, use high temperature, chemical resistant epoxy mortar, and grout

Wood Subfloor

Organic Adhesive

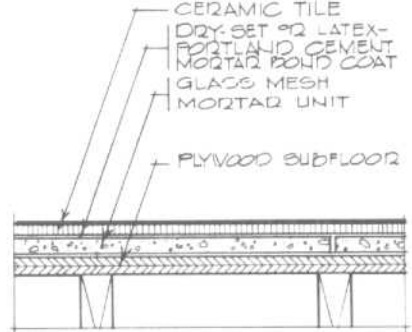


Recommended use

- over wood floors exposed to residential traffic only

Glass Mesh Mortar Units

Dry-Set Mortar or Latex-Portland Cement

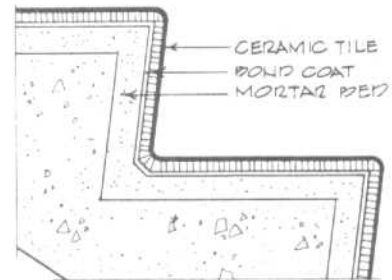


Recommended uses

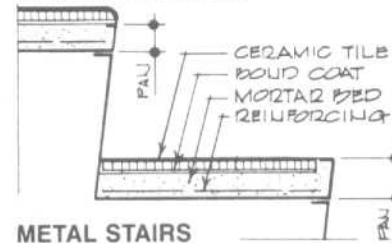
- over structurally sound plywood where lightweight construction is a factor
- where water resistance is desired
- eliminates necessity of recessing subfloor to accommodate portland cement mortar bed

STAIRS

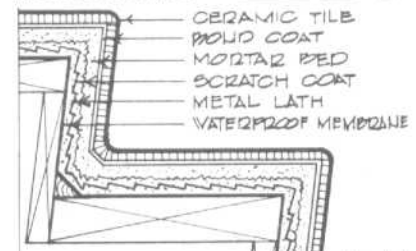
Cement Mortar



CONCRETE STAIRS

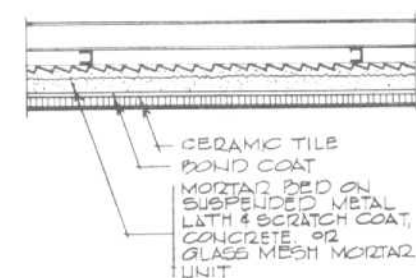


METAL STAIRS



WOOD STAIRS

CEILINGS, SOFFITS



Recommended uses

- over a mortar bed
- over glass mesh mortar units
- over clean, sound, dimensionally stable concrete
- over metal lath attached directly to the bottom of wood joists or trusses; spacing not to exceed 16" on center

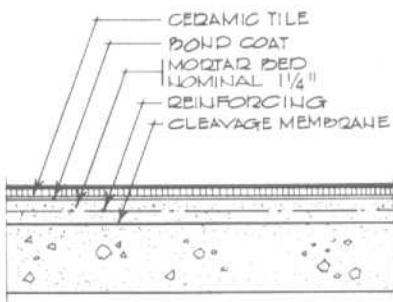


FLOORS AND FLOOR FINISHES

Ceramic Tile on Concrete Slab Floor Construction Details

CONCRETE SUBFLOOR

Cement Mortar  
Cleavage Membrane



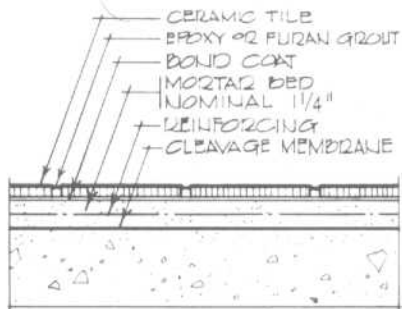
Recommended use

- over structural floors subject to bending and deflection

Requirements

- reinforcing mesh mandatory
- mortar bed thickness to be uniform, nominal 1/4" thick

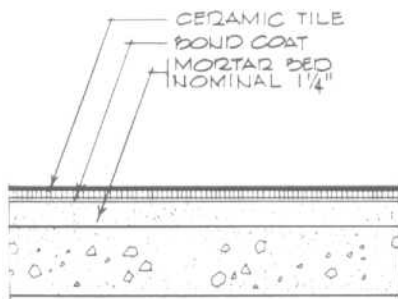
Cement Mortar  
Epoxy or Furan Grout



Recommended uses

- with tile set by Method F111 requiring good stain resistance and resistance to erosion caused by occasional contact with mild chemicals such as found in commercial dining areas, photographic dark rooms, public toilets, public foyers, etc.
- for use with quarry tile and paver tile

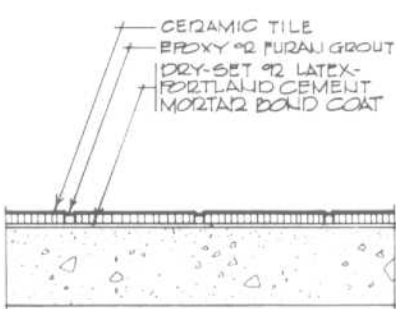
Cement Mortar,  
Bonded



Recommended uses

- on slab-on-grade construction where no bending stresses occur
- on properly cured structural slabs where deflection does not exceed 1/360 of span
- on properly cured structural slabs of limited area

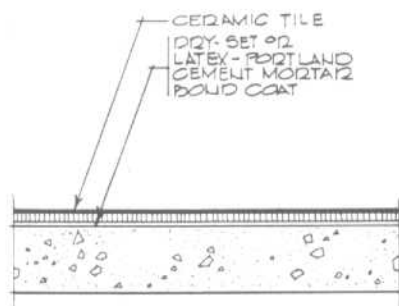
Dry-Set Mortar,  
Epoxy or Furan Grout



Recommended uses

- with tile set by Method F112 or Method F113 requiring good stain resistance and resistance to erosion caused by occasional contact with mild chemicals such as found in commercial dining areas, photographic dark rooms, public toilets, public foyers, etc.
- for use with quarry tile and paver tile

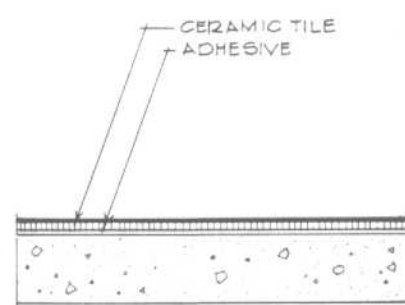
Dry-Set Mortar or  
Latex-Portland Cement Mortar



Recommended uses

- on plane, clean concrete
- on slab-on-grade construction where no bending stresses occur

Organic Adhesive or  
Epoxy Adhesive

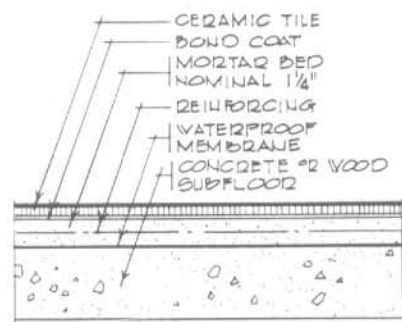


Recommended use

- for use over concrete floors in residential construction only; for heavier service select Method F113

WATERPROOF MEMBRANE

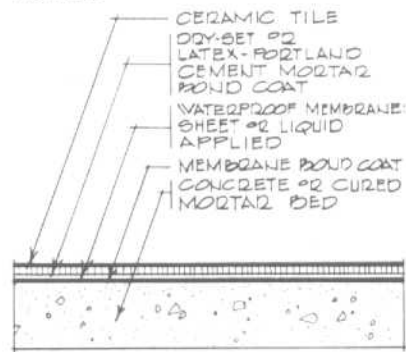
Cement Mortar Bed



Recommended use

- wherever a waterproof interior floor is required in conjunction with ceramic tile installed on a portland cement mortar bed

Thin-Set

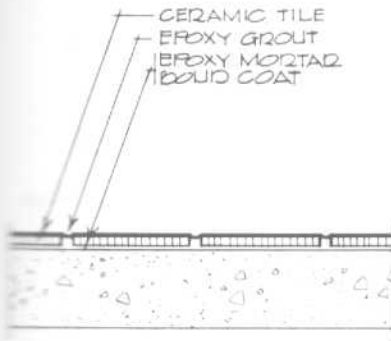


Recommended use

- wherever a waterproof interior floor is required in conjunction with ceramic tile installed in a thin-set method

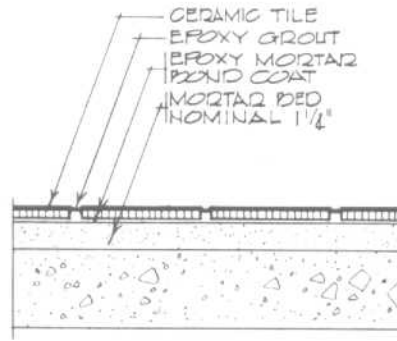
FLOORS AND FLOOR FINISHES

Ceramic Tile on Concrete Slab Floor Construction Details



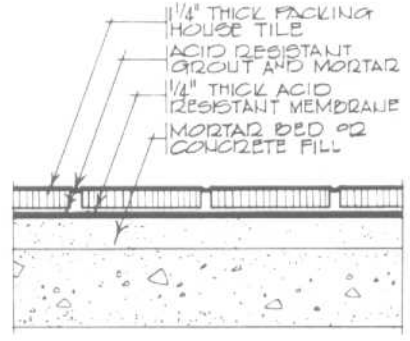
Recommended uses

- for setting and grouting ceramic mosaics, quarry tile, and paver tile
- where moderate chemical exposure and severe cleaning methods are used, such as in commercial kitchens, dairies, breweries, food processing plants, etc.
- for tilework exposed to prolonged high temperatures, use high-temperature, chemical-resistant epoxy mortar and grout



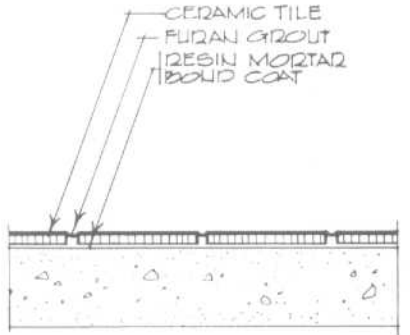
Recommended uses

- where leveling of subfloor is required
- for setting and grouting ceramic mosaics, quarry tile, and paver tile
- where moderate chemical exposure and severe cleaning methods are used, such as in commercial kitchens, dairies, breweries, food processing plants, etc.
- for tilework exposed to prolonged high temperatures, use high-temperature chemical resistant epoxy mortar and grout



Recommended use

- for setting 1/4" thick packing house tile in areas of continuous or severe chemical exposure where special protection against leakage or damage to concrete subfloor is required

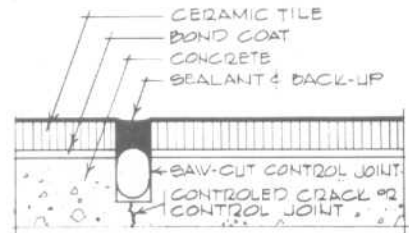
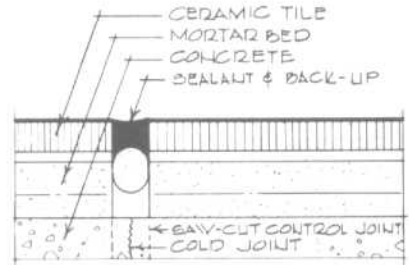
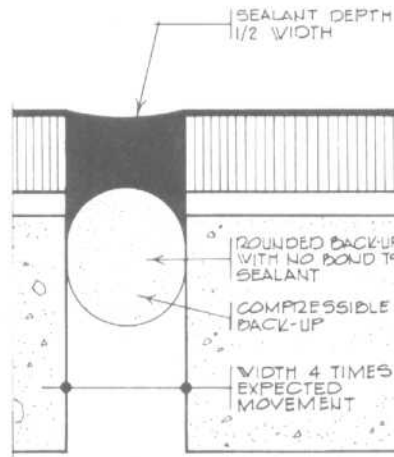
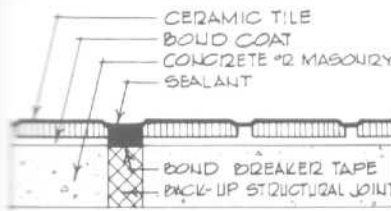
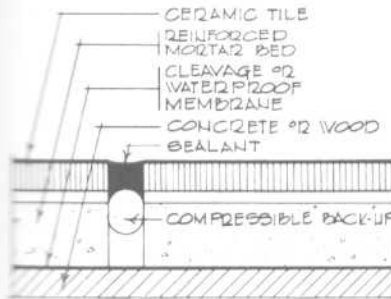


Recommended uses

- for setting and grouting quarry tile and paver tile
- in kitchens, chemical plants, etc.

EXPANSION JOINTS

Vertical and Horizontal



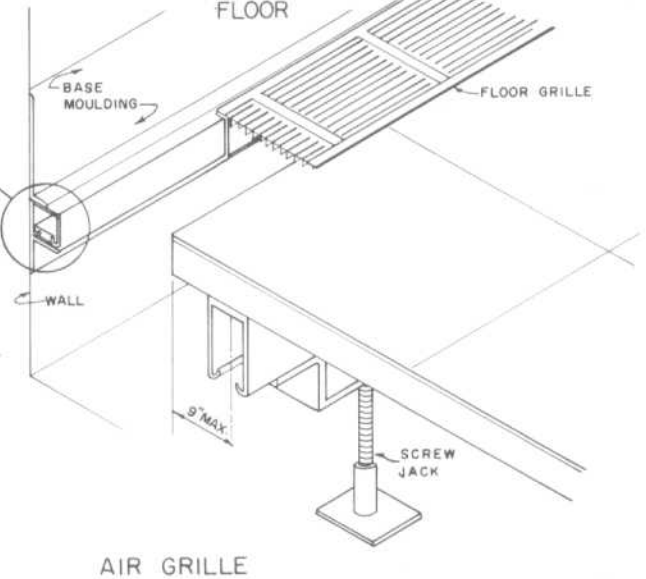
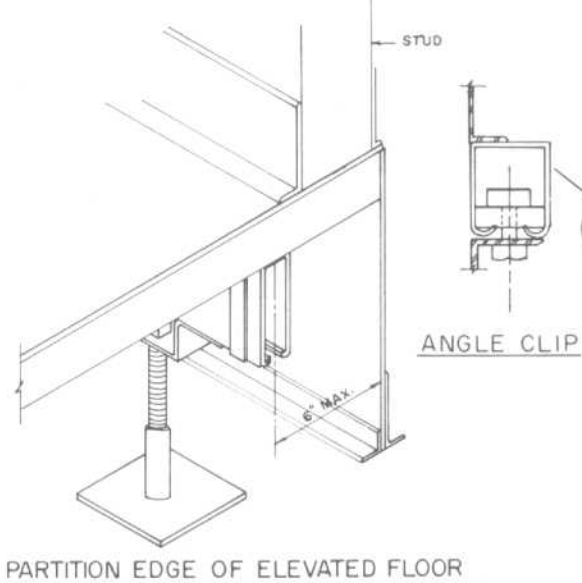
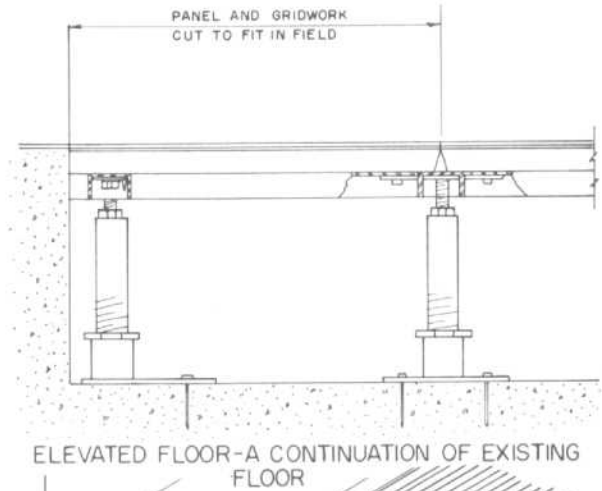
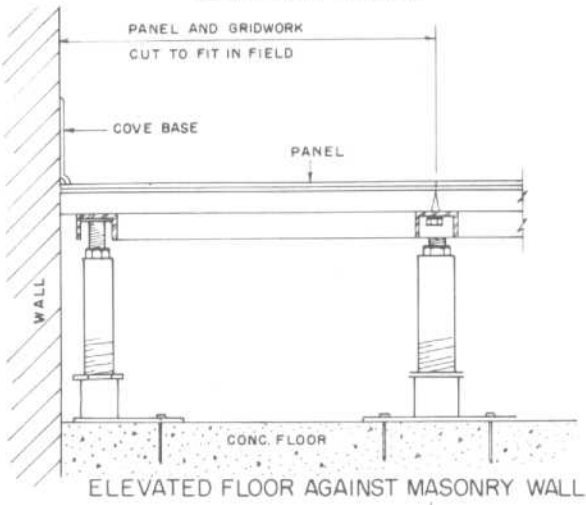
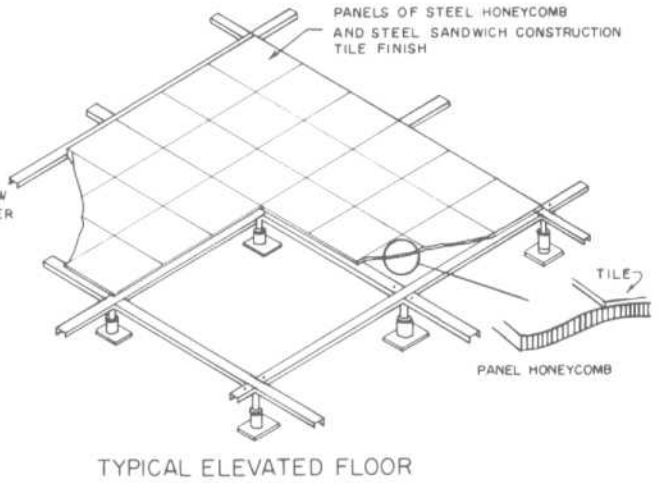
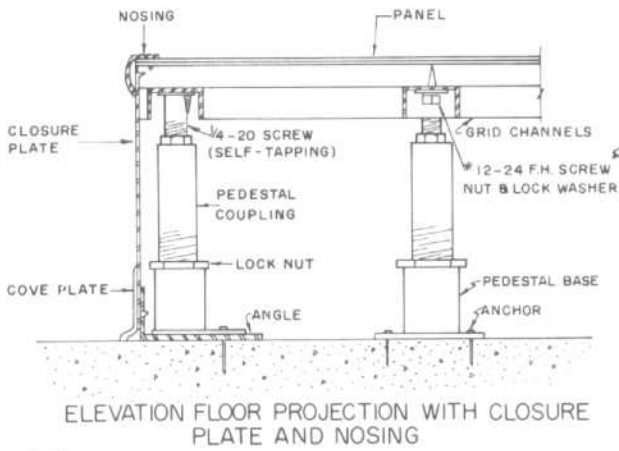
Use these details for control, contraction, and isolation joints





FLOORS AND FLOOR FINISHES

Raised Computer Room Floors



## DOORS

### Hollow Metal Door Construction

The design, specification, and detailing of a door can have serious consequences for functional considerations such as accessibility and sound transmission. The door is also one of the most important architectural elements with respect to design image and aesthetics. A door can be a major part of design expression: a monumental door to a church or synagogue, the main entrance to a residence, the doors to a corporate board room — all of these doors have symbolic importance.

Doors come in a variety of standard heights, widths, and thicknesses, yet they may also be custom designed, assume a

variety of shapes and forms, and be constructed with a variety of materials. The design, specification, and detailing of a door is, in fact, a rather complex task.

A door is typically set within a frame or jamb, but may also be installed within a wall without a frame or jamb. The frame/jamb interface between door and wall partition is another area requiring special attention by the designer.

The design of a door is never complete without the specification of hardware. Hinges, locksets, closers, stops, and thresholds are but a few of the hardware elements that a designer must consider.

This section on doors provides the designer with extensive information on door types, materials, door frames, and materials and methods of door construction and installation. Details show doors and frames installed in all types of walls and partitions, including wood and metal stud, masonry, concrete, and glass.

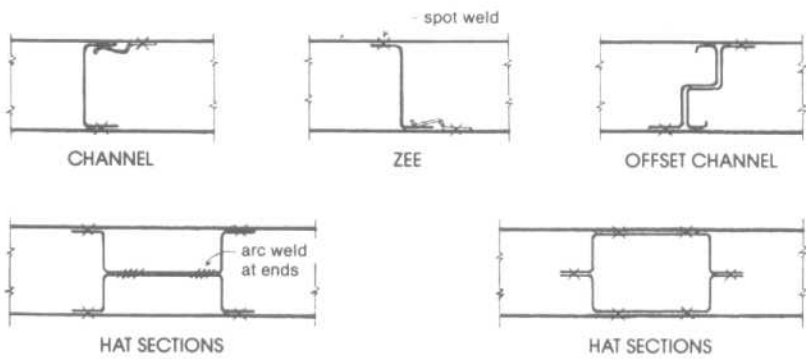
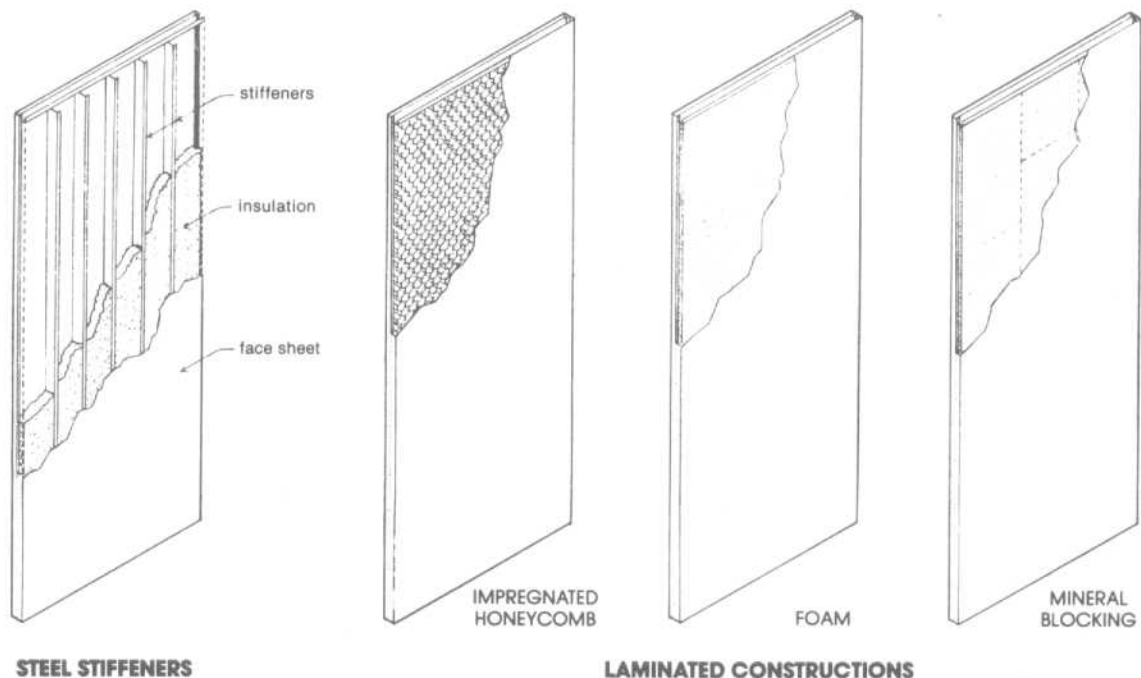
Of special interest to the designer are examples of less standard door types such as elevator doors, sliding pocket doors, and fabric-covered doors. The majority of the details in this section are taken from the actual working drawings of successfully executed projects.

### PANEL CONSTRUCTION

There are two basic types of panel construction:

*Steel stiffened:* Face sheets supported by steel stiffeners, which are channels, Z-shaped sections, hat-shaped sections, or similar members, positioned vertically. Sheets are attached to these members by spot welding.

*Laminated core:* Sandwich construction employing a core of impregnated kraft paper honeycomb, plastic foam, or structural mineral blocking, to which the steel face sheets are laminated, using a structural adhesive.



**REPRESENTATIVE STIFFENER SECTIONS**  
Other sections used by some manufacturers

**Types of Construction**

The four basic types of construction for hollow metal swing doors are illustrated and identified in Fig. 1. The type usually specified in commercial work is the continuously welded edge seam construction, Type A, and it is this type which is the basis of NAAMM Standard HMMA 861.

Most custom hollow metal doors are of the full flush type with continuously welded edges (Type A). When glazed openings, recessed panels, or louvers are to be provided, they are built into the door during fabrication, rather than being cut out of a flush panel door by field modification.

Fire-rated doors may differ in certain details of construction; see NAAMM Standard HMMA 850, Fire-Rated Hollow Metal Doors and Frames.

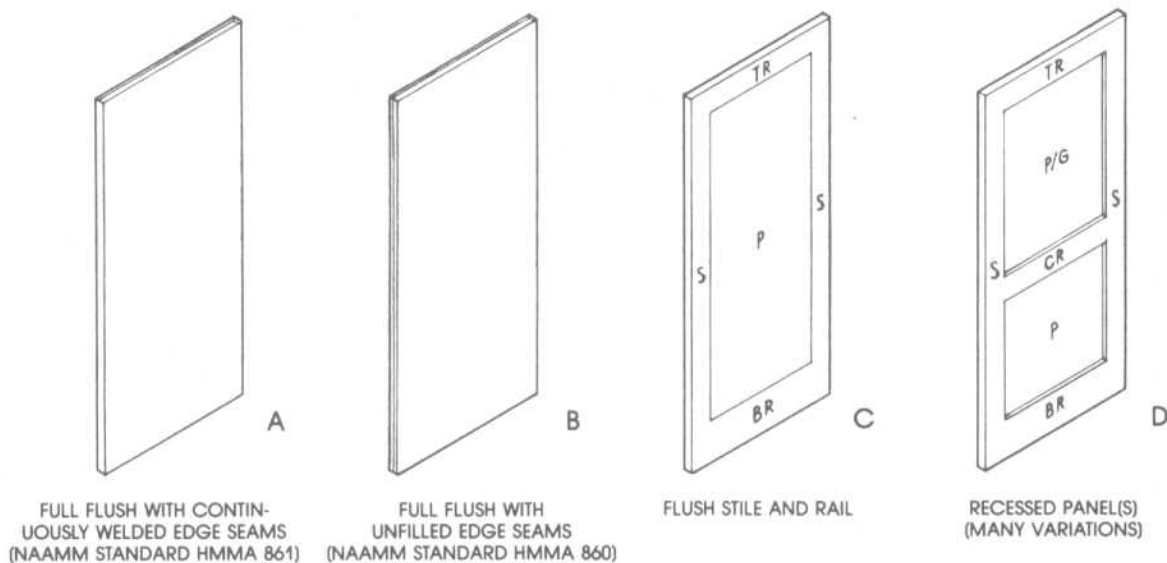
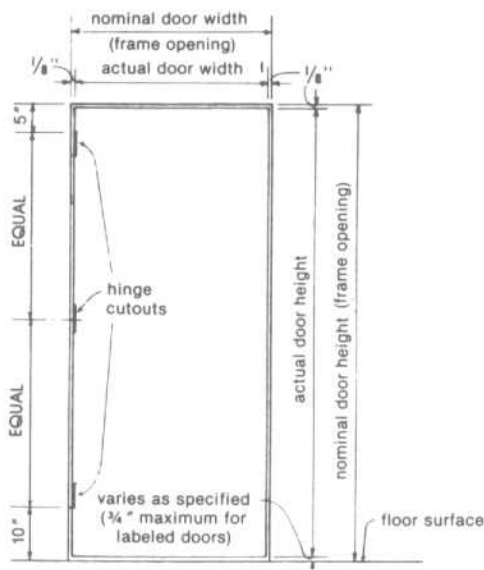


Fig. 1 The top edge of Types A and B doors may have only an inverted channel (standard construction) or may have an additional closing channel. Types C and D have tubular rails and stiles, with no edge seams. S = stile (hinge stile is stile at edge where hinges or pivots are located; lock stile is stile in which a lock or latch is installed; and meeting stile is stile adjacent to another door, in a pair of doors). TR = top rail. CR = center rail. BR = bottom rail. P = panel. P/G = panel or glass.

DOORS

Hollow Metal Door Types



**DIMENSIONS AND HINGE LOCATIONS**

Hinge locations shown represent the industry standard, but may be altered to suit requirements.

**MOST COMMON SIZES FOR 1/4-INCH THICK DOORS\***

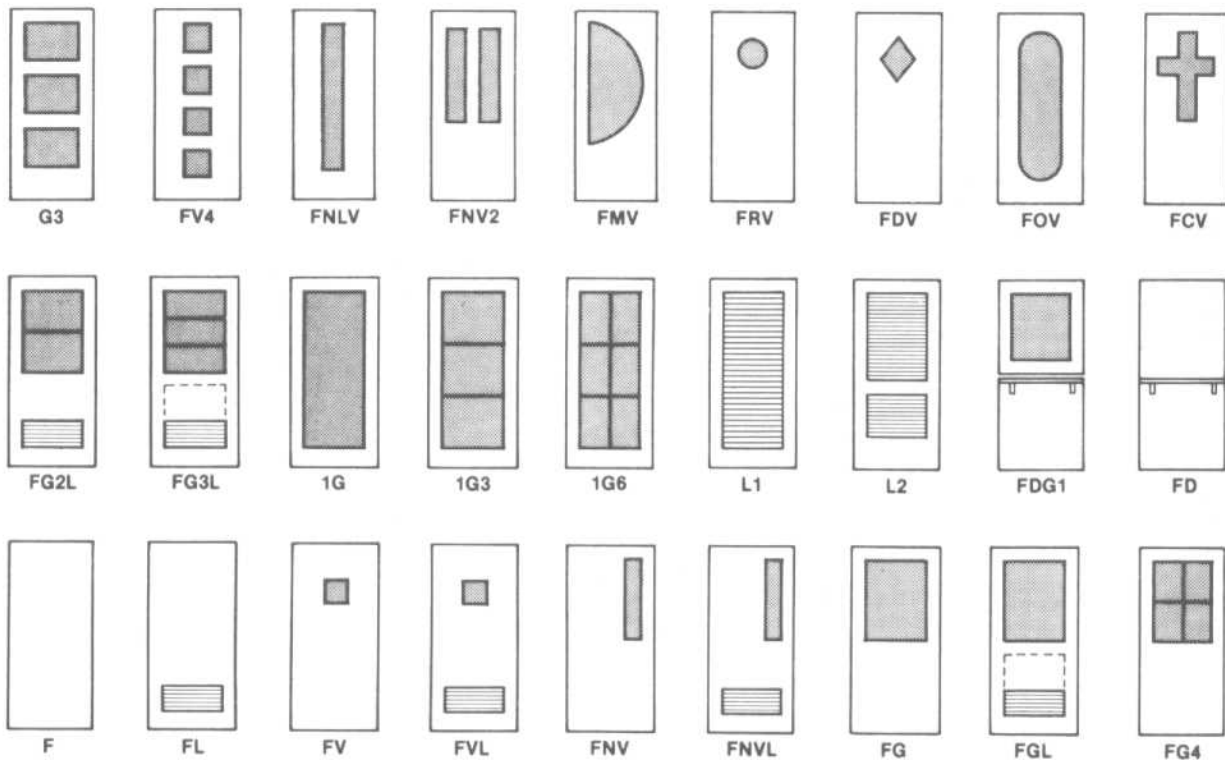
Width of Opening	Height of Opening				
2'0"	6'8"	7'0"	7'2"	7'10"	8'0"
2'4"	6'8"	7'0"	7'2"	7'10"	8'0"
2'6"	6'8"	7'0"	7'2"	7'10"	8'0"
2'8"	6'8"	7'0"	7'2"	7'10"	8'0"
3'0"	6'8"	7'0"	7'2"	7'10"	8'0"
3'4"	6'8"	7'0"	7'2"	7'10"	8'0"
3'6"	6'8"	7'0"	7'2"	7'10"	8'0"
3'8"	6'8"	7'0"	7'2"	7'10"	8'0"
4'0"	6'8"	7'0"	7'2"	7'10"	8'0"

\*Sizes shown are for single doors only; for pairs of doors, use twice the width indicated.

**OTHER DOOR SIZES:** The sizes listed are those most commonly used, but custom hollow metal doors are available in any width, height and thickness desired. It is not uncommon to supply them in widths of 5' or more and/or heights of 10' or more. Standard doors, on the other hand, are generally available from inventory only in the most commonly used sizes.

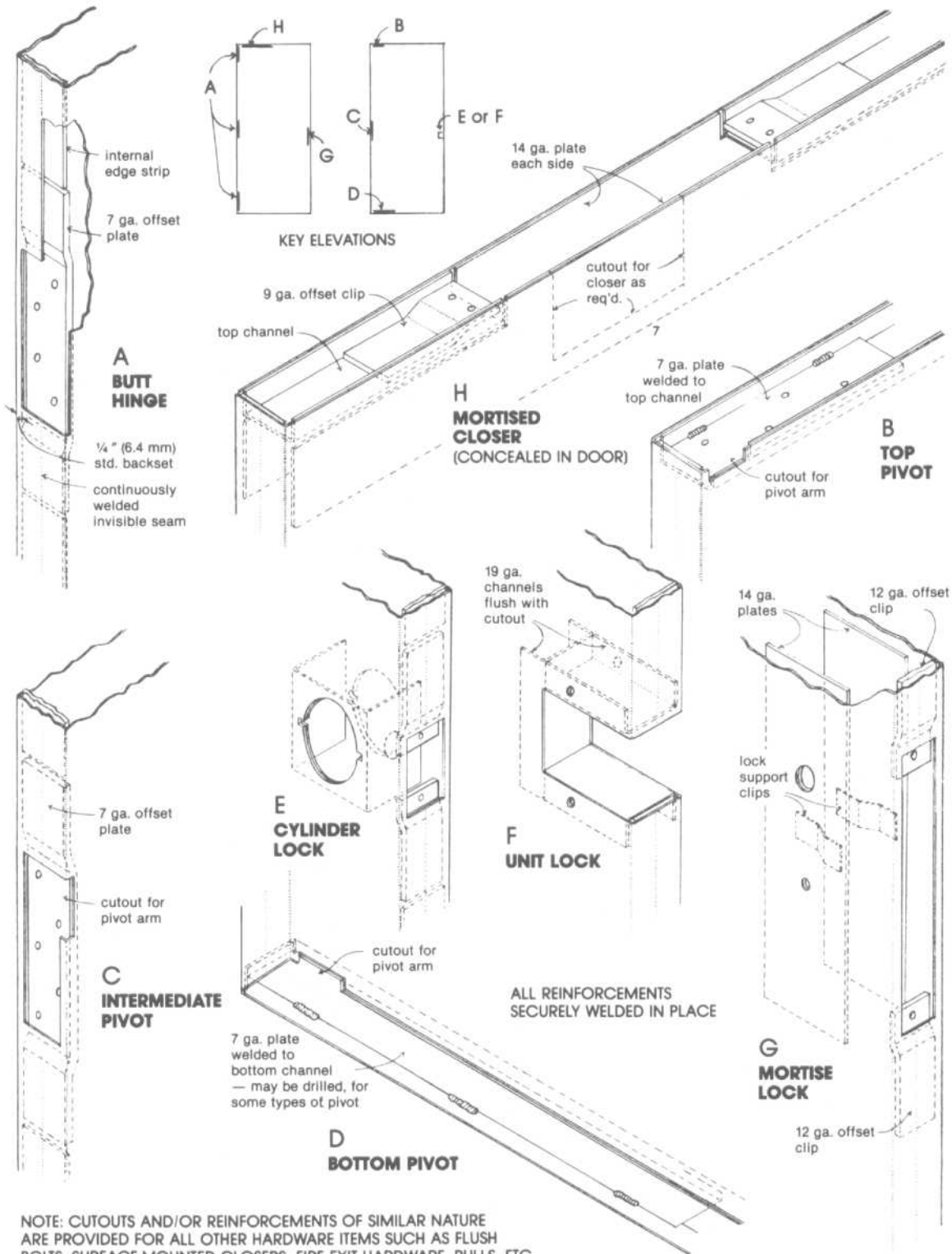
**LISTING DESIGNATION:** Always preface the door listing with "SGL" or "PR," followed by the designation of the opening size. For example, a single flush door for a 4'0" x 8'0" frame opening is listed SGL 4080F, and a pair of flush doors for an 8'0" x 8'0" frame opening is listed as PR 8080F.

**REPRESENTATIVE DOOR DESIGNS**



NOTE: Some manufacturers may use differing designations for some designs

**TYPICAL HARDWARE PREPARATION**



NOTE: CUTOUTS AND/OR REINFORCEMENTS OF SIMILAR NATURE ARE PROVIDED FOR ALL OTHER HARDWARE ITEMS SUCH AS FLUSH BOLTS, SURFACE-MOUNTED CLOSERS, FIRE EXIT HARDWARE, PULLS, ETC.

DOORS

Hollow Metal Door Schedules

DOOR SCHEDULE

Column numbers are for  
14 ← reference here only

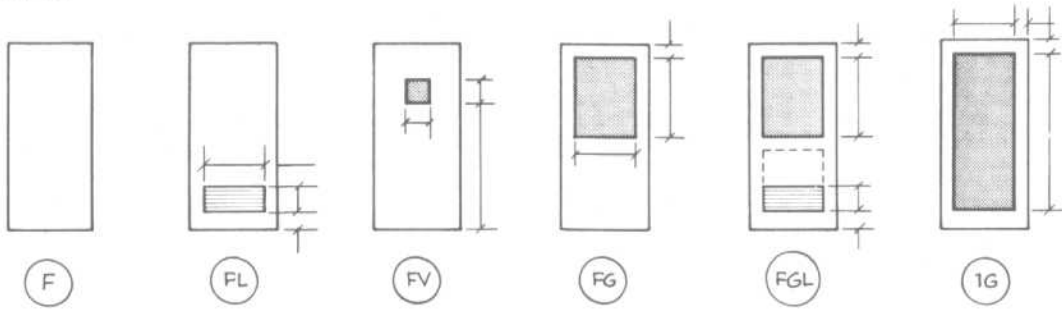
Opening Number	Type	Mat'l.	DOOR				FRAME				Fire Rating	Hard-Ware Set	Remarks			
			Nominal Size*		Sill Detail	Louwer		Spec'l. Detail	Type	Mat'l.				Sections		
			No.	Width		Height	Thkns.							W	H	Jamb
101	F	HM	1	3-0	7-0	1 3/4	—	—	—	1	HM	1/17	1/17	—	1	
102	1G	AL	2	6-0	8-0	1 3/4	—	TEMP	—	2	AL	5/17	5/17	—	8	Contin. aluminum threshold
103	FGL	WD	1	3-0	7-0	1 3/4	—	1/4" TEMP	2B/17	1	HM	1/17	1/17	—	4	
104	FG	HM	1	3-0	7-0	1 3/4	—	1/4" WIRE	—	1	HM	5/17	5/17	—	6	
105	FV	HM	3	4-0	7-0	1 3/4	—	1/4" TEMP	—	5	HM	2/17	2/17	—	1	Mullions 16/17
106	F	HM	2	7-0	7-0	1 3/4	—	—	—	2	HM	1/17	1/17	—	5	
107	FL	HM	1	3-0	7-0	1 3/4	23	12	—	3	HM	1/17	1/17	—	7	Transom bar 16/17
108	F	WD*	1	2-10	7-0	1 3/4	—	—	2B/17	1	HM	3/17	3/17	—	4	Plastic faced door
109	—	—	—	—	—	—	—	—	—	1	HM	5/17	5/17	—	—	Cased opening
110	FGL	HM	1	3-0	7-0	1 3/4	23	20	1/4" TEMP	4	HM	1/17	1/17	25, 19/17	1	Side light mullion 16/17
111	F	HM	1	3-0	7-0	1 3/4	—	—	3 1/17	1	HM	8/17	8/17	—	2	Sound retardant

\*Use metric units if desired; 1 inch = 25.4 mm, 1 foot = 0.305 m.

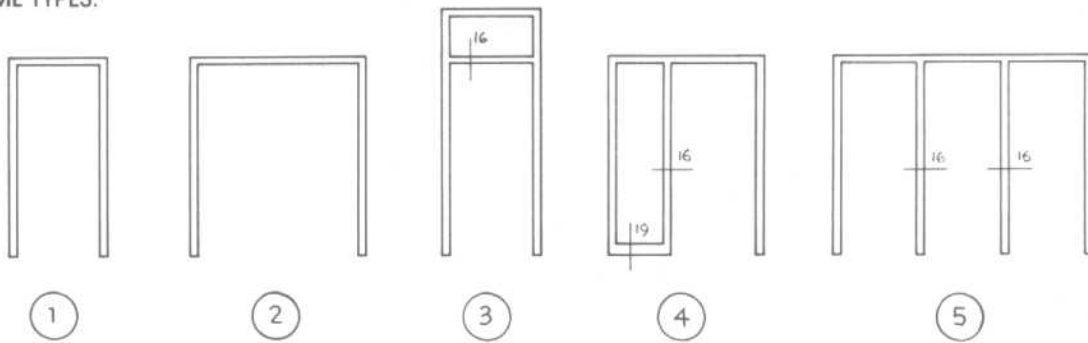
- Opening Number**  
Number all openings individually, with the numbering system reflecting floor numbers if practicable.
- Door Type**  
Use alphabetical designation for types, as shown on elevation views on facing page. Elevations should show door configurations and all features such as louvers, vision lights, etc. Do not use one elevation with dash lines to indicate variations.
- Door Material**  
Designate material from which door is made: HM = hollow metal; AL = aluminum; WD = wood. • Indicates special facing as noted in Remarks column. Type of core construction should be stated in the specifications.
- Nominal Size**  
List number of doors per framed opening, plus width, height and thickness of door. State head and jamb clearances in specifications, using Hollow Metal Manufacturers Association recommended standards unless special conditions require otherwise.
- Sill Detail**  
Reference sill detail, which shows sill clearance, threshold if any, and any special condition. Reference number shows detail number first, followed by sheet number.
- Louwer**  
Note width and height (in inches) of louwer panel. Louwer types may be either specified or shown in detail drawings.
- Glass**  
Note thickness and type of glass to be used in glazed opening.
- Special Detail**  
Reference detail(s) showing special features such as astragal (on pair), dutch door shelf, flush transom panel or other.
- Frame Type**  
Use numerical designation for type, as shown on elevation views on facing page.
- Frame Material**  
Designate material from which frame is made, using same symbols as for door materials.
- Frame Sections**  
Reference details, showing frame sections at head and jamb, and details of such members as transom bars, mullions and other special features.
- Fire Rating**  
State fire rating, if any, required for opening.
- Hardware Set**  
State applicable hardware set number as described in specifications.
- Remarks**  
Note here any special characteristics or required features of the opening, to insure that the contractor or supplier will be properly informed.

**REPRESENTATIVE DETAILS ACCOMPANYING DOOR SCHEDULE**

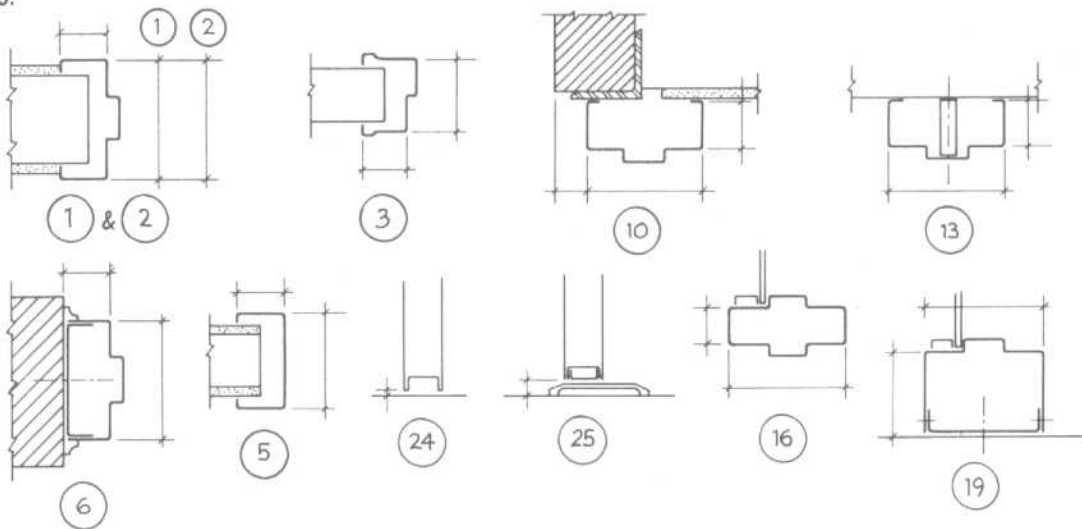
DOOR TYPES:



FRAME TYPES:



DETAILS:



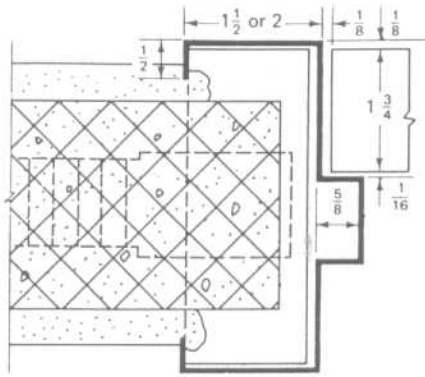
DOORS

Hollow Metal Door Schedules

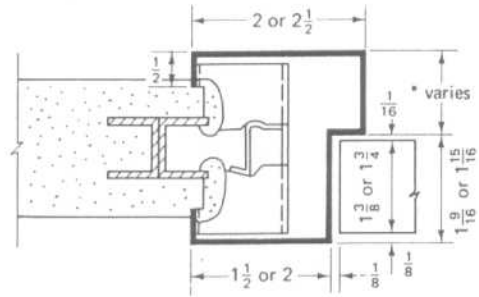
DOOR SCHEDULE

SYMBOL	①	②	③	④	⑤
SIZE	5'-0" x 7'-0"	5'-0" x 7'-0"	5'-0" x 7'-0"	2'-0" x 7'-0"	5'-0" x 7'-0"
LOCATION	CELLAR EXIT	CELLAR + BOILER RM	CELLAR	CELL. APPT./CORRID.	APARTMENT ENTRY
TYPE	FLUSH, INSULATED	FLUSH	FLUSH	FLUSH	FLUSH
MATERIAL	HOLL. MET. w/ WFB GLASS	HOLLOW METAL	HOLLOW METAL	HOLL. MET./HOLL. GLASS	HOLLOW METAL
GADDLE	STEEL			WHEEL	
REMARKS	1/2 HR. P.F.S.C.	1/2 HR. P.F.S.C.			1/2 HR. P.F.S.C., ETC. - 50 W/REPPLE MSA # 187.72
NOTES:					
	⑥	⑦	⑧	⑨	⑩
	VARIABLE SLAT PLANS	VARIABLE SLAT PLANS	2'-0" x 7'-0"	2'-0" x 7'-0"	2'-0" x 7'-0"
	VARIABLE	VARIABLE	2'-0" x 7'-0"	2'-0" x 7'-0"	2'-0" x 7'-0"
	CLOSETS	CLOSETS	BATHROOMS	BATHROOMS & GRAND FL.	BATHROOMS
	BI-FOLD N/ LAYERS	FLUSH	FLUSH	FLUSH	FLUSH
	WOOD	WOOD	WOOD	WOOD	WOOD
			WARELIS	WARELIS	
	UNDERCUT 1"	UNDERCUT 1"	UNDERCUT 1"	TO COMPLY W/ L.L. 50 UNDERCUT 1"	
	⑪	⑫	⑬	⑭	⑮
	2'-0" x 7'-0"	2'-0" x 7'-0"	2'-0" x 7'-0"	2'-0" x 7'-0"	2'-0" x 7'-0"
	BEDRMS & GRAND FL.	STORAGE ENT./VESTIBULE	GAFT + 10 (11#)	ROOF BURBAG/APPT.	
	FLUSH	FLUSH	SLIDERS	FLUSH	
	WOOD	WOOD & TEMPER GLASS	WOOD	HOLL. MET.	
		WARELIS		STEEL	
	TO COMPLY N/ L.L. 50		TO COMPLY W/ L.L. 50 ONE LOCATION ONLY (11# - AFF 1 D)		

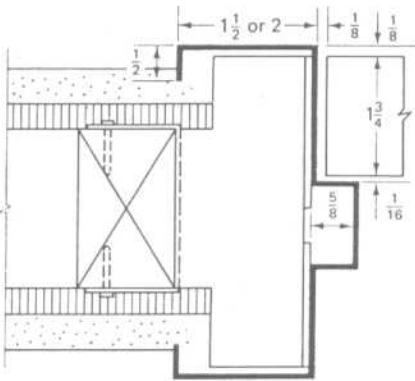




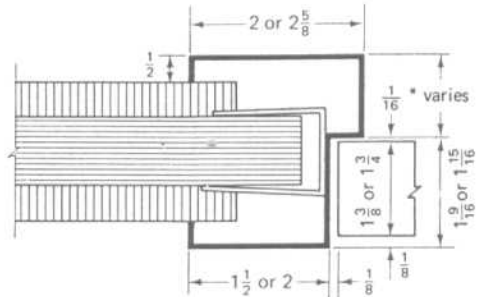
(a) Masonry with plaster, one or both sides



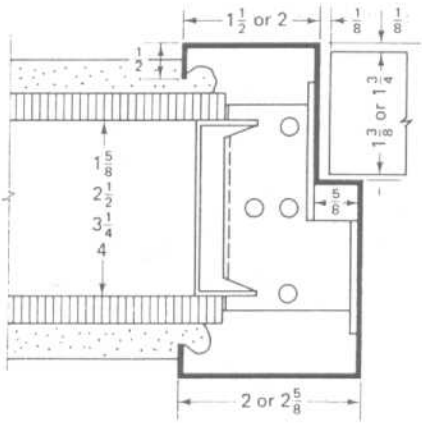
(b) Two-inch plaster wall



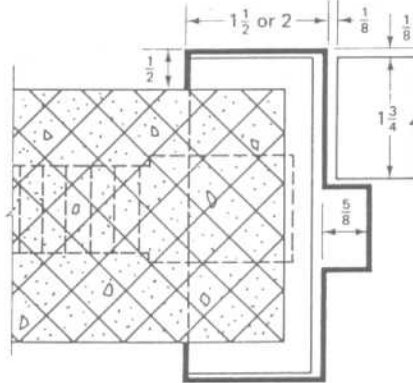
(c) Wood stud and plaster



(d) Two-inch solid dry wall



(e) Steel stud and plaster

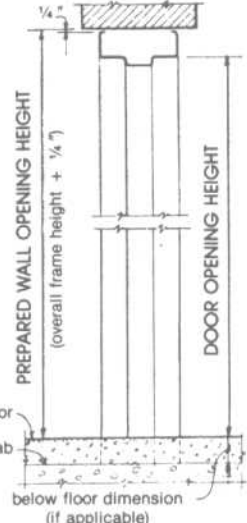
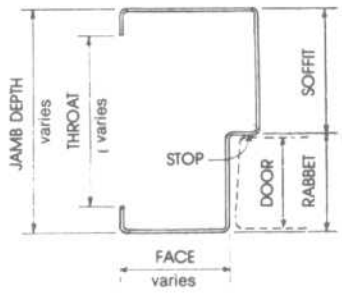
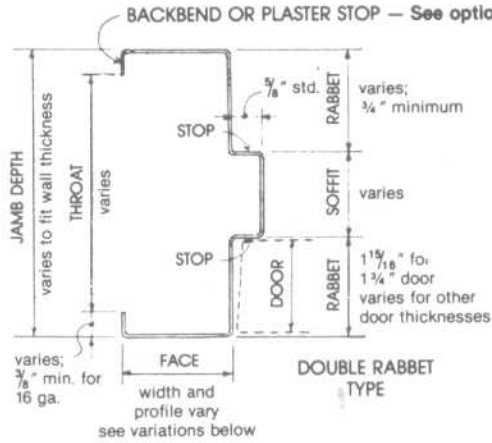


(f) Masonry block. Wrap-around or butt joint

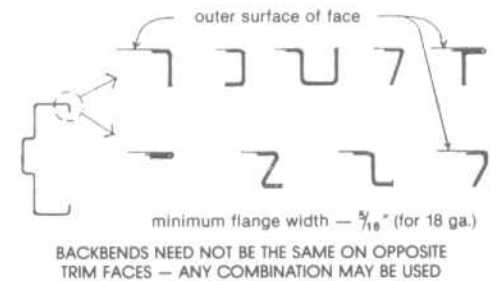
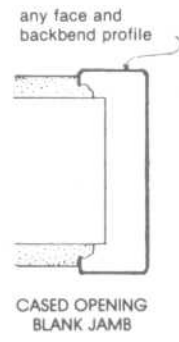
Fig. 2 Typical jamb installations.

**DOORS**

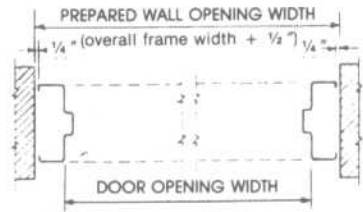
Hollow Metal Door Frames



**BASIC DOOR FRAME PROFILES AND THEIR PARTS**

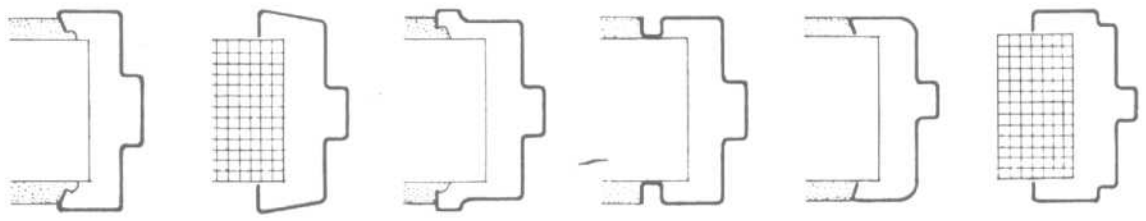


**VERTICAL FRAME DIMENSIONS**

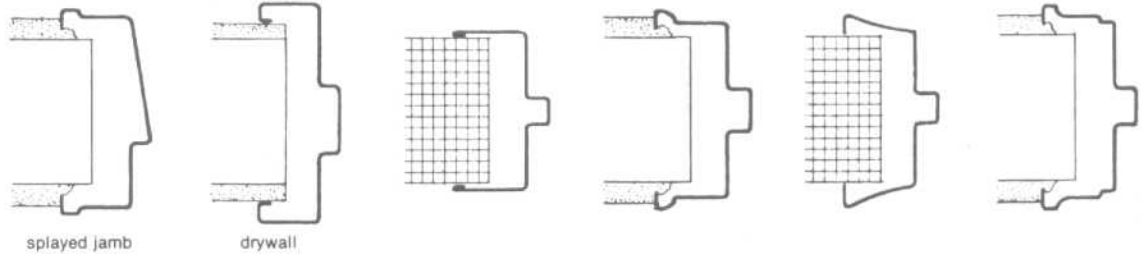


**HORIZONTAL FRAME DIMENSIONS**

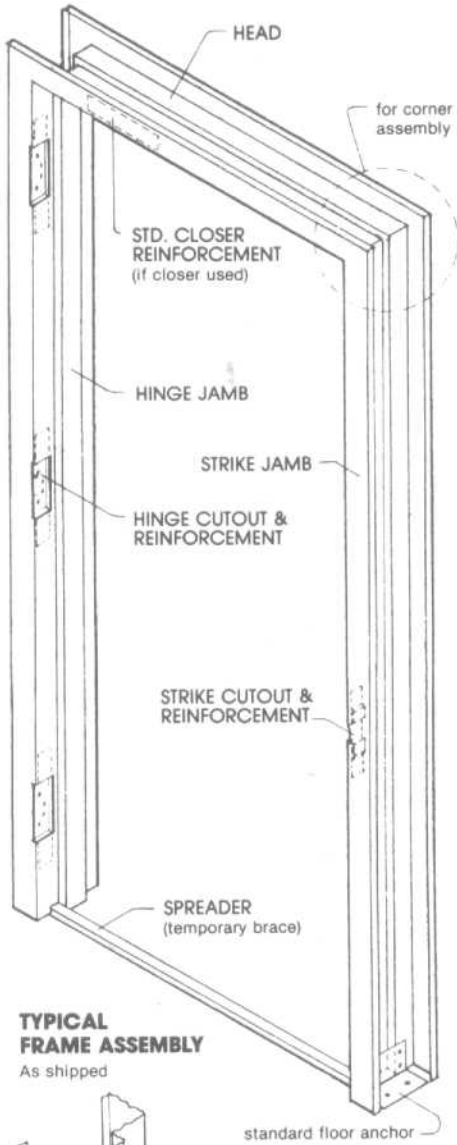
**TYPICAL BACKBEND or PLASTER STOP PROFILES**



Frame depth to fit any wall thickness or finish Any face profile may be combined with any backbend profile

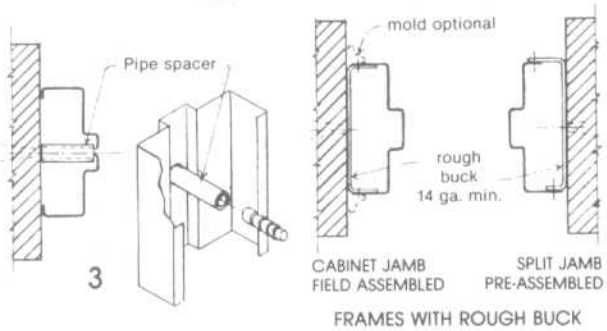
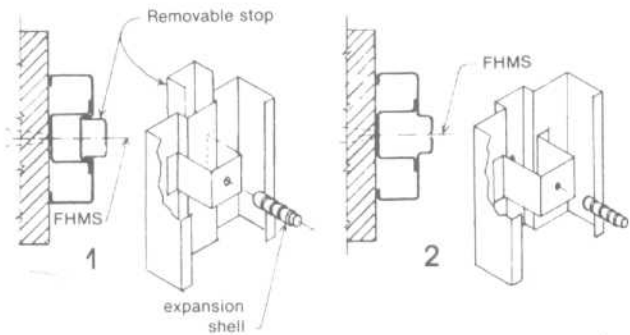
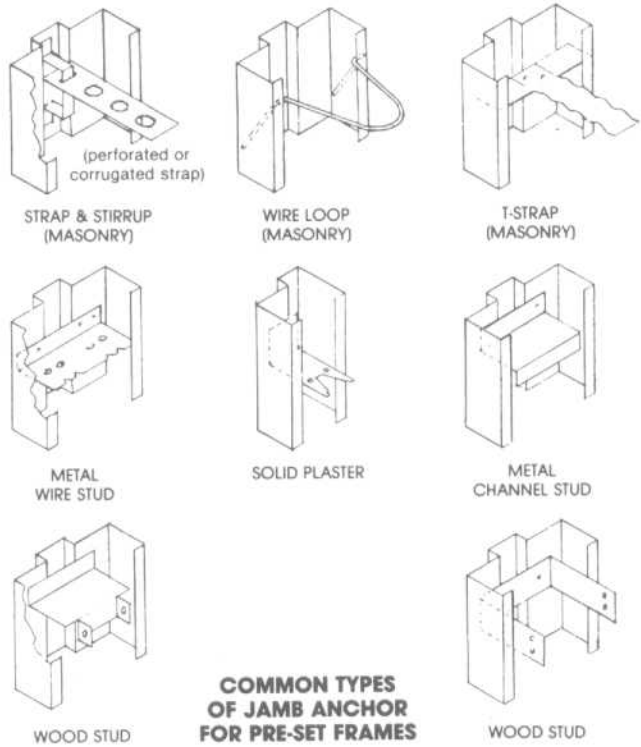
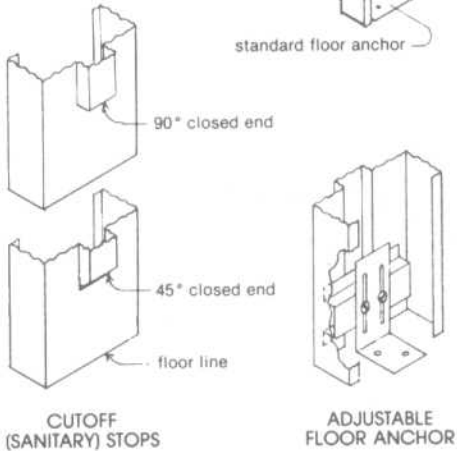


**REPRESENTATIVE FRAME PROFILES**



**TYPICAL FRAME ASSEMBLY**

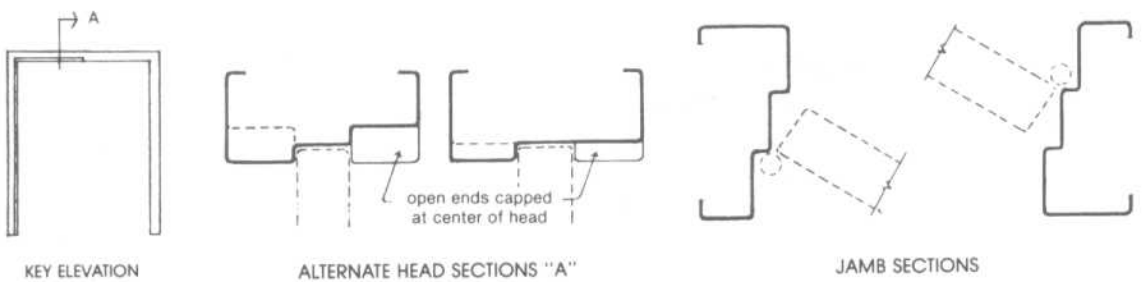
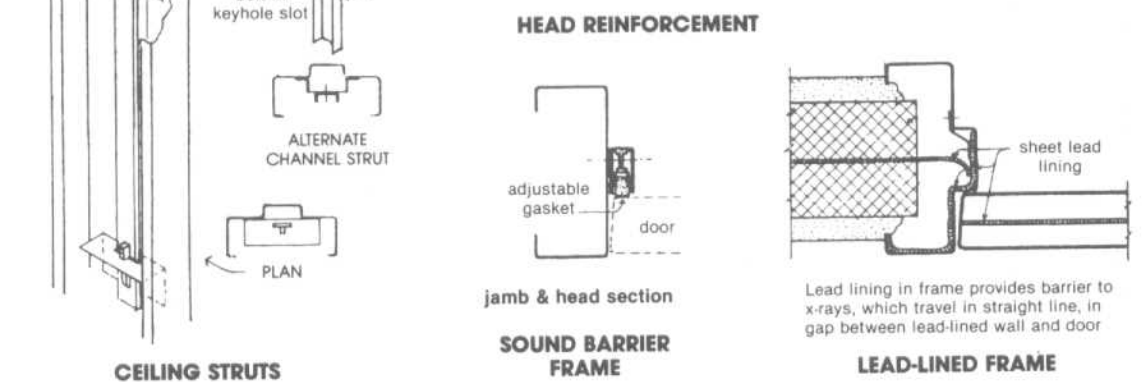
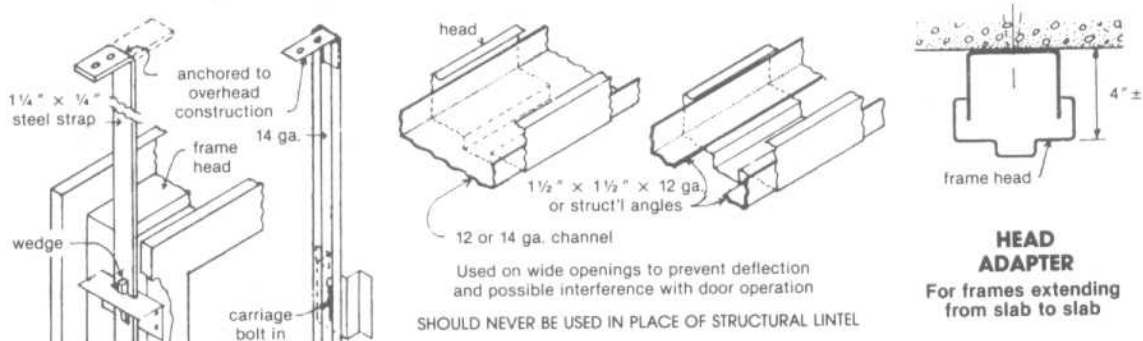
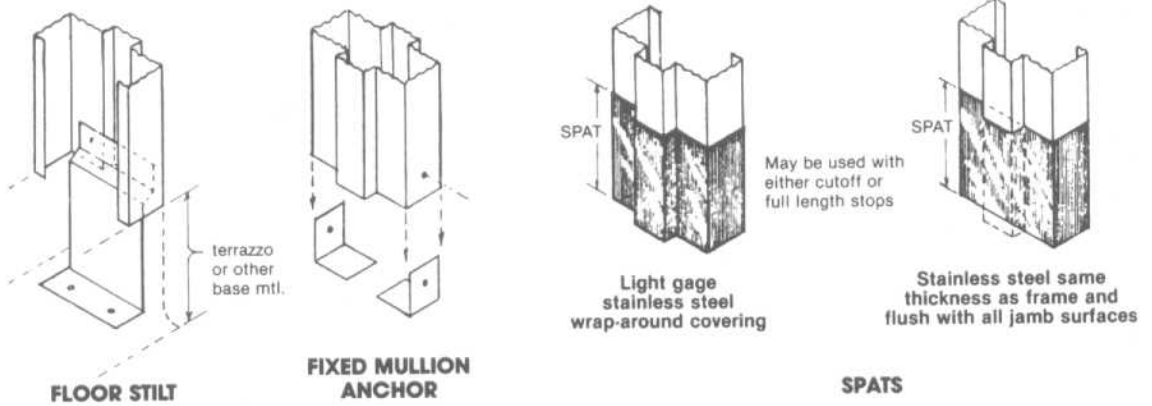
As shipped



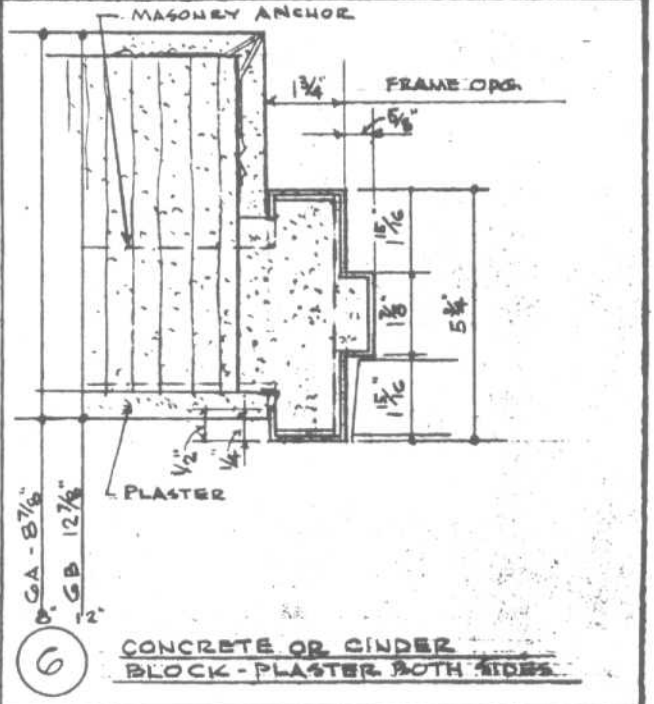
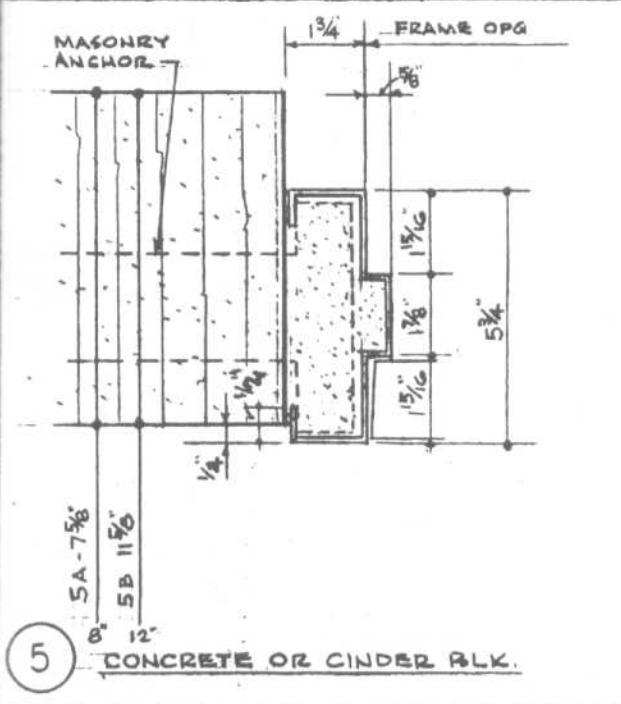
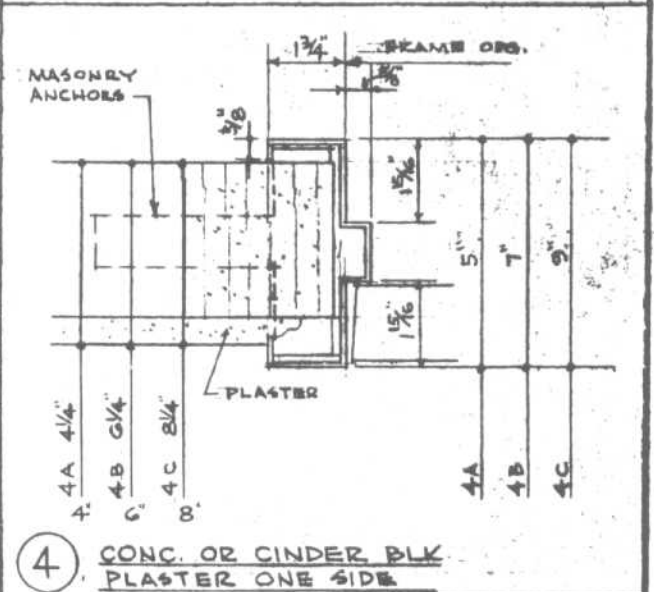
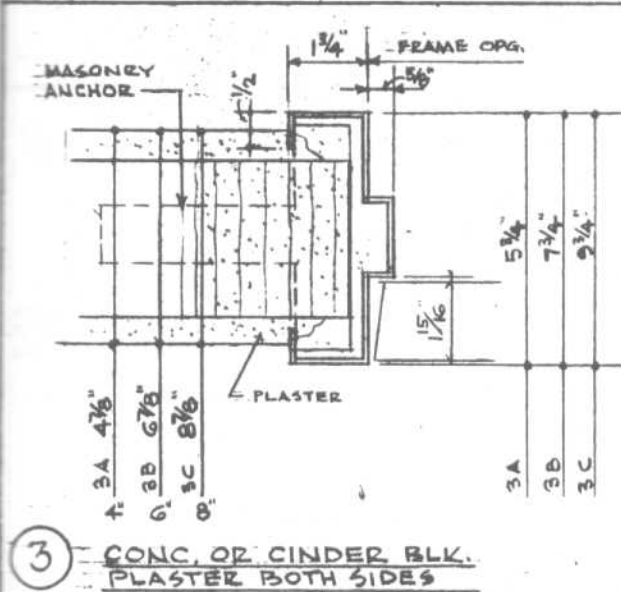
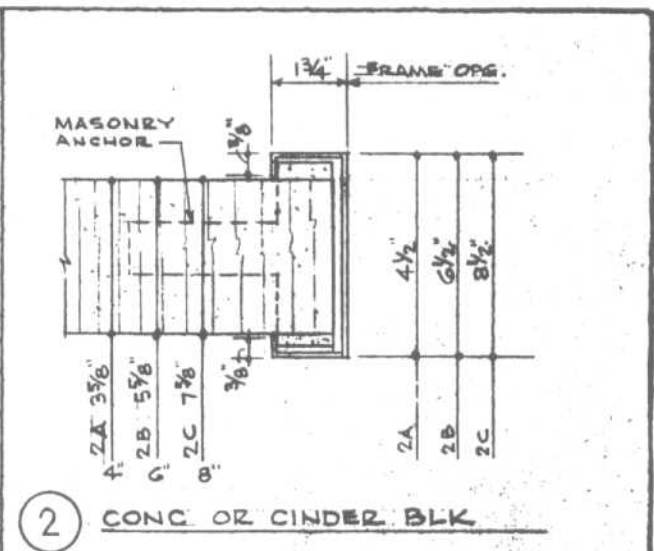
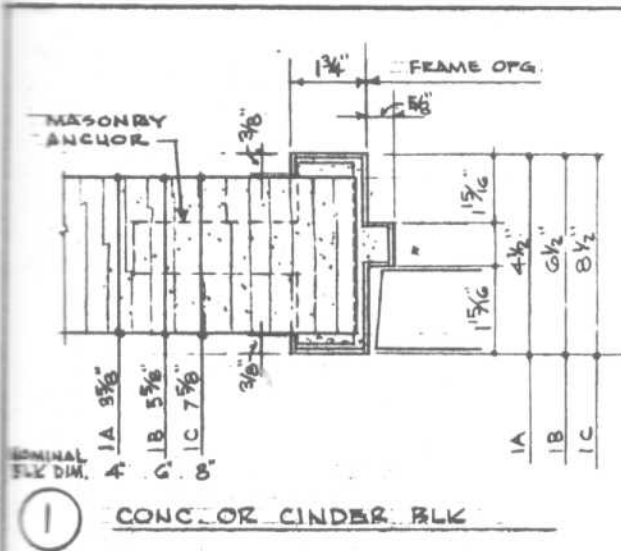
**ANCHORAGE OF FRAMES IN PREPARED OPENINGS**

**DOORS**

Hollow Metal Door Frames

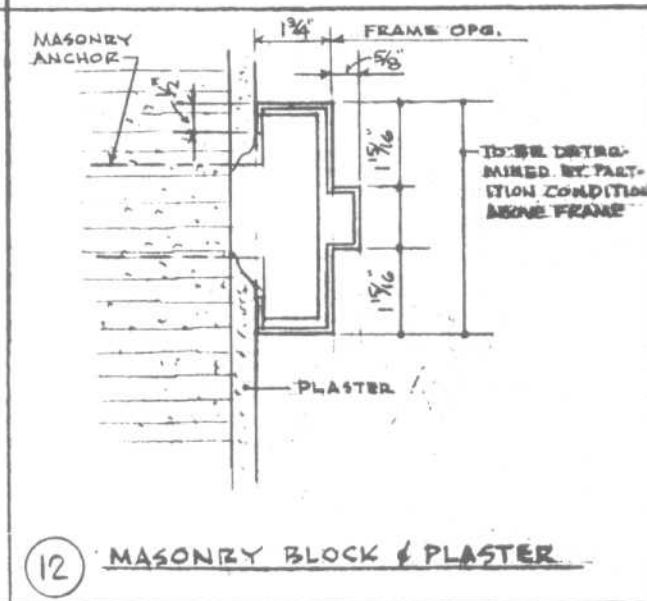
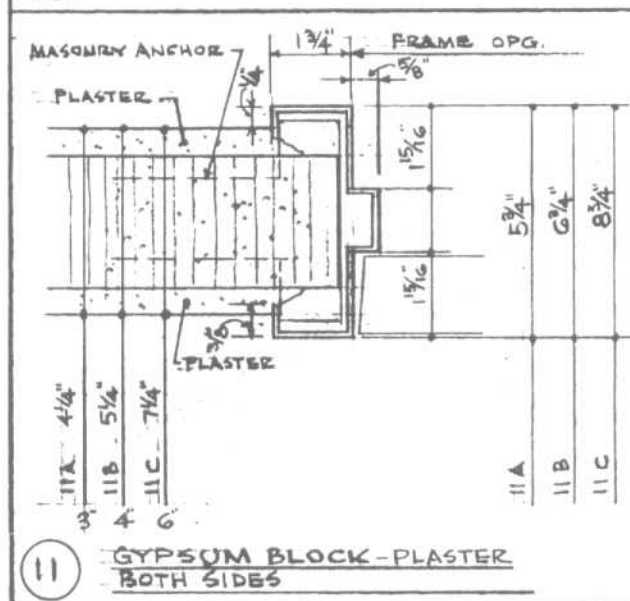
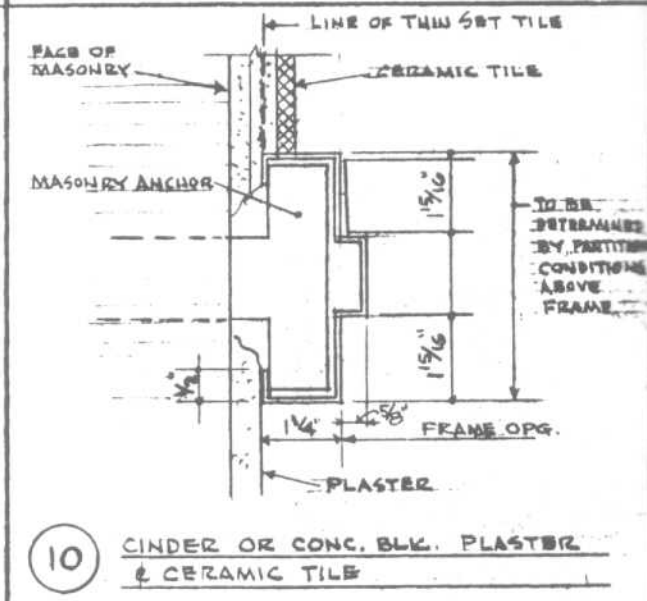
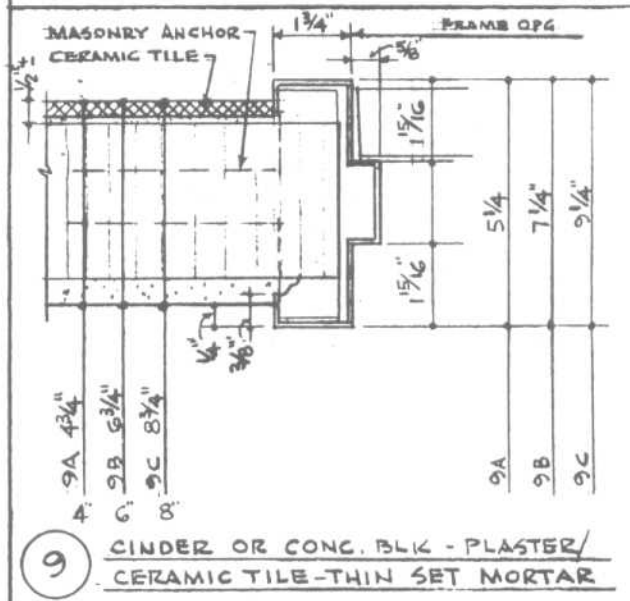
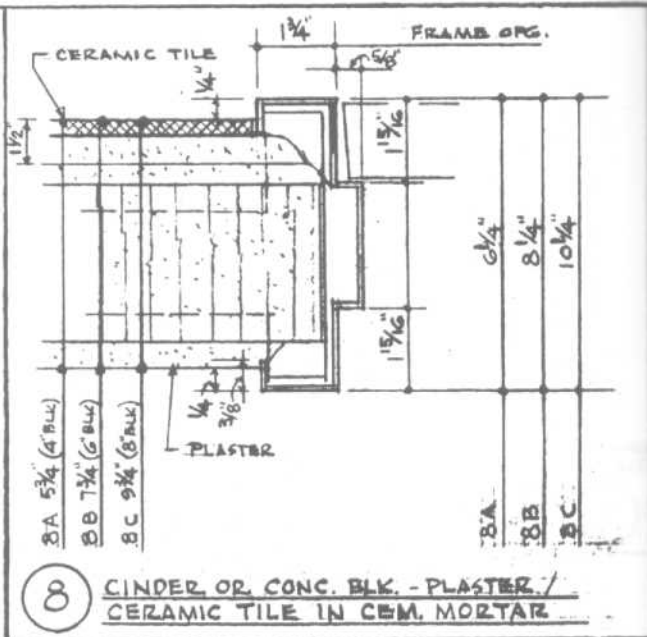
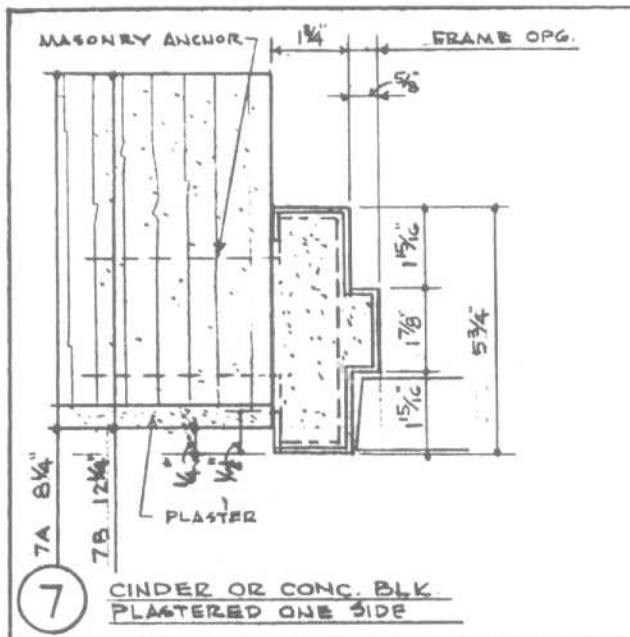


**DETAILS OF DOUBLE EGRESS FRAME**



DOORS

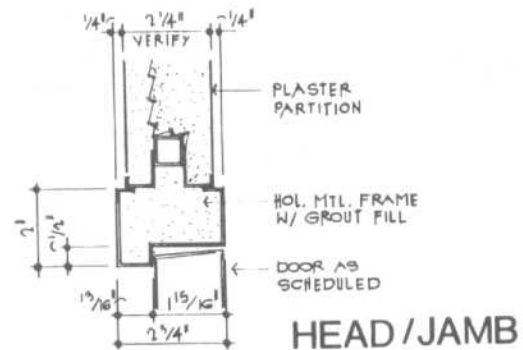
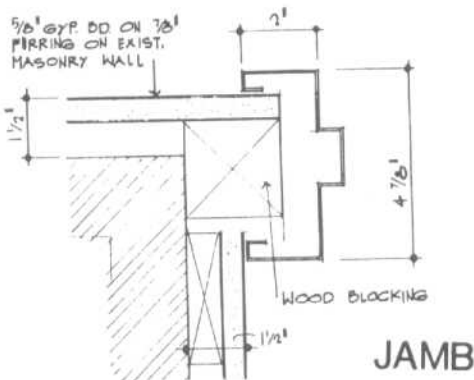
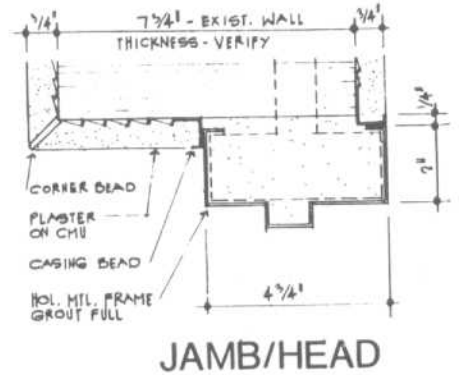
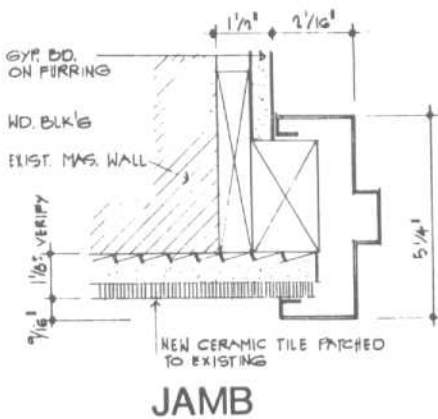
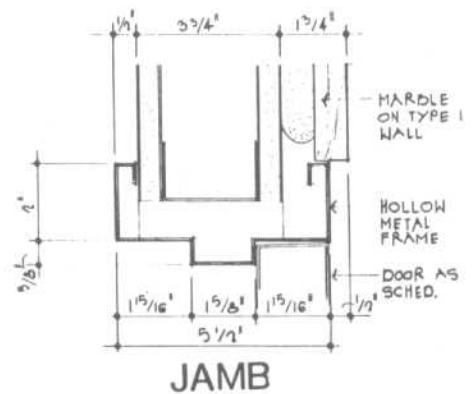
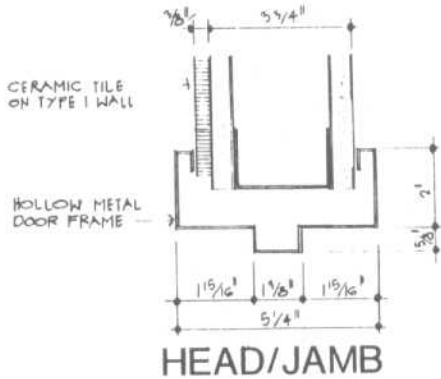
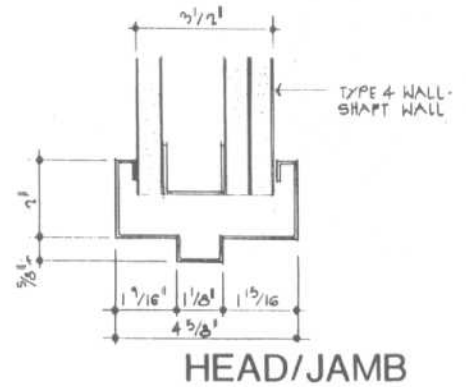
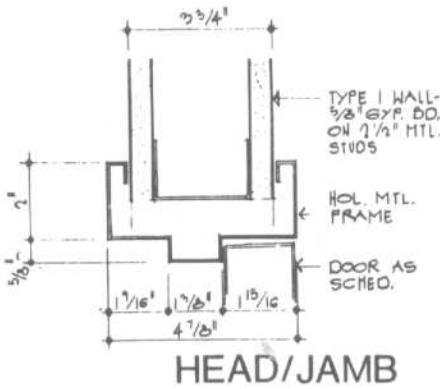
Hollow Metal Door Frames





DOORS

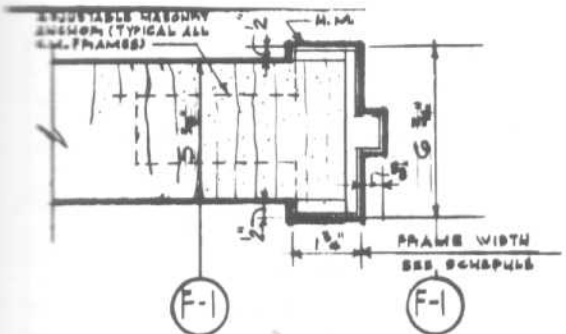
Hollow Metal Door Frames



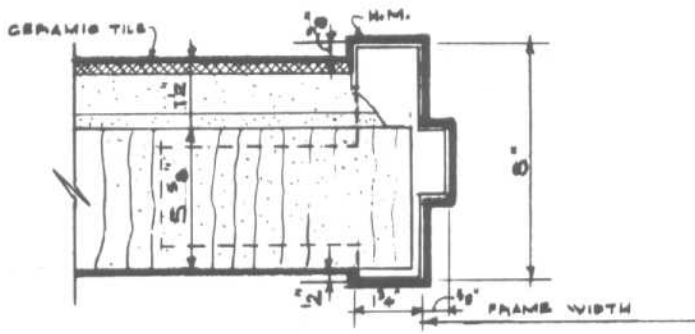


DOORS

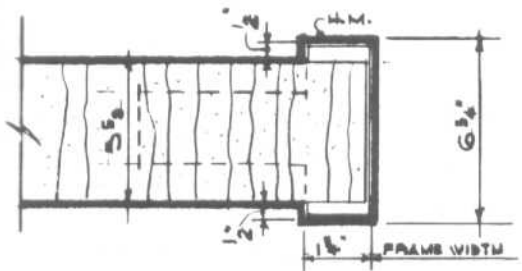
Hollow Metal Door Frames



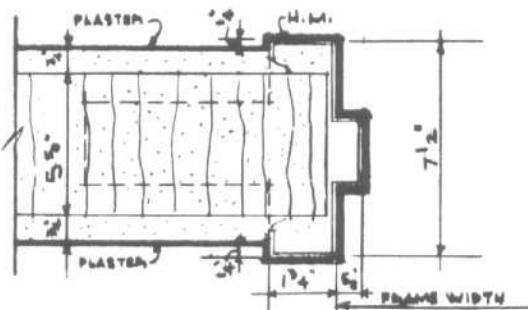
F-1 UNFINISHED MASONRY BLOCK @ 3" x 1'-0"



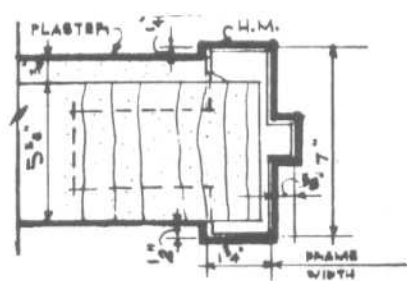
F-2 MASONRY BLK. - CERAMIC TILE ONE SIDE @ 3" x 1'-0"



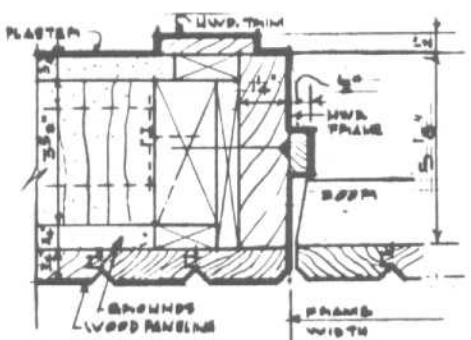
F-3 THINNED OP. MASONRY BLOCK @ 3" x 1'-0"



F-4 MASONRY BLK. PLASTER BOTH SIDES @ 3" x 1'-0"



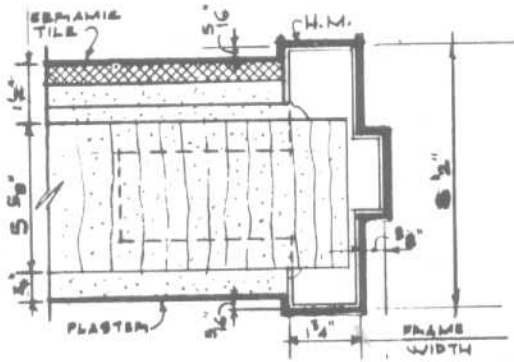
F-5 MASONRY BLK. PLASTER ONE SIDE @ 3" x 1'-0"



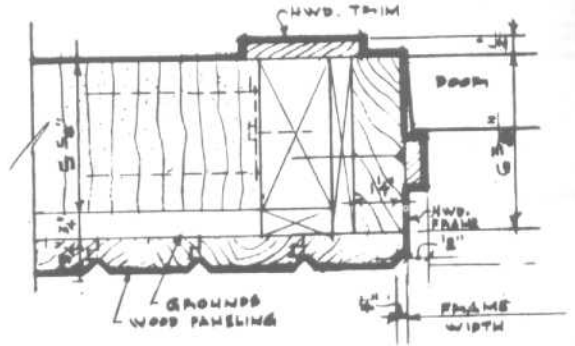
F-6 WOOD FRAME @ 3" x 1'-0"

DOORS

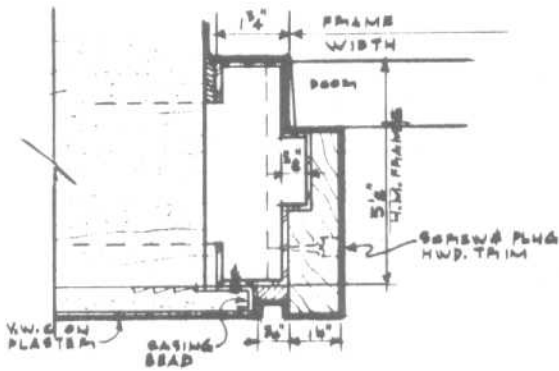
Hollow Metal Door Frames



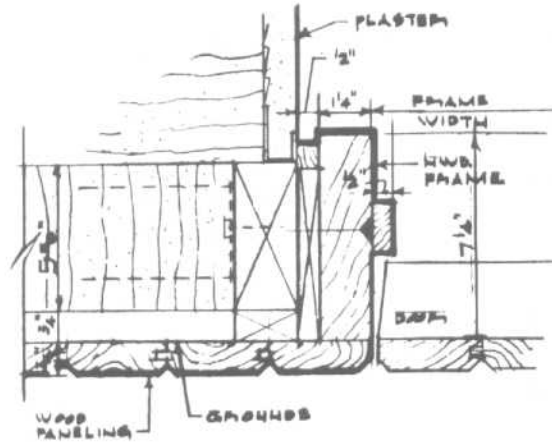
F-7 MASONRY SW. CERAMIC TILE & PLASTER  
 3'-11-0"



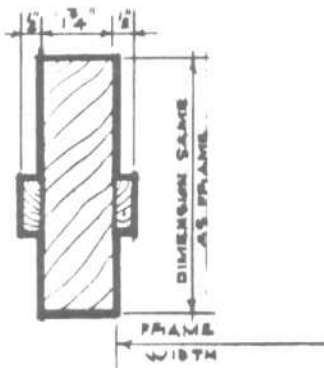
F-8 HARDWOOD FRAME  
 3'-11-0"



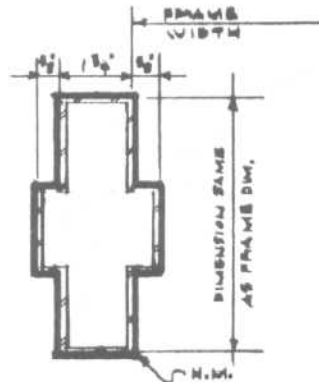
F-9 H.M. FRAME - H.W.D. COVERING  
 3'-11-0"



F-10 HARDWOOD FRAME  
 3'-11-0"



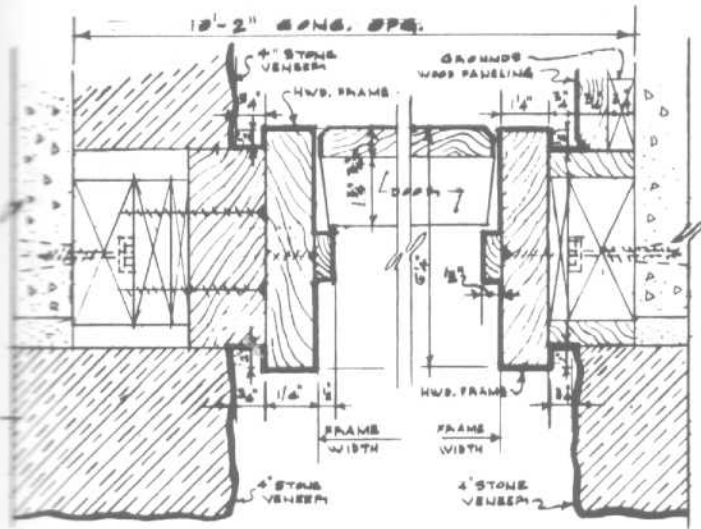
F-11 TYPICAL HARDWOOD MULLION  
 3'-11-0"



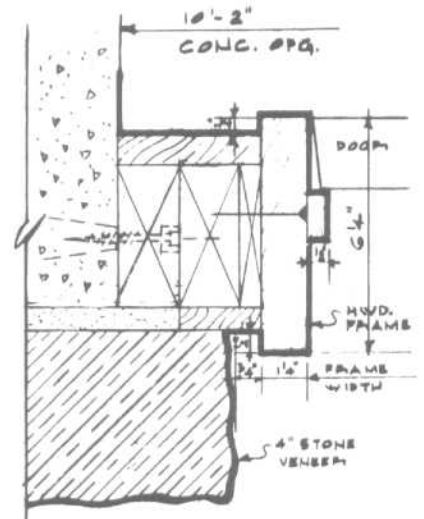
F-12 TYPICAL H.M. MULLION  
 3'-11-0"

DOORS

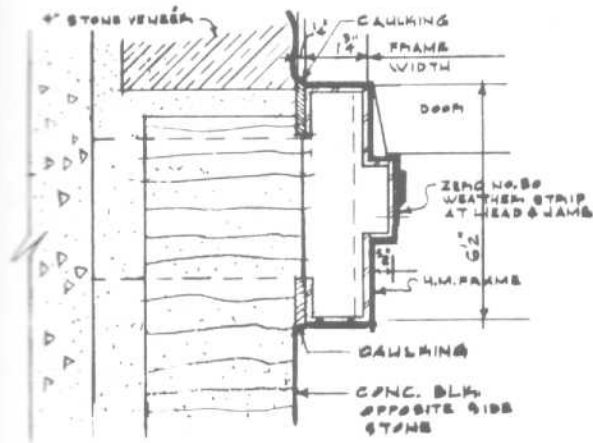
Hollow Metal and Wood Door Frames



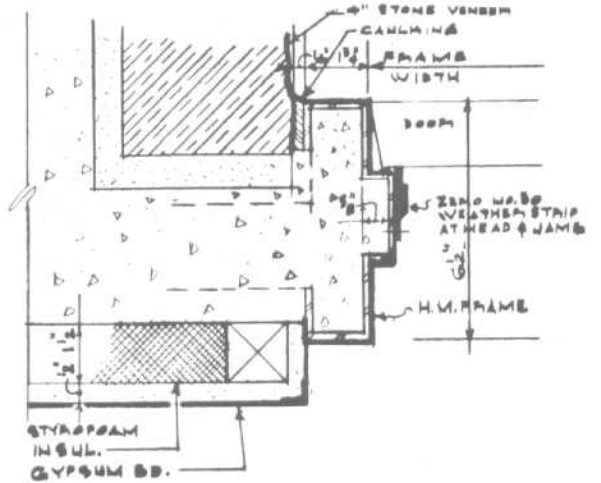
F-13 HARDWOOD FRAME  
@ 3" x 1'-0"



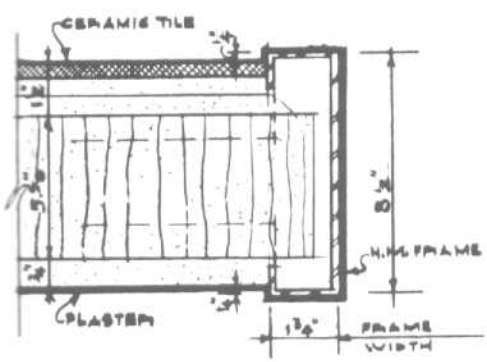
F-14 HARDWOOD FRAME  
@ 3" x 1'-0"



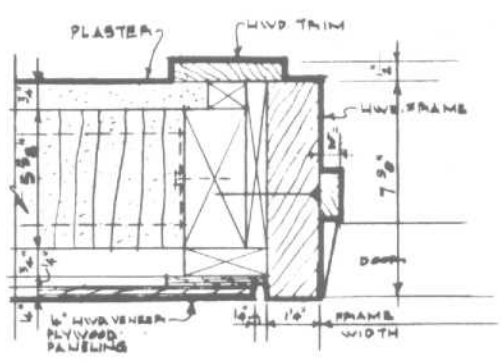
F-15 EXTERIOR HOLLOW METAL FRAME  
@ 3" x 1'-0"



F-16 EXTERIOR HOLLOW METAL FRAME  
@ 3" x 1'-0"



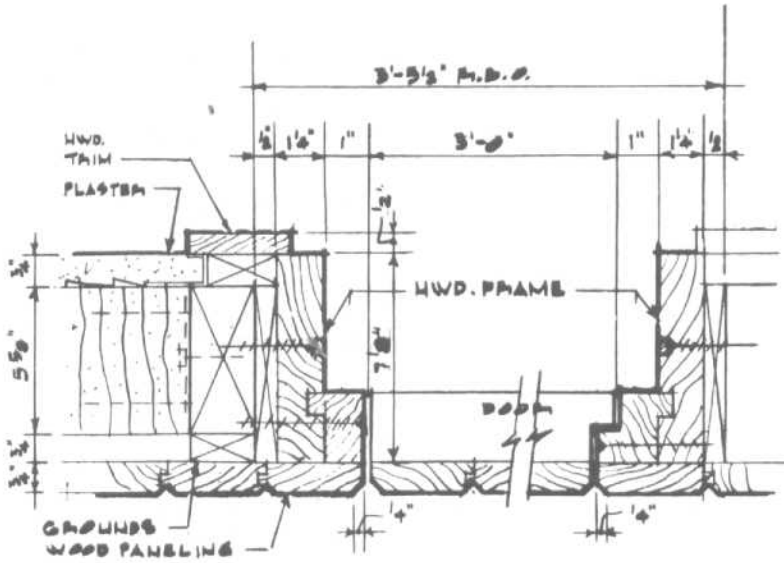
F-17 THINNED OPG. MASONRY BLK. CERAMIC TILE & PLASTER @ 3" x 1'-0"



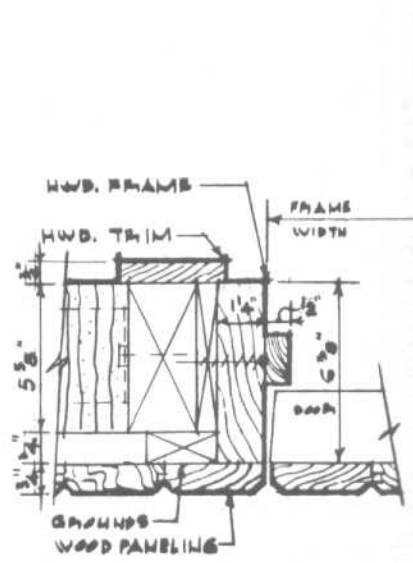
F-18 HARDWOOD FRAME  
@ 3" x 1'-0"

DOORS

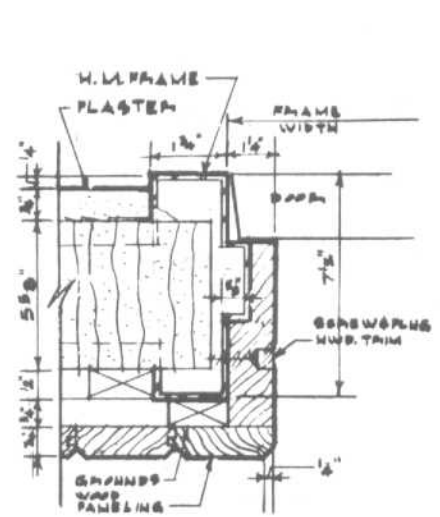
Hollow Metal and Wood Door Frames



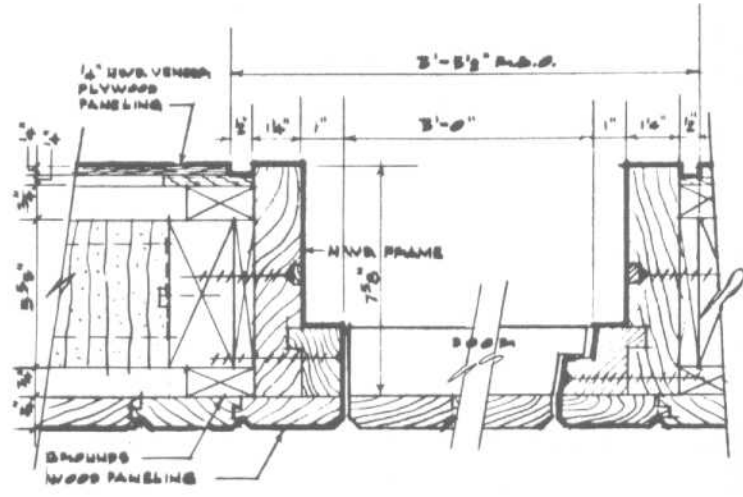
F-25 HARDWOOD FRAME  
@ 3' x 1'-0"



F-26 HARDWOOD FRAME  
@ 3' x 1'-0"



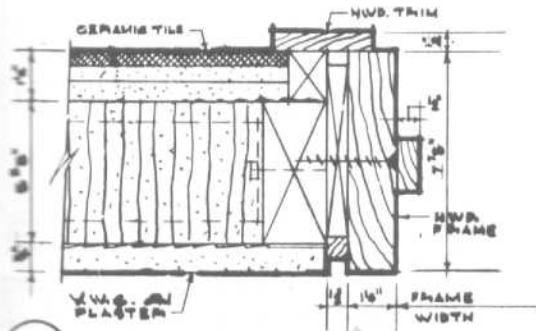
F-27 H.M. FRAME - HWD. COVERING  
@ 3' x 1'-0"



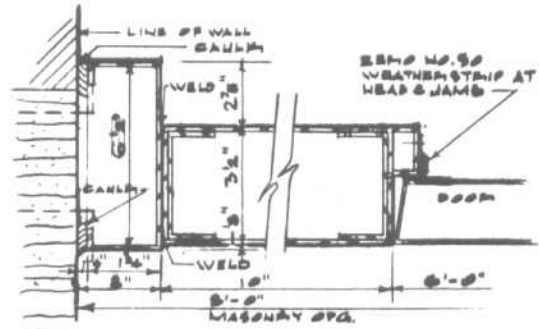
F-28 HARDWOOD FRAME  
@ 3' x 1'-0"

DOORS

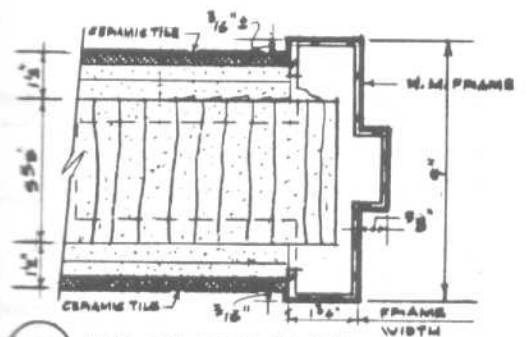
Hollow Metal and Wood Door Frames



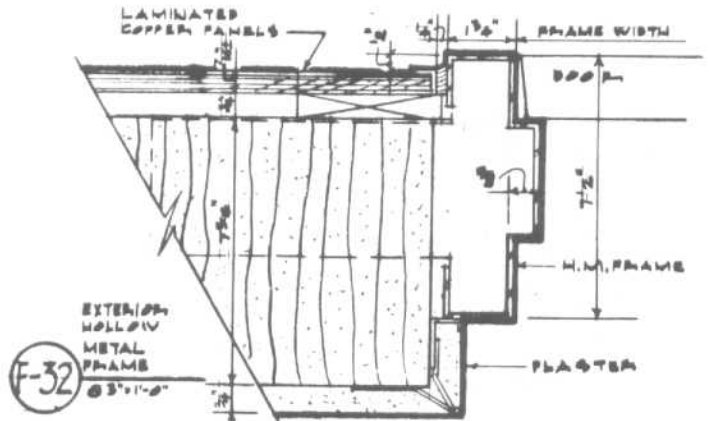
F-29 HARDWOOD FRAME  
@ 3' x 1'-0"



F-30 EXTERIOR HOLLOW METAL FRAME  
@ 3' x 1'-0"



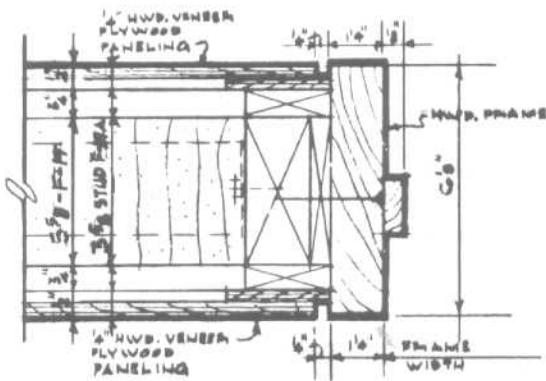
F-31 HOLLOW METAL FRAME  
@ 3' x 1'-0"



F-32 EXTERIOR HOLLOW METAL FRAME  
@ 3' x 1'-0"

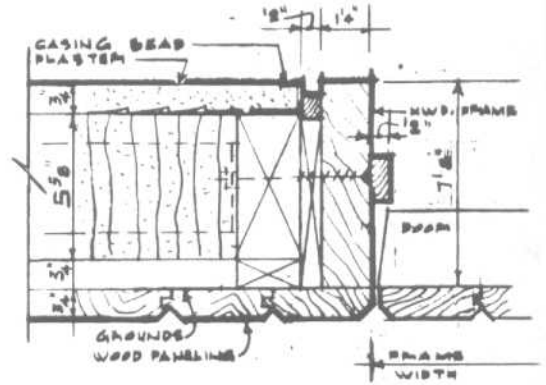
DOORS

Hollow Metal and Wood Door Types

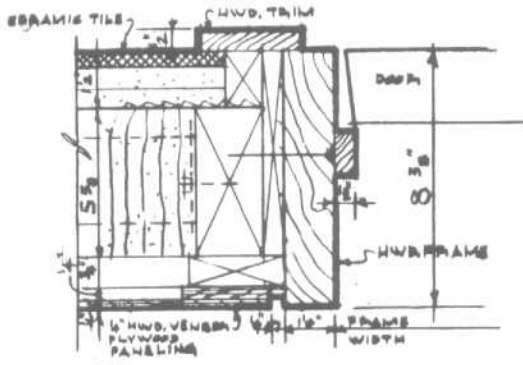


F-19 HARDWOOD FRAME  
 @ 3" x 1'-0"

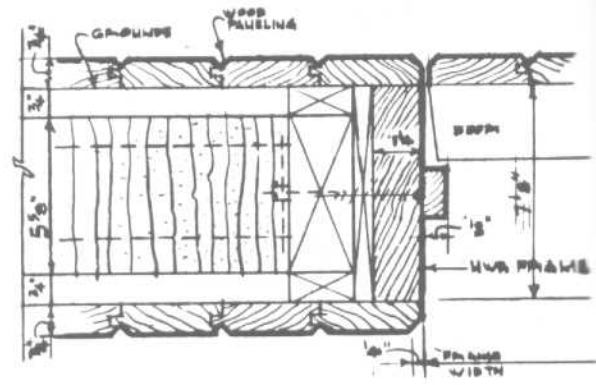
F-19A WOOD STUD PARTITION



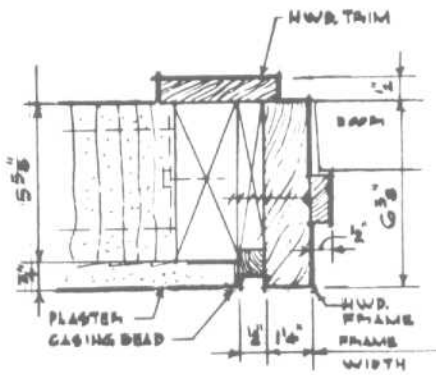
F-20 HARDWOOD FRAME  
 @ 3" x 1'-0"



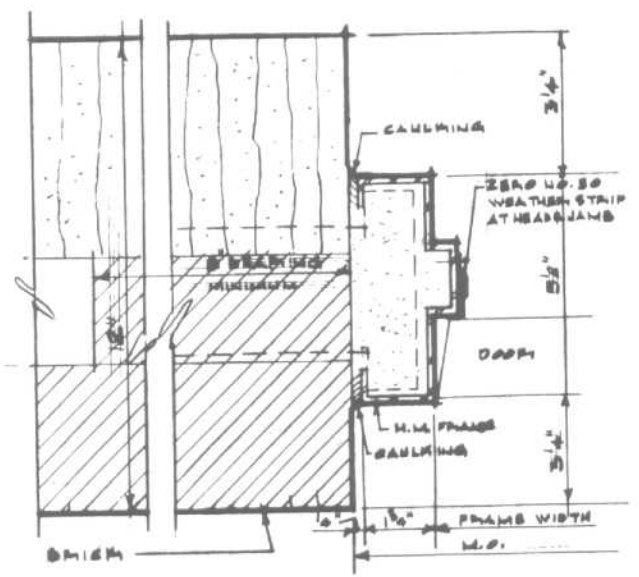
F-21 HARDWOOD FRAME  
 @ 3" x 1'-0"



F-22 HARDWOOD FRAME  
 @ 3" x 1'-0"



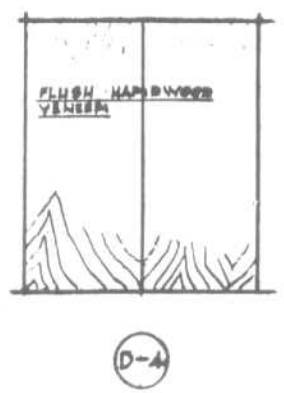
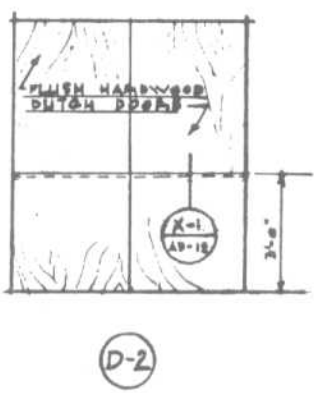
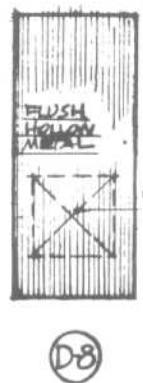
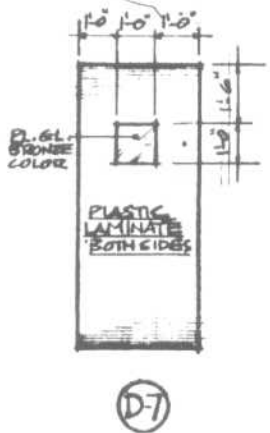
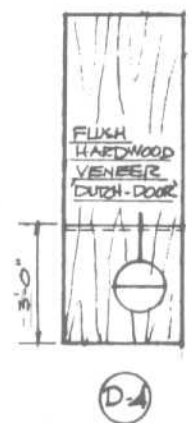
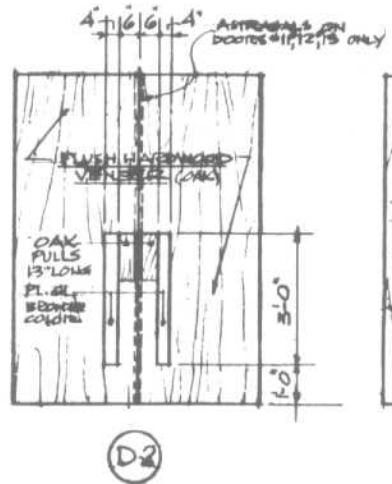
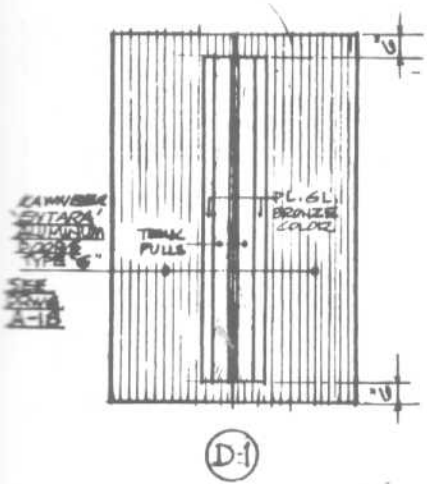
F-23 HARDWOOD FRAME  
 @ 3" x 1'-0"



F-24 EXTERIOR HOLLOW METAL FRAME  
 @ 3" x 1'-0"

DOORS

Door Types



DOORS

Door Types



D-5



D-6



D-16



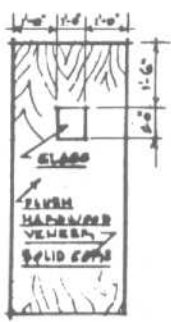
D-17



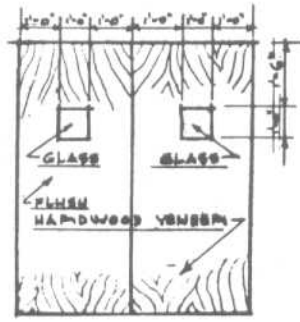
D-7



D-8



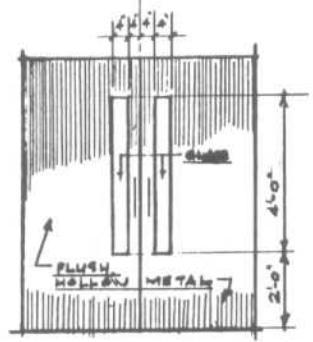
D-12



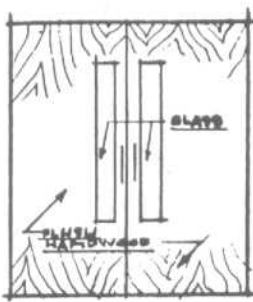
D-13



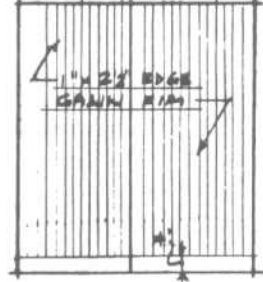
D-14



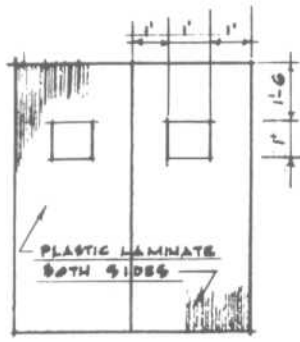
D-10



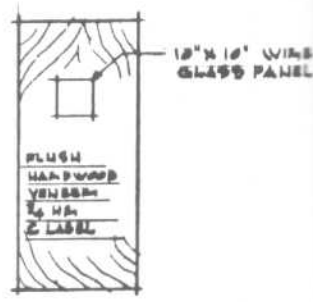
D-11



D-15

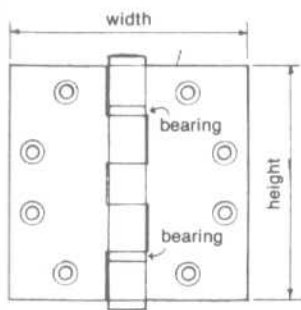


D-18



D-19



**FULL MORTISE BUTT HINGE**

Two equal square-edged leaves, one mortised into door edge, the other into frame rabbet.

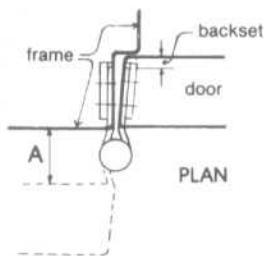
Two bearings, as shown, on regular weight hinges, four on heavy weight.

**Typical Uses:**

By far the most common type of hinge for both interior and exterior hollow metal and wood swing doors, in all types of buildings.

**Usual Sizes (see NOTE below):**

heights — 4½", 5" for doors over 36" w.  
widths — 4½" for 1¼" door and 1½" trim clearance (dimension A); 5" (or more) for thicker doors or larger clearances.



PLAN

**HALF MORTISE BUTT HINGE**

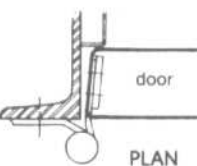
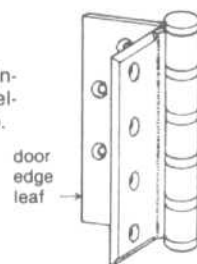
One square-edged leaf mortised into door edge; the other leaf, bevel-edged, mounted on face of frame.

**Typical Uses:**

Used with hollow metal or kalamein doors in structural channel frames, usually in industrial type buildings.

**Usual Sizes:**

4½", 5" and 6" heights.



PLAN

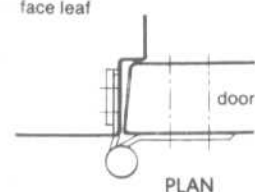
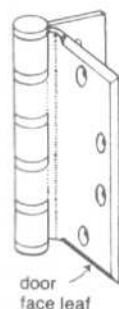
**HALF SURFACE BUTT HINGE**

One leaf, bevel-edged, mounted on face of door; the other leaf, square-edged, mortised into frame rabbet.

**Typical Uses:**

Used with hollow metal or kalamein doors in hollow metal frames, usually in industrial buildings. Heavy weight type also used on lead-lined doors.

Usual Sizes: 4½", 5" and 6" heights.



PLAN

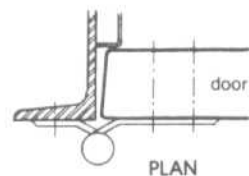
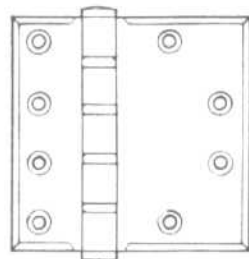
**FULL SURFACE BUTT HINGE**

Two bevel-edged leaves of differing widths, one surface-mounted on door face, the other on frame face.

**Typical Uses:**

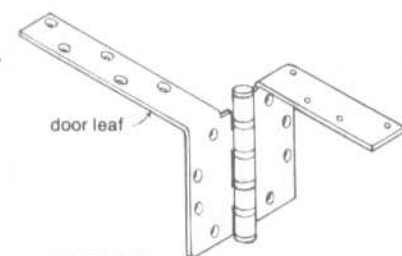
Used with hollow metal or kalamein doors in structural channel frames, in industrial buildings. Heavy weight type may be used on lead-lined doors.

Usual Sizes: 4½", 5" and 6" heights.

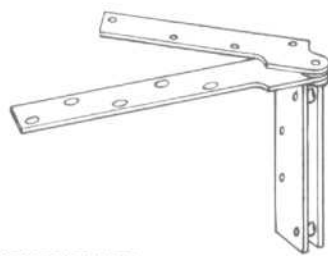


PLAN

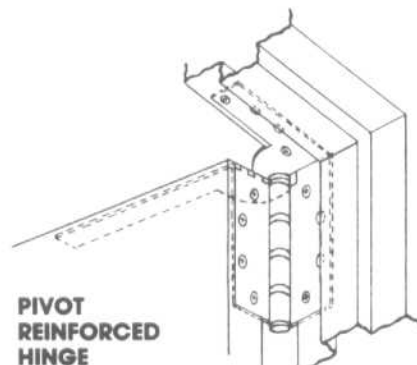
**NOTE:** Anchor hinges and pivot hinges should be specified for heavy doors and doors with high frequency use, such as entrances to large department stores, office buildings, theaters, banks and schools, or to toilet rooms in schools and airport buildings. Regular weight hinges may be specified for doors with average and low frequency uses such as corridor doors in public buildings and doors in residential buildings.

**ANCHOR HINGE**

Heavy weight hinge with each leaf extended at its top edge and bent to form a flange that fastens to top edge of door and to frame head rabbet. May be used as top hinge on heavy doors and doors having high frequency usage.

**THRUST PIVOT UNIT AND HINGE SET**

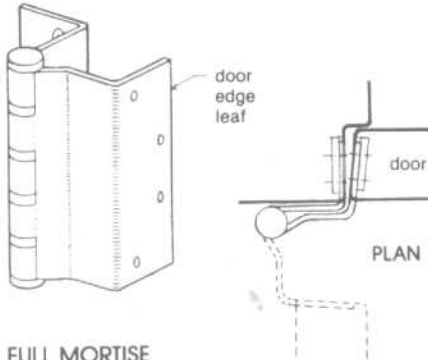
Pivot unit for top of door, with both jamb and top plates for both door and frame. Used, with conventional butt hinges, on wide doors that may be subjected to abnormal abuse. The hinge is almost invisible when door is closed.

**PIVOT REINFORCED HINGE**

Heavy weight hinge with added pivot on the same pin. Leaves of pivot are interlocked with hinge leaves. Used with conventional butt hinges on doors subject to abnormal abuse, particularly with overhead closers.

**DOORS**

Hollow Metal Door Hardware: Hinges



**FULL MORTISE**

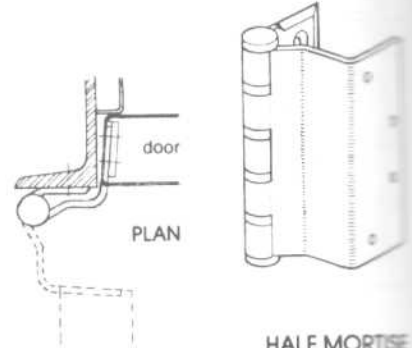
Both leaves bent; one mortised into frame rabbet, the other into door edge.

**HOSPITAL "SWING CLEAR" TYPES**

These hinges have their pins located approximately 2" beyond the door edge, providing an unobstructed clear frame opening width when the door is open 90°.

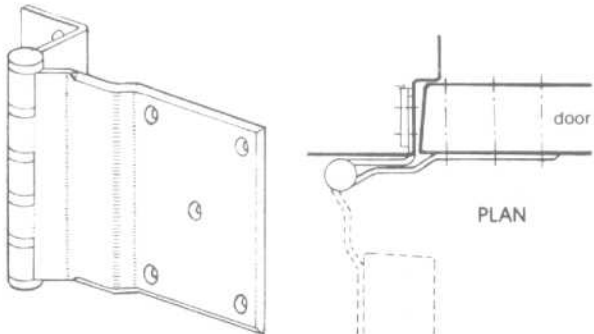
They are used on hospital corridor doors to patients' rooms, operating rooms, emergency rooms, or wherever a completely clear opening is required in hospitals, institutional or public buildings.

Swing clear hinges are available only in heavy weight



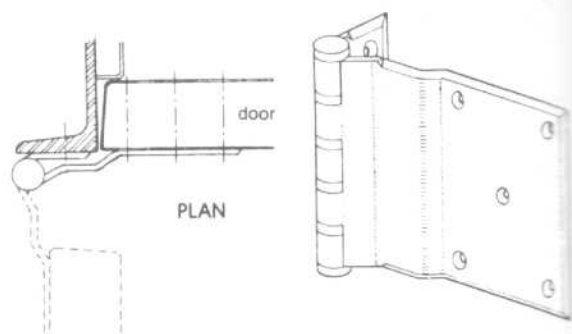
**HALF MORTISE**

One bent leaf mortised into edge of door, one flat, bevel-edged leaf surface-mounted on frame face.



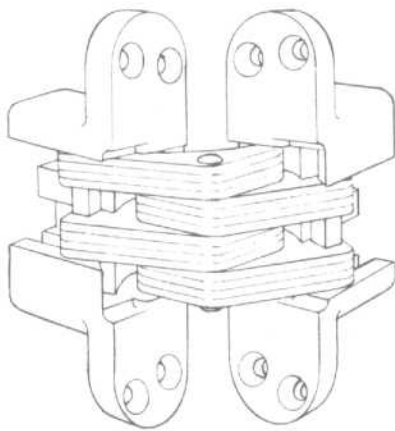
**HALF SURFACE**

Offset bevel-edged leaf surface-mounted on door face, bent leaf mortised into frame rabbet.



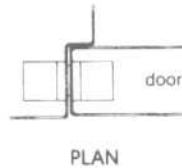
**FULL SURFACE**

Offset bevel-edged leaf surface-mounted on door face, other bevel-edged leaf surface-mounted on frame face.

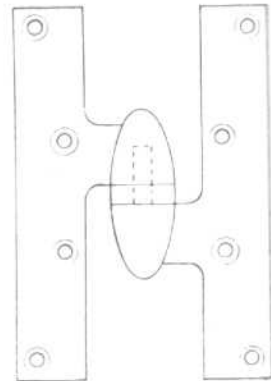
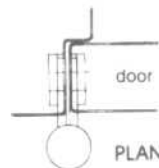


**INVISIBLE HINGE**

Full mortised, centered on door thickness. Hinge is completely concealed when door is closed.



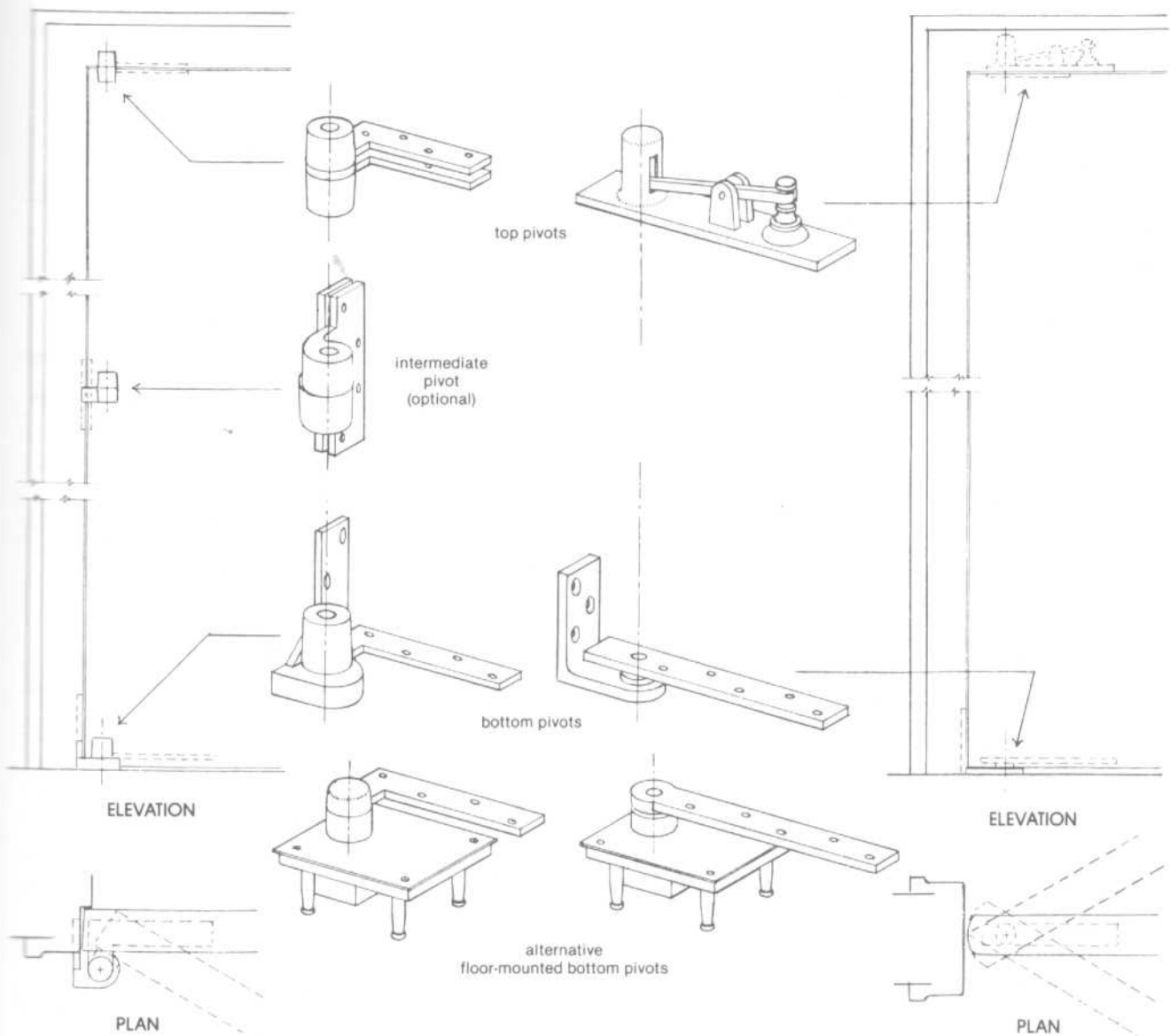
Full mortised; door leaf usually centered on door thickness. When door is closed, only the knuckle is visible.



**OLIVE KNUCKLE HINGE (PAUMELLE HINGE SIMILAR)**

## DOORS

## Hollow Metal Door Hardware: Pivots

**OFFSET TYPE**

Used on single-acting doors only. Need for intermediate pivot depends upon the size, weight and usage of door; recommendation of hardware manufacturer should be followed. Pivot knuckles visible when door is closed.

**CENTER TYPE**

Used at top and bottom of double-acting doors only. Pivots are completely invisible when door is closed.

Pivots are stronger and more durable than hinges and are better able to withstand the racking stresses to which doors are subjected. Their use is generally recommended on oversize doors, on heavy doors such as lead-lined doors, and on entrance doors to public buildings such as schools, theaters, banks, store and office buildings.

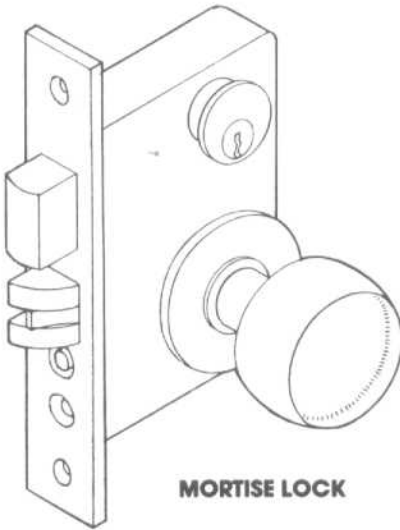
**NOTE:** Because of adjustments that must be made during the installation of doors with bottom pivots, it is recommended that reinforcements be furnished in blank and that drilling and tapping be done in the field by the contractor.

**DOORS**

Hollow Metal Door Hardware

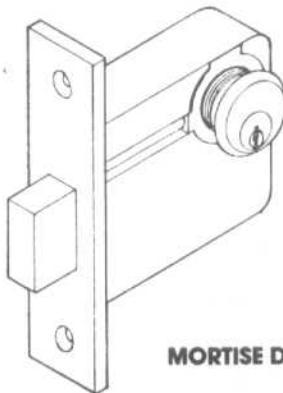
**LOCKS, LATCHES, AND DEADLOCKS**

The selection of the proper lock type is very important. The types shown here are those most commonly used, but are by no means the only types available. Their names serve to identify either the type of lock construction or the type of installation. Mortise locks provide the greatest variety of lock functions, the best security, and excellent durability. Another popular type, with rugged construction and easily operated, is the preassembled lock, which is completely assembled at the factory. It does not have as many lock functions as the mortise lock, but can have a separate deadbolt. The bored lock is the least secured type and is not available with a separate deadbolt in the lock.



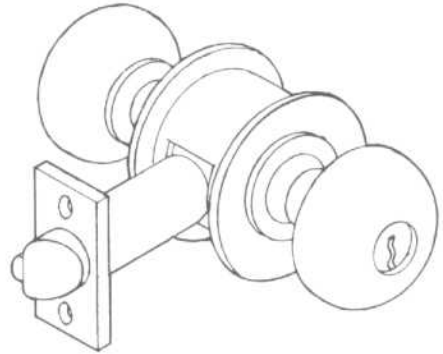
**MORTISE LOCK**

The mortise lock is so named because it is installed in a prepared recess (mortise) in the door. Working parts are contained in a rectangular case with holes for cylinder and knob spindle. Anti-friction split bolts are available for smooth retraction of the lock bolt. Lock front may be armored to protect against burglars getting at cylinder screws and lock fasteners. Lever handles may be used if desired, and trim may be either sectional or full plate.



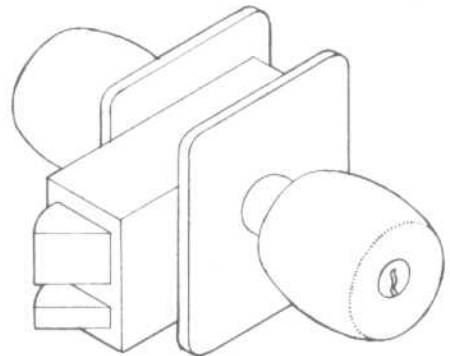
**MORTISE DEADLOCK**

This is a mortise lock with a deadlock only. (A deadlock is a lock bolt which has no bevel or spring action, and is operated by a key or thumb turn.) It is often used for locking a door having push or pull plates or for providing added security on doors with cylindrical locks.



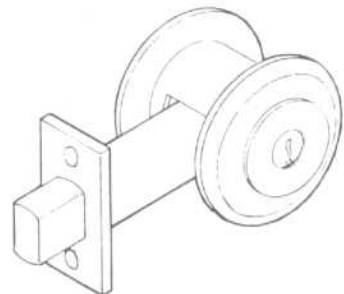
**BORED (CYLINDRICAL) LOCK**

This type of lock uses the key-in-the-knob principle. It is installed in a door having one hole bored through the thickness of the door and another bored in from the edge. The assembly must be tight on the door, without excessive play, to avoid binding.



**UNIT LOCK**

This lock is preassembled in the factory and consists of a one-piece extruded or cast brass frame within which all parts are contained. It is installed in a rectangular reinforced notch in the door edge. Lever handles may be used in place of knobs.



**BORED (CYLINDRICAL) DEADLOCK**

This is a cylindrical type of lock having a deadbolt only. It fits into the same type of cylindrical cutout as that required for the bored lock.

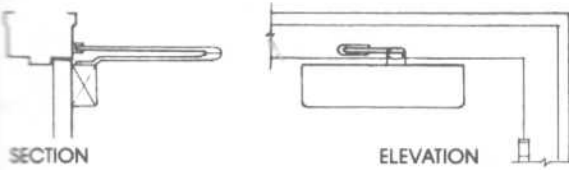
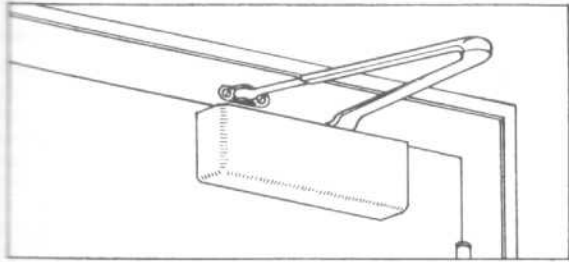
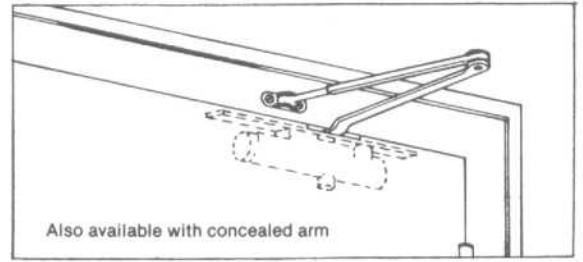


Fig. 3 Surface mounted, on hinge face of door.



Also available with concealed arm

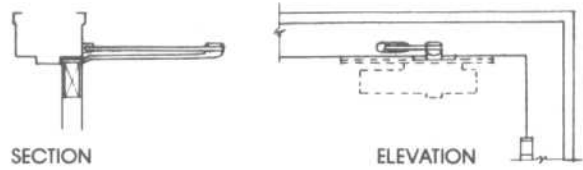


Fig. 4 Concealed in door, with exposed arm.

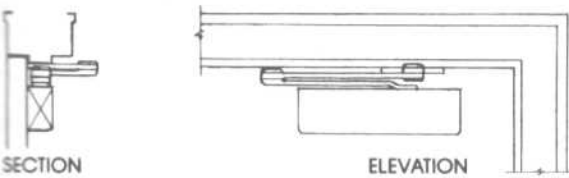
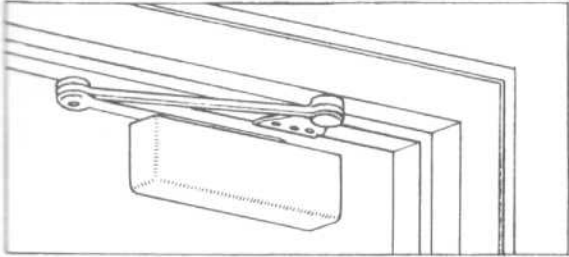


Fig. 5 Surface mounted, on stop face of door.

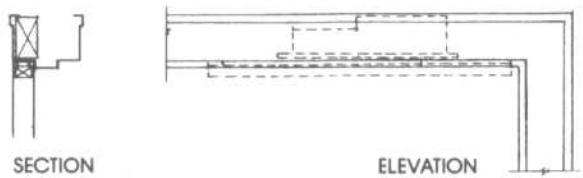
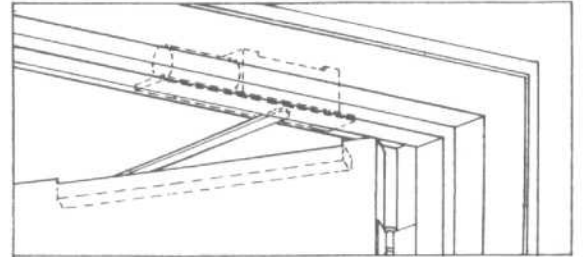


Fig. 6 Concealed in head, with concealed arm.

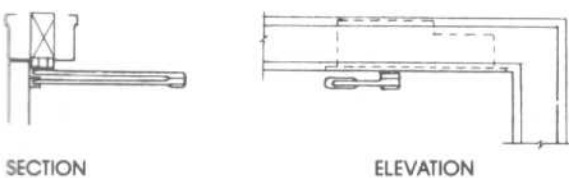
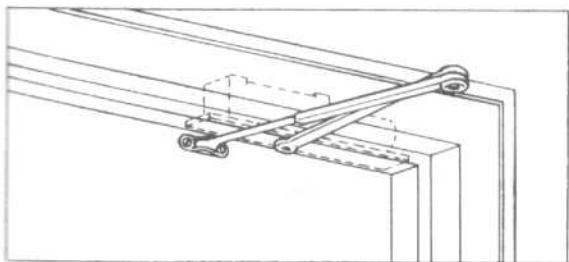


Fig. 7 Concealed in head, with exposed arm.

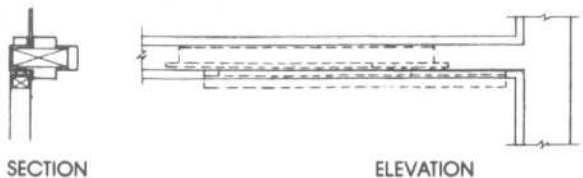
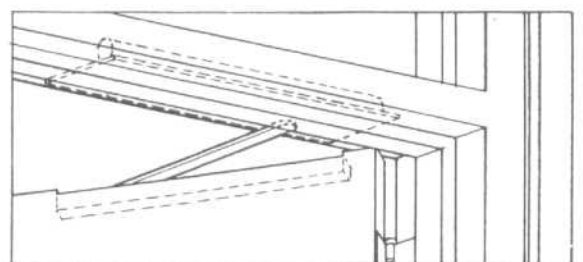


Fig. 8 Concealed in transom bar.

**DOORS**

**Hollow Metal Door Hardware: Floor Closers**

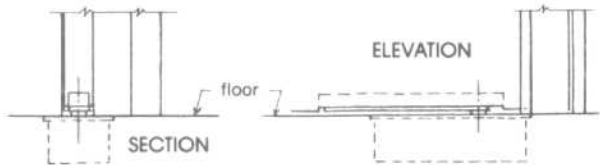
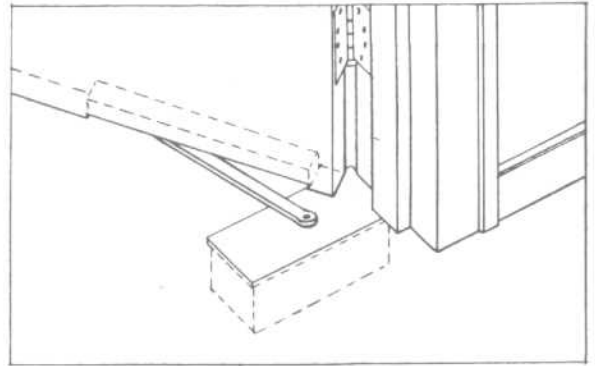
**OVERHEAD AND FLOOR CLOSERS**

Overhead closers (Figs. 3 to 8) are hydraulic devices, containing a piston, fluid chambers, and a spring. When the door is opened the piston is pulled back, the spring is compressed, and the fluid is moved from one side of the piston to the other. With release of the door a reverse action takes place, closing the door. Closing speed is controlled by an adjustable valve or valves. Overhead closers may be installed on either single- or double-acting doors.

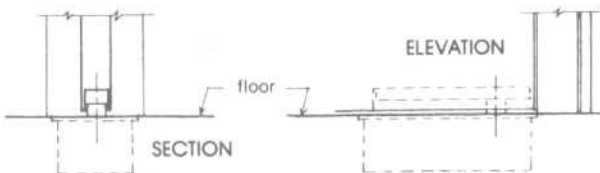
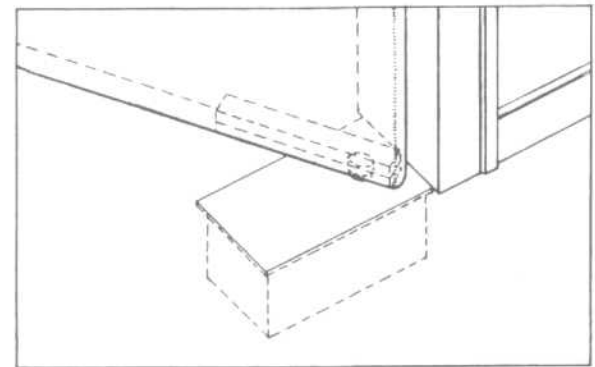
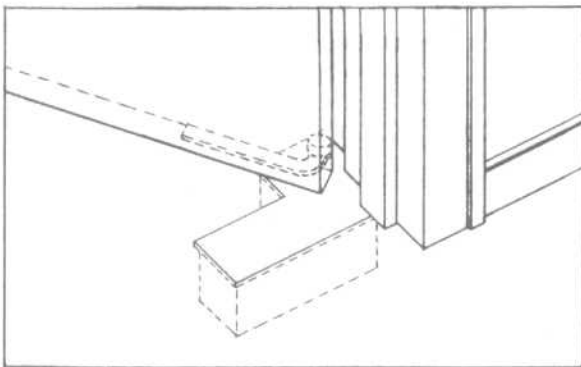
Floor closers, generally more durable than overhead closers, provide concealed closing mechanisms often appropriate for doors having a high frequency of use. As shown, the type of closer used depends on whether the door is hung on hinges, offset pivots, or center pivots.

Both overhead and floor closers are available in a range of sizes for various door sizes, locations, and job conditions. The manufacturer's recommendations should always be followed in determining which size and type should be used.

Where surface-mounted closers are specified, internal reinforcement plates shall be provided in the door and frame by the manufacturer. Drilling and tapping for the closer shall be done in the field by the installer. Only after the door is installed and adjusted can the closer be mounted for proper operation. If drilling and tapping have been done at the factory, the necessary field adjustments become difficult if not impossible.



**FOR HINGED DOORS**



**FOR OFFSET PIVOTED DOORS**

**FOR CENTER PIVOTED DOORS**

single acting

either single or double-acting

**PANIC AND FIRE EXIT HARDWARE**

**Types of Installation**

Panic hardware is tested and labeled for casualty only, fire exit hardware for both casualty and fire resistance. Only the latter may be used where fire rated doors are required. Both types are always releasable from the inside by depressing the crash bar. The mortise type (Fig. 9) and the concealed vertical rod type (Fig. 10) are the least conspicuous, and either of these types is readily applicable to custom hollow metal doors.

Rim and mortise types are used on

- Single door
- Active door of pair
- Both doors of pair with mullion

Vertical rod types are used on

- Single door
- Active door of pair
- Both doors of pair

Where rim type (Fig. 11) or exposed vertical rod (Fig. 12) exit devices are specified, internal reinforcement plates shall be provided in the door and frame by the manufacturer. Drilling and tapping for trim and mounting plates shall be done in the field by the installer. The hardware can then be more readily adjusted for best operation.

In preparing the door for a lock, the drilling of three bolt holes (1/2" dia. or less) and/or the drilling and tapping for sectional or full trim plates shall be done in the field by the installer and not at the factory. After the lock is installed and adjusted, the trim plate can be applied to suit the final position of the latching device. If thru bolt holes or tapped holes are provided at the factory, this adjustment becomes difficult if not impossible.

The manufacturer shall drill for all function holes, i.e., cylinder, turn piece, and knob.

**Door Coordinators**

Coordinators (Figs. 13 and 14) are used on pairs of doors having overlapping astragals and closers. When both leaves are open, the coordinator holds the active leaf open until the inactive leaf is closed, preventing interferences of the astragal.

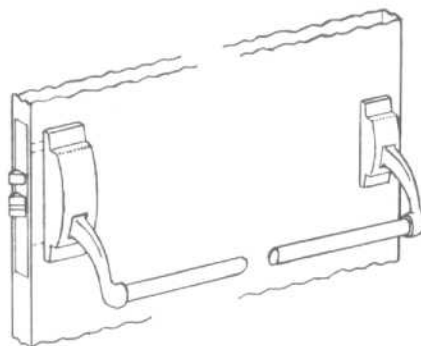


Fig. 9 Mortise type exit device.

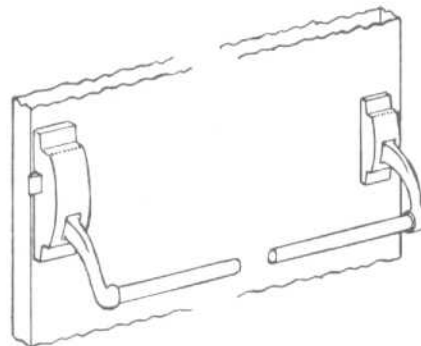


Fig. 11 Rim type exit device.

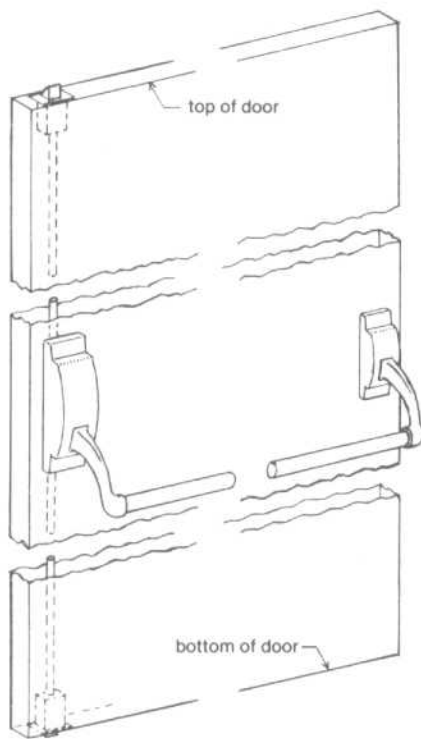


Fig. 10 Concealed vertical rod type exit.

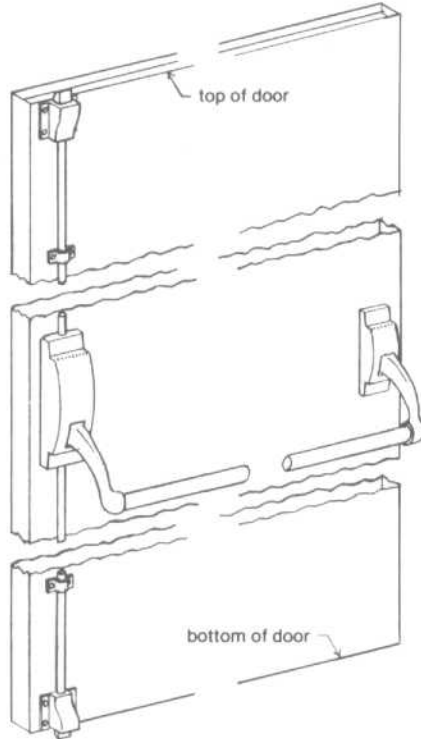


Fig. 12 Exposed vertical rod type exit device.

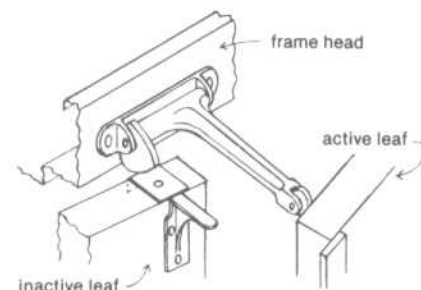


Fig. 13 Surface-mounted type door and coordinator.

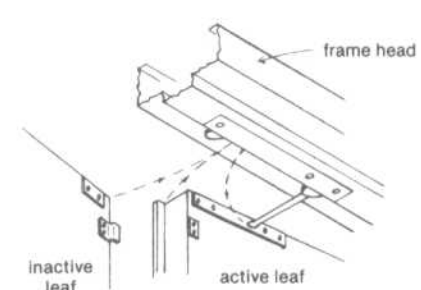


Fig. 14 Mortised type door coordinator.

**DOORS**

**Hollow Metal Door Hardware**

**FLUSH BOLTS**

These bolts are installed on the inactive leaf of a pair of doors to secure it in the closed position to serve as a latching point for the active leaf. They may also be used as auxiliary locking devices for added security. Bolts may be either surface-mounted or flush (concealed rod); only the latter type is illustrated in Fig. 15.

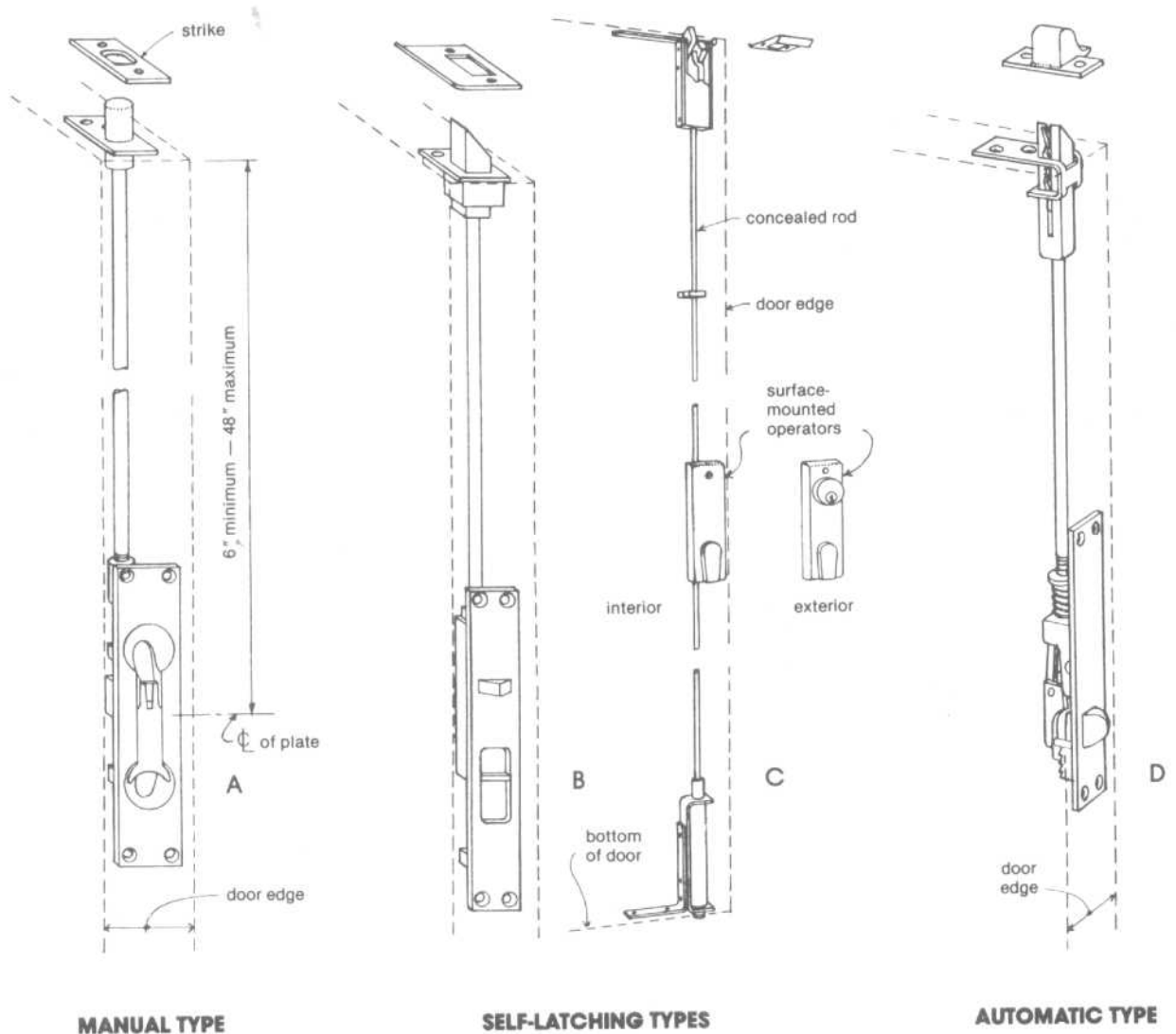
There are many variations of these flush bolts; only the more common types being shown in Fig. 15. Due to the variety of frame

construction encountered, the selection of the most appropriate type of strike is particularly important, and clearance at the floor must be very carefully controlled to insure proper engagement.

The manual type (Fig. 15A) requires hand operation of the operating lever for both latching and unlatching. The variable length of the extension rod, however, permits convenient location of the operating mechanism in the door edge. The self-latching types

(Fig. 15B and C) latch automatically when the inactive leave is closed, but must be unlatched manually. The automatic type (Fig. 15D) both latches and unlatches automatically when the inactive leaf is closed or opened.

None of these types of flush bolt should be used on doors that are intended to serve as emergency exists. NFPA pamphlet 80 should be consulted for the selection of bolts for fire-rated pairs of doors.

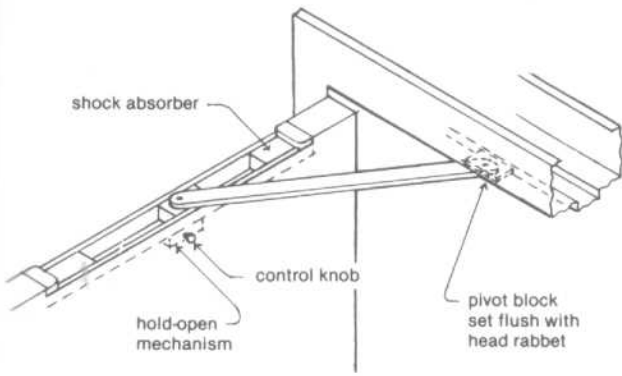


U.L.-APPROVED BOLTS ARE REQUIRED AT BOTH TOP AND BOTTOM OF INACTIVE LEAF OR FIRE-RATED PAIRS OF DOORS

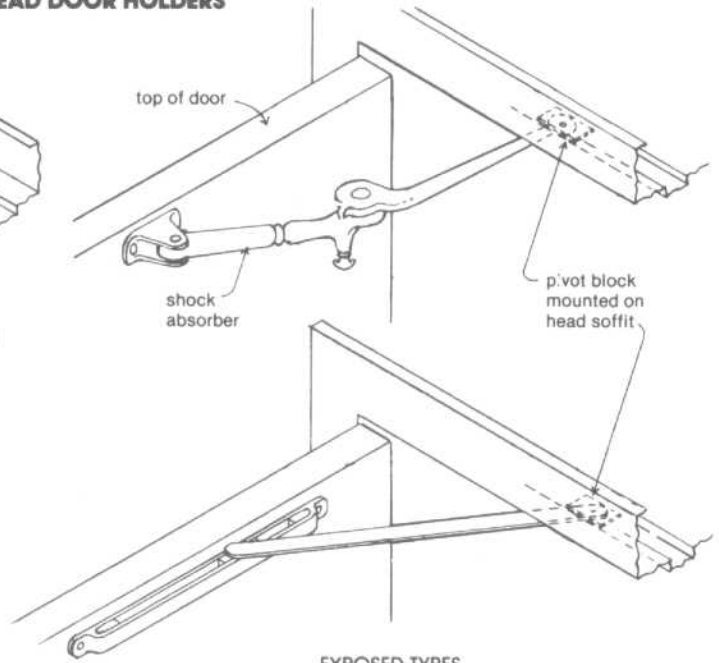
Fig. 15 Except for Type C, only top bolts are shown; bottom bolts are similar in all cases.



**OVERHEAD DOOR HOLDERS**

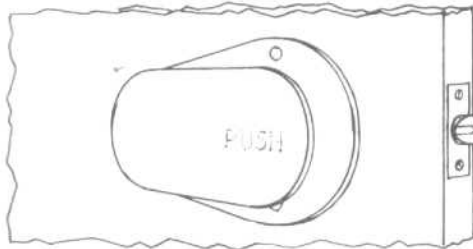


**CONCEALED TYPE**  
For single- or double-acting doors

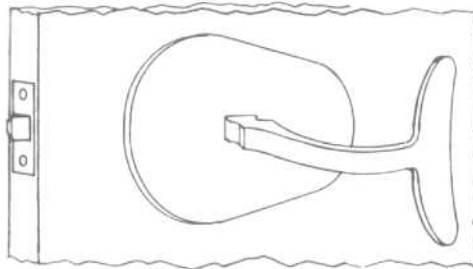


**EXPOSED TYPES**  
For single-acting doors only

These are devices used to limit and control the swing of the door or hold it in the open position. By controlling the door action they serve to protect against damage to the door and/or hinges caused by abusive usage, and damage to the holder caused by violent opening of the door.



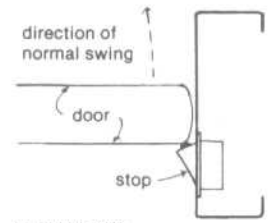
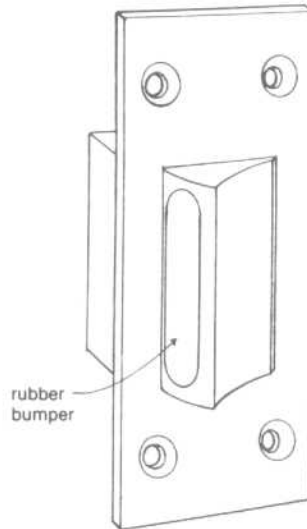
**PUSH LEVER**



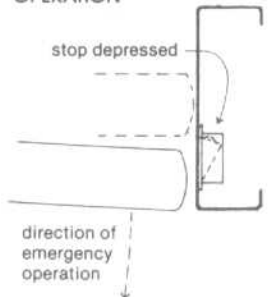
**PULL LEVER ON OPPOSITE FACE**

**HOSPITAL DOOR LATCH**

Designed primarily for use in hospitals, on corridor doors leading to patient rooms. May also be used on any door requiring push-pull operation, particularly by forearm or elbow, when hands are engaged in carrying objects.



**PLAN VIEWS ILLUSTRATING OPERATION**

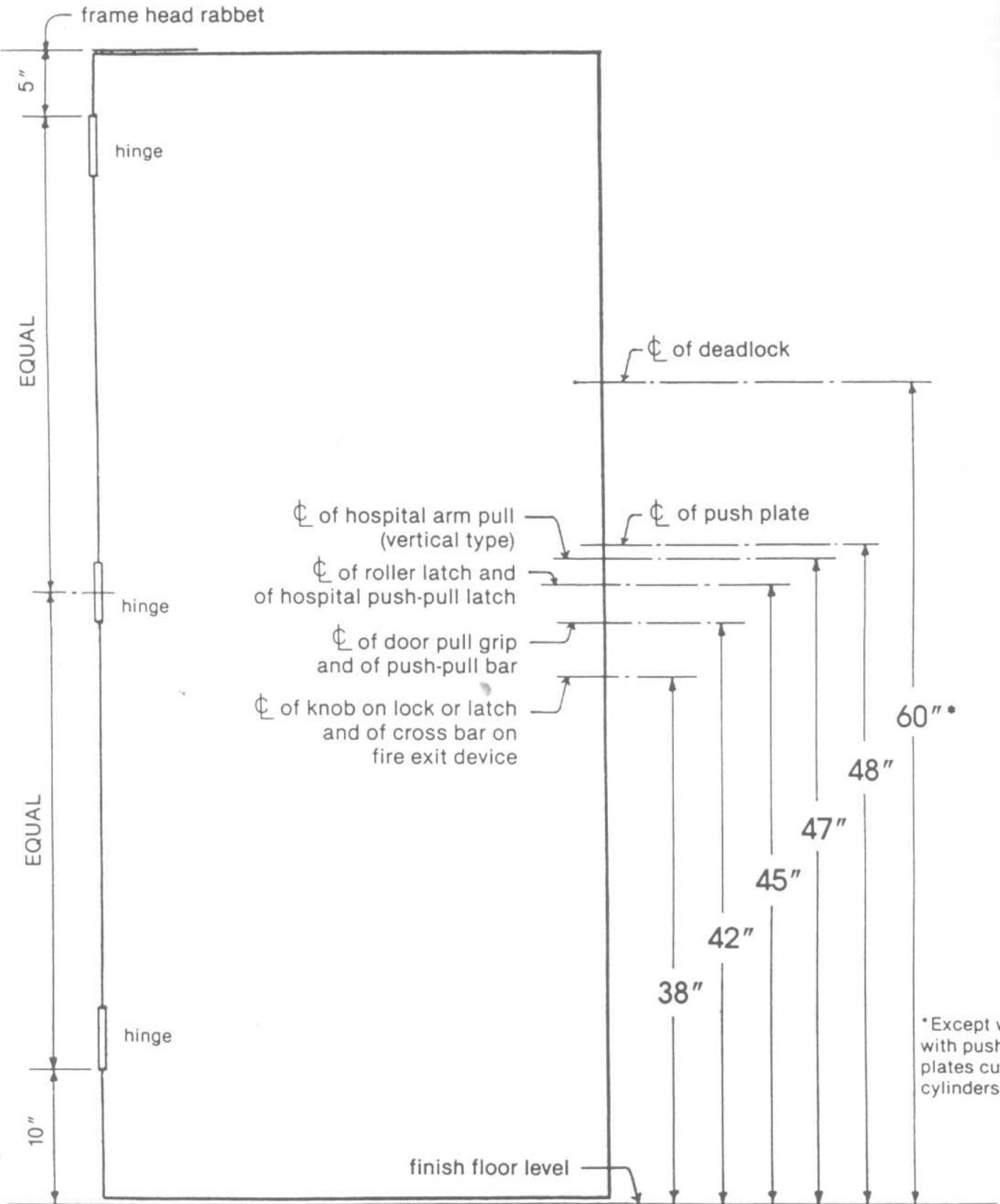


**EMERGENCY DOOR STOP**

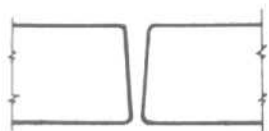
Intended primarily for use in hospitals, on doors between patient rooms and toilets. This stop permits door to be opened from the stop side in the event that an incapacitated patient should block the normal swing by falling. Door must be hung on center (double-acting) pivots.

**DOORS**

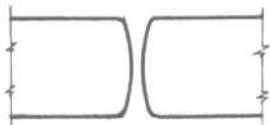
Hardware Locations



\* Except when with push-pull plates cut for cylinders.



V-BEVEL



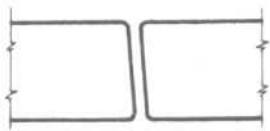
BULLNOSE

Used on double-acting center-pivoted doors

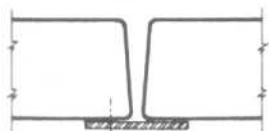


RABBETED

These two types may be used on double egress doors

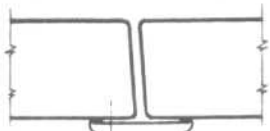


PARALLEL BEVEL



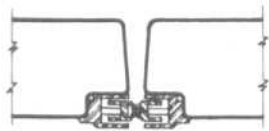
V-BEVEL

with flat surface astragal



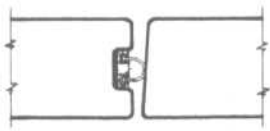
PARALLEL BEVEL

with molded surface astragal



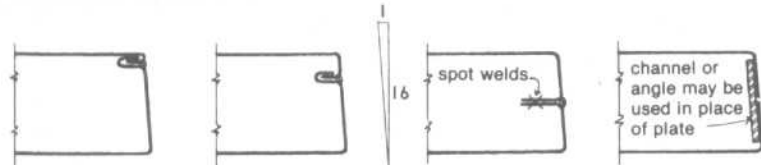
RECESSED ADJUSTABLE ASTRAGAL

Surface-mounted type also used

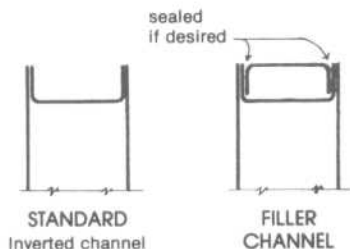


RECESSED WEATHERSTRIPPING

**COMMON MEETING STILE EDGE PROFILES**



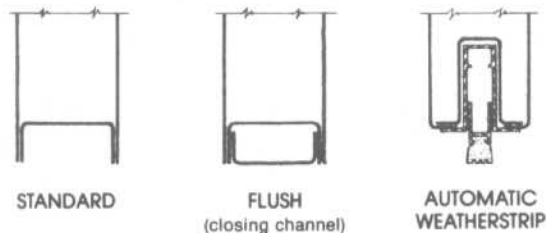
All joint seams continuously welded and ground smooth



**STILE EDGE DETAILS — TYPE A DOORS**

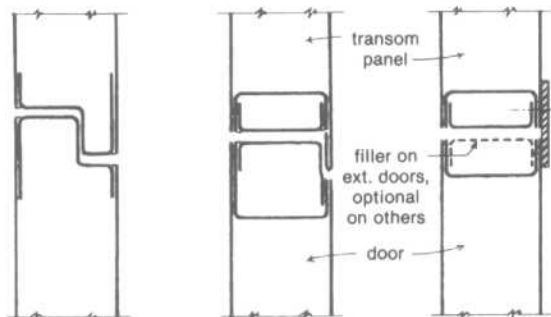
**TOP EDGE DETAILS**

HARDWARE REINFORCEMENTS are provided on doors wherever hardware is to be attached, to insure that it is firmly and securely fastened.



Other designs available as required

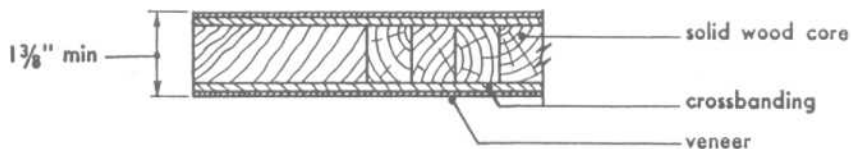
**BOTTOM EDGE DETAILS**



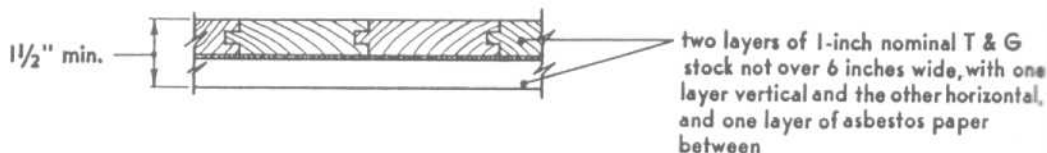
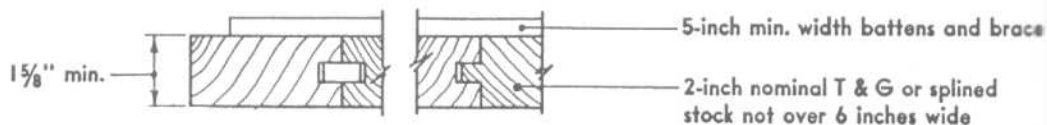
**TOP EDGE DETAILS WITH FLUSH TRANSOM PANEL ABOVE**

**DOORS**

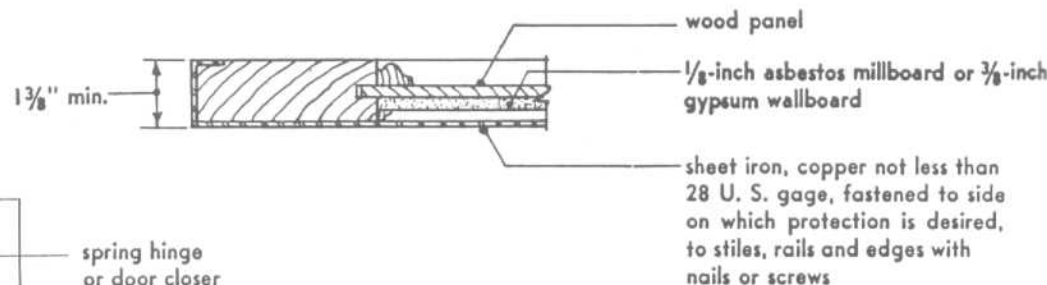
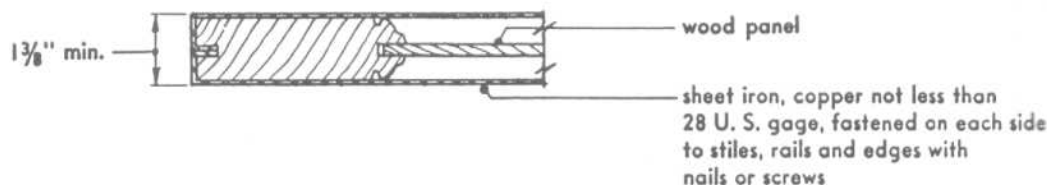
Fire-Protected Wood Doors



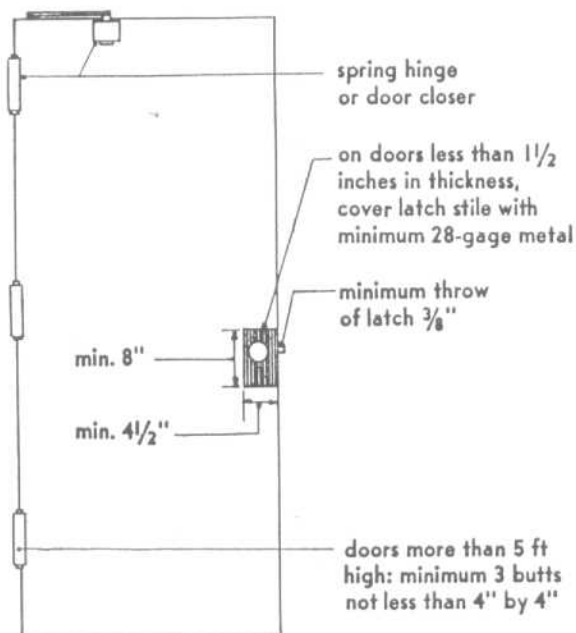
**SOLID WOOD CORE FLUSH DOORS**



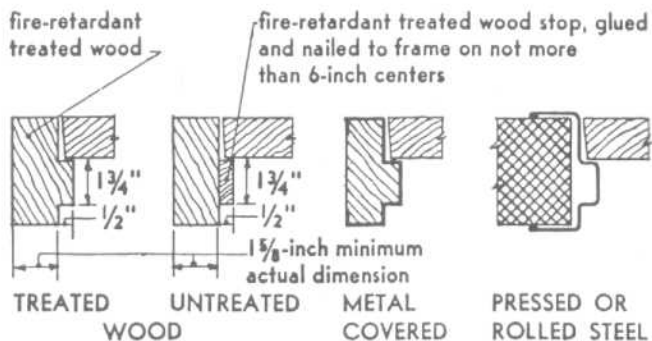
**BATTENED DOORS**



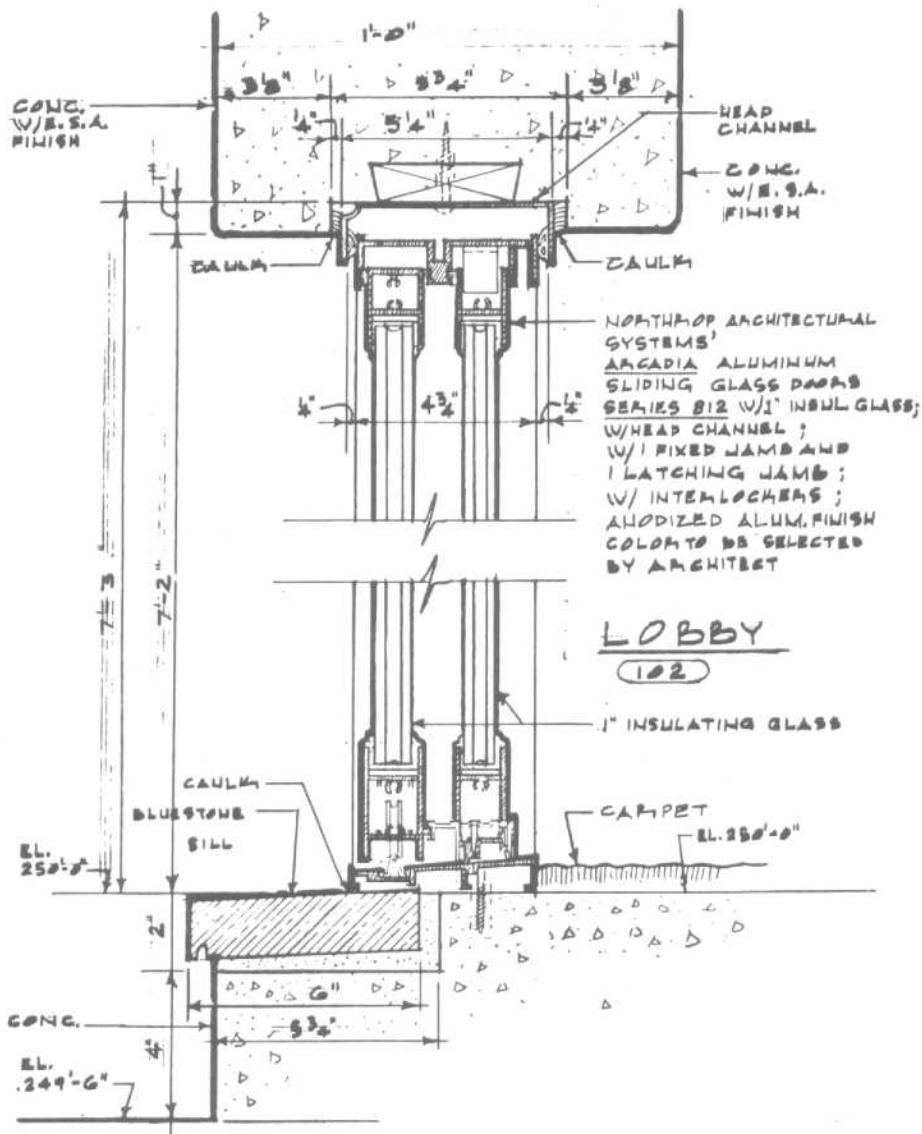
**PROTECTED PANEL DOORS**



**HARDWARE**



**FRAMES**



LOBBY  
102



3'-1'-0"

DOORS

Thresholds

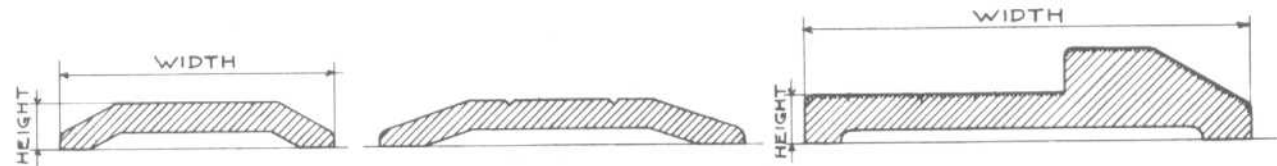
Thresholds are essential for nearly every type of door. Usually a standard section is satisfactory. Where conditions require, special sections may be designed.



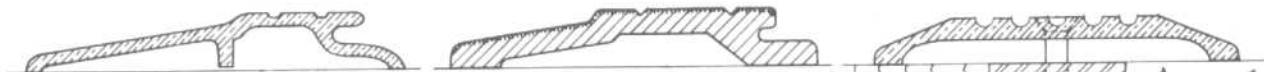
Thresholds of plain surface, extruded or rolled.



Thresholds with fluted surface, extruded or rolled.



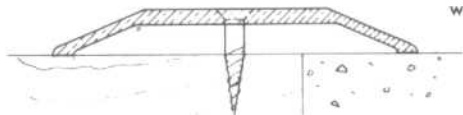
Thresholds cast with plain or abrasive surface.



Thresholds for weather strips.

Holes for fastening not to exceed 12" o.c. for threshold less than 3" wide. For thresholds over 3" fastenings should not exceed 15" o.c. On wide sills holes may be staggered.

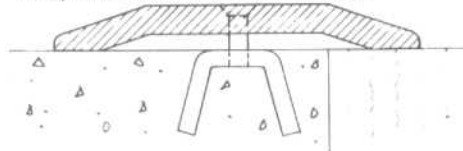
Threshold fastened with screws tapped to steel angle set in floor construction.



Threshold fastened to wood with wood screws.



Threshold fastened with screw in fibre plug or expansive metal anchor. Floor may be cement, terrazzo or similar construction.



Threshold fastened with screws tapped to clips set in cement.

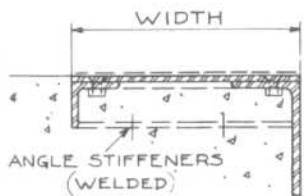
THRESHOLD SIZES AND METAL									
FIG.	WIDTH	HEIGHT	CAST	STEEL	BRASS	BRONZE	ALUMINUM	NICKEL SILVER	
14	2 1/2"	1/4"		o	o	o	o	o	
15	3"	1/4"		o	o	o	o	o	
16	4"	1/2"		o	o	o	o		
17	3"	5/16"		o	o	o	o		
18	4"	1/2"		o	o	o	o		
19	5"	1/2"		o	o	o	o		
20	6"	5/8"			o	o	o		
21	7 1/2"	1/2"					o		
22	3"	1/2"	o						
23	4"	1/2"	o						
24	5"	1/2"	o						
25	4 3/16"	5/8"			o	o	o		
26	4" 5" 6"	5/8"	o						

Cast metal may be iron, aluminum, bronze, or nickel silver, with or without abrasive surface.

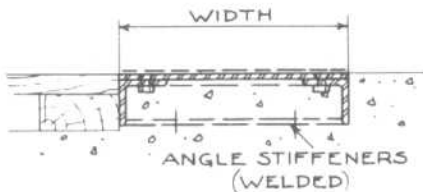
These thresholds are representative of a great many sections produced in various metals, widths, heights, and types of surface. For other sections refer to manufacturers' catalogs.

DOORS

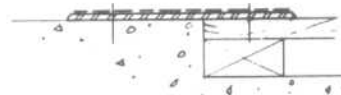
Thresholds and Joint Strips



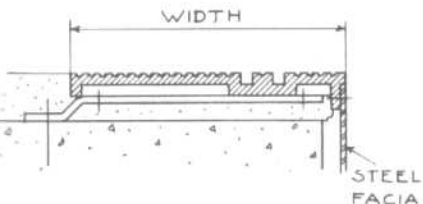
Steel loading door threshold anchored to concrete



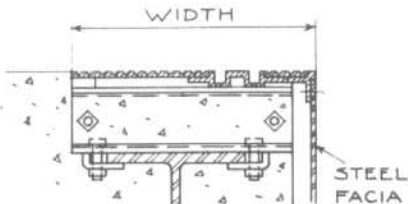
Steel shipping door threshold anchored to concrete



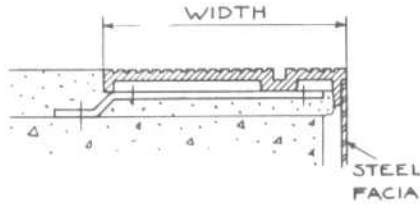
Steel shipping door threshold screwed to floor



Elevator door threshold for double doors cast with grooves. Surface may be abrasive or plain of cast iron, aluminum or bronze.

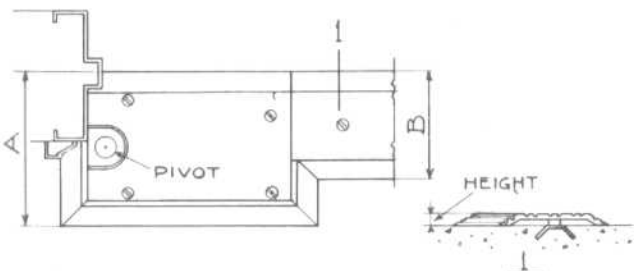


Elevator door threshold for double doors of rolled sections, steel, bronze or aluminum.

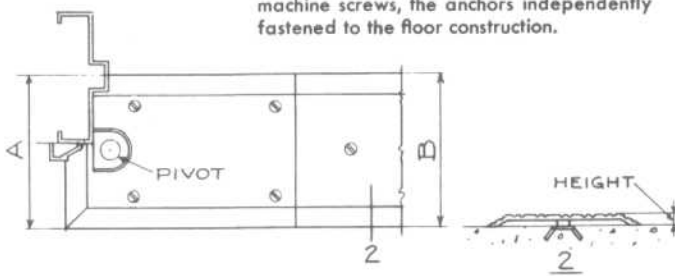


Elevator door threshold for single doors cast with grooves. Surface may be abrasive or plain of cast iron, aluminum or bronze.

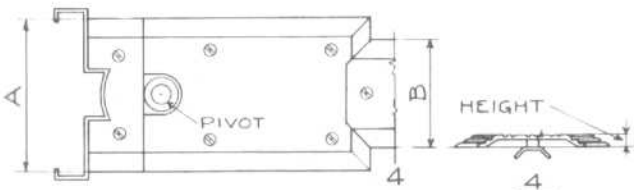
Thresholds with concealed steel anchors are usually fastened to anchors with flat head machine screws, the anchors independently fastened to the floor construction.



Threshold for single acting floor check.

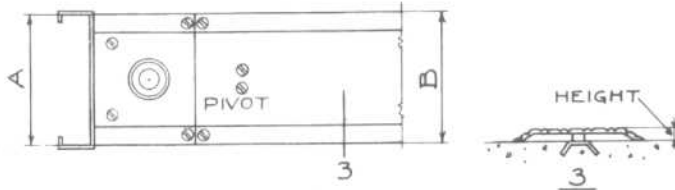


Threshold for single acting floor check.



Threshold for double acting floor check.

SCALE 1/2" = 1'-0"



Threshold for double acting floor check.

Thresholds for floor checks may be obtained in the same metals and sections as standard thresholds or may be designed to fit special conditions.

All thresholds fitted to floor checks must be designed with removable cover plate.

Screw spacing must fit floor check.

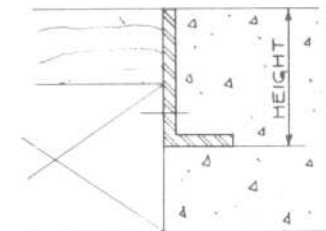
Dimension "A" is determined by type of floor check, usually 5 3/4", 6 3/4" or 7 3/4".

Dimension "B" may be same as "A" or less as specified.

SPECIFY:

- Type, location
- Width, length
- Metal and finish
- Show detail of special requirements

Joint strips, also called dividing strips or division bars, used for separation of floors of different materials, may be of steel or non-ferrous metals. They may be of angles or other sections with anchors attached, or of a patented design.

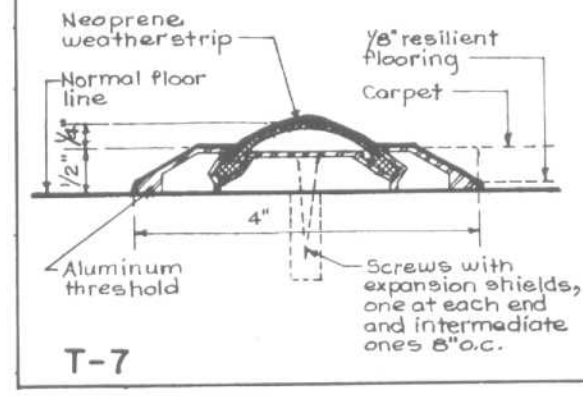
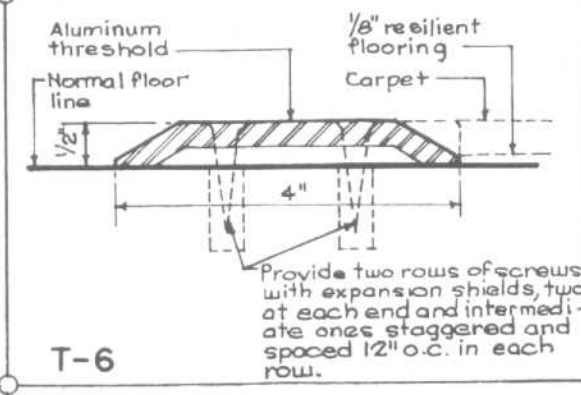
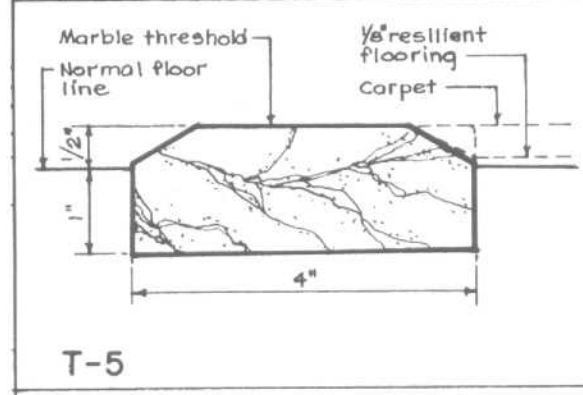
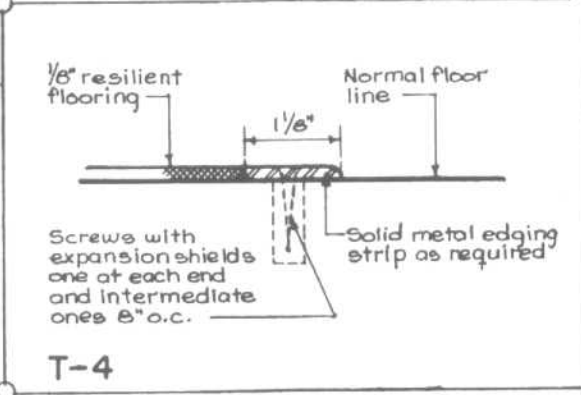
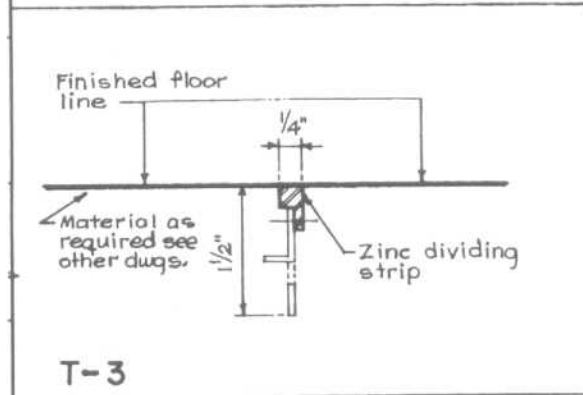
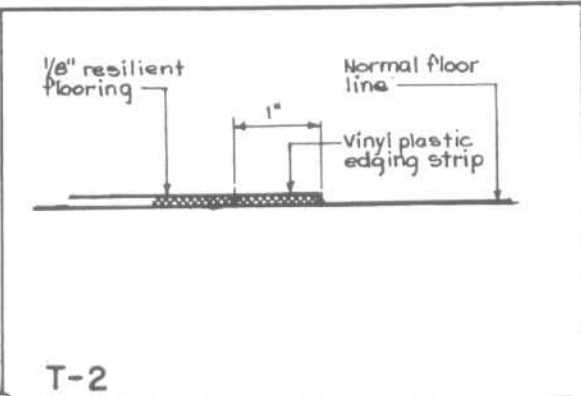
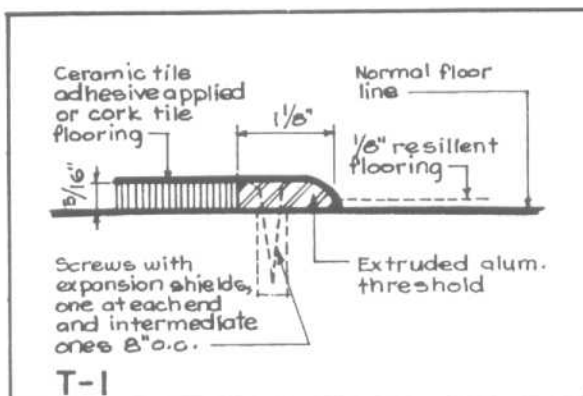


SCALE 1" = 1"

Terrazzo strips for design or pattern work in terrazzo floors are not considered architectural metal.

DOORS

Thresholds and Edging Strips



**NOTES:**

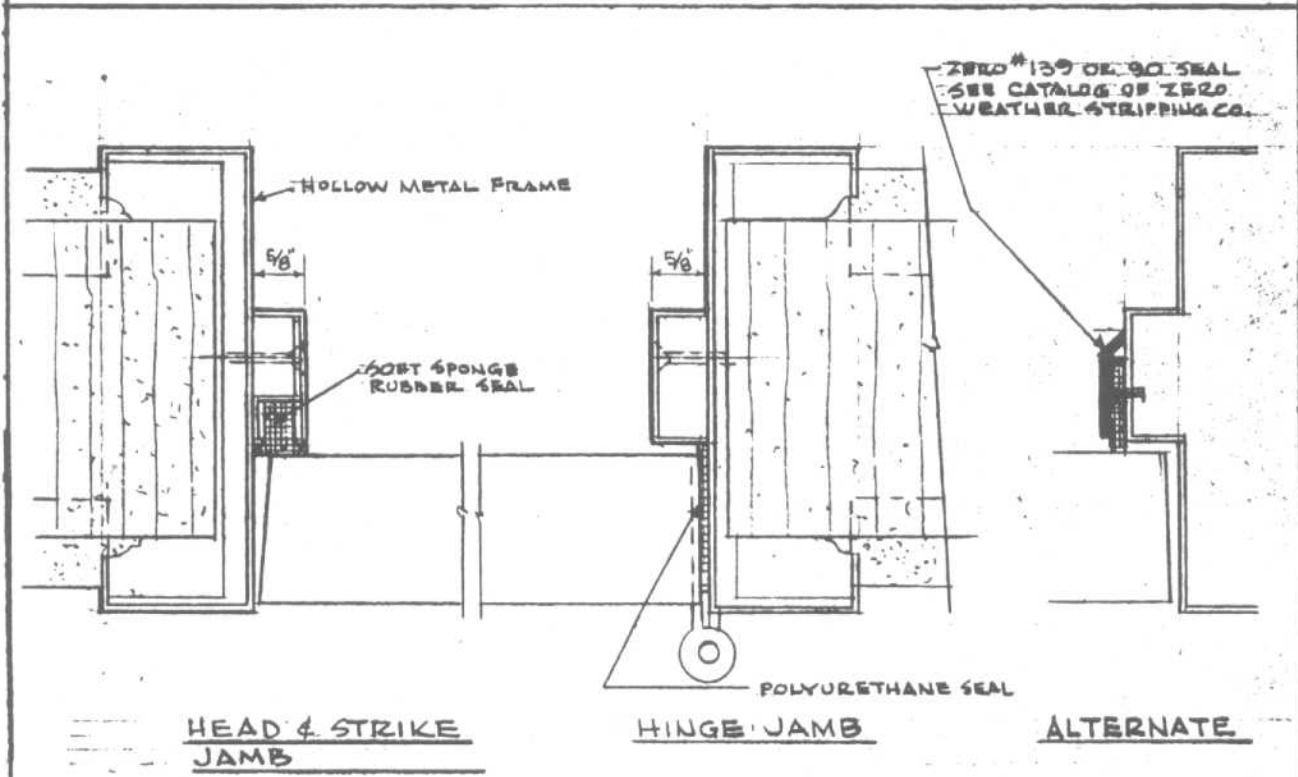
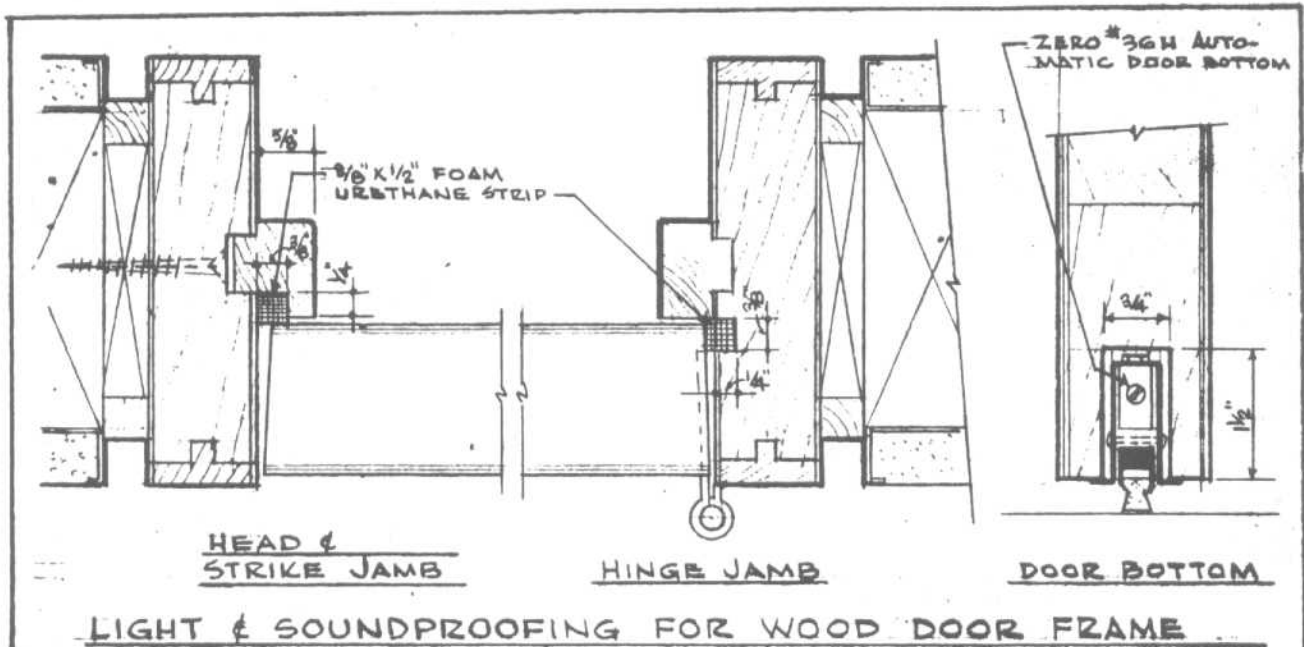
1. For door swing, see other drawings.
2. For schedule of floor finishes, see other drawings.
3. For gauges of metal see specifications.





DOORS

Light- and Soundproofing of Wood and Hollow Metal Door Frames



LIGHT & SOUNDPROOFING FOR HOLLOW METAL FRAME

NOTE: DOOR BOTTOM SIMILAR TO WOOD DOOR ABOVE  
FOR SURFACE MOUNTED AUTOMATIC DOOR BOTTOM  
USE ZERO #365

The prime functions of the door frame are to hold the door and its controls in the opening, and to trim the opening. But frames often serve other esthetic or functional purposes also, such as trimming a wall opening having no door, or enclosing glazed areas that provide through-wall visibility or admitting light and/or air. Hollow metal frames, which are strong, sturdy, and durable, serve all such functions economically.

The variety of configurations available in custom hollow metal frames is virtually unlimited. Illustrated in Fig. 16 are some of the more common and representative types.

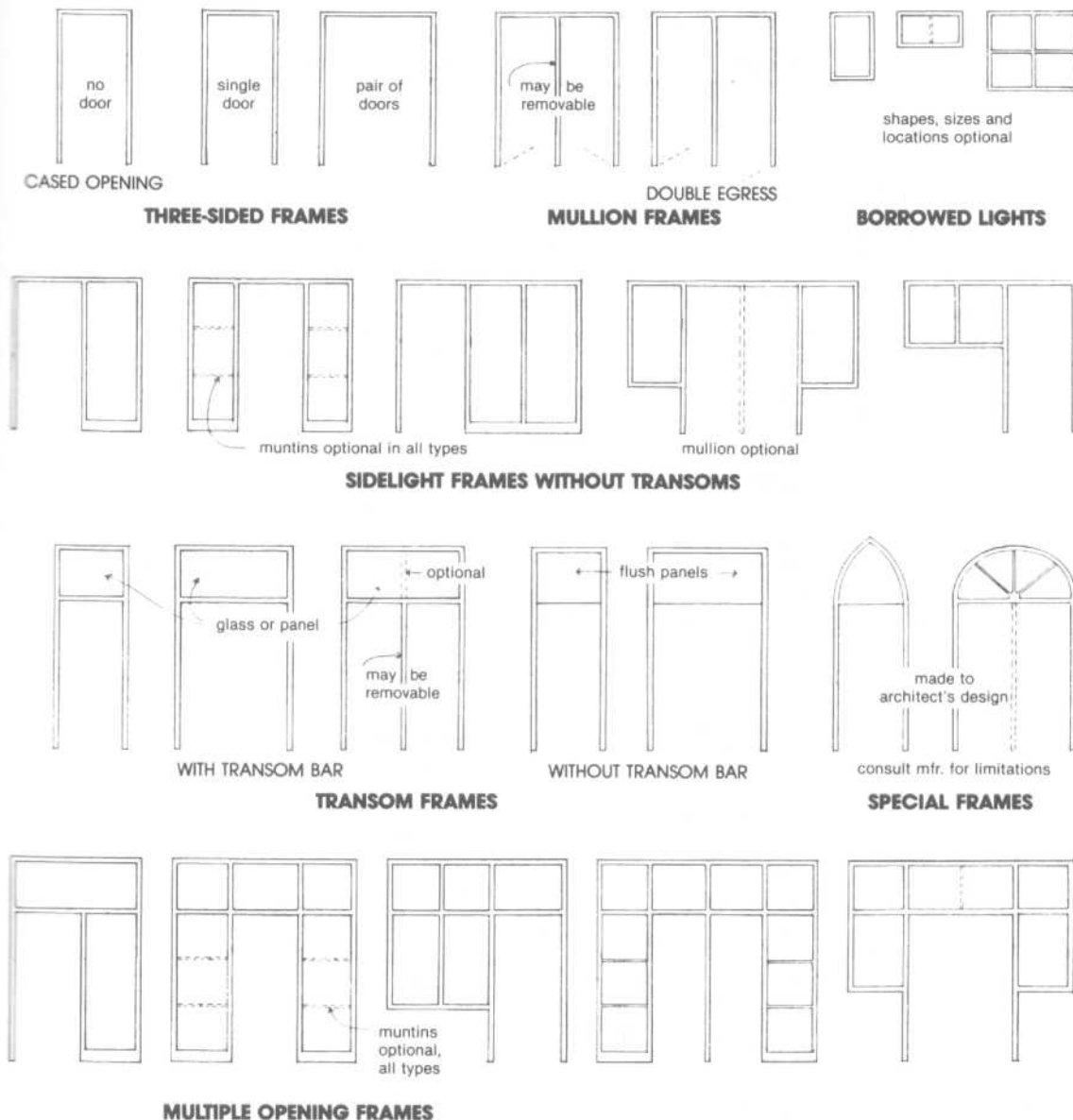
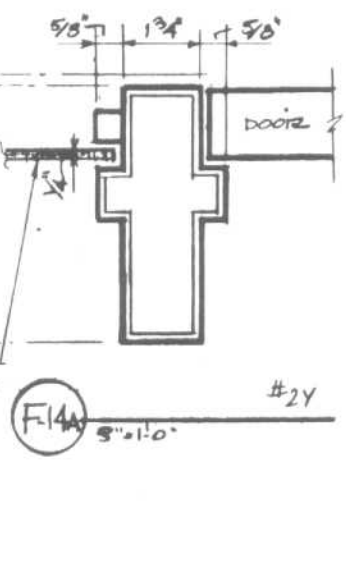
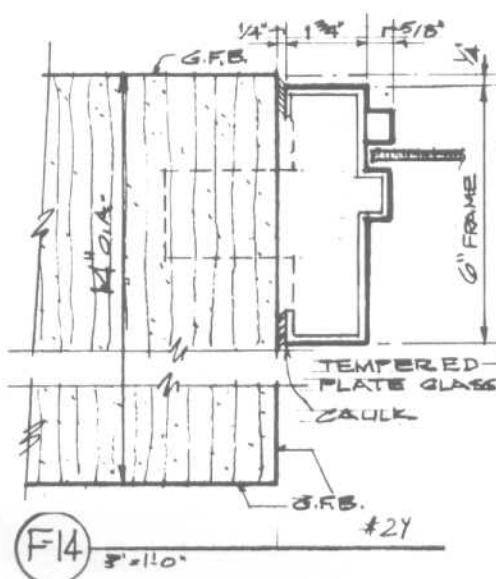
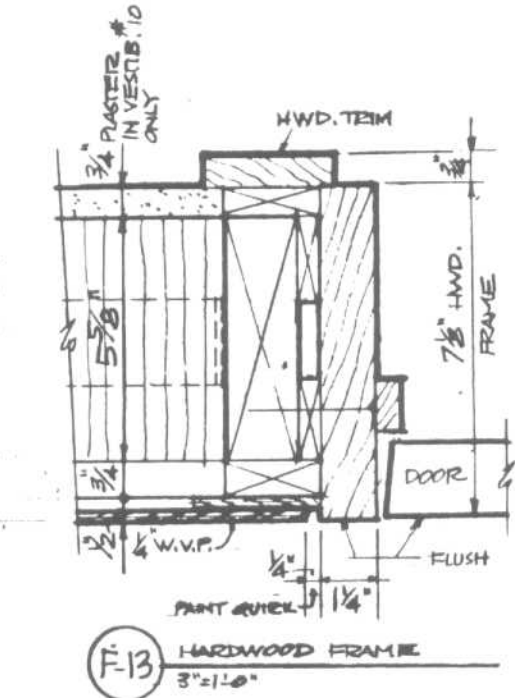
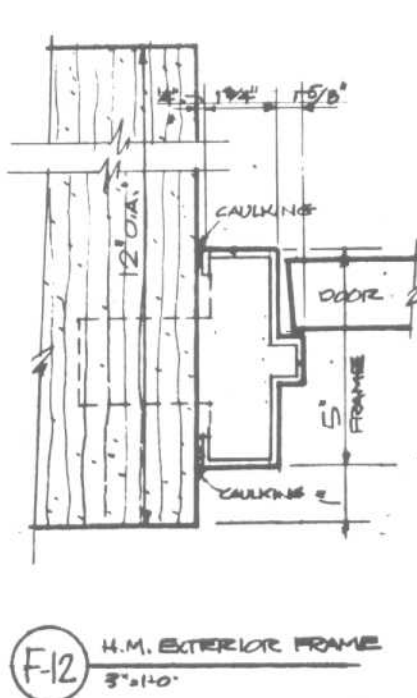
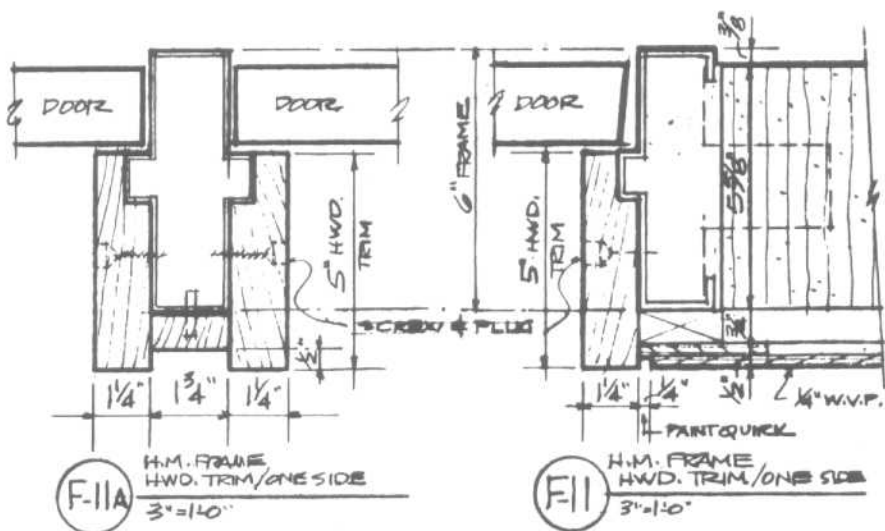


Fig. 16

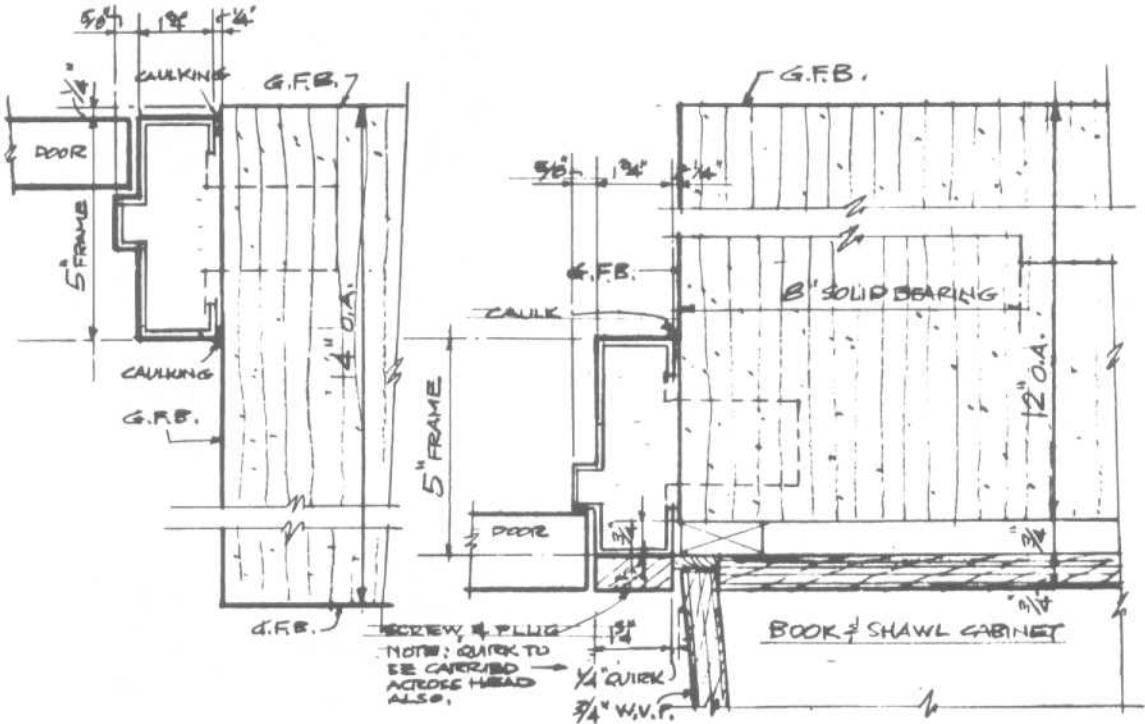
DOORS

Hollow Metal Door Frames



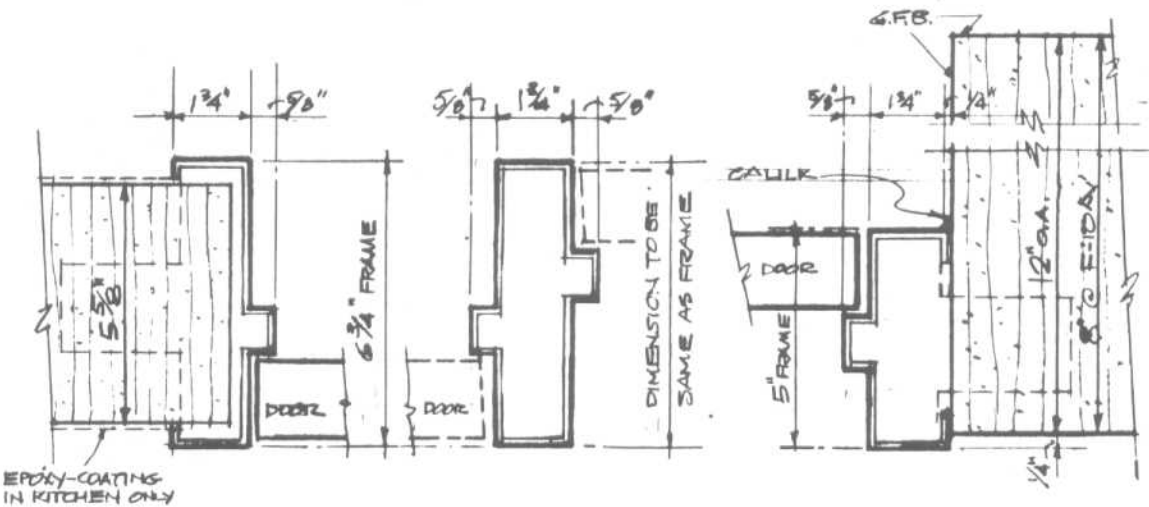
DOORS

Hollow Metal Door Frames



F-6 H.M. EXTERIOR FRAME  
3" x 10"

F-7 H.M. FRAME - HARDWOOD/ONE SIDE  
3" x 10" SEE DETAIL 4/A-20 FOR DOOR #11



EPoxy-COATING IN KITCHEN ONLY

F-8 H.M. FRAME  
3" x 10"

F-9 H.M. MULLION  
3" x 10"

F-10 H.M. FRAME  
3" x 10"

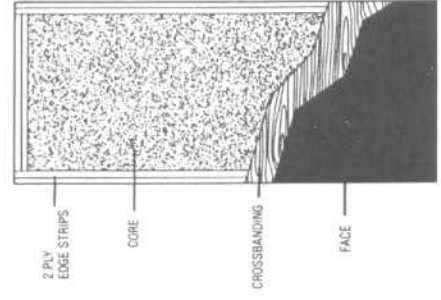
F10A H.M. FRAM.

DOORS

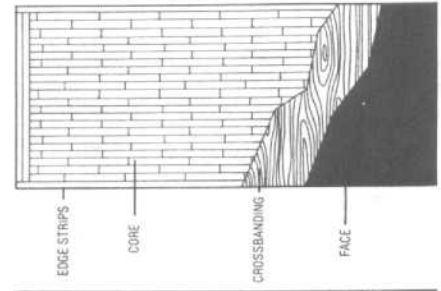
Door Types and Construction

	PARTICLE	STAVE	HOLLOW	ACOUSTICAL ** STC 31, 36, 38, & 40*	LEAD	STILE AND RAIL	THICKNESS MAX. SIZE CORE STILES RAILS FACES CROSSBANDS VENEER MATCHING PREMACHINING OPENINGS SPECIAL DETAILS FINISHING WARRANTY STANDARDS
THICKNESS	1 1/4" - 1 3/4"	1 1/4" - 1 3/4" - 2 1/4"	1 1/4" - 1 3/4"	1 1/4"	1 1/4" - lead thickness to 1/4"	1 1/4" - 2 1/4"	
MAX. SIZE	4' 0" x 12' 0"	4' 0" x 12' 0"	4' 0" x 12' 0"	4' 0" x 10' 0"	4' 0" x 10' 0"	4' 0" x 12' 0"	
CORE	Mat. formed particle board conforming to ANSI A208.1-1.1.	(21-27 pcf) Low density wood blocks bonded together. One species per core.	Resin impregnated honeycomb - 1/2" cell	Special materials and assembly to meet ratings shown	Divided core. Mat. formed particle board conforming to ANSI A208.1-1M3. Lead over 1/4" reinforced with lead plugs	Stiles and rails: Low density wood blocks bonded together & to edgebands. Panels: Mill option: mat. formed particle board or edge-glued lumber core.	
STILES	1/4" face matching or compatible to face veneer. Mill option: inter-ply. Glued to core. Maximum 3"	1/4" matching or compatible to face veneer. Glued to core	1 1/2" 2 ply. Matching or compatible to face veneer. Mill option: inter-ply.	STC 31 - Stave 1/4" particle 1 1/4" matching or compatible to face veneer. Glued to core. Inter-ply. Glued to core.	1/4" matching or compatible to face veneer. Glued to core.	1/4" Matching or compatible to face veneer. Glued to stile.	
RAILS	1 1/4" mill option hardwood glued to core standard. Nominal 2 1/2", 5", 8" and 12" optional.		2 1/4" mill option hardwood	STC 31 - 1 1/4" mill option hardwood glued to core. STC 36, 38, 40 - 3"	2 1/4" mill option hardwood glued to core	1/4" edgebands compatible to face veneer. Glued to rail.	
FACES	All available domestic and foreign veneers. Medium density overlays. High pressure laminates.					All available 1/4" - 5/8" sliced hardwood veneers on stiles and rails. Standard veneers on panel faces.	
CROSSBANDS	Min. 1/4" hardwood					1/4" mill option hardwood.	
VENEER MATCHING	Virtually unlimited in standard veneers, and matching in door and transoms with wood grain plastics.					Limited veneer matching	
PREMACHINING	Pre-fitting, mortise for appropriate hardware. No preparation for surface mounted						
OPENINGS	Min. 5" margins edge of door and adjacent hardware cut-outs. Max. opening 40% of door area or 50% of height.					Min. 5" stiles, minimum 10" bottom rail, min. 5" top rail.	
SPECIAL DETAILS	Cut light openings* install metal and wood louvers, wood beads, and safety glazing. Standard beads or architect's detail at light doors and breezes.	Cut light openings* install metal and wood louvers, wood beads, and safety glazing. Standard beads or architect's detail at light doors and breezes.	Cut light openings* install metal and wood louvers, wood beads, and safety glazing. Standard beads or architect's detail at light and lower openings.	Cut light openings*. Safety glazing. Standard wood, acoustical and lead lined beads. No applied mouldings. No Dutch doors.		Solid stitching or moulding per architect's detail. Wood louvers and safety glazing factory installed.	
FINISHING	Gerdall II, primed, painted, oiled or waxed as specified						
WARRANTY	Interior - Life of original installation. Exterior - 2 years.	Interior - 1 year Exterior - Not recommended	Interior - Not recommended Exterior - Not recommended	Interior - Life of original installation. Exterior - Not recommended	Interior - 2 years Exterior - Not recommended		
STANDARDS	NWWDAL I.S.-1 AWI Section 1300 PC Federal LLLD581, Type I & II, Class 1	NWWDAL I.S.-1 AWI Section 1300 SLC Federal LLLD581, Type I & II, Class 1	NWWDAL I.S.-1	NWWDAL I.S.-1 AWI Section 1300 SR - ASTM E90-70 Federal LLLD581, Type IV, Class 4	NWWDAL I.S.-1 AWI-1300-LL and EA13-73 Federal LLLD581, Type III		

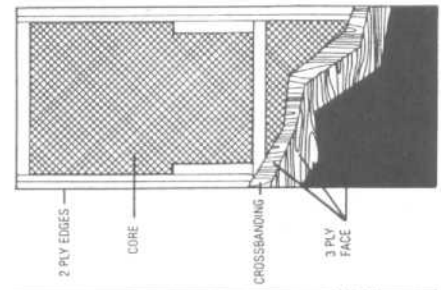
\*Footnote on openings - Minimum margins per AWI Section 1300. \*\*No rating guaranteed on doors with lites or pairs.



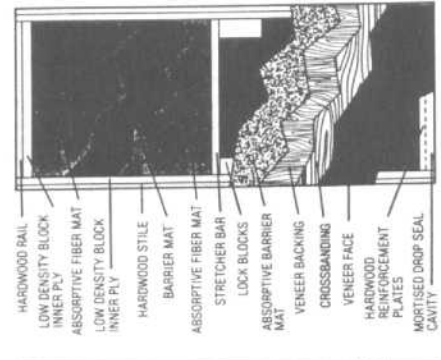
PARTICLE



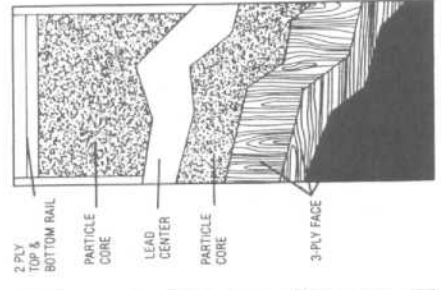
STAVE



HOLLOW



ACOUSTICAL STC 38



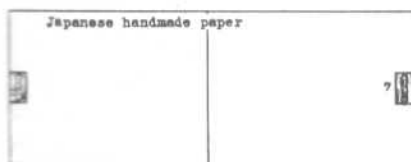
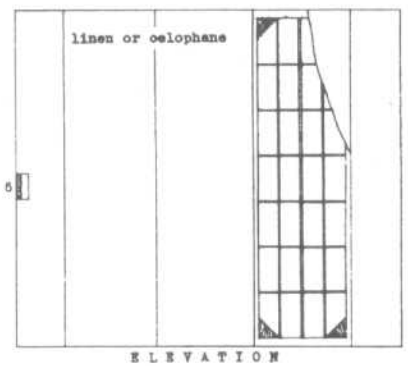
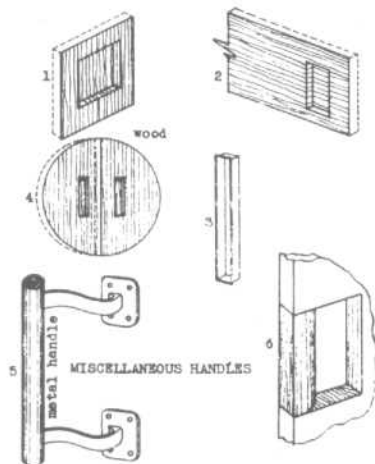
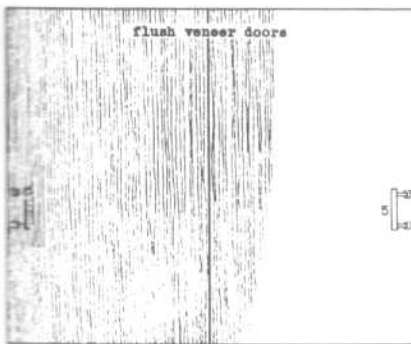
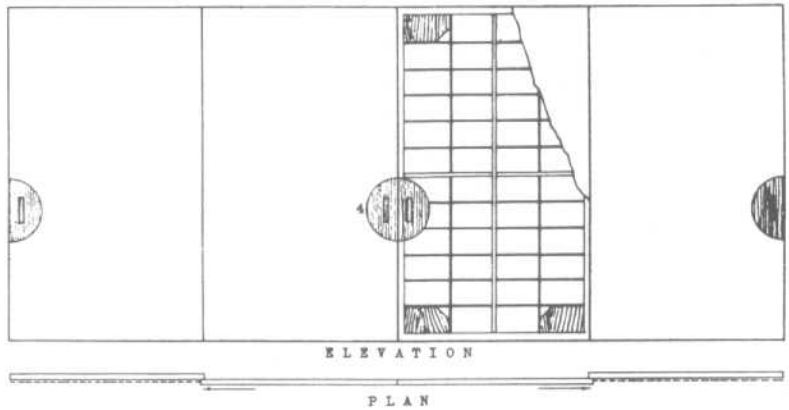
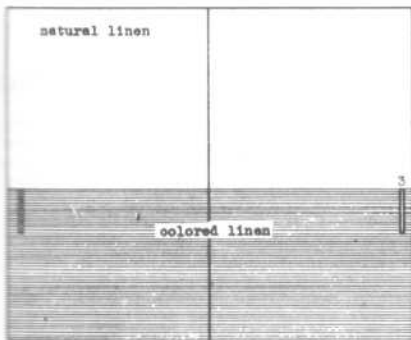
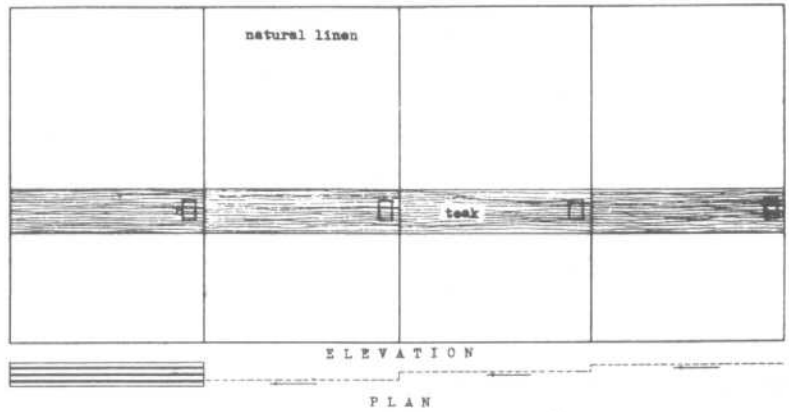
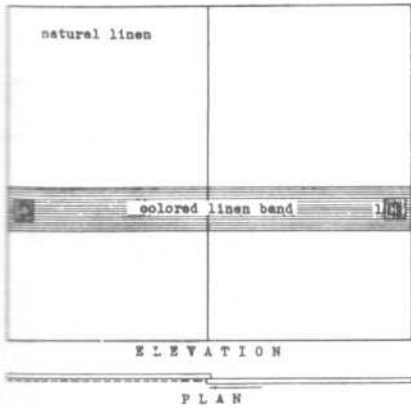
LEAD



STILE AND RAIL

DOORS

Sliding Doors and Handles



DOORS

Door Types

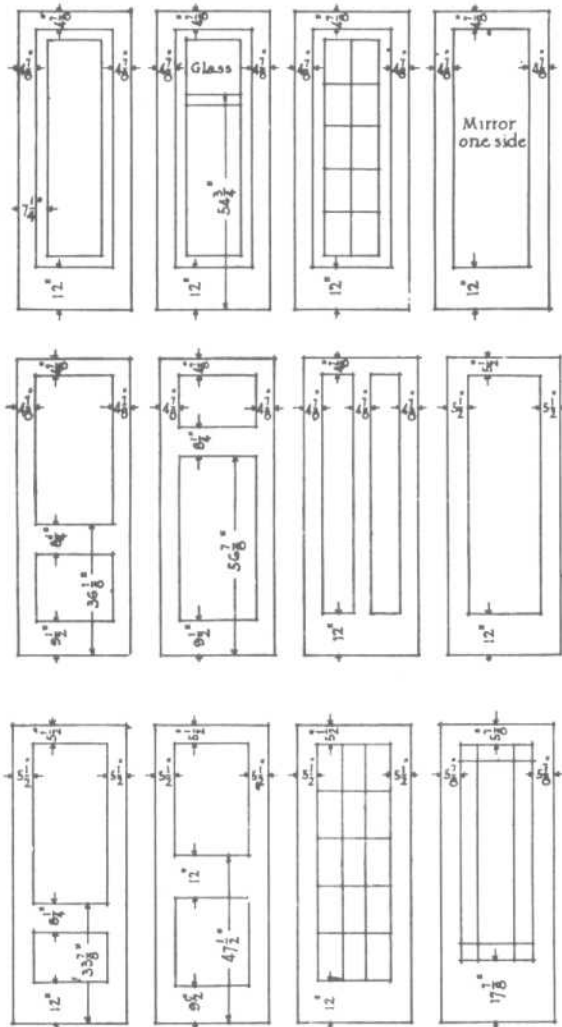
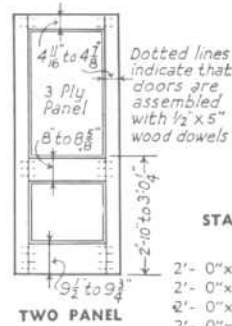


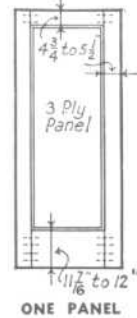
Fig. 17 Typical interior doors showing the dimensions of stiles and rails.



Lock rail heights, width of stiles, and width of rails as noted on all elevations are minimum and maximum dimensions as used by the various manufacturers.

STANDARD SIZES OF ONE, TWO, AND SIX PANEL DOORS

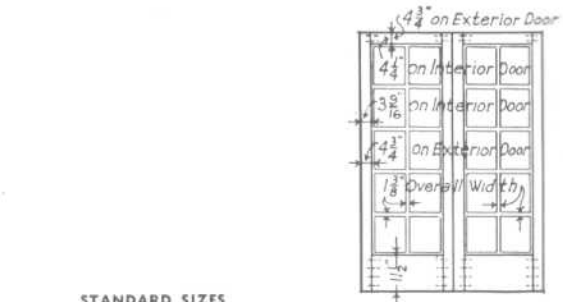
2'-0" x 6'-0", 1 3/8"	2'-10" x 6'-10", 1 3/8"
2'-0" x 6'-6", 1 3/8"	3'-0" x 6'-8", 1 3/8"
2'-0" x 6'-8", 1 3/8"	3'-0" x 7'-0", 1 3/8"
2'-0" x 7'-0", 1 3/8"	2'-6" x 6'-6", 1 3/8"
2'-4" x 6'-6", 1 3/8"	2'-6" x 6'-8", 1 3/8"
2'-4" x 6'-8", 1 3/8"	2'-6" x 7'-0", 1 3/8"
2'-6" x 6'-6", 1 3/8"	2'-8" x 6'-8", 1 3/8"
2'-6" x 6'-8", 1 3/8"	2'-8" x 7'-0", 1 3/8"
2'-6" x 7'-0", 1 3/8"	2'-10" x 6'-10", 1 3/8"
2'-8" x 6'-8", 1 3/8"	3'-0" x 6'-8", 1 3/8"
2'-8" x 7'-0", 1 3/8"	3'-0" x 7'-0", 1 3/8"



ONE AND TWO PANEL DESIGNS

Manufactured in Ponderosa Pine with laminated flat panels of pine, fir, gum, or birch. Moulded CGB, BG or Ovolo Sticking. Standard thickness of doors 1 3/8" or 1 1/2". Made also in any Hardwood with veneered stiles, rails and panels.

Fig. 18 Sizes of panelled interior doors.



STANDARD SIZES

- 4'-0" opening, 2'-0" x 6'-8" or 2'-0" x 7'-0"
- 4'-8" opening, 2'-4" x 6'-8" or 2'-4" x 7'-0"
- 5'-0" opening, 2'-6" x 6'-8" or 2'-6" x 7'-0"
- 5'-4" opening, 2'-8" x 6'-8" or 2'-8" x 7'-0"

CASEMENT DESIGNS

Casement doors can also be divided into:  
 8 lights (2 wide—4 high) and  
 12 lights (3 wide—4 high).

Pairs of casement doors in openings less than 5'-0" wide have 3 5/8" stiles as shown while pairs in openings 5'-0" wide and wider have 4 1/4" stiles.

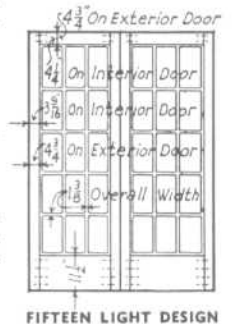


Fig. 19 Sizes of French or casement doors.



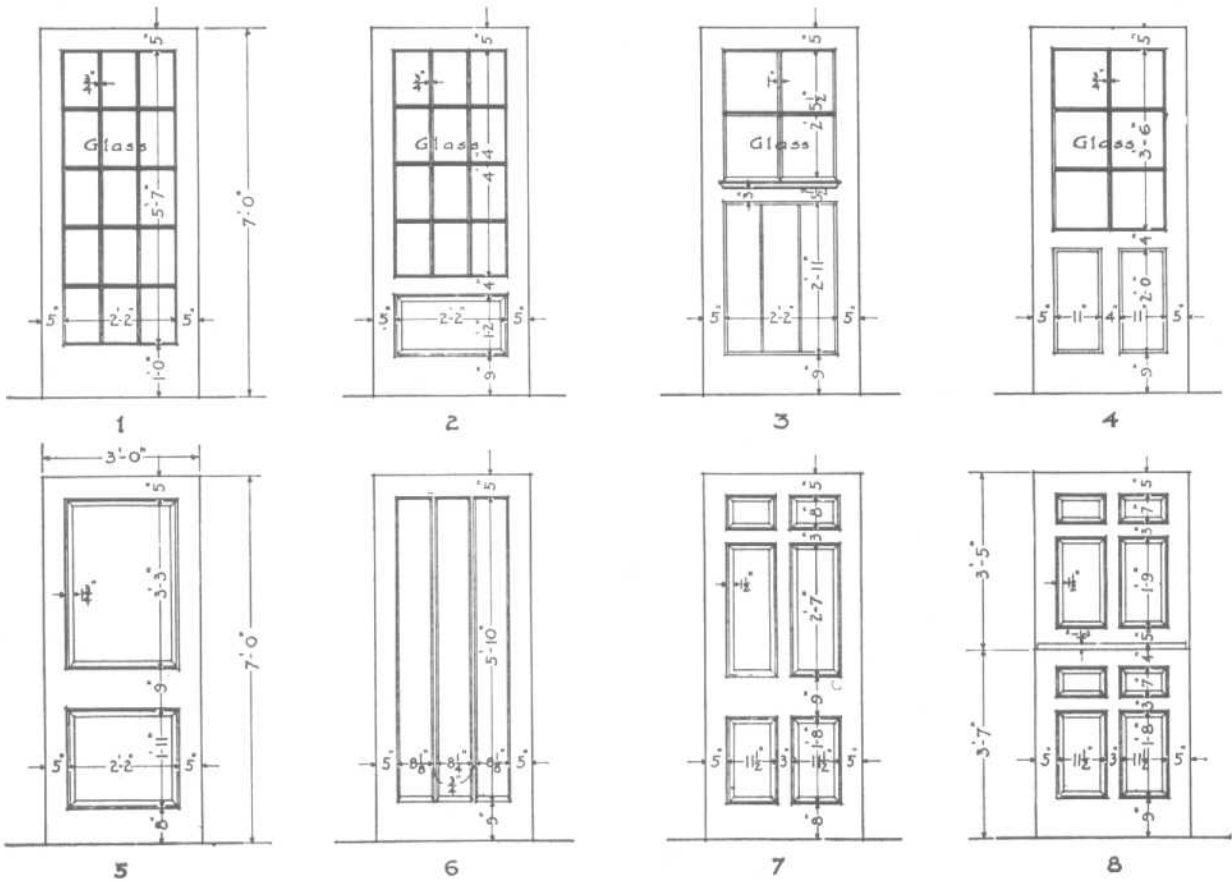


Fig. 20 Exterior wood doors.

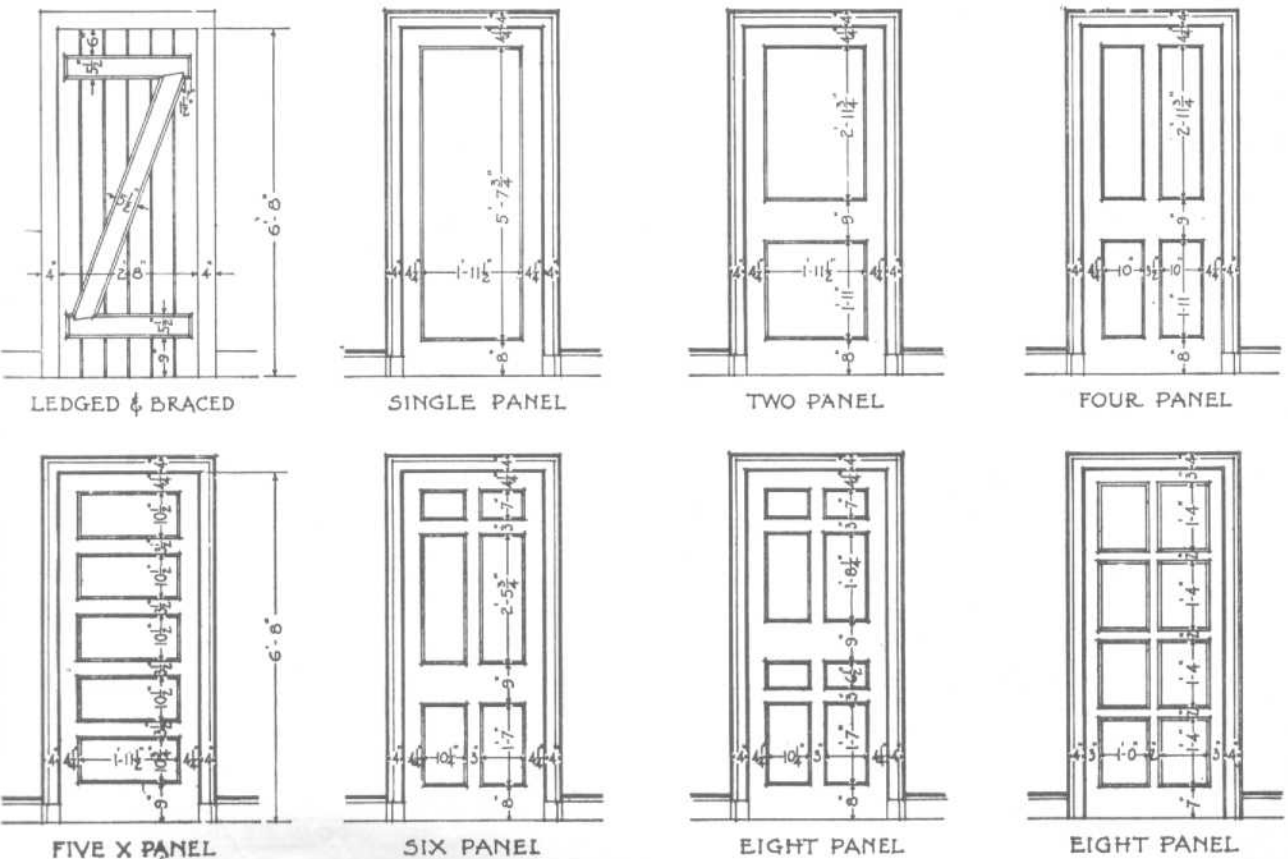
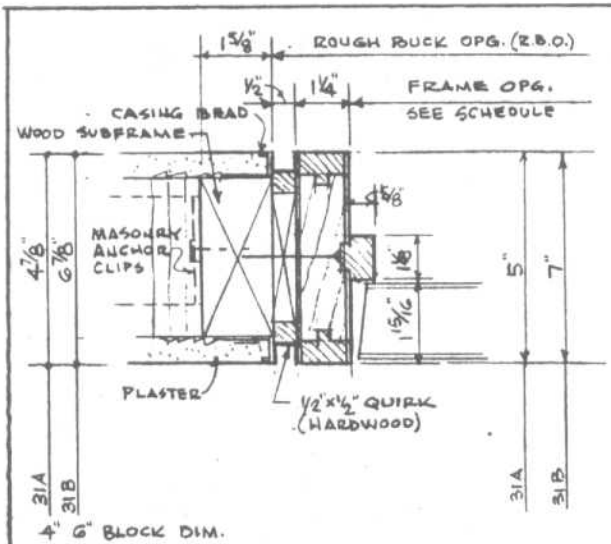


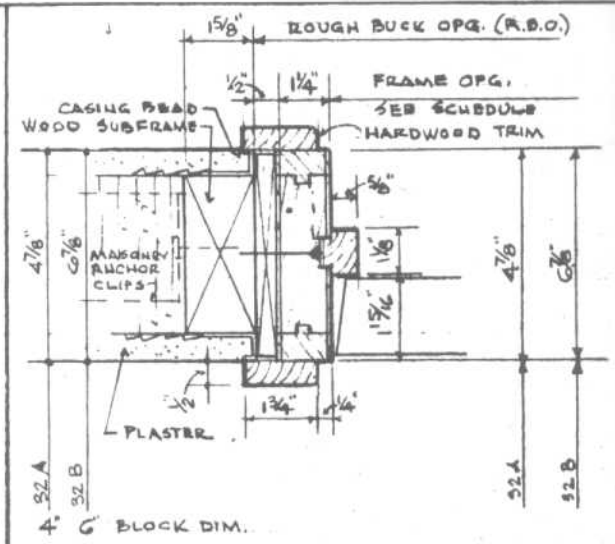
Fig. 21 Interior wood doors.

DOORS

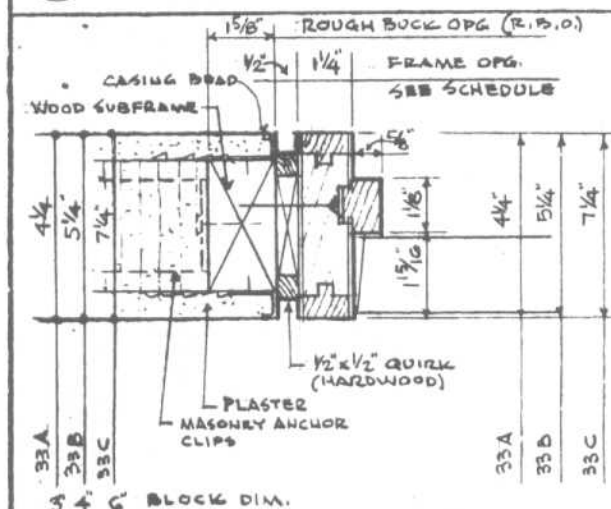
Wood Door Frames



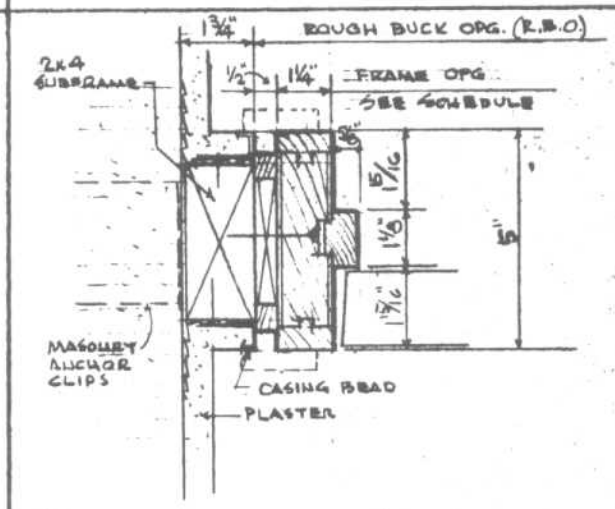
31 CINDER OR CONC. BLOCK - PLASTER BOTH SIDES - FIREPROOF WOOD FRAME



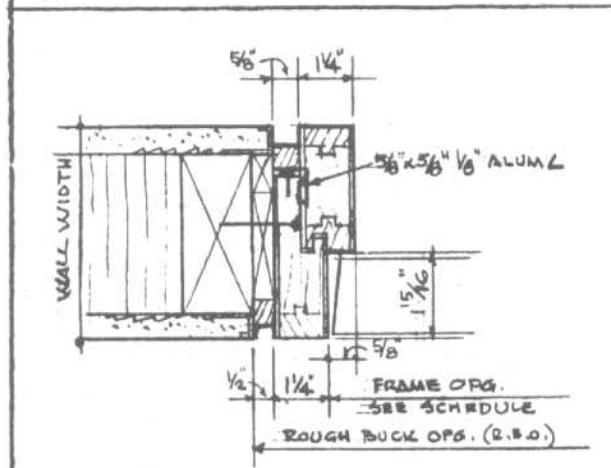
32 CINDER OR CONC. BLOCK - PLASTER BOTH SIDES - FIREPROOF WOOD FRAME



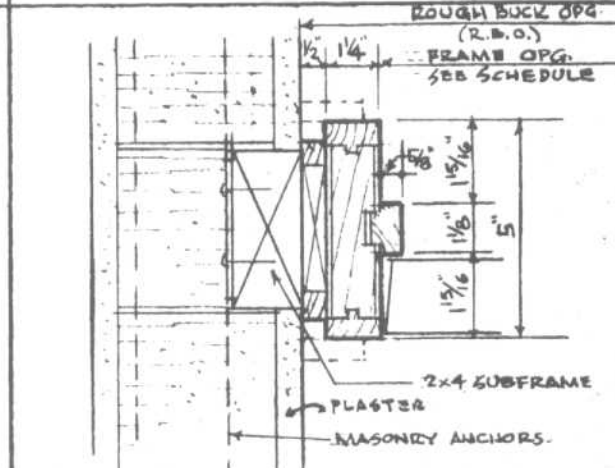
33 GYPSUM BLK. PLASTER BOTH SIDES FIREPROOF WOOD FRAME



34 MASONRY BLK & PLASTER FIREPROOF WOOD FRAME



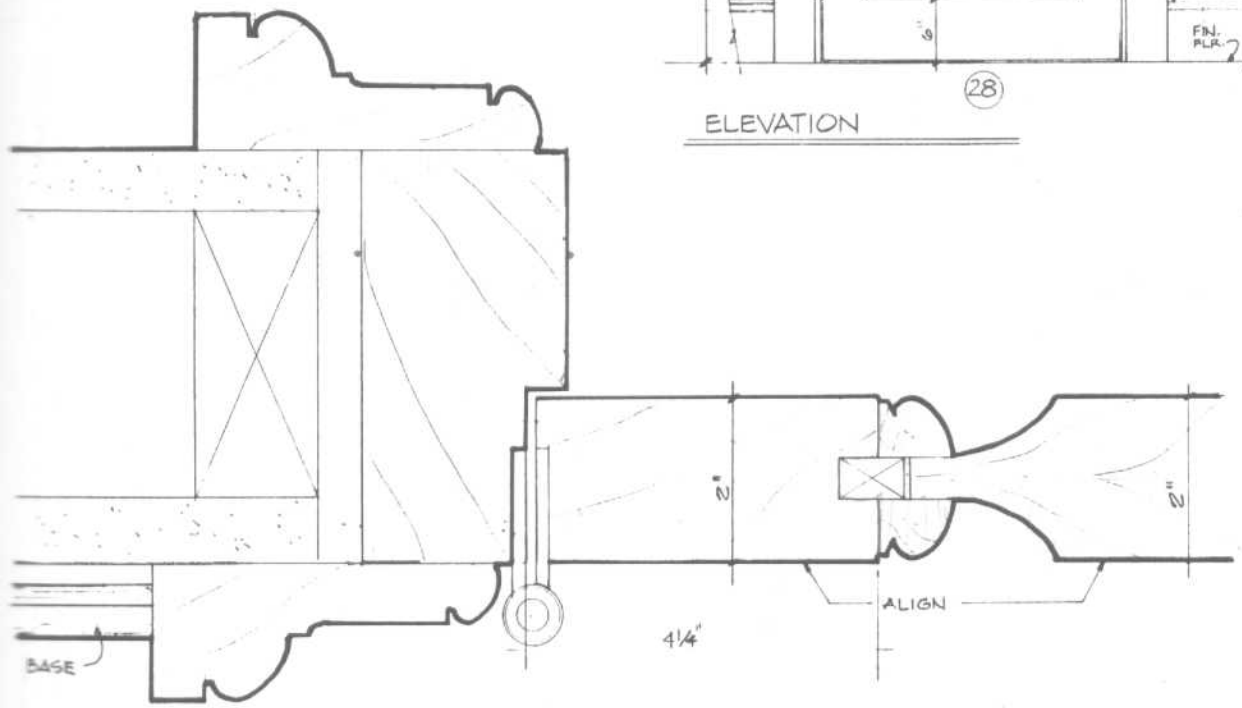
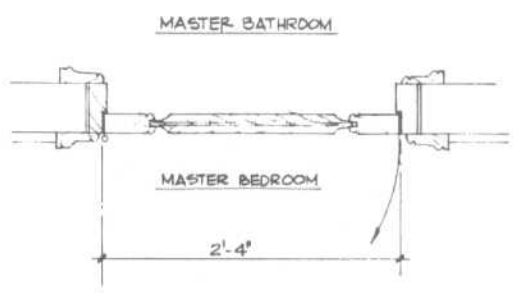
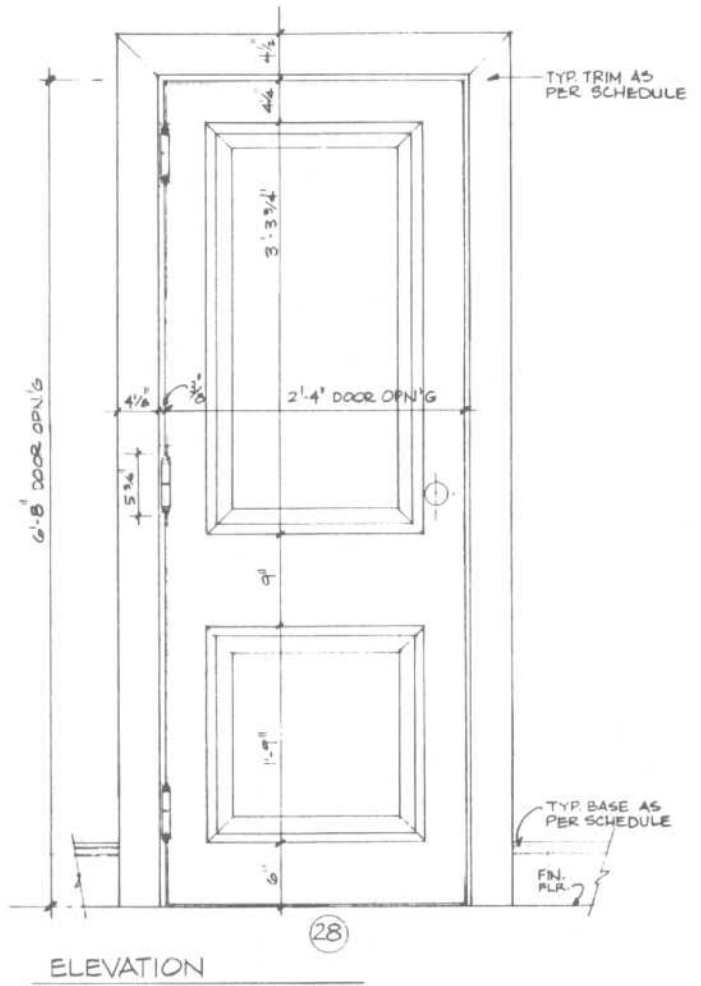
35 MASONRY BLK & PLASTER FIREPROOF WOOD FRAME



36 MASONRY BLK & PLASTER FIREPROOF WOOD FRAME SCALE: 3" = 1'-0"

DOORS

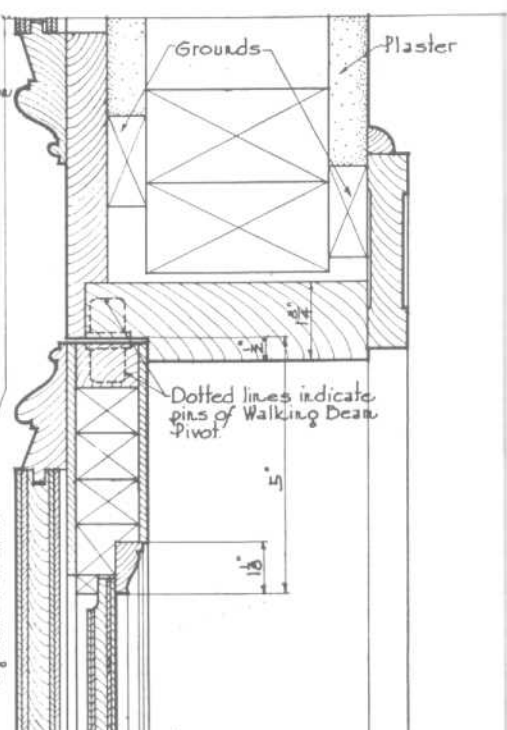
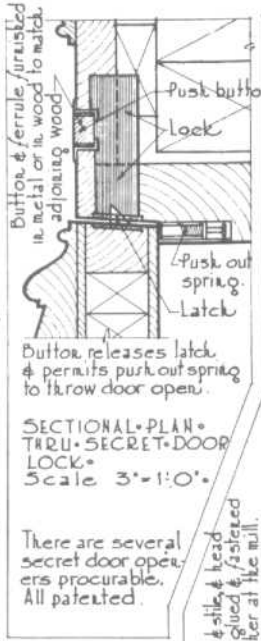
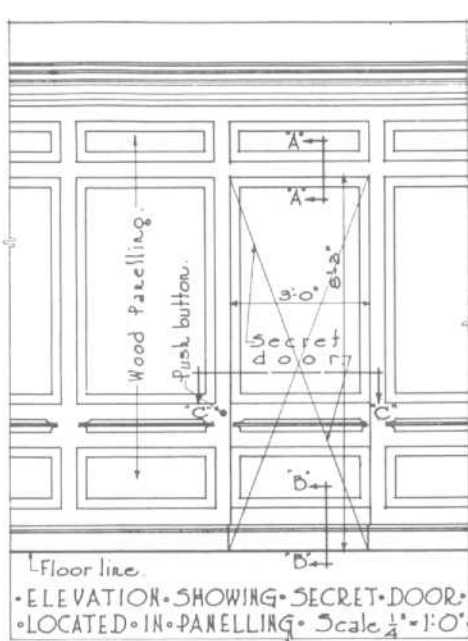
Wood Door Frames



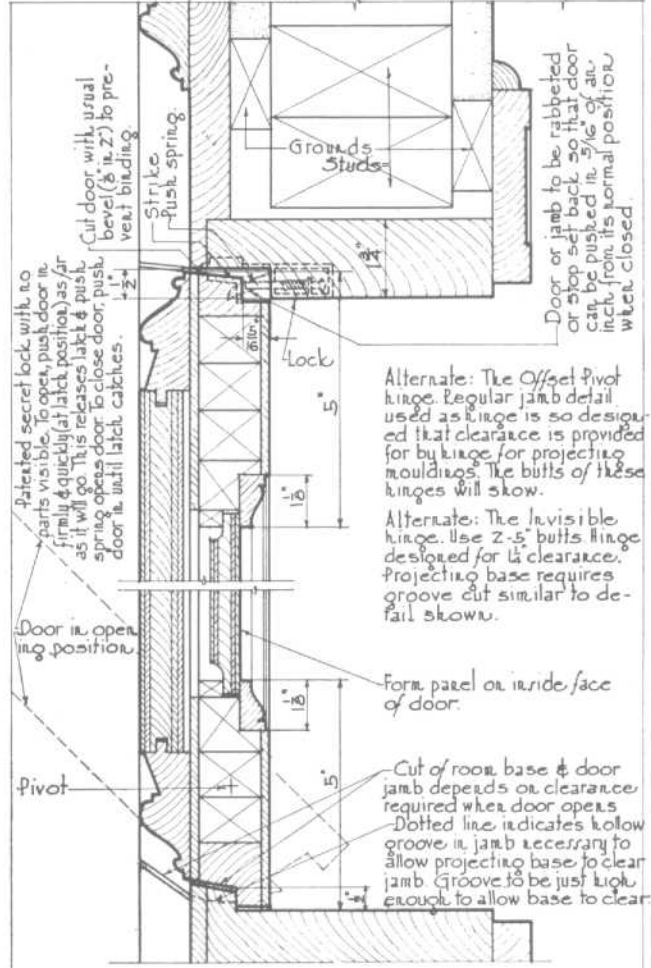
DETAIL @ JAMB  
F.S.

DOORS

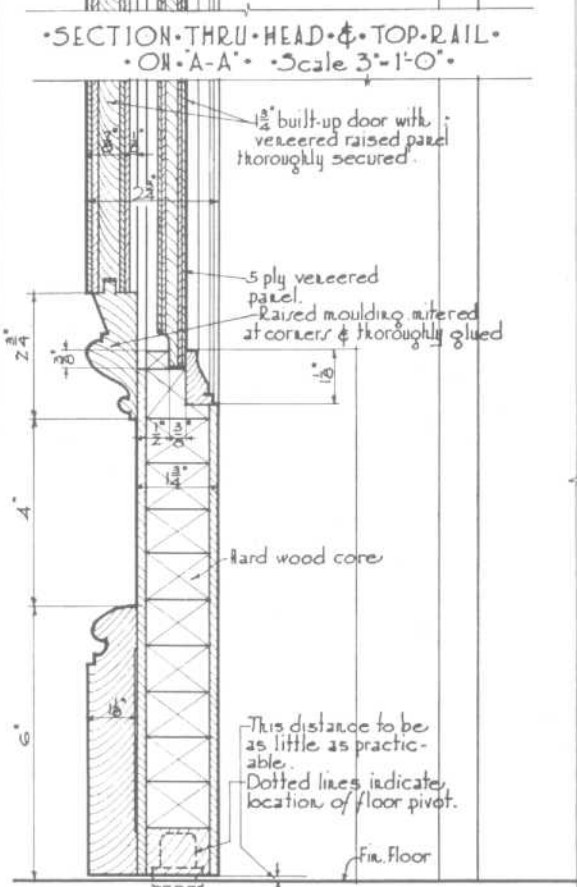
Secret Door



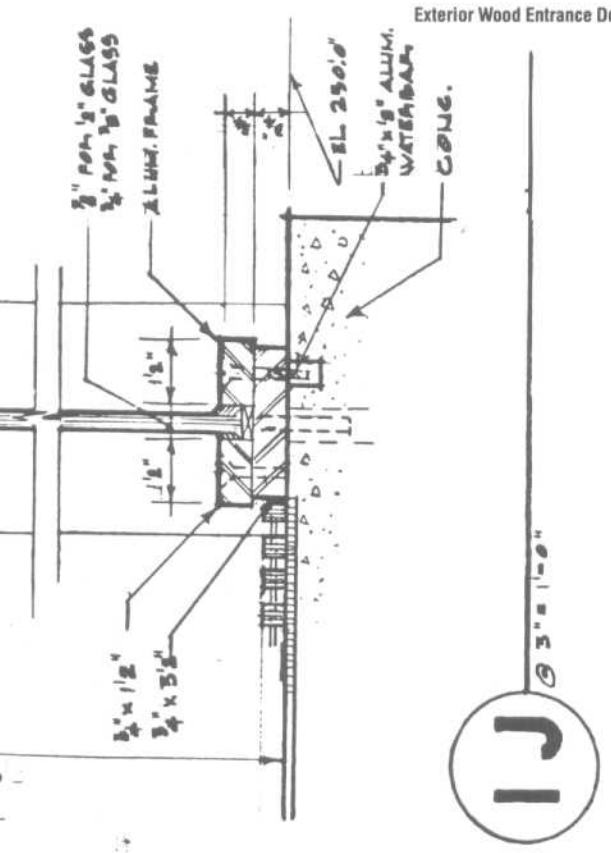
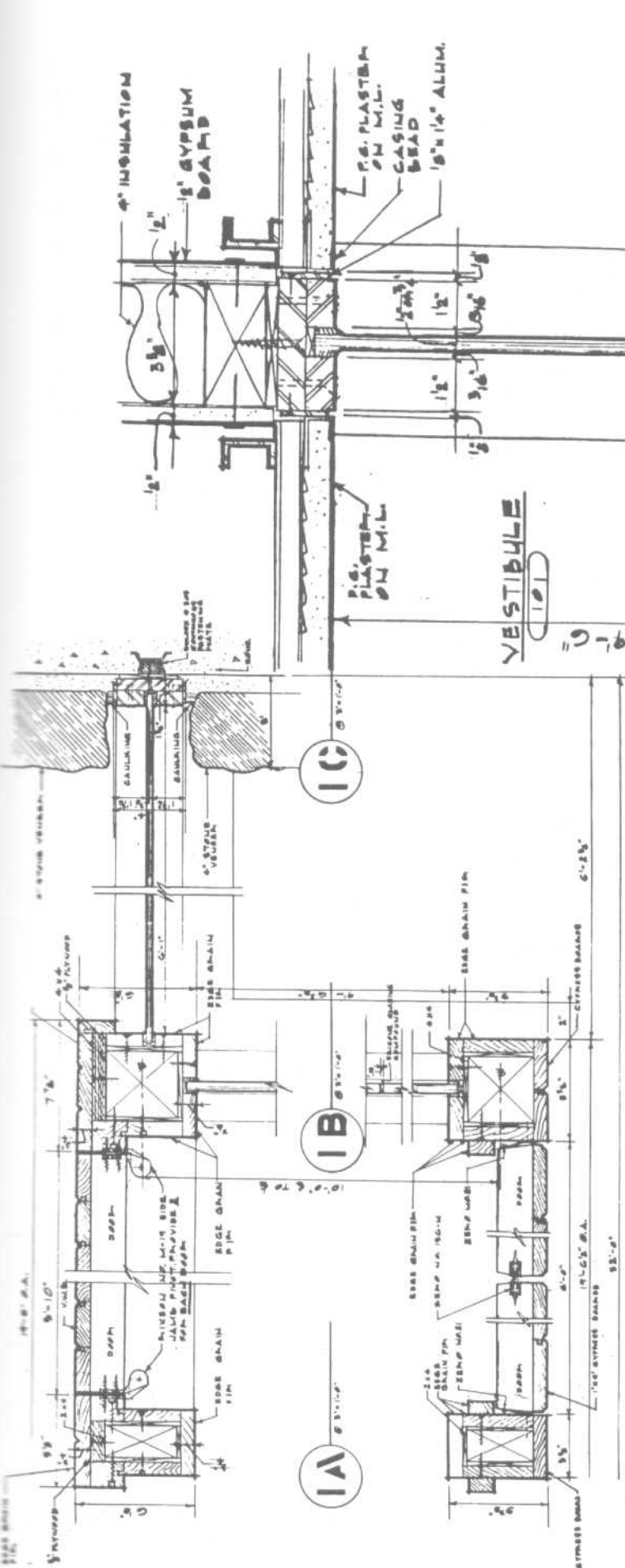
SECTION THRU HEAD & TOP RAIL ON A-A Scale 3"=1'-0"



SECTION THRU SECRET DOOR (SHOWING BEVEL CUTS IN BASE, JAMB & DOOR) ON C-C Scale 3"=1'-0"



SECTION THRU BOTTOM RAIL & ATTACHED BASE ON D-D Scale 3"=1'-0"



1-0-1

DOORS

Exterior Wood Entrance Doors

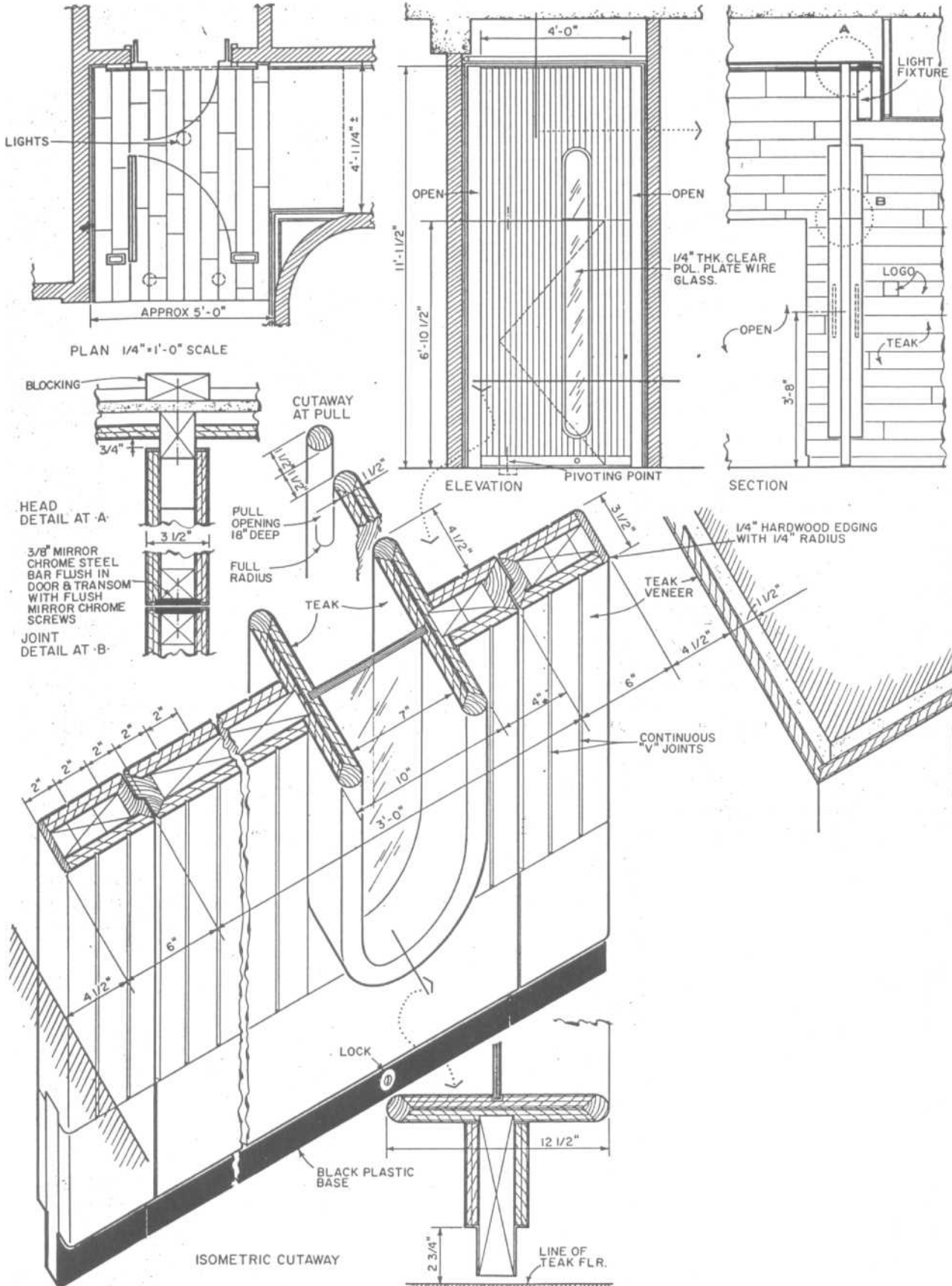
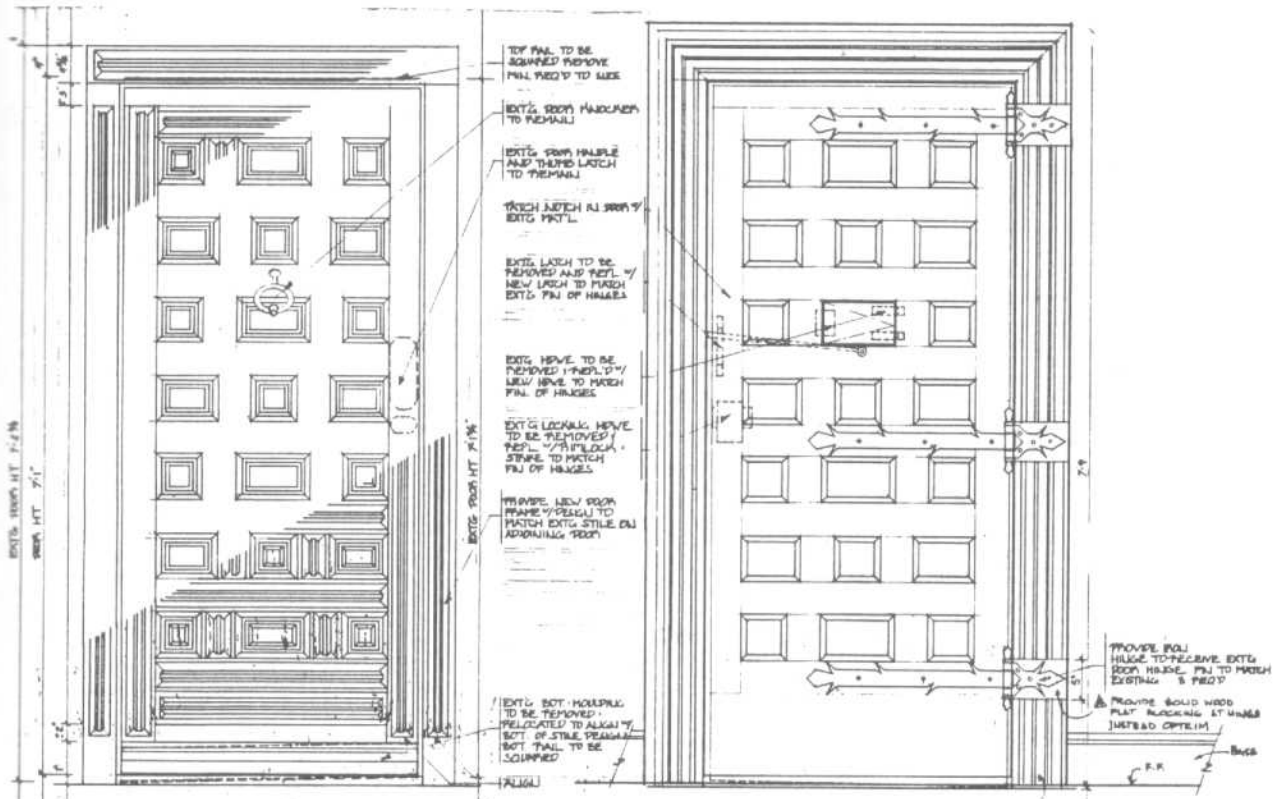


Fig. 22 Door for an architect's office.

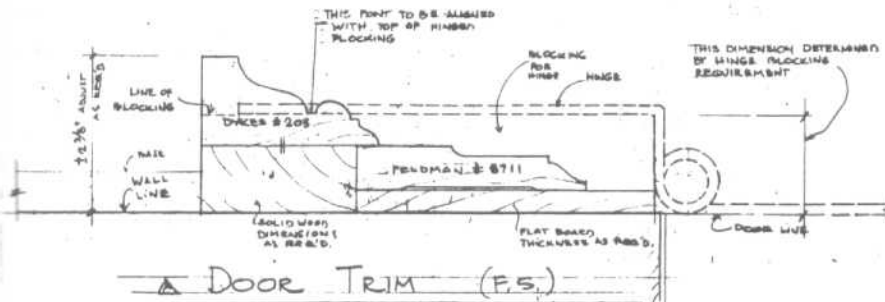
DOORS

Exterior Wood Entrance Doors



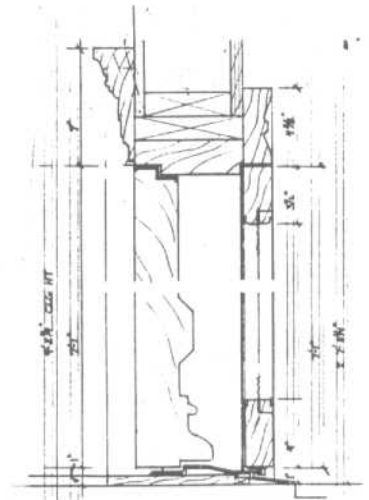
EXTERIOR ELEVATION - FRONT AND FRAME

INTERIOR ELEVATION



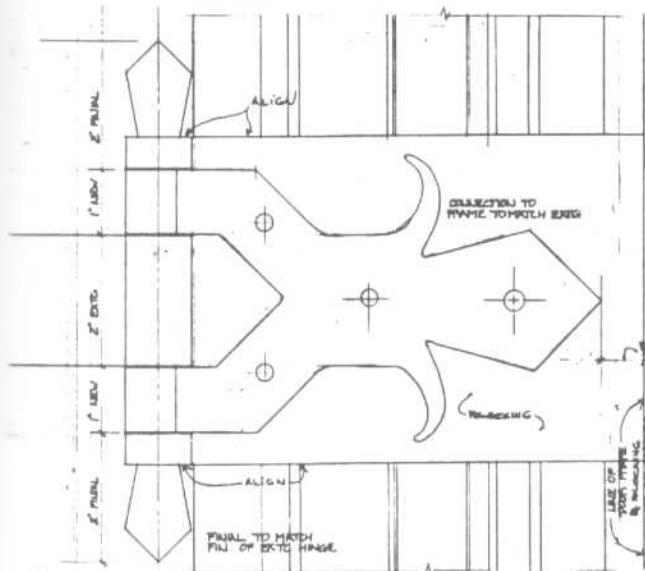
Door Trim (P.S.)

NOTE: FINISH WD. TO BE GRAINED TO MATCH ANTIKOR BOARDING AT CLG.

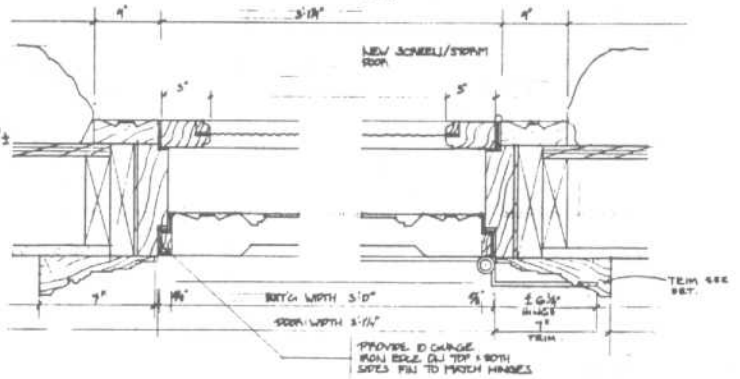


DETAIL SECTION - FRONT ROOM + SORELLI

SAMPLE TYPE 2250 \* 100 SAMPLE TYPE 2250 \* 544



DETAIL VIEW LEAD FOR EXISTING HINGE

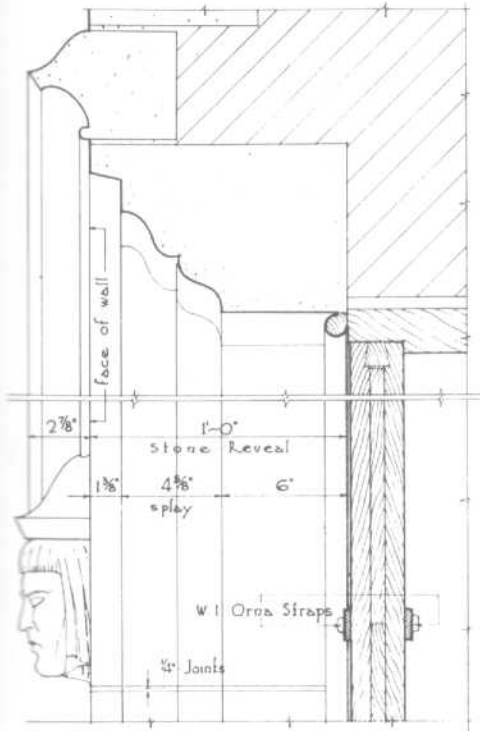


DETAIL PLAN - FRONT ROOM + SORELLI



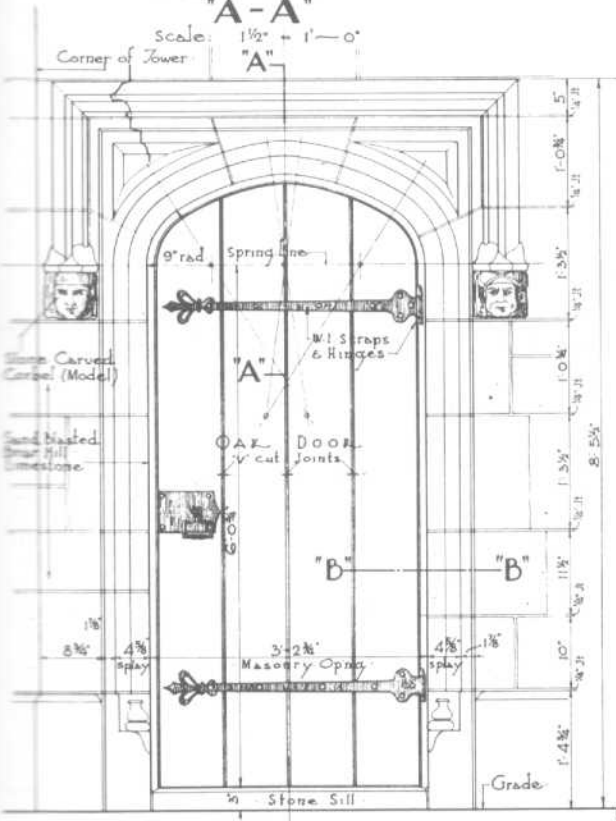




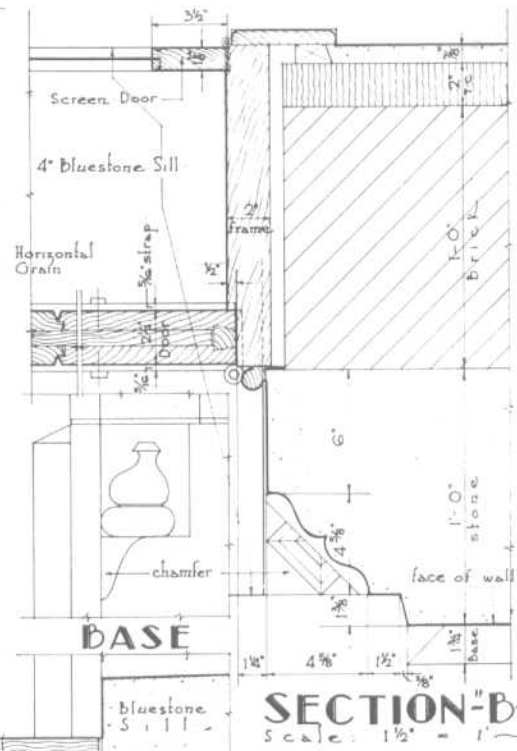


**SECTION "A-A"**

Scale:  $1\frac{1}{2}'' = 1'-0''$



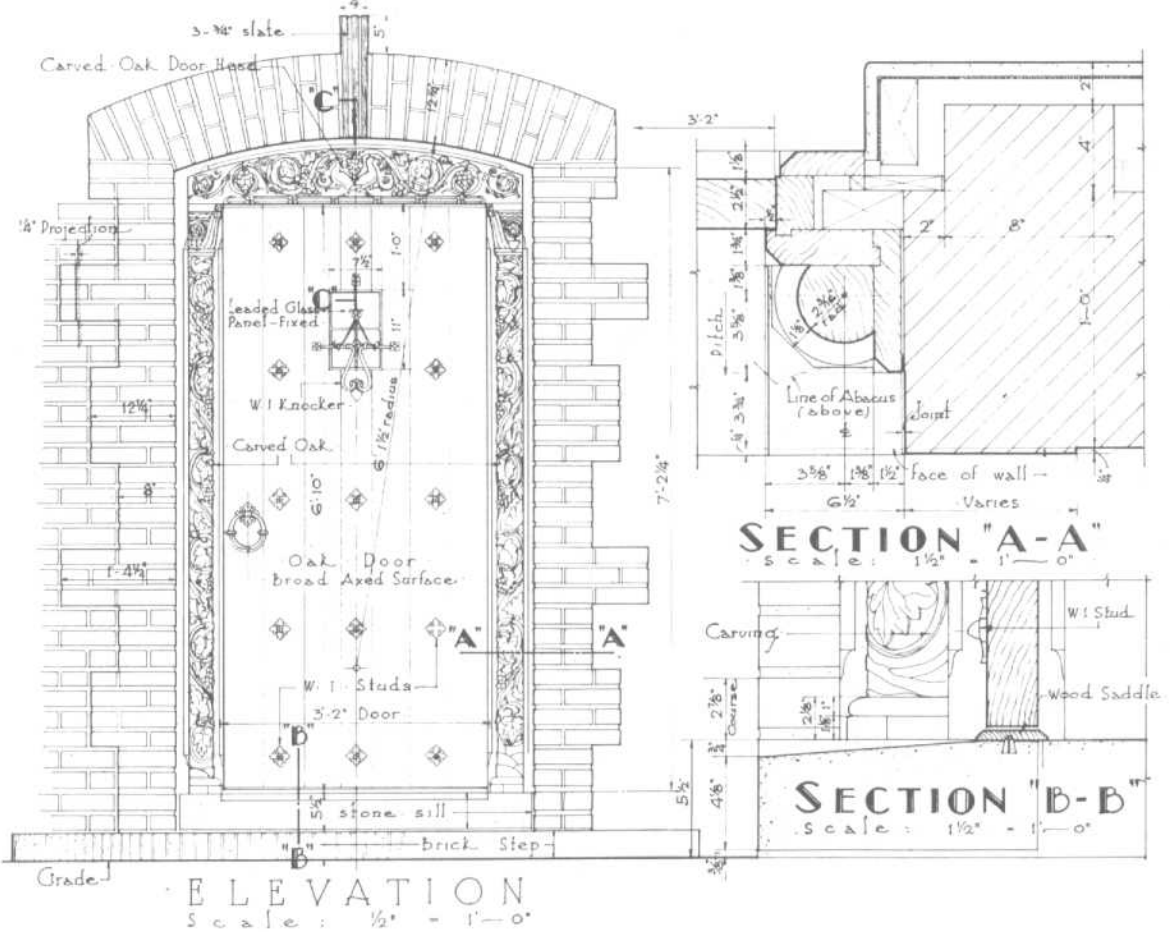
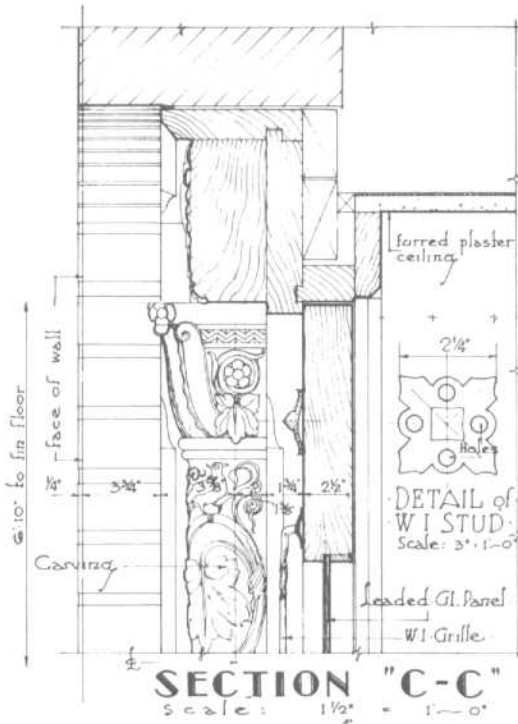
**ELEVATION**  
Scale:  $1\frac{1}{2}'' = 1'-0''$

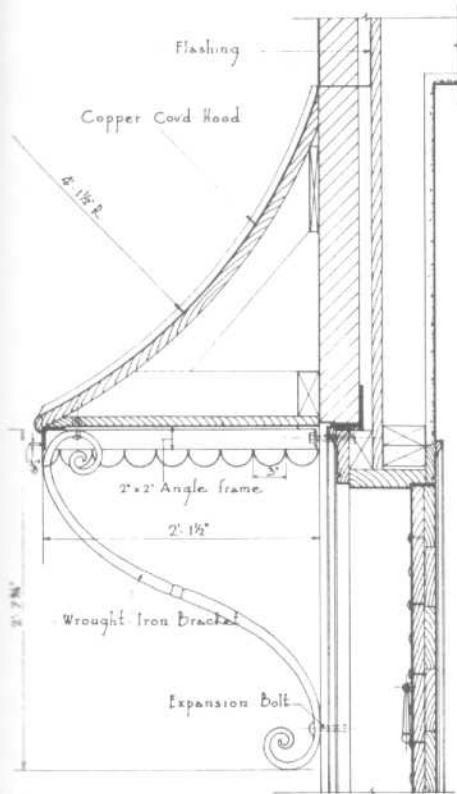


**SECTION "B-B"**  
Scale:  $1\frac{1}{2}'' = 1'-0''$

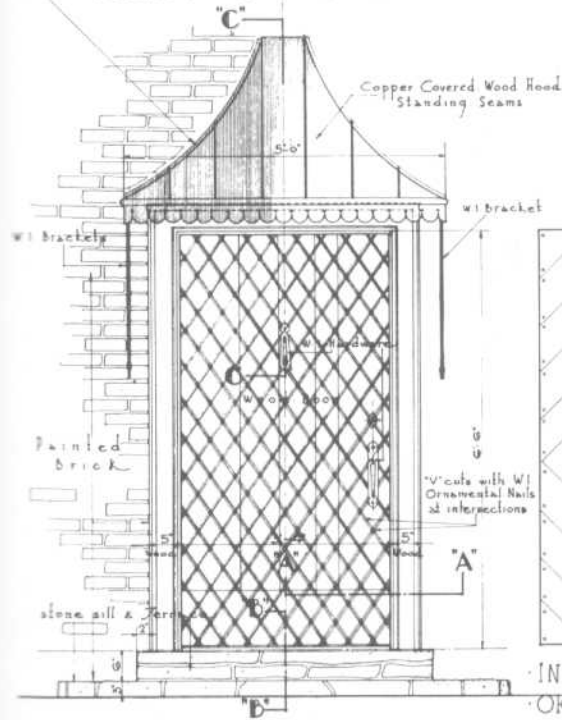
DOORS

Exterior Wood Entrance Doors

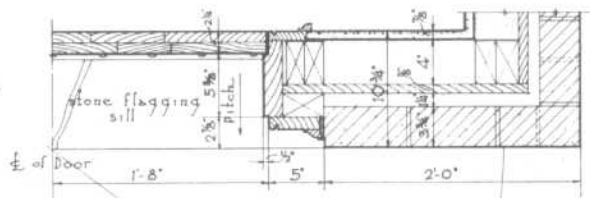




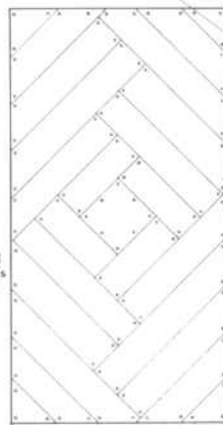
**SECTION "C-C"**  
Scale:  $\frac{3}{4}" = 1'-0"$



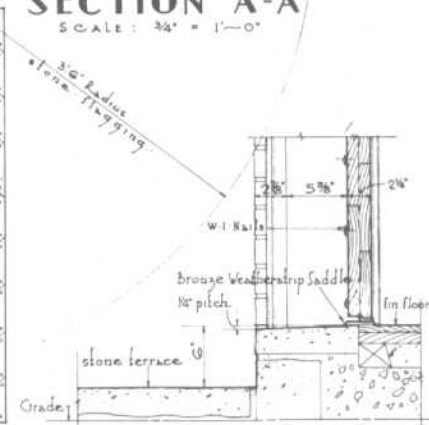
**ELEVATION**  
Scale:  $\frac{3}{8}" = 1'-0"$



**SECTION "A-A"**  
Scale:  $\frac{3}{4}" = 1'-0"$



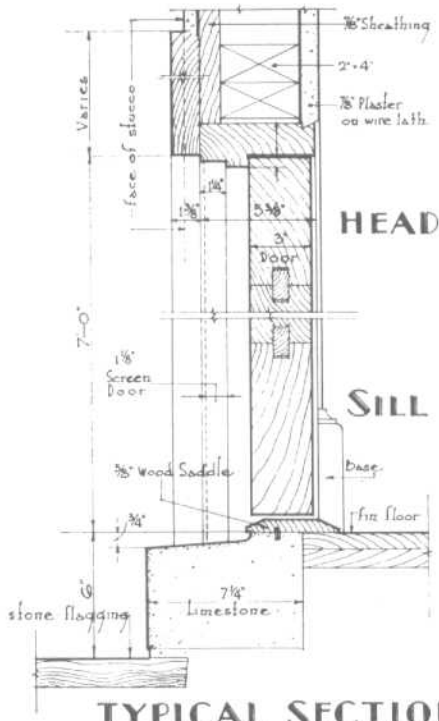
**INTERIOR ELEVATION OF DOOR**  
Scale:  $\frac{3}{8}" = 1'-0"$



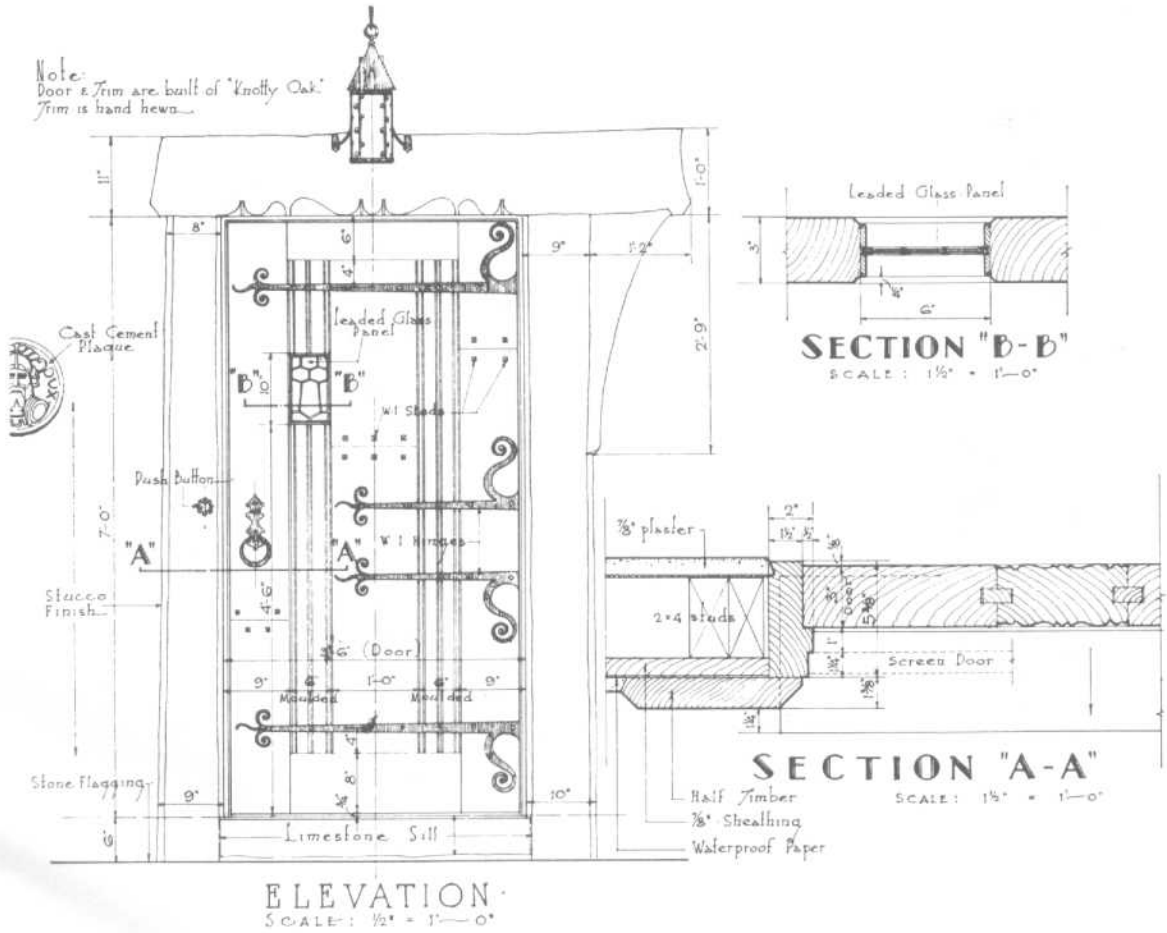
**SECTION "B-B"**  
Scale:  $\frac{3}{4}" = 1'-0"$

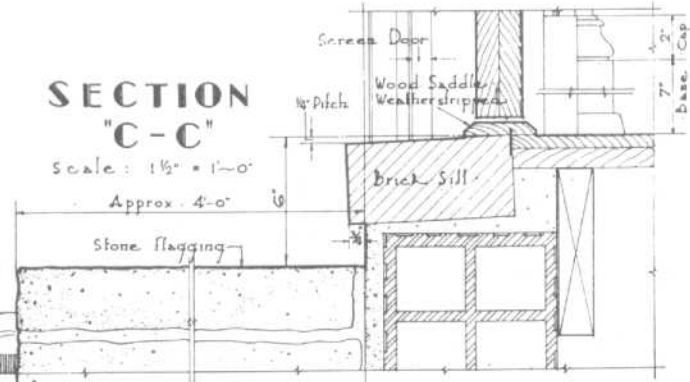
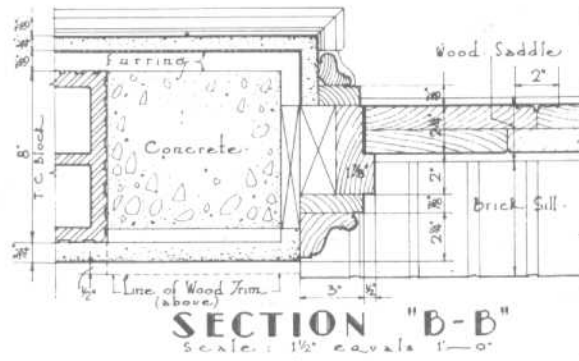
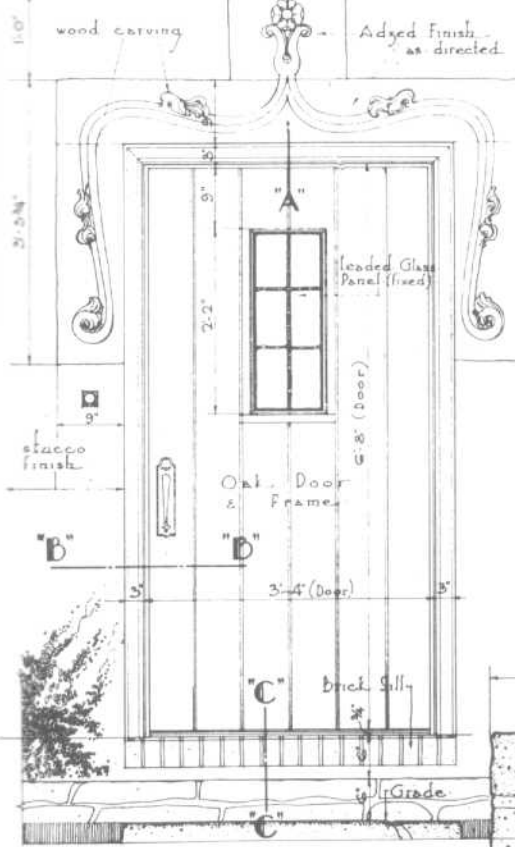
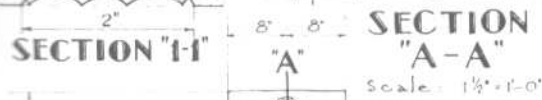
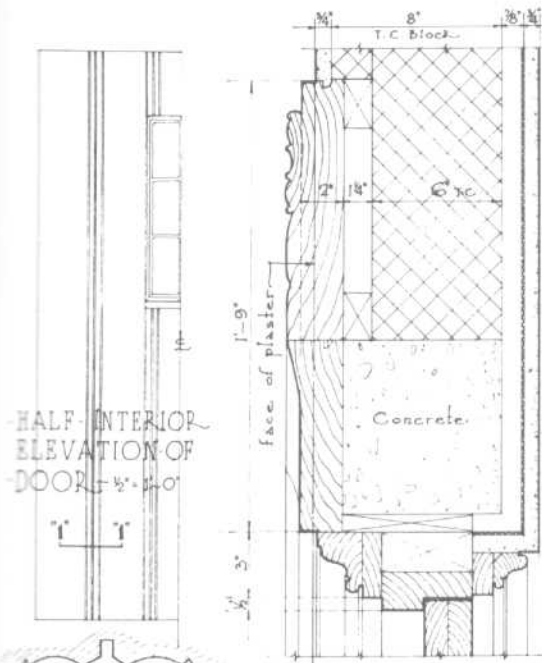
DOORS

Exterior Wood Entrance Doors



Note:  
Door & Trim are built of "Knolly Oak"  
Trim is hand hewn.

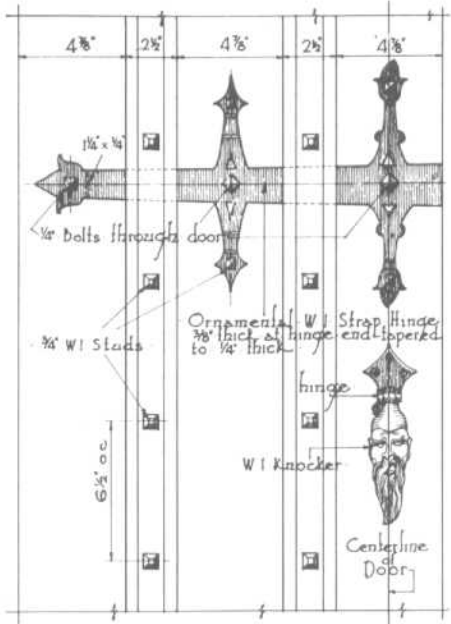




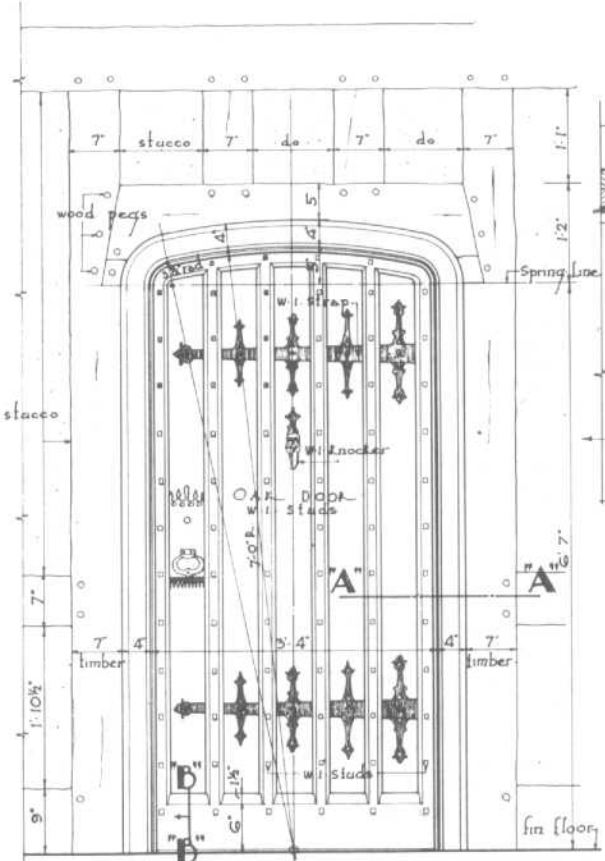
ELEVATION  
SCALE: 1/2" = 1'-0"

DOORS

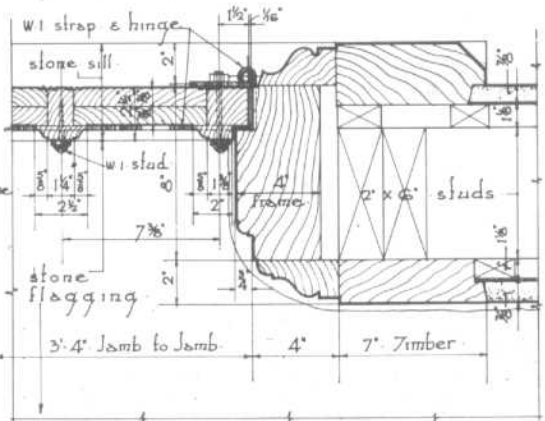
Exterior Wood Entrance Doors



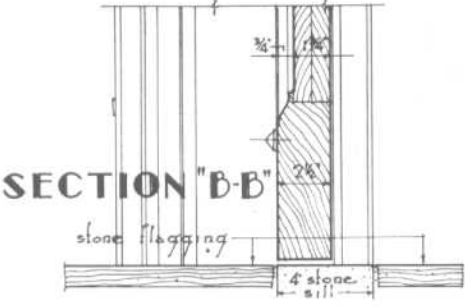
1/2" SCALE · DETAIL OF W.I. STRAP & DOOR KNOCKER



ELEVATION  
Scale: 1/2" = 1'-0"



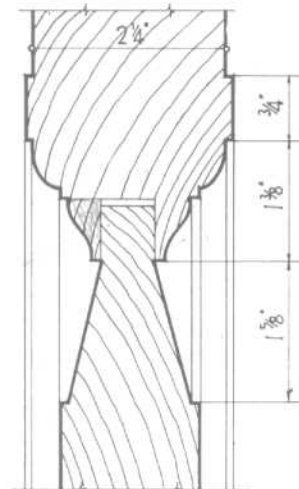
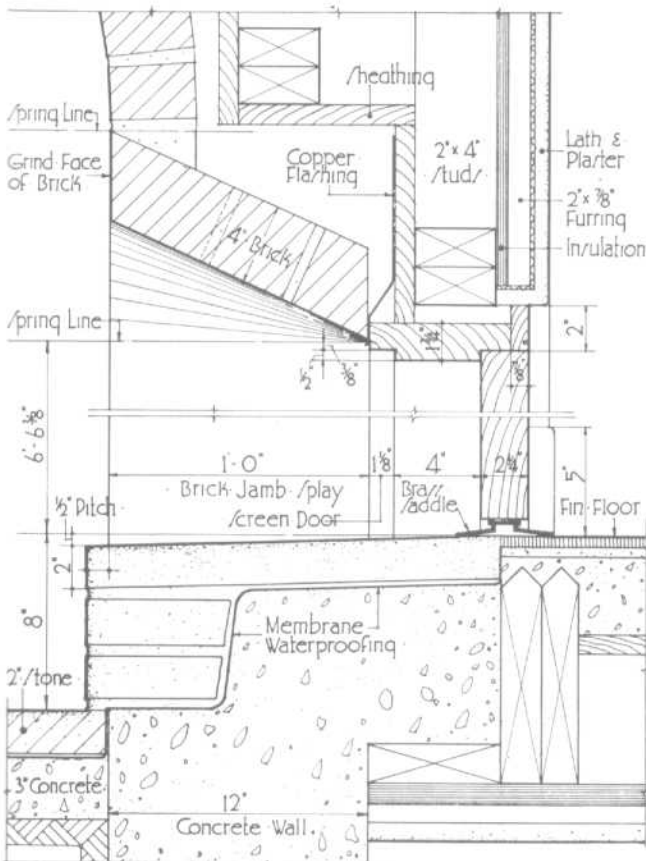
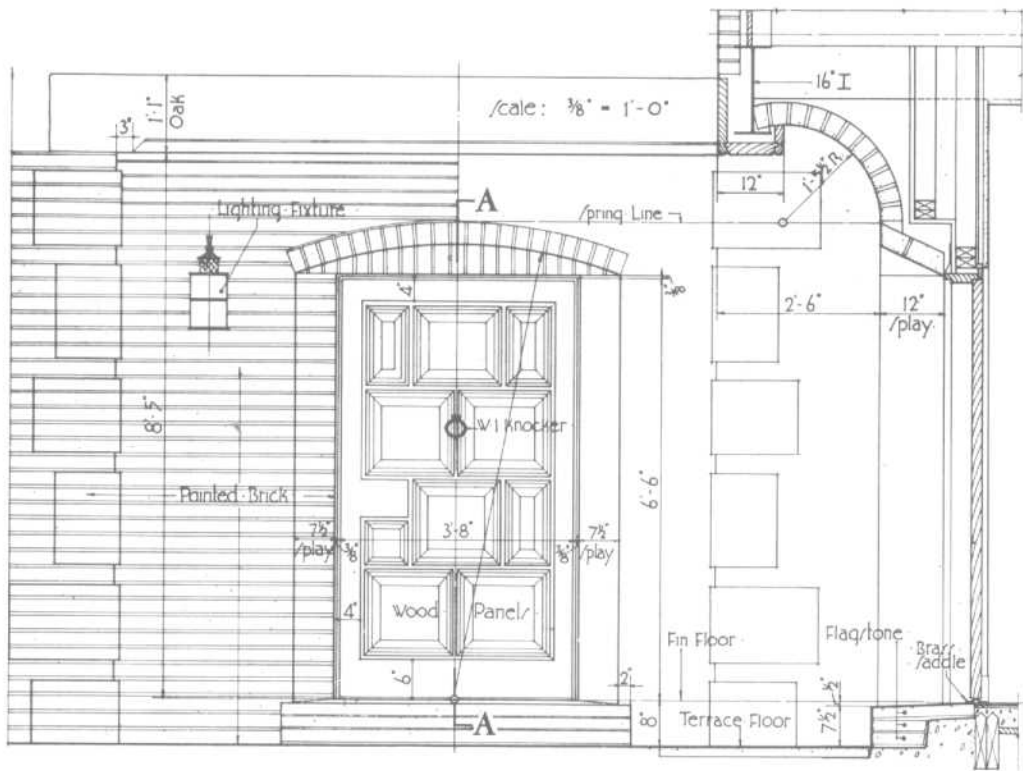
SECTION "A-A"  
Scale: 1/2" = 1'-0"



SECTION "B-B"

DOORS

Exterior Wood Entrance Doors



· DETAIL OF ·  
· DOOR · PANEL ·  
· Scale: Half · Full 1/32 ·

DOORS

Exterior Wood Entrance Doors

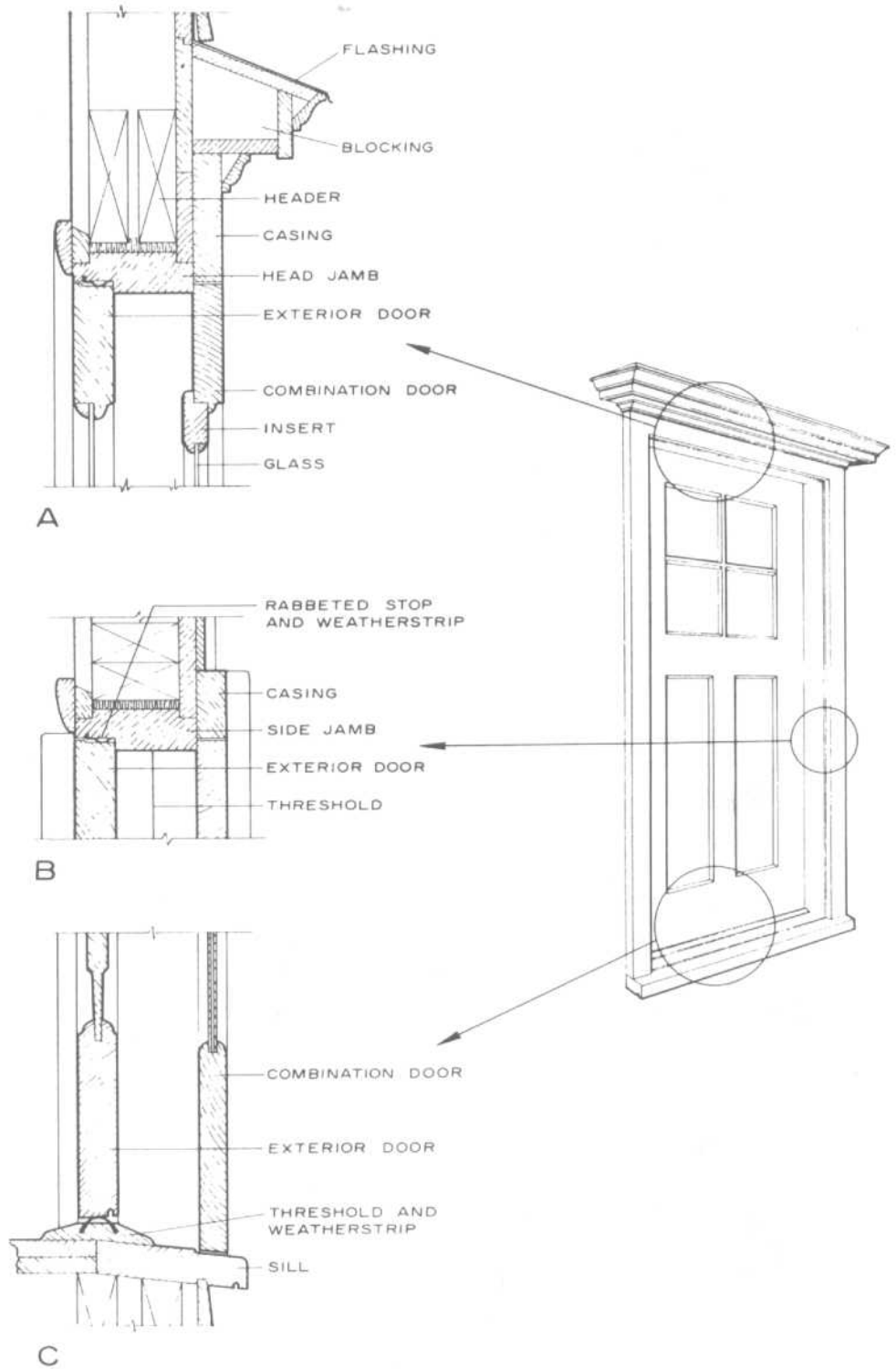
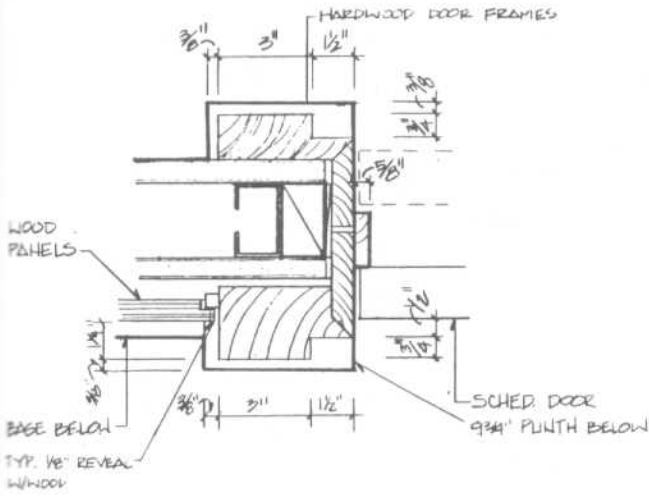
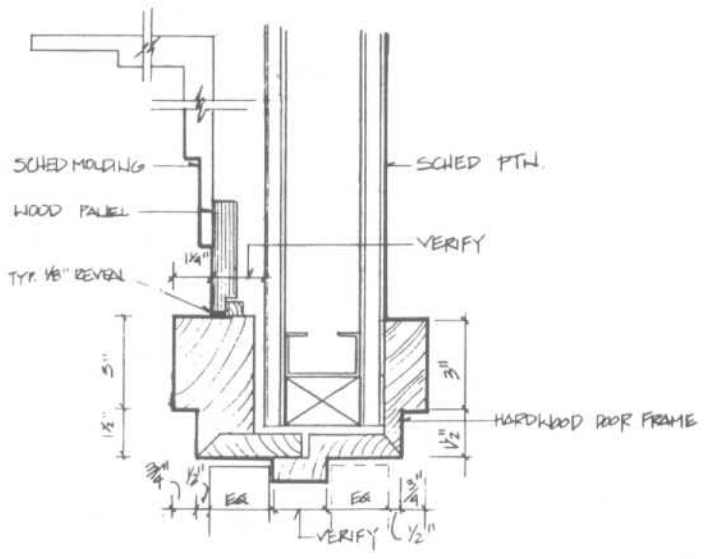


Fig. 23 Exterior door and frame. Exterior-door and combination-door (screen and storm) cross sections: A, head jamb; B, side jamb; C, sill.



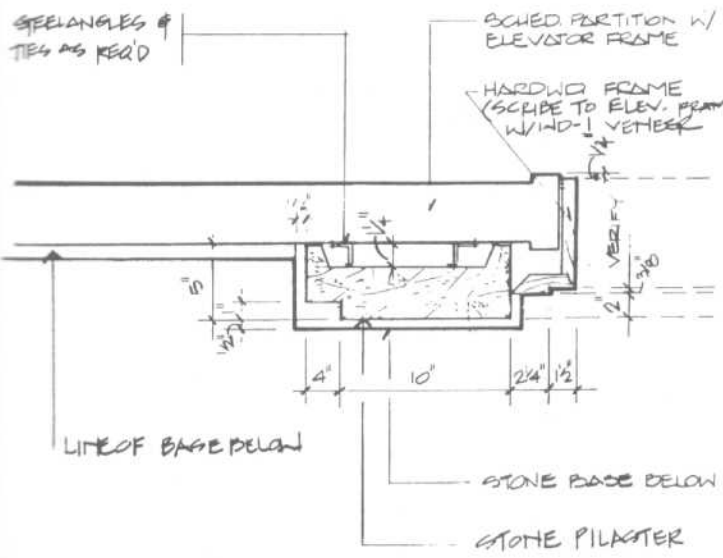


WOOD DOOR JAMB



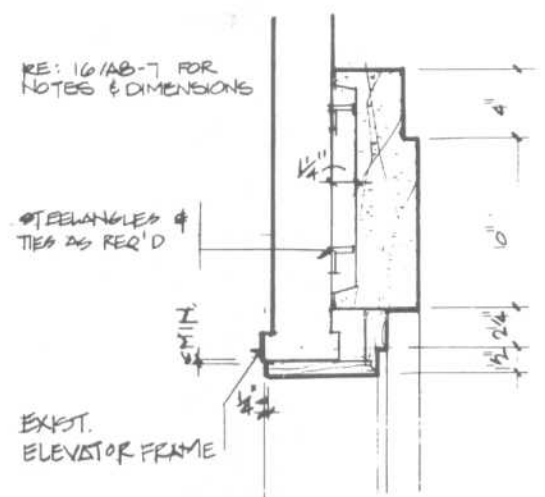
WOOD DOOR HEAD

Wood clad metal door frames



JAMB @ ELEVATOR

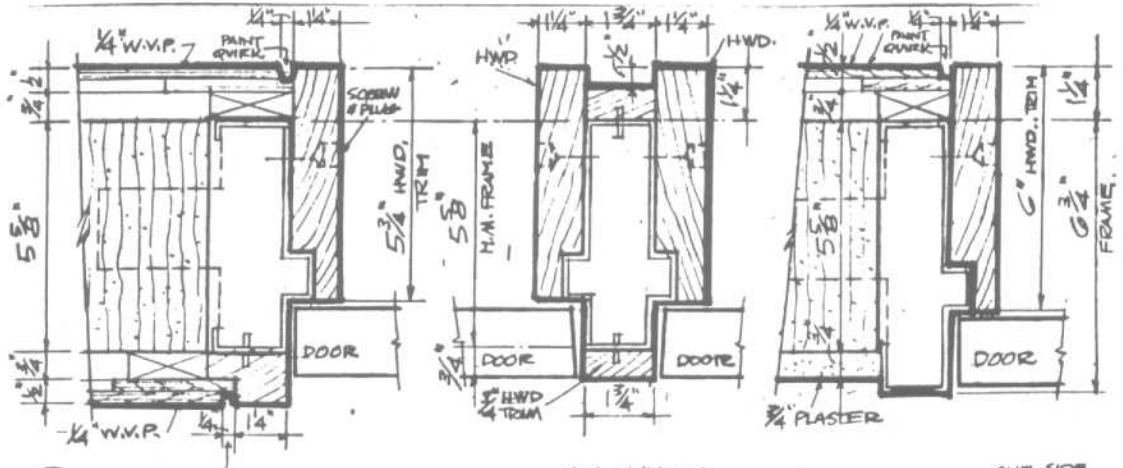
Marble jamb and head details at elevator



HEAD @ ELEVATOR

DOORS

Metal Door Frames

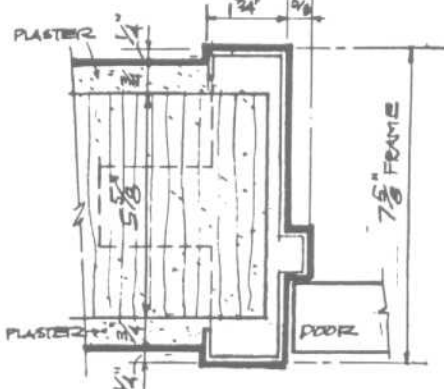


F-1 H.M. FRAME - H.W.D. TRIM  
3" x 1-0"

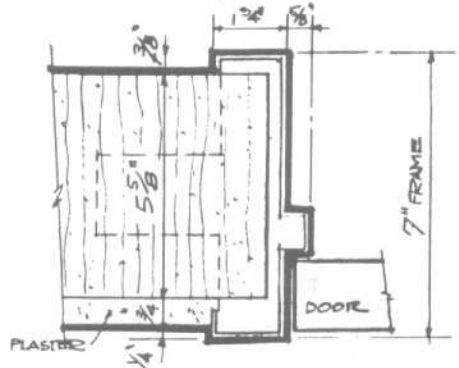
F-2 H.M. MULLION  
H.W.D. TRIM  
3" x 1-0"

F-3 H.M. FRAME - ONE-SIDE  
H.W.D. TRIM  
3" x 1-0"

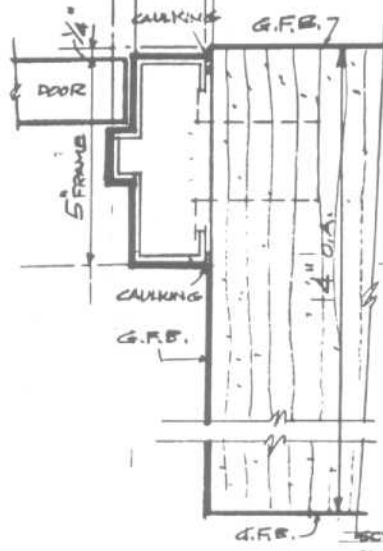
(ALSO TYPICAL AS  
ASTRAL FOR CLASS "B"  
F.R.S.C. DOORS IN FIRE WALL)



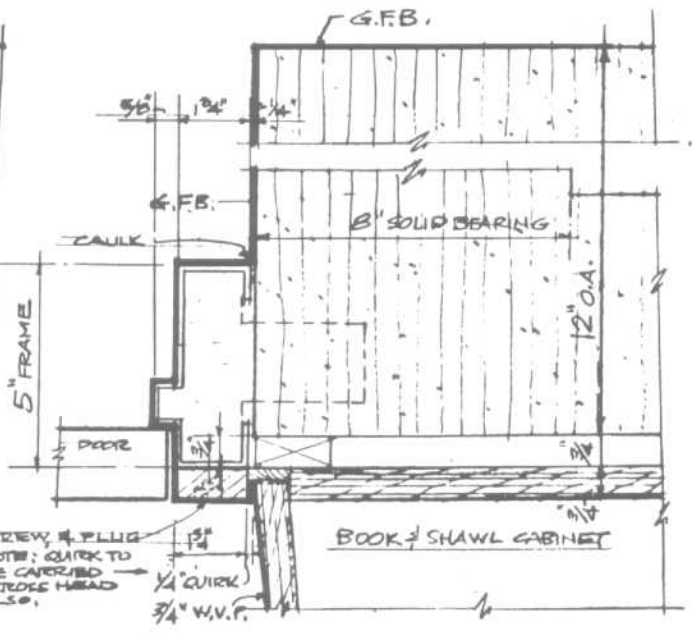
F-4 H.M. FRAME - PLAS. / BOTH SIDES  
3" x 1-0"



F-5 H.M. FRAME - PLAS. / ONE SIDE  
3" x 1-0"



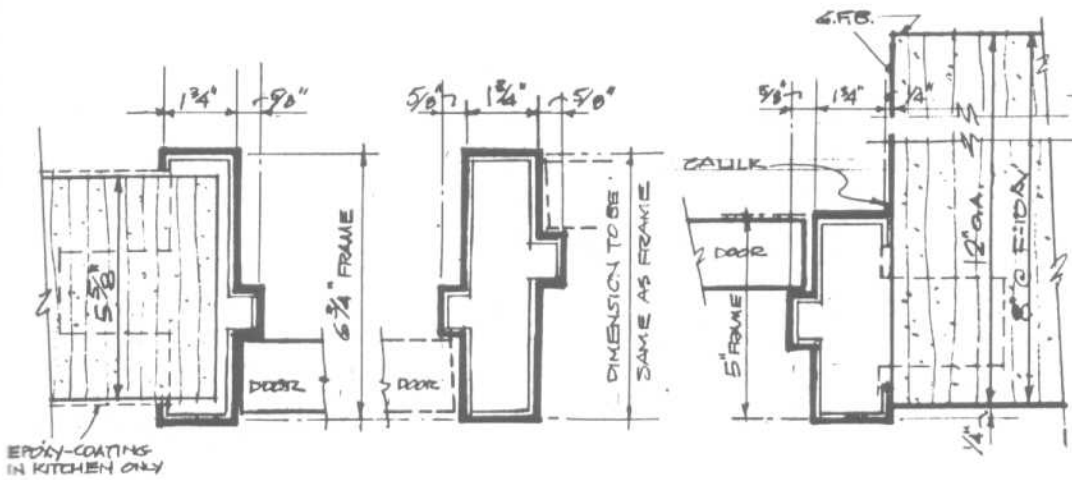
F-6 H.M. EXTERIOR FRAME  
3" x 1-0"



F-7 H.M. FRAME - HARDWOOD / ONE SIDE  
3" x 1-0" SEE DETAIL 4/A-20 FOR DOOR #11

DOORS

Metal Door Frames

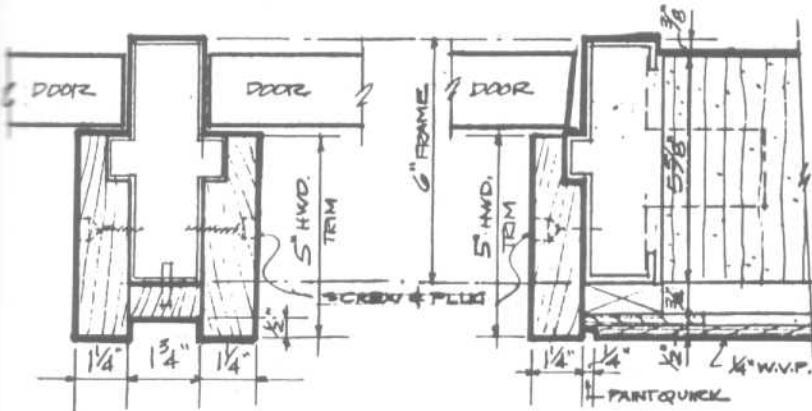


EPoxy COATINGS  
IN KITCHEN ONLY

F-8 H.M. FRAME  
3"x10"

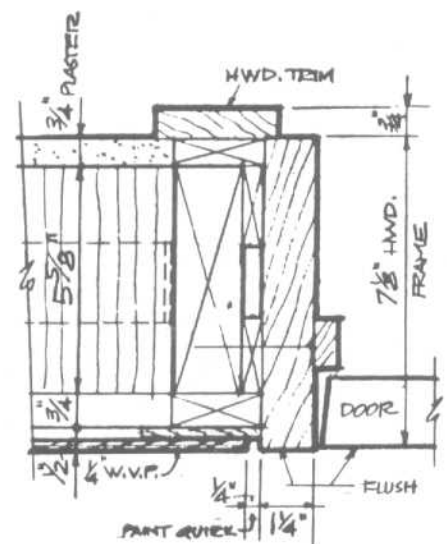
F-9 H.M. MULLION  
3"x10"

F-10 H.M. FRAME  
3"x10"

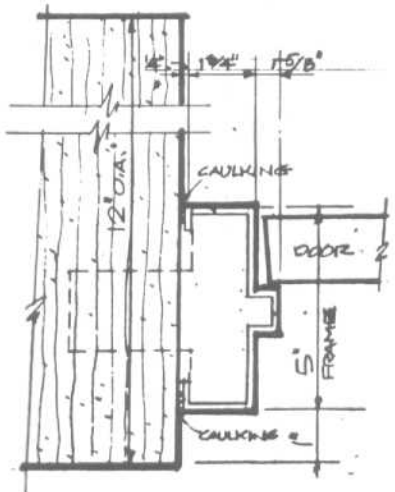


F-11A H.M. FRAME  
HWD. TRIM/ONE SIDE  
3"x10"

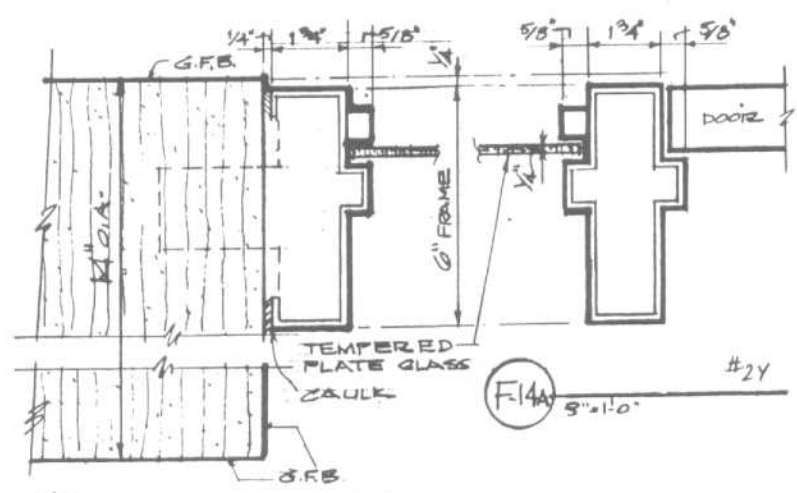
F-11 H.M. FRAME  
HWD. TRIM/ONE SIDE  
3"x10"



F-13 HARDWOOD FRAME  
3"x10"



F-12 H.M. EXTERIOR FRAME  
3"x10"

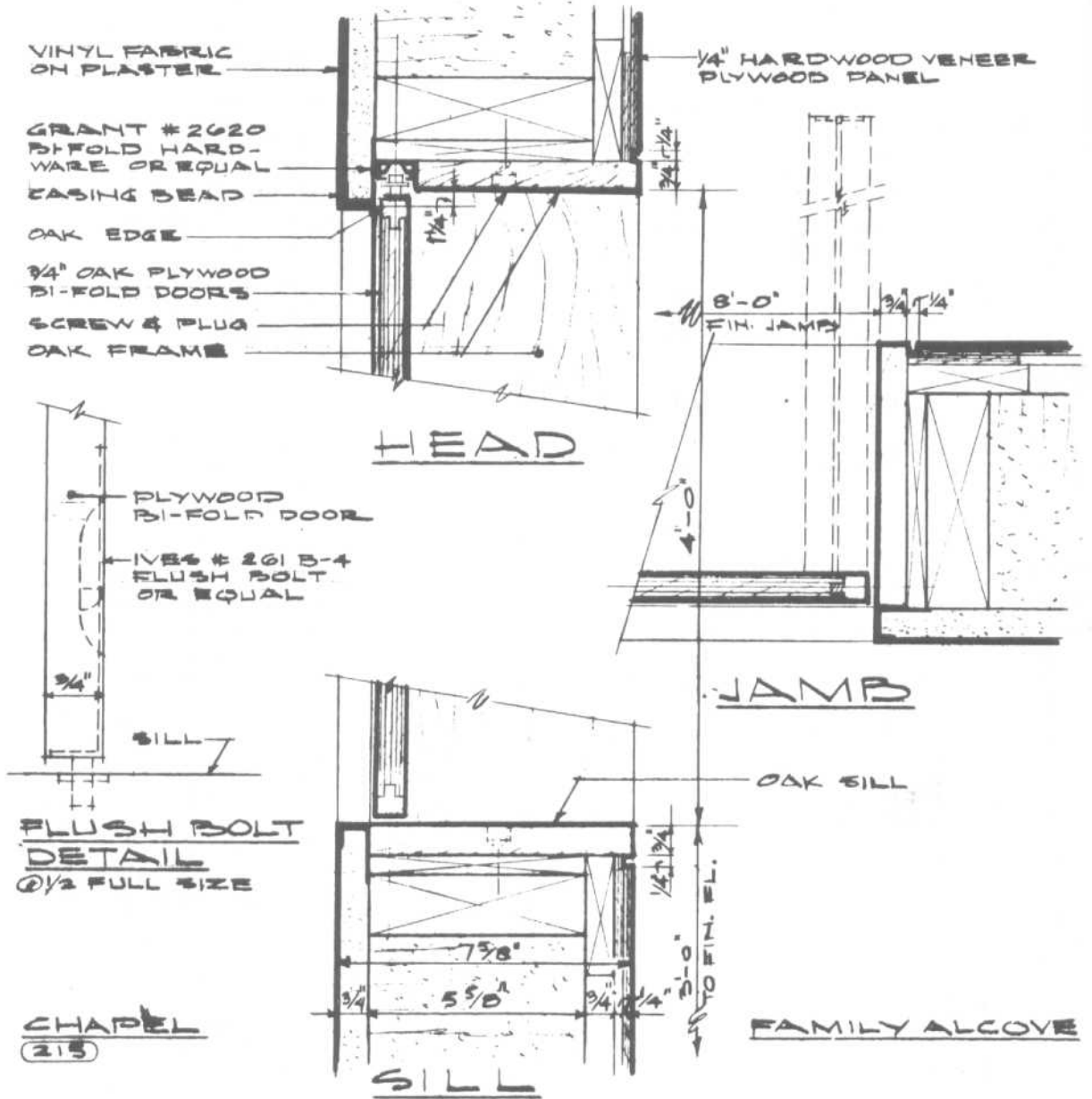


F-14 #2Y  
3"x10"

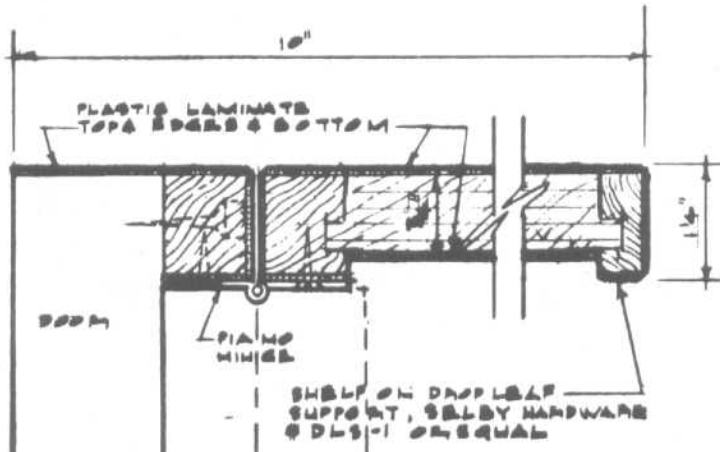
F-14A #2Y  
3"x10"

DOORS

Bi-Fold Doors



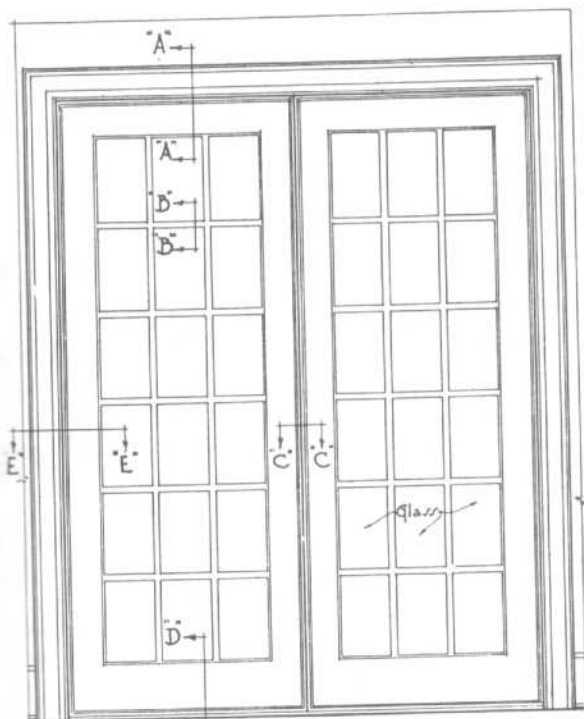
BI-FOLD DOOR DETAILS  
@ 5" = 1'-0"



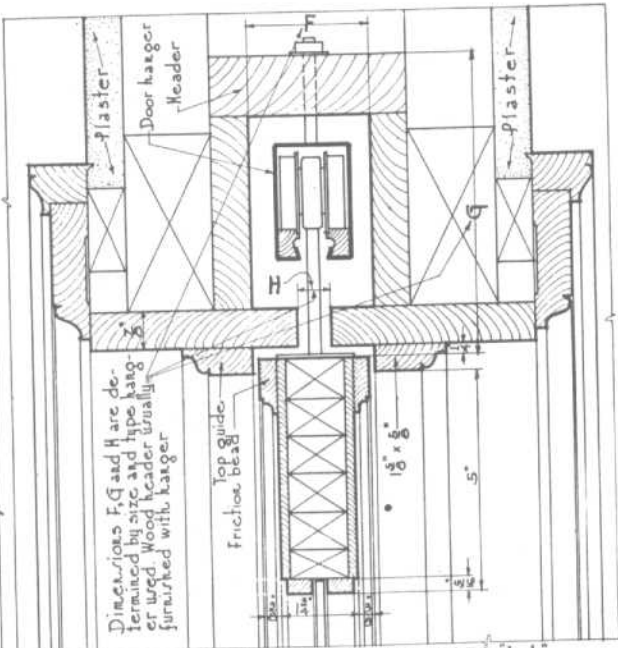
Folding shelf for dutch doors

DOORS

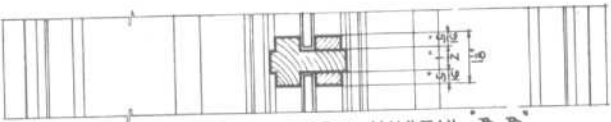
Sliding French Door



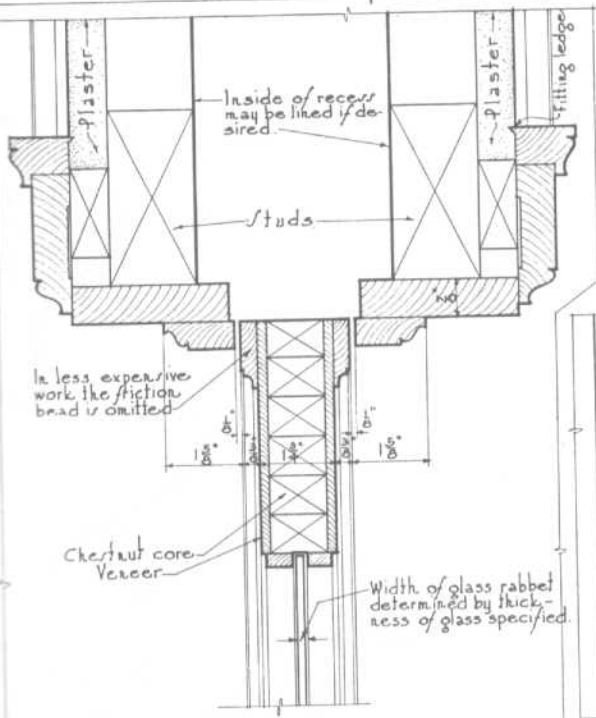
• ELEVATION • OF • SLIDING • DOORS •



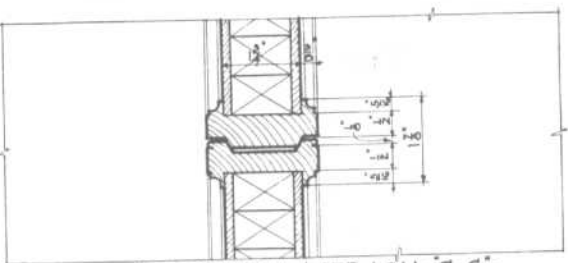
• SECTION • THRU • HEAD • A-A •



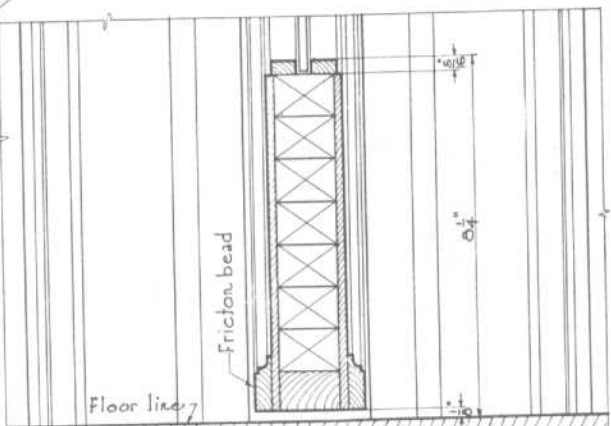
• SECTION • THRU • MUNTIN • D-D •



• SECTION • THRU • JAMB • E-E •



• SECTION • THRU • ASTRAGAL • C-C •



• SECTION • THRU • BOTTOM • RAIL • D-D •

DOORS

Hardware

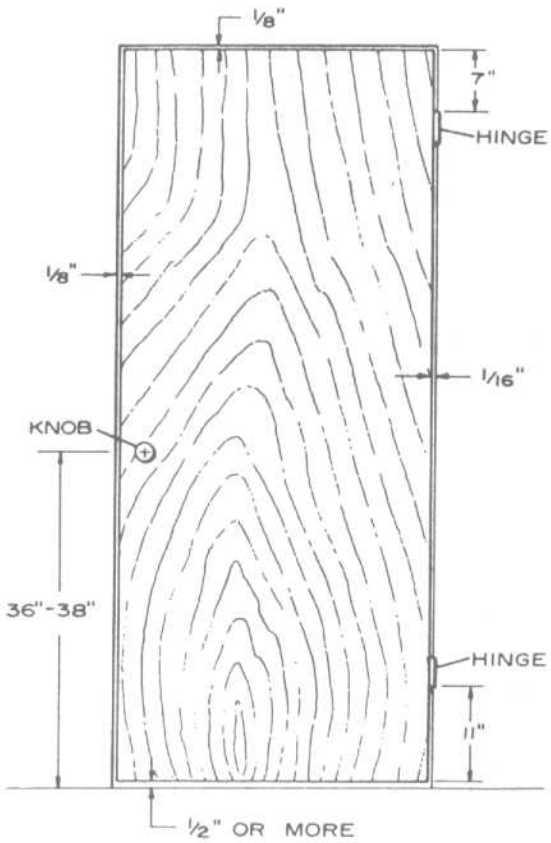


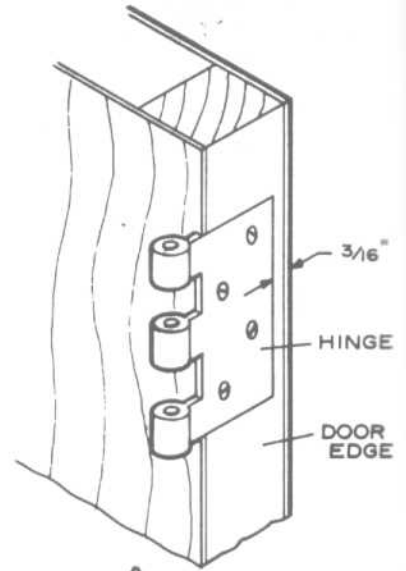
Fig. 24 Door clearances.

Hardware for doors may be obtained in a number of finishes, with brass, bronze, and nickel perhaps the most common. Door sets are usually classed as (a) entry lock for exterior doors, (b) bathroom set (inside lock control with safety slot for opening from the outside), (c) bedroom lock (keyed lock), and (d) passage set (without lock).

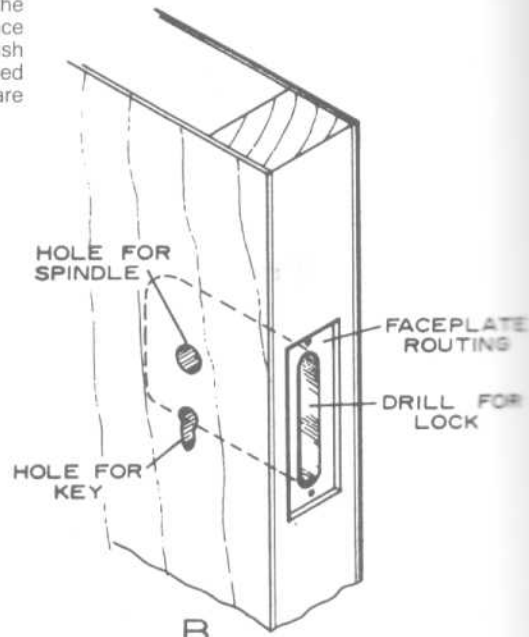
Hinges

Using three hinges for hanging 1 3/4-in exterior doors and two hinges for the lighter interior doors is common practice. There is some tendency for exterior doors to warp during the winter because of the difference in exposure on the opposite sides. The three hinges reduce this tendency. Three hinges are also useful on doors that lead to unheated attics and for wider and heavier doors that may be used within the house.

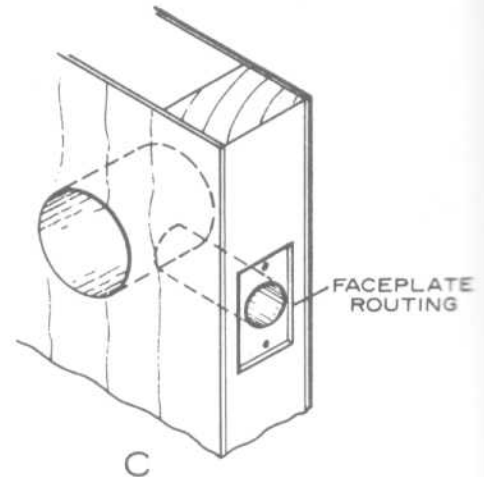
Loose-pin butt hinges should be used and must be of the proper size for the door they support. For 1 3/4-in-thick doors, use 4- by 4-in butts; for 1 3/8-in doors, 3 1/2- by 3 1/2-in butts. After the door is fitted to the framed opening, with the proper clearances, hinge halves are fitted to the door. They are routed into the door edge with about a 3-16-in back distance (Fig. 26A). One hinge half should be set flush with the surface and must be fastened square with the edge of the door. Screws are included with each pair of hinges.



A



B



C

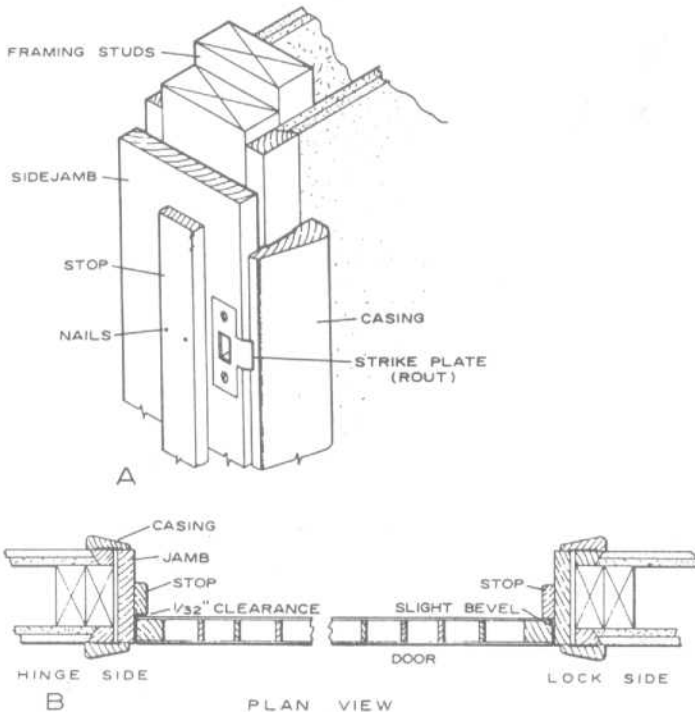
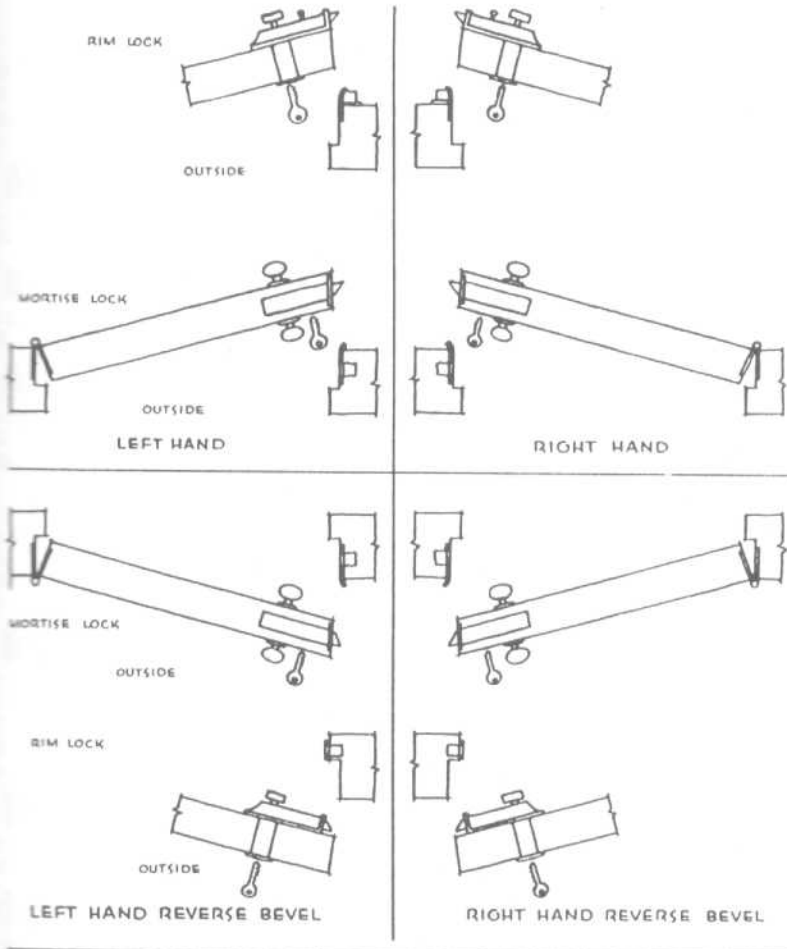


Fig. 25 Door details: A, installation of strike plate; B, location of stops.

Fig. 26 Installation of door hardware: A, hinge; B, mortise lock; C, bored lock set.

DOORS

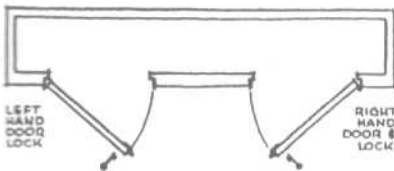
Hand of Locks; Lock Functions



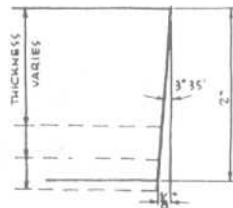
Locks not designated as reversible are made right-hand, left-hand, right-hand reverse bevel, or left-hand reverse bevel.

The hand of a lock is invariably determined from the outside of an entrance door or from the corridor or hall side of a room door. An easy method of determining the hand of a lock is to imagine oneself on that side of the opening from which the lock is controlled or operated by the key. Viewing the opening in this position, note which one of the following is true: (1) If the door swings in and is hinged at your right hand, the lock is right-hand; (2) if hinged at your left hand, the lock is left-hand; (3) if the door swings toward you and is hinged at your right, the lock is right-hand reverse bevel; (4) if hinged at your left hand, the lock is left-hand reverse bevel.

You may find that many locks are marked "reversible," meaning that they are interchangeably right- or left-hand, and in these instances no reference to hand or bevel of lock is necessary. These are locks which operate alike from both sides or locks which can be inverted in order to reverse the locking functions.

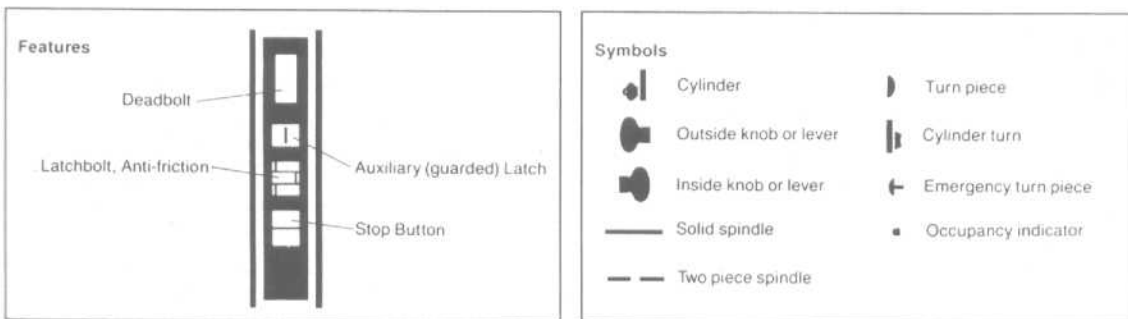


CUPBOARDS, CABINETS, BOOKCASES



STANDARD BEVEL

Determination of the hand of mortise or rim locks




















Features of and symbols for door hardware



DOORS

Lock Functions

	<p><b>OFFICE</b>  <b>For Inner Office and Area Entry Doors.</b></p> <ul style="list-style-type: none"> <li>• Latchbolt retracted by lever or knob from either side unless outside is locked by stop button.</li> <li>• When outside is locked, latchbolt is retracted by key outside and lever or knob inside.</li> <li>• Auxiliary latch deadlocks latchbolt when door is closed.</li> <li>• Latch holdback available.</li> </ul>		<p><b>CLASSROOM</b></p> <ul style="list-style-type: none"> <li>• Latchbolt retracted by lever or knob from either side unless outside is locked by key.</li> <li>• Inside lever or knob always free for immediate exit.</li> <li>• Auxiliary latch deadlocks latchbolt when door is closed.</li> </ul>
	<p><b>APARTMENT ENTRANCE</b>  <b>For Apartment House or Office Building Entrance Doors</b></p> <ul style="list-style-type: none"> <li>• Latchbolt retracted by lever or knob either side unless outside is locked by key from inside.</li> <li>• When locked, latchbolt retracted by tenant key outside, lever or knob inside.</li> <li>• Auxiliary latch deadlocks latchbolt when door is closed.</li> </ul>		<p><b>STOREROOM</b></p> <ul style="list-style-type: none"> <li>• Latchbolt retracted by lever or knob inside, by key outside.</li> <li>• Outside lever or knob always inoperative. Knob is free spinning.</li> <li>• Auxiliary latch deadlocks latchbolt when door is closed.</li> <li>• Latch holdback available.</li> </ul>
	<p><b>INSTITUTION</b>  <b>For Permanently Locked Passage Doors.</b></p> <ul style="list-style-type: none"> <li>• Latchbolt retracted by key from either side.</li> <li>• Both levers or knobs always inoperative.</li> <li>• Auxiliary latch deadlocks latchbolt when door is closed.</li> <li>• Latch holdback available.</li> </ul>		<p><b>ENTRANCE</b>  <b>For Commercial and Residential Entry Doors</b></p> <ul style="list-style-type: none"> <li>• Deadbolt and latchbolt retracted by lever or knob trim either side unless outside is locked by stop button.</li> <li>• When locked, key outside and lever or knob inside retracts deadbolt and latchbolt simultaneously. Outside remains locked until stop button is reset to unlocked position.</li> <li>• Deadbolt operated by key and turn piece. Throwing deadbolt automatically locks stop button.</li> <li>• Auxiliary latch deadlocks latchbolt when door is closed and locked.</li> </ul>
	<p><b>STORE DOOR</b>  <b>For Store Entrance Doors.</b></p> <ul style="list-style-type: none"> <li>• Latchbolt retracted by lever or knob from either side unless outside is locked by stop button.</li> <li>• When locked latchbolt retracted by key outside and lever or knob inside.</li> <li>• Deadbolt operated by key from either side.</li> <li>• Auxiliary latch deadlocks latchbolt when door is closed.</li> </ul>		<p><b>CONVALESCENT</b>  <b>For Convalescent or Bedroom Doors</b></p> <ul style="list-style-type: none"> <li>• Latchbolt retracted by lever or knob from either side when unlocked.</li> <li>• Deadbolt operated by key outside and turn piece inside.</li> <li>• Throwing deadbolt disengages outside lever or knob.</li> <li>• Turning inside lever or knob retracts deadbolt and latchbolt simultaneously for immediate exit and unlocks outside.</li> </ul>
	<p><b>STORE DOOR</b>  <b>For Storedoor, Storeroom or Utility Room Doors.</b></p> <ul style="list-style-type: none"> <li>• Latchbolt retracted by lever or knob from either side.</li> <li>• Deadbolt operated by key from either side.</li> </ul>		<p><b>CLOSET</b>  <b>For Closet, Storeroom, or Utility Room Doors</b></p> <ul style="list-style-type: none"> <li>• Latchbolt retracted by lever or knob from either side at all times.</li> <li>• Deadbolt operated by key outside.</li> </ul>
	<p><b>CYLINDER X TURN PIECE</b>  <b>Deadlock</b></p> <ul style="list-style-type: none"> <li>• Deadbolt operated by key outside and turn inside.</li> </ul>		<p><b>DORMITORY</b>  <b>For Dormitory or Bedroom Doors.</b></p> <ul style="list-style-type: none"> <li>• Latchbolt retracted by lever or knob from either side at all times.</li> <li>• Deadbolt is operated by key outside and by turn piece inside.</li> </ul>
	<p><b>DOUBLE CYLINDER</b>  <b>Double Cylinder Deadlock</b></p> <ul style="list-style-type: none"> <li>• Deadbolt operated by key from either side.</li> <li>• Bolt automatically deadlocks when fully thrown.</li> </ul>		<p><b>HOTEL</b>  <b>For Corridor Doors to Guest Rooms.</b></p> <ul style="list-style-type: none"> <li>• Outside lever or knob always inoperative. Knob is free spinning.</li> <li>• Latchbolt retracted by guest key outside except when deadbolt is thrown by turn piece inside.</li> <li>• When thrown occupancy indicator is engaged, all keys inoperative except emergency or display keys.</li> <li>• Turning inside lever or knob retracts deadbolt and latchbolt simultaneously. Aux. latch deadlocks latchbolt when door is closed.</li> </ul>
	<p><b>CLASSROOM</b>  <b>Classroom Deadlock</b></p> <ul style="list-style-type: none"> <li>• Deadbolt operated by key outside.</li> <li>• Cylinder turn inside will retract deadbolt but will not project it.</li> <li>• Bolt automatically deadlocks when fully thrown.</li> </ul>		<p><b>HOTEL</b>  <b>For Corridor Doors to Guest Rooms</b></p> <ul style="list-style-type: none"> <li>• Same as 85P function except that visual "DO NOT DISTURB" plate replaces occupancy indicator button.</li> <li>• Available for 1 3/4" doors and escutcheon trim only.</li> </ul>
	<p><b>CYLINDER X BLANK</b>  <b>Deadlock</b></p> <ul style="list-style-type: none"> <li>• Deadbolt operated by key from one side.</li> <li>• No trim on opposite side.</li> <li>• Bolt automatically deadlocks when fully thrown.</li> </ul>		



## DOORS

## Lock Functions

A. N. S. I.  
No. Grade**ANSI A156.2**  
**Non-Keyed Locks Series 4000****Passage Latch:** Both knobs always unlocked**Exit Lock:** Unlocked by knob inside only. Outside knob always fixed.**Closet Latch:** Outside knob and inside thumbturn are always unlocked.**Exit Lock:** Blank plate outside. Inside knob always unlocked. (Specify door thickness, 1 3/8" or 1 3/4".)**Patio Lock:** Push-button locking. Turning inside knob releases button. Closing door on A & D series also releases button.**Bath/Bedroom Privacy Lock:** Push-button locking. Can be opened from outside with small screwdriver or flat narrow tool. Turning inside knob releases push-button. Closing door on A, C and D series also releases button, preventing lock-out.**Communicating Lock:** Turn button in outer knob locks and unlocks knob and inside thumbturn.**Hospital Privacy Lock:** Push-button locking. Unlocked from outside by turning emergency turn-button. Rotating inside knob or closing door releases inside button.A. N. S. I.  
No. Grade**Dummy Trim****Single Dummy Trim:** Single dummy trim for one side of door. Used for door pull or as matching inactive trim.A. N. S. I.  
No. Grade**ANSI A156.2**  
**Keyed Locks****ANSI A156.2**  
**Series 4000****Entrance Lock:** Unlocked by key from outside when outer knob is locked by turn-button in inside knob. Inside knob always unlocked.**Entrance/Office Lock:** Push button locking. Pushing button locks outside lever until unlocked with key or by turning inside lever.**Entrance Lock:** Turn/Push button locking: Pushing and turning button locks outside knob requiring use of key until button is manually unlocked. Push button locking: Pushing button locks outside knob until unlocked by key or by turning inside knob.**Service Station Lock:** Unlocked by key from outside when outer knob is locked by universal button in inside knob. Closing door releases button. Outside knob may be fixed by rotating universal button.**Vestibule Lock:** Unlocked by key from outside when outside knob is locked by key in inside knob. Inside knob is always unlocked.**Store Lock:** Key in either knob locks or unlocks both knobs.**Classroom Lock:** Outside knob locked and unlocked by key. Inside knob always unlocked.**Communicating Lock:** Key in either knob locks or unlocks each knob independently.**Dormitory Lock:** Locked or unlocked by key from outside. Push-button locking from inside. Turning inside knob or closing door releases button.**Classroom Hold-Back Lock:** Outside knob locked or unlocked by key. Inside knob always unlocked. Latch may be locked in retracted position by key.A10S F75 2  
C10S 1  
D10S 1  
F10N 2

D12D F89 1



A20S

A25D  
D25DA30D F77 2  
D30D 1  
F30N 2A40S F76 2  
C40S 1  
D40S 1  
F40N 2

A43D F79 2

A44S  
D44SA170  
D170  
F170N

F51N F81 2



D50PD F82 1

A53PD F81 2  
C53PD F82 1  
D53PD F82 1A55PD F92 2  
D55PD 1

D60PD F88 1



D66PD F91 1

A70PD F84 2  
C70PD 1  
D70PD 1

D72PD F80 1

A73PD F90 2  
D73PD 1

D76PD F85 1



DOORS

Lock Functions

		A.	N.	S.	I.		
		No.	Grade				
A79PD							
A80PD	F86		2				
C80PD			1				
D80PD			1				
F80N			2				
D82PD	F87		1				
A85PD	F93		2				
D85PD			1				

**Keyed Locks** *ANSI A156.2 Series 4000*

**Communicating Lock:** Locked or unlocked by key from outside. Blank plate inside.

**Storeroom Lock:** Outside knob fixed. Entrance by key only. Inside Knob always unlocked.

**Institution Lock:** Both knobs fixed. Entrance by key in either knob.

**Hotel-Motel Lock:** Outside knob fixed. Entrance by key only. Push-button in inside knob activates visual occupancy indicator, allowing only emergency masterkey to operate. Rotation of inside spanner-button provides lockout feature by keeping indicator thrown.

		A.	N.	S.	I.		
		No.	Grade				
B160N	E2151		2				
B460P			1				
B560			1				
B162N†	E2141		2				
B462P†			1				
B562†			1				
B461P	E2161		1				
B463P	E2171		1				
B464P							
B180	E2191		2				
B480			1				

**Deadbolt Locks** *ANSI A 156.5*

**Single Cylinder Deadbolt Lock:** Deadbolt thrown or retracted by key from outside or by inside turn unit. Bolt automatically deadlocks when fully thrown.

**Double Cylinder Deadbolt Lock:** Deadbolt thrown or retracted by key from either side.

**One-Way Deadbolt Lock:** Deadbolt thrown or retracted by key only. Blank plate inside.

**Classroom Deadbolt Lock:** Deadbolt thrown or retracted by key outside. Inside turn unit will retract bolt only.

**Cylinder Lock:** Deadbolt thrown or retracted by key from one side. No inside trim.

**Door Bolt:** Deadbolt thrown or retracted by turn unit only. No outside trim.

		A.	N.	S.	I.		
		No.	Grade				
B250PD	E2121		1				
B252PD†	E2111		1				
B270D	E2181		1				

**Deadlatch Locks** *ANSI A156.5*

**Night Latch:** Deadlocking latchbolt retracted by key from outside or by inside turn unit. Rotating turn unit and activating hold-back feature keeps latch retracted.

**Double Cylinder Deadlatch:** Deadlocking latchbolt retracted by key from either side. No hold-back feature.

**Exit Latch:** Deadlocking latchbolt retracted by inside turn unit only. No outside trim. Rotating turn unit and activating hold-back feature keeps latch retracted.

Schlage Number	A.	N.	S.	I.		
	No.	Grade				
B245S						
B281						
B282						

**Lever Functions**

**Lever Passage Latch:** For use on passage, closet and doors that do not require locking. Rotating either lever retracts latchbolt. (Specify door hand.)

**Single Dummy Trim-Double Dummy Trim:** For use on single or pairs of doors when fixed turn is required. (Specify door hand.)

		A.	N.	S.	I.		
		No.	Grade				
E51PD							
F160N							
F162N†							

**Grip Handle Sets**

**Entrance Lock:** Unlocked by key from outside when thumb-piece is locked by inside turn-button.

**Entrance Lock:** Deadbolt thrown or retracted by key from outside or by inside turn unit. Latch retracted by thumbpiece from outside or by inside knob.

**Double Cylinder Entrance Lock:** Deadbolt thrown or retracted by key from either side. Latch retracted by thumbpiece from outside or by inside knob.

†CAUTION: Double cylinder locks on residences and any door in any structure which is used for egress are a safety hazard in times of emergency and their use is not recommended. Installation should be in accordance with existing codes only.

A. N. S. I.  
No. Grade**Dummy Trim**

**Outside and Inside Dummy Trim:** For use as door pull or as dummy trim on an inactive pair of doors. Fixed thumbpiece and inside knob. Thru bolted dummy cylinder.

**Outside and Inside Dummy Trim:** For use as door pull or as dummy trim on inactive leaf of pair of doors. Fixed thumbpiece and inside knob. Dummy cylinder with inside plate.

A. N. S. I.  
No. Grade**Interconnected Locks**

ANSI A156.12

**Entrance—Single Locking:** Deadbolt thrown or retracted by key in upper lock from outside or by inside turn unit. Latchbolt retracted by knob from either side. Turning inside knob retracts deadbolt and latchbolt simultaneously for immediate exit.

**Entrance—Double Locking:** Deadbolt thrown or retracted by key in upper lock from outside or by inside turn unit. Deadlatch retracted by key in outer knob when locked by pushing turn-button in inner knob. Outer knob may be fixed in locked position by rotating turn-button. Inside knob retracts deadbolt and deadlatch simultaneously for immediate exit.

**Storeroom Lock:** Bolt may be operated by key from outside or by turn unit from inside. Bolt automatically deadlocks when fully thrown. Lock may be opened by key from outside. Inside knob will retract both latch and deadbolt. Latch automatically deadlocks when door is closed, inside knob always free for immediate exit. Outer knob always fixed.

**Hotel-Motel Lock:** Deadbolt thrown or retracted by key in upper lock from outside or by inside turn unit. Deadlatch retracted by key in outer fixed knob. Push-button in inner knob activates visual occupancy indicator, allowing only emergency masterkey to operate. Rotation of inside spanner-button provides lockout feature by keeping indicator thrown. Turning inside knob retracts deadbolt simultaneously for immediate exit.

A. N. S. I.  
No. Grade**Dummy Trim**

**Single Dummy Inside Trim:** Snap-on rose and knob. Concealed mounting screws.

**Dummy Trim Inside and Outside:** Snap-on rose and knobs thru-bolted.

A. N. S. I.  
No. Grade**Mortise Locks Non-Keyed** ANSI A156.13  
Series 1000

**Passage Latch:** Latch bolt retracted by lever or knob from either side at all times.

**Bath/Bedroom Privacy Lock:** Latchbolt retracted by lever or knob from either side unless outside is locked by inside turn piece. Operating inside lever or knob or closing door unlocks outside lever or knob. To unlock from outside, remove emergency button, insert turn piece (furnished) in access hole and rotate.

**Single Dummy Trim:** Lever or knob on both sides fixed by mounting bar.

**Pair Dummy Trim:** Lever or knob on both sides fixed by mounting bar.

**Single Dummy Trim:** Lever or knob on one side fixed. Includes lock chassis and armor front.

**Pair Dummy Trim:** Lever or knob both sides fixed. Includes lock chassis and armor front.

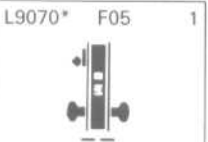
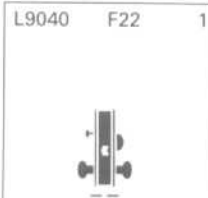
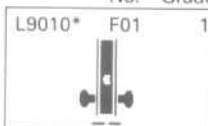
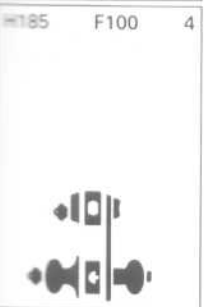
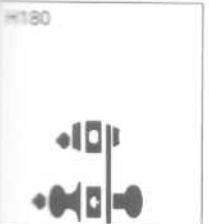
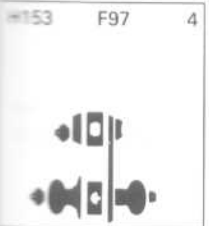
A. N. S. I.  
No. Grade**Keyed Locks**

**Office and Inner Entry Lock:** Latchbolt retracted by lever or knob from either side unless outside is made inoperative by key outside or by rotating inside turn piece. When outside is locked, latchbolt is retracted by key outside or by lever or knob inside. Outside lever or knob remains locked until thumbturn is returned to vertical or by counter clockwise rotation of key. Auxiliary latch deadlocks latchbolt when door is closed.

**Apartment Entrance Lock:** Latchbolt retracted by lever or knob from either side unless outside is locked by key from inside. When locked, latchbolt retracted by key outside or lever or knob inside. Auxiliary latch deadlocks when door is closed.

**Classroom Lock:** Latchbolt retracted by lever or knob from either side unless outside is locked by key. Unlocked from outside by key. Inside lever or knob always free for immediate exit. Auxiliary latch deadlocks latchbolt when door is closed.

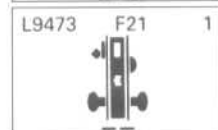
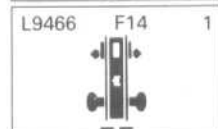
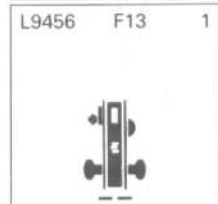
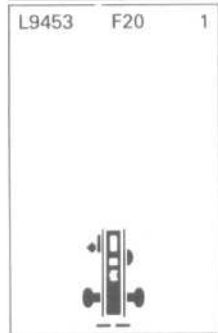
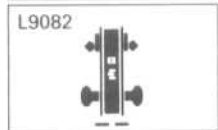
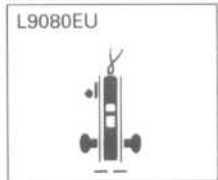
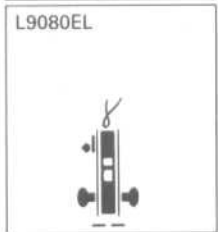
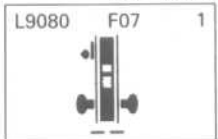
\*\*When armored front is required as strike for inactive door, specify L9177 for single or L9178 for pair of dummy trim. Specify door hand.



DOORS

Lock Functions

A. N. S. I.  
No. Grade



**Keyed Locks**

**Storeroom Lock:** Latchbolt retracted by key outside or by lever or knob inside. Outside lever or knob always inoperative. Auxiliary latch deadlocks latchbolt when door is closed.

**Storeroom Lock:** Electrically locked. Outside lever or knob continuously locked by 24V AC or DC. Latchbolt retracted by key outside or by lever or knob inside. Switch or power failure allows outside lever or knob to retract latchbolt. Auxiliary latch deadlocks latchbolt when door is closed. Inside lever or knob always free for immediate exit.

**Storeroom Lock:** Electrically unlocked. Outside lever or knob unlocked by 24V AC or DC. Latchbolt retracted by key outside or lever or knob inside. Auxiliary latch deadlocks latchbolt when door is closed. Inside lever or knob always free for immediate exit.

**Institution Lock:** Latchbolt retracted by key from either side. Lever or knob on both sides always inoperative. Auxiliary latch deadlocks latchbolt when door is closed.

**Entrance Lock:** Latchbolt retracted by lever or knob from either side unless outside is locked by 20° rotation of thumbturn. Deadbolt thrown or retracted by 90° rotation of thumbturn. When locked, key outside or lever or knob inside retracts deadbolt and latchbolt simultaneously. Outside lever or knob remains locked until thumbturn is restored to vertical position. Throwing deadbolt automatically locks outside lever or knob. Auxiliary latch deadlocks latchbolt when door is closed.

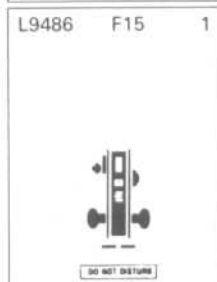
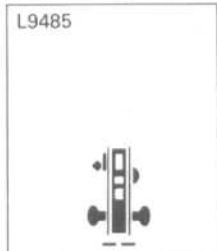
**Dormitory/Exit Lock:** Latchbolt retracted by lever or knob from either side. Deadbolt thrown or retracted by key outside or inside thumbturn. Throwing deadbolt locks outside lever or knob. Rotating inside lever or knob simultaneously retracts deadbolt and latchbolt, and unlocks outside lever or knob.

**Closet/Storeroom Lock:** Latchbolt retracted by lever or knob from either side except when deadbolt is extended. Deadbolt extended or retracted by key outside.

**Store/Utility Room Lock:** Latchbolt retracted by knob or lever from either side except when deadbolt extended. Deadbolt extended or retracted by key from either side.

**Dormitory/Bedroom Lock:** Latchbolt retracted by knob or lever from either side except when deadbolt is extended. Deadbolt extended or retracted by key outside or thumbturn inside.

A. N. S. I.  
No. Grade

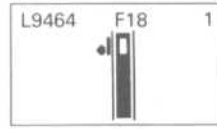
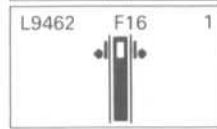
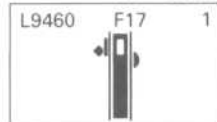


**Keyed Locks**

**Hotel Lock:** Latchbolt by key outside or by lever or knob inside. Outside lever or knob always fixed. Deadbolt thrown or retracted by inside thumbturn. When deadbolt is thrown, all keys become inoperative except emergency or display keys. Turning inside lever or knob retracts both deadbolt and latchbolt simultaneously. Auxiliary latch deadlocks latchbolt when door is closed.

**Hotel Lock:** Latchbolt retracted by key outside or by lever or knob inside. Outside lever or knob always fixed. Deadbolt thrown or retracted by inside thumbturn. When deadbolt is thrown, "DO NOT DISTURB" plate is displayed—all keys become inoperative except emergency or display keys. Turning inside lever or knob retracts both deadbolt and latchbolt simultaneously. Auxiliary latch deadlocks latchbolt when door is closed.

A. N. S. I.  
No. Grade



**Deadlocks**

**Cylinder X Thumbturn:** Deadbolt thrown or retracted by key outside or thumbturn inside.

**Double Cylinder:** Deadbolt operated by key from either side.

**Classroom Lock:** Deadbolt thrown or retracted by key from outside. Inside cylinder turn retracts deadbolt but cannot project it.

**Cylinder Lock:** Deadbolt thrown or retracted by key from one side. No trim on opposite side.

This section provides the designer with information on both suspended ceilings and ceilings directly attached to the structure above. It starts with a review of generic suspension systems and then provides details and discussion of the various suspended ceiling types.

Large-scale details show how, in addition to standard acoustical tiles, other ceiling materials such as plaster, metal panels, baffles, gypsum board, and wood can be attached to suspension systems. A variety of

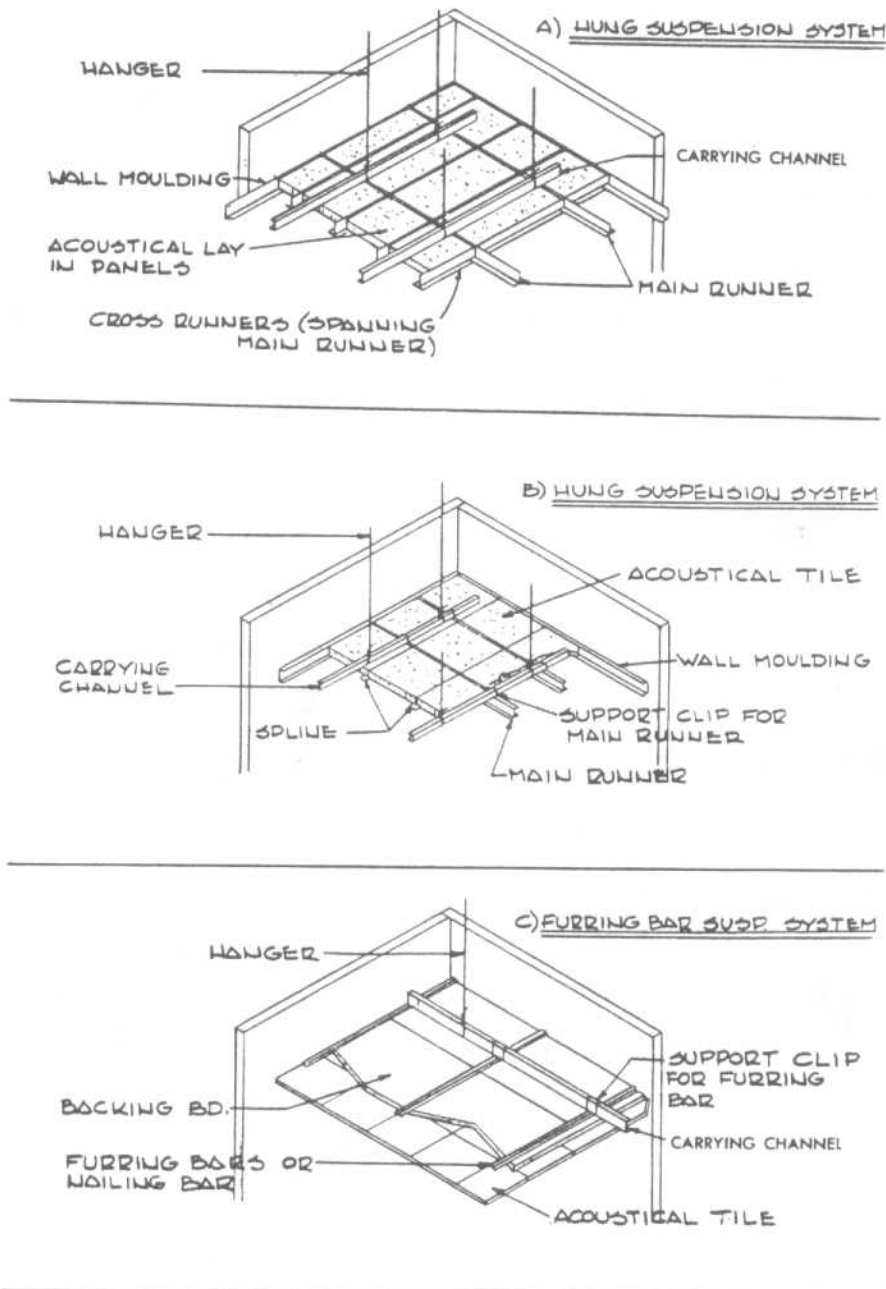
unusual conditions are also detailed, including curved and vaulted ceilings, wall conditions, light coves, and lighting fixture framing.

The designer is cautioned that in many jurisdictions, suspension systems must attain a higher level of structural integrity than most other architectural elements. For example, wire hangers may not be an acceptable method of suspending channels from the structure above. Rather, steel rods of a minimum diameter or flat bar hangers of a

minimum width and thickness may be required. Local or state codes should always be consulted prior to finalizing such details.

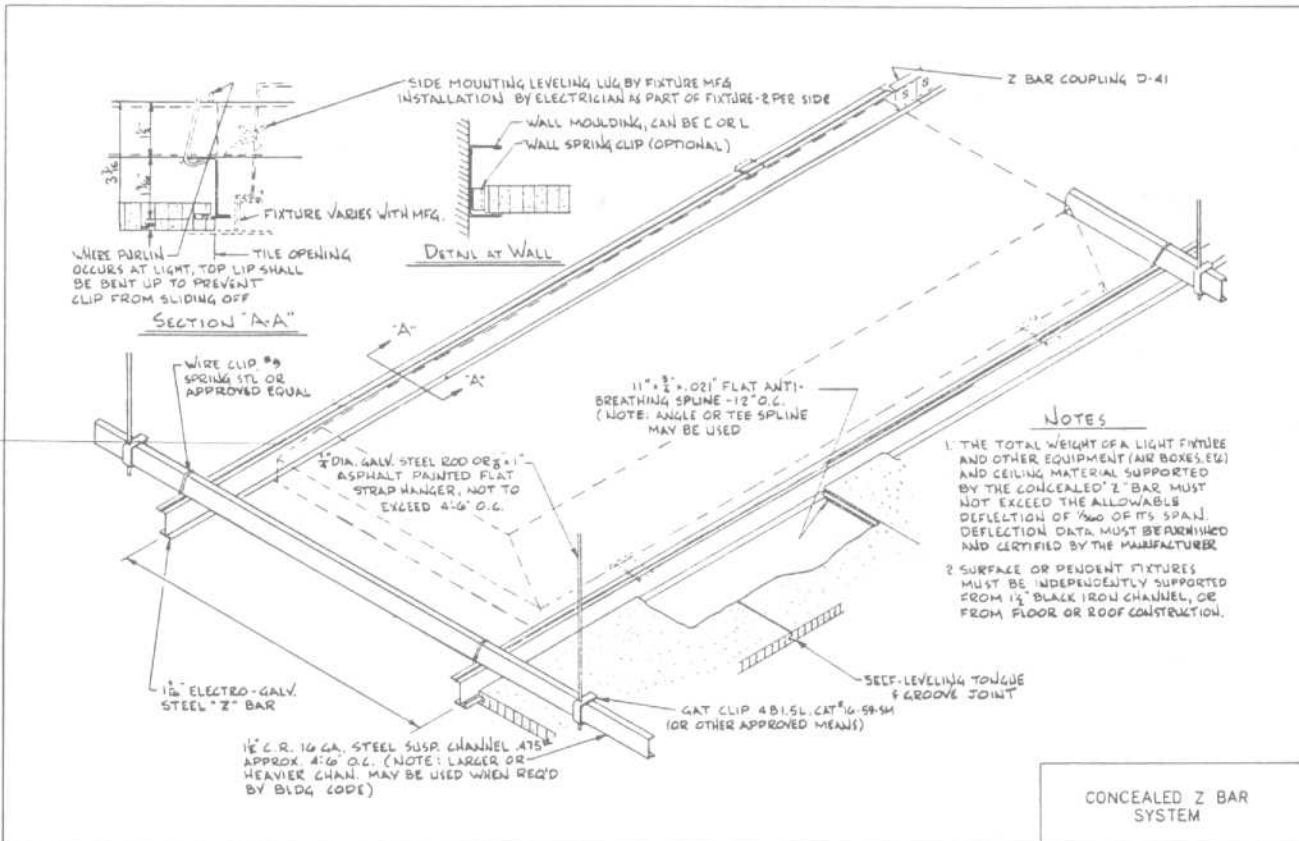
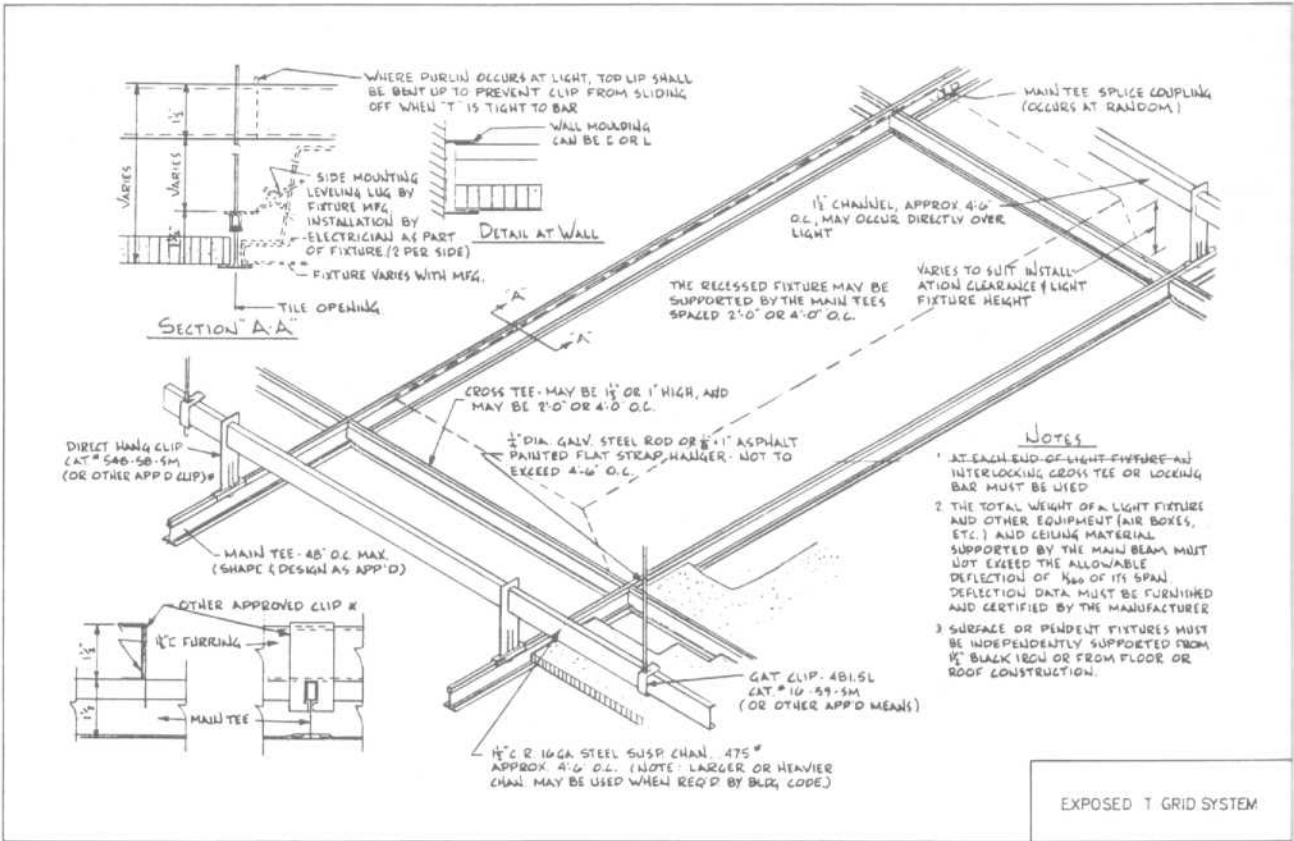
In many situations, the ceiling "skin" takes on further importance beyond aesthetic, acoustical, or visual requirements. It can also be used to complete an envelope that provides a fire-resistive rating to the structural members above. Again, it is necessary to thoroughly investigate the building and fire codes that might govern ceiling design.

### Acoustical Tile and Lay-in Panel Ceiling Suspension Systems



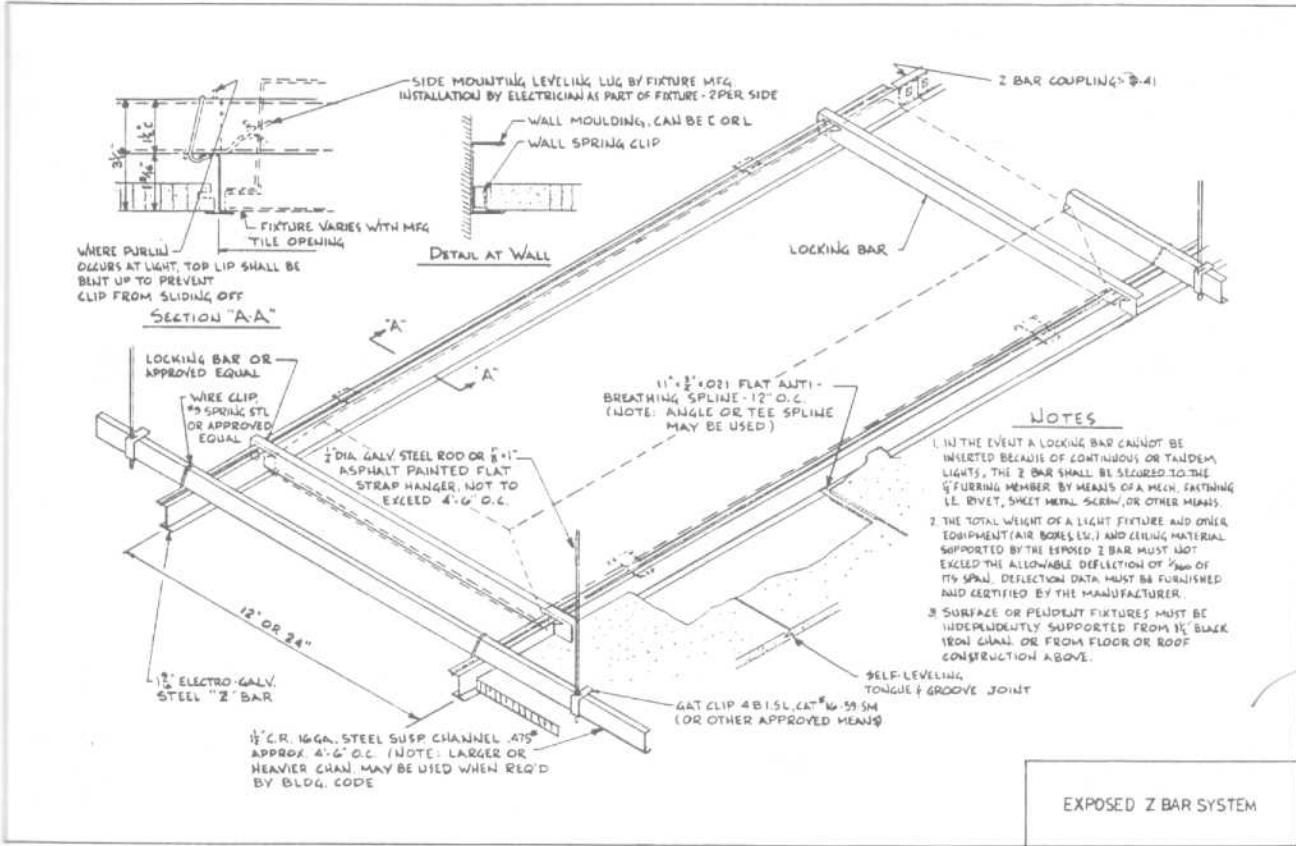
CEILINGS

Suspension System Types



CEILINGS

Suspension System Types





**CEILINGS**

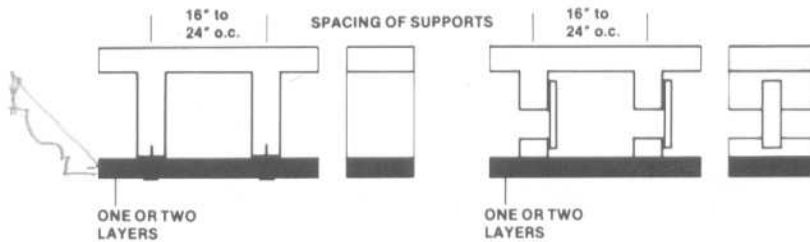
Gypsum Board Suspended Ceilings

**ASSEMBLY**

**REMARKS**

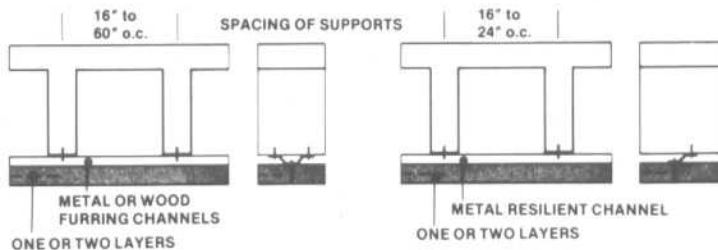
**GYPSUM BOARD, ATTACHED**

**DIRECT TO FRAMING**



- secured directly to framing members or to solid furring.
- most widely used in residential and light commercial construction.
- two layers may be required for an improved fire resistance rating or for better resistance to sound transmission.
- directly affected by deflection and/or expansion/contraction in supporting framing.

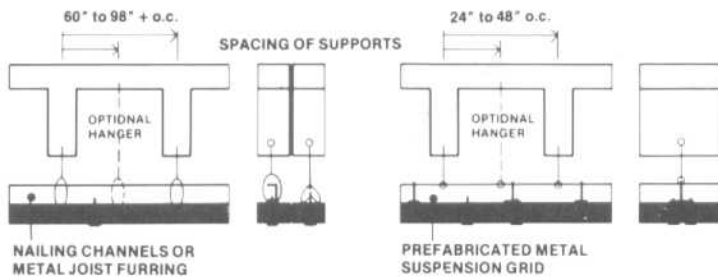
**FURRED-DOWN**



- hat-shaped or resilient channels may be used.
- furring will minimize effects of deflection and expansion/contraction in framing upon membrane.
- resilient channels also used to improve resistance to sound transmission.
- furring will also minimize effects of streaking due to temperature differential which may occur with direct attachment.

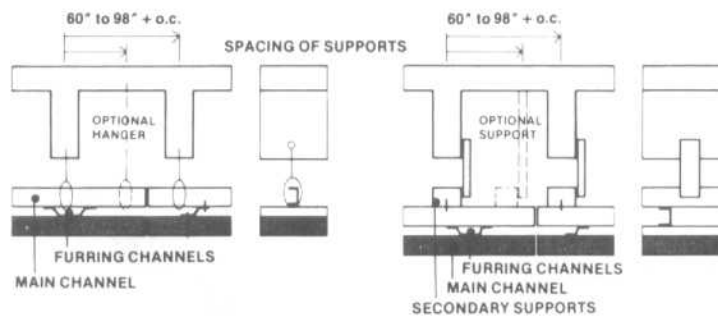
**GYPSUM BOARD, SUSPENDED**

**PRIMARY SUPPORTS ONLY**



- when framing is spaced more than 24 inches on centers, or when a plenum space for mechanical/electrical service lines is required, a suspension/support system consisting of wood or metal sections or special nailing channels is generally provided.
- prefabricated metal suspension systems are available.

**PRIMARY AND SECONDARY SUPPORTS**



- primary suspension system may also include a secondary system of furring channels used to align the primary system and/or to provide resilient mounting of the membrane.
- it is a high cost assembly and not widely used.
- resilient furring channels generally used with wood framing.

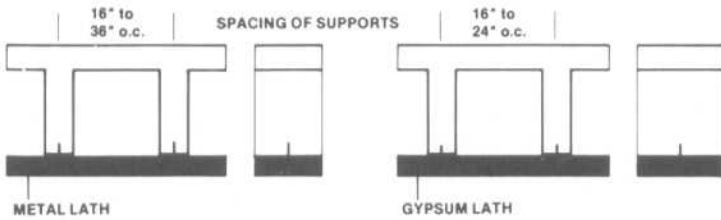


ASSEMBLY

REMARKS

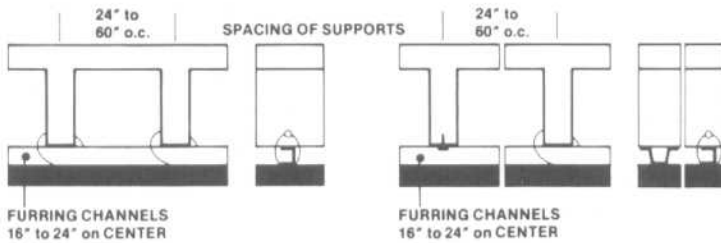
PLASTER, ATTACHED

DIRECT TO FRAMING



- metal or gypsum lath secured directly to framing.
- membrane will be directly affected by deflection and/or expansion/contraction in supporting framing.
- metal lath may be backed for machine application of plaster.
- fire resistance ratings for different assemblies have been established.

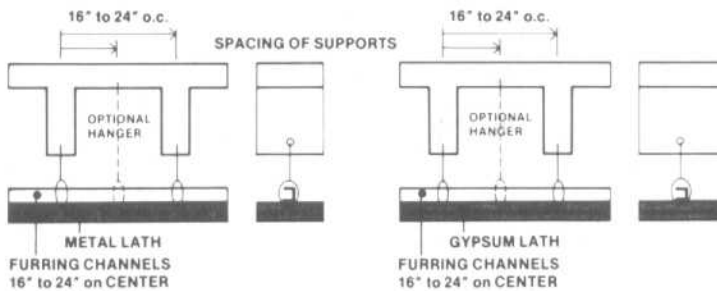
FURRED-DOWN



- furring channels secured to framing, lath supported by furring.
- furring will minimize effects of deflection and expansion/contraction upon membrane.
- large areas of membrane should have expansion joints and should not be restrained at the perimeter.
- corners of openings in gypsum lath membranes should have metal lath reinforcing.

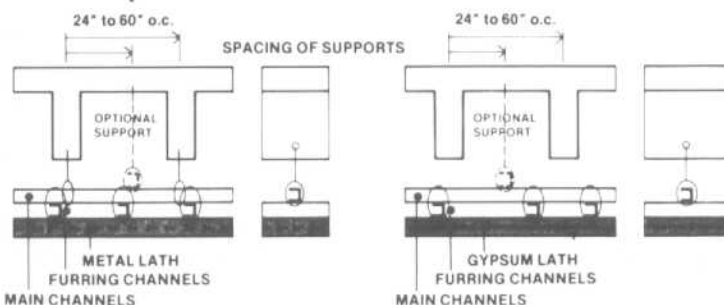
PLASTER, SUSPENDED

PRIMARY SUPPORTS ONLY



- suspended membrane with furring channels only is similar to furred membrane except that furring channels are suspended from, rather than directly attached to, framing members.
- suspension of membrane may be a requirement in some fire resistance rated floor or roof/ceiling assemblies.
- spacing of hangers is quite close and limits the size and/or extent of mechanical/electrical service lines in plenum space.

PRIMARY AND SECONDARY SUPPORTS



- when spacing of framing is wide and/or the number of hangers must be reduced, a primary support system consisting of main carrying channels may be used; the furring channels are then a secondary system, secured to such primary supports.
- for wide hanger spacing, metal joists instead of carrying channels may be used.

CEILINGS

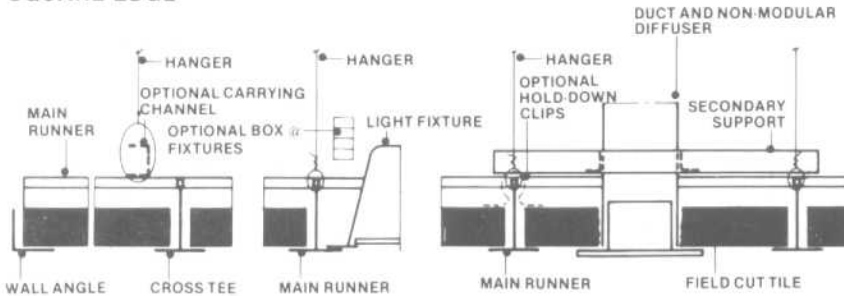
Exposed Grid Suspended Ceilings

ASSEMBLY

REMARKS

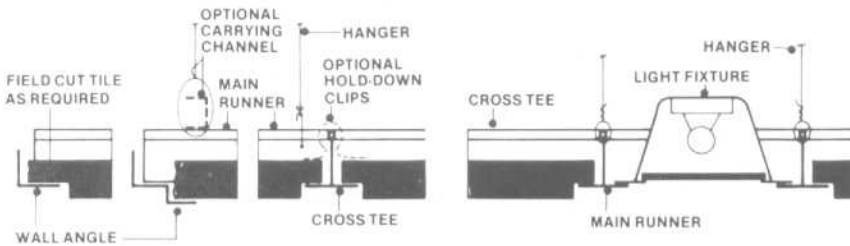
EXPOSED GRID: FLAT UNITS

SQUARE EDGE



- lay-in panels should be secured in place by clips when assembly requires a fire resistance rating; also against uplift due to pressure differential.
- fixtures generally have to be boxed-in for fire resistance rating; fire dampers must be provided at all openings, such as diffusers.
- hangers secured to framing members, structural deck, or to secondary framing system.

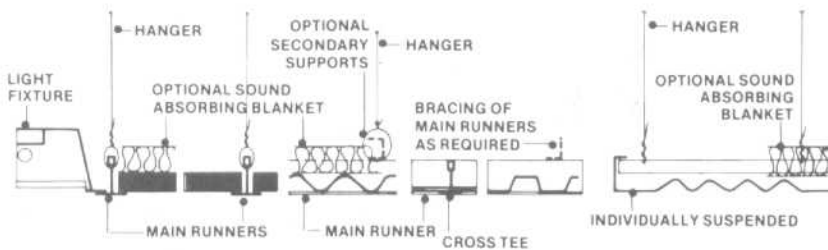
RECESSED EDGE



- clearance required for all lay-in panels for tilting them into place.
- suspension system used is the same as for square edge tile, but tile only available in 2x2 foot size.
- may be used in fire resistance-rated floor or roof/ceiling assemblies; clips to secure tiles in place and opening protection generally required.

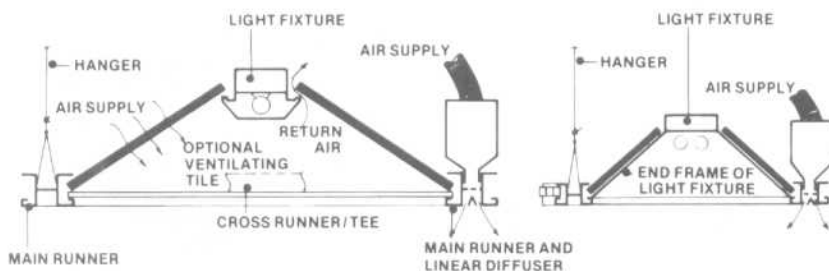
EXPOSED GRID, SHAPED UNITS

INLAY PANELS, CORRUGATED, RIBBED



- metal panels generally perforated, with sound absorbing blankets.
- plastic panels generally solid; used in luminous ceiling installations.
- corrugated/ribbed metal or plastic panels generally used with main runners only.
- flat plastic panels generally either 2x4 or 2x2 feet in size, used with main runners and cross tees.

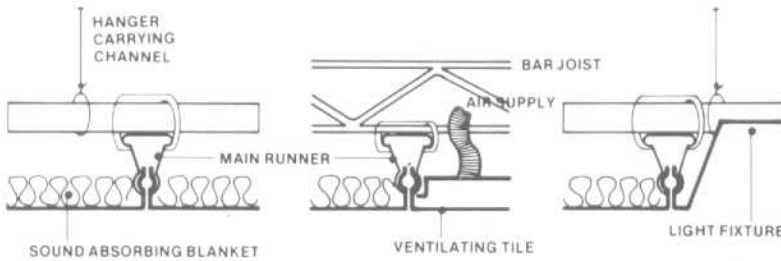
PRE-ASSEMBLED MODULES



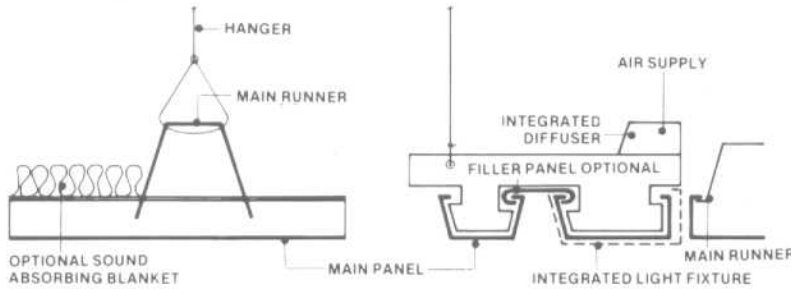
- flat pre-assembled modules are also available.
- when pressurized plenum and ventilating tile are used, air return must be ducted through plenum.
- with ventilating plenum, dirt streaking may result unless the membrane is made completely air tight.
- may be used in fire resistance-rated floor or roof/ceiling assemblies.

## ASSEMBLY

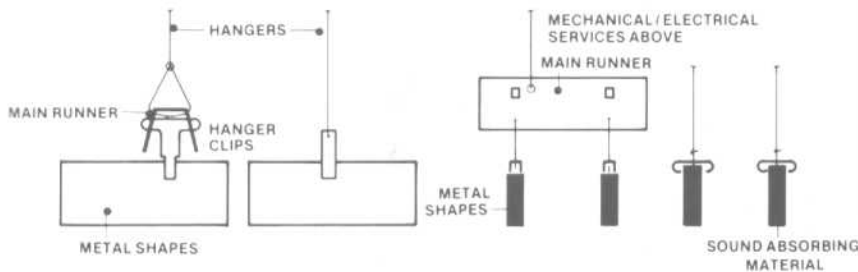
## REMARKS

**CONCEALED GRID, SHAPED UNITS****METAL PAN TILE**

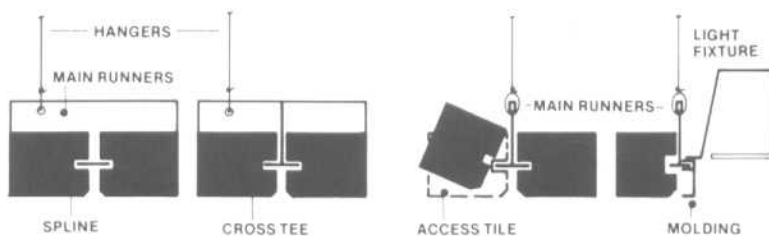
- tile may be repeatedly repainted without loss in sound absorbing characteristics.
- heating/cooling piping may be incorporated into the system.
- combination lighting/infra-red heating fixtures may be integrated into membrane.
- secondary suspension system generally required.
- tile may be used for supply/return air.

**LINEAR PANELS**

- formed prefinished metal panels in long lengths.
- air supply/return and lighting fixtures may be integrated into the system.
- may be used outdoors in protected locations, such as large soffits, canopies.
- some assemblies may be used as required components in fire resistance rated floor or roof/ceiling assemblies.
- membranes may be curved perpendicular to direction of panels.

**BAFFLES**

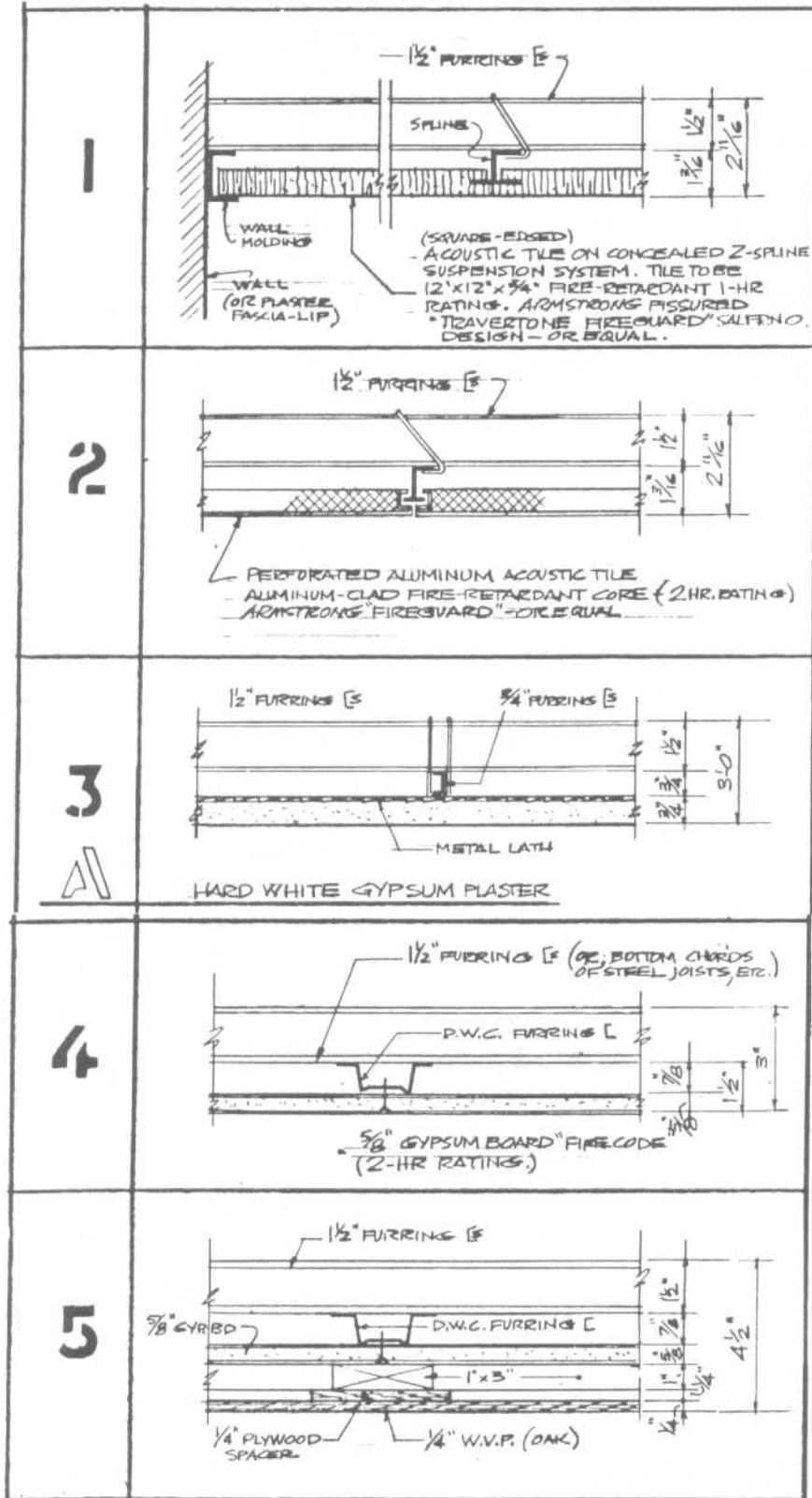
- baffles available in shaped metal, with or without sound absorbent material cores, or in faced sound absorbent material.
- various arrangements available, such as linear, radial, hexagonal.
- used to: provide additional sound absorption in selected locations; for visual interest, or to conceal mechanical/electrical services.

**CONCEALED GRID, FLAT UNITS****KERFED EDGE**

- tile, generally 12x12 inches in size with kerfed edges secured in place by main runners in one direction, and cross tees or splines in the other.
- secondary supports, such as carrying channels may be used to reduce spacing of hangers to framing system.
- may be used as component in fire resistance rated floor or roof/ceiling assemblies.
- special panels available to provide access to plenum.

CEILINGS

Suspended Ceiling Types



Concealed 2-spline system with acoustical tile

Concealed 2-spline system with aluminum-clad acoustical tile

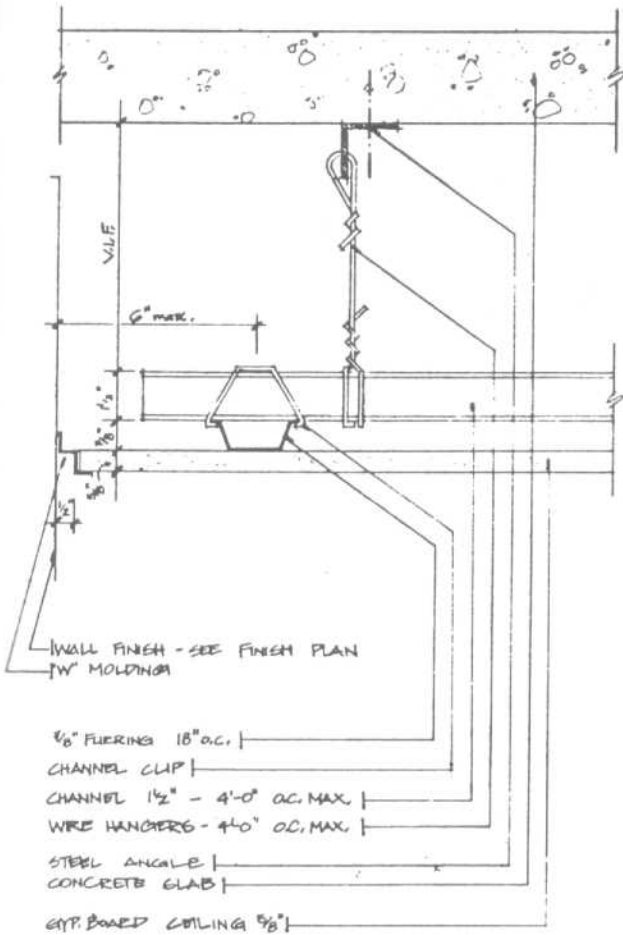
Suspended plaster ceiling

Suspended ceiling with gypsum board

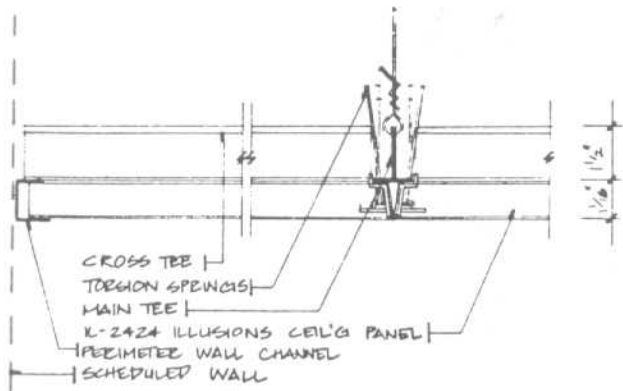
Suspended ceiling with plywood finish

CEILINGS

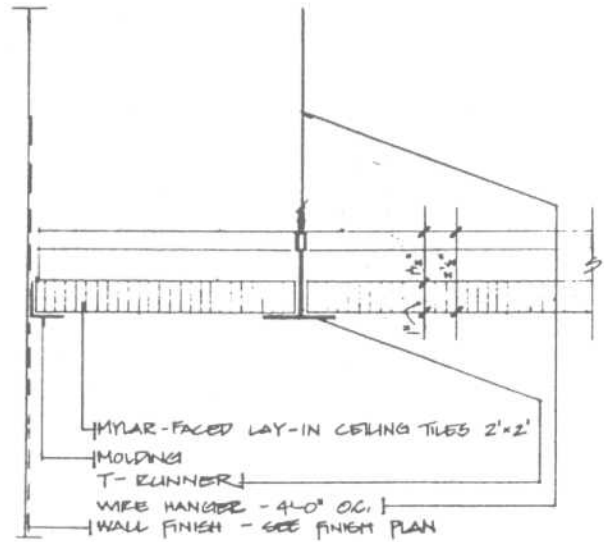
Suspended Ceiling Types



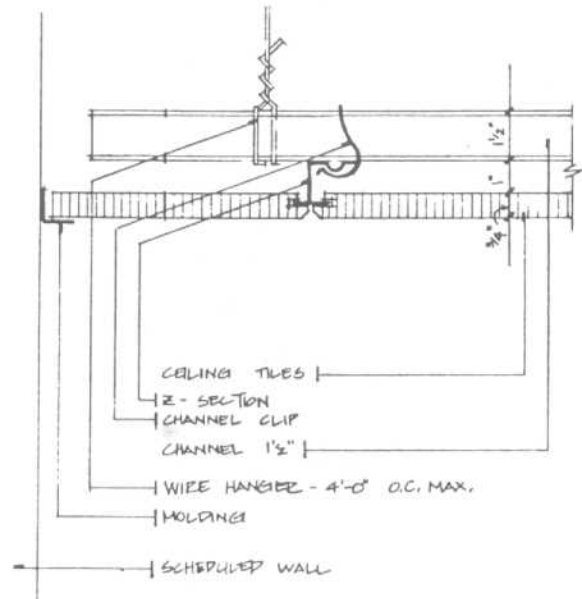
TYPICAL HUNG GYP. BOARD  
CEILING DETAIL



TYPICAL  
CEILING DETAIL



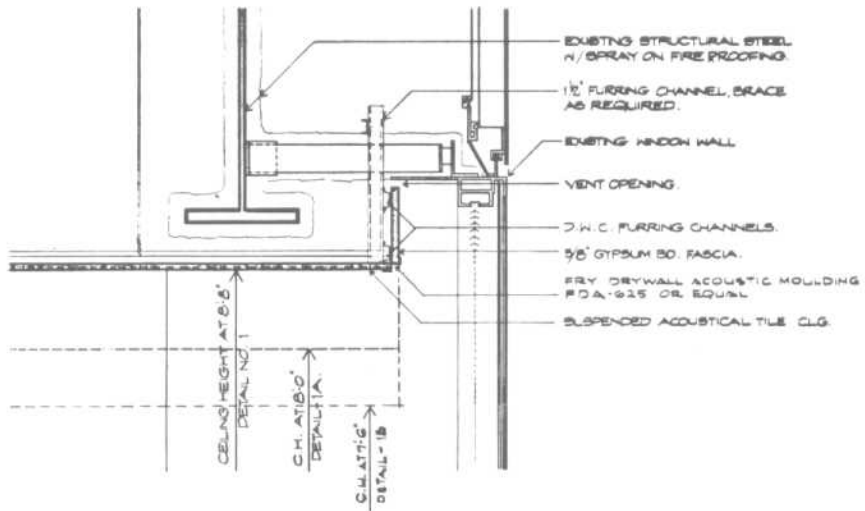
TYPICAL LAY-IN TILE  
CEILING DETAIL



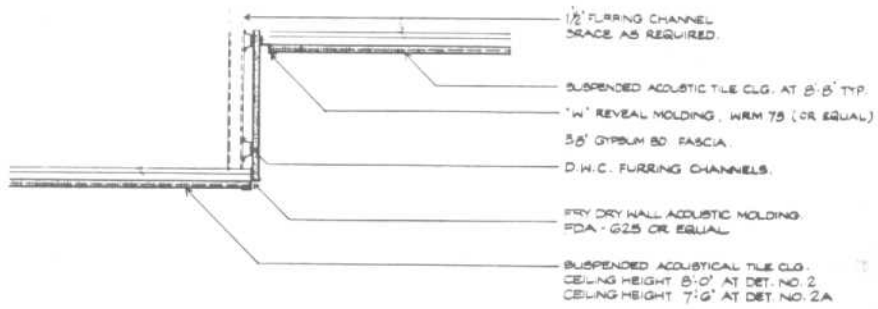
TYPICAL CONCEALED SPLINE  
CEILING DETAIL

CEILINGS

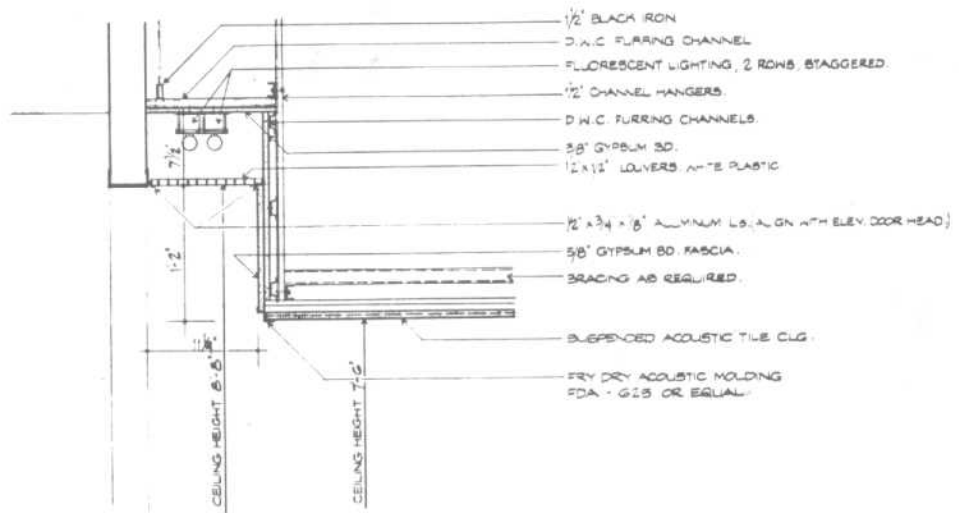
Suspended Ceiling Types



1



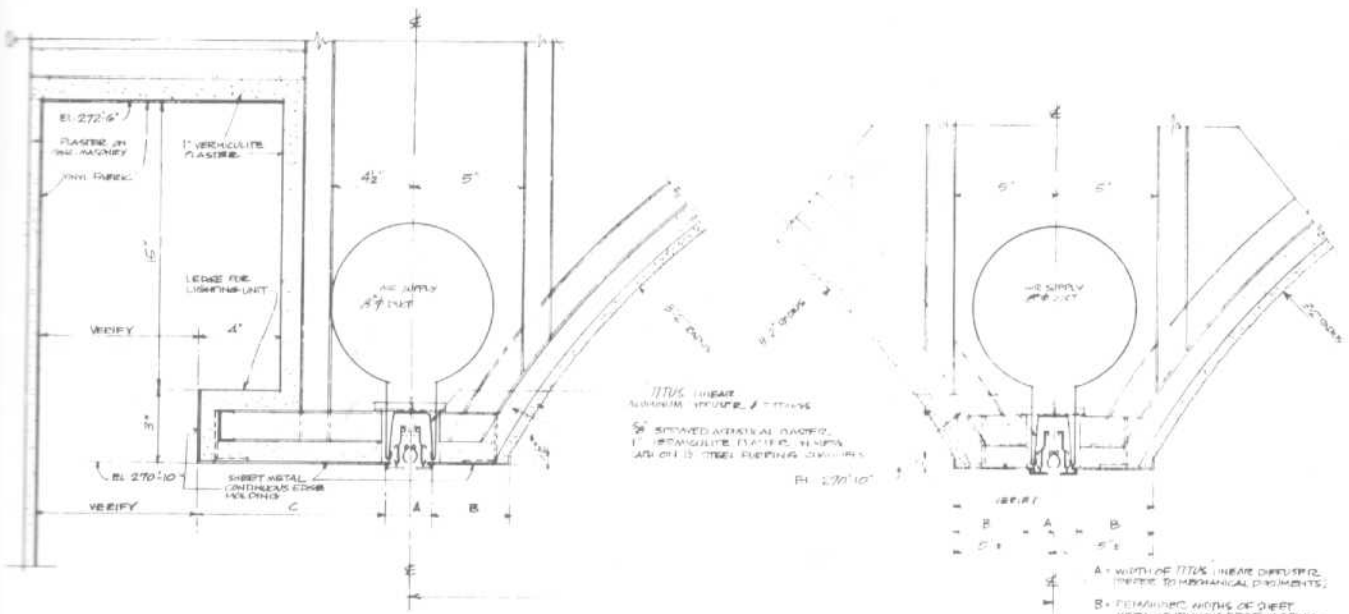
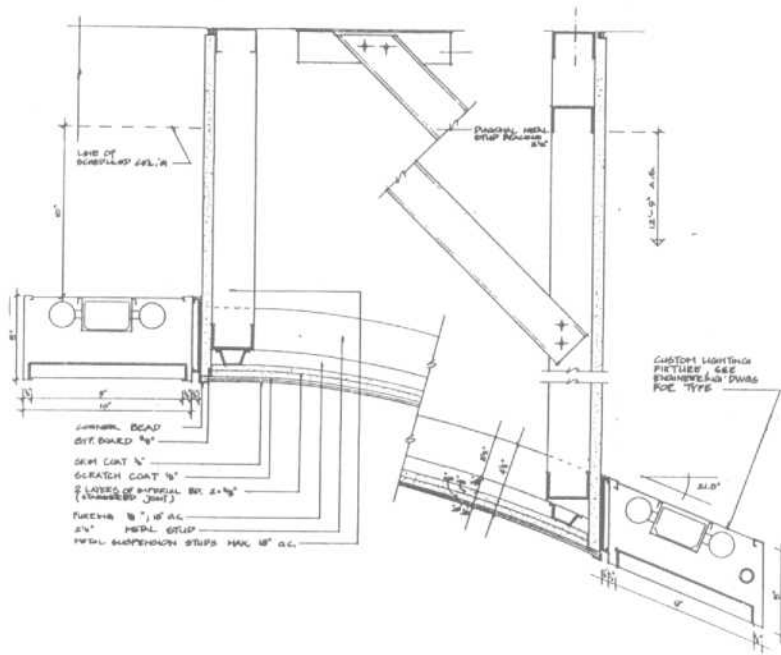
2



3

CEILINGS

Curved Ceiling with Recessed Lighting

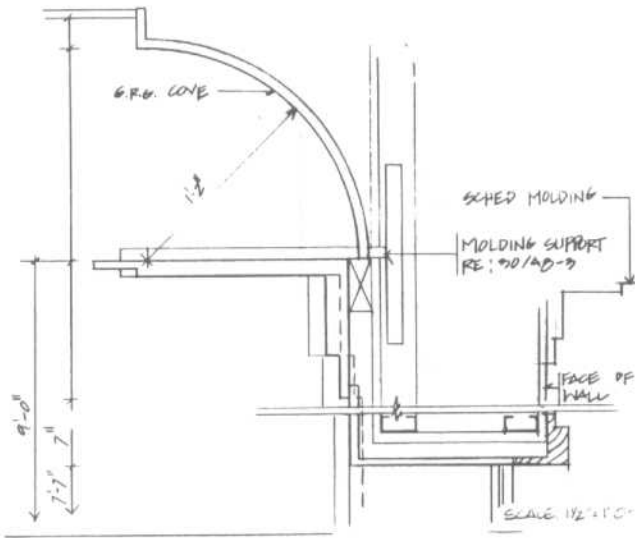


**4** LIGHT TROUGH & SPRINGLINE EDGE OF CHAPEL CEILING VAULT @ 8°-14°

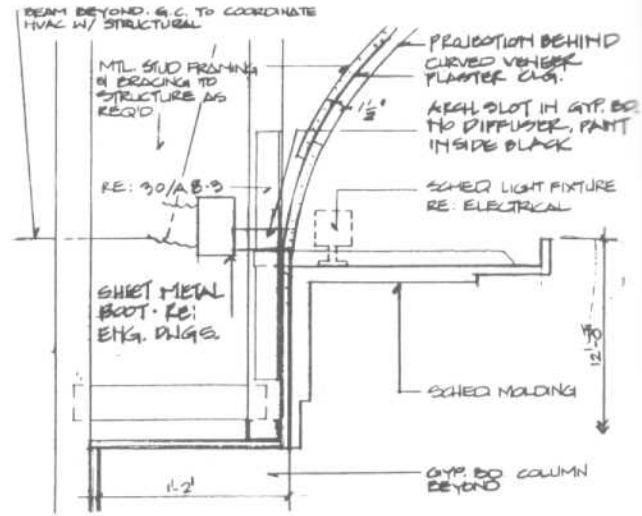
**5** TYPICAL SPRINGLINE EDGE OF CHAPEL CEILING VAULT @ 8°-14°

CEILINGS

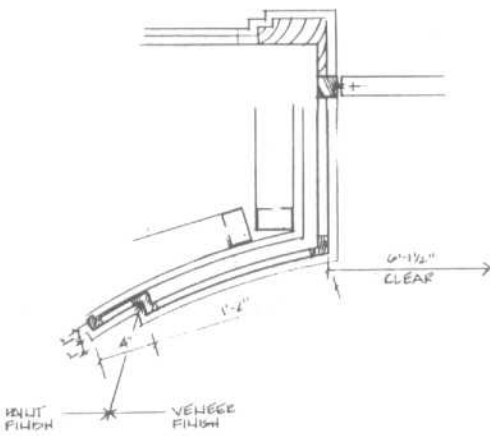
Vaulted Ceiling



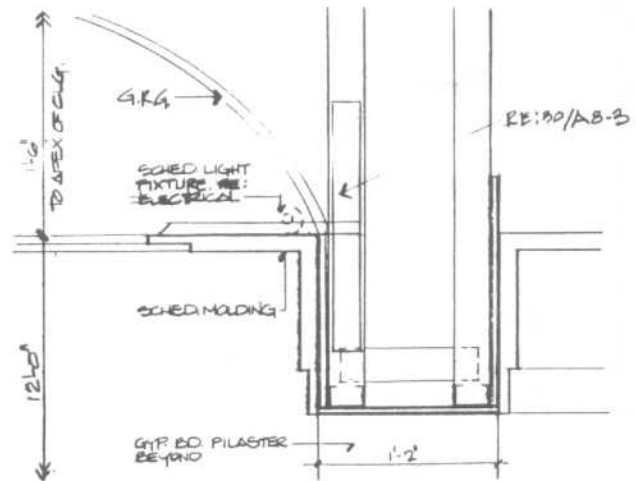
HEAD SECTION THROUGH PORTAL



VAULTED CEILING WITH MOULDING FRAMED COVE LIGHT

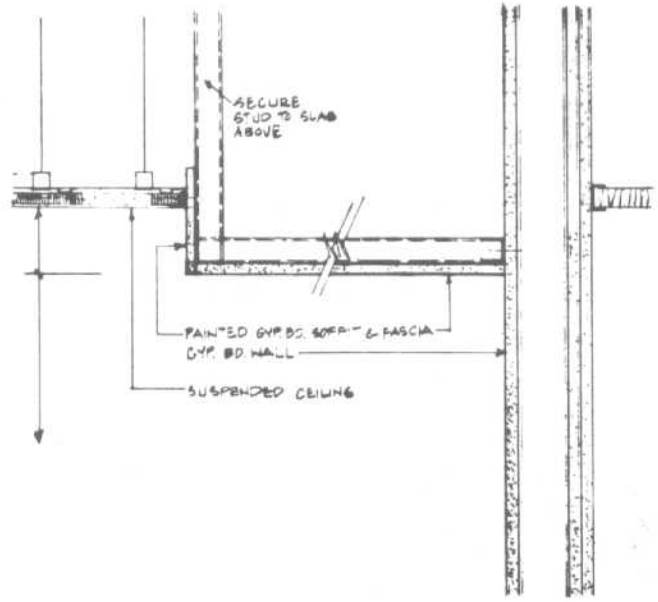
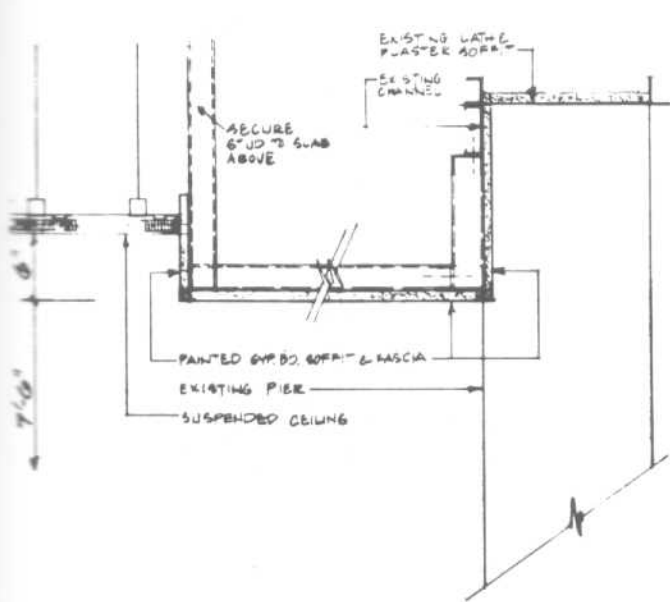


JAMB PORTAL



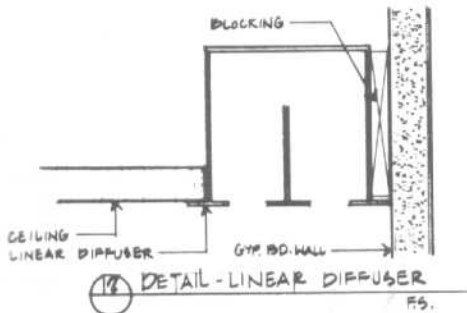
VAULTED CEILING WITH MOULDING FRAMED BEAM



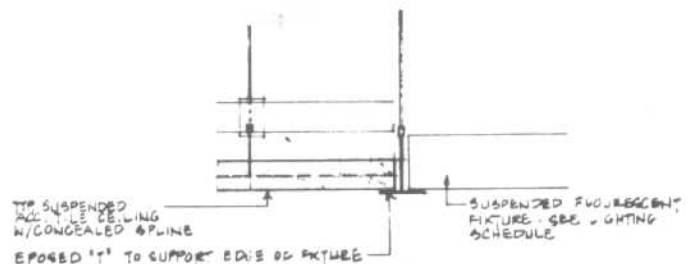


9 DETAIL - SOFFIT IN CAFETERIA AT WINDOW WALL  
1/2" = 1'-0"

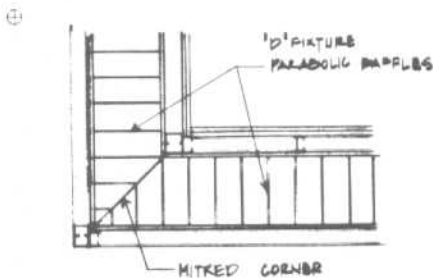
10 DETAIL - SOFFIT IN CAFETERIA  
1/2" = 1'-0"



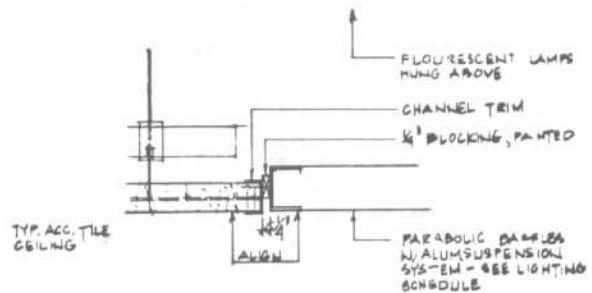
11 DETAIL - LINEAR DIFFUSER  
1/2" = 1'-0"



10 DETAIL - EDGE @ TYPE "E" FIXTURE  
1/2" = 1'-0"



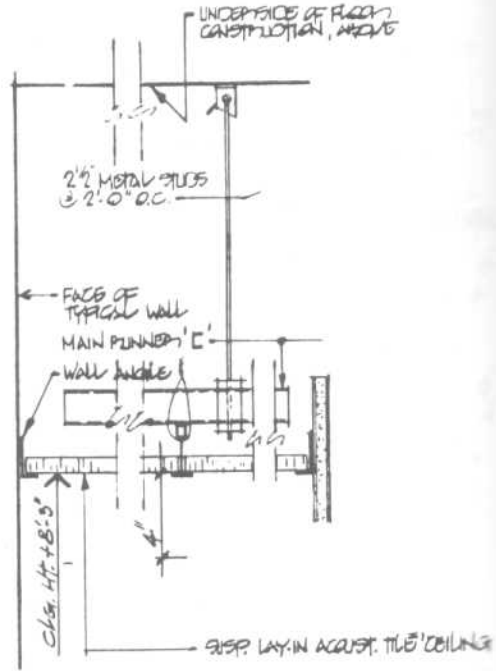
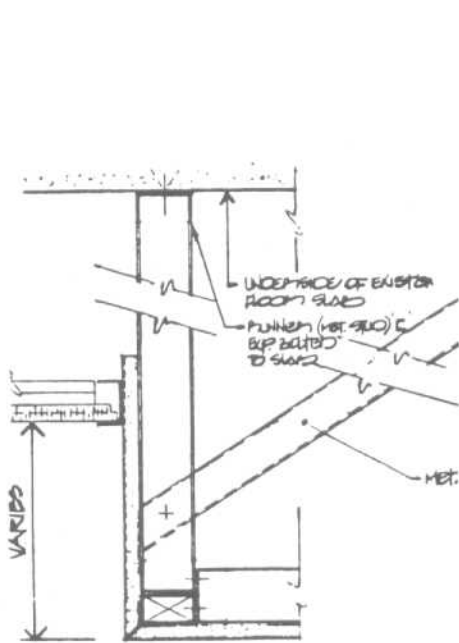
12 DETAIL - COVE AT MITRE CORNER  
1" = 1'-0"



11 DETAIL - EDGE @ TYPE "P" FIXTURE  
1/2" = 1'-0"

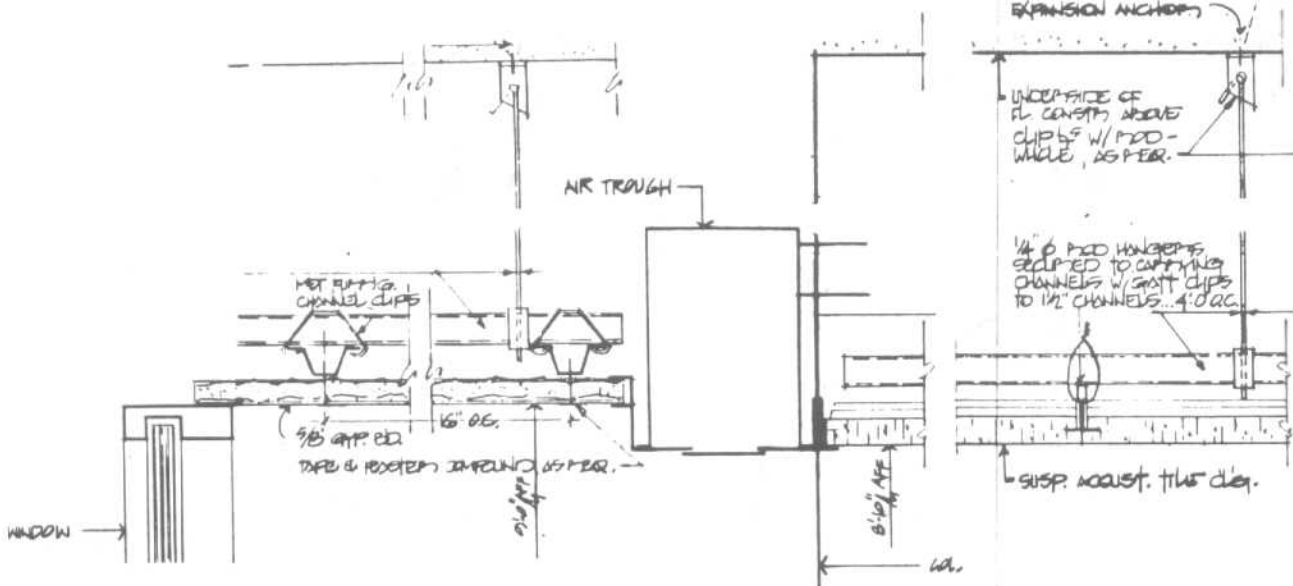
CEILINGS

Miscellaneous Details of Suspended Ceilings



SECTION THRU SUSP. CLG.

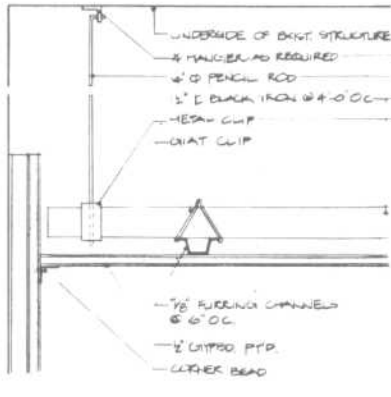
EXPOSED 'T' GRID (2'x2')



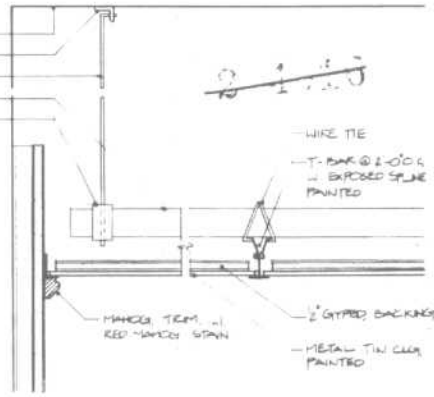
WINDOW HEAD - ALL FLOOR EXCEPT 2<sup>ND</sup> FL.

CEILINGS

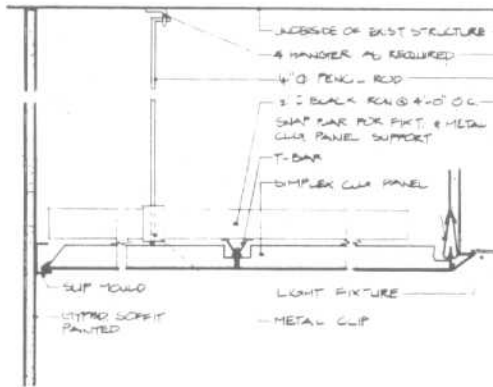
Miscellaneous Details of Suspended Ceilings



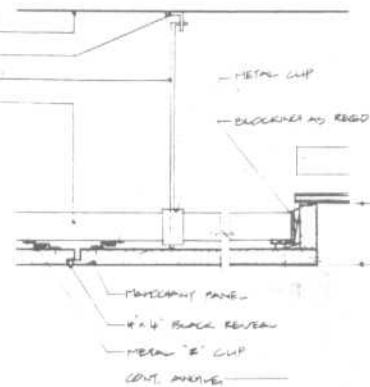
1 GYPSUM CEILING DETAIL  
SCALE: 3/4"=1'-0"



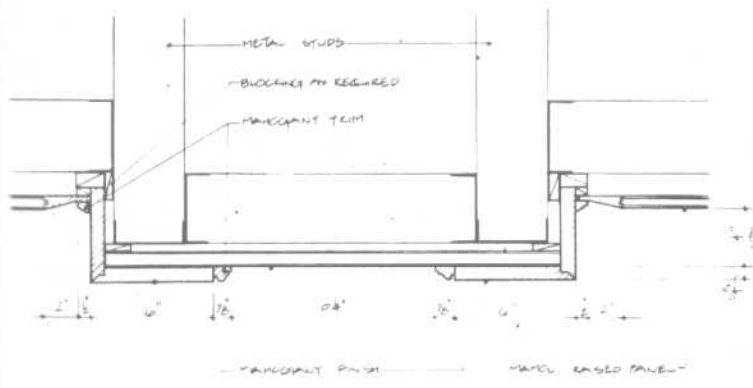
2 METAL TIN CEILING DETAIL  
SCALE: 3/4"=1'-0"



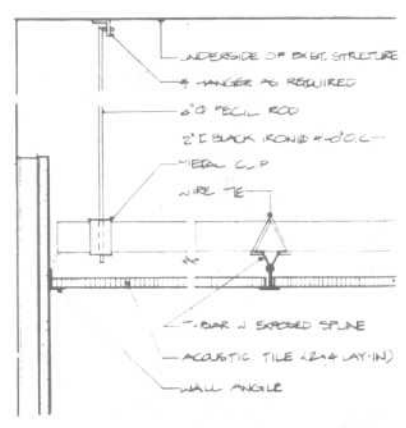
3 SIMPLEX METAL CEILING DETAIL  
SCALE: 3/4"=1'-0"



4 HANGER PANEL CEILING DETAIL  
SCALE: 3/4"=1'-0"



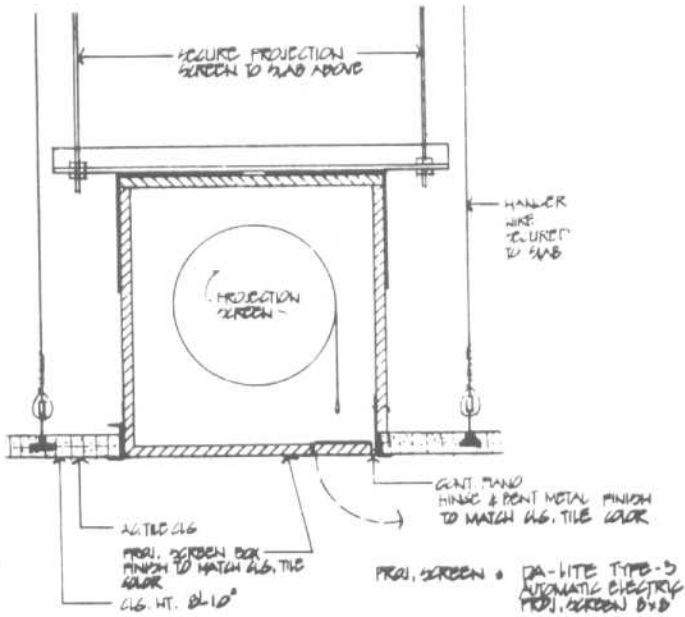
5 DETAIL OF RAISED HANGING PANEL CEILING  
SCALE: 3/4"=1'-0"



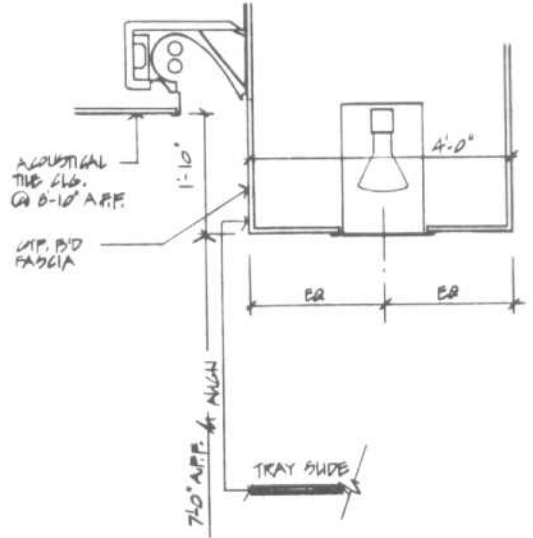
6 ACOUSTICAL TILE CEILING DETAIL  
SCALE: 3/4"=1'-0"

CEILING

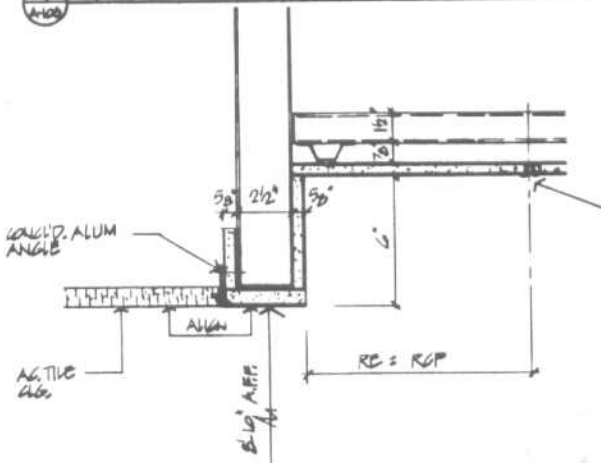
Suspended Ceilings: Perimeters and Drops



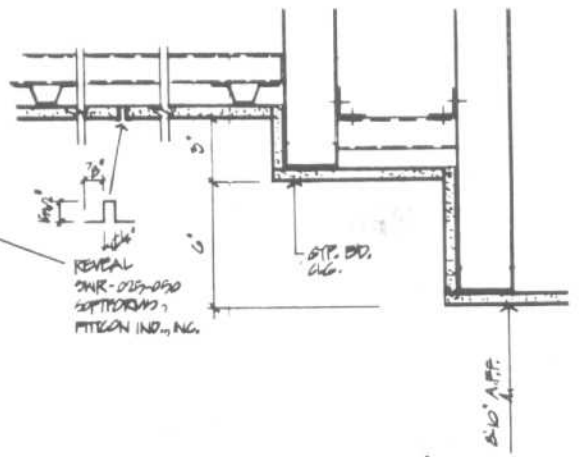
4  
A-103  
PROJECTION SCREEN



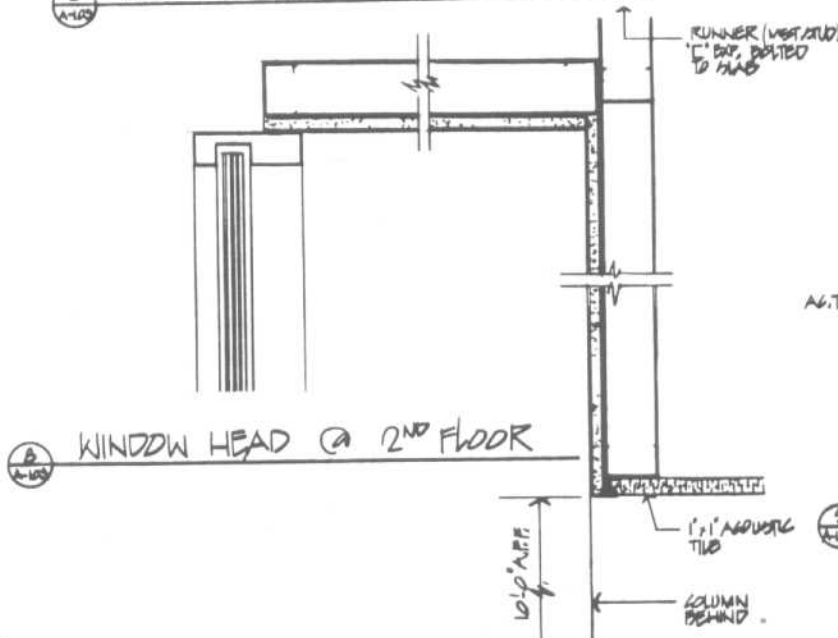
5  
A-104  
PERIMETER TROUGH SYSTEM  
A HERVEY (PTD-4)



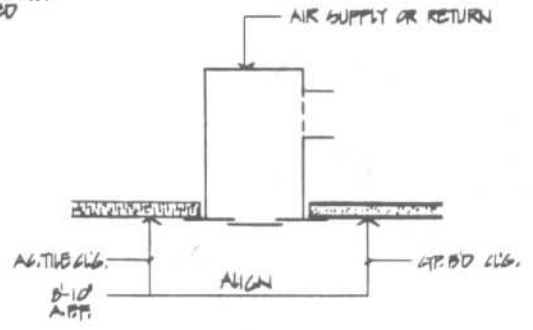
6  
A-105  
CONF. CNTR. CLG. - TIP.



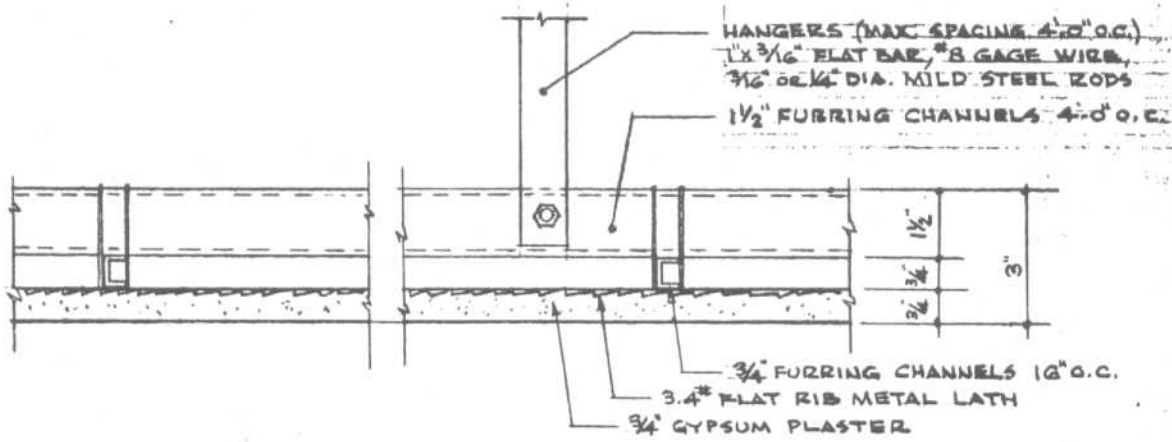
7  
A-106  
ELEVATOR LOBBY - SECT.  
REVEAL @ CLG.



8  
A-107  
WINDOW HEAD @ 2ND FLOOR

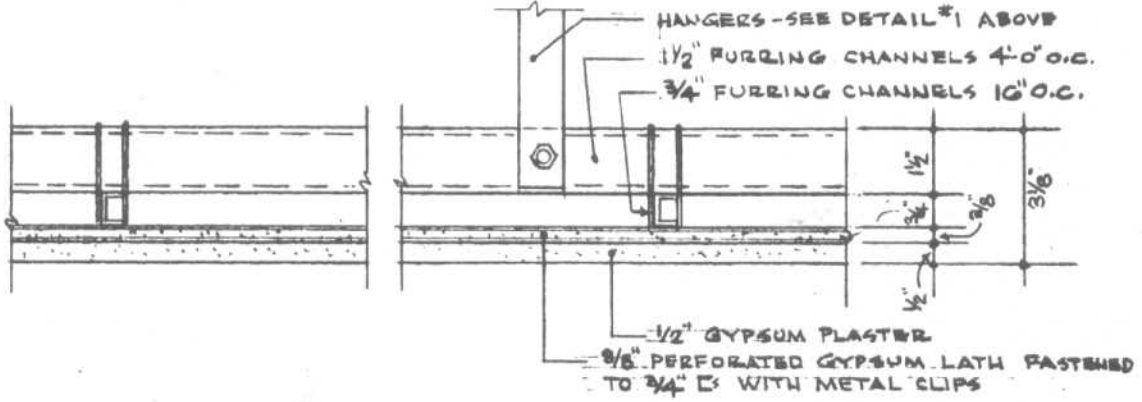


9  
A-108  
SECT. THRU TWO (2) DIFF. SUSP. CLG's



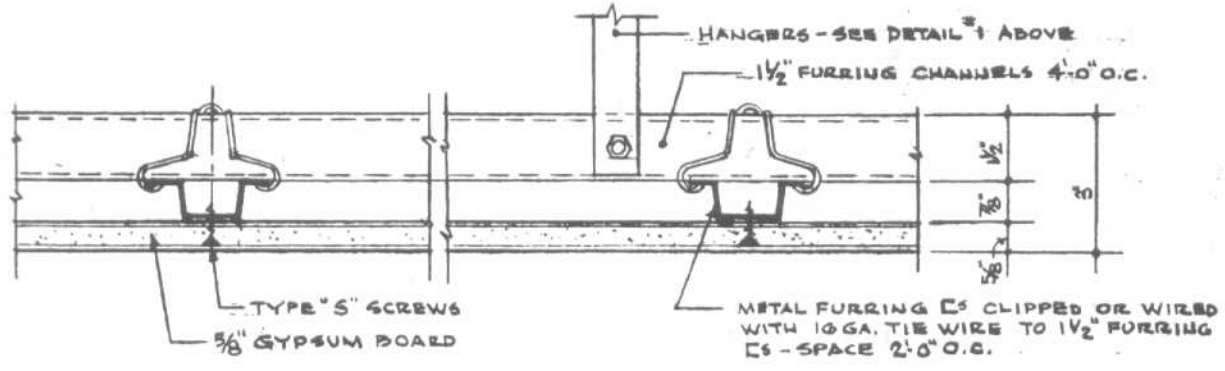
NOTE: WHERE FIRE RATING IS REQD. CHECK U.S. GYPSUM CATALOG FOR SPECIFICATIONS

1 PLASTER ON METAL LATH & STEEL FURRING



NOTE: WHERE FIRE RATING IS REQD. CHECK U.S. GYPSUM CATALOG & ADJUST THICKNESS & SPACING AS REQD.

2 PLASTER ON GYPSUM LATH & STEEL FURRING

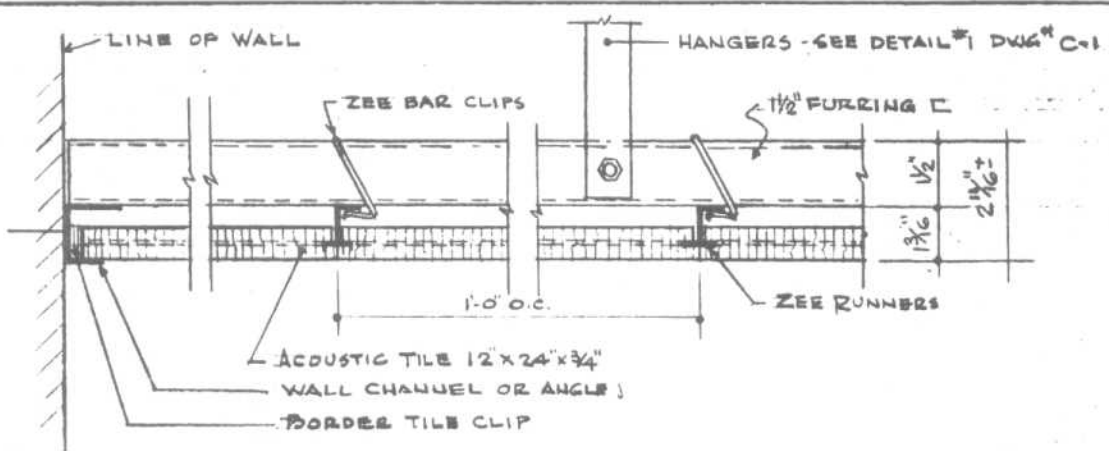


NOTE: CHECK BLDG. CODE & U.S. GYPSUM CATALOG FOR FIRE RATINGS

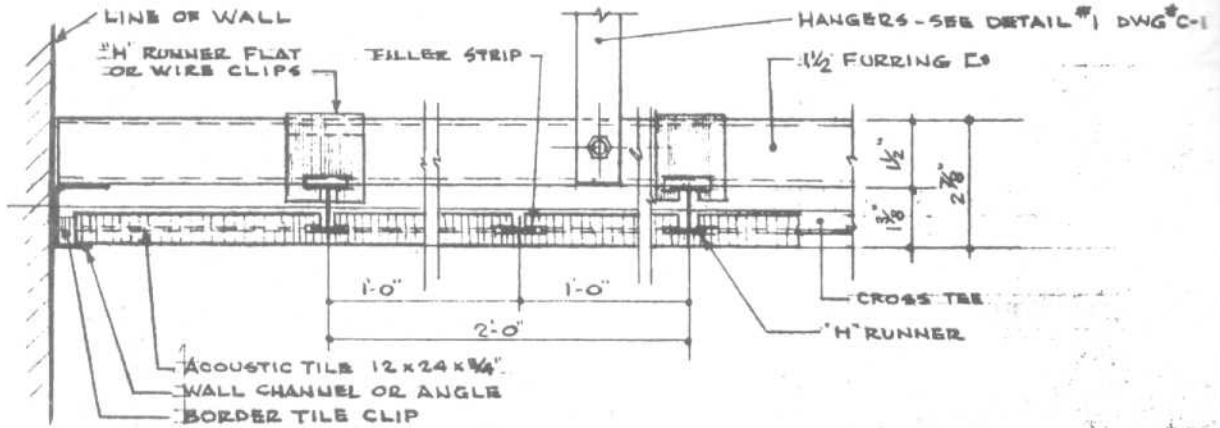
3 GYPSUM BOARD ON STEEL FURRING

CEILINGS

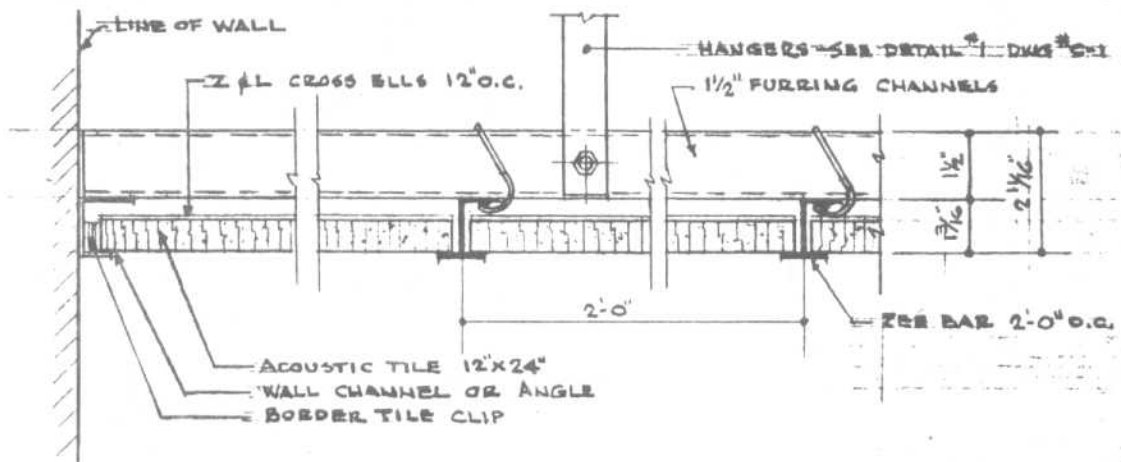
Suspended Ceilings



④ ACOUSTIC TILE CONCEALED ZEE SUSPENSION SYSTEM

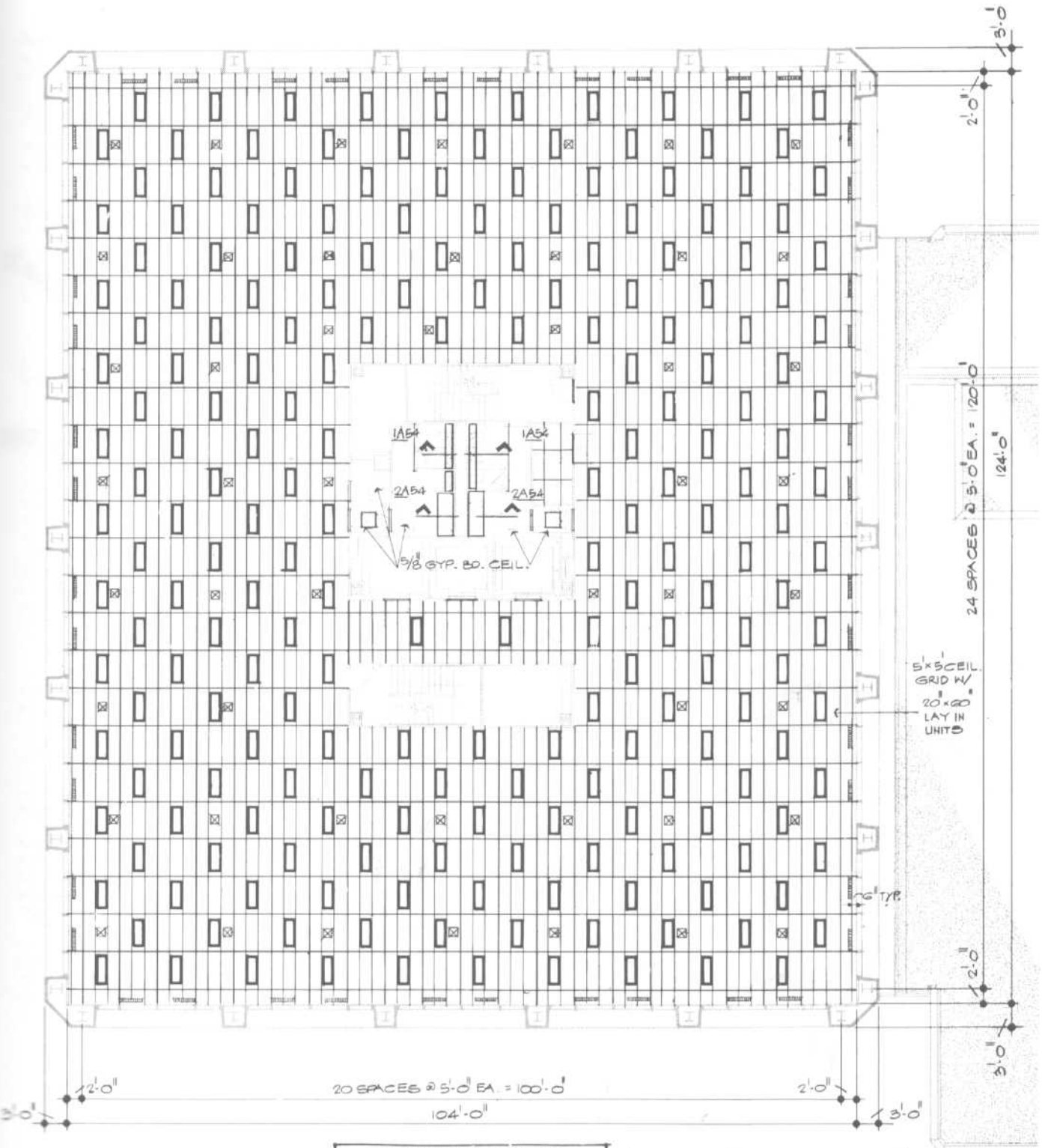


⑤ ACOUSTIC TILE H & T SUSPENSION SYSTEM



⑥ ACOUSTIC TILE Z & L SUSPENSION SYSTEM

**CEILING**  
Reflected Ceiling Plan



CEILING LEGEND	
SYMBOL	DESCRIPTION
	1'x4' RECESSED FLUORESCENT FIXTURE IN SUSPENDED METAL GRID WITH 1/2" CONCEALED SPLIT ACOUSTICAL PANELS
	20'x48" RECESSED FLUOR. FIXTURE IN 5'x5' SUSPENDED METAL GRID WITH 20'x48" ACOUST. LAY IN PANELS
	AIR CONDITIONING SUPPLY DIFFUSERS (SEE MECH.)

	AIR EXHAUST OR EXHAUST GRILLE OR RETURN AIR GRILLE (SEE MECH.)
	RECESSED FIXTURE OR SPINNER (SEE ELEC.)
	SURFACE MOUNTED OR SUSPENDED FLUOR. FIXTURE (SEE ELEC.)
	GYP. BO. OR PLASTER OR STUCCO
	1'x4' RECESSED FLUOR. FIXTURE W/ 5/8" MTL. GRID

STAIRS

Planning Data

Nowhere is the personal safety and comfort of the user more important than in the design of stairs. This section, therefore, provides the planning data necessary to solve most problems of stair design. Various stair types are illustrated, including straight run, long "L," wide "L," double "L," and narrow and wide "U." Stair tables and related diagrams are provided that indicate vertical and horizontal areas, headroom clearances, and tread and riser dimensions for various stair systems. Information concerning nosings, landing widths, etc., is also included. In addition to general planning data, this section includes barrier-free design data as well as actual construction details of wood, steel, and concrete stairs prepared by various design firms.

It should be noted that stair design must conform to local building codes. Most codes require that means-of-egress stairways not be less than 44 in (1118 mm) in width, that the least dimension of landings and platforms not be less than the required width of the stair, and that the minimum headroom in all parts of a stairway not be less than 6 ft 8 in (2032 mm) measured vertically from the tread nosing or from the floor surface of the

landing or platform. In one- and two-family dwellings, most codes require that stairways not be less than 3 ft (915 mm) clear in width, and that hand rails not be less than 30 in (762 mm) nor more than 34 in (864 mm) measured vertically from the nosing of the treads and be provided on at least one side of stairways of four or more risers.

CRITICAL DIMENSIONS AND CLEARANCES

Stair Table

Dimensions indicated in Fig. 1 and listed in Table 1 determine the vertical and horizontal areas and headroom clearances for stair systems with tread and riser proportions shown. They can be used directly in developing sketches or working drawings and eliminate the need for experimental stair plans or sections. All dimensions refer to face of treads without nosing.

Tabular data refer only to minimum conditions for straight run stairs. All figures may be adjusted according to requirements of design or stair use. For similar dimensional information controlling other types of stairways, see the following pages.

Widths of stairways may vary with local requirements. For passage of furniture, minimum clear widths should be selected from Table 2.

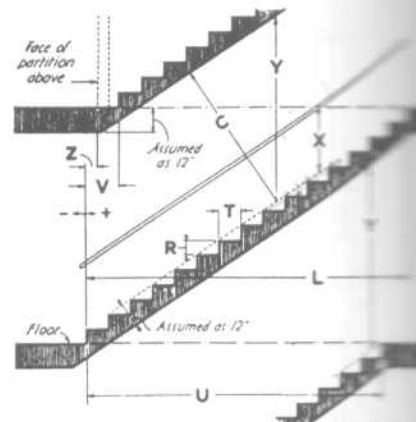


Fig. 1

TABLE 1 Stair Table

(Dimensions in feet and inches)

Floor to Floor Height	No. of Risers	Riser R	Tread T	Total Run L	Min. Headroom Y	Handrail X	Clearance C	Partition Above Z*	First Riser	
									Below - U	Above - V*
8'-0"	† 11	8.73*	8½*	6'-10½*	8'-2"	2'-10"	5'-8"	-1'-10"	8'-6"	-1'-7"
	† 12	8.00	9	8-3	7-10	2-9½	5-10½	-1-8½	9-7½	-1-4
	† 13	<b>7.38</b>	<b>10¼</b>	<b>10-3</b>	<b>7-7</b>	<b>2-9</b>	<b>6-2</b>	<b>-1-8½</b>	<b>11-6</b>	<b>-1-1½</b>
	† 14	<b>6.86</b>	<b>11½</b>	<b>12-8½</b>	<b>7-4</b>	<b>2-9</b>	<b>6-4</b>	<b>-1-7</b>	<b>13-8½</b>	<b>-9½</b>
	Δ 15	6.40	12½	14-7	7-3	2-9	6-7½	-1-6½	15-5½	-7½
Δ 16	6.00	13½	16-10½	7-3	2-9	6-7½	-1-9	17-6	-8	
8'-6"	† 12	8.50	8½	7-9½	8-1	2-9½	5-8½	-1-3½	8-10	-11
	† 13	7.85	9¼	9-3	7-9	2-9½	5-10½	-1-1	9-10	-7½
	† 14	<b>7.29</b>	<b>10½</b>	<b>11-4½</b>	<b>7-6</b>	<b>2-9</b>	<b>6-2</b>	<b>-10½</b>	<b>12-9</b>	<b>-4</b>
	† 15	<b>6.80</b>	<b>11½</b>	<b>13-8½</b>	<b>7-4</b>	<b>2-9</b>	<b>6-4</b>	<b>-10½</b>	<b>13-10</b>	<b>-1½</b>
	Δ 16	6.38	12½	15-7½	7-3	2-9	6-5½	-7	15-5½	+3½
Δ 17	6.00	13½	18-0	7-3	2-9	6-7	-7	17-8	+5	
9'-0"	† 12	9.00	8	7-4	8-3	2-10	5-6	-11	8-1	-8
	† 13	8.31	8½	8-6	8-0	2-9½	5-9	-9	8-11½	-5
	† 14	<b>7.71</b>	<b>9½</b>	<b>10-3½</b>	<b>7-9</b>	<b>2-9½</b>	<b>6-0</b>	<b>-8</b>	<b>10-8</b>	<b>-½</b>
	† 15	<b>7.20</b>	<b>10¼</b>	<b>12-3</b>	<b>7-6</b>	<b>2-9</b>	<b>6-2½</b>	<b>-3</b>	<b>11-10</b>	<b>+4½</b>
	† 16	<b>6.76</b>	<b>11¼</b>	<b>14-8¼</b>	<b>7-4</b>	<b>2-9</b>	<b>6-4</b>	<b>+2</b>	<b>13-11</b>	<b>+1-0</b>
Δ 17	6.35	12½	16-8	7-3	2-9	6-5½	+5	15-5½	+1-4	
Δ 18	6.00	13½	19-1½	7-3	2-9	6-7½	+6	17-8	+1-6	
9'-6"	† 13	8.77	8	8-0	8-2	2-10	5-5½	-3½	8-2	-½
	† 14	8.14	9	9-9	7-10	2-9½	5-9½	+0	9-5½	+5
	† 15	<b>7.60</b>	<b>9¼</b>	<b>11-4¼</b>	<b>7-7</b>	<b>2-9</b>	<b>6-4½</b>	<b>+4½</b>	<b>10-7</b>	<b>+10½</b>
	† 16	<b>7.13</b>	<b>10¼</b>	<b>13-8¼</b>	<b>7-5</b>	<b>2-9</b>	<b>6-2</b>	<b>+9½</b>	<b>12-2</b>	<b>+1-5½</b>
	† 17	<b>6.71</b>	<b>11¼</b>	<b>15-8</b>	<b>7-4</b>	<b>2-9</b>	<b>6-4</b>	<b>+1-1½</b>	<b>13-11½</b>	<b>+1-11</b>
Δ 18	6.33	12½	17-8½	7-3	2-9	6-5½	+1-5½	15-7	+2-4	
Δ 19	6.00	13½	20-3	7-3	2-9	6-8	+1-8	17-9	+2-7½	
10'-0"	† 14	8.57	8½	9-2½	8-1	2-9½	5-8½	+2	8-8	+6
	† 15	8.00	9	10-6	7-10	2-9½	5-10½	+6½	9-7	+11
	† 16	<b>7.50</b>	<b>10</b>	<b>12-6</b>	<b>7-7</b>	<b>2-9</b>	<b>6-1</b>	<b>+1-1</b>	<b>10-11½</b>	<b>+1-8½</b>
	† 17	<b>7.06</b>	<b>11</b>	<b>14-8</b>	<b>7-5</b>	<b>2-9</b>	<b>6-2½</b>	<b>+1-7½</b>	<b>12-8½</b>	<b>+2-2½</b>
	† 18	<b>6.67</b>	<b>12</b>	<b>17-0</b>	<b>7-4</b>	<b>2-9</b>	<b>6-5</b>	<b>+2-0</b>	<b>14-3½</b>	<b>+2-9</b>
Δ 19	6.32	12½	18-9	7-3	2-9	6-6	+2-5	15-8	+3-2½	
Δ 20	6.00	13½	21-4½	7-3	2-9	6-7½	+2-10	17-9	+3-8½	
10'-6"	† 14	9.00	8	8-8	8-3	2-10	5-5½	+6	8-0	+9
	† 15	8.40	8½	9-11	8-1	2-9½	5-8½	+9½	8-10	+1-1
	† 16	7.88	9¼	11-6¼	7-9	2-9½	5-10½	+1-3½	9-10	+1-8½
	† 17	<b>7.41</b>	<b>10</b>	<b>13-4</b>	<b>7-7</b>	<b>2-9</b>	<b>6-1</b>	<b>+1-9½</b>	<b>11-0</b>	<b>+2-3¼</b>
	† 18	<b>7.00</b>	<b>11</b>	<b>15-7</b>	<b>7-5</b>	<b>2-9</b>	<b>6-2½</b>	<b>+2-5</b>	<b>12-7½</b>	<b>+3-0½</b>
† 19	<b>6.63</b>	<b>12</b>	<b>18-0</b>	<b>7-4</b>	<b>2-9</b>	<b>6-4½</b>	<b>+2-11</b>	<b>14-4</b>	<b>+3-8½</b>	
Δ 20	6.30	12½	19-9½	7-3	2-9	6-6	+3-5½	15-7	+4-3½	
Δ 21	6.00	13½	22-6	7-3	2-9	6-7½	+4-0	17-9	+5-0	
11'-0"	† 15	8.80	8	9-4	8-2	2-10	5-6	+1-0½	8-1	+1-2½
	† 16	8.25	8½	10-11¼	8-0	2-9½	5-10	+1-5	9-2½	+1-9
	† 17	<b>7.76</b>	<b>9½</b>	<b>12-8</b>	<b>7-9</b>	<b>2-9½</b>	<b>6-0</b>	<b>+2-0</b>	<b>10-3½</b>	<b>+2-4½</b>
	† 18	<b>7.33</b>	<b>10¼</b>	<b>14-8¼</b>	<b>7-8</b>	<b>2-9</b>	<b>6-1¼</b>	<b>+2-7½</b>	<b>11-4½</b>	<b>+3-1½</b>
	† 19	<b>6.95</b>	<b>11</b>	<b>16-6</b>	<b>7-5</b>	<b>2-9</b>	<b>6-3</b>	<b>+3-3</b>	<b>12-8</b>	<b>+3-9</b>
† 20	<b>6.60</b>	<b>12</b>	<b>19-0</b>	<b>7-4</b>	<b>2-9</b>	<b>6-5</b>	<b>+3-10½</b>	<b>14-8½</b>	<b>+4-7½</b>	
Δ 21	6.29	12½	20-10	7-3	2-9	6-6	+4-5	15-8	+5-3	
Δ 22	6.00	13½	23-7½	7-3	2-9	6-7½	+5-1	17-8	+6-0	

\*Dimensions given plus or minus, i.e., behind or in front of first riser (see Fig. 1).

Notes: Figures in boldface indicate stairs recommended for most interiors.

† indicates stairs allowable only for attics and cellars but not recommended.

Δ indicates stairs for exterior or monumental use.



**Clearances for Furniture Passage**

Width is not always a critical factor of stairway design but is important when the layout involves one or more turns with straight runs. Typical layouts for such stairways include the Long L, Double L, Wide U, Wide L, and Narrow U. (See Fig. 3 for layouts and tabular data on these types.)

Stairways used solely as circulation from floor to floor can be 2'0" wide for comfortable passage of one individual or 3'6" for two, side-by-side. When furniture must be taken up and down, minimum clear widths of straight runs and landings must be carefully selected or corners will constitute obstructions in many instances.

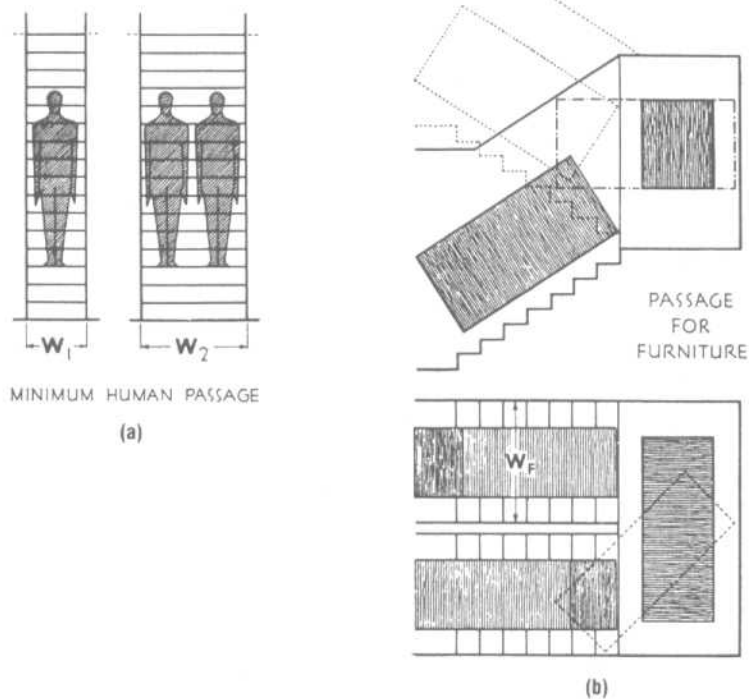
Recommended minimum clear widths as shown in Table 2 are not necessarily the width of stairs, either rough or wall-to-wall. Projections of newels, handrails, or baseboards can obstruct passage of furniture and must be taken into account when determining actual stair widths.

Headroom is also a controlling factor of design. With minimum headroom conditions shown in Table 1, clear widths for furniture passage must be greater in most cases than may be necessary if headroom is unlimited or equal at least to the ceiling heights. This is particularly important at the first riser and at turns, where the under rake of the first stair limits the vertical clearance of the stairway below. Therefore, if stairs must be comparatively narrow and if furniture must be transported over them, headroom, or vertical clearance, must be increased accordingly.

Landing widths may be increased to provide greater turning space for maneuvering furniture. If this is done, minimum clear widths can be proportionately decreased. However, this expedient is not effective unless hallways at either end of the stairway are at least equal to the landing widths. Narrow hallways often offer as great an obstruction to furniture maneuvering as low headroom, narrow runs, or cramped turns.

Open-well stairways give more opportunity to maneuver furniture, since even very bulky but light pieces may often be lifted over rails or newels. In general, a closed-string stair should be wider than an open-string type for the same degree of convenience.

The data in Table 2 reflect safe average clearances for transportation of items listed. Dimensions of furniture are subject to wide variations. Consequently, the minimum clear widths recommended here are susceptible to adjustment in certain instances.



**Fig. 2 Minimum stair widths. (a) Stairs designed for comfortable human passage only may be relatively narrow.  $W_1$  may be 2'0" but 2'6" is better.  $W_2$  should be at least 3'6". (b) Furniture passage demands greater width. If stair landing is increased or headroom unlimited,  $W_f$  may be decreased. See Table 2.**

**TABLE 2 Recommended Minimum Clear Widths of Stairs ( $W_f$ ) for Furniture Movement\***

Furniture		Min. Headroom <sup>▲</sup>		Unlimited Headroom		
Article	Size	Wide U Type	Narrow U Type	Wide and Narrow U	Narrow U only <sup>●</sup>	
					Stair	Landing
Double Bed Box Spring	4-6" x 6-6" x 8"	3'-2"	3'-2"	2'-3"		
Dressing Table	1-10" x 4-0" x 2-6"	2'-5"	2'-5"	2'-5"		
Bureau	2-0" x 4-0" x 3-0"	2'-8"	2'-8"	2'-8"		
Chiffonier	1-8" x 3-4" x 4-8"	2'-6"	2'-6"	2'-6"		
Chest of Drawers	1-9" x 3-4" x 4-8"	2'-7"	2'-7"	2'-7"		
Divan - Club	3-6" x 7-2" x 2-9"	4'-8"	4'-8"	3'-4"	3'-0"	3'-8"
Divan - Average	3-0" x 6-8" x 2-6"	4'-4"	4'-4"	2'-11"		
Piano - Concert Grand	9-0" x 5-4" x 1-8"	4'-8"	4'-8"	3'-2"	3'-0"	3'-4"
Piano - Music Room Grand	7-3" x 5-2" x 1-6"	3'-10"	3'-10"	3'-0"		
Piano - Drawing Room Grand	6-9" x 5-0" x 1-4"	3'-6"	3'-6"	2'-10"		
Piano - Baby Grand	5-8" x 4-10" x 1-2"	3'-0"	3'-0"	2'-8"		
Piano - Standard Upright	2-2" x 5-10" x 4-6"	4'-0"	3'-9"	3'-3"	3'-0"	3'-6"
Highboy - Large	2-0" x 3-6" x 7-6"	4'-4"	4'-4"	2'-10"		
Highboy - Average	1-8" x 3-4" x 6-0"	3'-6"	3'-6"	2'-6"		
Secretary - Large	1-10" x 3-8" x 7-2"	4'-0"	4'-0"	2'-10"		
Secretary - Average	1-10" x 3-0" x 6-10"	3'-10"	3'-10"	2'-6"		
Sideboard	1-9" x 5-0" x 3-2"	2'-6"	2'-6"	2'-6"		
Buffet	2-1" x 3-3" x 6-6"	4'-0"	4'-0"	2'-10"		
Dresser	1-9" x 6-0" x 5-6"	4'-4"	3'-6"	3'-4"	3'-0"	3'-8"
Table (6 People)	3-6" x 5-0" x 2-6"	3'-2"	3'-2"	3'-2"	3'-0"	3'-4"
Table (8 People)	3-6" x 7-0" x 2-6"	4'-8"	4'-4"	3'-2"	3'-0"	3-4
Table (10 People) Rd.	6-4" Diam.	4'-8"	4'-8"	3'-0"		
Desk - Slope Top	2-6" x 3-8" x 3-4"	3'-3"	3'-2"	3'-2"	3'-0"	3'-4"
Desk - Flat Top	3-0" x 5-6" x 2-6"	3'-2"	3'-0"	3'-0"		
Desk - Executive's	3-2" x 6-0" x 2-6"	4'-2"	4'-2"	3'-1"	3'-0"	3'-2"
Trunk - Wardrobe	1-11" x 2-6" x 3-7"	2'-5"	2'-5"	2'-5"		

\*Clear width between faces of rails, newels, etc., or between rail or newel and finish wall.

Notes: <sup>▲</sup> Headroom limited to minimum for comfortable human passage (see Table 1 and text).

<sup>●</sup> Narrow stairs and wide landings.

■ Absolute minimum not recommended (see text).

STAIRS

Planning Data

Purpose

The six diagrams in Fig. 3 represent unit plans for types of nonwinder stairways which are most frequently encountered in the average residential planning problem. Tabular information with each was developed from data contained in Table 1.

Unit plans are drawn to 1/8" scale and therefore can be supplied directly as a check of stair layouts to sketch plans and elevations. Each represents an average condition with a stair pitch well within the comfort zone. The basis is a 9'6" floor-to-floor height with 16 risers each 7.13" in height. Width is 3'0" from wall to wall.

Tabular data with each unit plan indicate dimensional variations which occur when stairways of substantially similar pitches are planned for floor-to-floor heights from 8 to 11 ft.

Width is the only critical dimension missing from this unit plan information. This varies with requirements of design and stair use and should be selected from data in Table 2. Width is a dimension controlling critical clearances on all stairs that contain a turn.

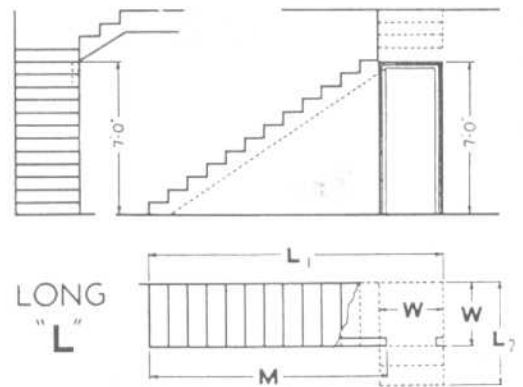
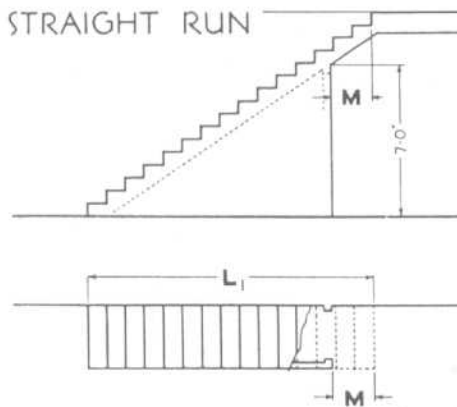
Winders have not been included in these unit plans because they represent a stair condition generally regarded as undesirable. However, use of winders is sometimes necessary due to cramped space. In such instances, winders should be adjusted to replace landings so that the narrow portions of treads at the inside of the turn are at least equal to 3/4" T. When this is done, dimensions of L<sub>1</sub> and L<sub>2</sub> are decreased by approximately 1/2T, the exact figure depending upon the width selected. The practice of adding a winder-riser to bisect the landing diagonally from the corner of a newel is to be avoided in

all cases for it produces a dangerously narrow step in a particularly undesirable place.

Application of Unit Plans

Diagrammatic data can be used on sketches as a graphic check as noted. Tabular data can be applied to either sketches or working drawings to eliminate the necessity of developing experimental stairway sections to determine run, proportional rise, horizontal and vertical areas, and location of under-rail minimum headroom.

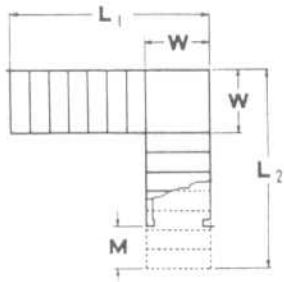
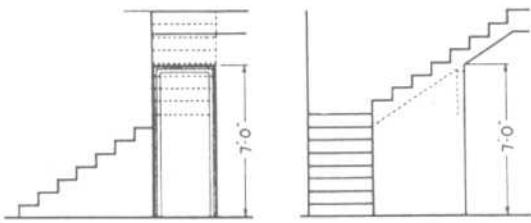
Dimensional data have been confined to a single pitch for all floor-to-floor heights. The pitch indicated is that most generally desirable for human comfort. Data for other pitches listed as tread and riser proportions in Table 1 can be substituted for values of L<sub>1</sub>, L<sub>2</sub>, and M.



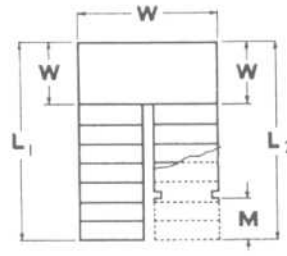
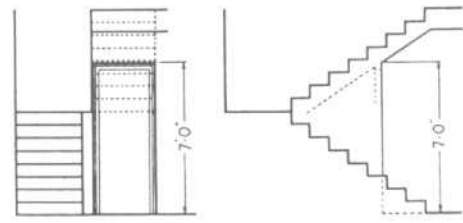
HEIGHT FLOOR TO FLOOR	NO OF RISERS	RISER	TREAD	L <sub>1</sub>	M
8'-0"	13	7.38	10 1/4"	10'-3"	—
8'-6"	14	7.29	10 1/2"	11'-4 1/2"	4 1/2"
9'-0"	15	7.20	10 3/4"	12'-3"	1'-1 1/2"
9'-6"	16	7.13	10 3/4"	13'-5 1/4"	1'-11 1/4"
10'-0"	17	7.06	11"	14'-8"	2'-9 1/2"
10'-6"	18	7.00	11"	15'-7"	3'-7"
11'-0"	19	6.95	11"	16'-6"	4'-5"

HEIGHT FLOOR TO FLOOR	NO RISERS	RISER	TREAD	NO RISERS	L <sub>1</sub>	NO RISERS	L <sub>2</sub>	M
8'-0"	13	7.38	10 1/4"	13	10'-3" + W	0	W	10'-3"
8'-6"	14	7.29	10 1/2"	13	10'-6" + W	1	W	10'-6"
9'-0"	15	7.20	10 3/4"	13	10'-6" + W	2	10 1/2" + W	10'-6"
9'-6"	16	7.13	10 3/4"	13	10'-9" + W	3	1'-9 1/2" + W	11'-0"
10'-0"	17	7.06	11"	13	11'-0" + W	4	2'-9" + W	11'-4"
10'-6"	18	7.00	11"	13	11'-0" + W	5	3'-8" + W	11'-5"
11'-0"	19	6.95	11"	13	11'-0" + W	6	4'-7" + W	11'-6"

Fig. 3



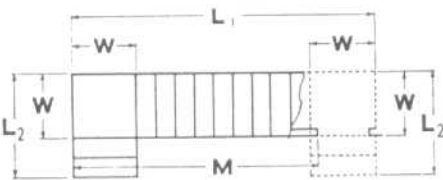
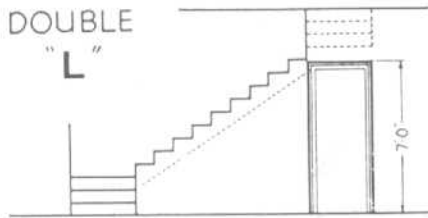
WIDE  
"L"



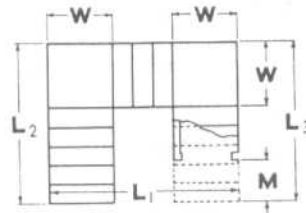
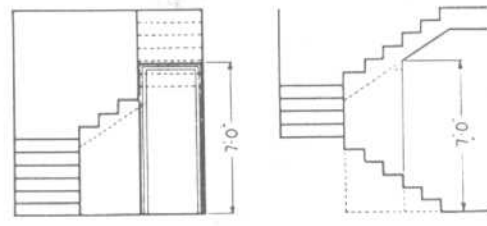
NARROW  
"U"

HEIGHT FLOOR TO FLOOR	N° RISERS	RISER	TREAD	N° RISERS	L <sub>1</sub>	N° RISERS	L <sub>2</sub>	M
8'-0"	13	7.38	10 1/4"	7	5'-1 1/2" + W	6	4'-3 3/4" + W	-
8'-6"	14	7.29	10 1/2"	7	5'-3" + W	7	5'-3" + W	4 1/2"
9'-0"	15	7.20	10 3/4"	8	6'-1 1/2" + W	7	5'-3" + W	1'-1 1/2"
9'-6"	16	7.13	10 3/4"	8	6'-3 3/4" + W	8	6'-3 3/4" + W	1'-11 1/4"
10'-0"	17	7.06	11"	9	7'-4" + W	8	6'-5" + W	2'-9 1/2"
10'-6"	18	7.00	11"	9	7'-4" + W	9	7'-4" + W	3'-7"
11'-0"	19	6.95	11"	10	8'-3" + W	9	7'-4" + W	4'-5"

HEIGHT FLOOR TO FLOOR	N° RISERS	RISER	TREAD	N° RISERS	L <sub>1</sub>	N° RISERS	L <sub>2</sub>	M
8'-0"	13	7.38	10 1/4"	7	5'-1 1/2" + W	6	4'-3 3/4" + W	-
8'-6"	14	7.29	10 1/2"	7	5'-3" + W	7	5'-3" + W	4 1/2"
9'-0"	15	7.20	10 3/4"	8	6'-1 1/2" + W	7	5'-3" + W	1'-1 1/2"
9'-6"	16	7.13	10 3/4"	8	6'-3 3/4" + W	8	6'-3 3/4" + W	1'-11 1/4"
10'-0"	17	7.06	11"	9	7'-4" + W	8	6'-5" + W	2'-9 1/2"
10'-6"	18	7.00	11"	9	7'-4" + W	9	7'-4" + W	3'-7"
11'-0"	19	6.95	11"	10	8'-3" + W	9	7'-4" + W	4'-5"



DOUBLE  
"L"



WIDE  
"U"

HEIGHT FLOOR TO FLOOR	N° RISERS	RISER	TREAD	N° RISERS	L <sub>1</sub>	N° RISERS	L <sub>2</sub>	M
8'-0"	13	7.38	10 1/4"	13	10'-3" + 2W	0	W	10'-3" + W
8'-6"	14	7.29	10 1/2"	12	9'-7 1/2" + 2W	1	W	9'-7 1/2" + W
9'-0"	15	7.20	10 3/4"	11	8'-9" + 2W	2	10 1/2" + W	8'-9" + W
9'-6"	16	7.13	10 3/4"	10	8'-0 1/4" + 2W	3	1'-9 1/2" + W	8'-3 3/4" + W
10'-0"	17	7.06	11"	9	7'-4" + 2W	4	2'-9" + W	7'-8" + W
10'-6"	18	7.00	11"	8	6'-5" + 2W	5	3'-8" + W	6'-10" + W
11'-0"	19	6.95	11"	7	5'-6" + 2W	6	4'-7" + W	6'-0" + W

HEIGHT FLOOR TO FLOOR	N° RISERS	RISER	TREAD	N° RISERS	L <sub>1</sub>	N° RISERS	L <sub>2</sub>	N° RISERS	L <sub>3</sub>	M
8'-0"	13	7.38	10 1/4"	4	2'-6 1/4" + 2W	4	2'-6 1/4" + W	5	3'-5" + W	-
8'-6"	14	7.29	10 1/2"	4	2'-7 1/2" + 2W	5	3'-6" + W	5	3'-6" + W	4 1/2"
9'-0"	15	7.20	10 3/4"	4	2'-7 1/2" + 2W	5	3'-6" + W	6	4'-4 1/2" + W	1'-1 1/2"
9'-6"	16	7.13	10 3/4"	4	2'-8 1/4" + 2W	6	4'-5 3/4" + W	6	4'-5 3/4" + W	1'-11 1/4"
10'-0"	17	7.06	11"	4	2'-9" + 2W	6	4'-7" + W	7	5'-6" + W	2'-9 1/2"
10'-6"	18	7.00	11"	4	2'-9" + 2W	7	5'-6" + W	7	5'-6" + W	3'-7"
11'-0"	19	6.95	11"	4	2'-9" + 2W	7	5'-6" + W	8	6'-5" + W	4'-5"

Fig. 3 (Continued)

**STAIRS**

Layouts and Dimensions

**Nosings**

Nosings extending ¾ to 1½ in (usually 1¼ in) beyond the face of the riser are functionally necessary and are required by most building codes. Nosings may be provided by extending the treads or by sloping the risers. The latter method is customary in concrete stairs because of easier forming, and in any type of stair where carpet is to be installed. This type of nosing is also recommended for stairs to be used by the handicapped.

**Stairway Layouts**

Comfortable stairways cannot be designed except in relation to dimensions of the average human figure. As applied to stairways these dimensions and the equivalent of the average comfortable walking stride of about 24 in fix the gradient of stairways, the proportional relation of treads and risers, the height of the handrail, and the minimum necessary headroom.

Figure 4 indicates the influence of human figure dimensions and suggests the desirability of varying ceiling clearances and handrail heights according to variations in stair gradients. These variations are included in Table 3.

Treads and risers in curved stairs should be proportioned on an assumed "line of travel" 18 in from the inner (smaller radius) handrail.

All building codes have strict specifications for stairs which are required exits. The National Building Code of the American Insurance Association and the New York City code both require that treads and risers be proportioned by the formula  $T \times R = 70$  to 75, with risers not over 7¾ in high and treads not less than 9 in wide, exclusive of nosings. Minimum stair width for most uses is 44 in, based on two 22-in lanes of traffic. Handrails are required on both sides and may project a maximum of 3½ in into the required width. Winders and open risers are prohibited. The maximum vertical rise permitted between landings is 12 ft; in places of assembly it is 8 ft. Stairs must be designed for a live load of 100 lb/ft<sup>2</sup>.

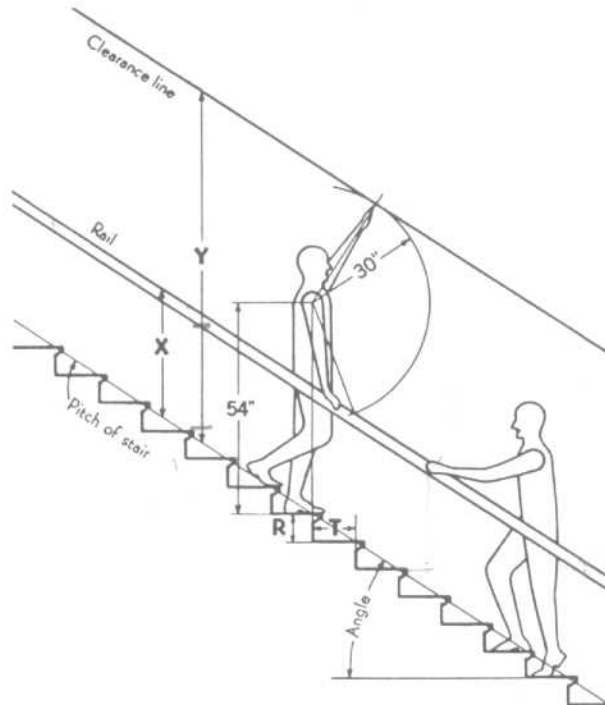
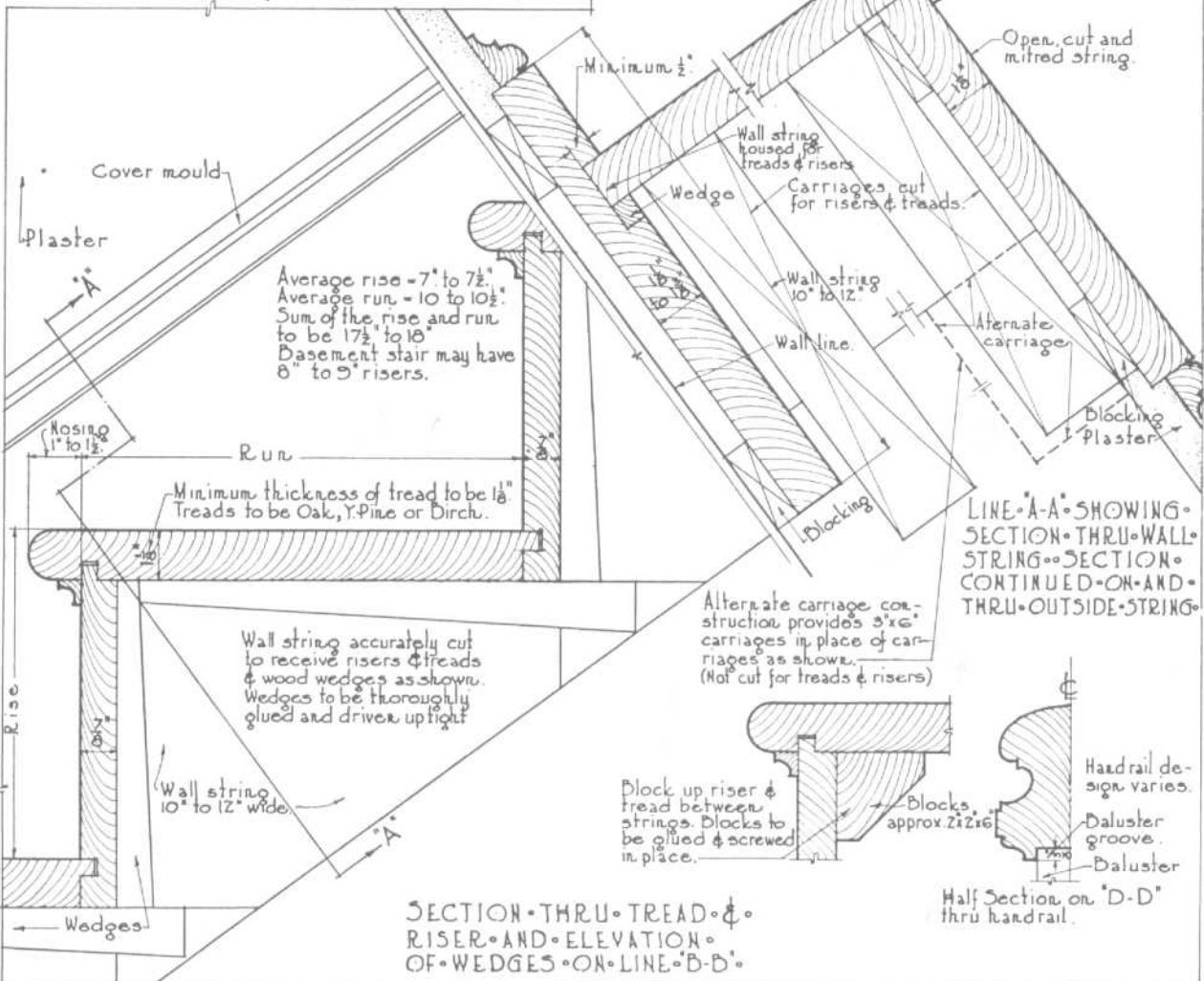
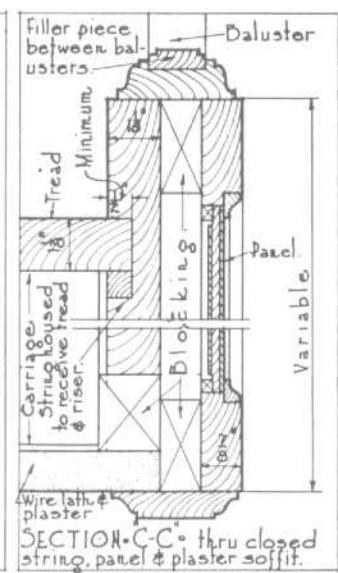
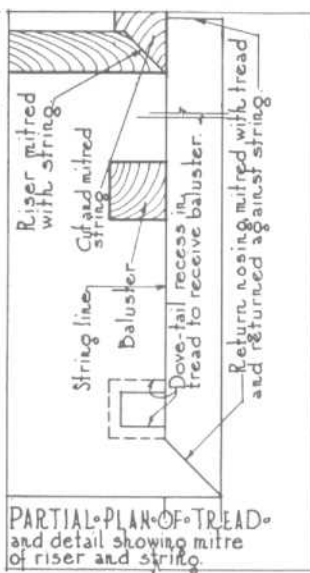
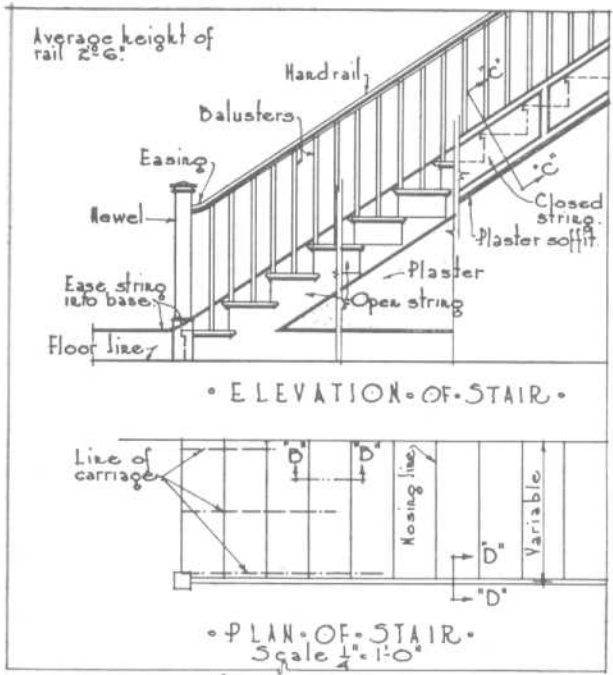


Fig. 4

**TABLE 3** Dimensions for Stairways

Step dimensions		Gradient designations		Headroom * Y in inches	Handrail height X in inches	NOTES
Riser R in inches	Tread T in inches	Per cent grade	Angle in degrees, minutes			
5	16	31.25	17 - 21	85	33½	1. 7" by 11" is the proportion by which all steps are laid out 2. Risers from 5" to 6½" are suitable for exterior and "grand" interior stairs 3. Risers from 6½" to 7¾" are most comfortable and most suitable for interior stairs 4. Risers for cellar and attic stairs may be up to 9" high 5. Width - minimum for single-file travel, 30" 6. Width - minimum for comfort, 36" 7. Width - desirable (for furniture passage etc.), 42" 8. Consult local building codes on all stair problems
5½	15½	33.87	18 - 43	86		
5½	14¾	37.28	20 - 27			
5½	14	41.07	22 - 20	87		
6	13½	44.44	23 - 58			
6¾	13	48.07	25 - 40	88		
6½	12¾	53.06	27 - 57			
6¾	11¾	57.44	29 - 52	89		
7	11	63.63	32 - 28			
7¾	10½	69.04	34 - 37	90		
7½	10	75	36 - 52			
7¾	9½	81.57	39 - 12	91		
8	9	88.88	41 - 38			
8¾	8½	97.05	44 - 9	92		
8½	8¾	103.02	45 - 51			
8¾	8½	107.07	46 - 57	93		
9	8	112.5	48 - 22			

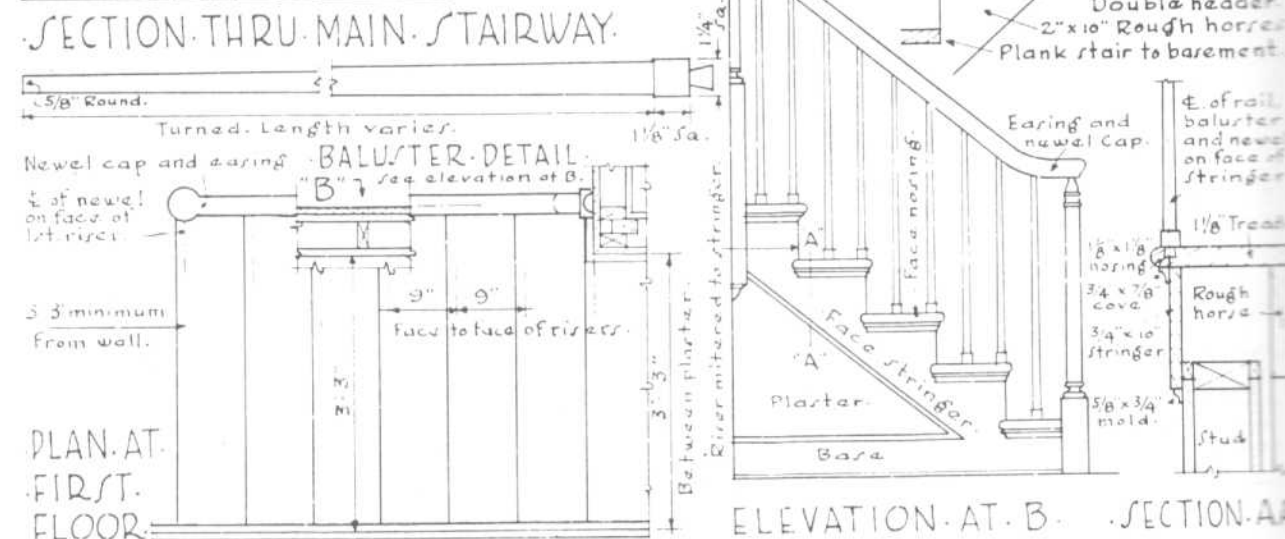
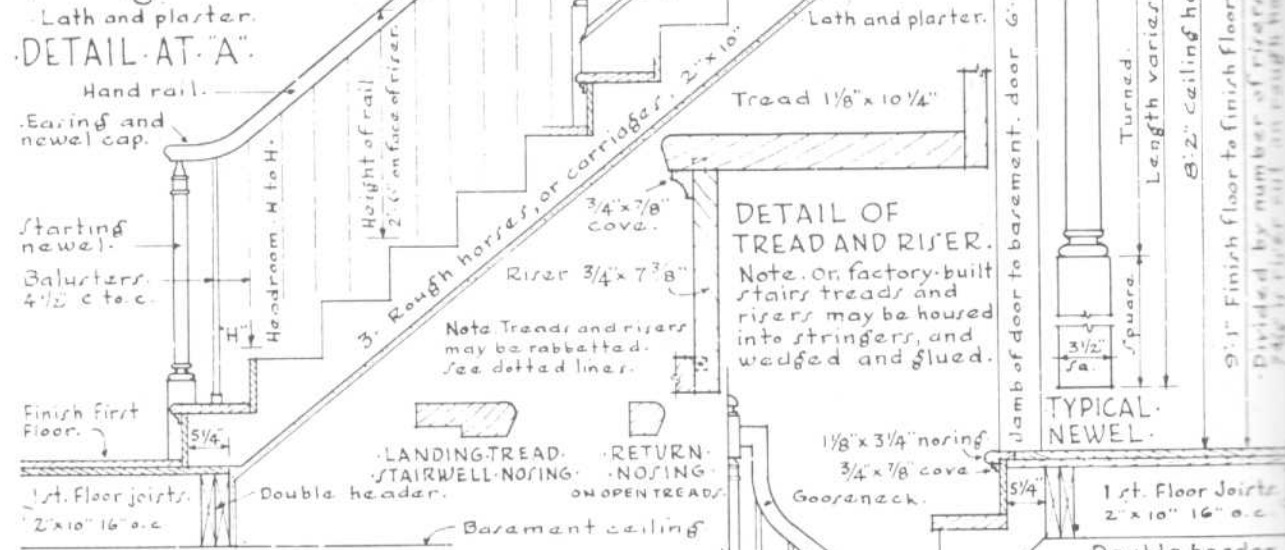
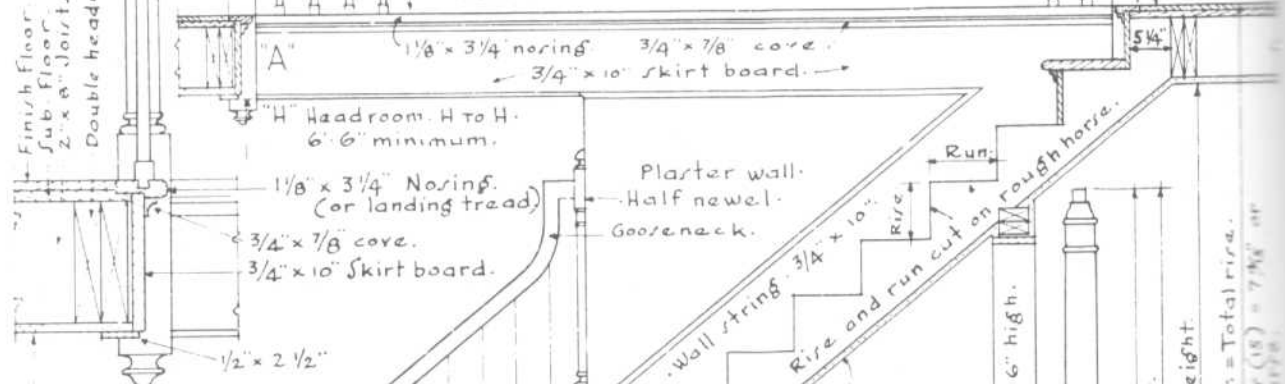
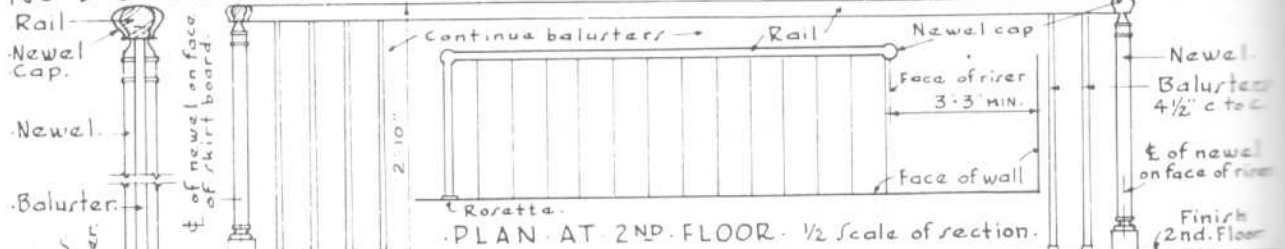
Minimum for head clearance only can be safely taken as 84 in. for all gradients; HUD permits 80 in.



STAIRS

Wood Stairs

NO. D.5. DETAILS OF MAIN STAIRWAY TWO STORY COLONIAL HOUSE

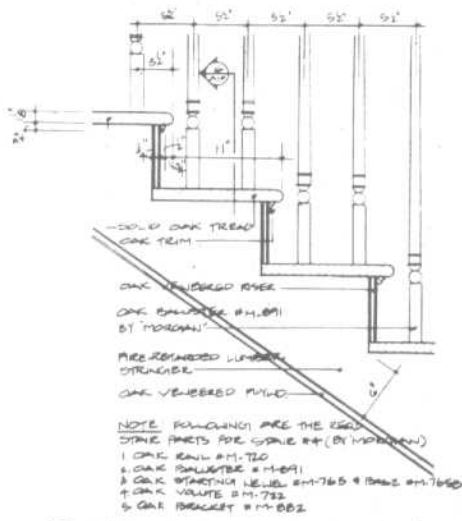
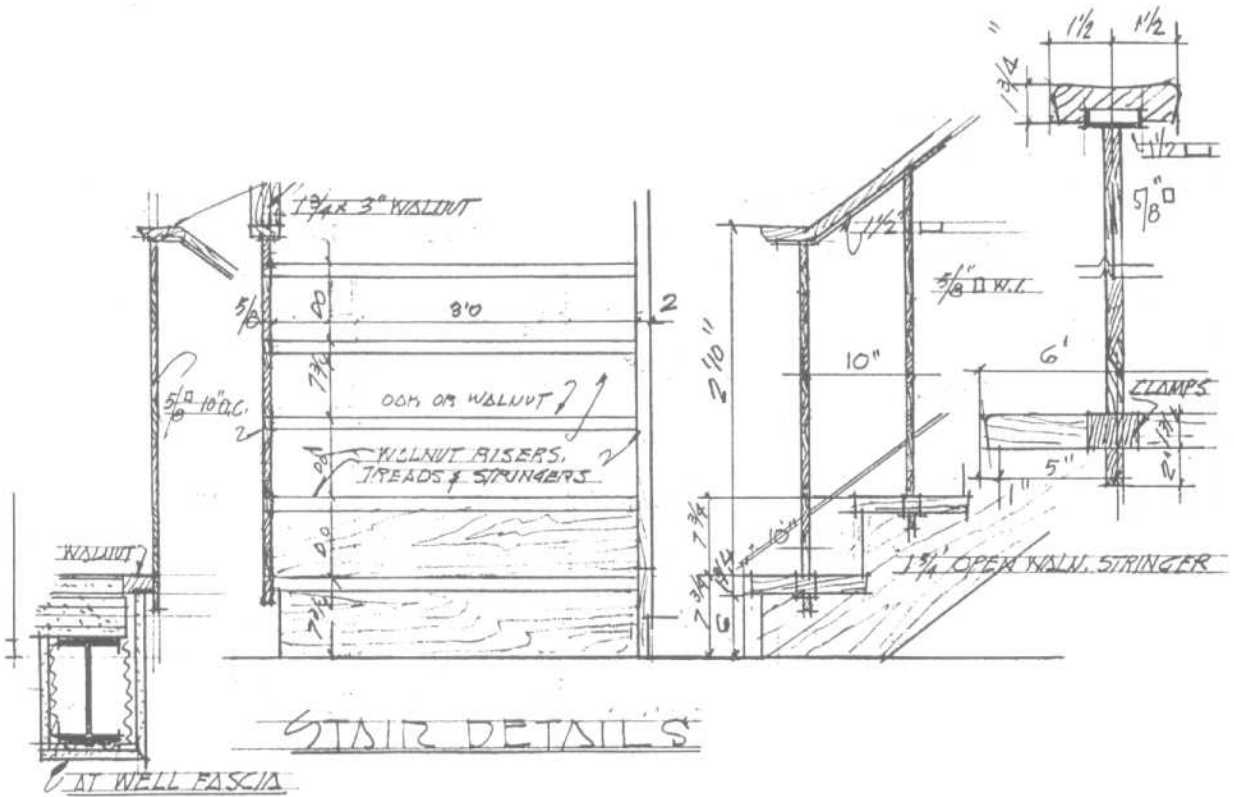




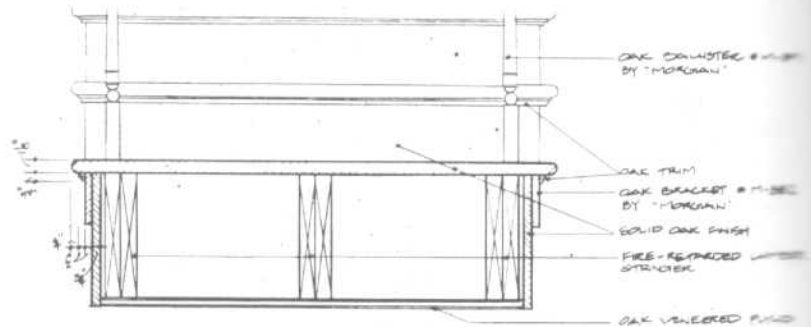


STAIRS

Miscellaneous Stair Details



15  
A10  
DETAIL OF TREAD & RISER AT STAIR #4  
SCALE: 3/4" = 1'-0"



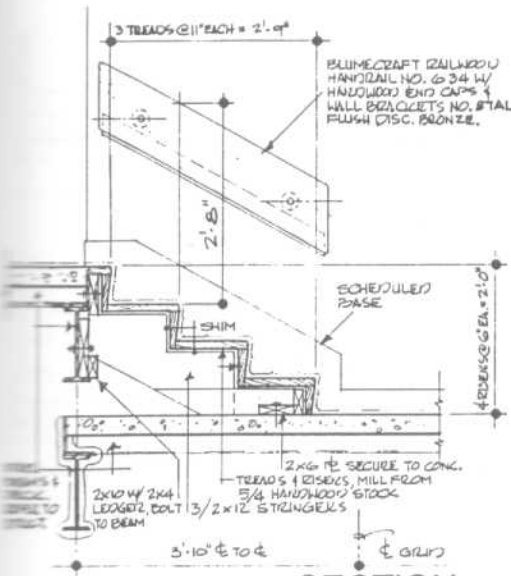
- NOTES
- 1 FOR ALL REED PARTS BY "MORGAN" SEE NOTE ON DETAIL 13A10
  - 2 FOR STEP AT PLATFORM DOWNING & UP, DETAILS ARE SIMILAR TO DETAIL 13A16/A.110

16  
A10  
DETAIL OF STRINGER AT STAIR #4  
SCALE: 1/2" = 1'-0"

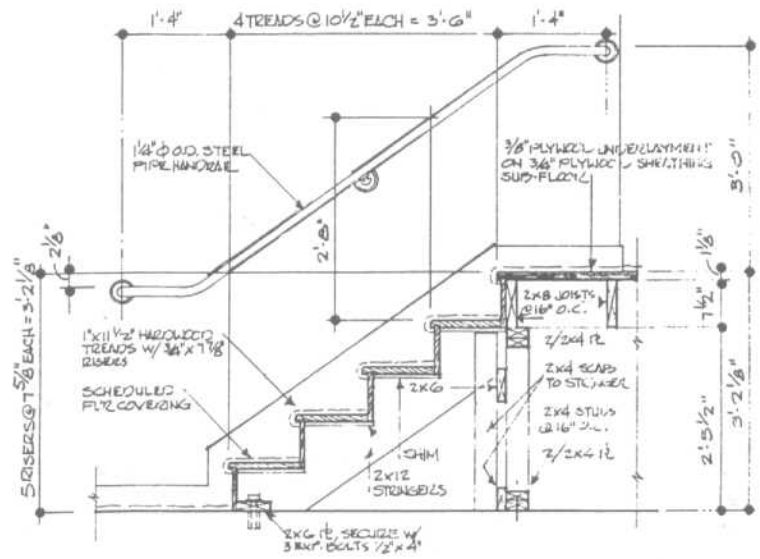


STAIRS

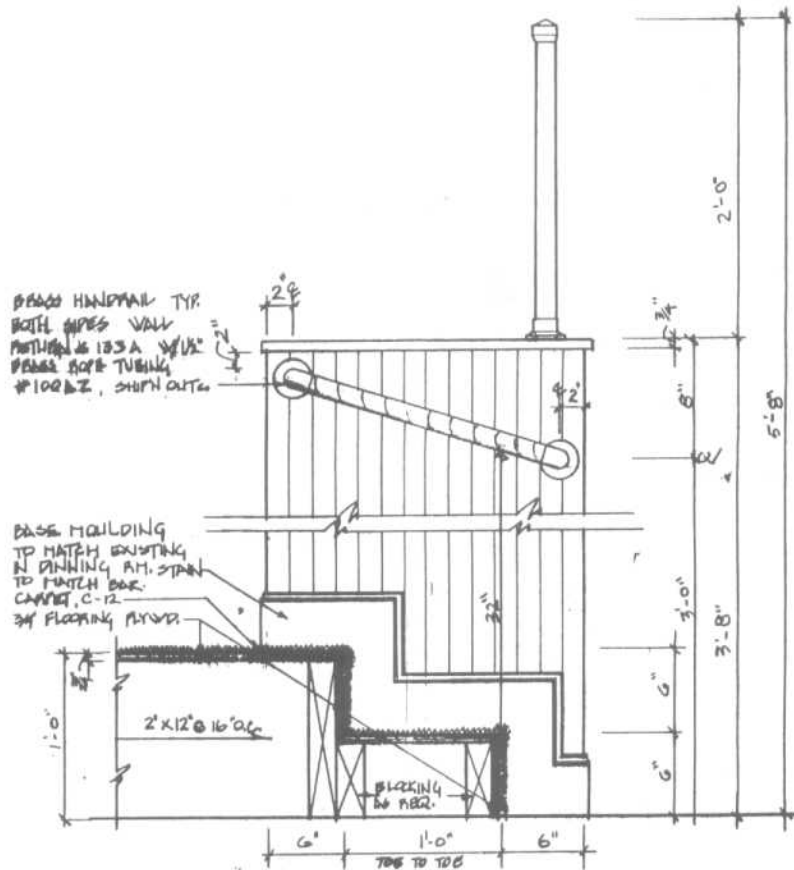
Miscellaneous Stair Details



SECTION



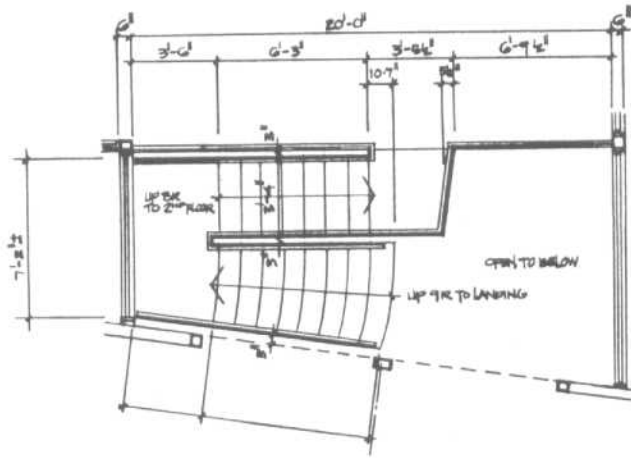
SECTION



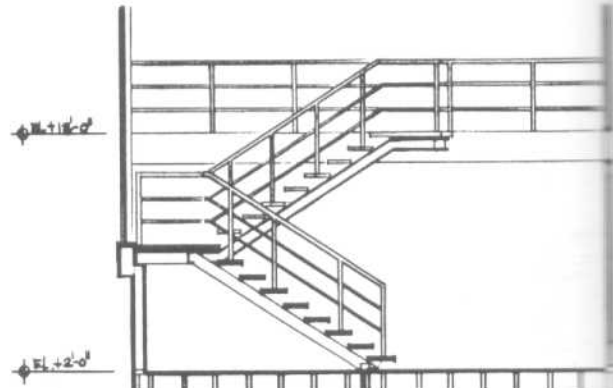
SECTION THRU STEPS

STAIRS

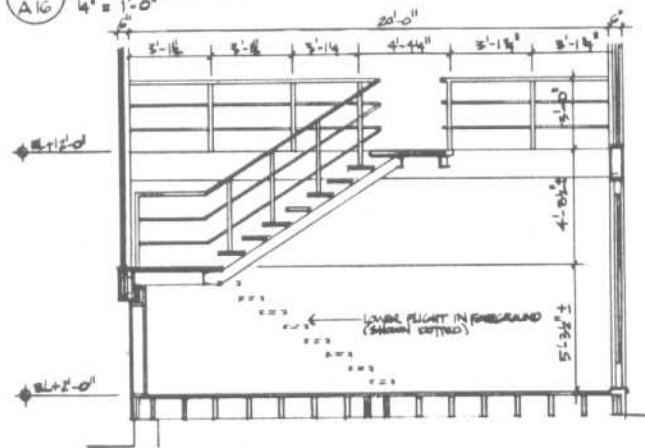
Wood and Steel Stairs



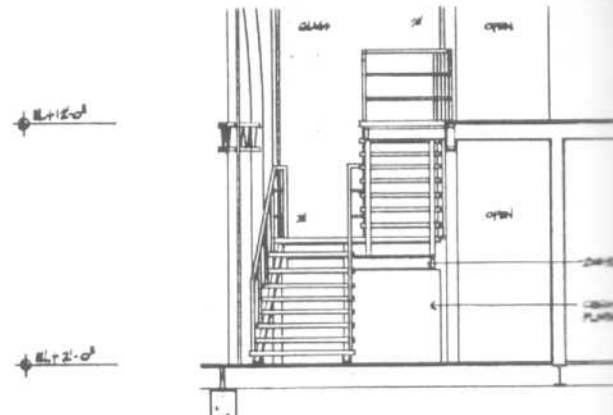
1 PLAN  
A16 4' = 1'-0"



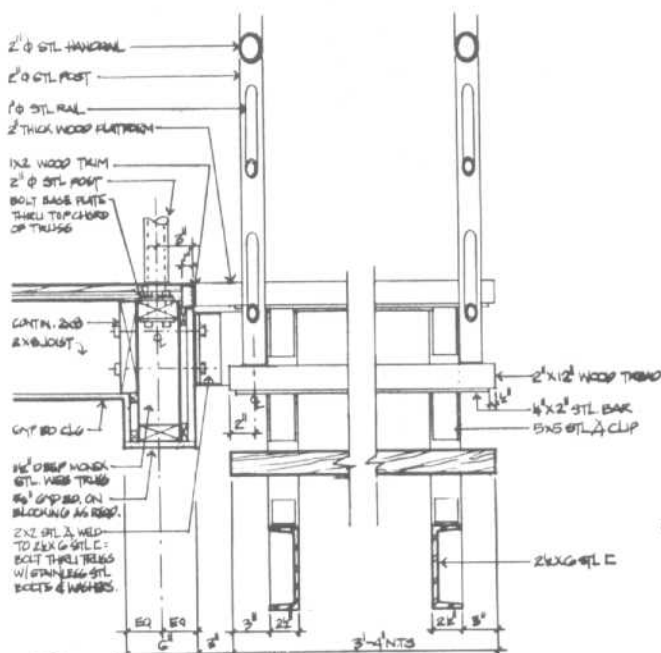
3 SECTION THRU LOWER FLIGHT LOOKING NORTH  
A16 4' = 1'-0"



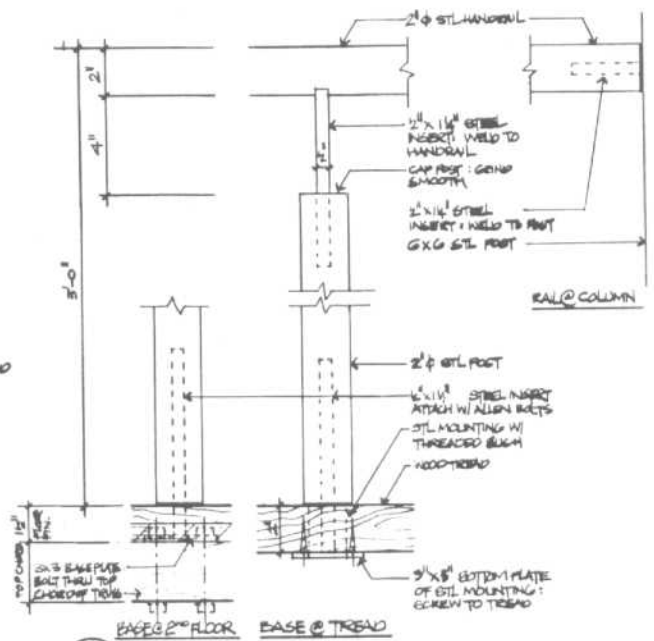
2 SECTION THRU UPPER FLIGHT LOOKING NORTH  
A16 4' = 1'-0"



4 WEST ELEVATION  
A16 4' = 1'-0"



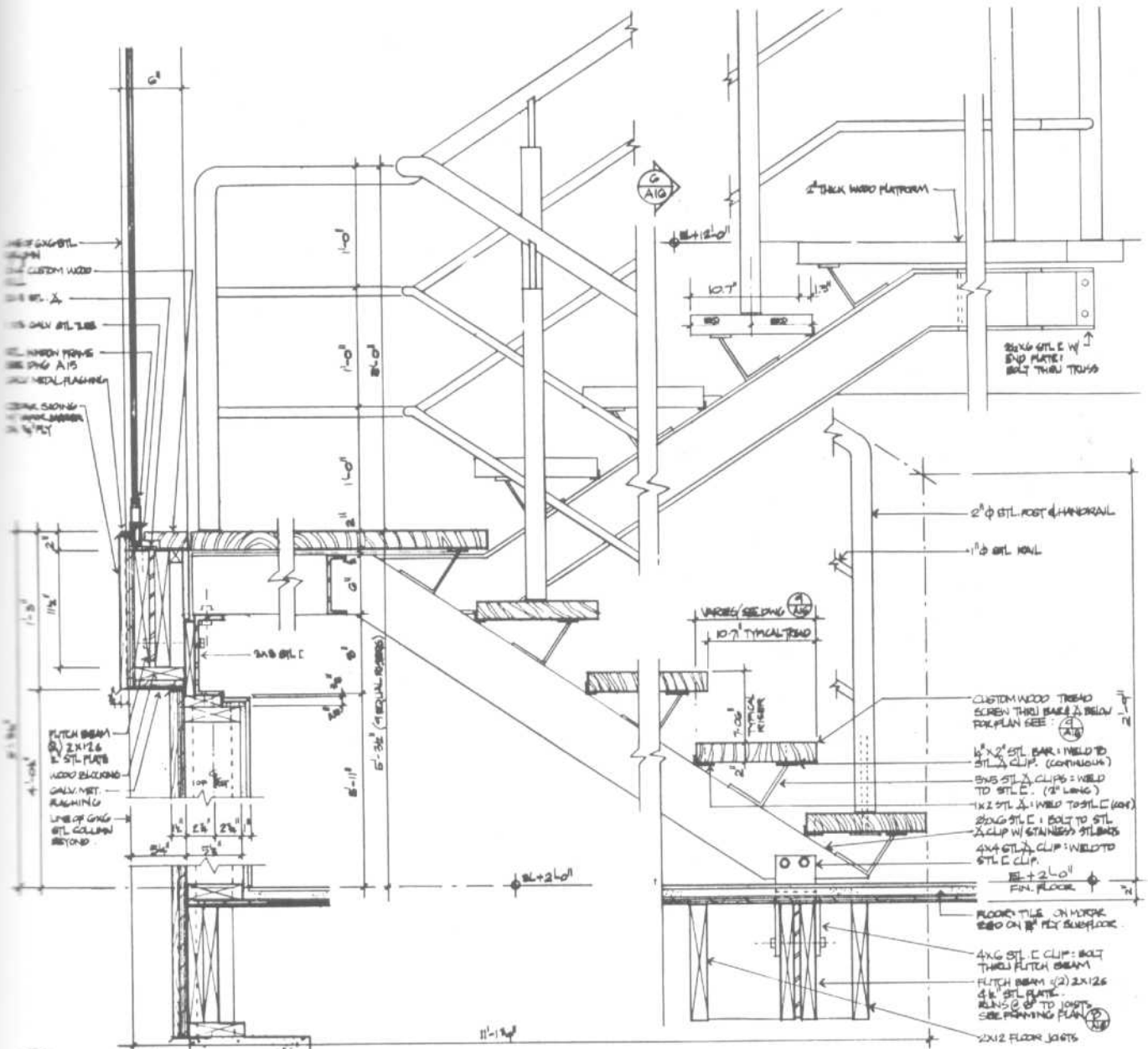
6 CROSS SECTION THRU STAIR  
A16 1/2" = 1'-0"



7 HANDRAIL POST: DETAILS  
A16 3" = 1'-0"

STAIRS

Wood and Steel Stairs

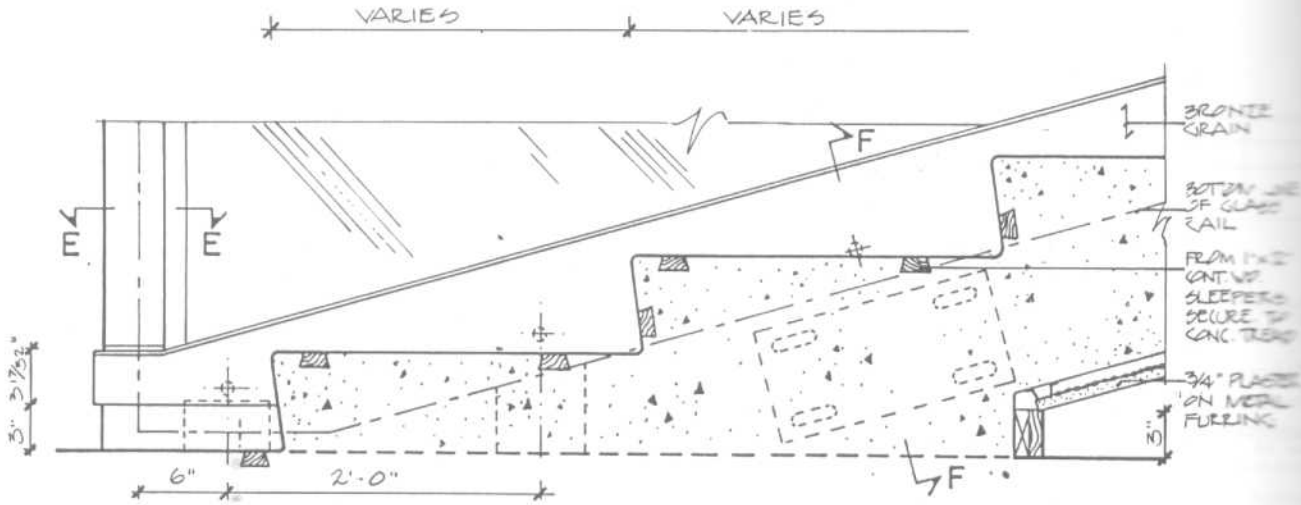


5 SECTIONAL ELEVATION  
A16 1/2" = 1'-0"

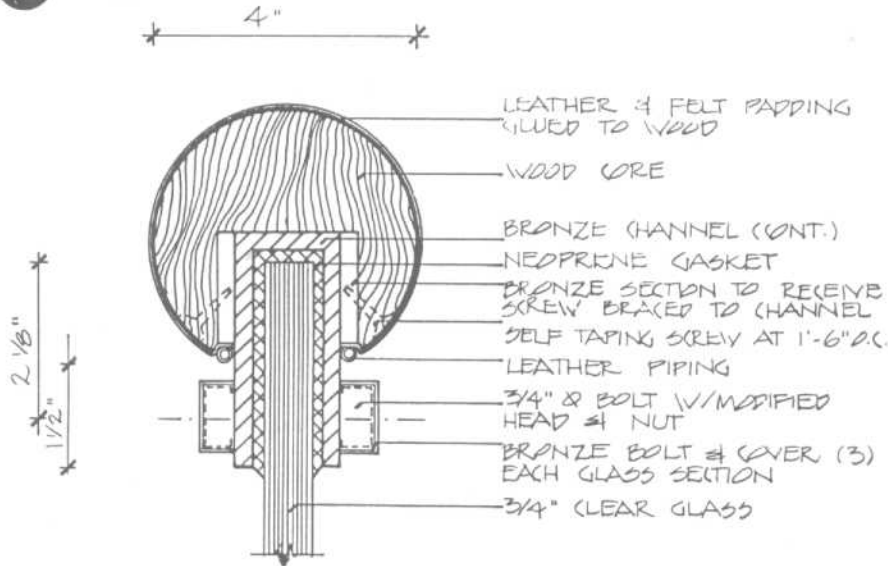
- 2" THICK WOOD PLATFORM
- 2" x 6" STEEL W/ END PLATE BOLT THRU TRUSS
- 2" Ø STEEL POST @ HANDRAIL
- 1" Ø STEEL NAIL
- CUSTOM WOOD TREAD SCREEN THRU BARS & BELOW FOR PLAN SEE: (A16)
- W x 2" STEEL BAR WELDED TO STEEL CLIP (CONTIGUOUS)
- 6x6 STEEL CLIPS WELDED TO STEEL C (2" LONG)
- 1x2 STEEL WELDED TO STEEL C (104)
- 2x6 STEEL BOLT TO STEEL CLIP W/ STAINLESS STEEL BOLTS
- 4x4 STEEL CLIP WELDED TO STEEL CLIP
- FIN. FLOOR
- FLOOR TILE ON WOOD SUB ON 1/2" FLY SUBFLOOR
- 4x6 STEEL CLIP BOLT THRU FURCH BEAM
- FURCH BEAM (2) 2x12 4x STEEL PLATE BUNGLE UP TO JOIST SEE FINISHING PLAN (A16)
- 2x12 FLOOR JOISTS

STAIRS

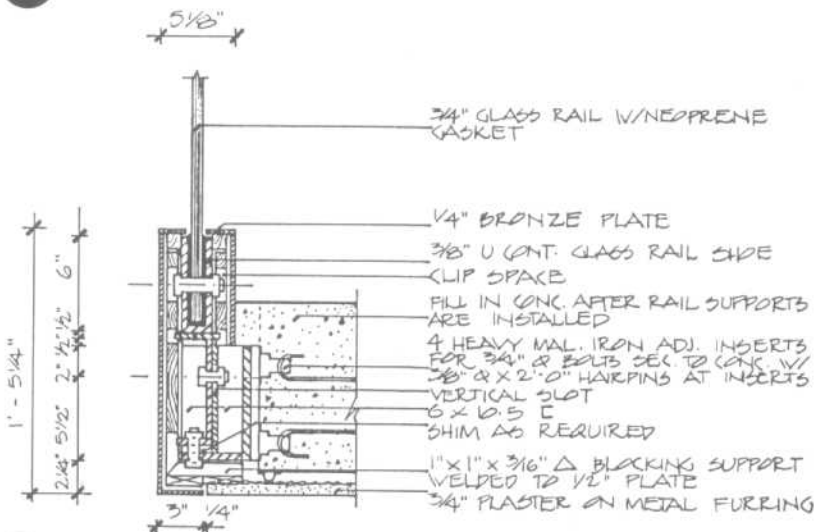
Concrete Stairs



**DD** Section



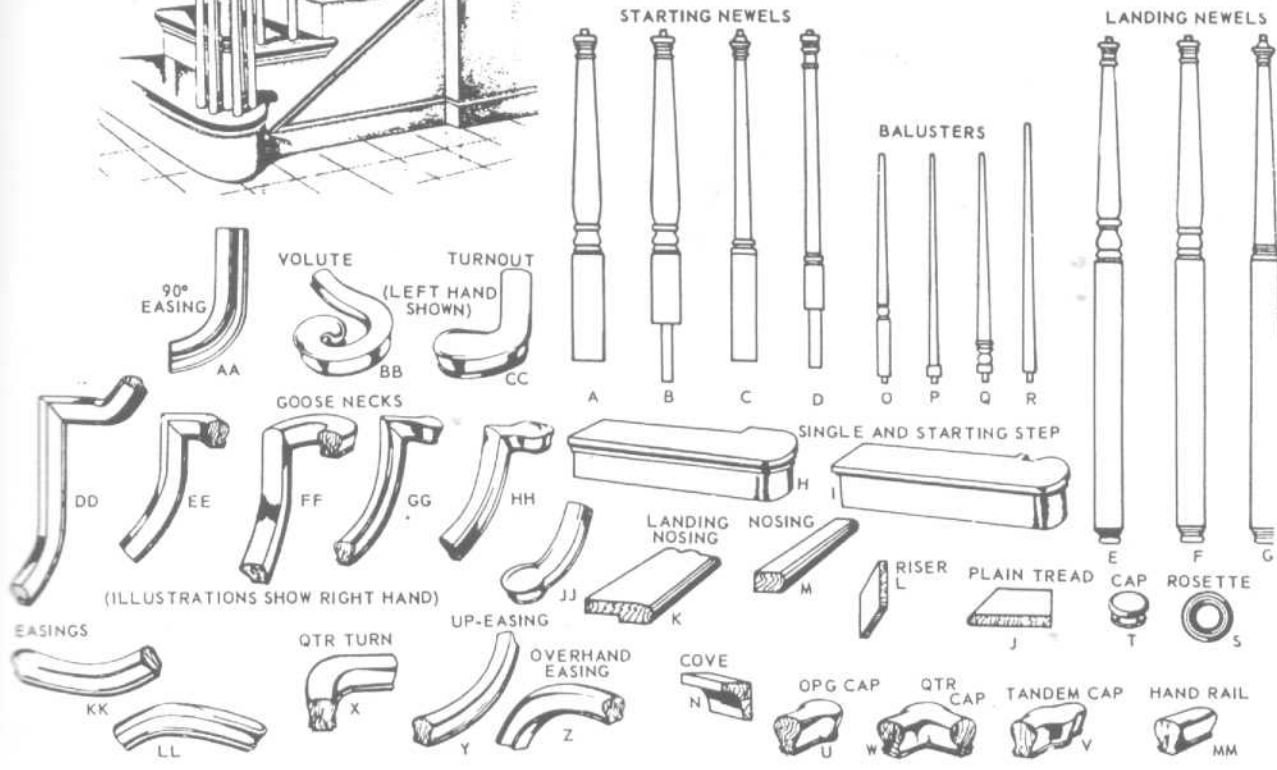
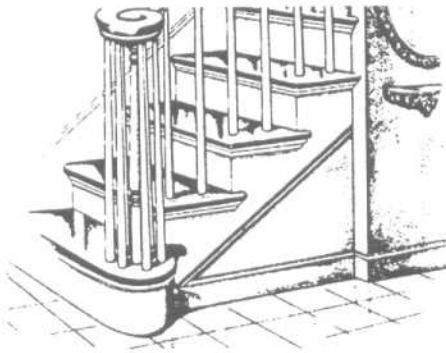
**EE** Section



**FF** Section

STAIRS

Wood Handrail Components



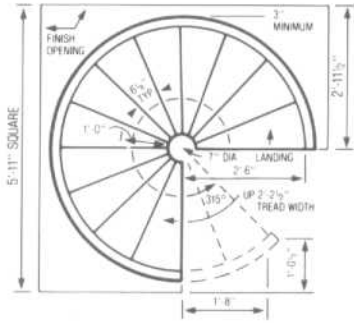
- A-D Starting Newels
- E-G Landing Newel
- H-I Starting Step
- J Stair Tread
- K Landing Tread
- L Risers
- M Return Nosing
- N Stair Cove
- O-R Turned Balusters
- S Wall Rosette
- T Plain Cap
- U One OPC Newel Cap
- V Tandem Cap
- W Quarter Turn Cap
- X Quarter Turn
- Y Up Easing

- A Overhand Easing
- AA 90 degree Up Easing
- BB Volute
- CC Turnout
- DD Gooseneck 2 Riser
- EE Gooseneck 1 Riser
- FF Gooseneck 1 Riser Ledge Return
- GG Gooseneck Riser with Cap
- HH Gooseneck Riser Tandem Cap
- JJ Starting Easing
- KK Starting Easing with Return End
- MM Hand Rail

STAIRS

Spiral and Circular Stairs

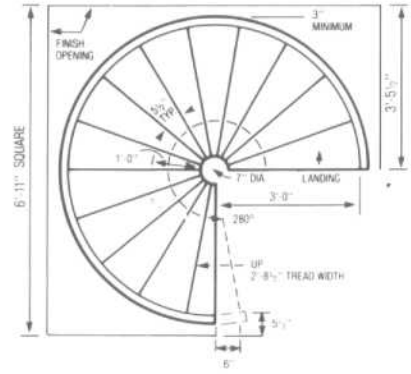
SPIRAL STAIRS



5' diameter – spiral

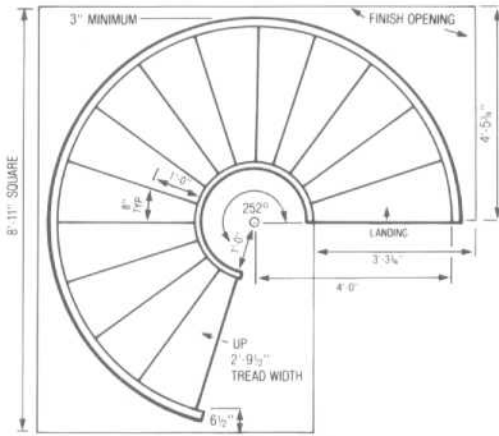


5' diameter – spiral



6' diameter – spiral

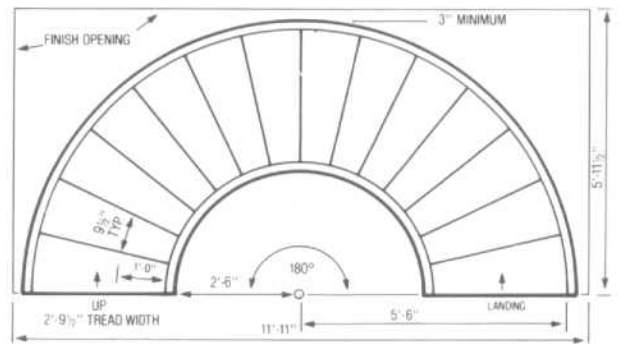
CIRCULAR STAIRS



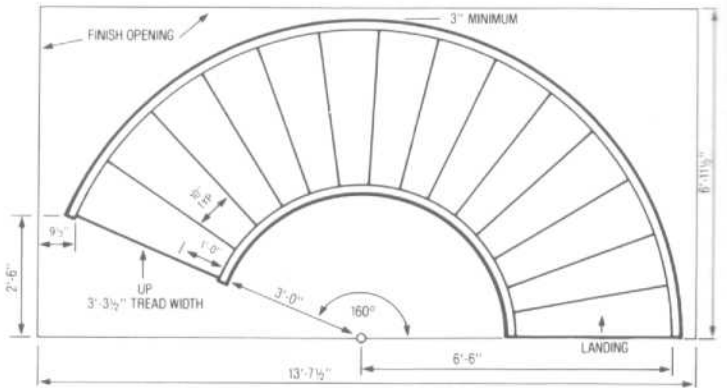
8' diameter – circular



9' diameter – circular



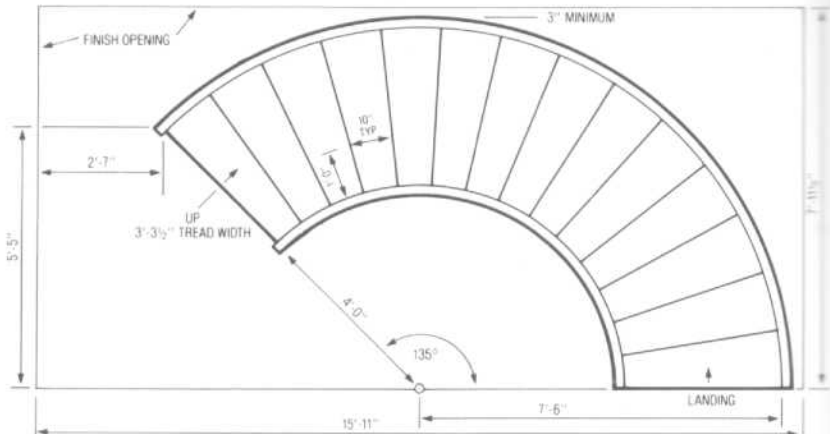
11' diameter – circular



13' diameter – circular



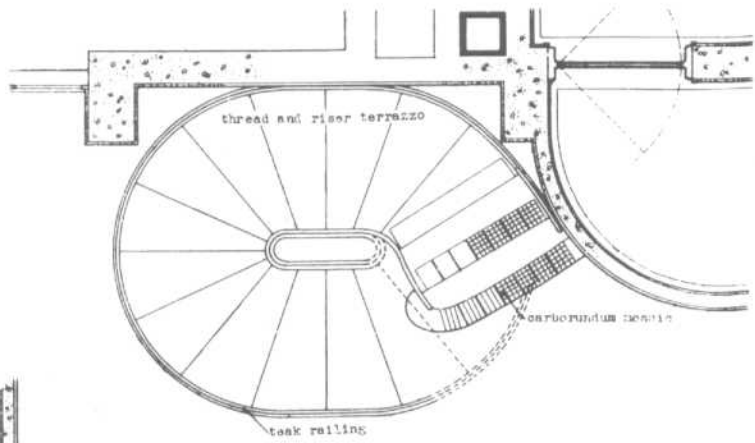
15' diameter – circular



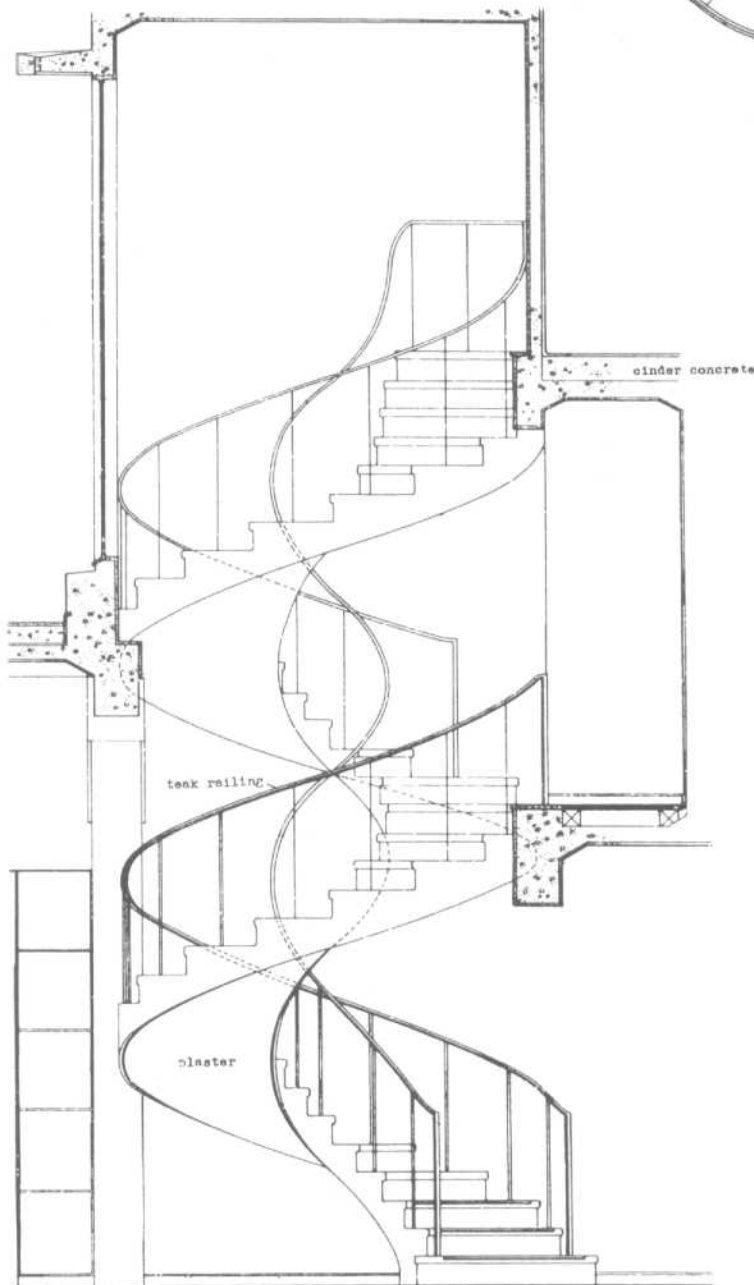
15' diameter – circular

STAIRS

Circular/Oval Stairs



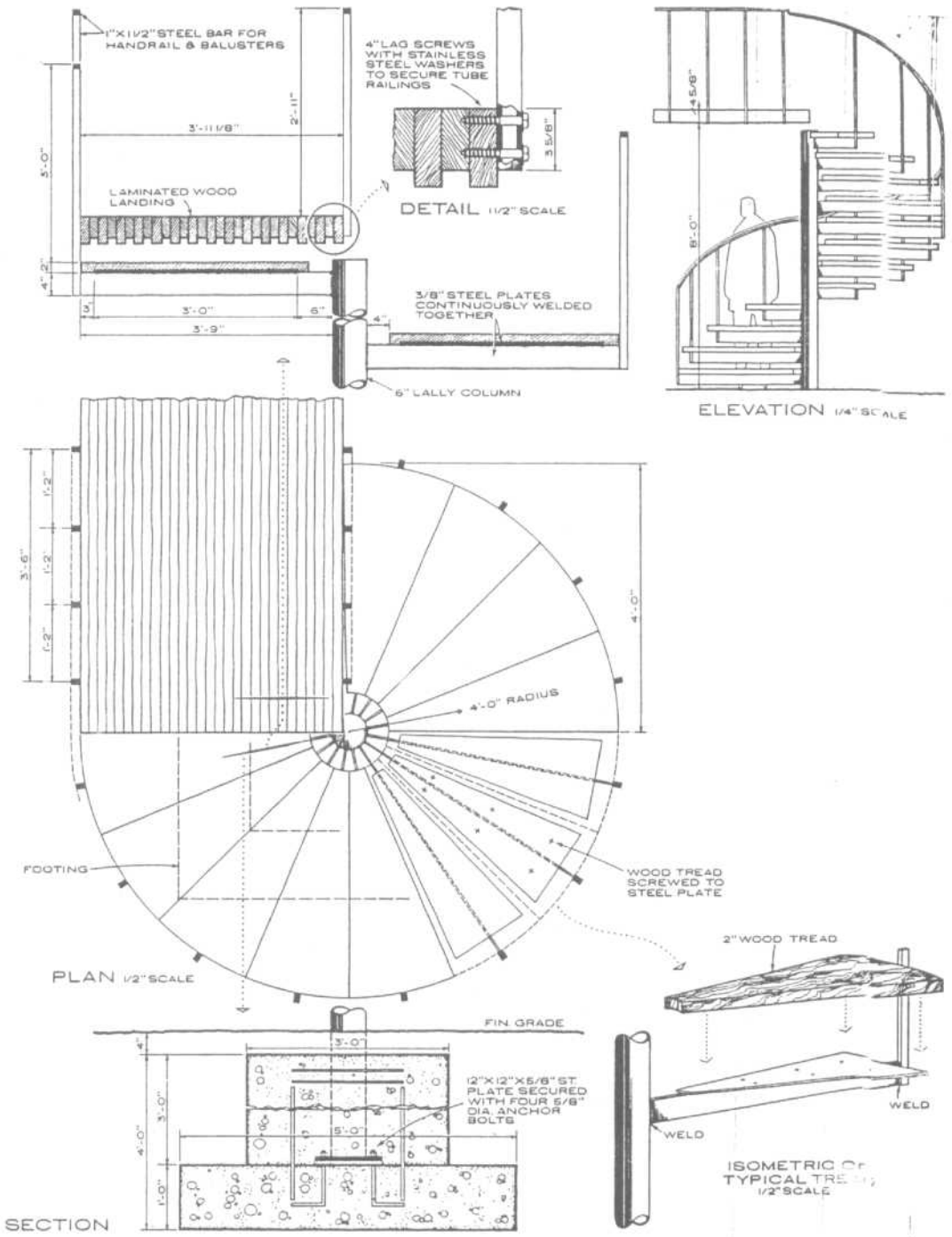
Plan



Elevation

STAIRS

Spiral Stairs





### Types of Stairs

Four types of stairs are defined: straight stairs, circular stairs, curved stairs, and spiral stairs.

Straight stairs are by far the most common type, representing the bulk of the stair market. Though the term "straight" is self-explanatory, for purposes of classification a straight stair is defined as one in which the stringers are straight members. Straight stairs, unlike stairs of the other three types, may be arranged in several different ways:

**Straight run:** Either a single flight extending between floors, as shown in Fig. 5A, or a series of two or more flights in the same line, with intermediate platforms between them, as shown in Fig. 5B.

**Parallel:** Successive flights which parallel each other and are separated only by one or more intermediate platforms, as shown in Fig. 5C.

**Angled:** Successive flights placed at an angle of other than 180° to each other (often 90°), with an intermediate platform between them, as shown in Fig. 5D or E. The type shown in Fig. 5D is often referred to as a "trussed" stair.

**Scissor:** A pair of straight run flights paralleling each other in plan and running in opposite directions on opposite sides of a dividing wall, as shown in Fig. 5F.

Circular stairs are stairs which, in plan view, have an open circular form, with a single center of curvature. They may or may not have intermediate platforms between floors.

Curved stairs are stairs which, in plan view, have two or more centers of curvature, being oval, elliptical, or some other compound curved form. They also may or may not have one or more intermediate platforms between floors.

Spiral stairs are stairs with a closed circular form, having uniform sector shaped treads and a supporting center column.

### Classes of Stairs

The class designation of stairs, as already noted, is a key to the type of construction, the quality of materials, details and finish and, in most cases, the relative cost. As stairs of all classes are built to meet the same standards of performance in respect to load carrying capacity and safety, these class distinctions do not represent differences in functional value, but in character and appearance. It is important to recognize that where function is the prime concern, and esthetics are of minor importance, significant economies can be achieved by specifying one of the less expensive classes.

The following four classes of stairs are listed in order of increasing cost (as a general rule); the general construction characteristics of each class are described.

**Industrial class.** Stairs of this class are purely functional in character and consequently they are generally the most economical. They are designed for either interior or exterior use, in industrial buildings such as factories and warehouses, or as fire escapes or emergency exitways. They do not include stairs which are integral parts of industrial equipment.

Industrial class stairs are similar in nature to any light steel construction. Hex head

bolts are used for most connections, and welds, where used, are not ground. Stringers may be either flat plate or open channels; treads and platforms are usually made of grating or formed of floor plate, and risers are usually open, though in some cases filled pan type treads and steel risers may be used. Railings are usually of either pipe, tubing, or light steel angle construction.

**Service class.** This class of stairs serves chiefly functional purposes, but is not unattractive in appearance. Service stairs are usually located in enclosed stairwells and provide a secondary or emergency means of travel between floors. In multistoried buildings they are commonly used as egress stairs. They may serve employees, tenants, or the public, and are generally used where economy is a consideration.

Stringers of service stairs are generally the same types as those used on stairs of the industrial class. Treads may be one of several standard types, either filled or formed of floor or tread plate, and risers are either exposed steel or open construction. Railings are typically of pipe construction or a simple bar type with tubular newels, and soffits are usually left exposed. Connections on the underside of the stairs are made with hex head bolts, and only those welds in the travel area are smooth.

**Commercial class.** Stairs of this class are usually for public use and are of more attractive design than those of the service class. They may be placed in open locations or may be located in closed stairwells or in public, institutional, or commercial buildings.

Stringers for this class of stairs are usually exposed open channel or plate sections. Treads may be any of a number of standard types, and risers are usually exposed steel. Railings vary from ornamental bar or tube construction with metal handrails to simple pipe construction, and soffits may or may not be covered. Exposed bolted connections in areas where appearance is critical are made with countersunk flat or oval head bolts; otherwise, hex head bolts are used. Welds in conspicuous locations are smooth, and all joints are closely fitted.

**Architectural class.** This classification applies to any of the more elaborate and usually more expensive stairs, those which are designed to be architectural features in a building. They may be wholly custom designed or may represent a combination of standard parts with specially designed elements such as stringers, railings, treads, or platforms. Usually this class of stair has a comparatively low pitch, with relatively low risers and correspondingly wider treads. Architectural metal stairs may be located either in the open or in enclosed stairwells in public, institutional, commercial, or monumental buildings.

The materials, fabrication details, and finishes used in architectural class stairs vary widely, as dictated by the architect's design and specifications. As a general rule, construction joints are made as inconspicuous as possible, exposed welds are smooth, and soffits are covered with some surfacing material. Stringers may be special sections exposed, or may be structural members enclosed in other materials. Railings are of an ornamental type and, like the treads and risers, may be of any construction desired.

### General Requirements, All Classes of Stairs

All fixed metal stairs, regardless of class, are of fire-resistant construction and are designed and constructed to carry a minimum live load of 100 pounds per square foot of projected plan area or an alternative concentrated load of 300 pounds applied at the center of any tread span. Railings and handrails are designed and constructed to withstand a minimum force of 200 pounds applied in any direction at any point on the rail.

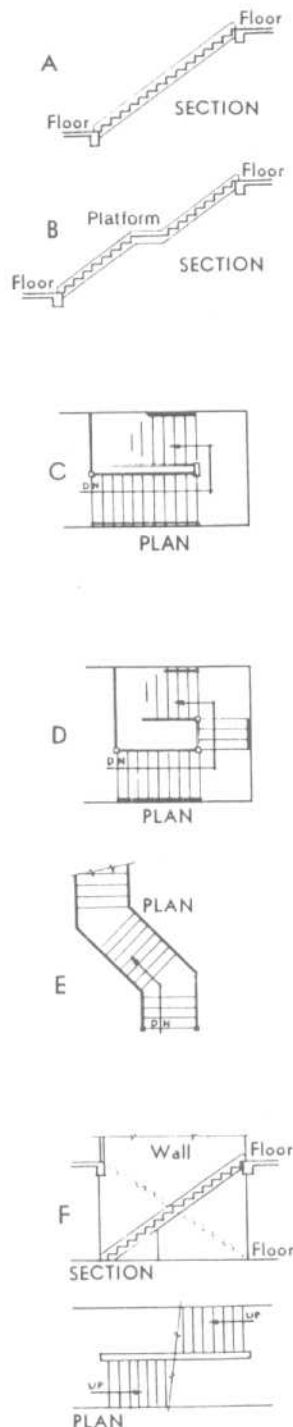
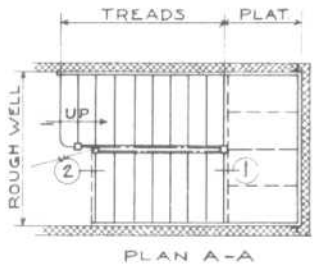
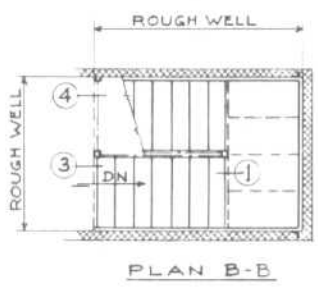
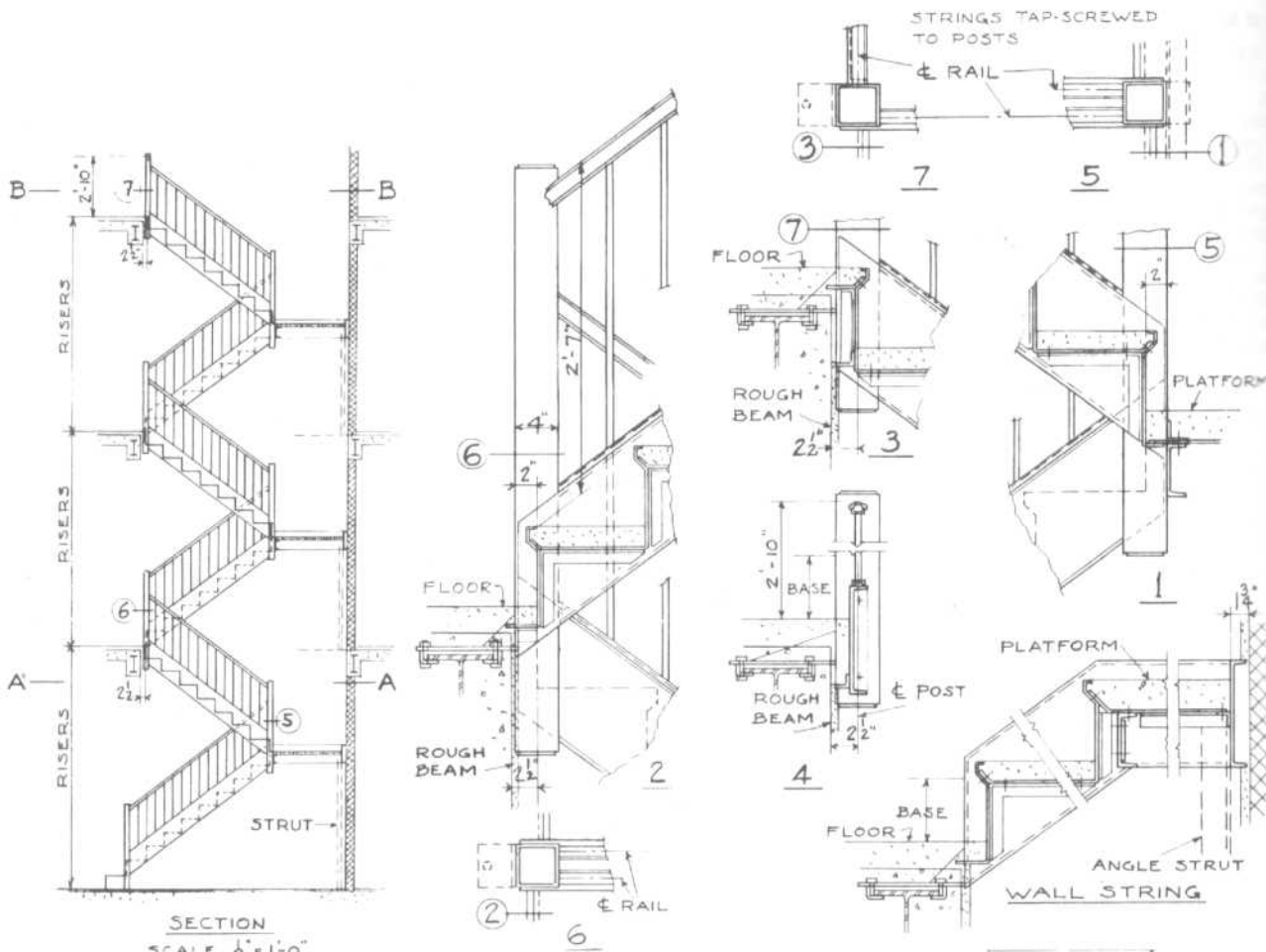


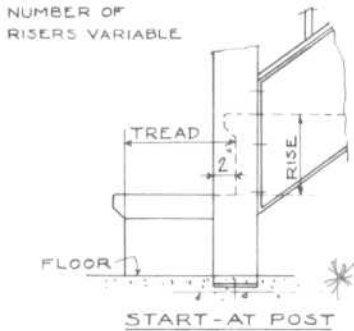
Fig. 5

STAIRS

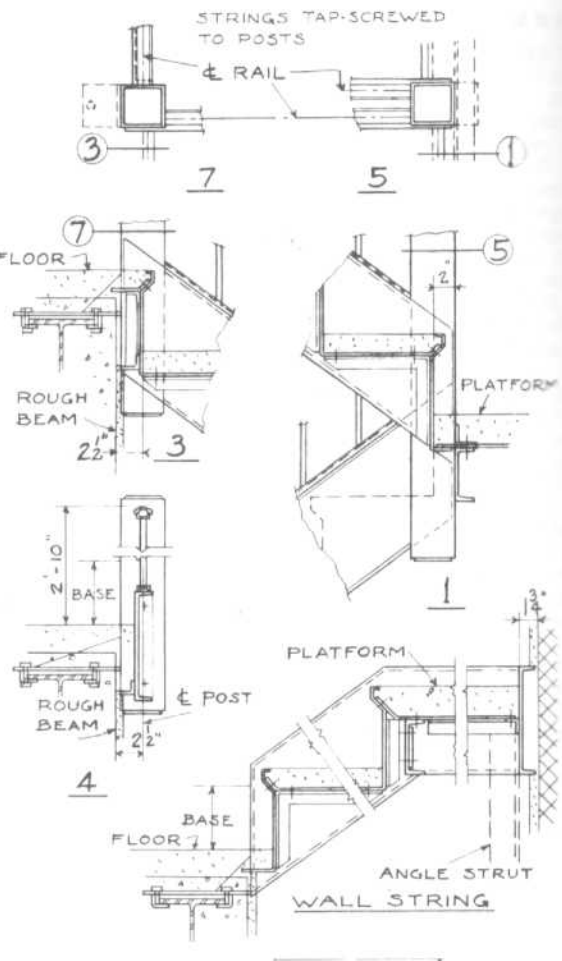
General Purpose Steel Stairs



LAYOUT FOR:  
MULTIPLE STORY  
INTERMEDIATE PLATFORM  
TWO RUNS PER STORY



START-AT POST

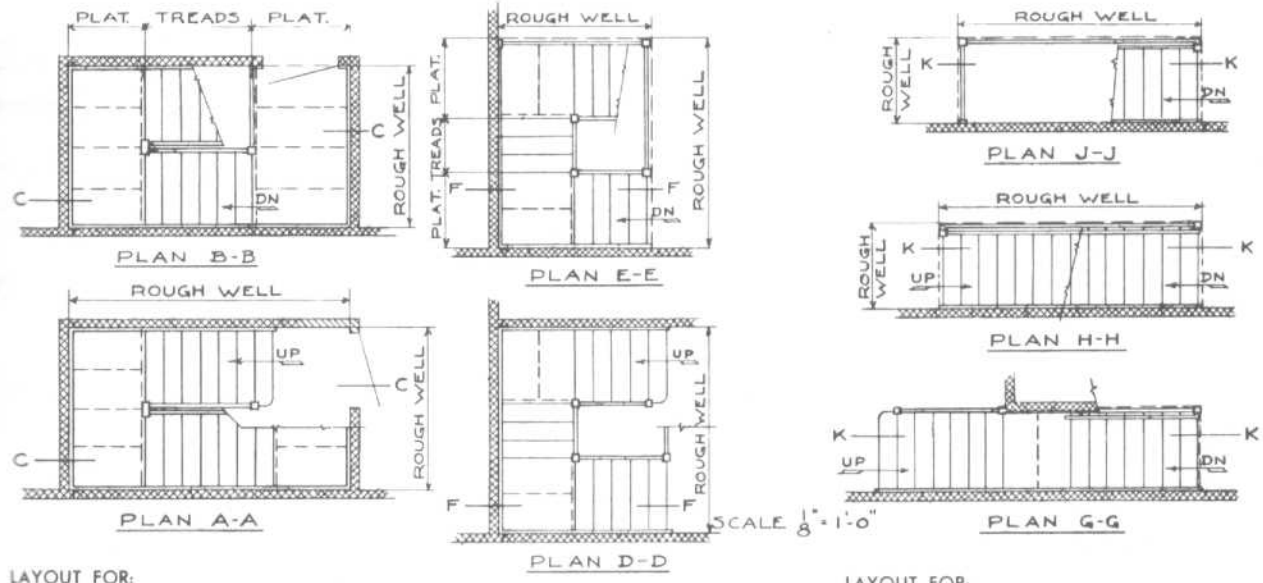
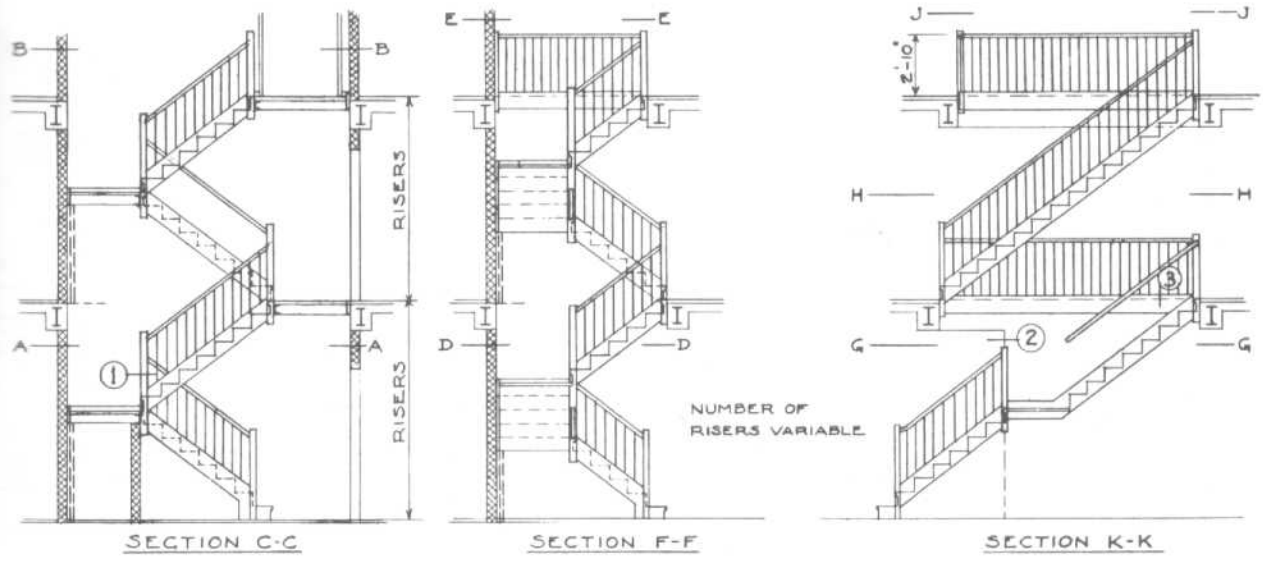


WALL STRING  
START-AT WALL  
SCALE 3/4"=1'-0"

**SPECIFICATION FOR STAIR AS DETAILED:**  
Furnish and erect steel stairs and railings complete as detailed. Strings 10"x1 1/2"x8.4 lb. channels with 1 1/4"x1 1/4"x1/8" angle brackets, facias same section bolted to newels and floor construction. Headers of channels bolted or welded to newels and strings. Angle struts placed in wall, bolted to strings and to floor construction. Risers and sub-treads of 14 gauge steel, sub-platforms of 12 gauge steel reinforced with angle or tee stiffeners. Fill, 2" for treads, 3" for platforms, by others. Newels 4" square pipe, railing balusters 1/2" square spaced 4 1/2" and welded into 1"x1 1/2" channels top and bottom with handrail section as shown. All surfaces to be cleaned and painted one shop coat. Shop drawings, to show construction methods and fastenings, are to be approved before fabrication.

**ALTERNATE SPECIFICATIONS:**  
Strings may be channels, flat plates, or formed plates.  
Tread Brackets may be other size angles, or bars.  
Riser Brackets may be omitted.  
Hanger Rods may be used in place of struts.  
Sub-Treads, Risers and Sub-Platforms may be heavier gauge.  
Newels and Railings may be of other construction as designed by architect.  
Wall Rails, where required, may have same handrail section as railing.  
Prime Coat may be red lead, black graphite, zinc chromate, or other approved paint.

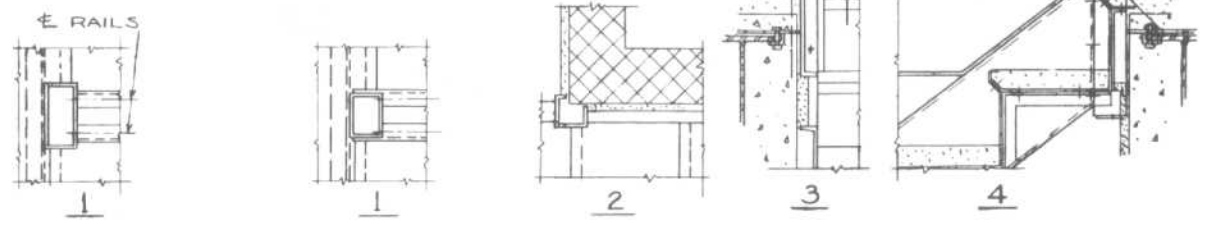
**STAIRS**  
Steel Stairs



LAYOUT FOR:  
 MULTIPLE STORY  
 INTERMEDIATE PLATFORMS  
 PLATFORM AT FLOOR  
 TWO RUNS PER STORY  
 Strings and rails finishing against face of rectangular newels, allowing minimum hand clearance between strings and rails. For wider center well, two square newels replace one rectangular newel.

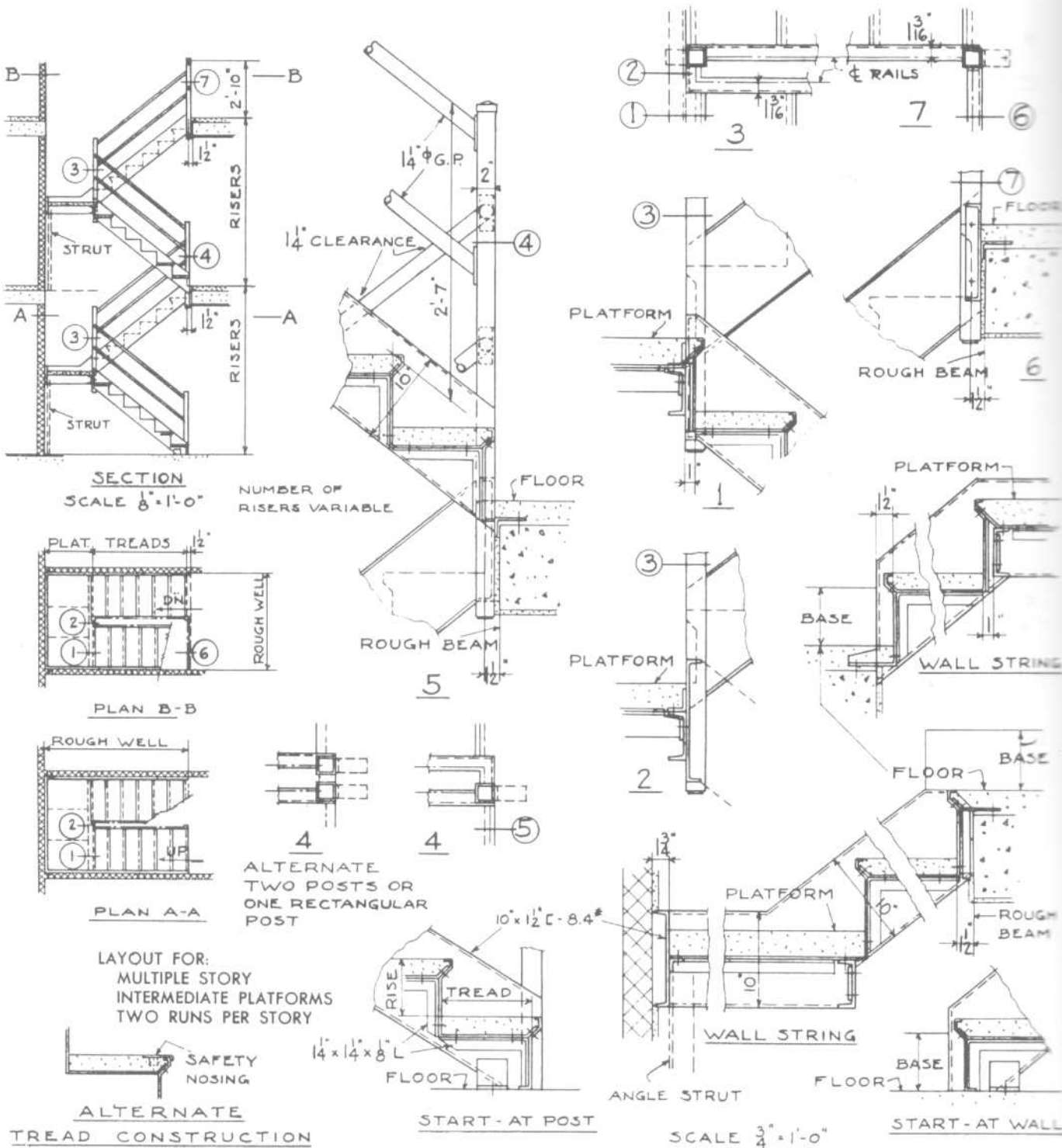
LAYOUT FOR:  
 MULTIPLE STORY  
 INTERMEDIATE PLATFORMS  
 THREE RUNS PER STORY  
 Open center well allowing intermediate stair runs at 90 degrees. One square newel at each platform.

LAYOUT FOR:  
 MULTIPLE STORY  
 INTERMEDIATE PLATFORMS  
 ONE AND TWO RUNS PER STORY  
 Arrangement for stairs in corridors, or other restricted spaces, either closed or open well.

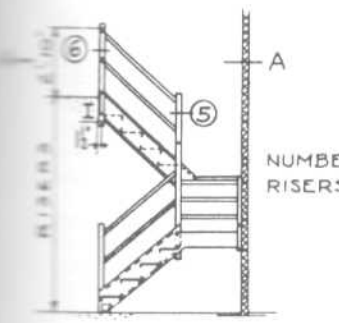


STAIRS

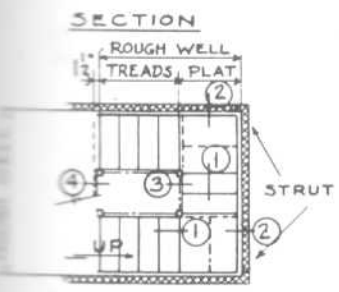
Steel Stairs



**STAIRS**  
Steel Stairs



NUMBER OF RISERS VARIABLE



PLAN A-A

SCALE  $\frac{1}{8}'' = 1'-0''$

LAYOUT FOR:  
SINGLE STORY  
INTERMEDIATE PLATFORMS  
THREE RUNS PER STORY



GRATING



CAST ABRASIVE

ALTERNATE TREAD CONSTRUCTION

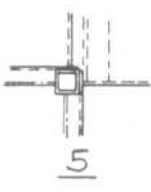


WALL RAIL ENDS RETURNED

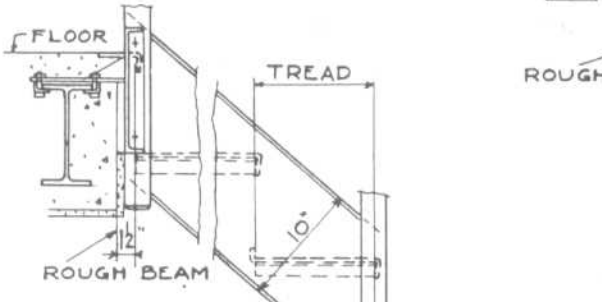
$1\frac{1}{4}'' \phi$  PIPE



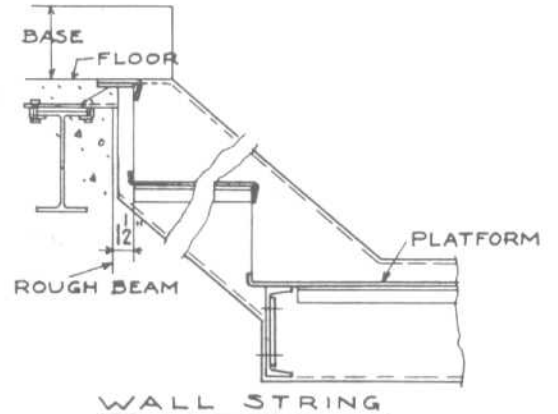
6



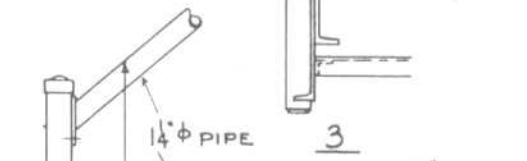
5



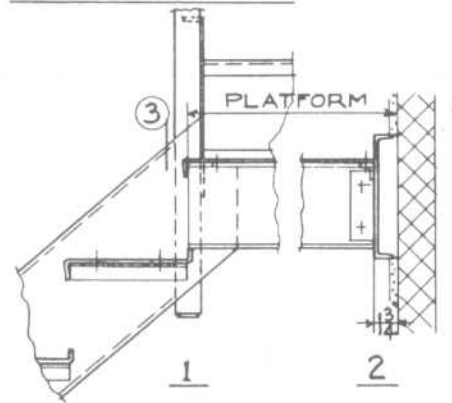
4



WALL STRING

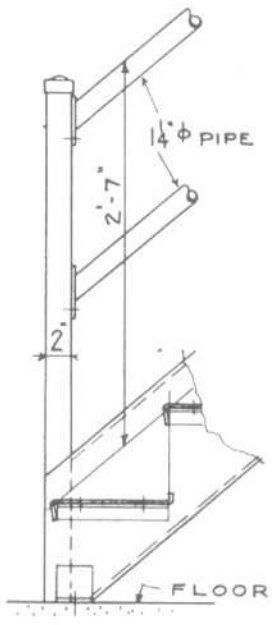


3

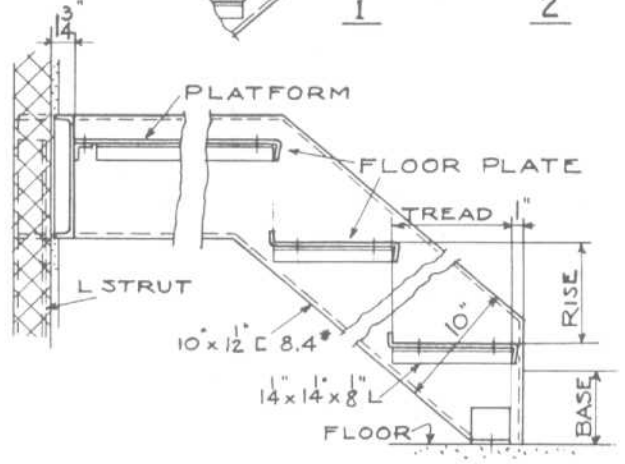


1

2

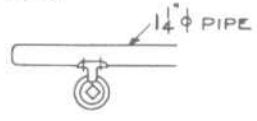


START-AT POST

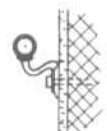


WALL STRING

SCALE  $\frac{3}{4}'' = 1'-0''$

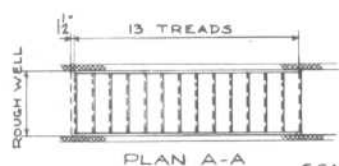
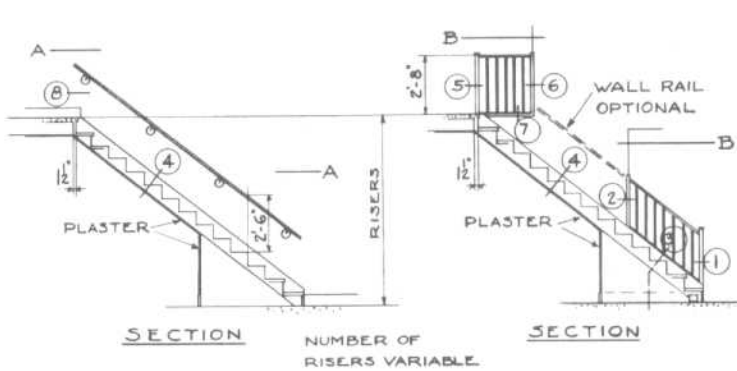


WALL RAIL CLOSED END WITH BRACKET

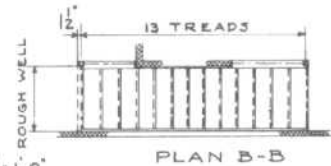


STAIRS

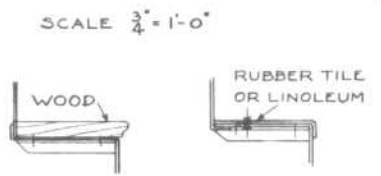
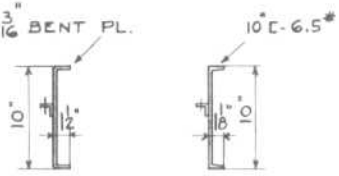
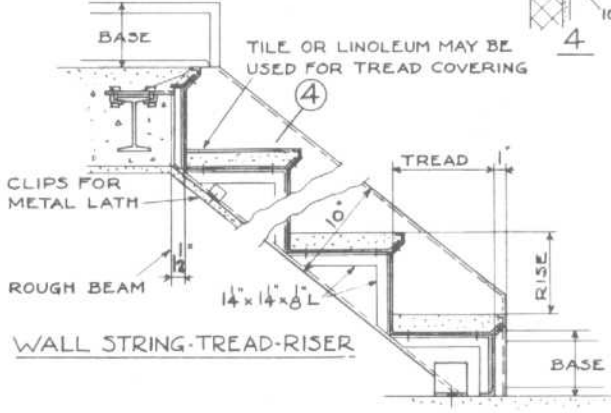
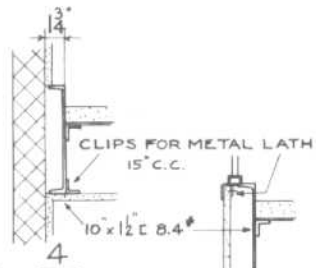
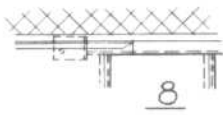
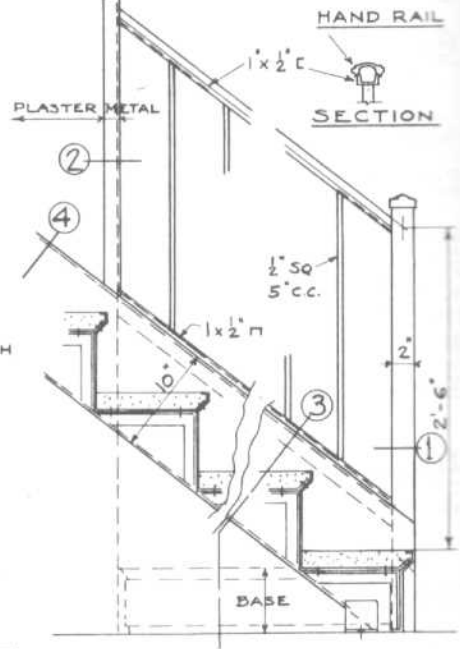
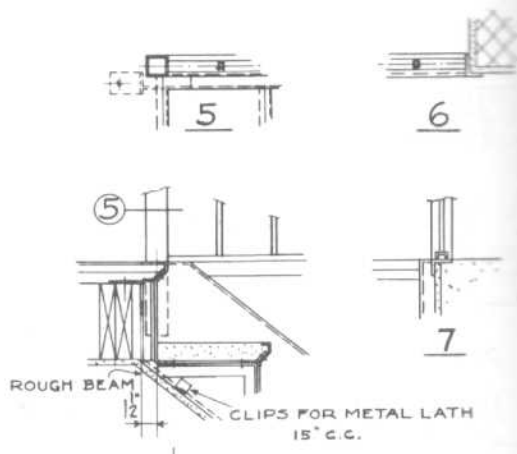
Steel Stairs



LAYOUT FOR:  
ONE STORY  
SINGLE RUN  
BETWEEN WALLS



LAYOUT FOR:  
ONE STORY  
SINGLE RUN  
WITH RAILINGS



STAIRS

Stair Platform Construction

The platform (Fig. 6) is shown constructed with a steel channel, A, of adequate strength to span the well on line X, through Secs. 1, 2, and 3, and supported at both ends by the wall strings. Newel posts rest on this channel through angle clips, around which the platform plate is cut (Sec. 3). Face strings have welded end plates with flathead screws tapped into the newels (Sec. 2).

The two platforms with two intermediate risers (Fig. 7) are shown constructed with the load carried on line Y by string B, post C, and channel D, which are shown bolted together (Secs. 8, 9, and 10) with through bolts. The load is also carried from post C on line Z in the same manner.

The members at post C may be brought together and welded and the post fitted over the connection, or the entire unit welded.

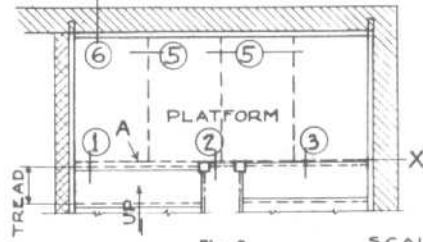


Fig. 6

Plan—One Platform. Load carried on Line X. Wall strings supported on masonry wall.

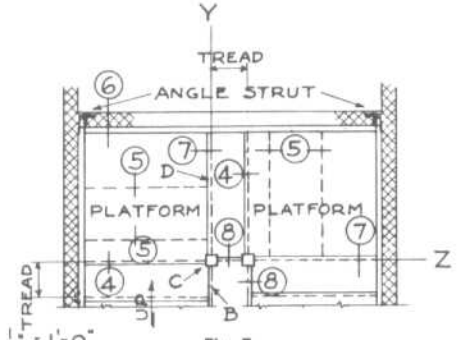
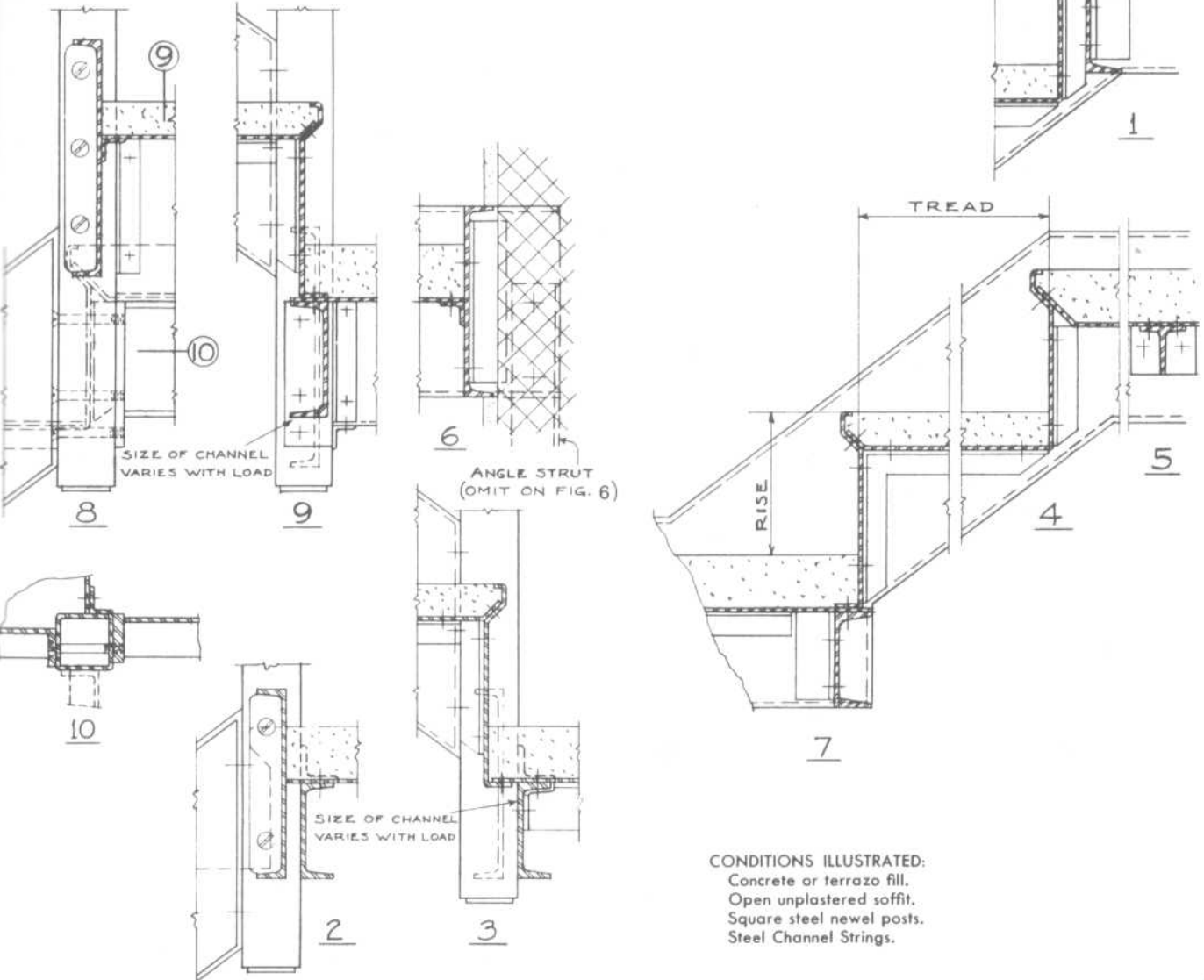


Fig. 7

Plan—Two Platforms with Two Intermediate Risers. Load carried on Line Y and supplemented on Line Z. Wall strings supported by struts.

SCALE 1/4" = 1'-0"

Stairs are supported by one or more of the following methods, (a) String at floor rests directly on floor construction; (b) String at landing or platform extends into adjacent load-bearing wall; or (c) String at landing or platform is supported by struts extending to the floor below, these being of angles, I-beams or pipes either set in the wall or exposed; or (d) String at landing or platform is supported by rods hung from the floor above, either set in walls or exposed; (e) String paralleling load-bearing wall may have shelf brackets on the back of the strings and set in wall; similar brackets may be used with struts or hanger rods.

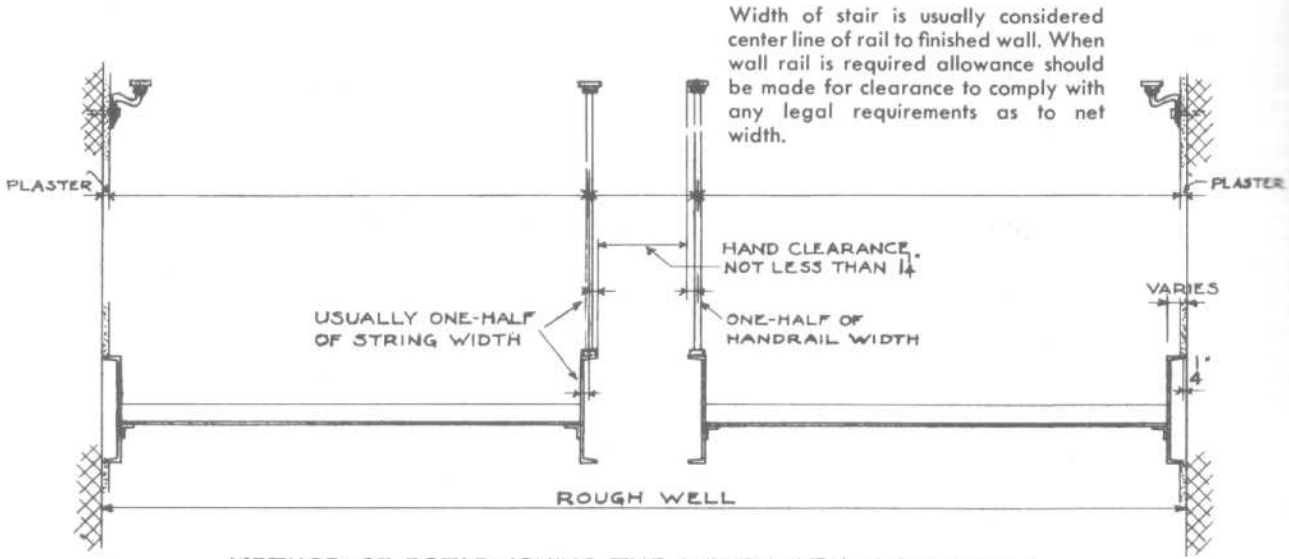


CONDITIONS ILLUSTRATED:  
 Concrete or terrazo fill.  
 Open unplastered soffit.  
 Square steel newel posts.  
 Steel Channel Strings.

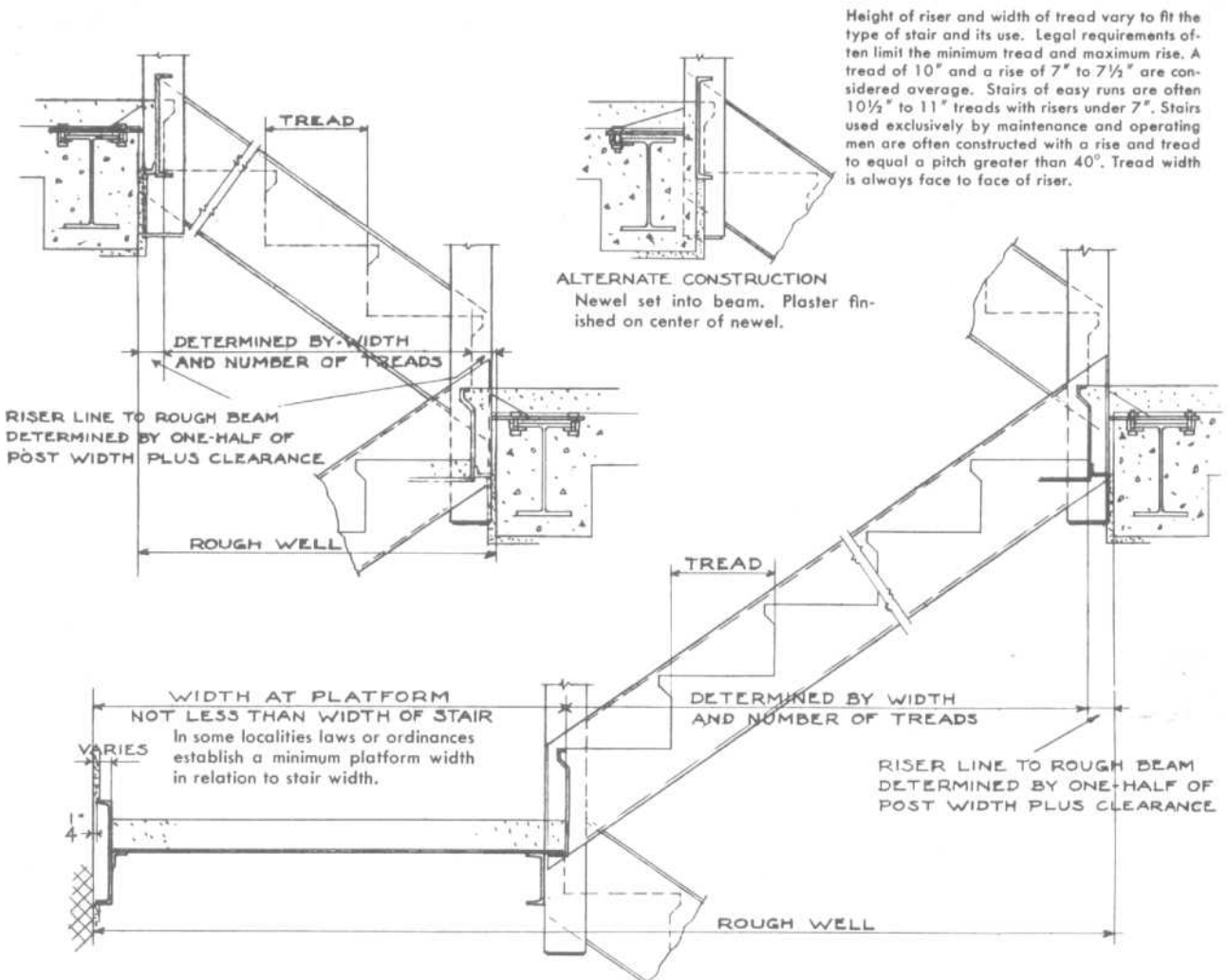


STAIRS

Stairwell



METHOD OF ESTABLISHING THE WIDTH OF A STAIR WELL



METHOD OF ESTABLISHING THE LENGTH OF A STAIR WELL



**REFER TO GOVERNING CODES TO ESTABLISH DIMENSIONS**

Width of stair is usually measured from inside face of balusters or newel to finished wall. However, governing codes should be consulted for points of measurement.

3½" maximum projection into required egress width. If more than 3½", egress width should be increased by the excess of projection over 3½".

Minimum 1½" hand clearance between rails, and between handrail and wall, or other obstructions.

A minimum clearance of ¼" should be allowed between edge of stringer and wall.

STAIR WELL WIDTH — DISTANCE BETWEEN WALLS

Minimum code requirements are usually measured from finished wall to finished wall. When establishing rough stair well dimensions, allowance should be made for thicknesses of any finish materials to be applied to the rough walls.

Platform width not less than width of stair, usually measured from inside face of balusters or newel to finished wall. However, governing codes should be consulted for points of measurement.

All handrailing heights to meet minimum requirements of governing codes.

A minimum clearance of ¼" should be allowed between edge of stringer and wall.

Varies; recommended minimum 1½"

Length determined by tread run and number of treads required by code.

Varies; recommended minimum 1½"

STAIR WELL WIDTH — DISTANCE BETWEEN WALLS

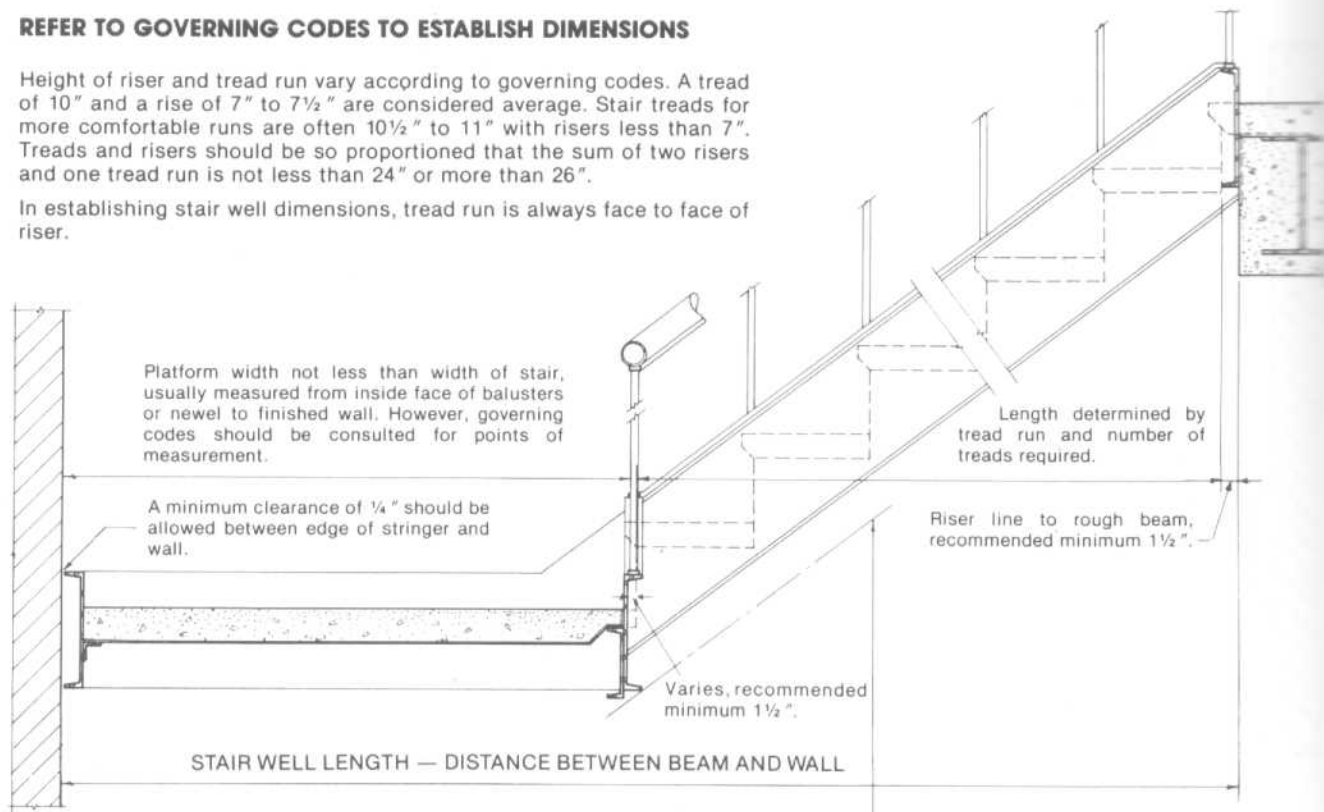
**STAIRS**

Stair Length Dimensions

**REFER TO GOVERNING CODES TO ESTABLISH DIMENSIONS**

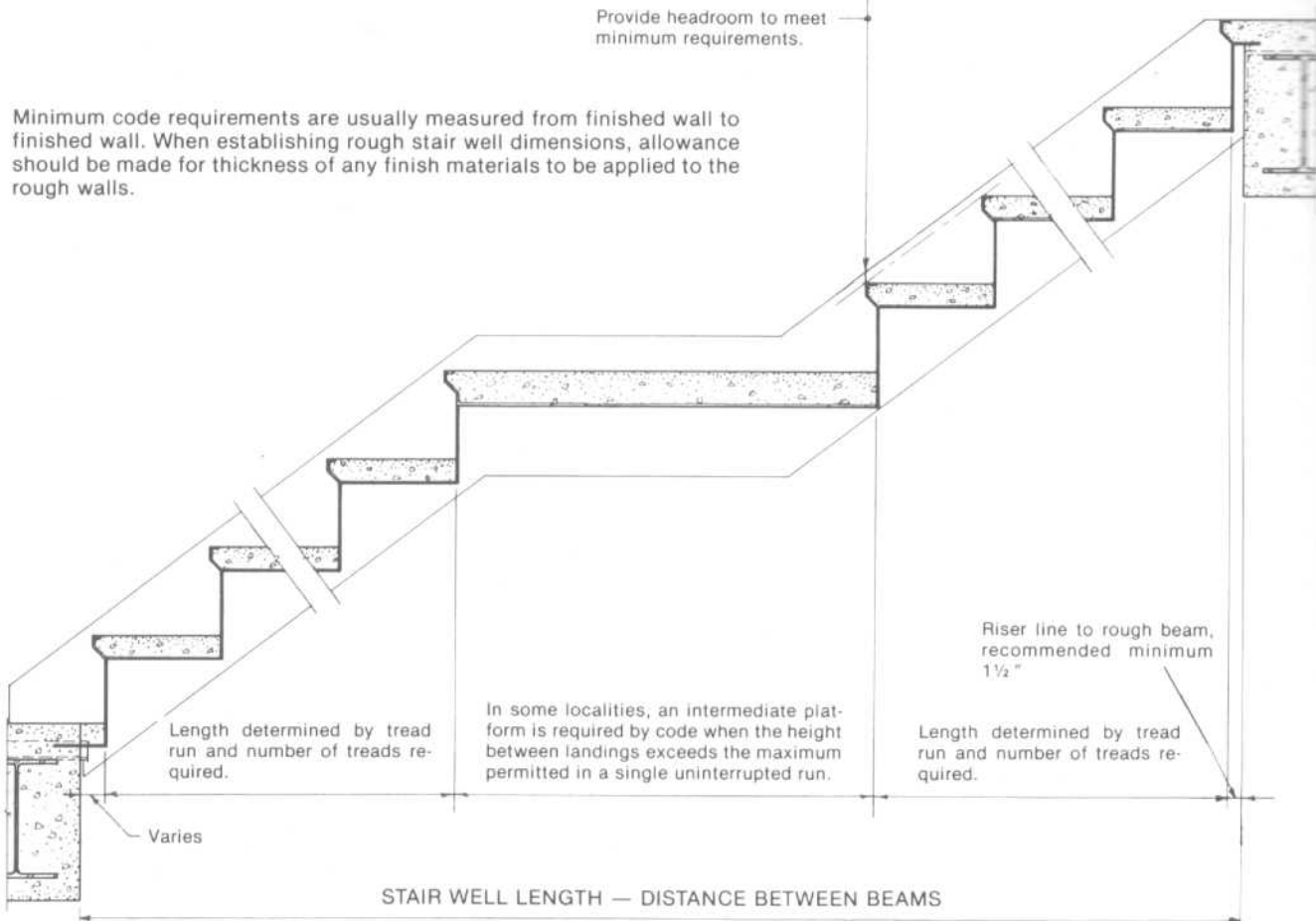
Height of riser and tread run vary according to governing codes. A tread of 10" and a rise of 7" to 7½" are considered average. Stair treads for more comfortable runs are often 10½" to 11" with risers less than 7". Treads and risers should be so proportioned that the sum of two risers and one tread run is not less than 24" or more than 26".

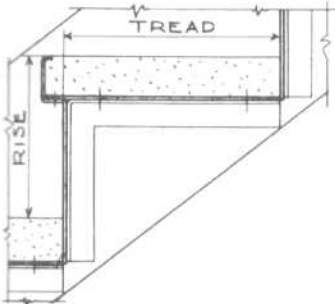
In establishing stair well dimensions, tread run is always face to face of riser.



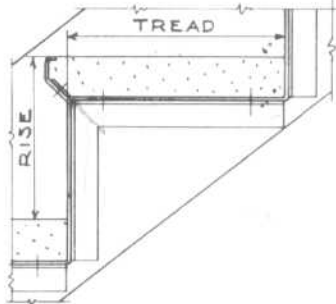
Provide headroom to meet minimum requirements.

Minimum code requirements are usually measured from finished wall to finished wall. When establishing rough stair well dimensions, allowance should be made for thickness of any finish materials to be applied to the rough walls.

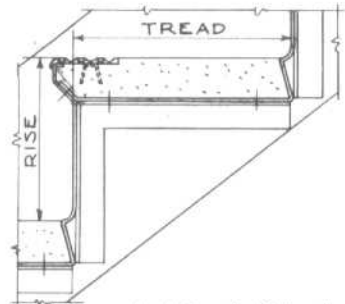




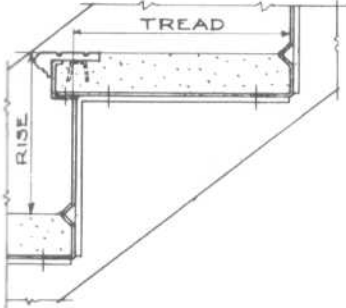
Steel riser and sub tread with formed nosing, angle supporting brackets.



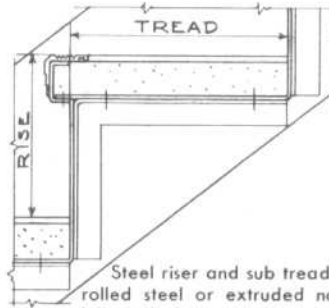
Steel riser and sub tread with formed nosing, sanitary cove, angle supporting brackets.



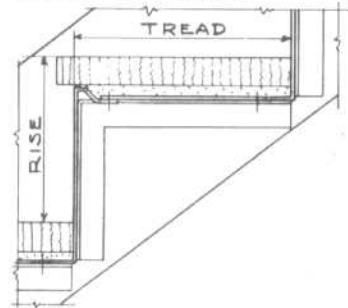
Steel riser and sub tread with lead filled safety nosing, sanitary cove, angle supporting brackets.



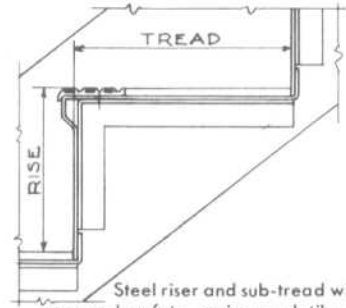
Steel riser and sub tread with abrasive safety nosing, sanitary cove, flat bar supporting brackets.



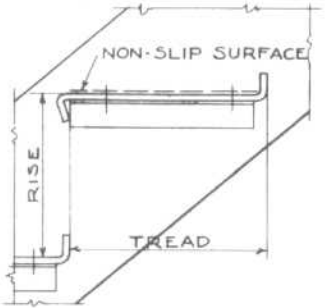
Steel riser and sub tread with rolled steel or extruded nosing and tile or linoleum tread, angle supporting brackets. Other types of safety nosing or tread covering may be used.



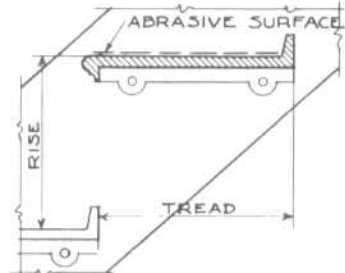
Steel riser and sub tread with marble, or pre-cast tread, angle supporting brackets.



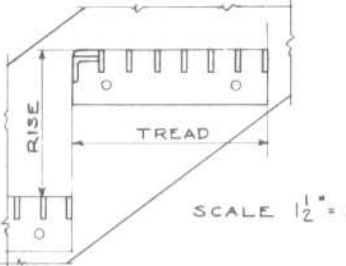
Steel riser and sub-tread with grooved safety nosing and tile or linoleum fill, angle supporting bracket. Other types of safety nosing or tread covering may be used.



Steel floor plate tread, angle tread bracket, with or without steel riser.

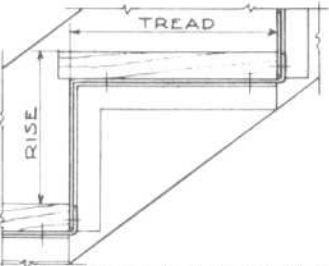


Cast metal abrasive tread, with or without steel riser.

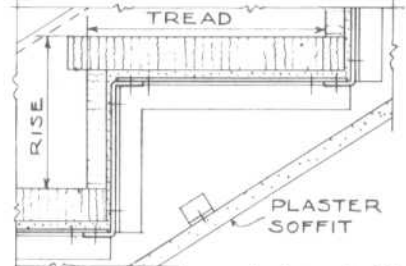


Grating Tread.

SCALE  $\frac{1}{2}'' = 1'-0''$



Steel riser and sub tread with pre-cast or wood treads, angle supporting brackets.



Steel sub-riser and sub tread with marble tread and riser, angle supporting brackets.

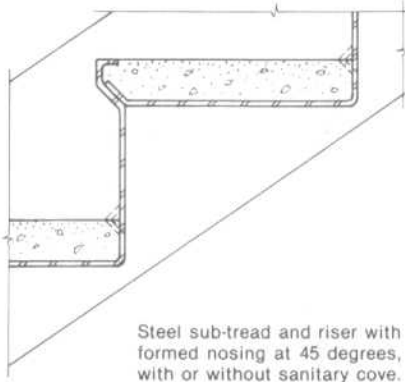
Stairs with concrete or terrazzo fill may be constructed with the top of supporting bracket 2" below the tread surface and 3" below the platform surface. These thicknesses may be less for narrow stairs or where use is limited.

Fill is always considered the distance from string bracket to finish tread.

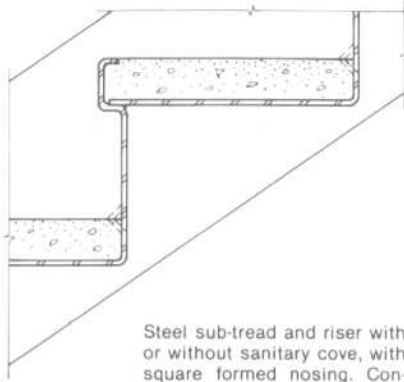
Treads and riser brackets may be  $1\frac{1}{4}'' \times 1\frac{1}{4}'' \times \frac{3}{16}''$  or  $\frac{1}{8}''$  angles, welded or riveted to string, or  $\frac{1}{4}'' \times 1\frac{1}{4}''$  bar welded. Treads and risers are usually bolted to brackets with round head bolts. Cast or grating treads are usually bolted to strings with two  $\frac{3}{8}''$  bolts at each end. Brackets back of risers may be omitted when more economical construction is desired.

STAIRS

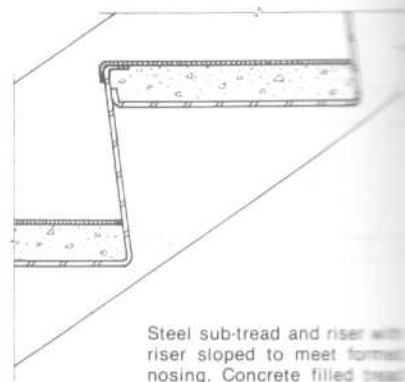
Tread Sections



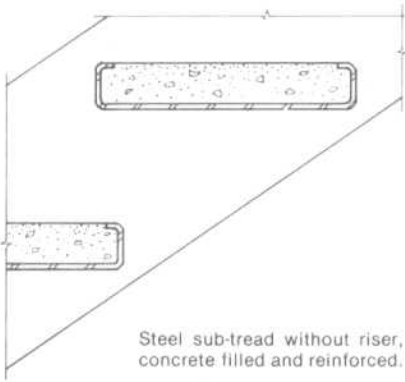
Steel sub-tread and riser with formed nosing at 45 degrees, with or without sanitary cove. Concrete filled tread.



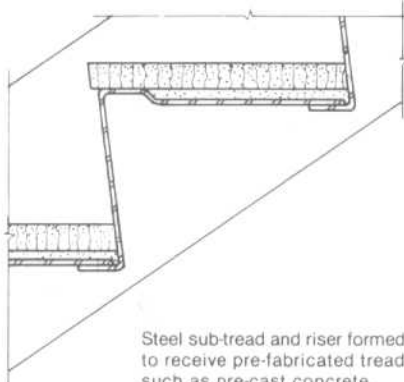
Steel sub-tread and riser with or without sanitary cove, with square formed nosing. Concrete filled tread.



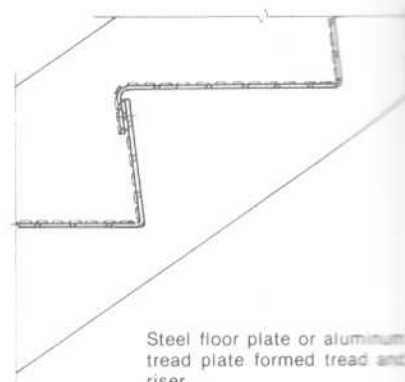
Steel sub-tread and riser with riser sloped to meet formed nosing. Concrete filled tread with resilient tile covering.



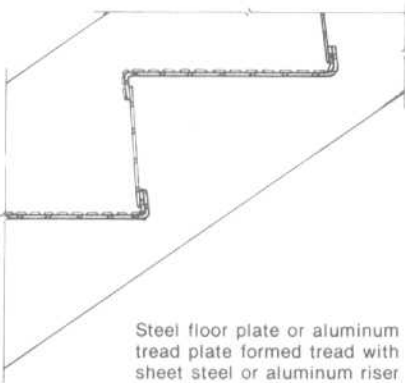
Steel sub-tread without riser, concrete filled and reinforced.



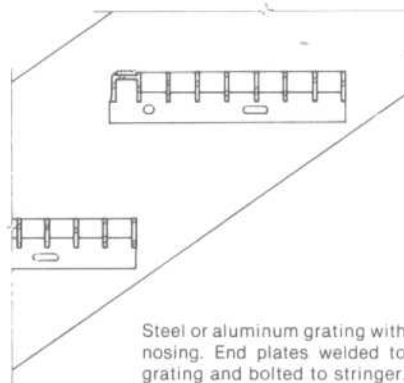
Steel sub-tread and riser formed to receive pre-fabricated tread such as pre-cast concrete.



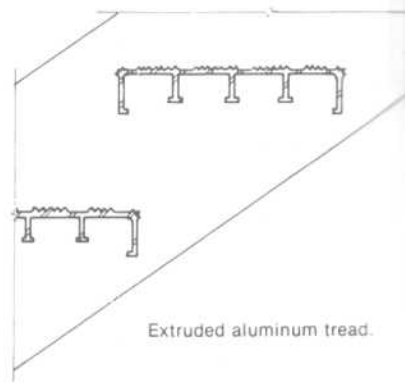
Steel floor plate or aluminum tread plate formed tread and riser.



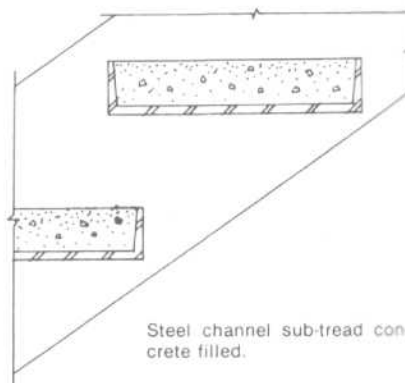
Steel floor plate or aluminum tread plate formed tread with sheet steel or aluminum riser optional.



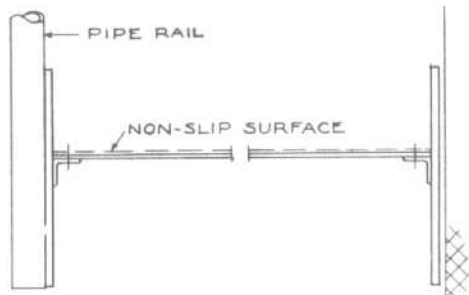
Steel or aluminum grating with nosing. End plates welded to grating and bolted to stringer.



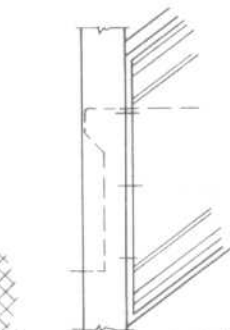
Extruded aluminum tread.



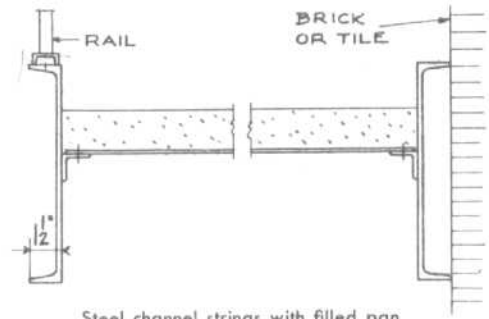
Steel channel sub-tread concrete filled.



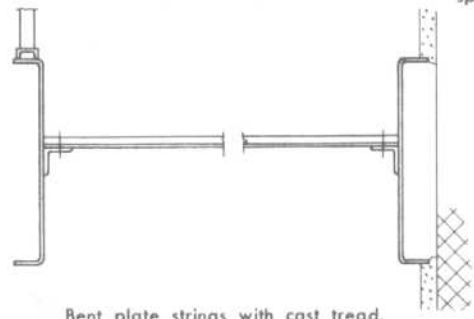
Flat plate strings with floor plate tread and pipe railing.



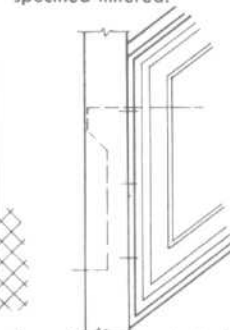
Face string at post. Moldings not mitered unless shown or specified mitered.



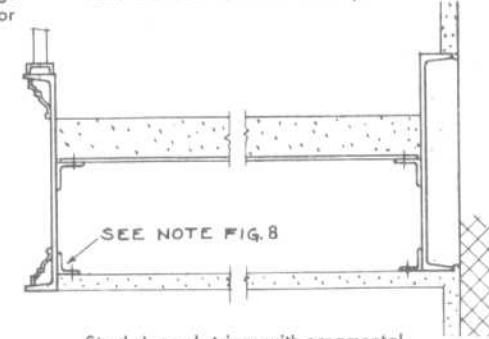
Steel channel strings with filled pan type tread. The stair should be installed before the face brick or tile walls are built to insure close joints.



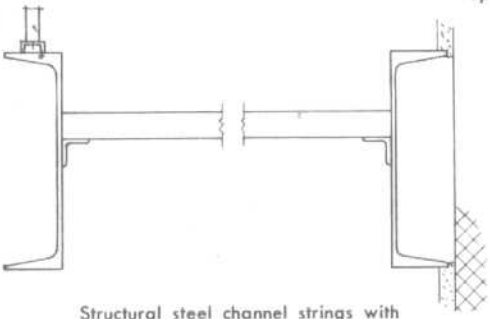
Bent plate strings with cast tread, with or without abrasive.



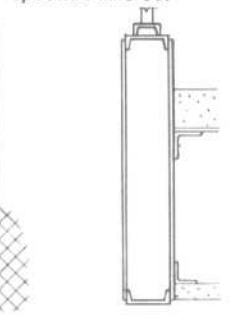
Face string at post. Moldings mitered only when shown or specified mitered.



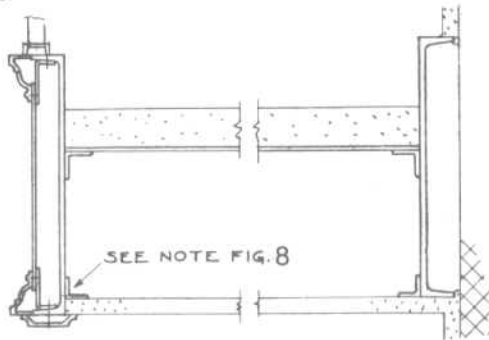
Steel channel strings with ornamental molding on face string and channel wall string; plastered soffit.



Structural steel channel strings with grating type treads.



Box type face string of two plates and two channels.

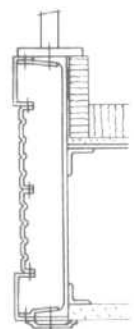


Box type face string of channel, plate and moldings; channel wall string.

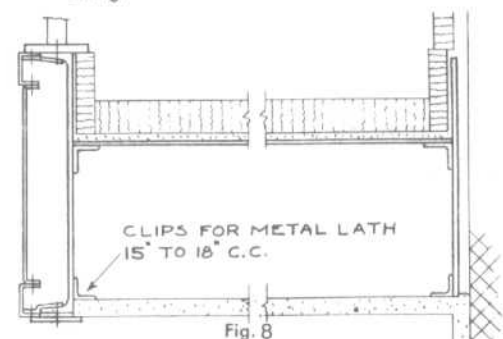
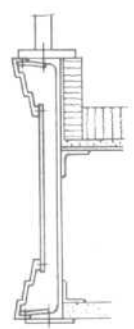
These string sections include a majority of the various types of strings employed for steel stairs. Other types also are used, and other methods of combining with railings are sometimes desired.

The various types of trim moldings shown are only illustrative of the possibilities of design. The various forms of box type strings shown illustrate several methods of accomplishing this type of construction.

Because of the great number of extrusion and rolling dies now in use for the manufacture of moldings of steel, aluminum, bronze and other metals, the architectural plans should give the manufacturers molding numbers selected. If the moldings shown are designed specially for the project the plans should so state.



Box type face strings.

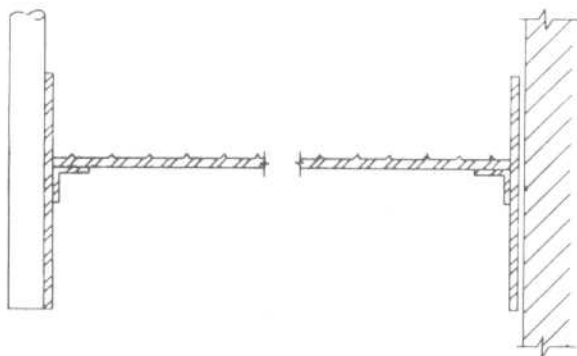


Box type face string of steel channel and ferrous or non-ferrous exposed face; steel plate wall string.

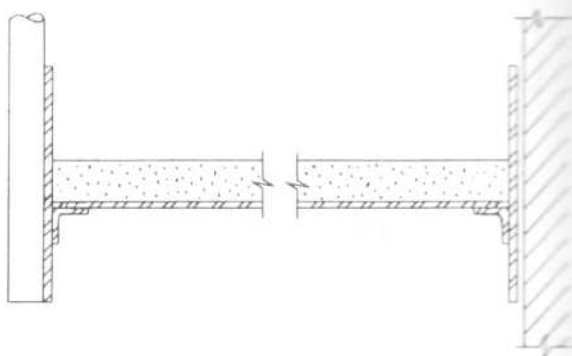
Fig. 8

STAIRS

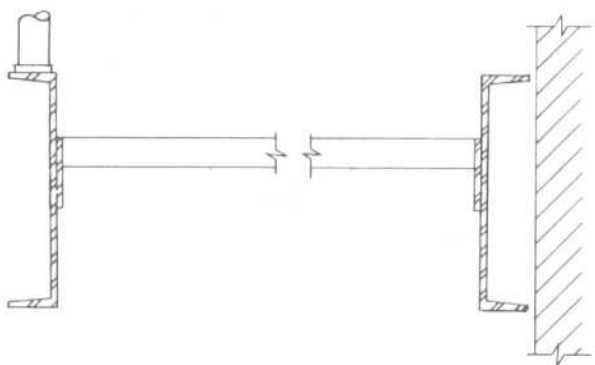
Stringer Sections



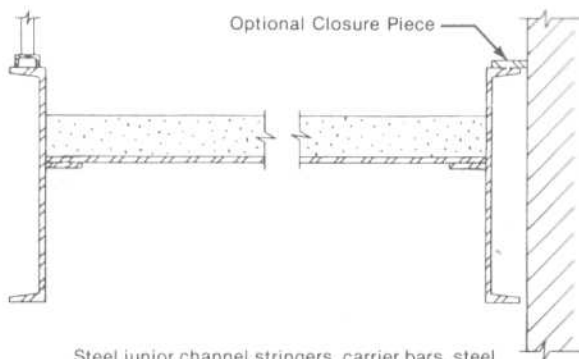
Steel plate stringers, carrier angles, floor plate treads, pipe railing on side of face stringer. Aluminum tread plate may be used when specified. Wall not plastered.



Steel plate stringers, carrier angles, steel sub-tread and riser, concrete filled tread. Pipe railing on side of face stringer, wall not plastered.



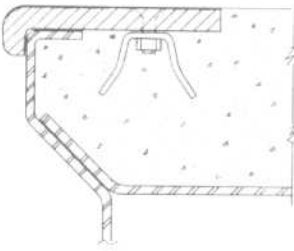
Standard steel channel stringers, grating tread bolted or welded to stringer, pipe railing bolted or welded to top flange of face stringer. Wall not plastered.



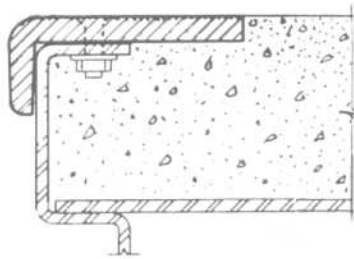
Steel junior channel stringers, carrier bars, steel sub-tread and riser. Concrete filled tread. Railing with bottom channel fastened to top flange of face stringer. Optional closure piece fastened to top flange of wall stringer in the field. Wall not plastered.

STAIRS

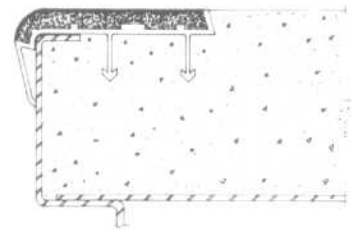
Abrasive Nosings and Treads



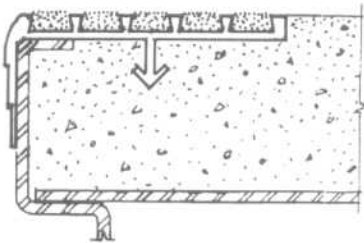
Cast abrasive nosing with short lip, available in iron, bronze or aluminum as specified. Standard drilling with wing anchors, bolts and nuts or drilled as required.



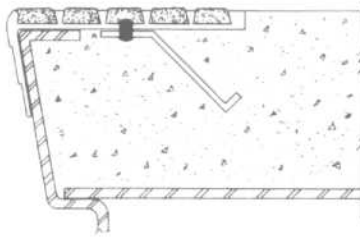
Cast abrasive nosing with deep lip, available in iron, bronze or aluminum as specified. Standard drilling with wing anchors, bolts and nuts or drilled as required.



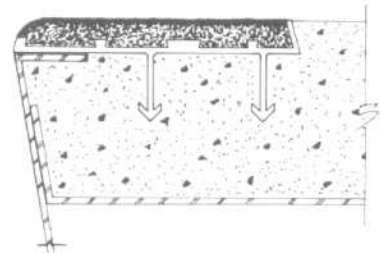
Extruded aluminum base with epoxy top, containing abrasive. Available in colors. Integral anchors for fresh concrete. Also available drilled to specifications without the anchors.



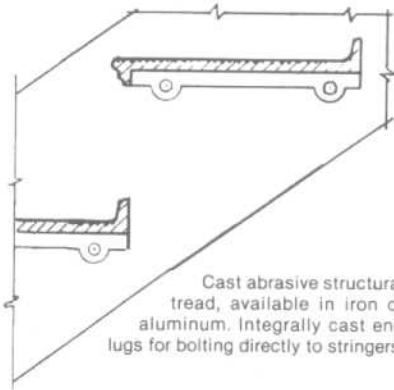
Extruded aluminum or brass with abrasive filled ribs. Concealed integral anchor runs full length of tread. Also available drilled to specifications, without the integral anchor.



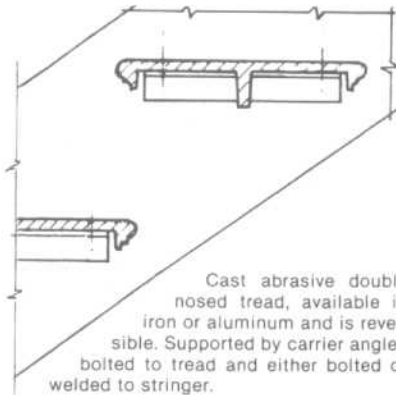
Extruded aluminum with abrasive ribs. Special design for pan stairs with sloped risers. Drilled to specification or furnished with strap anchors or wing anchors.



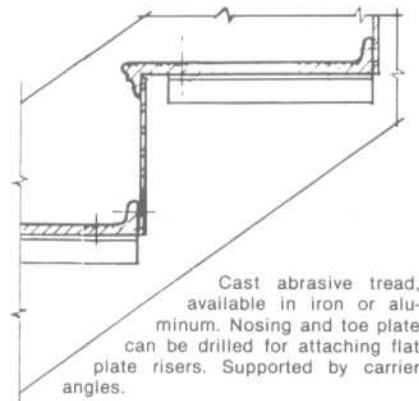
Barrier free design to meet standards for the physically handicapped. Aluminum base with epoxy containing abrasive top. Integral anchors for fresh concrete.



Cast abrasive structural tread, available in iron or aluminum. Integrally cast end lugs for bolting directly to stringers.



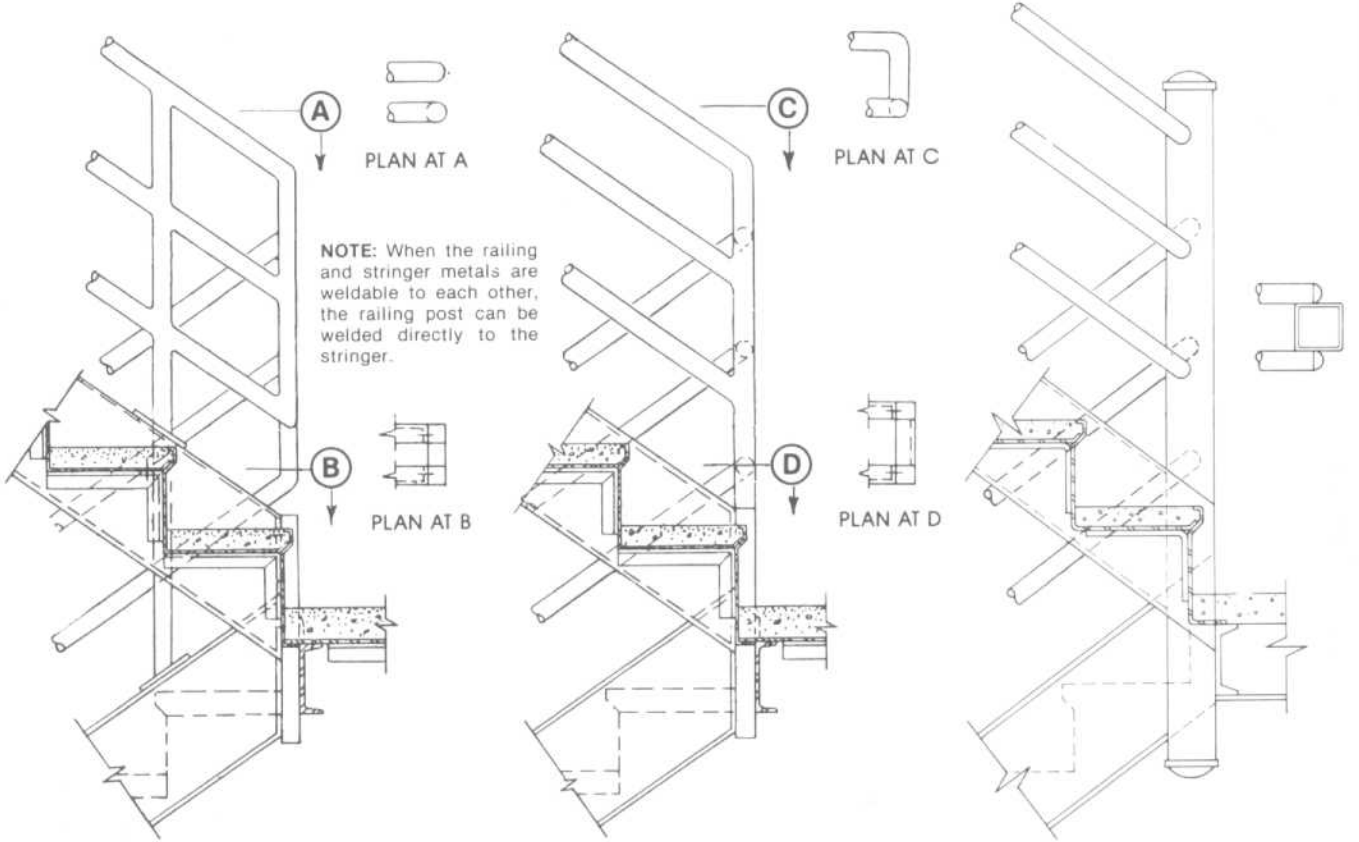
Cast abrasive double nosed tread, available in iron or aluminum and is reversible. Supported by carrier angles bolted to tread and either bolted or welded to stringer.



Cast abrasive tread, available in iron or aluminum. Nosing and toe plate can be drilled for attaching flat plate risers. Supported by carrier angles.

STAIRS

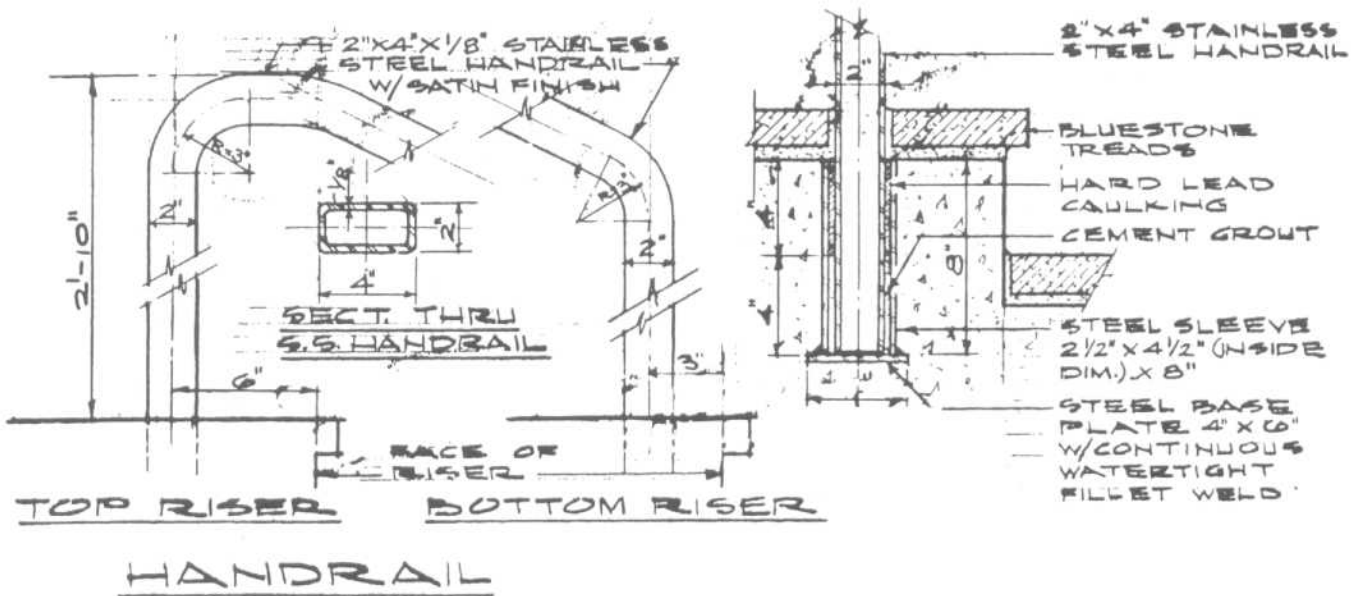
Handrails



Stair platform or landing with pipe railings, railings not connected, for stairwell having minimum clearance. Short newels, supported on header.

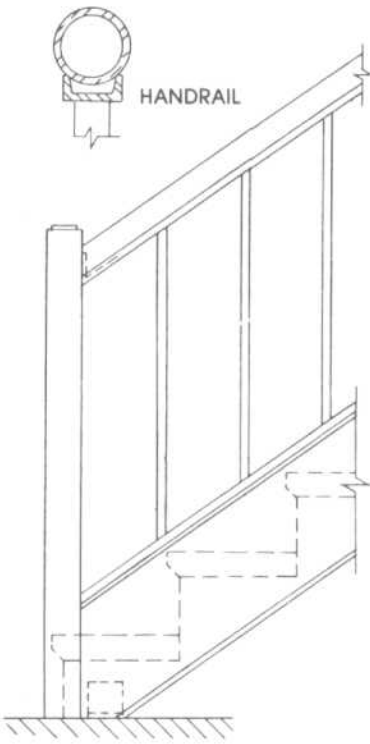
Stair platform or landing with pipe railing, one post at return. Lower rail returned into post, two or more posts used at wide wells. Short newels, supported on header.

Stair platform or landing with rectangular or square newel, pipe railing members capped and welded to newel post.

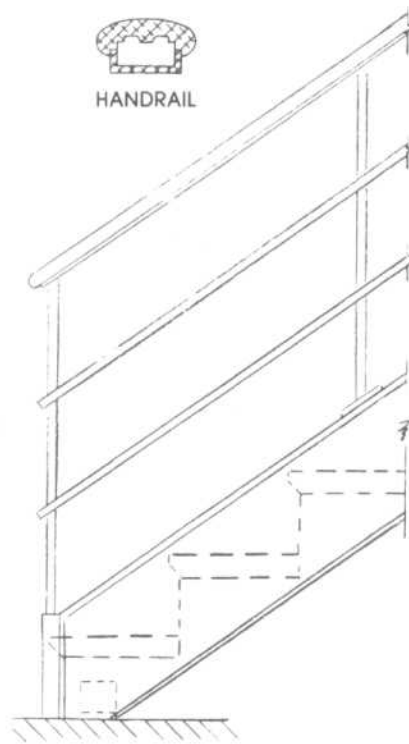




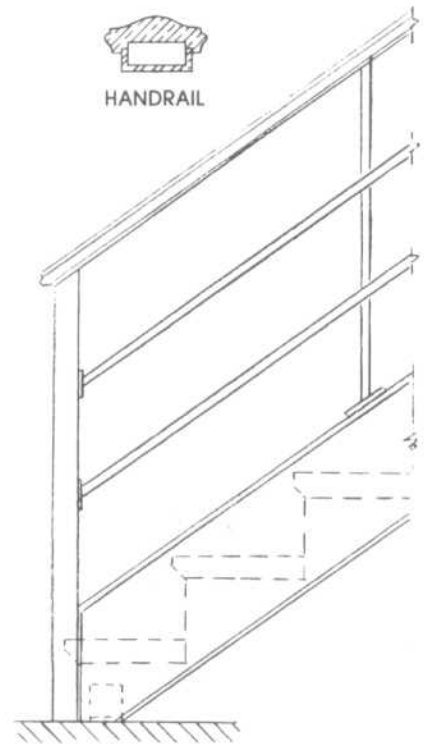
**STAIRS**  
Newels and Railings



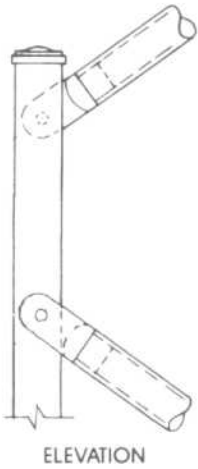
Stair start with square newel, baluster type railing with channel top and bottom, pipe handrail.



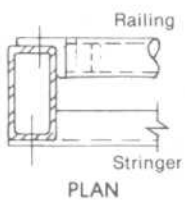
Stair start with short newel, parallel bar type railing with end and intermediate posts of square, rectangular or round section, extruded handrail with mitered, forged or cast terminal.



Stair start with square newel, parallel bar type railing with intermediate posts of square, rectangular or round section; extruded or rolled handrail section mitered to form cap over newel.

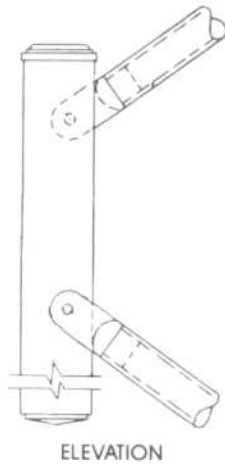


ELEVATION

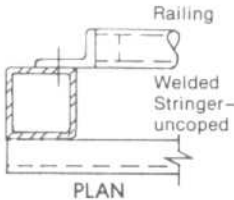


PLAN

Square or rectangular newel, pipe rail fitted with offset lug to center on stringer.

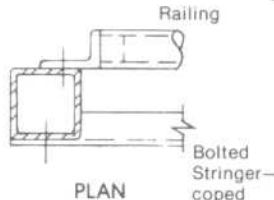


ELEVATION



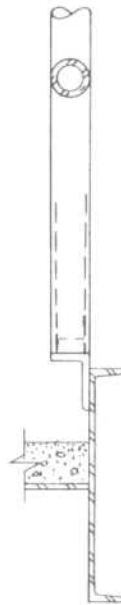
PLAN

Square or rectangular newel, pipe rail fitted with offset lug for positioning inside of stringer.

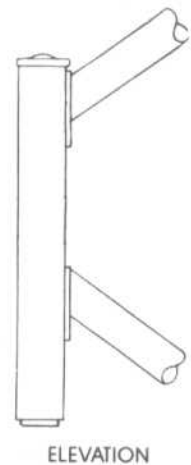


PLAN

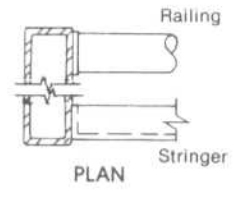
Bolted Stringer—coped



Section showing fastening for intermediate posts to stringers.



ELEVATION

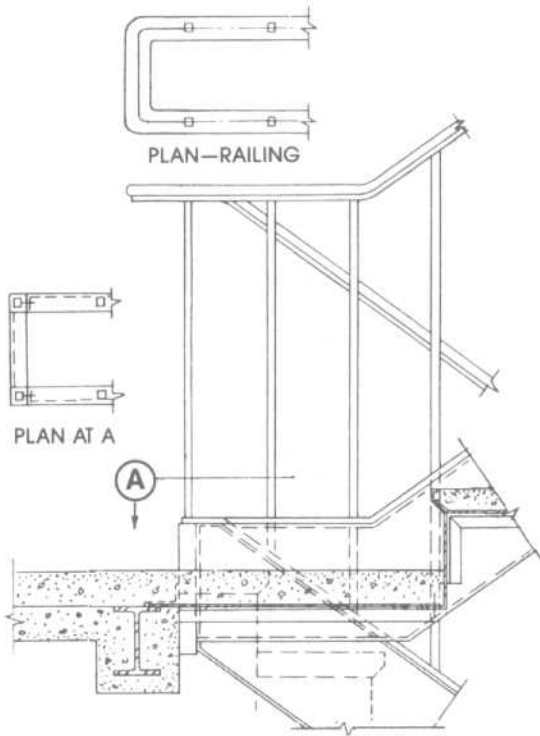


PLAN

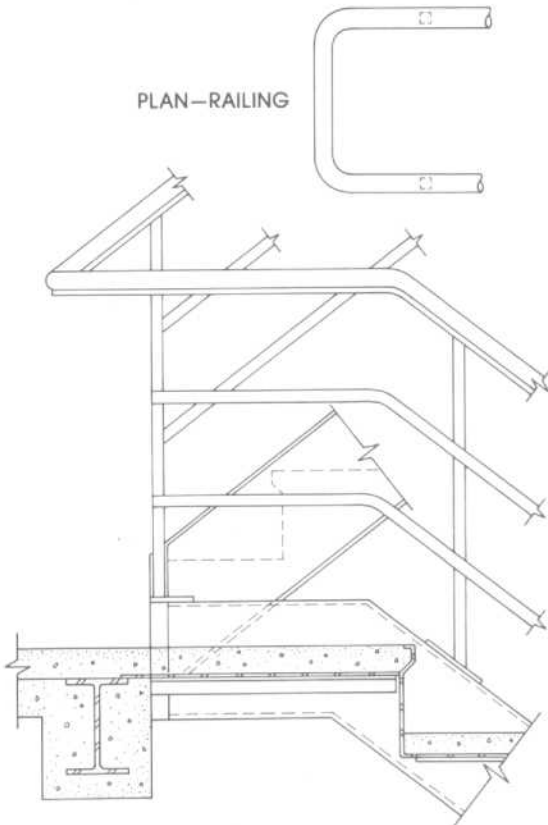
Rectangular newel, pipe rail and stringer welded or bolted to face.

STAIRS

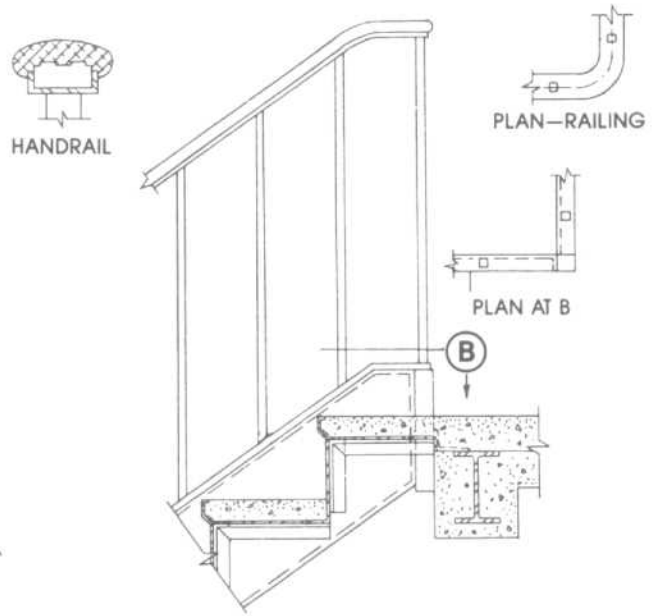
Newels and Railings



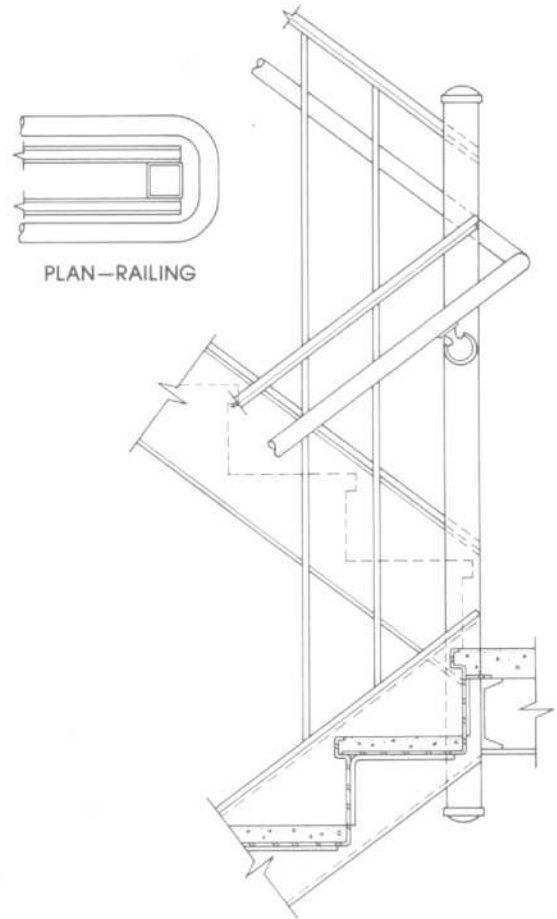
Stair landing with stringers and fascia framed square. Square railing return, end balusters centered on newels and landing extended on up flight to set-back riser.



Stair landing with stringers and fascia framed square. Radius railing return, parallel bar type railing with end balusters centered on newels. Landing extended on down flight to set-forward riser.



Stair landing, with stringer and fascia at right angle. Landing extended on down flight to set-forward riser, producing easement in handrail.



Stair landing with stringers and fascia framed into full height newel, baluster railing with channel top and bottom. Continuous pipe handrail offset from balusters and newels by brackets.

Figures 9 and 10 indicate typical railings for decks, platforms, balconies, roofs, and similar locations, adapted for residential, apartment, or hotel construction. These railings may be fastened with wood screws or lag bolts to wood, or with expansion bolts to masonry. On roofs or decks the setting of the post bases should be waterproofed.

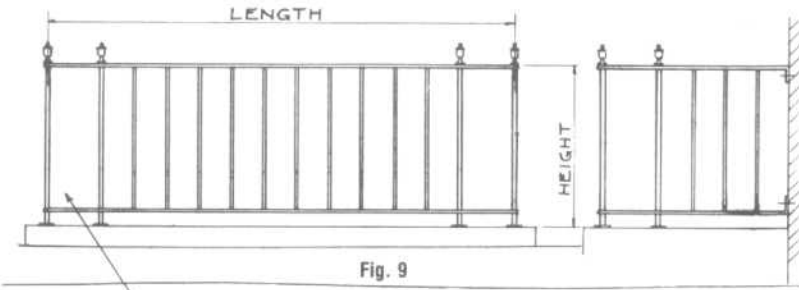


Fig. 9

SPACE FOR ORNAMENT  
DESIGN BY ARCHITECT

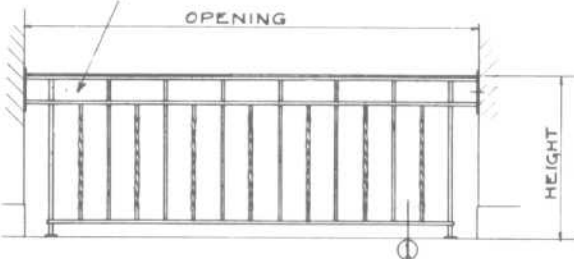
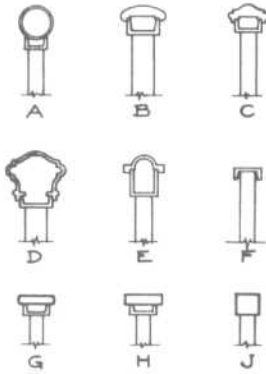
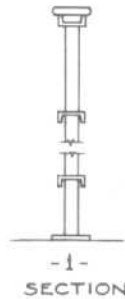


Fig. 10



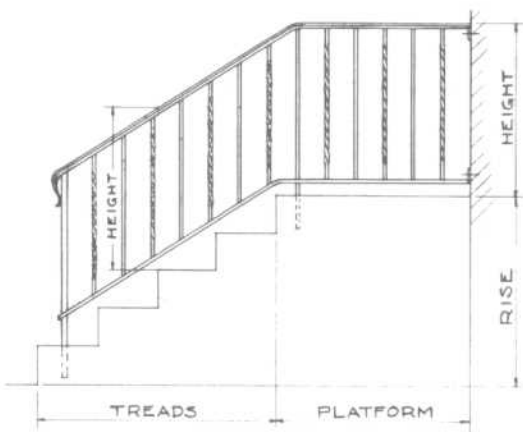
Methods of constructing railing top members.

SCALE  $1\frac{1}{2}'' = 1'-0''$

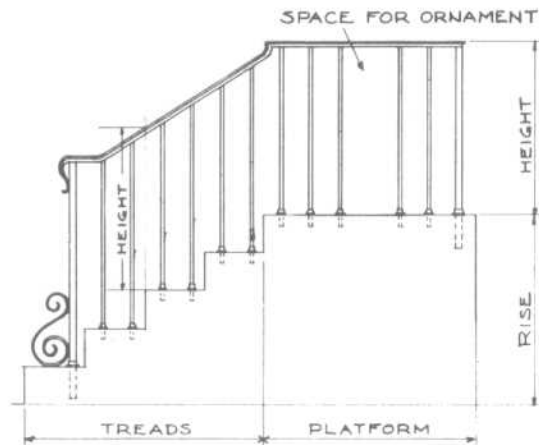
**TO SPECIFY:**

- Give locations.
- Indicate kind of metal.
- Specify finish.
- Give sizes of members.
- Give height.
- Provide scale details of ornaments, finials and bases.

Specify method of fastening, or have fabricator provide fastenings best suited to each condition.



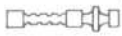
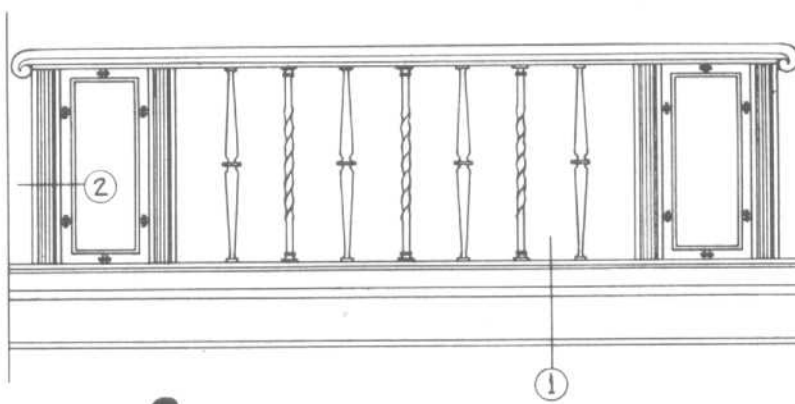
Railing with balusters and bottom longitudinal member supporting balusters. Posts extending into masonry.



Railing without bottom longitudinal member, each baluster set in masonry and fitted with slip flange or base. Masonry specifications should specify holes.

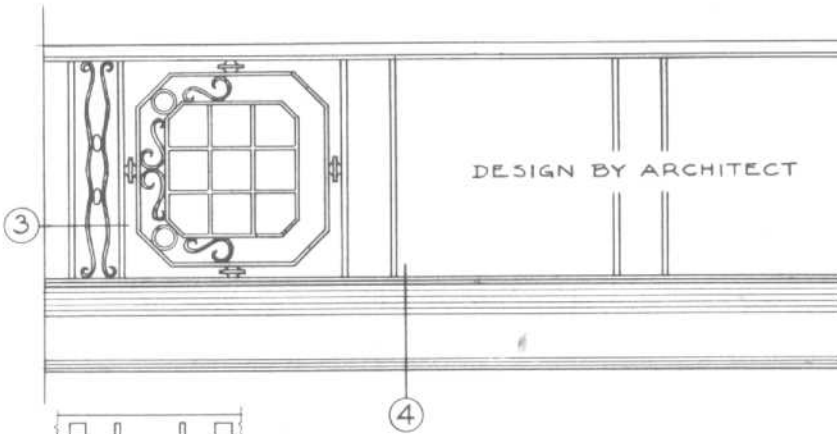
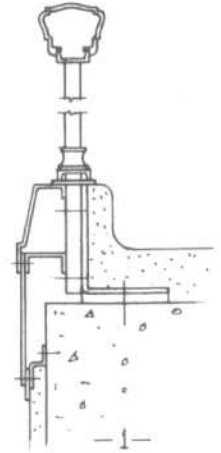
STAIRS

Ornamental Railings



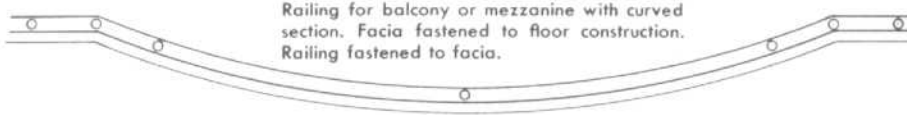
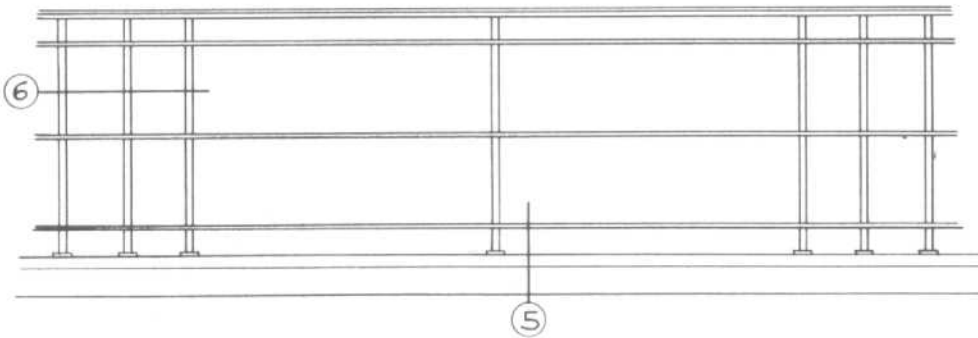
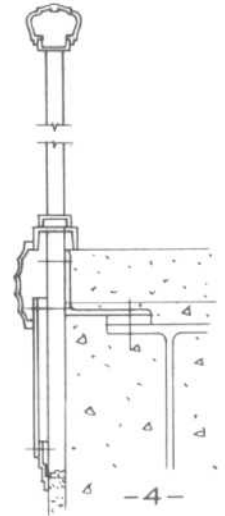
Railing panels set between columns or jambs. Posts extended to floor construction for support.

-2-



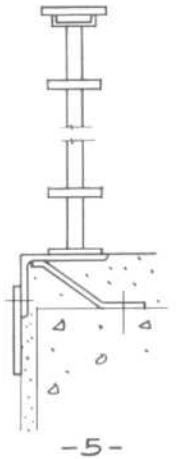
Railing for balcony or mezzanine with double posts and panels. Posts extended to support fascia and fastened to floor construction.

-3-



Railing for balcony or mezzanine with curved section. Fascia fastened to floor construction. Railing fastened to fascia.

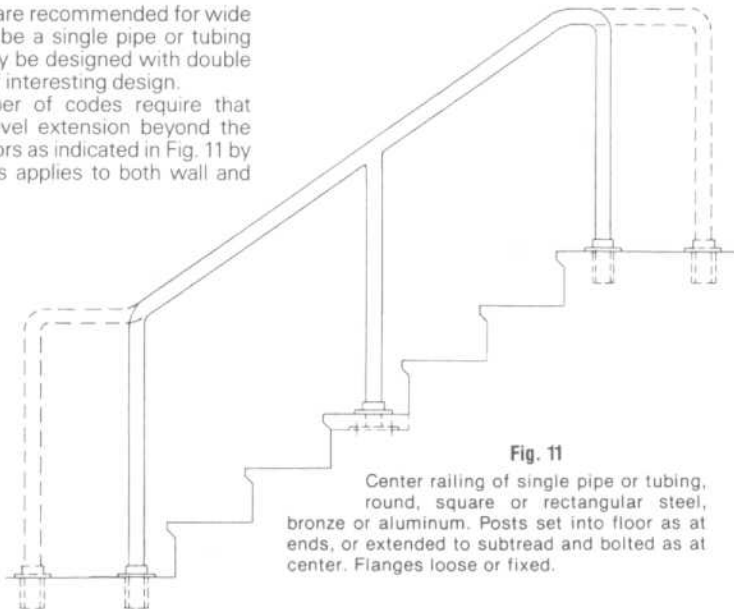
-6-



-5-

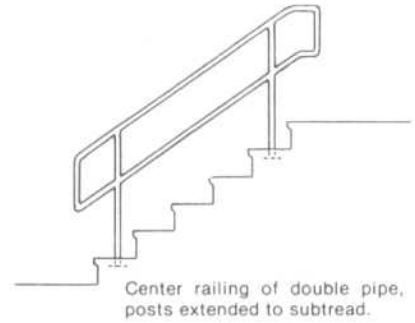
Center railings are recommended for wide stairs. They may be a single pipe or tubing railing or they may be designed with double rails and panels of interesting design.

*Note:* A number of codes require that railings have a level extension beyond the nosings at the floors as indicated in Fig. 11 by dashed lines. This applies to both wall and center railings.

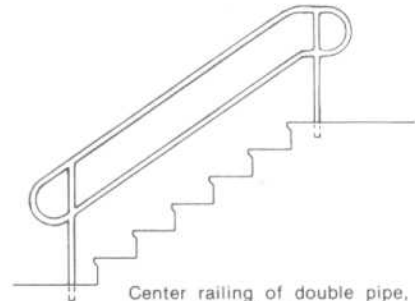


**Fig. 11**

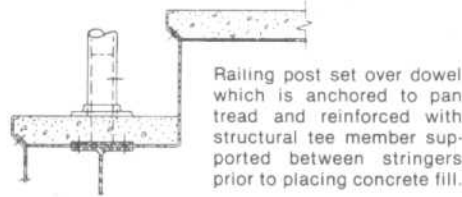
Center railing of single pipe or tubing, round, square or rectangular steel, bronze or aluminum. Posts set into floor as at ends, or extended to sub-tread and bolted as at center. Flanges loose or fixed.



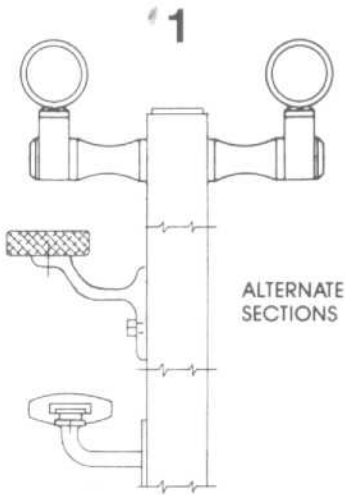
Center railing of double pipe, posts extended to sub-tread.



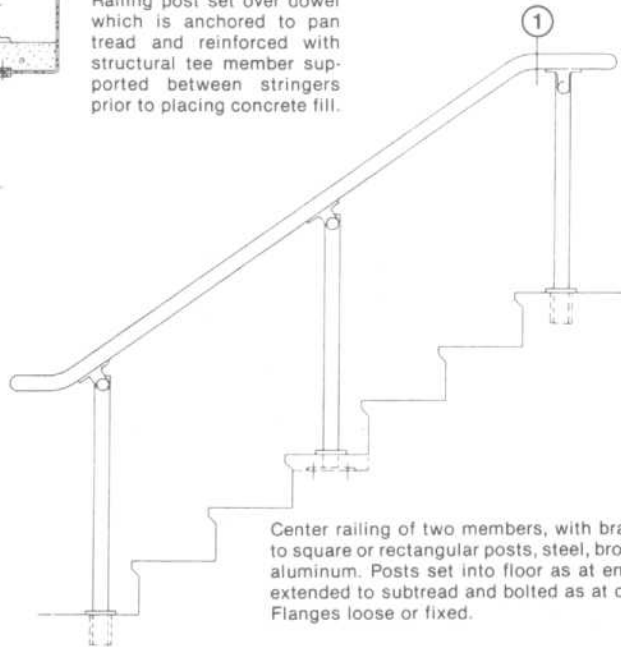
Center railing of double pipe, posts set into floor.



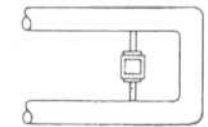
Railing post set over dowel which is anchored to pan-tread and reinforced with structural tee member supported between stringers prior to placing concrete fill.



**ALTERNATE SECTIONS**

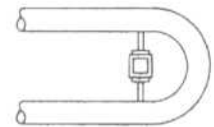


Center railing of two members, with brackets to square or rectangular posts, steel, bronze or aluminum. Posts set into floor as at ends, or extended to sub-tread and bolted as at center. Flanges loose or fixed.



**PLAN A**

Handrail with square return mitered.

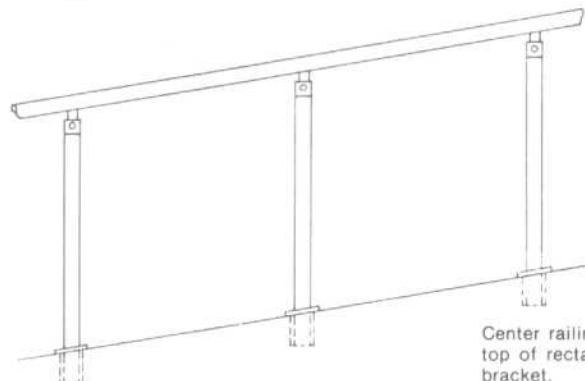


**PLAN B**

Handrail with round return.



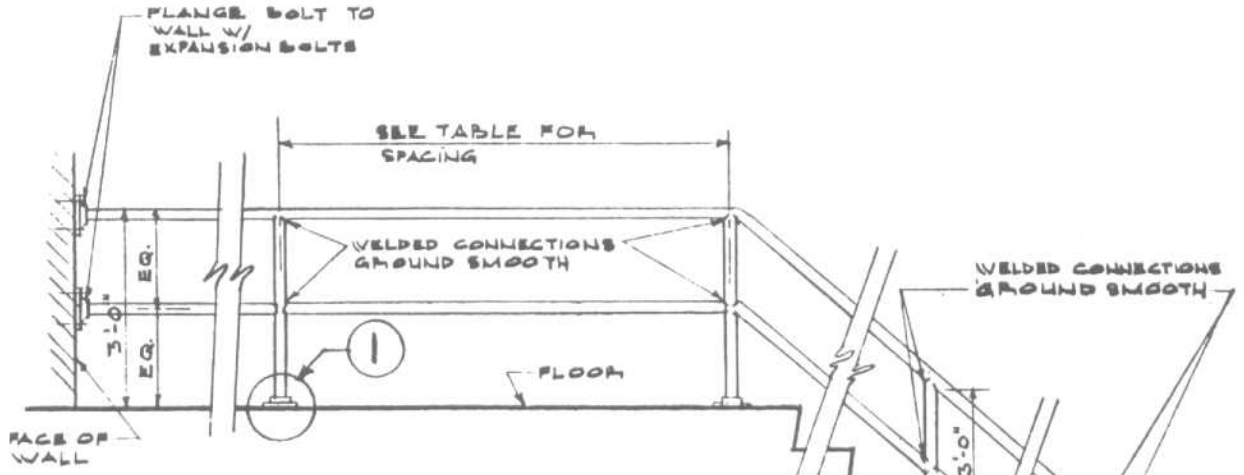
**HINGED BRACKET**



Center railing of single member centered on top of rectangular post by means of hinged bracket.

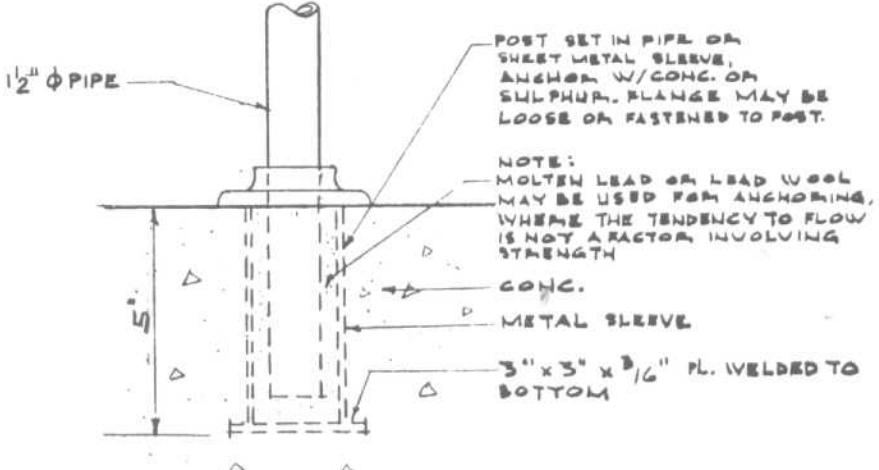
Non-ferrous or stainless steel sleeves may be used on exterior rails to prevent staining masonry or concrete.

STAIRS  
Railings

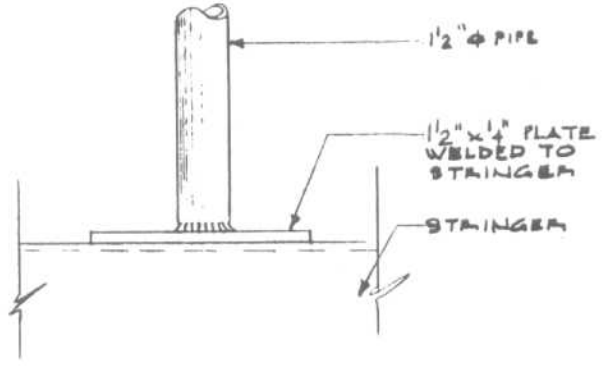


**ELEVATION OF WELDED PIPE RAILING**

Ⓢ 3" = 1'-0"



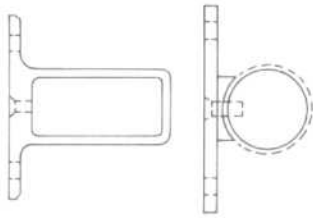
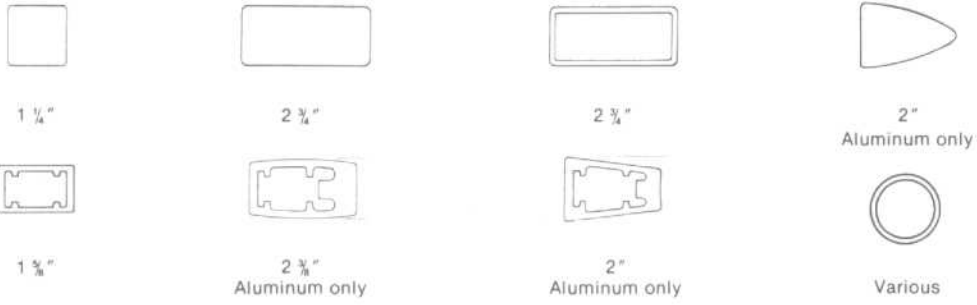
**I** Ⓢ 3" = 1'-0"



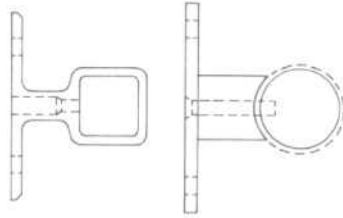
**WELDED PIPE RAILING DETAIL FOR STEEL STAIRS**  
Ⓢ 3" = 1'-0"

RECOMMENDED POST SPACING FOR PIPE RAILING	
SIZE OF PIPE	MAXIMUM SPACING
3/4"	4'
1"	6'
1 1/4"	7'
1 1/2"	8'
2"	9'
2 1/2"	10'
3"	10'

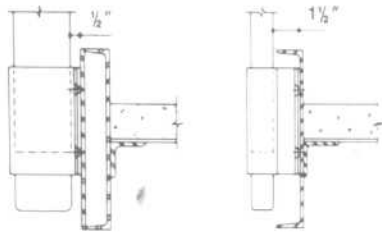
**TYPICAL EXTRUDED ALUMINUM AND BRONZE POST SECTIONS**



Flanges for box and solid stringers.

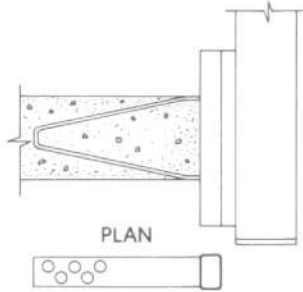


Flanges for channel stringers.

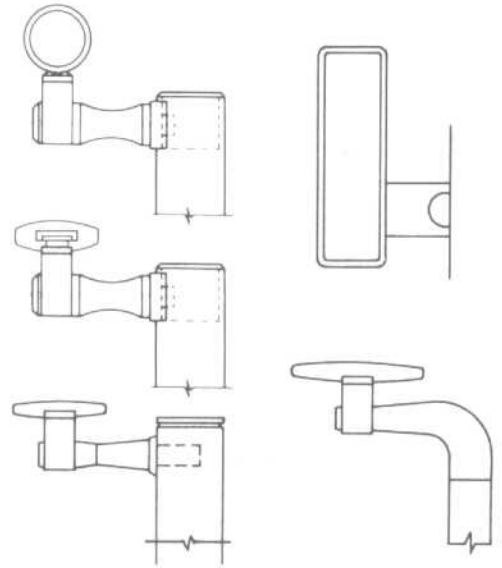


Post mounted on box stringer.

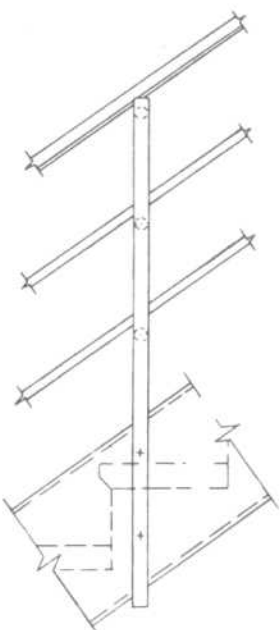
Post mounted on channel stringer.



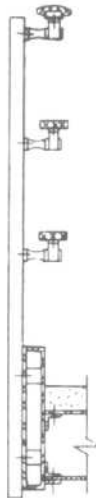
Post mounted on concrete step using post anchor.



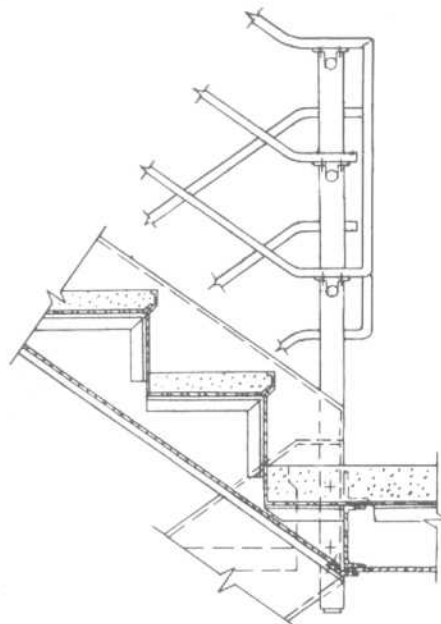
Sections — Railing posts with brackets.



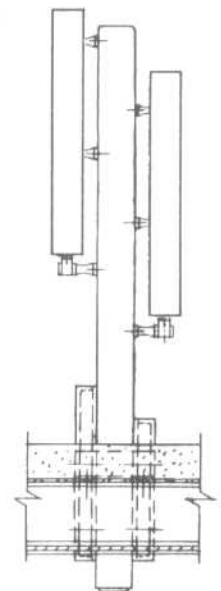
Elevation; intermediate post set on face of box stringer.



**Fig. 12**  
Section; intermediate post set on face of box stringer.



Stair landing with box stringers attached to sides of newel, parallel type bar railing supported by brackets at newels and intermediate posts. Risers offset to allow metal soffits of stair to meet at intersection with soffit of landing. Bottom and top rails must be the same and have symmetrical cross section to obtain proper mitered connection.



**Fig. 13** Elevation of Fig. 12: rectangular newel post.

STAIRS

Handrail Sections

TYPICAL EXTRUDED ALUMINUM AND BRONZE HANDRAIL SECTIONS

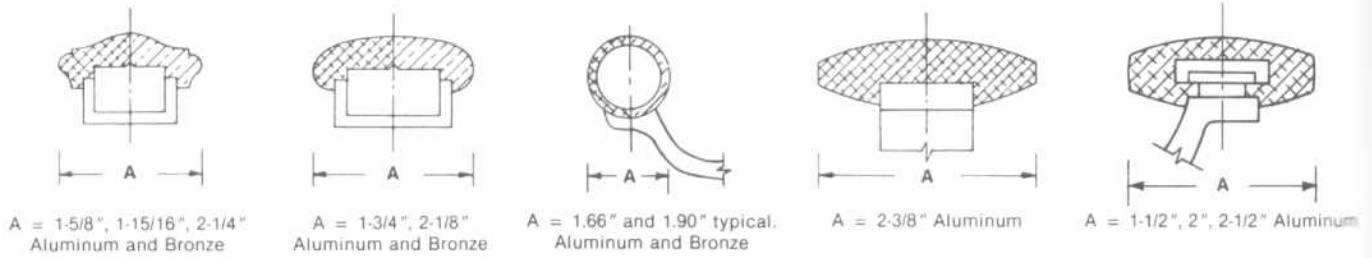
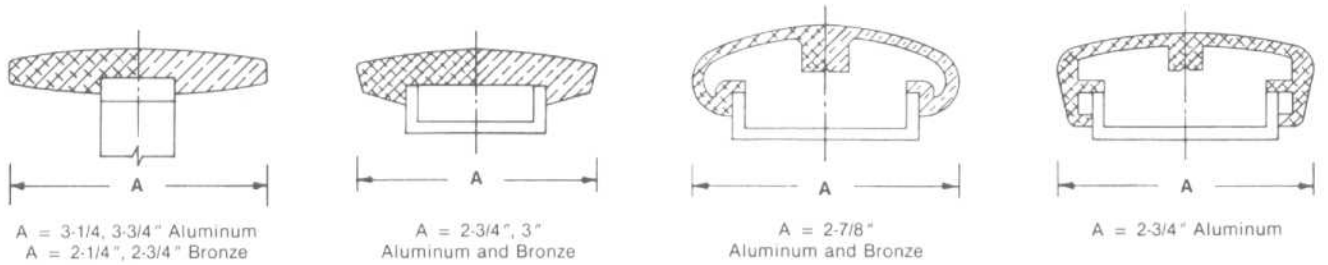


Fig. 14



Most of these sections can be mounted on channels or flats, secured by screws from below. Some are designed for mounting on handrail brackets. The use of channels instead of solid bars often simplifies the attachment of baluster and ornaments. The channels may be of the same or a different metal.

TYPICAL ROLLED STEEL HANDRAIL SECTIONS

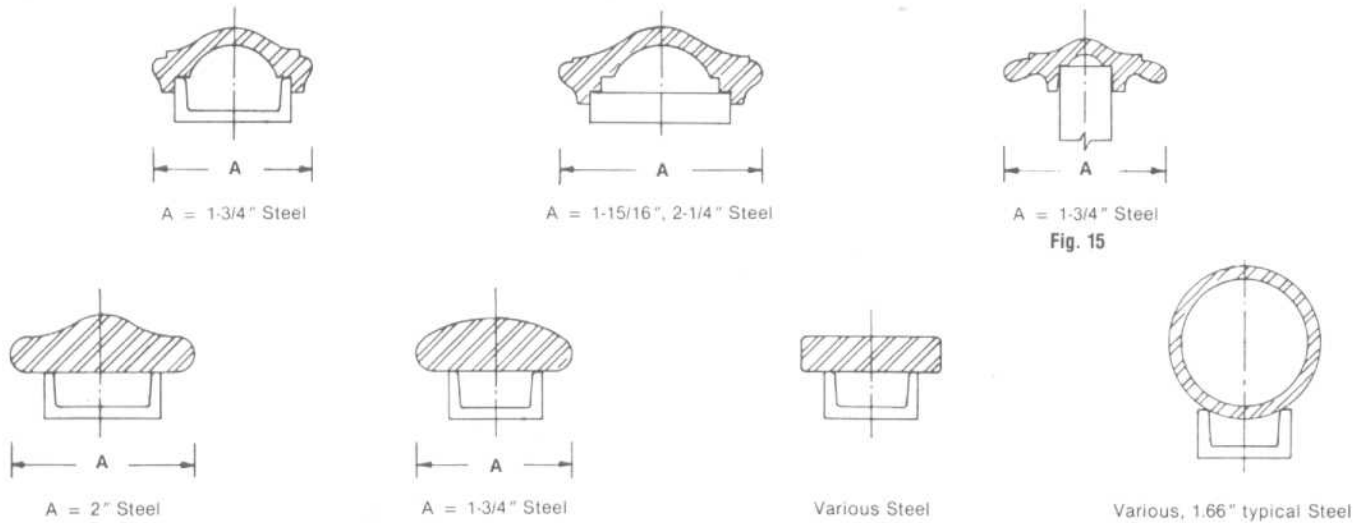
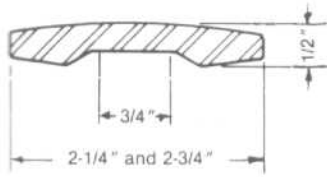


Fig. 15

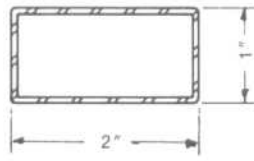
Most of these sections can be mounted on channels or flats, secured by screws or welding from below. Sometimes they are welded directly to the baluster (see Fig. 15) or attached to handrail brackets (see Fig. 14). The use of channels often simplifies the attachment of balusters and ornaments.



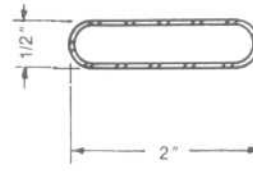
**REPRESENTATIVE EXTRUDED AND TUBULAR STAINLESS STEEL HANDRAIL SECTIONS**



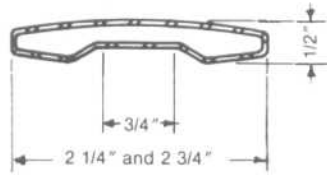
Stainless Steel Extrusion



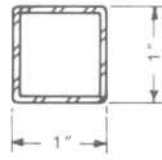
Stainless Steel (other sizes available)



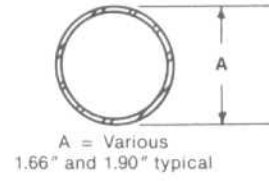
Stainless Steel



Stainless Steel



Stainless Steel (other sizes available)



A = Various  
1.66" and 1.90" typical

Stainless Steel

Stainless tubular handrail sections usually have a wall thickness of .065".

**PLASTIC HANDRAIL COVERINGS**

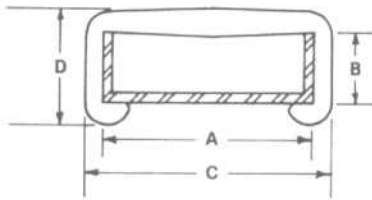


Fig. 16

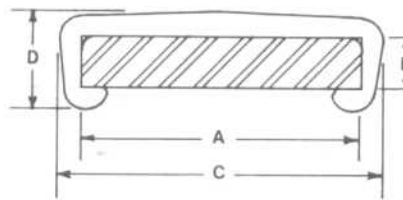


Fig. 17

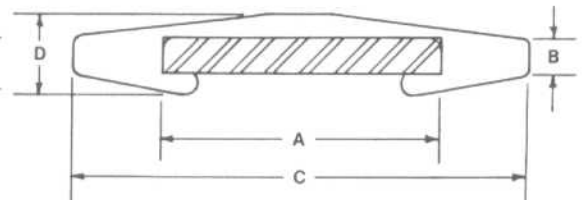


Fig. 18

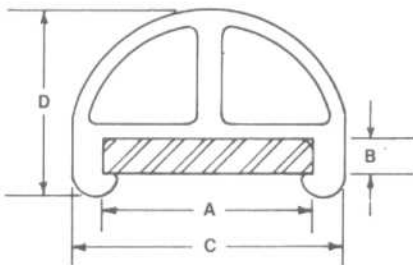


Fig. 19

**TABLE 4 Table of Dimensions for Plastic Handrail Coverings**

	A	B	C	D
Fig.	Inside width	Inside height	Outside width	Outside height
16	1"	1/2"	1 3/16"	1 3/16"
	1 1/4"		1 9/16"	
	1 1/2"		1 1 3/16"	
17	1 1/4"	1/4"	1 3/16"	9/16"
	1 1/2"		1 3/16"	
	2"		2 3/16"	
18	1 1/2"	1/4"	2 3/4"	1/2"
	2"		3 1/4"	
19	1 1/4"	1/4"	1 5/8"	1 3/16"
	1 1/2"		1 7/8"	

Caution: Consult manufacturers for fabrication limitations.

**General Information**

Functional and decorative plastic handrail mouldings of polyvinyl chloride plastics are available in a variety of sizes and profiles, several of which are illustrated in Figs. 16 to 19. Consult suppliers' current literature for variations in details and features.

Plastic handrail mouldings are not structural and require bar, tube, or channel members to support vertical and horizontal loads.

Plastic handrail mouldings are produced in a range of colors from subdued to bright, to suit either formal or informal design situations. The color is integral with the plastic,

which is highly resistant to wear, weathering, and corrosion.

The thermoplastic material becomes pliable when heated (not over 165°F), at which time it can be fitted over the support member and conforms to vertical, horizontal, or combined vertical and horizontal curves within certain limitations.

Lateral bends should have a minimum centerline radius of not less than 2 times the width of the plastic section or 2 1/2 to 3 times the width of the support section, whichever is greater. Mitered corners should be used if

sharper turns are required.

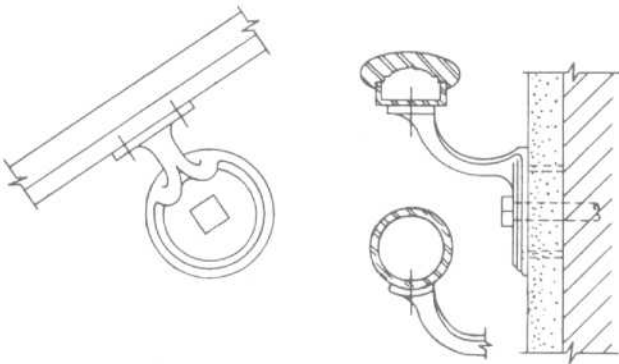
Combined vertical and horizontal turns can be formed by twisting the moulding.

The material can be joined by thermal welding, and end caps can be shaped using a knife, a file, or abrasives.

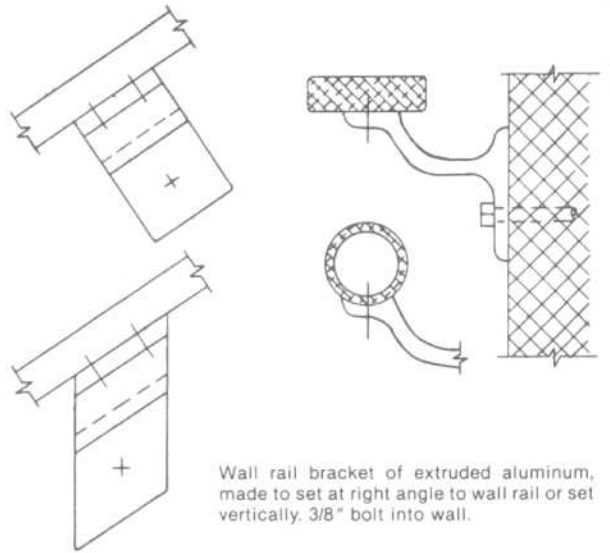
The use of a cleaning solution for removing grease and foreign material is recommended, after which a solvent is used for polishing or removing abrasive scratches. Normal cleaning requires only soap and water.

STAIRS

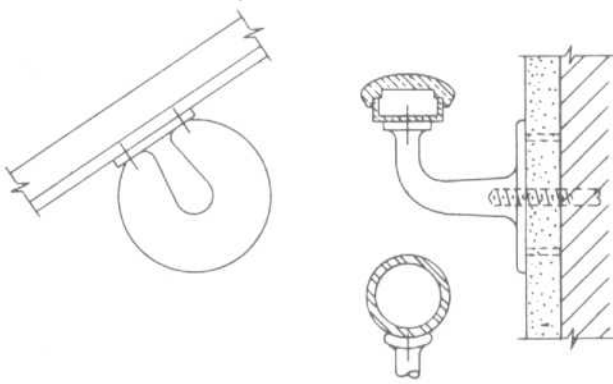
Wall Handrail Brackets



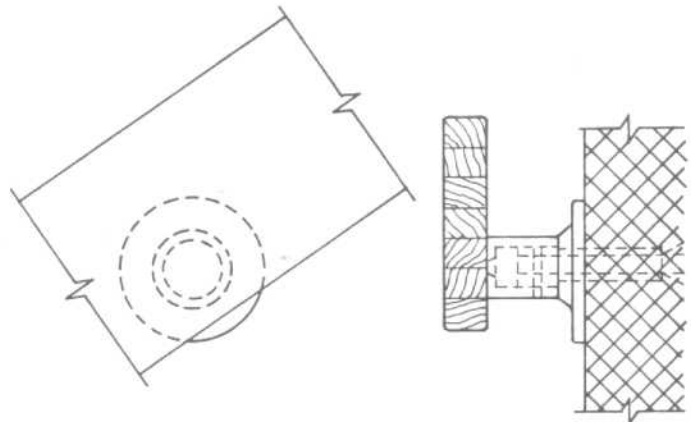
Wall rail bracket of conventional cast design, malleable iron, aluminum or bronze. 3/8" bolt into wall.



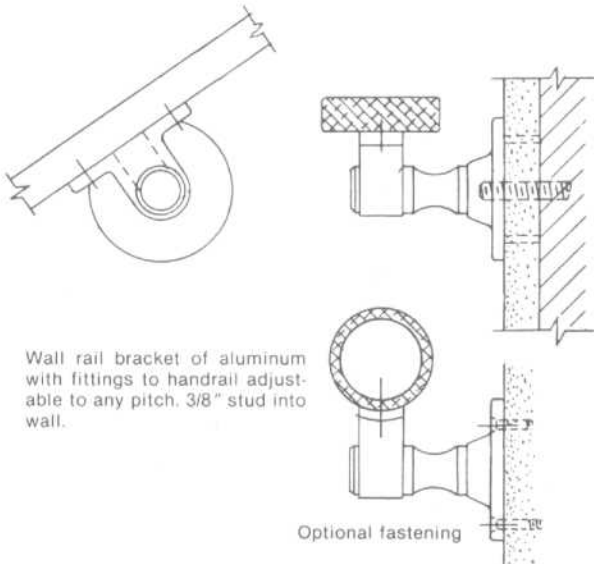
Wall rail bracket of extruded aluminum, made to set at right angle to wall rail or set vertically. 3/8" bolt into wall.



Wall rail bracket of conventional cast design, malleable iron, aluminum or bronze, 3/8" stud into wall, tapped into arm of bracket.

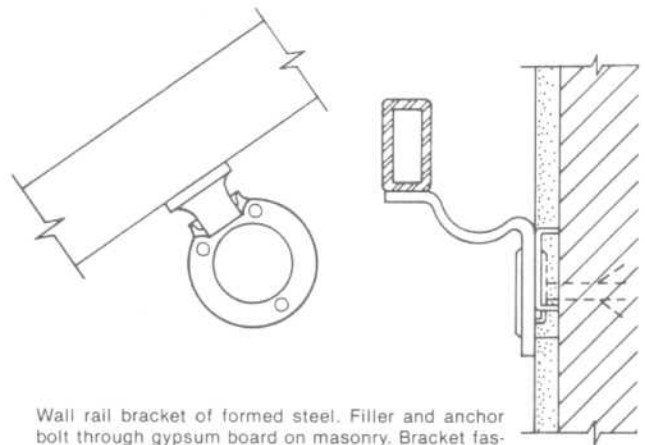


Two-piece wall rail bracket of aluminum. Wall plate bolted into wall through expansion type anchor. Outer sleeve screwed to rail. Outer sleeve fastened to wall plate by set screw.

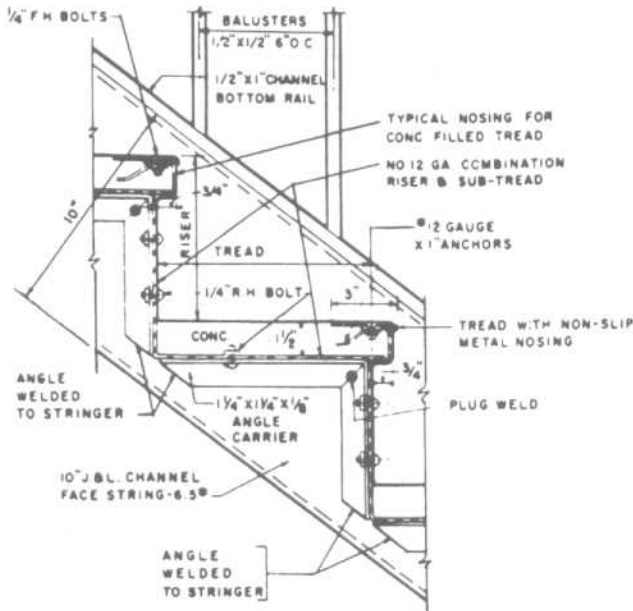


Wall rail bracket of aluminum with fittings to handrail adjustable to any pitch. 3/8" stud into wall.

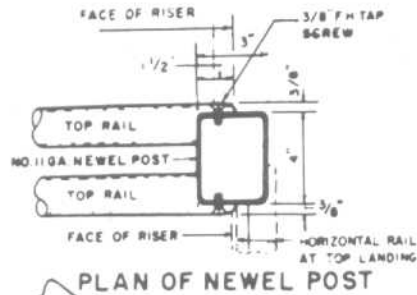
Optional fastening



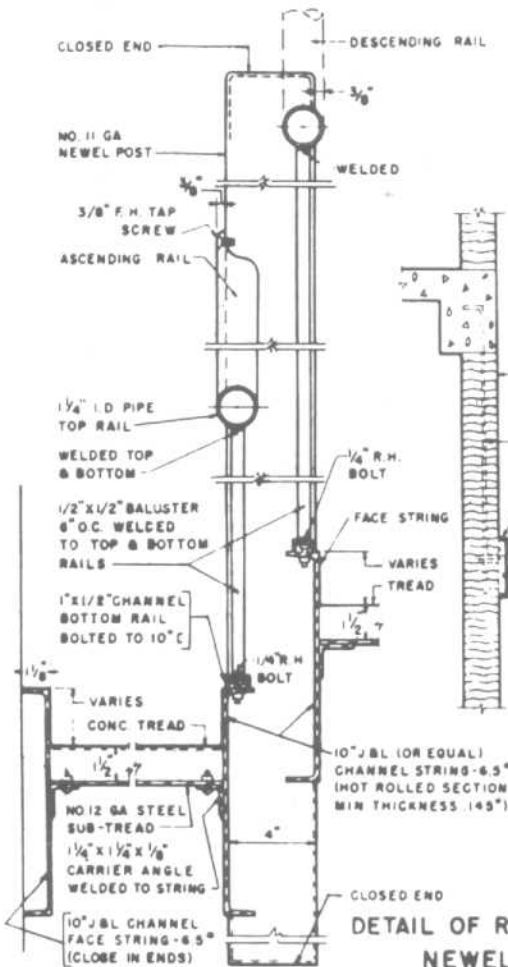
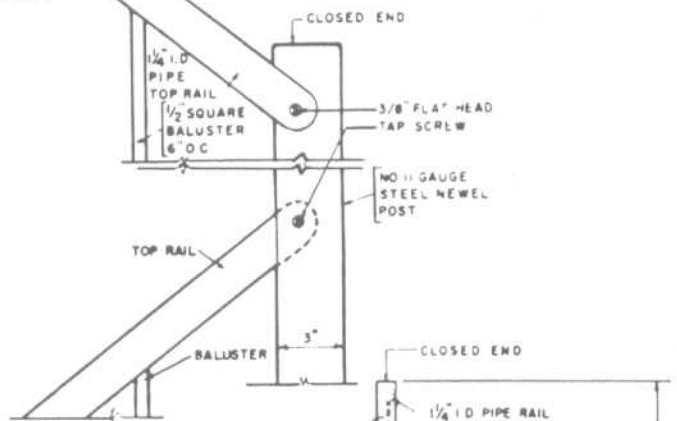
Wall rail bracket of formed steel. Filler and anchor bolt through gypsum board on masonry. Bracket fastened to filler by three screws or by 3/8" bolt through center.



TYPICAL DETAIL OF STEP

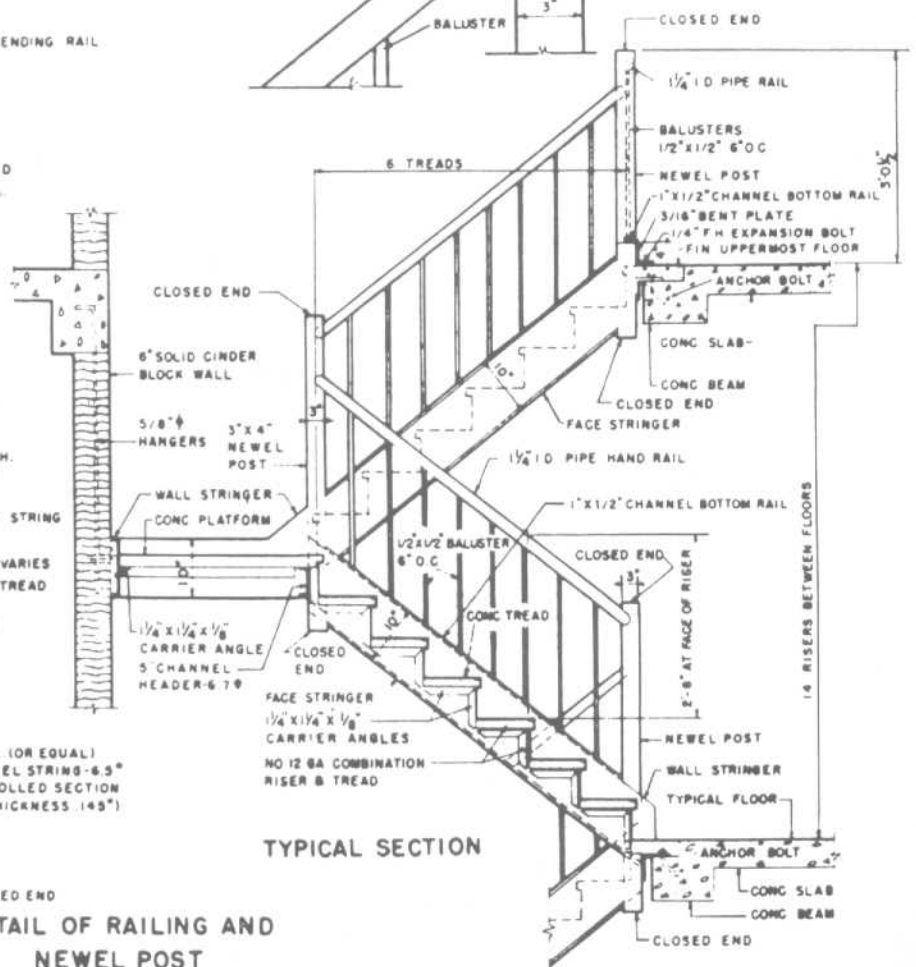


PLAN OF NEWEL POST



DETAIL OF RAILING AND NEWEL POST

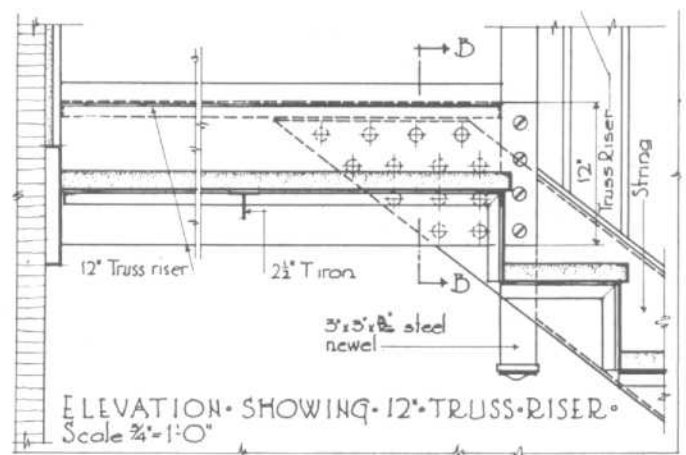
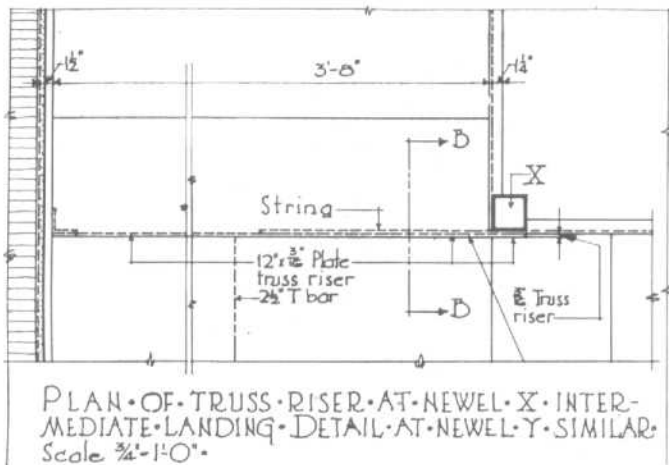
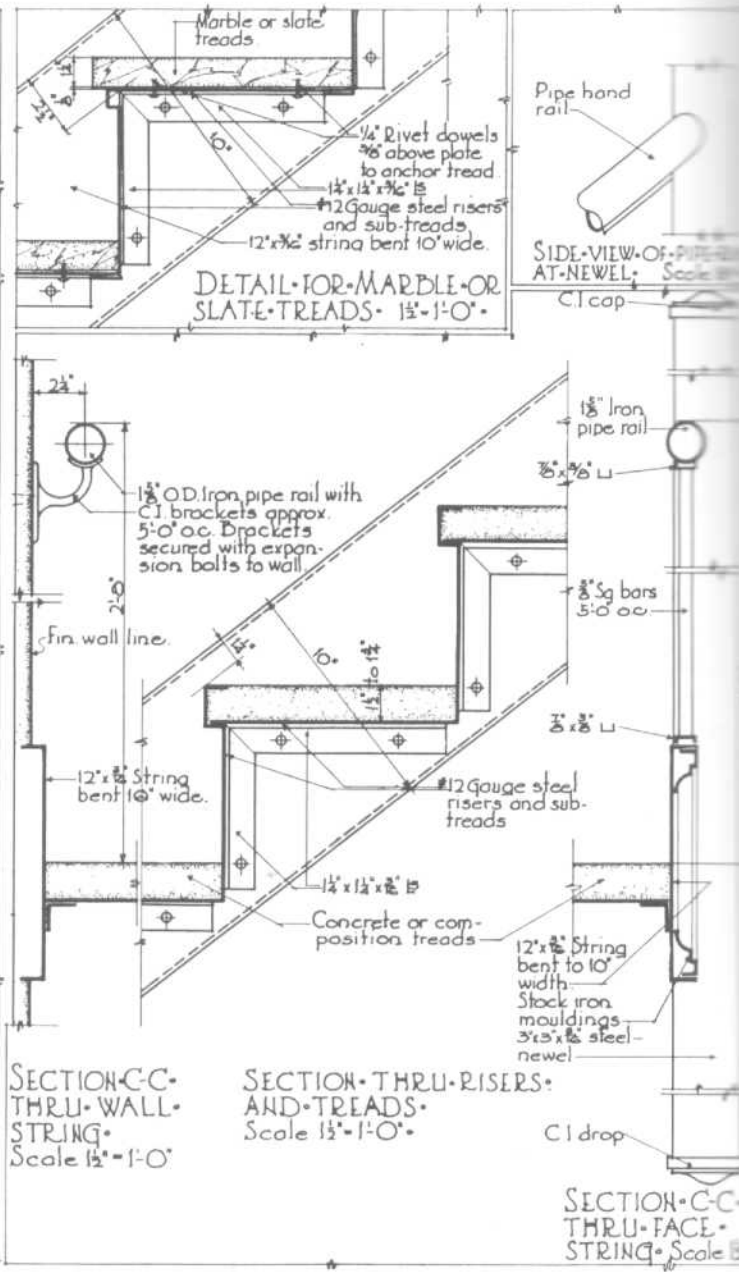
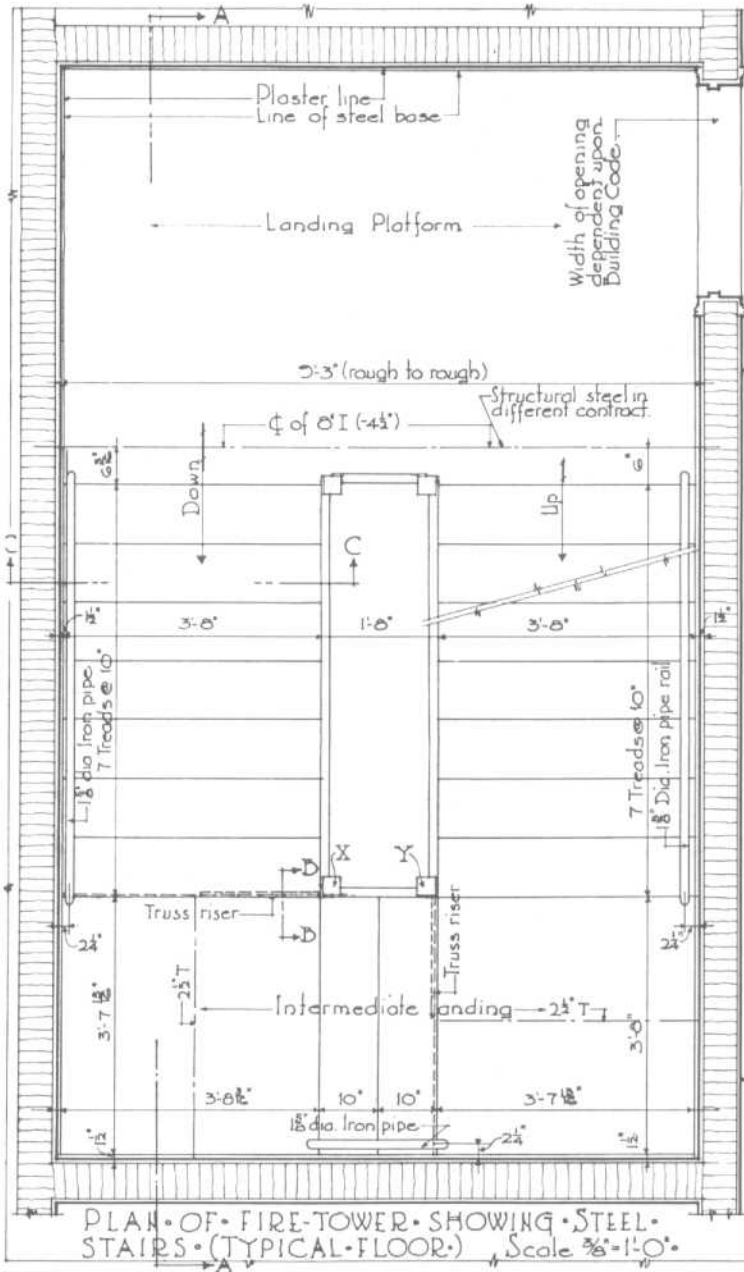
Typical steel stair construction



TYPICAL SECTION

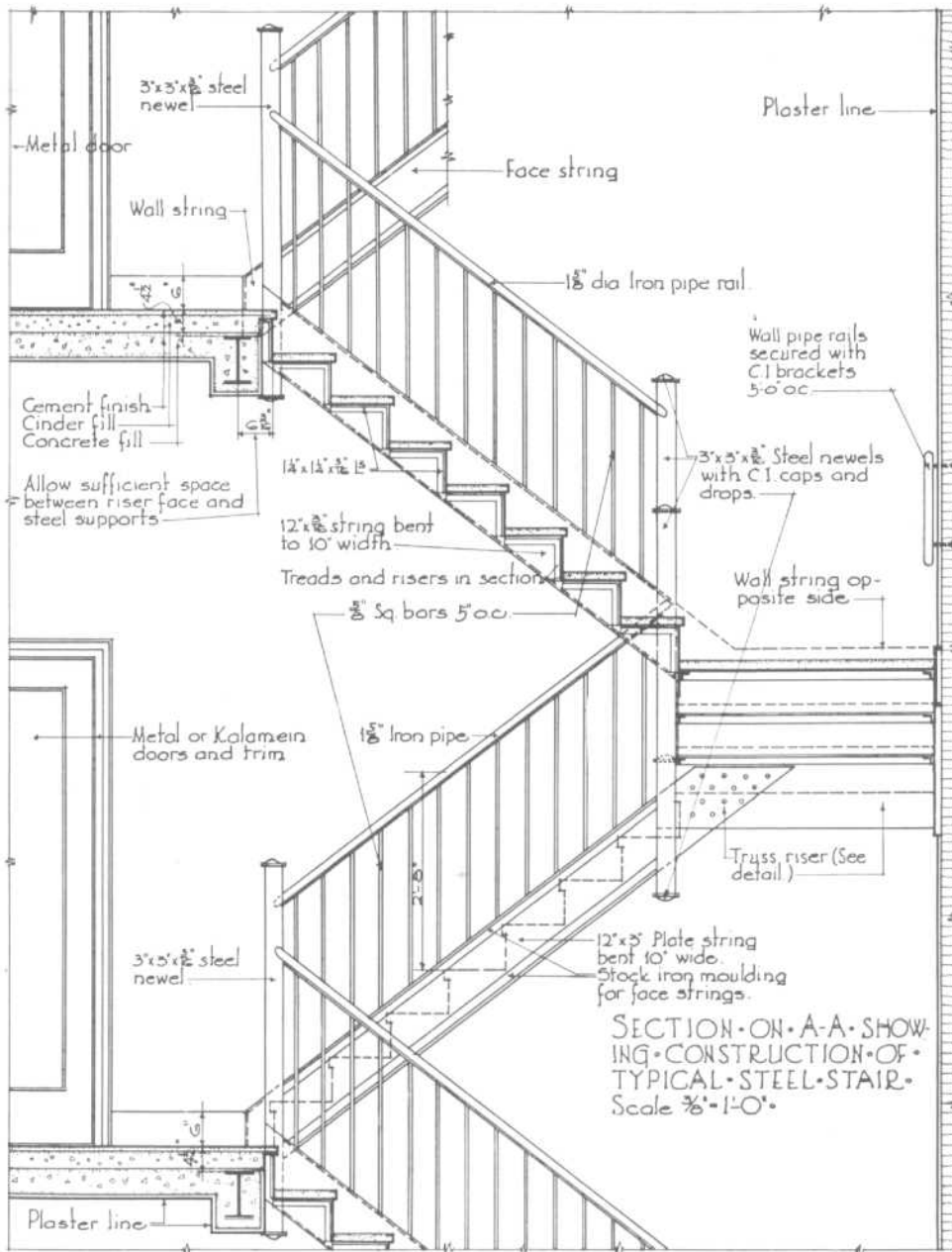
STAIRS

Steel Stairs

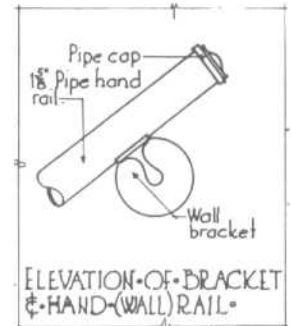


STAIRS

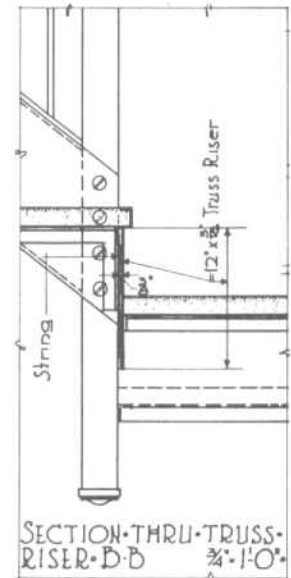
Steel Stairs



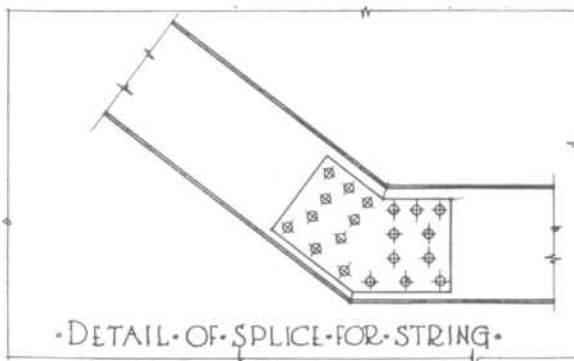
SECTION ON A-A SHOWING CONSTRUCTION OF TYPICAL STEEL STAIR. Scale 3/8" = 1'-0"



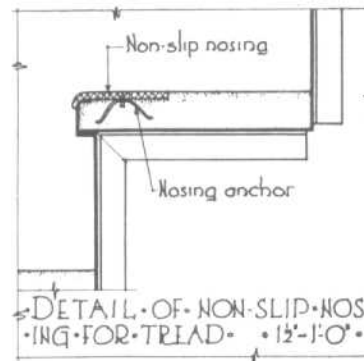
ELEVATION OF BRACKET FOR HAND (WALL) RAIL



SECTION THRU TRUSS RISER D-D 3/8" = 1'-0"



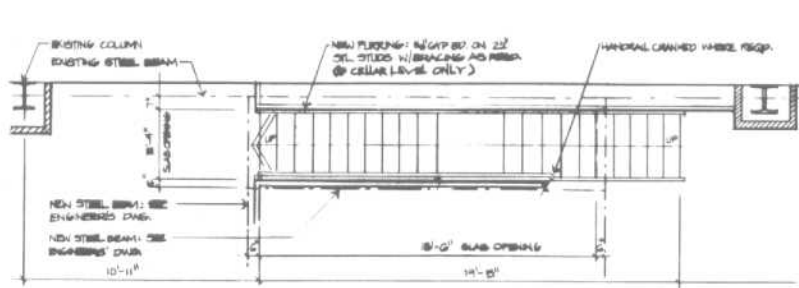
DETAIL OF SPLICE FOR STRING



DETAIL OF NON-SLIP NOSING FOR TREAD 1/2" = 1'-0"

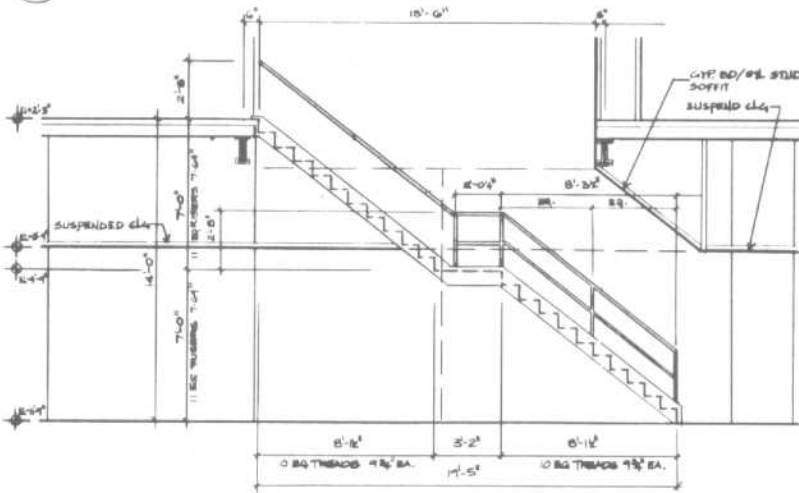
STAIRS

Steel Stairs



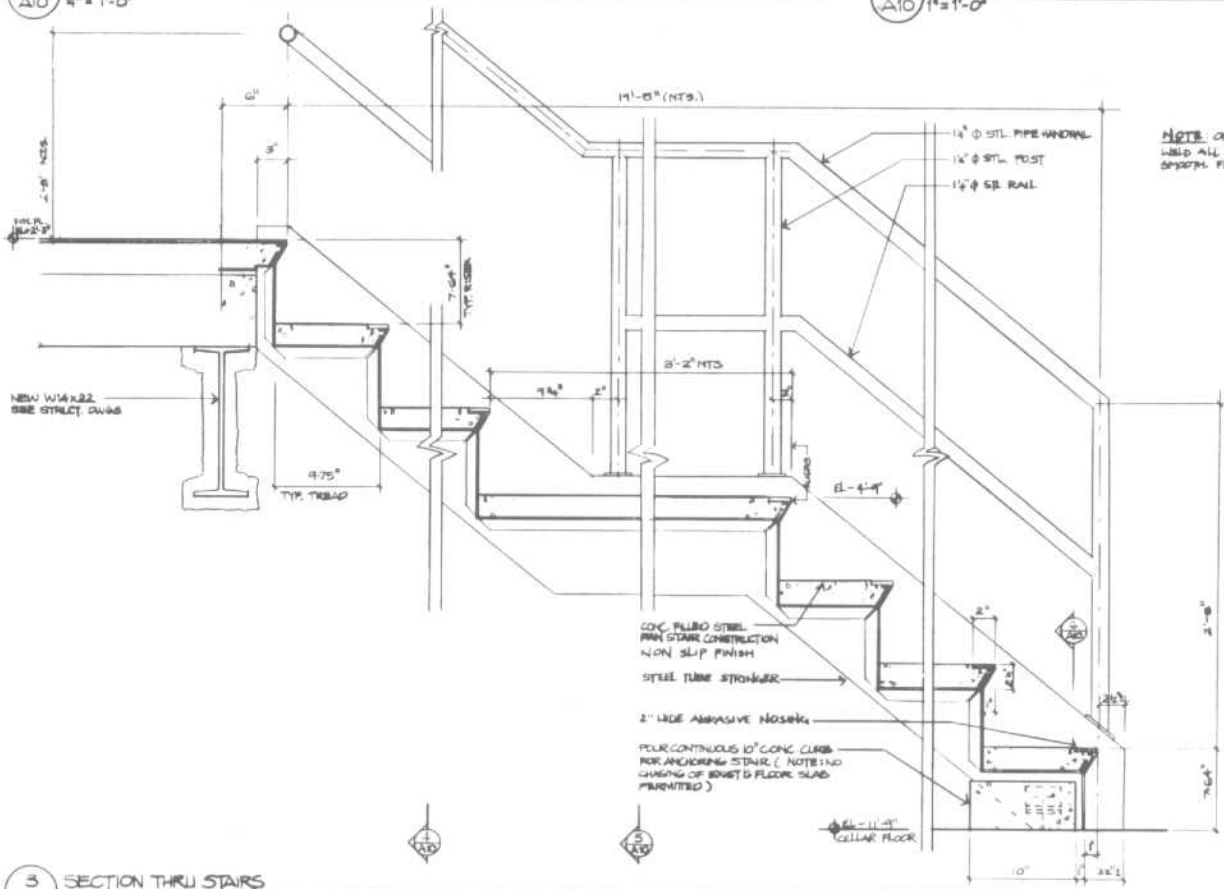
1 PLAN: NEW STAIRS @ CELLAR

A10 1/4" = 1'-0"



2 ELEVATION OF STAIRS

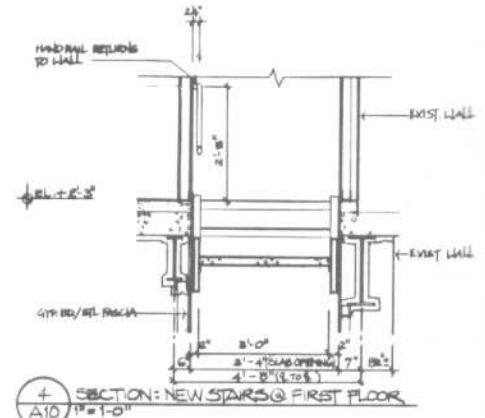
A10 1/4" = 1'-0"



NOTE: ON HANDRAIL I WELD ALL JOINTS & GRIND SMOOTH FINISH W/ BRUNT

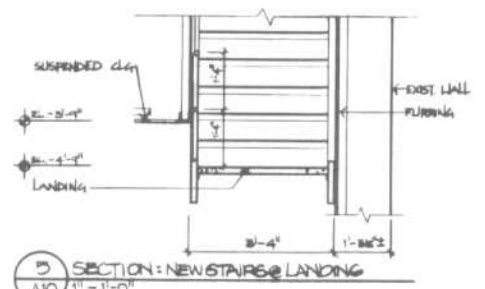
3 SECTION THRU STAIRS

A10 1/2" = 1'-0"



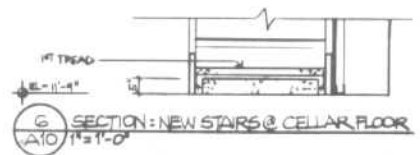
4 SECTION: NEW STAIRS @ FIRST FLOOR

A10 1/4" = 1'-0"



5 SECTION: NEW STAIRS @ LANDING

A10 1/4" = 1'-0"



6 SECTION: NEW STAIRS @ CELLAR FLOOR

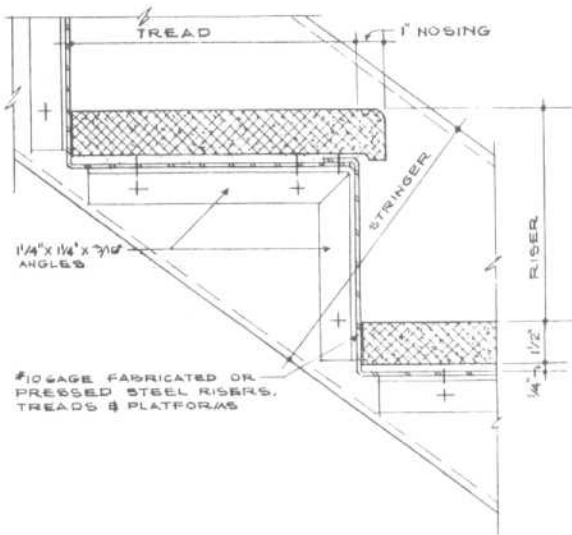
A10 1/4" = 1'-0"



STAIRS

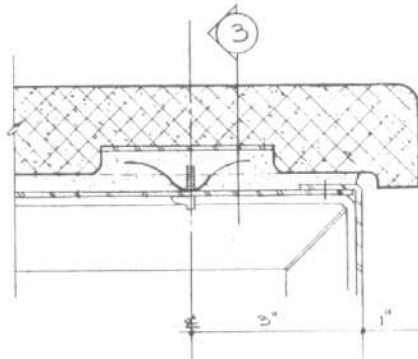
Steel Stairs

STEEL STAIRS WITH TERRAZZO TREADS



1/4" x 1/4" x 3/16" ANGLES

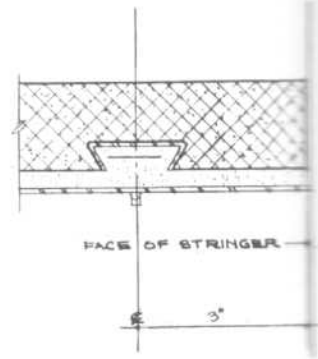
#10 GAGE FABRICATED OR PRESSED STEEL RISERS, TREADS & PLATFORMS



2 DOVETAIL ANCHOR  
@ 1/2" FULL SIZE

LENGTH (FT)	THICKNESS (MIN.) IN.
TO 4'-6"	1 1/2"
4'-6" TO 6'-6"	1 3/4"
6'-6" TO 8'-0"	2"
OVER 8'-0"	NOT RECOMMENDED

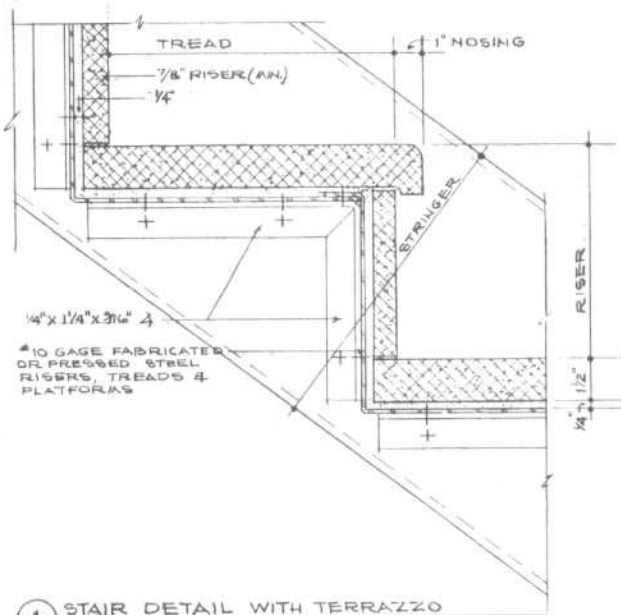
MINIMUM RECOMMENDED THICKNESS FOR TERRAZZO TREAD, RISERS, & STRINGERS



3 SECTION  
@ 1/2" FULL SIZE

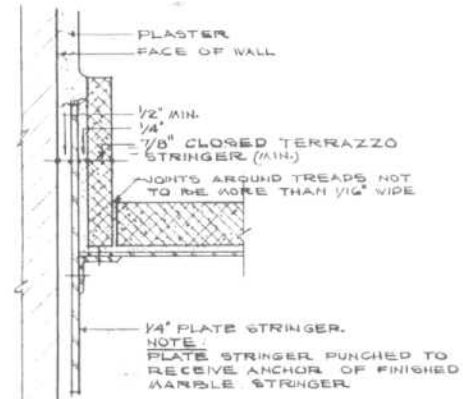
1 STAIR DETAIL (TERRAZZO TREAD)  
@ 3" = 1'-0"

STEEL STAIRS WITH TERRAZZO TREADS AND RISERS



1/4" x 1/4" x 3/16" A

#10 GAGE FABRICATED OR PRESSED STEEL RISERS, TREADS & PLATFORMS



2 STRINGER DETAIL

1 STAIR DETAIL WITH TERRAZZO RISERS & TREADS



**STAIRS**  
Spiral Stairs

**Construction**

Material may be steel, stainless steel, cast iron, or aluminum. Treads are supported in cantilever fashion by the column, each consecutive tread being rotated at a predetermined angle. The platform attaches to the column and is fastened to the floor structure to hold the column secure. The spiral railing is supported by balusters attached to the outer ends of the treads.

**Tread Designs**

Fabricators provide several standard types and designs of treads and platforms. These include open riser, closed riser, and cantilever types, with surface of checkered plate, abrasive plate, steel grating, or plain surface to receive wood, resilient flooring, carpet, or other covering. Pan type treads to receive concrete or terrazzo fill are also available.

**Stair Height**

Spiral stairs are adaptable to any height, the height being equal to the distance from finished floor to finished floor.

**Stair Diameter**

Spiral stairs are available in various diameters from 3'6" to 8'0", normally in 6" increments. A 4'0" diameter is considered minimum for general access purposes; a 5'0" diameter provides a comfortable general purpose stair. Larger diameters are used chiefly for architectural effect. Note that the diameter of the finished well opening should be at least 2" greater than the stair diameter, to provide hand clearance.

**Hand of Stairs**

*Left-hand stairs:* User ascends in clockwise direction, with handrail at left.

*Right-hand stairs:* User ascends in counterclockwise direction, with handrail at right.



Fig. 20

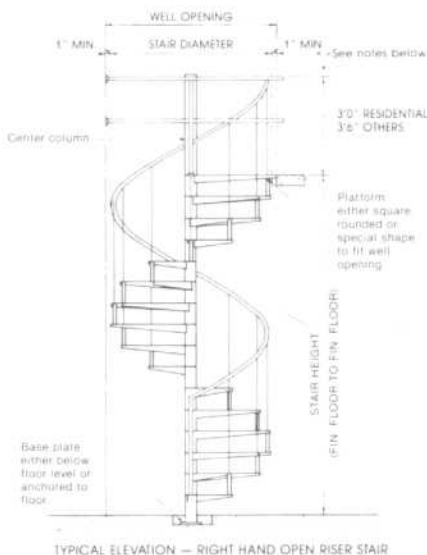
TABLE 5 Riser Heights for Various Tread Angles

Tread angle	Min. height of riser*	Treads per 1/4 circle	Treads per full circle
30°	8 <sup>15</sup> / <sub>16</sub> "	9	12
27°	8"	10	13 = 351°
24 <sup>1</sup> / <sub>2</sub> °	7 <sup>5</sup> / <sub>16</sub> "	11	15 = 367 <sup>1</sup> / <sub>2</sub> °
22 <sup>1</sup> / <sub>2</sub> °	6 <sup>11</sup> / <sub>16</sub> "	12	16

\*Minimum height to attain 6'6" clear headroom using a 90° landing, 2" thick.

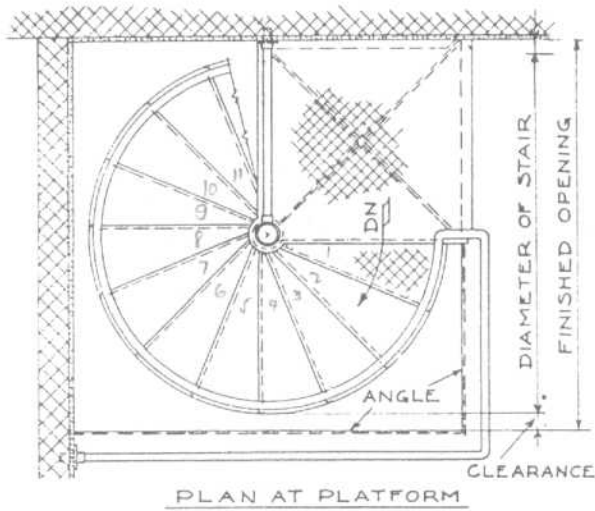
TABLE 6 Chart for Selection of Number and Height of Risers

Floor to floor height	Number of risers and height of each in inches								
	10	11	12	13	14	15	16	17	18
7'0"	8.4	7.6	7.0						
7'4"	8.8	8.0	7.3	6.8					
7'8"	9.2	8.4	7.7	7.0					
8'0"	9.6	8.7	8.0	7.4	6.9				
8'2"	9.8	8.9	8.2	7.5	7.0				
8'4"		9.1	8.3	7.7	7.1	6.7			
8'6"		9.3	8.5	7.8	7.3	6.8			
8'8"		9.4	8.7	8.0	7.4	6.9			
8'10"			8.8	8.2	7.6	7.1	6.6		
9'0"			9.0	8.3	7.7	7.2	6.7		
9'2"			9.2	8.5	7.9	7.3	6.9		
9'4"			9.3	8.6	8.0	7.5	7.0		
9'6"				8.8	8.1	7.6	7.1	6.7	
9'8"				9.0	8.3	7.7	7.2	6.8	
9'10"				9.2	8.4	7.9	7.4	6.9	
10'0"				9.3	8.6	8.0	7.5	7.0	6.7
10'2"					8.7	8.1	7.6	7.2	6.8
10'4"					8.9	8.3	7.7	7.3	6.9
10'6"					9.0	8.4	7.9	7.4	7.0
10'8"					9.1	8.5	8.0	7.5	7.1
10'10"						8.6	8.1	7.6	7.2
11'0"						8.7	8.2	7.8	7.3
11'2"						8.9	8.4	7.9	7.4
11'4"						9.0	8.5	8.0	7.6
11'6"							8.6	8.1	7.7
11'8"							8.7	8.2	7.8
12'0"							9.0	8.5	8.0

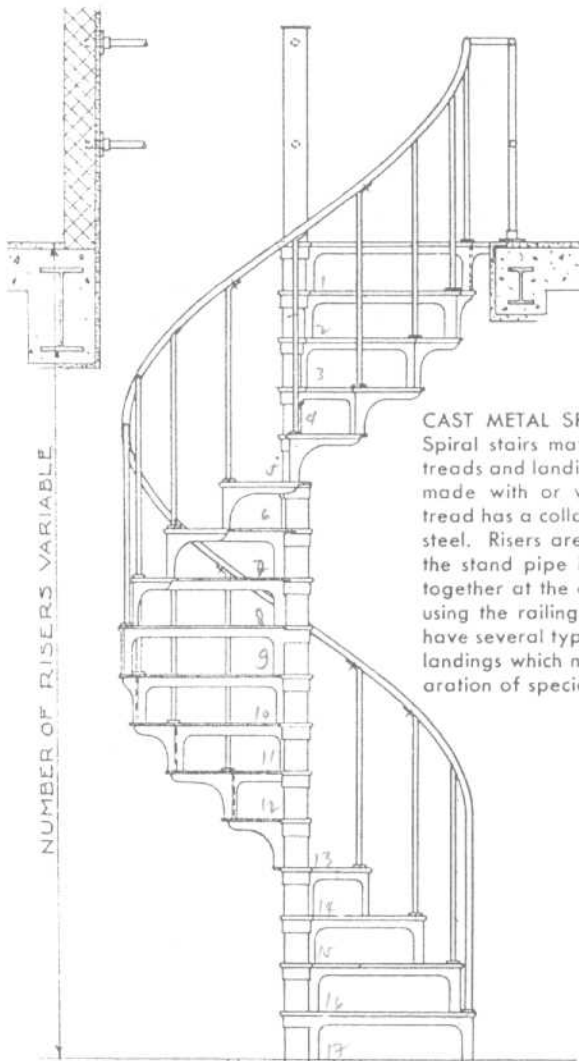
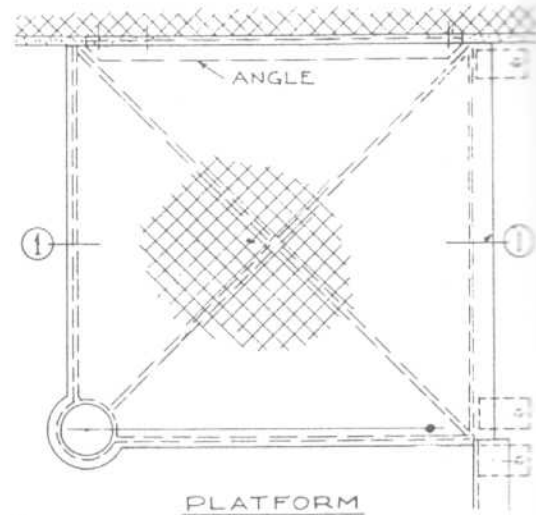


STAIRS

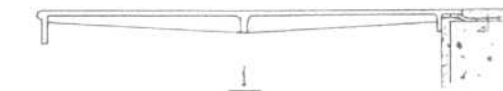
Spiral Stairs



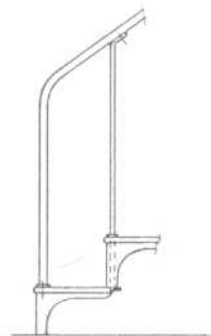
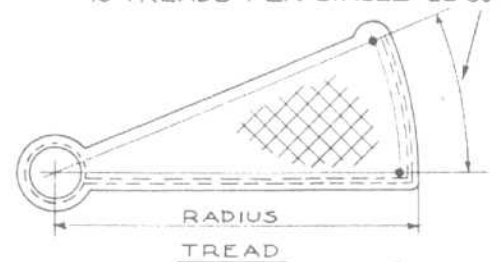
**Diameter and head room** Spiral stairs may be made in diameters from 3'6" to 6'0" or greater, with 4'0" usually considered the minimum for easy travel. The well hole should be at least 3" larger in diameter than the stair, for railing clearance. Spiral stairs are usually constructed with 12 or 16 treads to the circle. Head room should be calculated on the basis of three-fourths of a circle. On a 12-tread circle, 9" is approximately the minimum rise, providing 6'9" head room. On a 16-tread circle, 7" rise will provide 7'0" head room. A rise up to 12" per tread may be employed.



**CAST METAL SPIRAL STAIR CONSTRUCTION:** Spiral stairs may be constructed with cast metal treads and landings of plain or checkered surface, made with or without abrasive material. Each tread has a collar which slips over a stand pipe of steel. Risers are not desirable as toe room near the stand pipe is limited. The treads are bolted together at the outer edge, either by bolts or by using the railing posts as bolts. Fabricators may have several types of standard design treads and landings which may be satisfactory without preparation of special patterns.

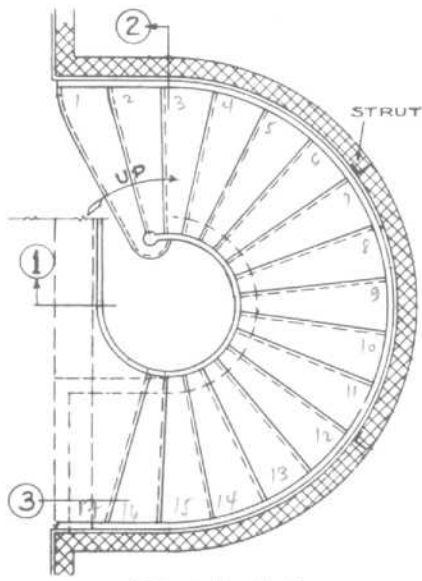


12 TREADS PER CIRCLE - 30°  
16 TREADS PER CIRCLE - 22° 30'

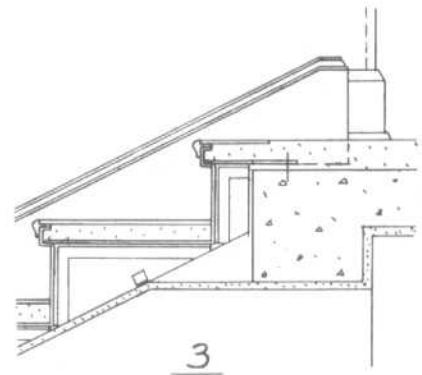
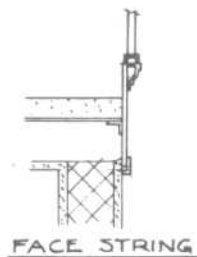
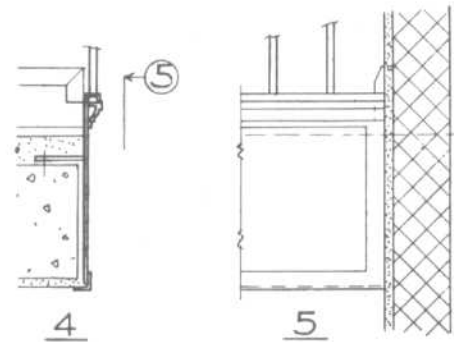
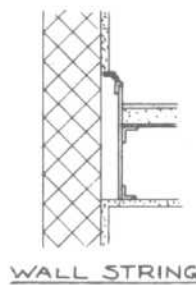
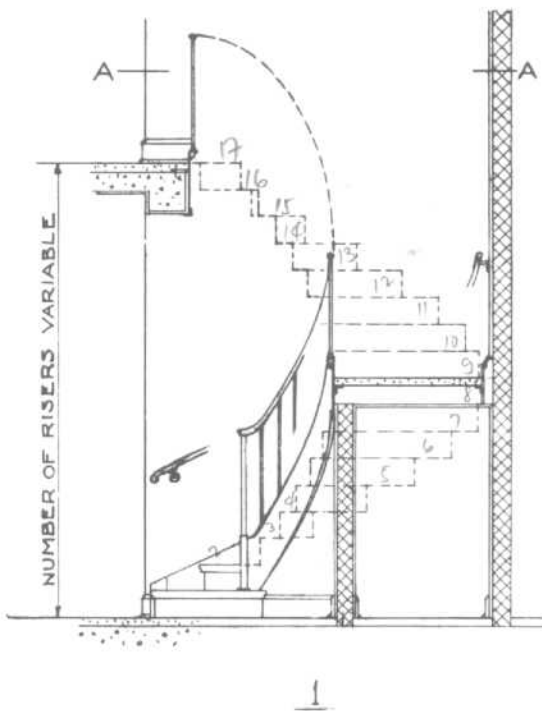
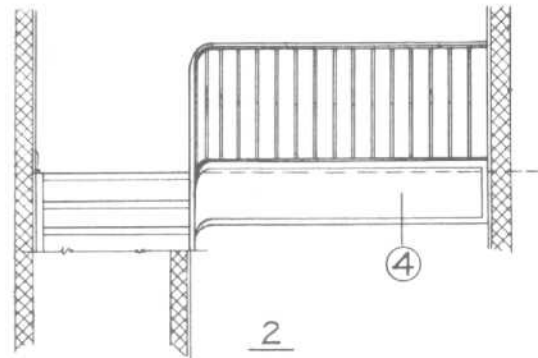


SCALE.  $\frac{3}{8}'' = 1'-0''$

**STAIRS**  
Circular Stairs



PLAN A-A



Circular stairs placed between walls may be built self-supporting at the inner string and be supported by concealed struts or hangers at the outer string. When completely exposed a circular stair may be designed to require few supports between floors.

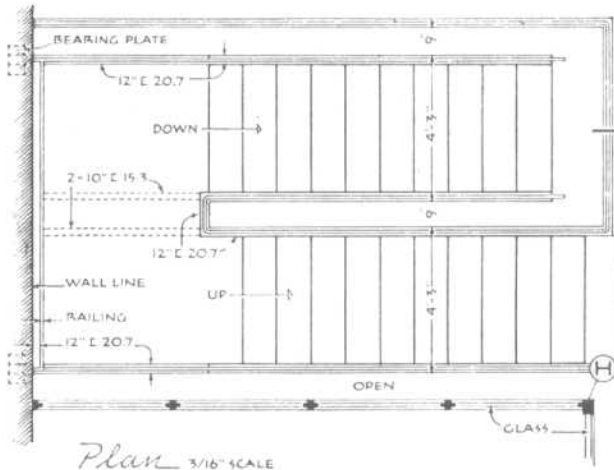
In constructing a circular stair the overall size of the well and the tread length of the stairs may be adjusted to fit the particular conditions of the structure. Treads should be a minimum width of 8" at a distance 15" out from the inside railing. The treads may be of steel, abrasive cast iron, abrasive non-ferrous metal, cement, tile, linoleum, wood, marble or other material.

Landings and platforms may be constructed as part of the stair, and may be supported by beam or cantilever construction. Wall rails and brackets may be constructed with handrail sections matching the railing.

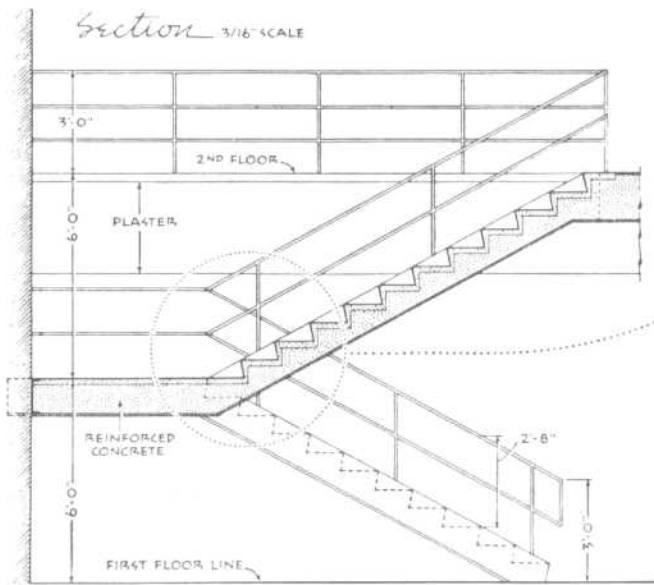
Face strings and railings may be similar to those used on straight stairs but should be designed of shapes adaptable to abrupt curved construction. The small radius to which these are constructed offers possibilities of design that should not be overlooked. Combinations of contrasting metal colors can be effectively employed in such installations.

STAIRS

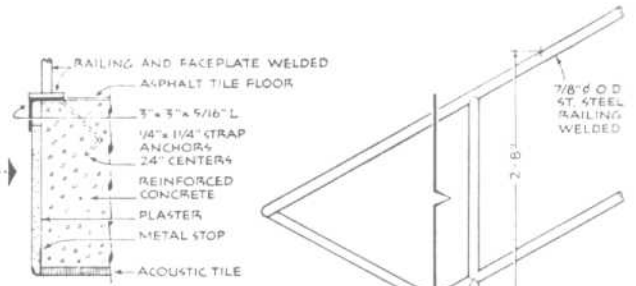
Concrete Stairs



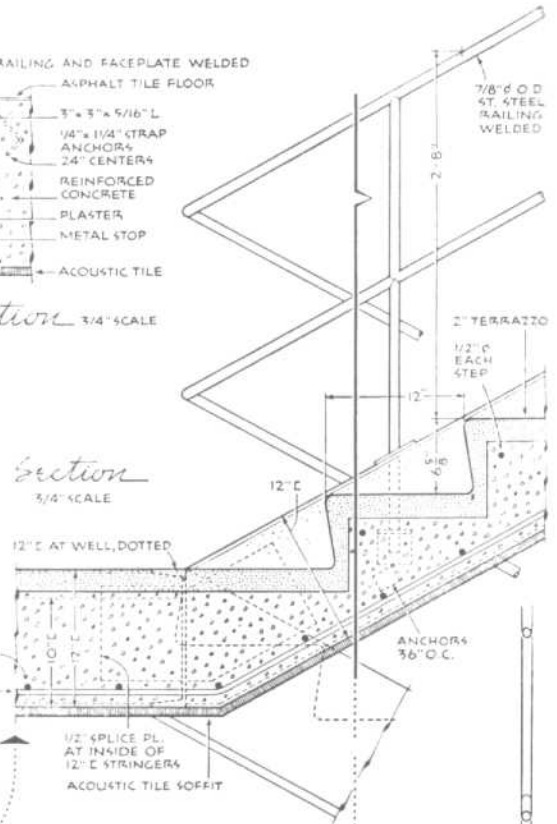
Plan 3/16" SCALE



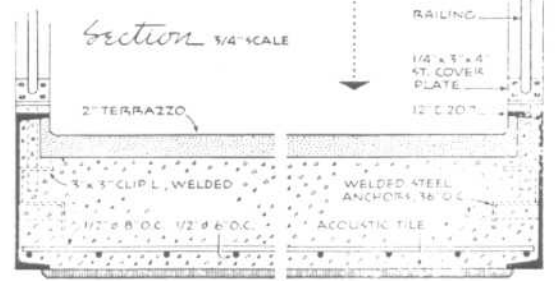
Section 3/16" SCALE



Section 3/4" SCALE

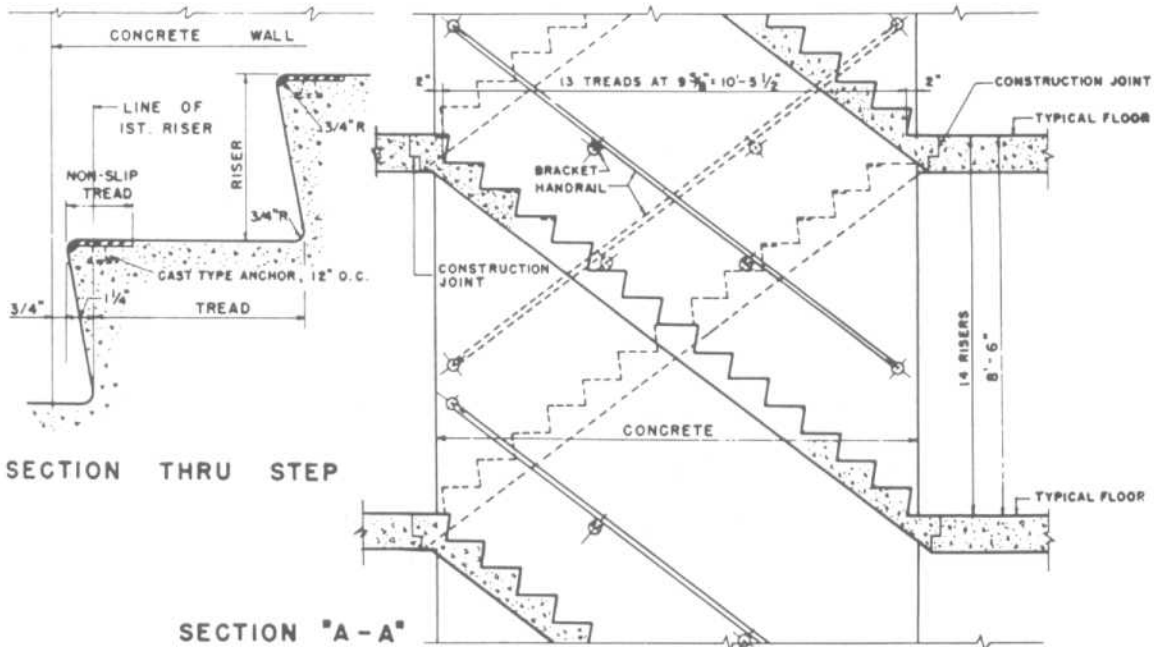
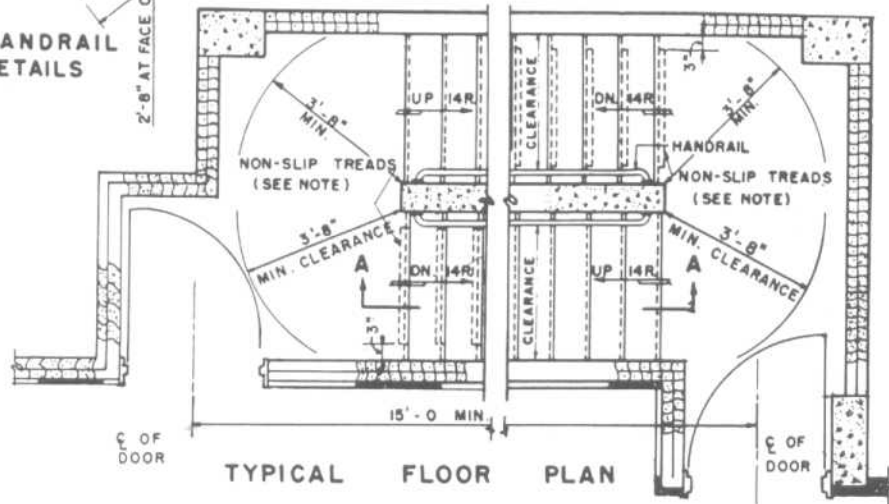
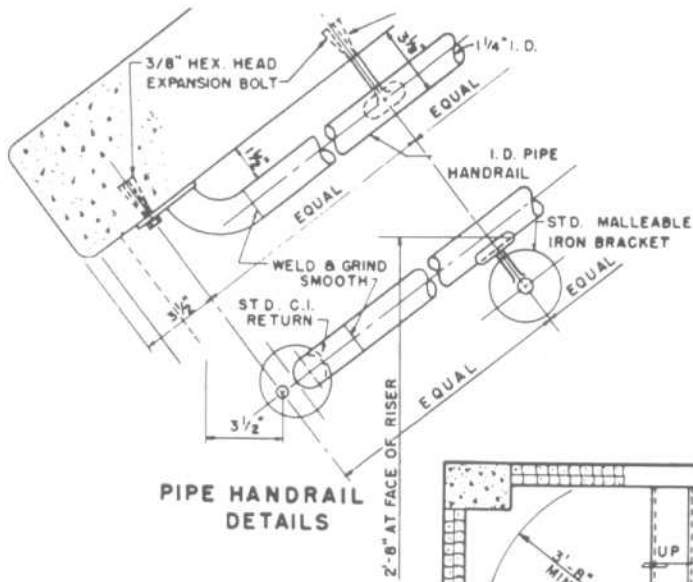


Section 3/4" SCALE



Section 3/4" SCALE

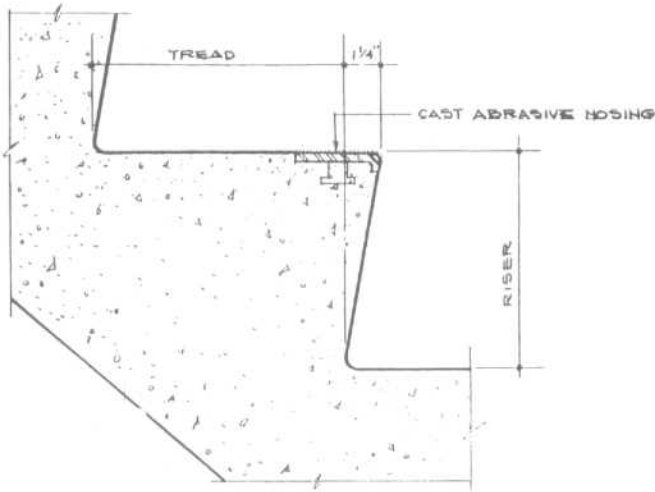
**STAIRS**  
Concrete Stairs



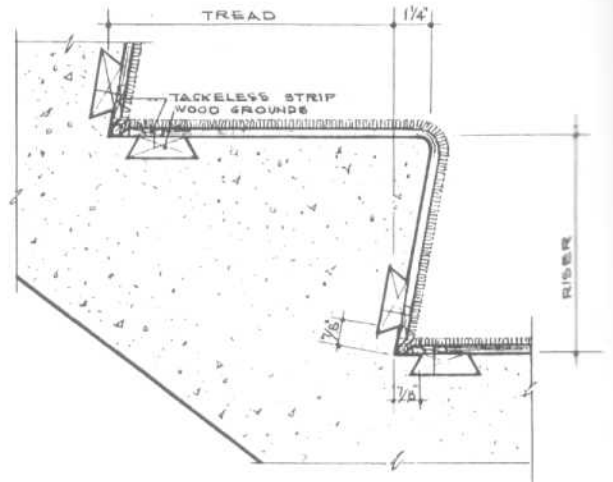
Typical reinforced concrete scissor stair

STAIRS

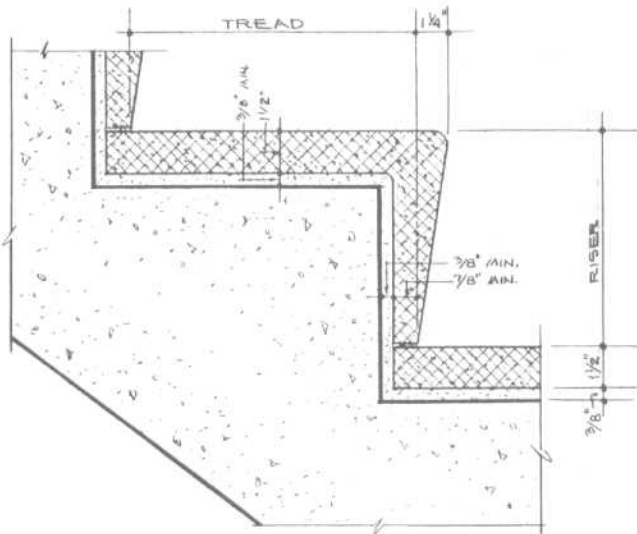
Concrete, Steel, and Terrazzo Stairs



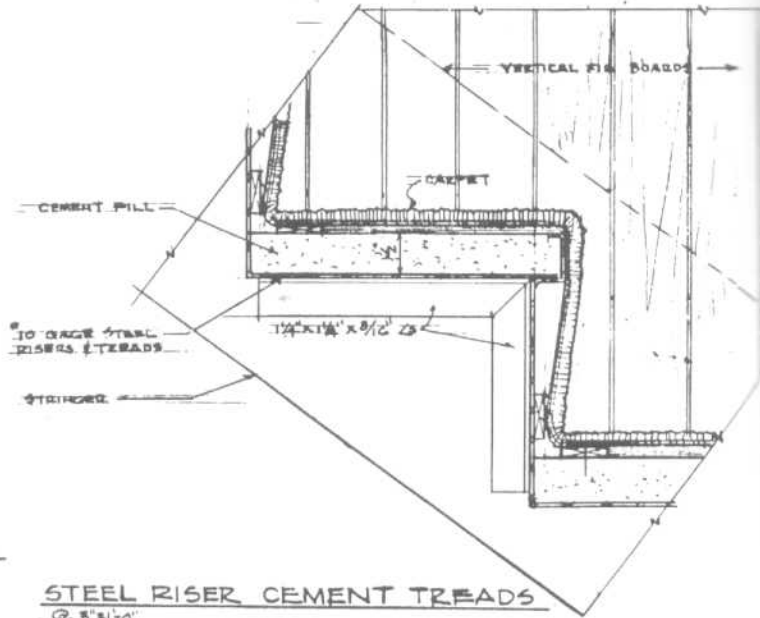
1 STAIR DETAIL



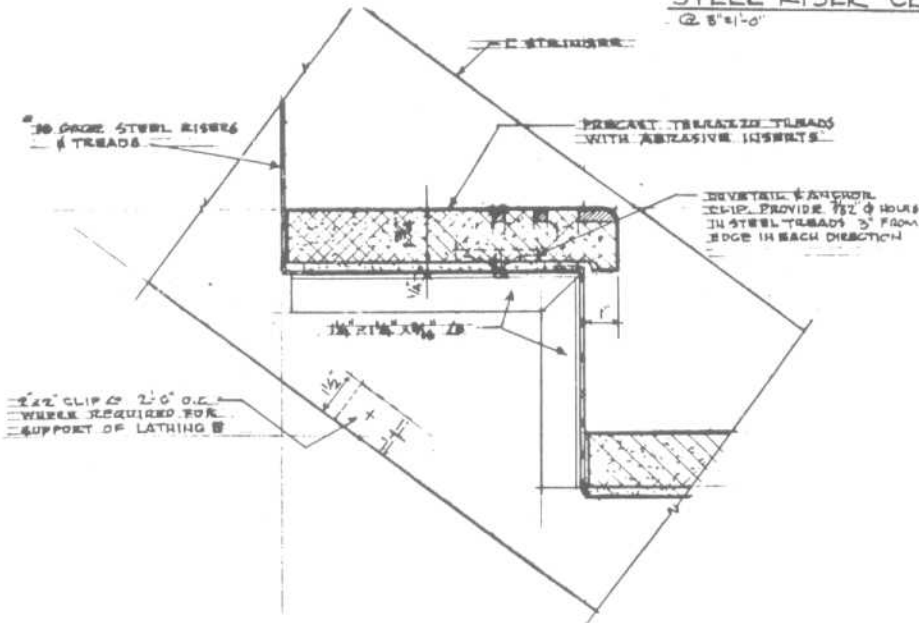
1 STAIR DETAIL WITH CARPETING



2 STAIR DETAIL WITH TERRAZZO TREADS & RISERS



STEEL RISER CEMENT TREADS @ 8'-10"



STEEL RISER TERRAZZO TREADS @ 8'-10"

**STAIRS**  
Marble Treads

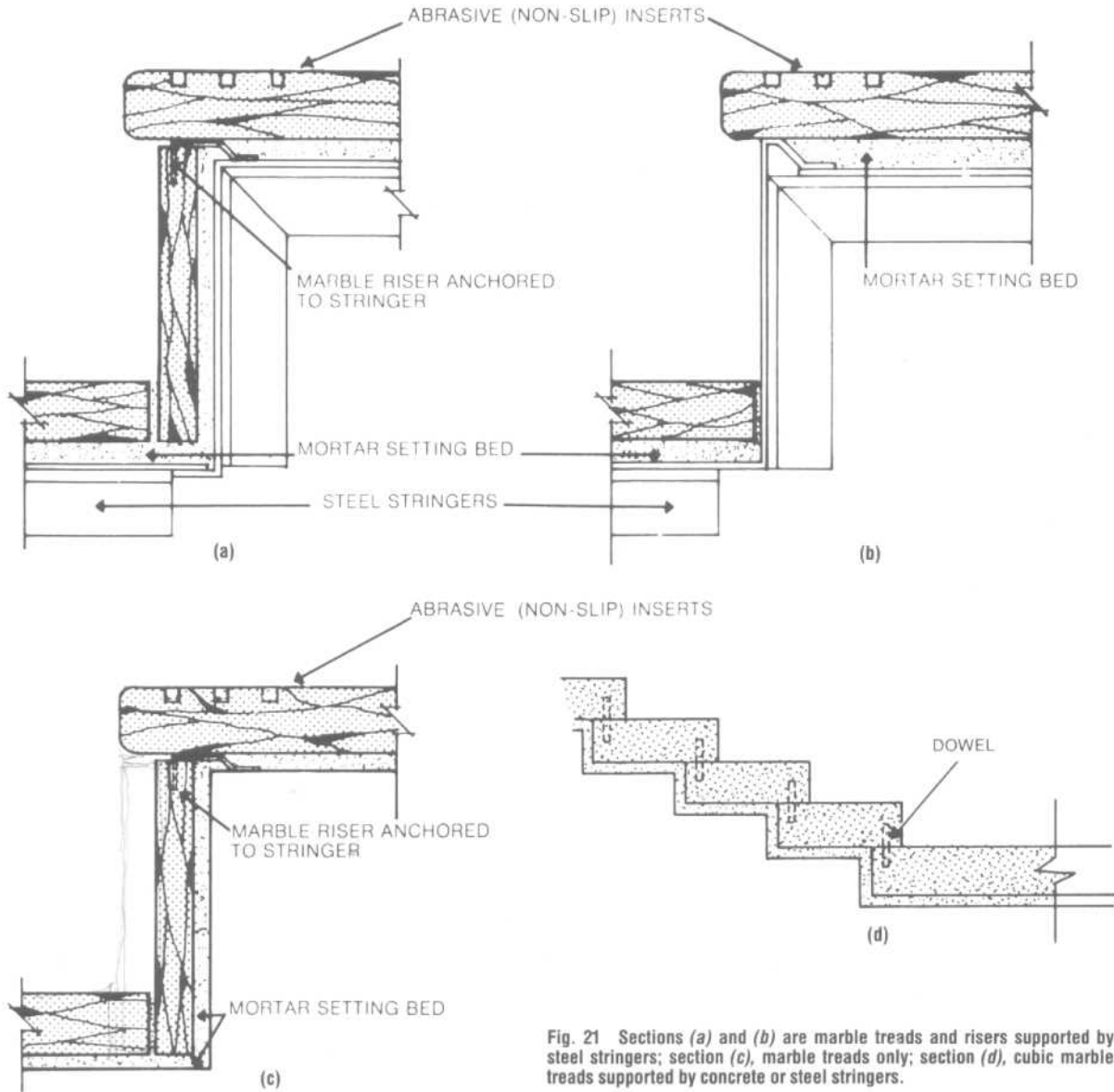


Fig. 21 Sections (a) and (b) are marble treads and risers supported by steel stringers; section (c), marble treads only; section (d), cubic marble treads supported by concrete or steel stringers.

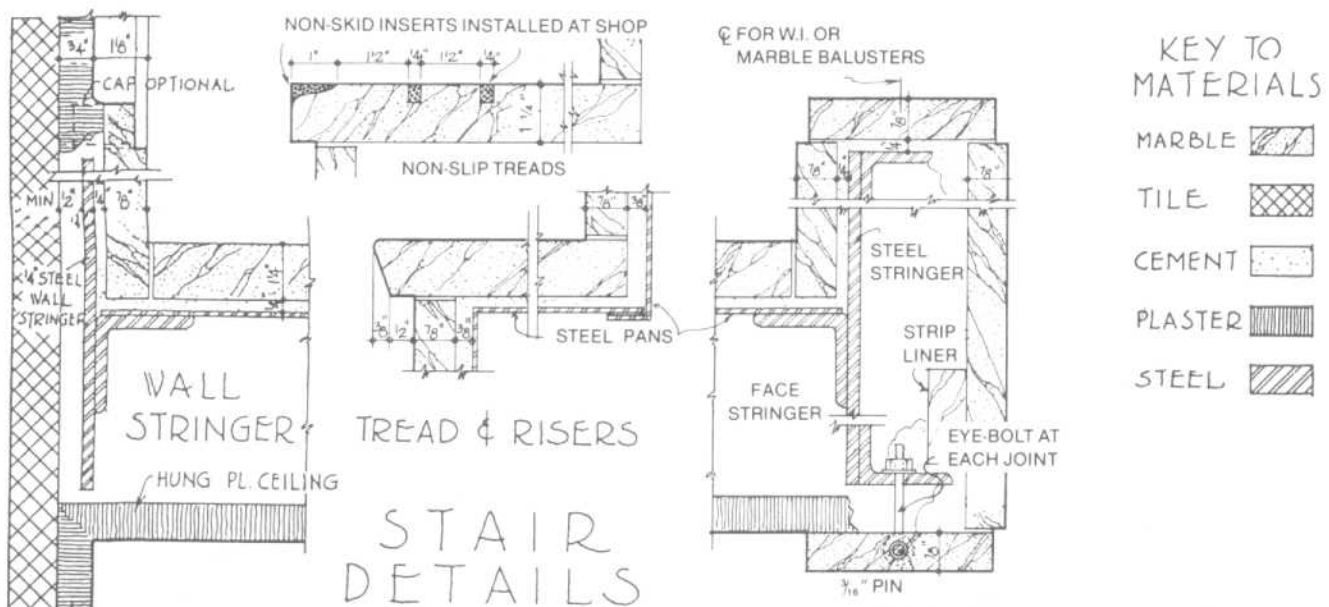
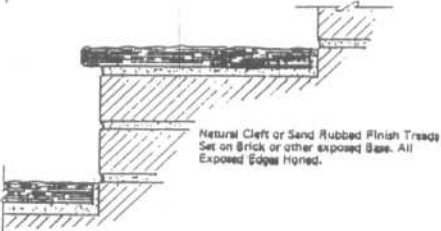
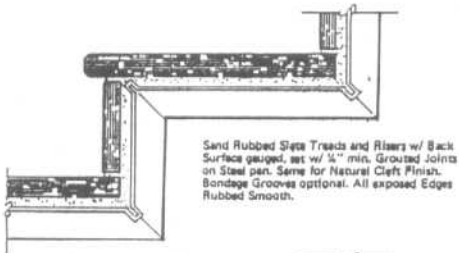
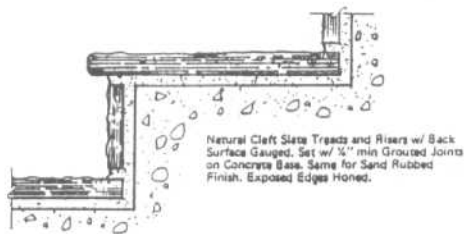


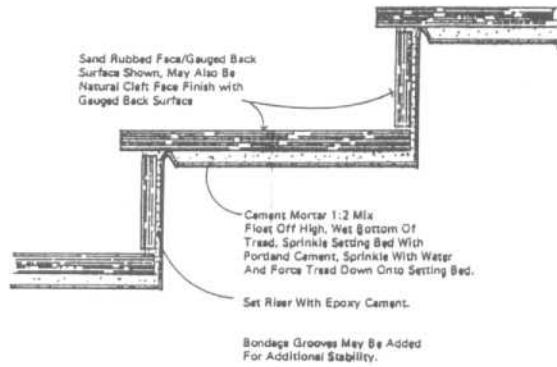
Fig. 22 Interior marble details.

STAIRS

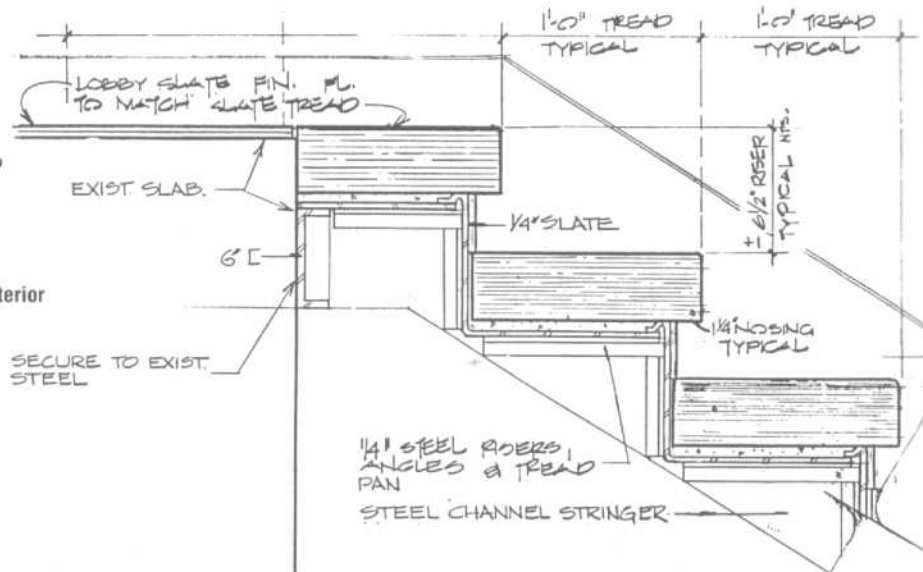
Slate Treads



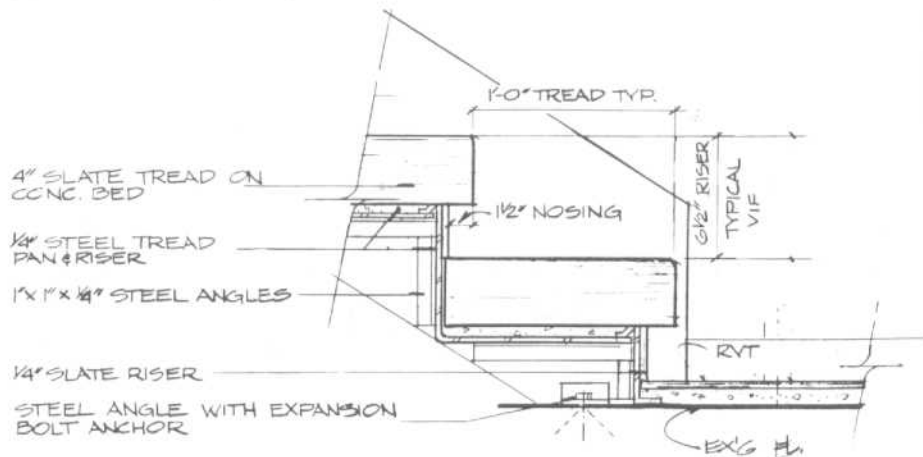
Suggested detail for slate treads and risers, exterior and/or interior



Slate treads and risers set on metal pan stair



4 DETAIL OF TOP END STAIR # 4 @ LOBBY LEVEL  
SCALE: 1/2" = 1'-0"



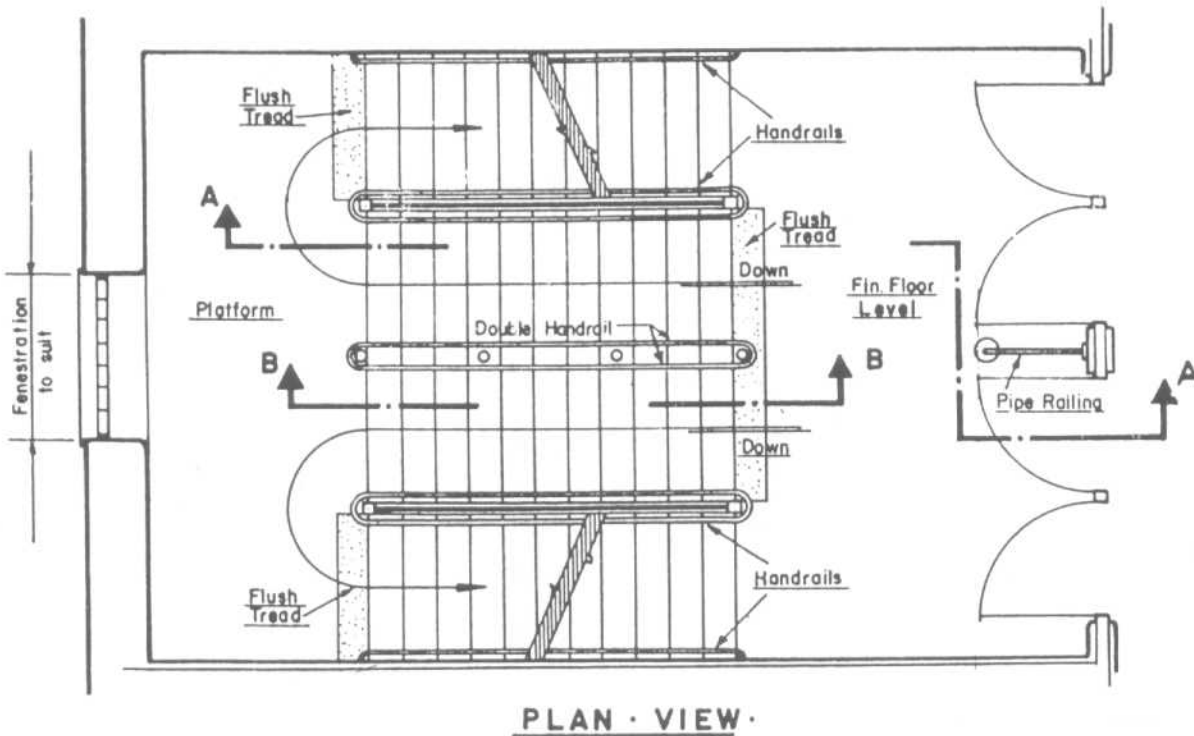
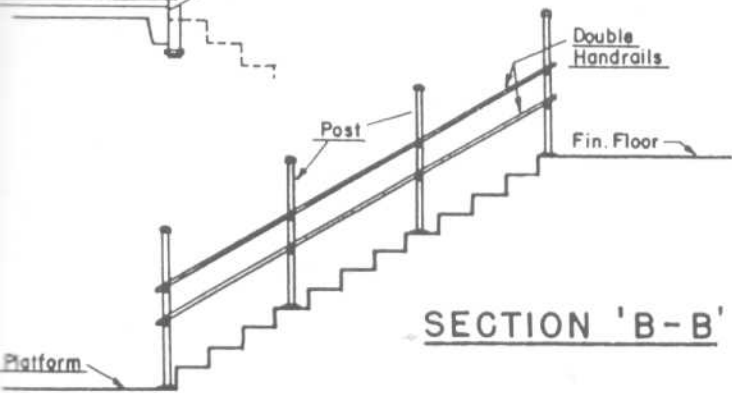
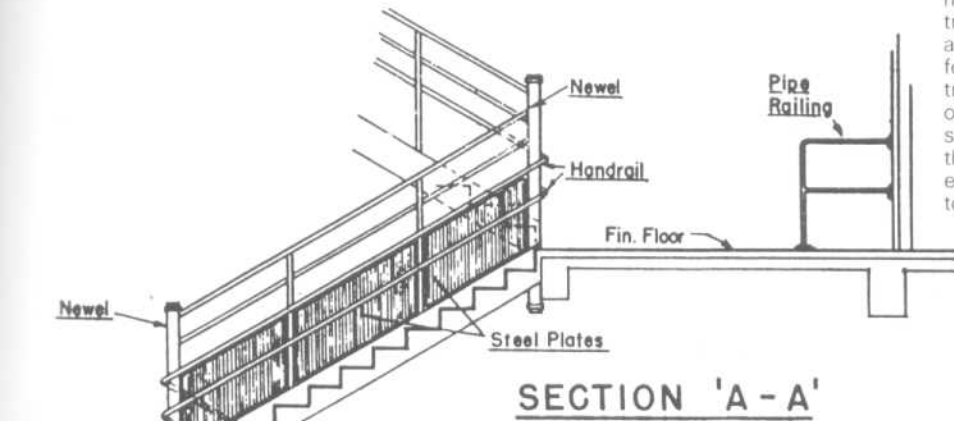
6 DETAIL OF STAIR # 4 LANDING  
SCALE: 1/4" = 1'-0"



STAIRS

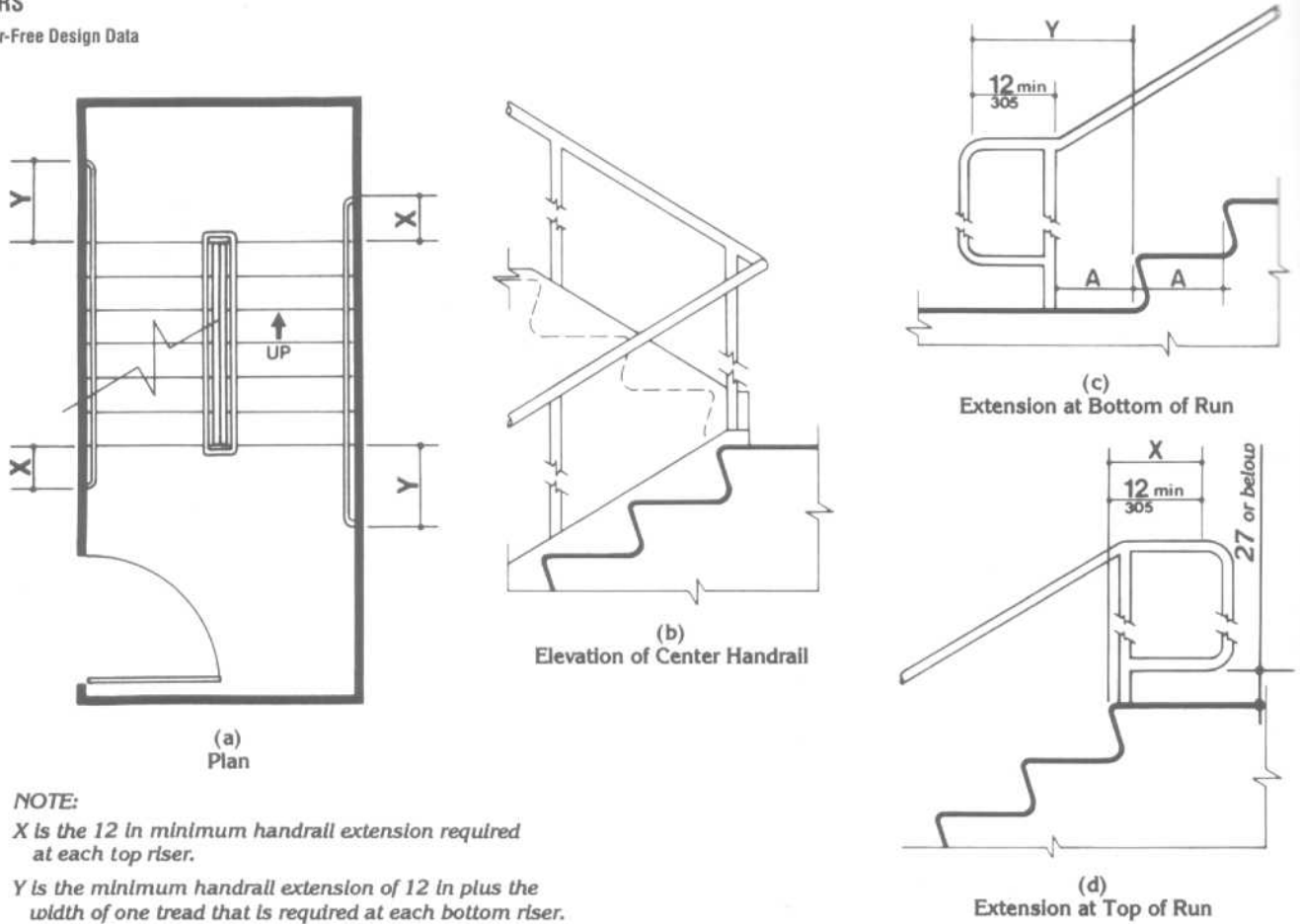
Planning Data

Any potential hazards must be eliminated. Stairs should be "easy going," that is, there must be an appropriate relationship of riser to tread. Treads are of nonslip material which is also extended onto platforms and landings for a distance equal to the width of the stair treads. Double handrails, one higher than the other, are provided on stairs for each line of short or tall pupils. The posts, which support the center handrails of double stairs, are extended high enough above the top handrail to prevent pupils from sliding down.



**STAIRS**

Barrier-Free Design Data



**NOTE:**

*X is the 12 in minimum handrail extension required at each top riser.*

*Y is the minimum handrail extension of 12 in plus the width of one tread that is required at each bottom riser.*

Fig. 23 Stair handrails.

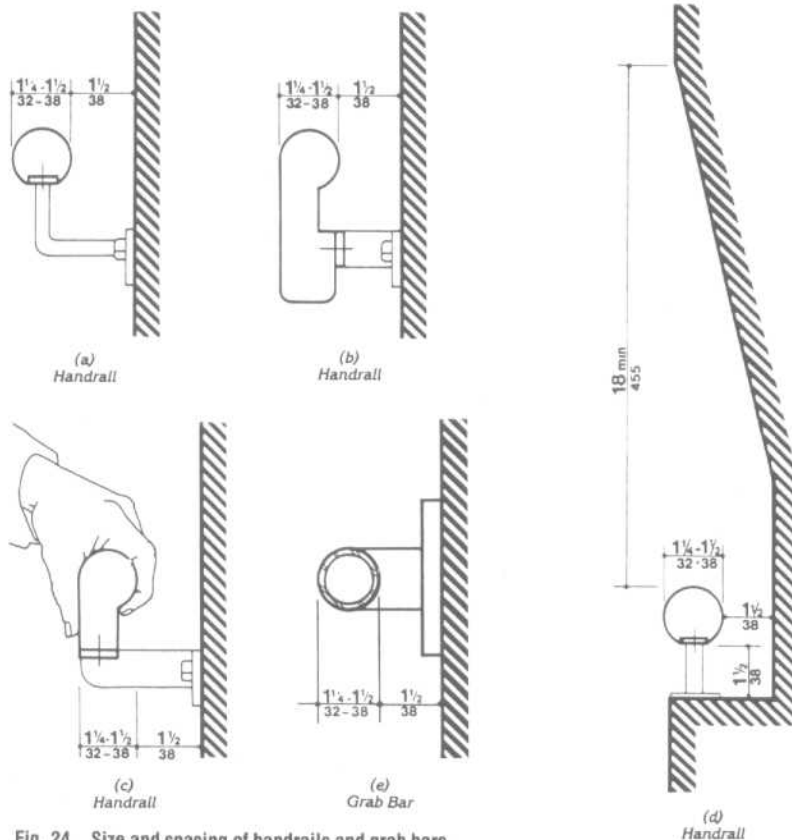


Fig. 24 Size and spacing of handrails and grab bars.

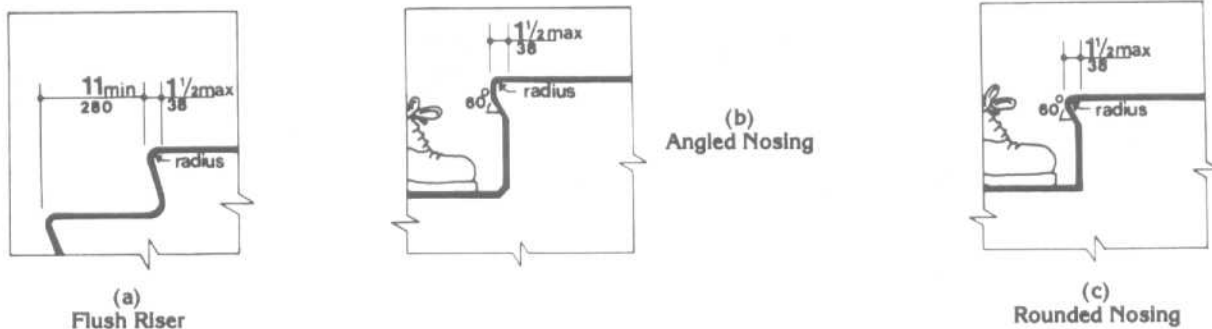


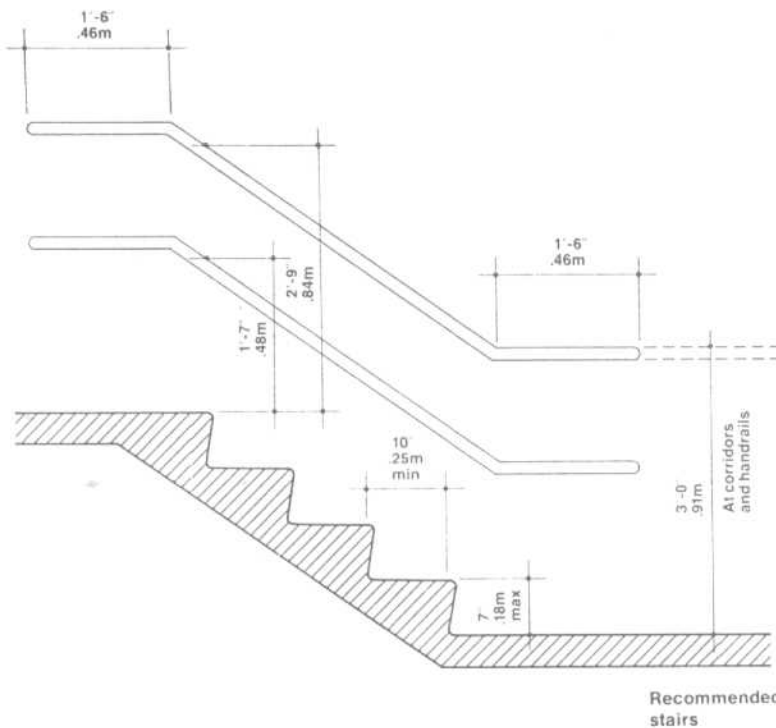
Fig. 25 Usable tread width and examples of acceptable nosings.

**Steps and Stairs**

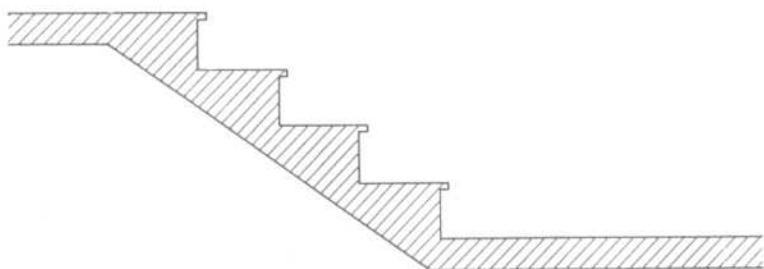
Steps and stairs should have nonprotruding nosings so that people with stiff joints, braces, artificial legs, or other leg or stability problems will not catch their toes as they climb.

Handrails should be oval or round with 1 1/2" / 4 cm hand clearance between the rails and the wall; 1 1/2" / 4 cm clearance will provide ease of grip but will prevent the hand or wrist from slipping between the handrail and the wall if the person loses balance. Handrails should be positioned on both sides of steps and stairs and should extend beyond the first and last steps on at least one side and preferably on both to allow people with long leg braces to pull themselves beyond these points. To guard against falls and to help children, some codes require another, lower handrail.

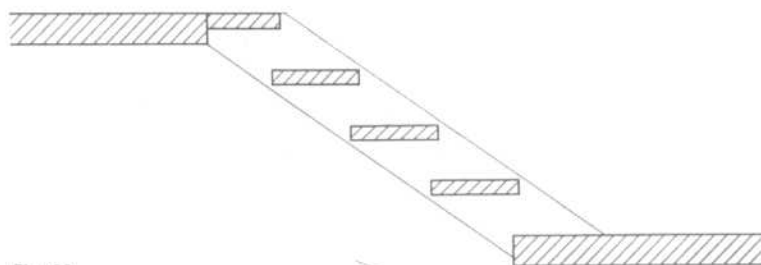
Steps, stairs, and handrails should not be made of slippery material.



Recommended stairs



Not acceptable

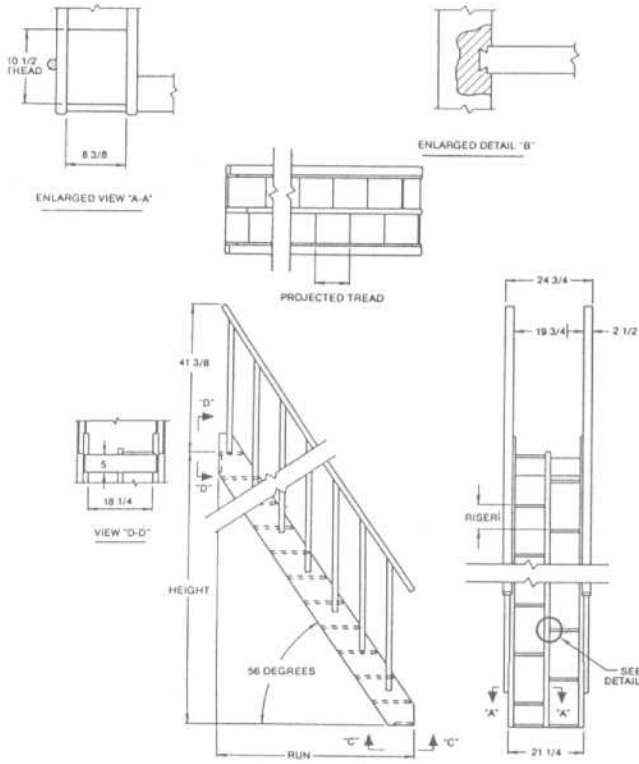


Not acceptable

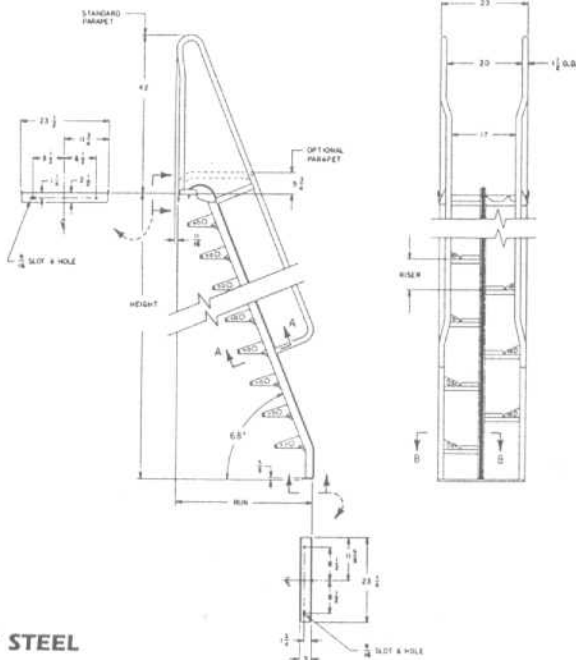
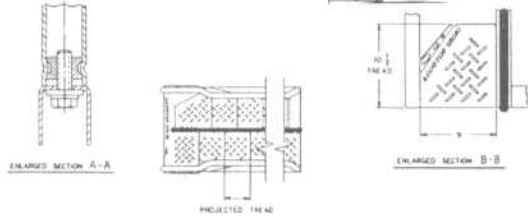
Fig. 26

STAIRS

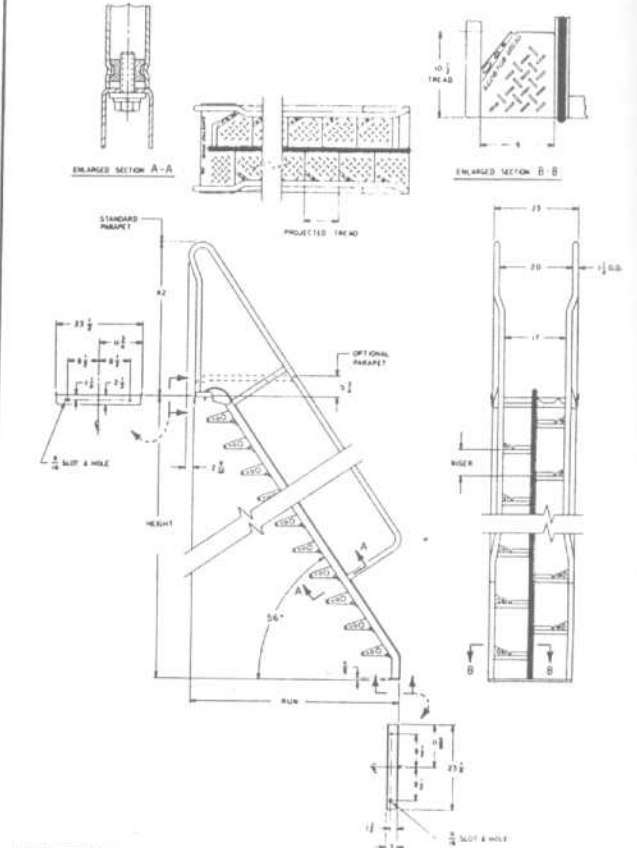
Ladders



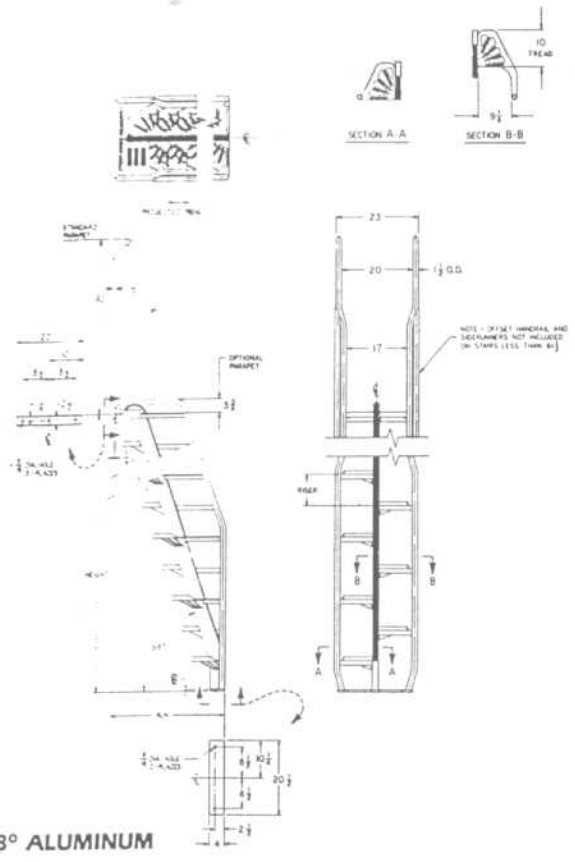
56° WOOD



68° STEEL



56° STEEL

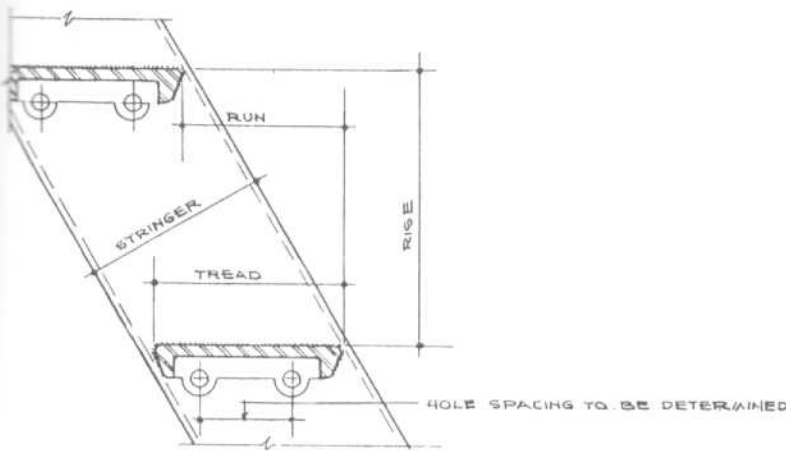


68° ALUMINUM

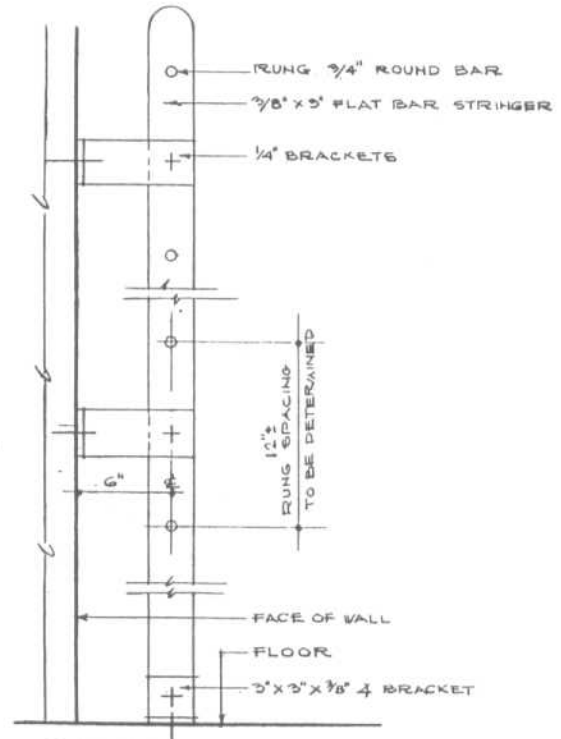
STAIRS

Ladders; Open Steel Stairs

LADDERS

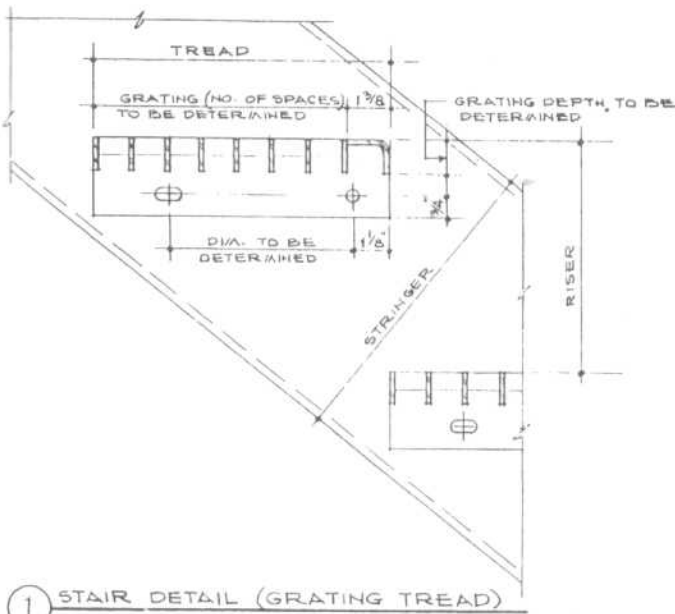


1 ENGINEERS LADDER WITH CAST ABRASIVE TREADS



2 VERTICAL LADDER

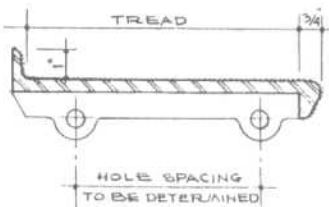
OPEN STEEL STAIRS



1 STAIR DETAIL (GRATING TREAD)

WIDTH OVERALL	CENTER TO CENTER SPACING
5 INCHES	2 INCHES O.C.
6	3
7	3 1/2
8	4
9	5
10	6

STANDARD HOLE SPACING FOR CAST ABRASIVE TREAD



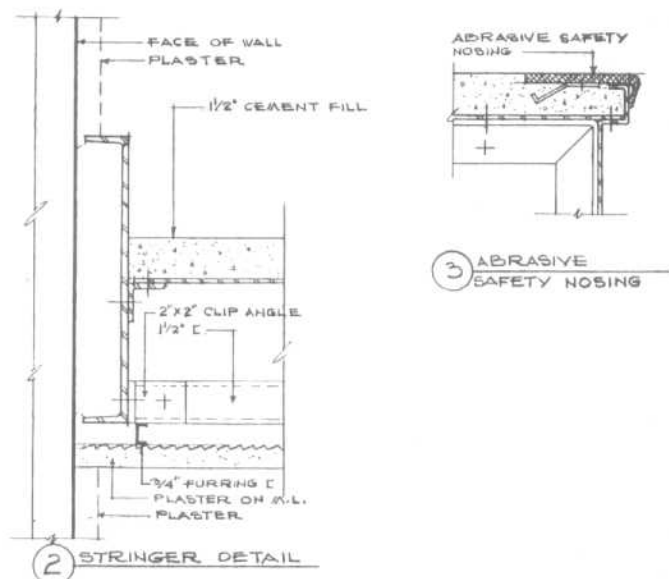
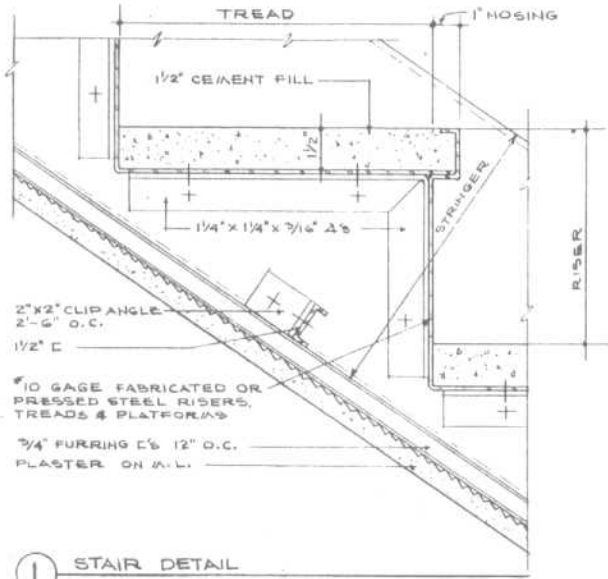
2 CAST ABRASIVE TREAD

THICKNESS IN INCHES	CAST IRON	CAST ALUMINUM	CAST BRONZE	CAST HICKLE-BRONZE
5/16"	UP TO 6" WIDE	UP TO 5" WIDE	UP TO 5" WIDE	UP TO 5" WIDE
3/8"	12"	18"	18"	18"
7/16"	24"	26"	24"	24"
1/2"	30"	36"	30"	30"
5/8"	42"	42"	36"	36"

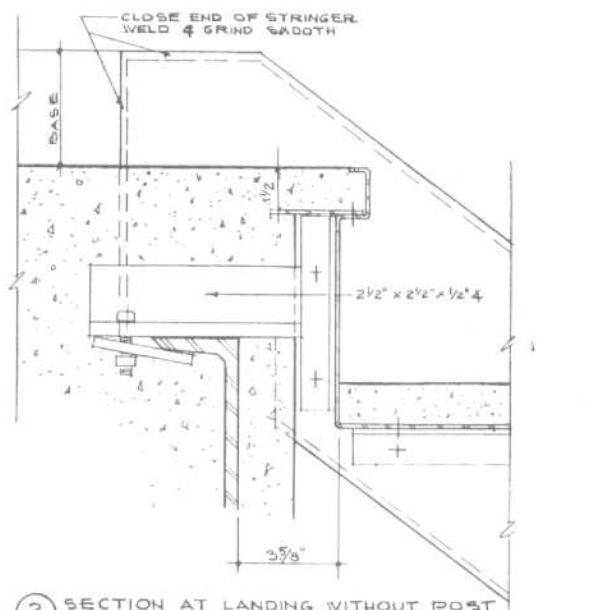
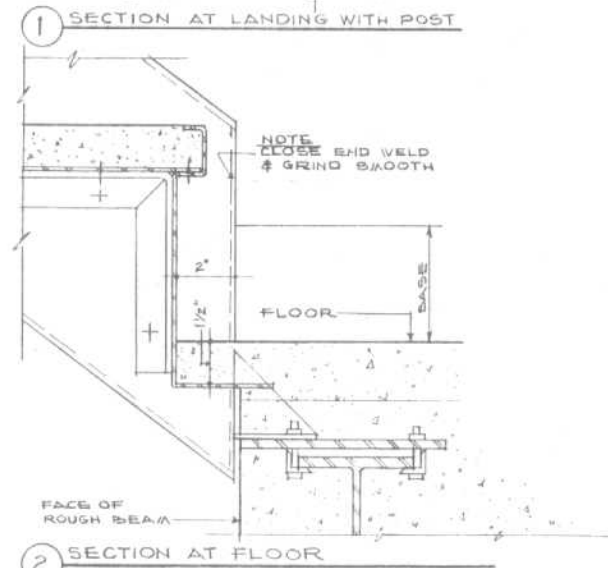
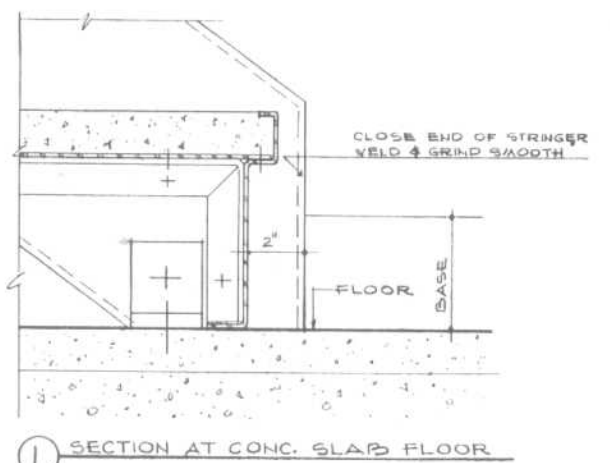
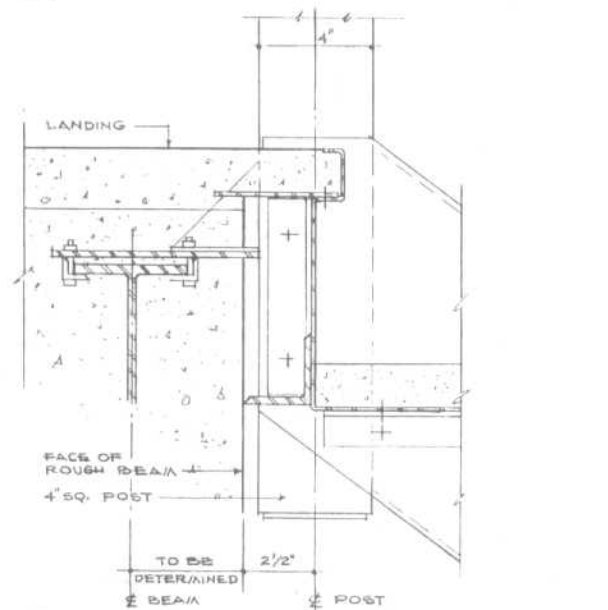
THICKNESS LIMITATIONS FOR VARIOUS WIDTH CASTINGS

STAIRS

Steel Pan Cement-Filled Stairs



NOTE:  
STRINGER DETAIL SIMILAR FOR STAIRS  
WITH TERRAZZO OR MARBLE TREADS  
& RISERS



STAIRS

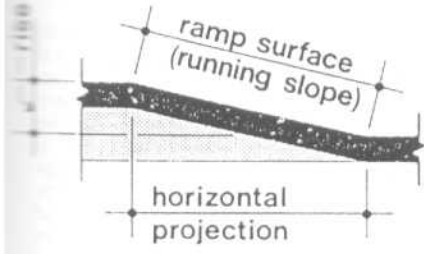
Barrier-Free Ramps

**Slopes and rise** Provide the least practical slope for any ramp or curb ramp subject to the following new construction requirements:

1. Maximum running slope shall not exceed 1:12 (8.3%)
2. Maximum rise for any run shall not exceed 2'6" (760 mm)

**Width** Ramps and curb ramps shall have a minimum clear width of 3'0" (915 mm) exclusive of edge protection or flared sides.

**Cross-slope and surface** Cross-slope of ramp surfaces shall not exceed 1:48 (¼ in/ft).



slope	maximum rise		maximum projection	
	in	mm	ft	m
1:12 to < 1:16	30	760	30	9
1:16 to < 1:20	30	760	40	12

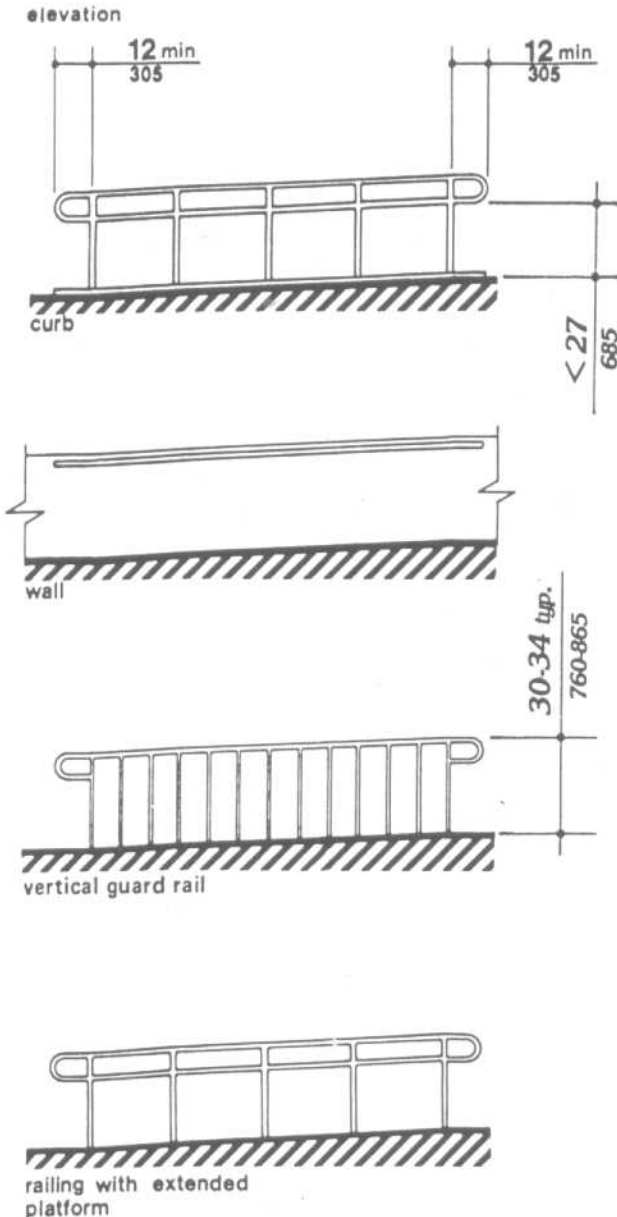
**maximum rise & projection**  
new construction

slope	maximum rise		maximum projection	
	in	mm	ft	m
1:10 to 1:8	3	75	2	0.6
1:12 to 1:10	6	150	5	1.5

**maximum rise & projection**

alterations to existing construction

ramp slope



section

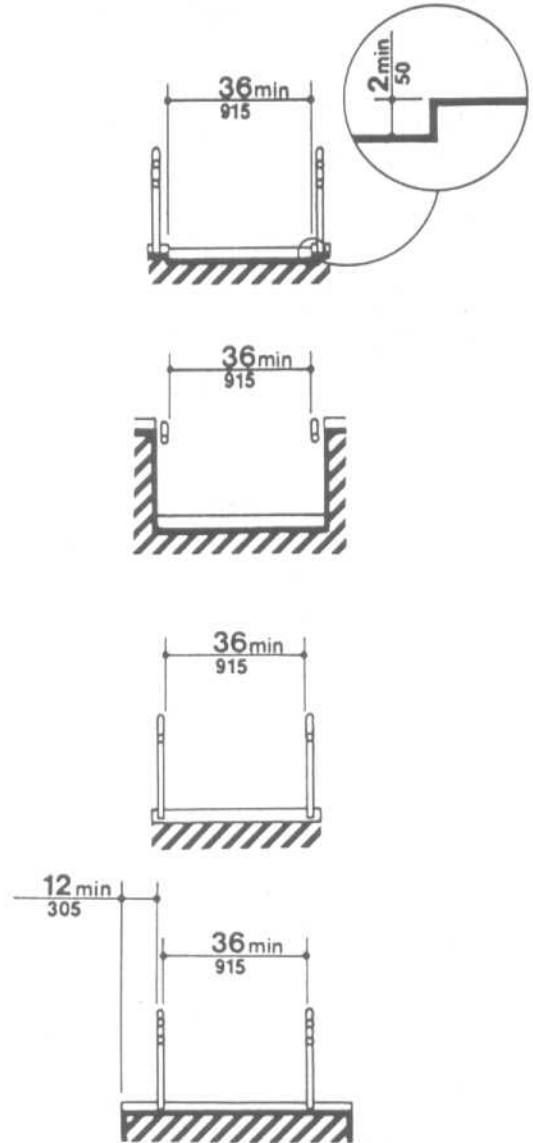


Fig. 27 Examples of edge protection and handrail extensions.

## FIREPLACES

The function of the fireplace today differs dramatically from its role of years ago. Whereas its original function was primarily to provide heat for warmth and/or cooking, today it serves more as a decorative asset and as the focal point of interior spaces and conversational groupings, providing the esthetic pleasure and comfort of firelight.

Of particular interest to the interior designer is the proportion and scale of the fireplace opening, the treatment of wall surfaces surrounding the fireplace, the design of mantel pieces and hearth extensions, and the array of fireplace accessories available. Accordingly, the information contained in this section addresses these considerations. Drawings include elevations, plans, and details of various fireplaces; elevations of a wide selection of prefabricated mantel types; and a sampling of fireplace accessories including andirons, wrought iron fire sets, and log grates. It should be noted that, aside from their decorative aspects, the fireplace and chimney have important structural implications and require special foundations. Moreover, the fireplace must be designed to carry smoke away safely.

With respect to hearth extensions, most building codes require that for fireplaces having an opening of less than 6 ft<sup>2</sup> (0.56 m<sup>2</sup>), the hearth must extend a minimum of 16 in (406 mm) beyond the face of the opening and a minimum of 8 in (203 mm) on each side. For fireplaces whose openings exceed 6 ft<sup>2</sup>, the hearth must extend a minimum of 20 in (508 mm) beyond the face of the opening and 12 in (305 mm) on each side.

Most building codes also require that woodwork or other combustible materials not be placed within 6 in (153 mm) of a fireplace opening, and that combustible material within 12 in (305 mm) of a fireplace

opening not project more than 1/8 in for each 1-in distance from such an opening.

Since building codes may vary, it is important that the designer have her or his plans checked for conformance with the applicable local or state codes. Any structural modifications to an existing fireplace and chimney or the design of a new fireplace and chimney should be reviewed by a professional engineer or registered architect.

A fireplace that draws properly can be assured by applying proper principles of design. The size of flue should be adequate and should be based upon the size of the fireplace opening. One rule commonly used is to take one-tenth of the area of the fireplace opening to find the minimum area of the flue. For example, if a fireplace had an opening 3 ft wide by 2 ft 6 in high, it would have an area of 1080 in<sup>2</sup>. One-tenth of 1080 in<sup>2</sup> equals 108 in<sup>2</sup>. The standard-size flue nearest to this requirement and readily available is a 13- by 13-in flue lining, which has an inside cross-sectional area of 126.56 in<sup>2</sup>. One could also use a 13-in round flue that has a cross-sectional area of 113.0 in<sup>2</sup>.

The front of the fireplace should be wider than the back and the upper part of the back should tilt forward to meet the throat in order to throw heat into the room instead of up the chimney. The arch over the top of the fireplace opening should be only 4 in thick, and the throat should project toward the front as much as possible to form the smoke shelf behind it. The area of the throat should be 1 1/4 times the area of the flue, with minimum and maximum width of 3 and 4 1/2 in, respectively, so that the narrow throat will cause a quick suction into the flue. The sides of the fireplace above the throat are drawn together to form the flue, which always starts exactly over the center of the width of the fireplace.

The smoke shelf is very necessary to stop back drafts. The depth of the fireplace should be one-half the height of the opening, with a maximum of 24 in. The back should rise one-half the height of the opening before sloping forward and should be two-thirds the opening in width.

The back, sides, and parts of the hearth that are under the fire must be built of heat-resistant materials. Firebrick laid in fire clay is the best combination.

The damper is a large valve that can be adjusted to regulate the draft. Many types of commercial damper units are manufactured. The position of a damper unit is important. The damper is generally set about 8 in above the top of the fireplace opening and is concealed by the brickwork. One advantage of these units is that they are correctly designed and have correctly proportioned throat damper and chamber to provide a form for the masonry and to reduce the risk of failure in the function of the completed fireplace.

The hearth consists of two parts, the front or finish hearth and the back hearth under the fire. The front hearth is simply a precaution against flying sparks and, while it must be noncombustible, it need not resist intense prolonged heat. Because the back hearth must withstand intense heat, it is built of heat-resistant materials. In buildings with wood floors, the hearth in front of the fireplace should be supported on masonry. The front hearth should project at least 16 in from the front of the fireplace.

At the back part of the hearth it is customary to have an ash dump for dropping the ashes into the ash pit, which is generally located in the basement with a door for cleaning out ashes.



FIREPLACES

Components and Terminology

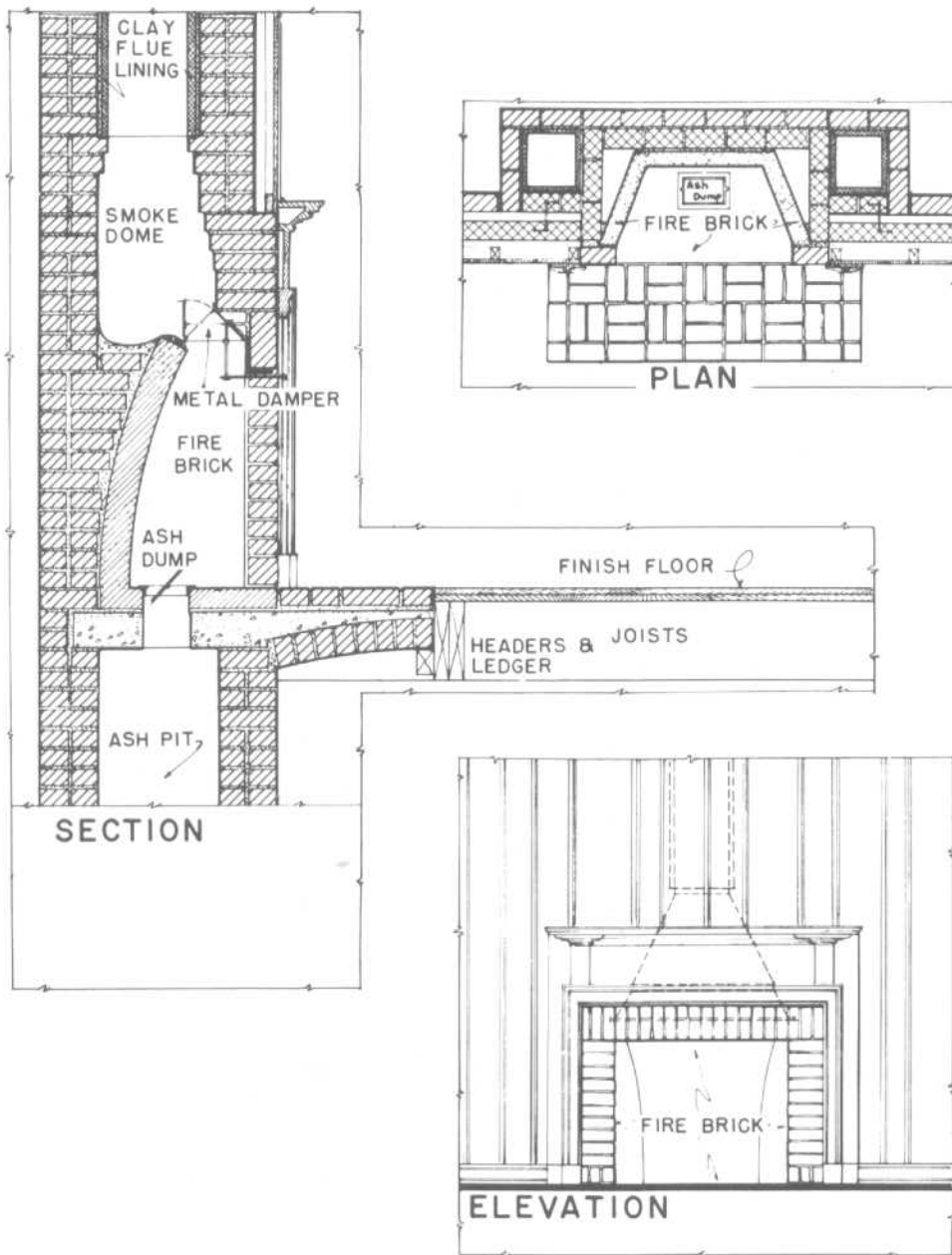


Fig. 1 Construction details of a typical fireplace.

FIREPLACES

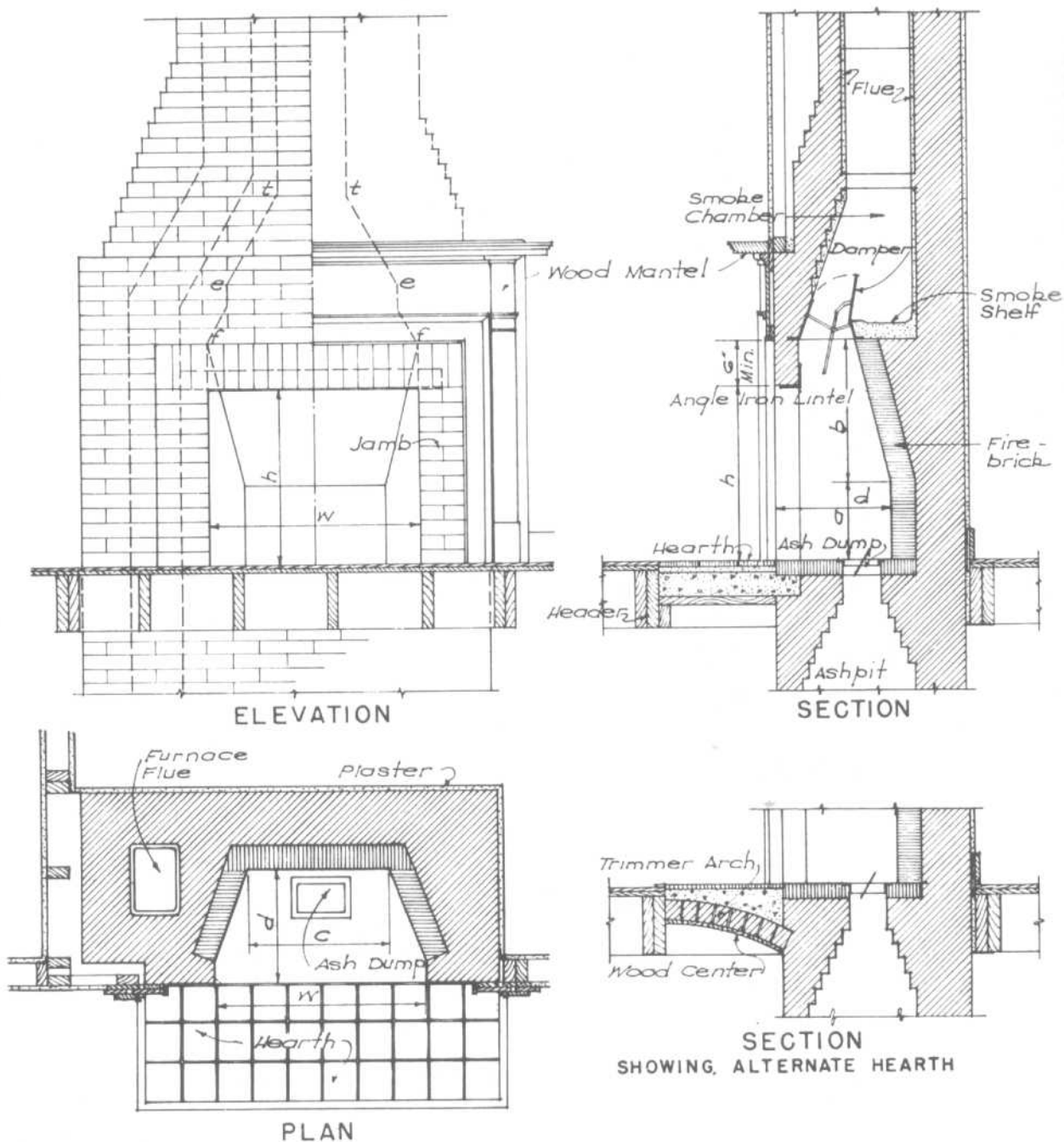
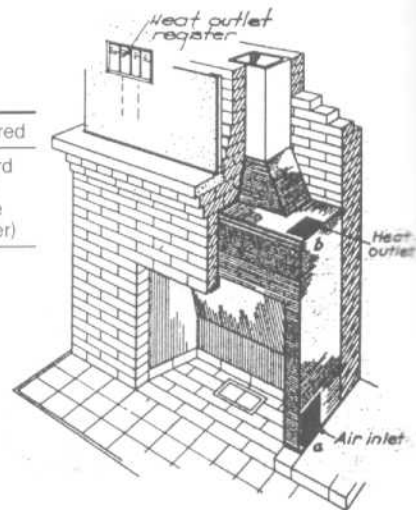
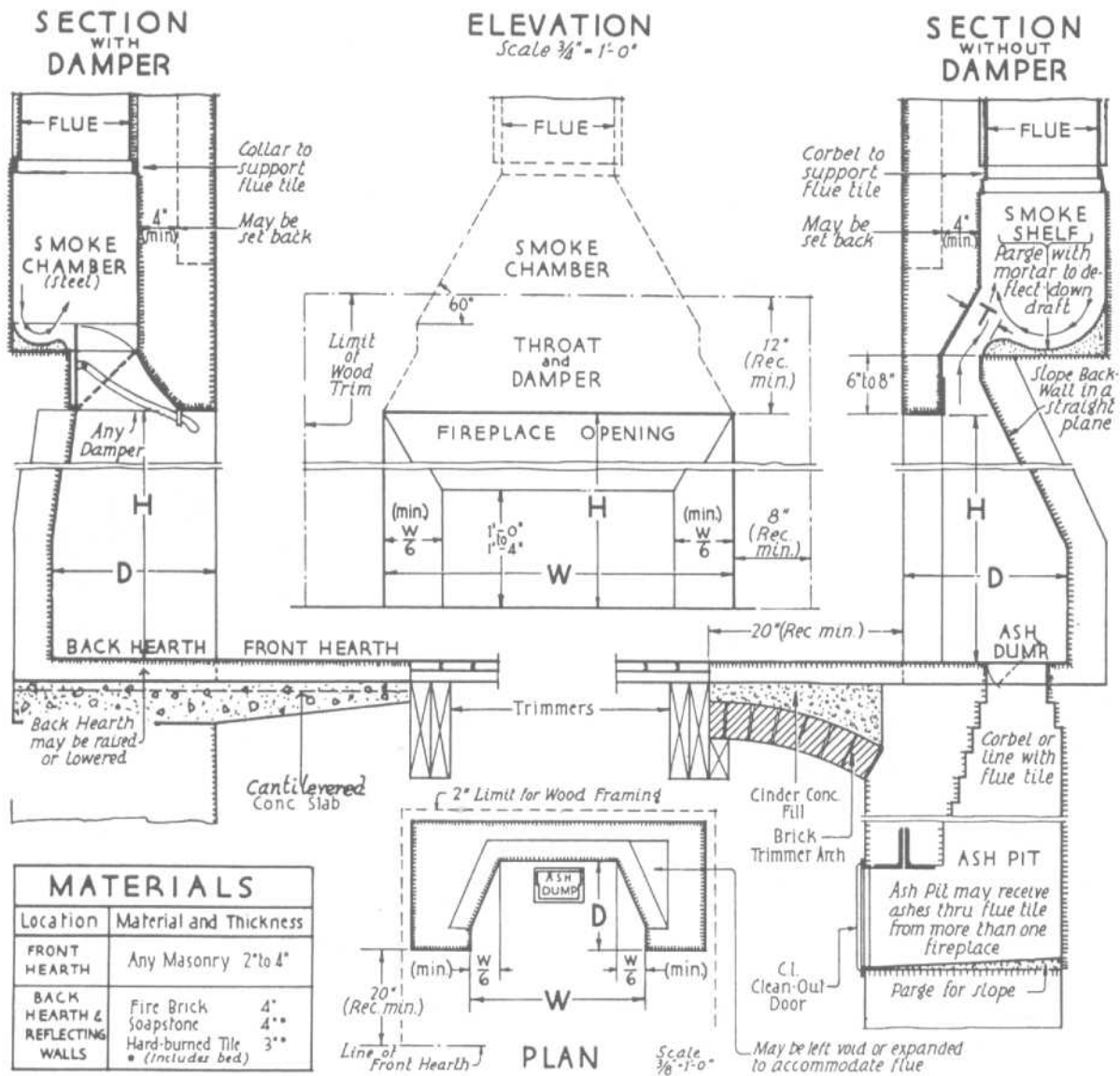


Fig. 2 Construction details of a typical fireplace.

TABLE 1 Recommended Dimensions for Fireplaces and Size of Flue Lining Required  
(Letters in column heads refer to Fig. 2; all dimensions in inches)

Size of fireplace opening		Depth, <i>d</i>	Minimum width of back wall, <i>c</i>	Height of vertical back wall, <i>a</i>	Height of inclined back wall, <i>b</i>	Size of flue lining required	
Width, <i>w</i>	Height, <i>h</i>					Standard rectangular (outside dimensions)	Standard round (inside diameter)
24	24	16-18	14	14	16	8½ × 13	10
28	24	16-18	14	14	16	8½ × 13	10
30	28-30	16-18	16	14	18	8½ × 13	10
36	28-30	16-18	22	14	18	8½ × 13	12
42	28-32	16-18	28	14	18	13 × 13	12
48	32	18-20	32	14	24	13 × 13	15
54	36	18-20	36	14	28	13 × 18	15
60	36	18-20	44	14	28	13 × 18	15
54	40	20-22	36	17	29	13 × 18	15
60	40	20-22	42	17	30	18 × 18	18
66	40	20-22	44	17	30	18 × 18	18
72	40	22-28	51	17	30	18 × 18	18





FIREPLACE DIMENSIONS (In Inches)		RECOMMENDED FLUE SIZES (In Inches)					
		FIREPLACE WIDTH W	RECTANGULAR FLUES			EQUIVALENT ROUND	
W	H		D	Flue Area	Effective Area	Inside Diameter	Effective Area
24 to 84	$\frac{2}{3}$ to $\frac{3}{4}$ W	24	8 1/2 x 8 1/2	7 1/4 x 7 1/4	41**	8	50.3**
$\frac{1}{2}$ to $\frac{2}{3}$ H { 16 to 24 (Rec) for Coal 18 to 24 (Rec) for Wood		30 to 34	8 1/2 x 13	7 x 11 1/2	70**	10	78.54**
FLUE (Effective Area) 1/8 WH for unlined flue 1/10 WH for rectangular lining 1/12 WH for circular lining		36 to 44	13 x 13	11 1/4 x 11 1/4	99**	12	113.0**
		46 to 56	13 x 18	11 1/4 x 6 3/4	156**	15	176.7**
T (Area)	$\frac{3}{4}$ to $\frac{3}{2}$ FLUE AREA	58 to 68	18 x 18	15 3/8 x 5 3/4	195**	18	254.4**
T (Width)	3" minimum to 4 1/2" maximum	70 to 84	20 x 24	17 x 21	278**	22	380.13**

**FIREPLACES**

Through or Two-Way

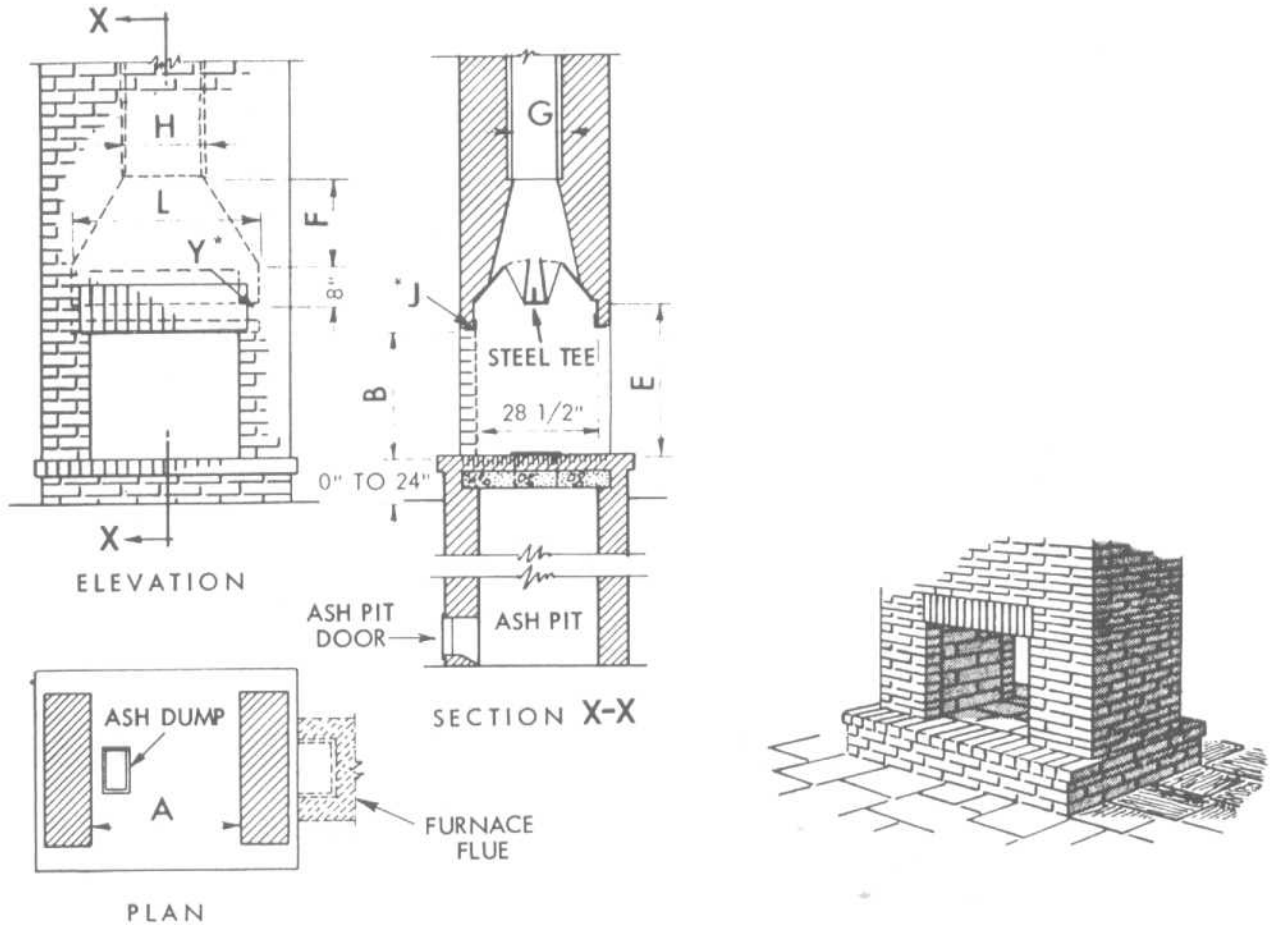


Fig. 3 Fireplace open on both sides.

TABLE 2 Table of Dimensions and Equipment (in inches)

Width of opening, A	Height of opening, B	Damper height, E	Smoke chamber, F	Old flue size		New flue size		Angle (2 req'd),* J	L	Tee	Ash dump	Ash-pit door
				G	H	G	H					
28	24	30	19	13	13	12	16	A-36	36	35	58	12 x 8
32	29	35	21	13	18	16	16	A-40	40	39	58	12 x 8
36	29	35	21	13	18	16	20	A-42	44	43	58	12 x 8
40	29	35	27	18	18	16	20	A-48	48	47	58	12 x 8
48	32	37	32	18	18	20	20	B-54	56	55	58	12 x 8

\*Angle sizes: A—3 x 3 x 3/16; B—3 1/2 x 3 1/2 x 1/4".

Note Y from Fig. 3: The damper and the steel T should not be built-in solid at the ends, but given freedom to expand with heat.

**FIREPLACES**  
Corner Design

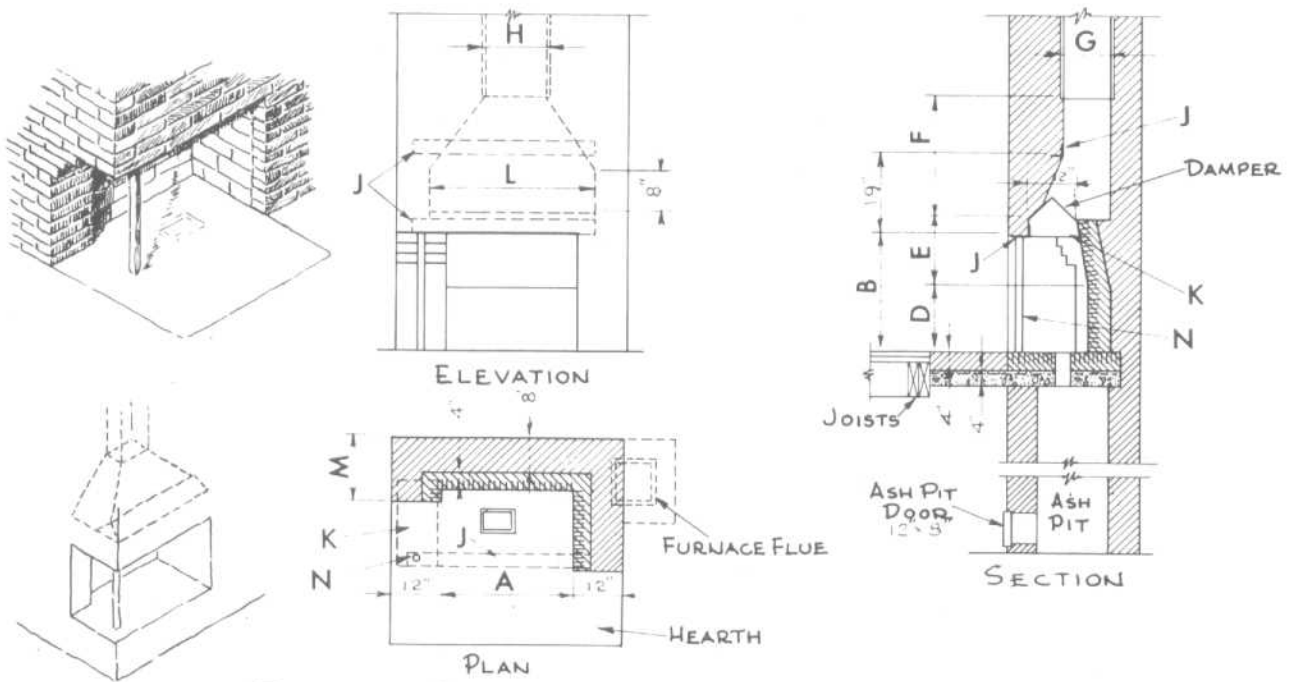


TABLE OF DIMENSIONS AND EQUIPMENT (IN INCHES)

A	B	C	D	E	F	OLD FLUE SIZES		NEW FLUE SIZES		L	M	STEEL ANGLE J*	PLATE LINTEL K	CORNER POST N				
						IN	OUT	IN	OUT									
28	26½	20	14	20	29¼	11¼	13	11¼	13	10¼	12	10¼	12	36	16	*A-36	11x16	3φx26½
32	26½	20	14	20	32	11¼	13	11¼	13	10¼	12	13½	16	40	16	*A-42	11x16	3φx26½
36	26½	20	14	20	35	11¼	13	11¼	13	10¼	12	13½	16	44	16	*A-48	11x16	3φx26½
40	29	20	14	20	35	11¼	13	15¾	18	13½	16	13½	16	48	16	*B-54	11x16	3φx29
48	29	24	14	24	43	11¼	13	15¾	18	13½	16	13½	16	56	20	*B-60	11x16	3φx29

\* ANGLE SIZES      \*A 3 x 3 x 3/16      \*B 3 1/2 x 3 1/2 x 1/4

Fig. 4 Corner fireplace.

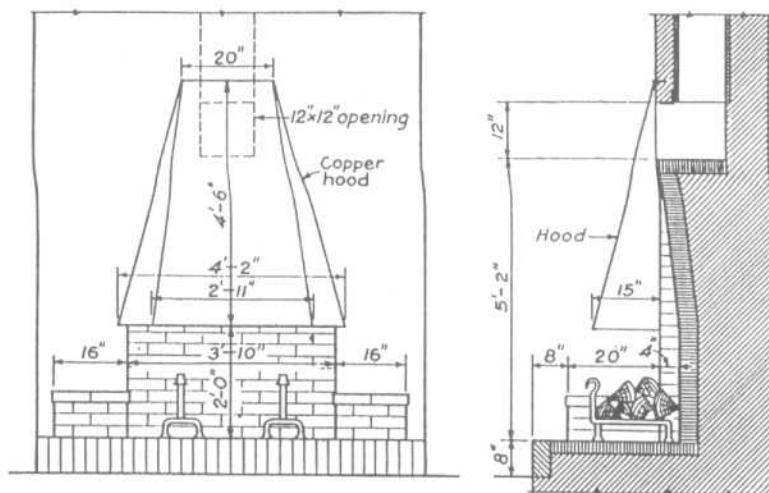
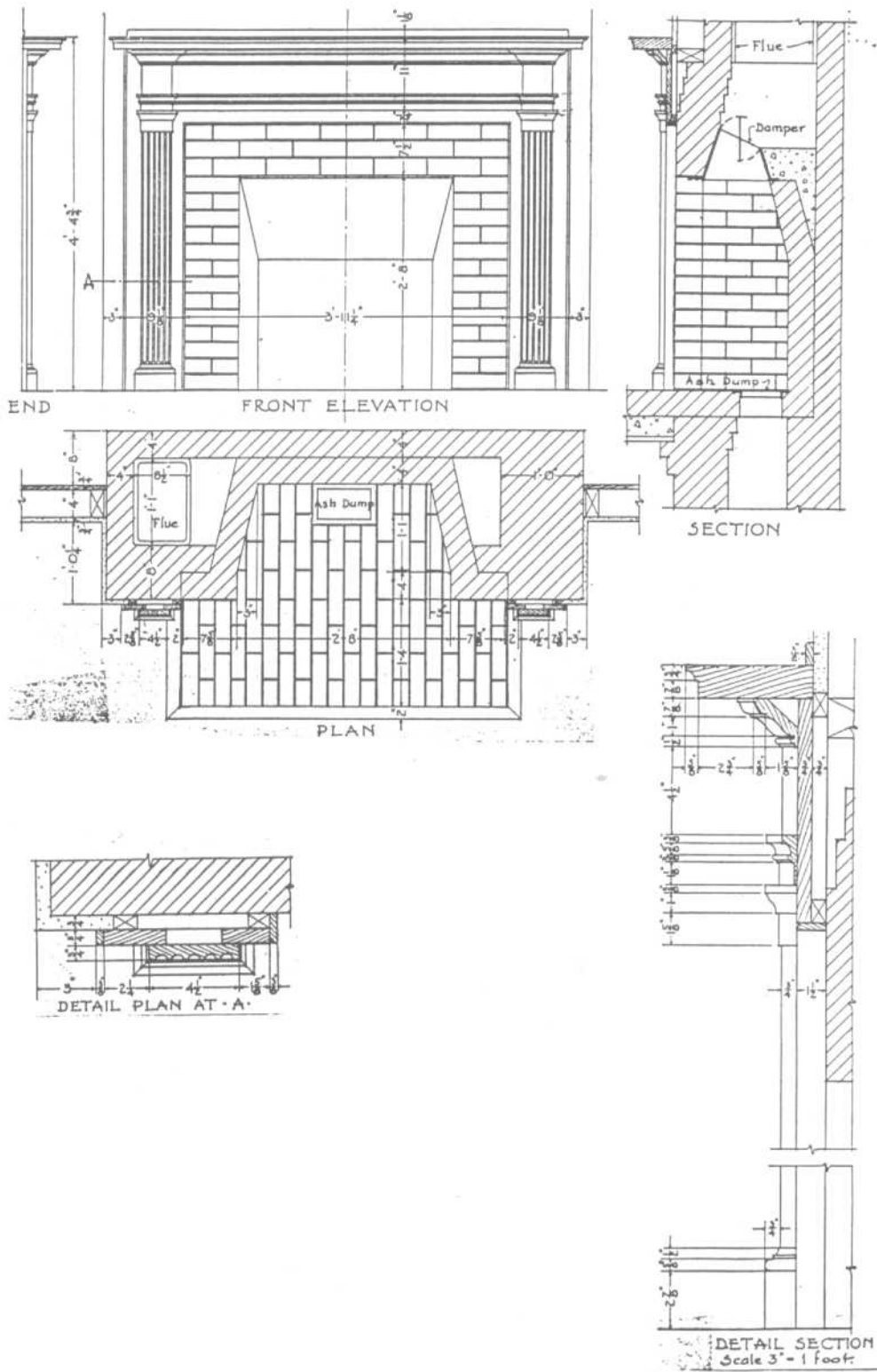
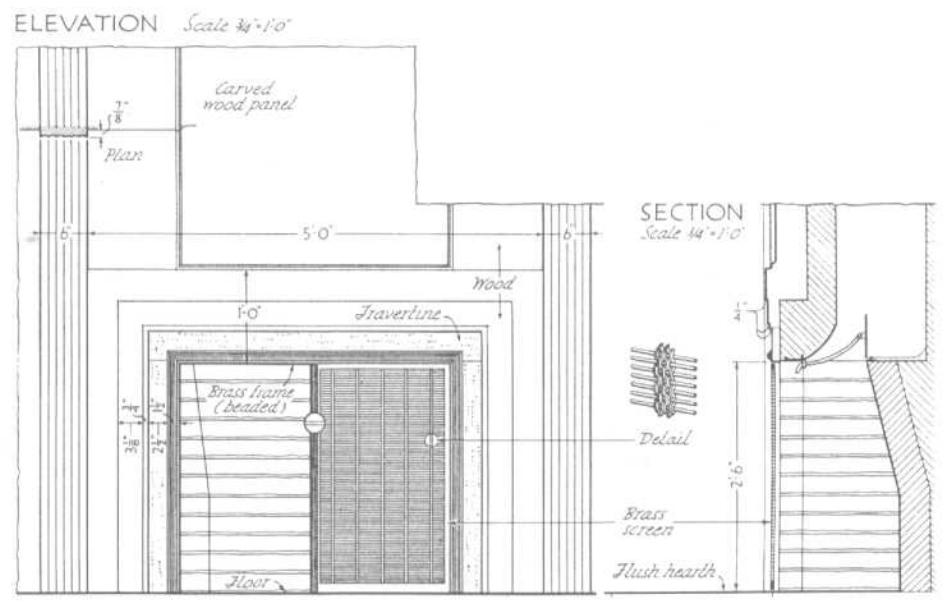
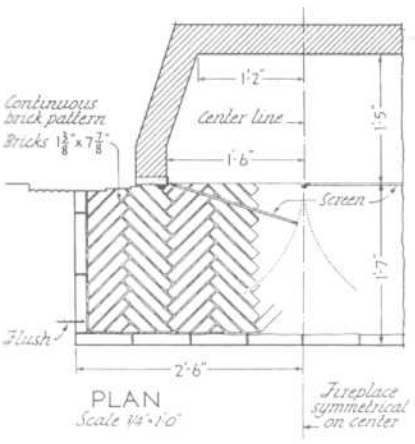
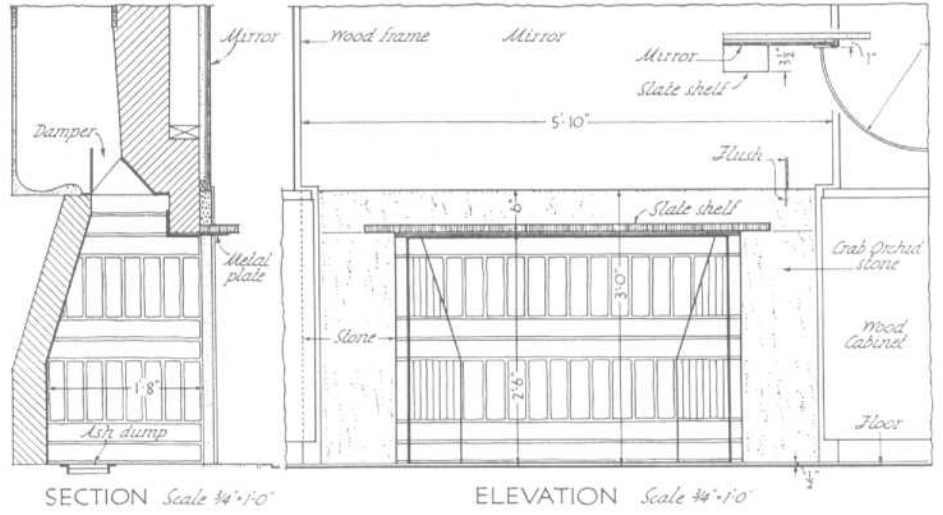
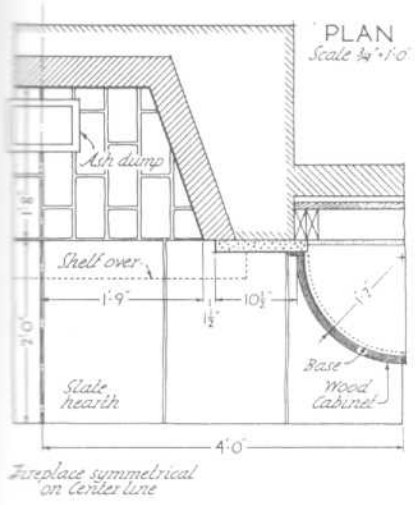


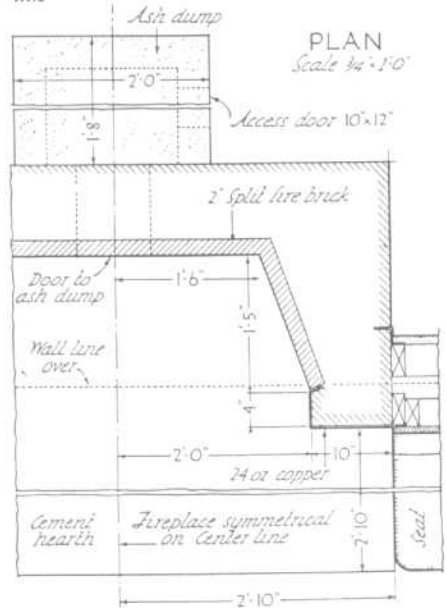
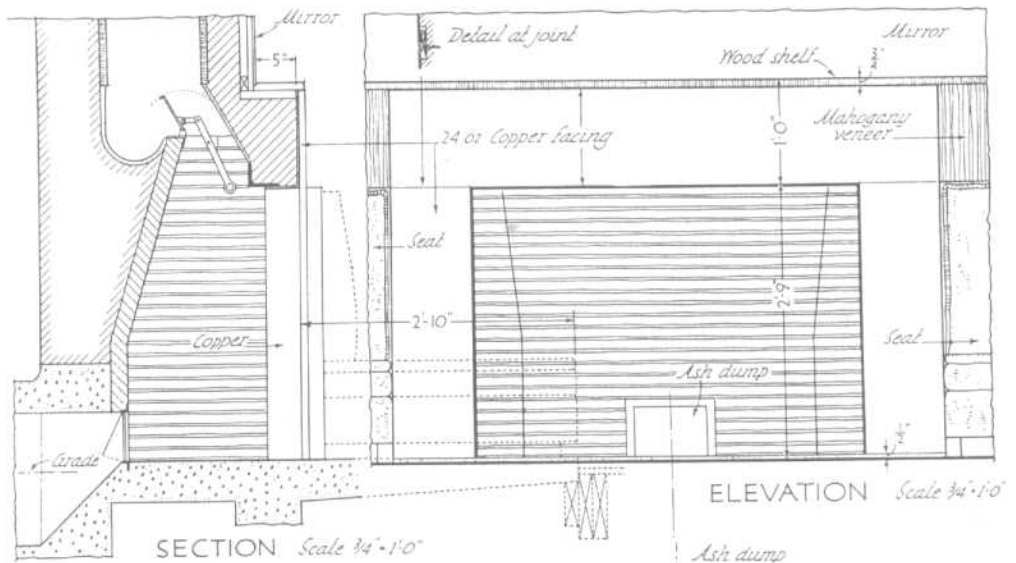
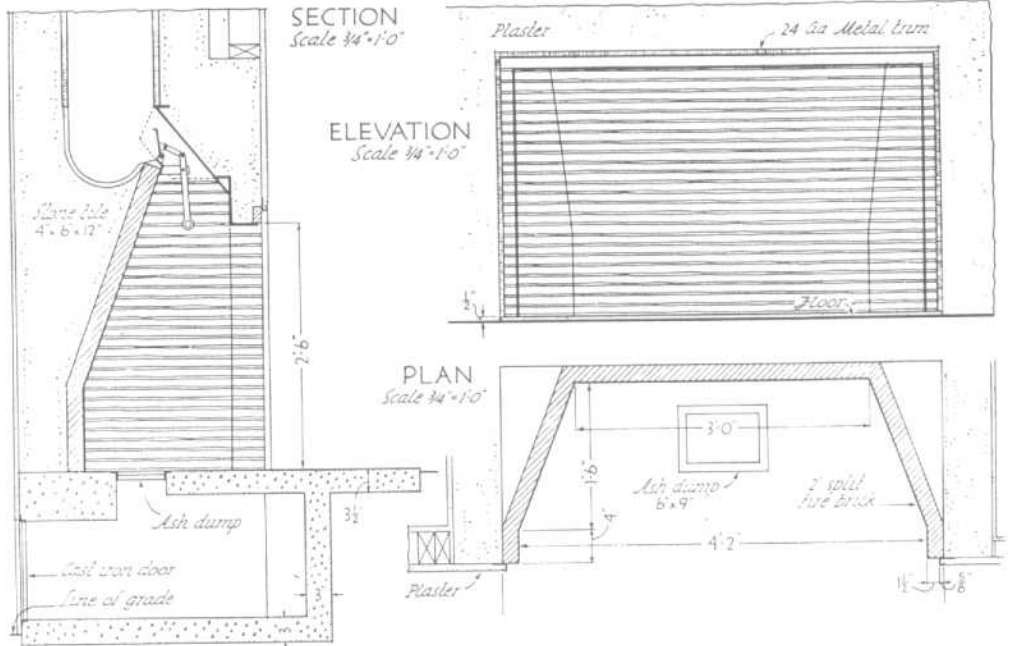
Fig. 5 A shallow fireplace with a copper hood, built as shown, throws out considerable heat after the hood gets hot. The wall should be of fire-resistant masonry.

FIREPLACES

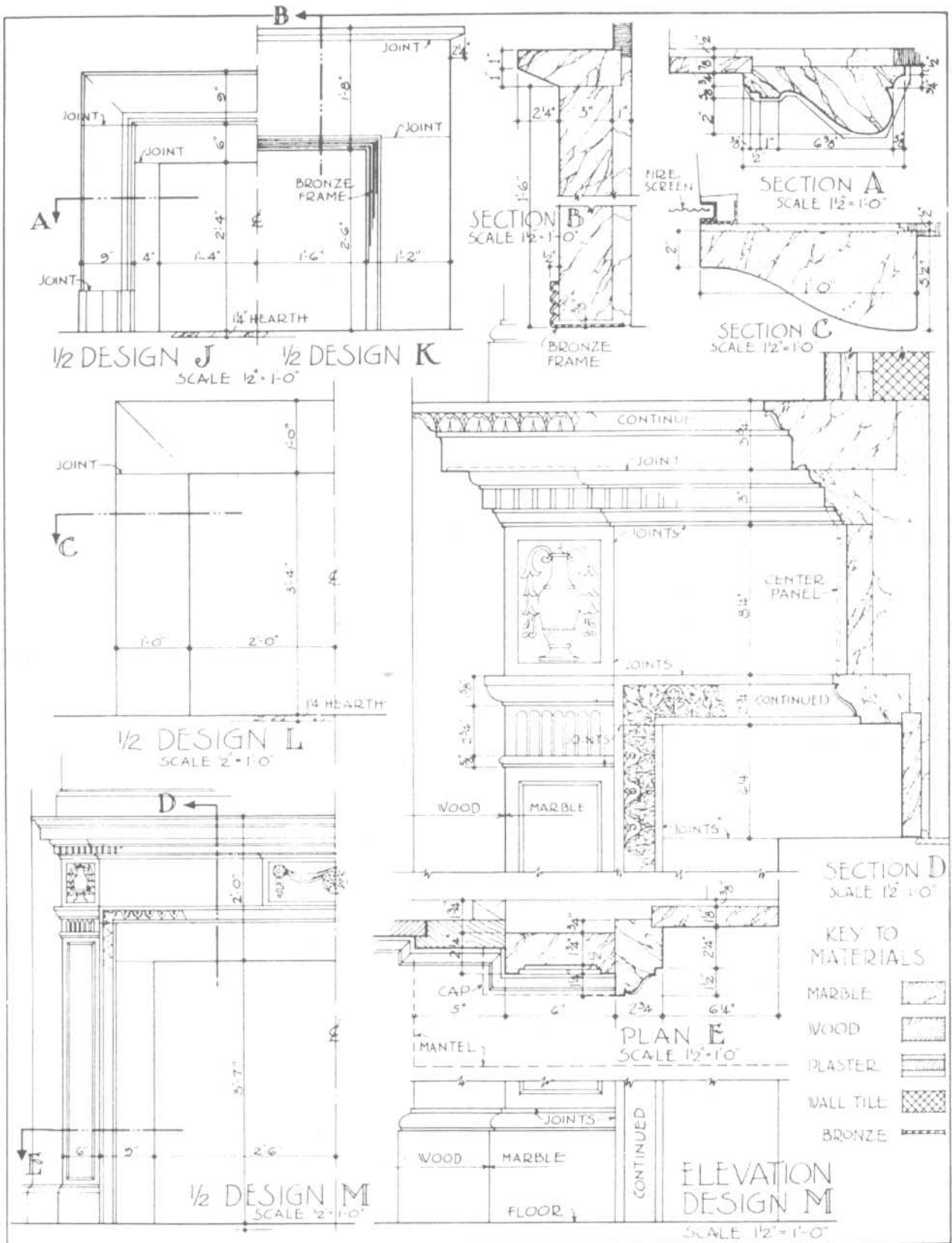




FIREPLACES

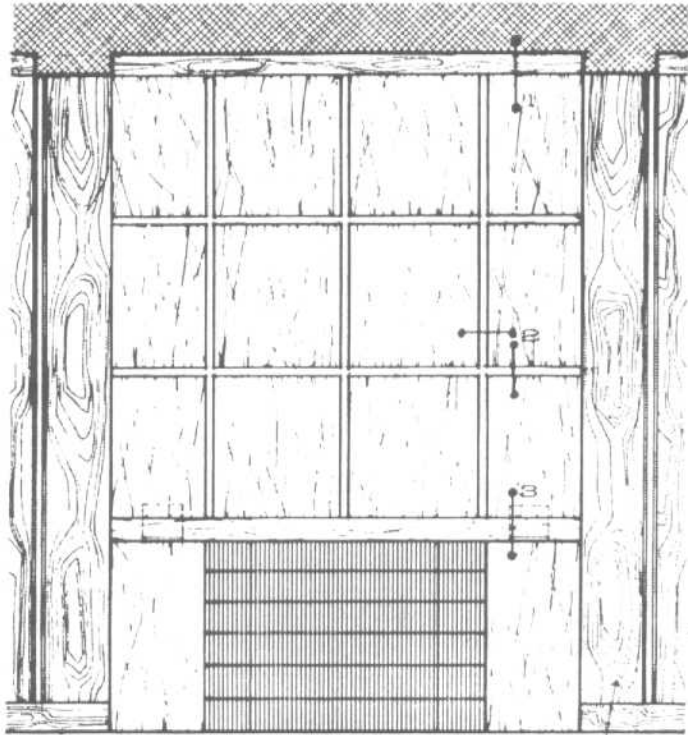




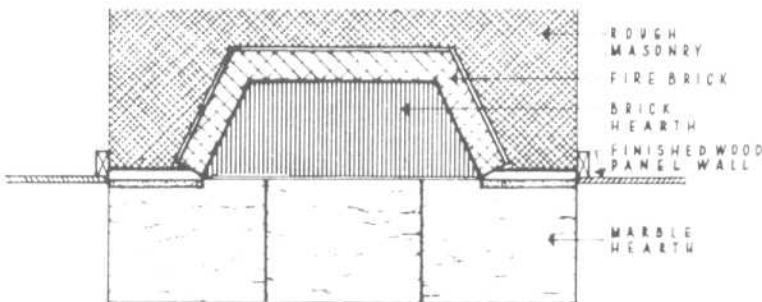
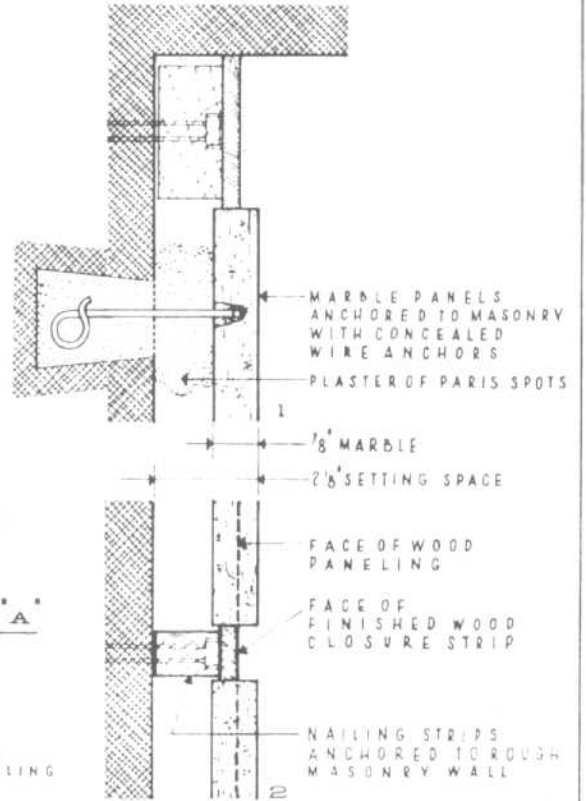


FIREPLACES

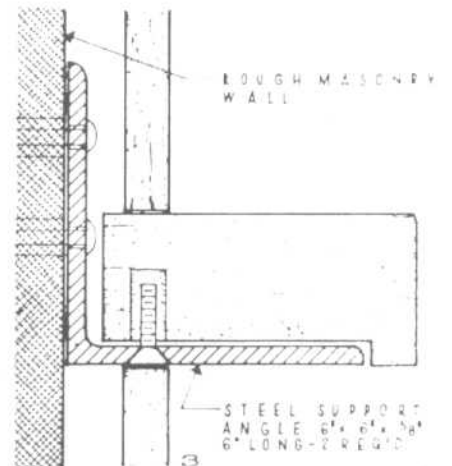
Marble Mantels



ELEVATION



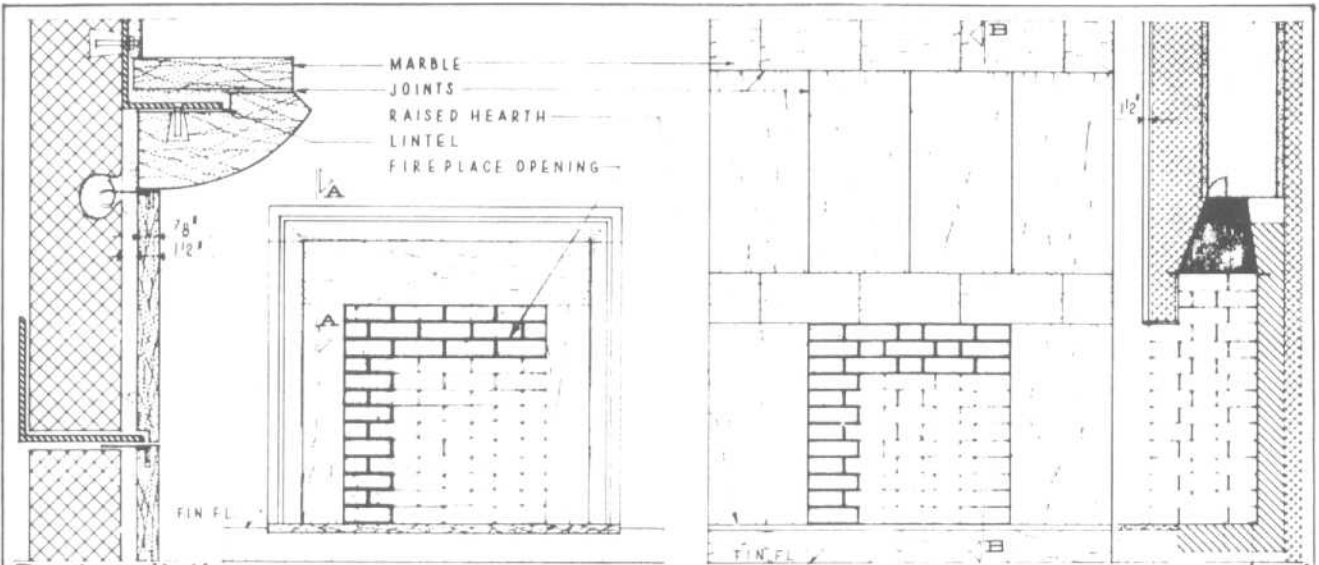
PLAN AT 'A'



DETAILS

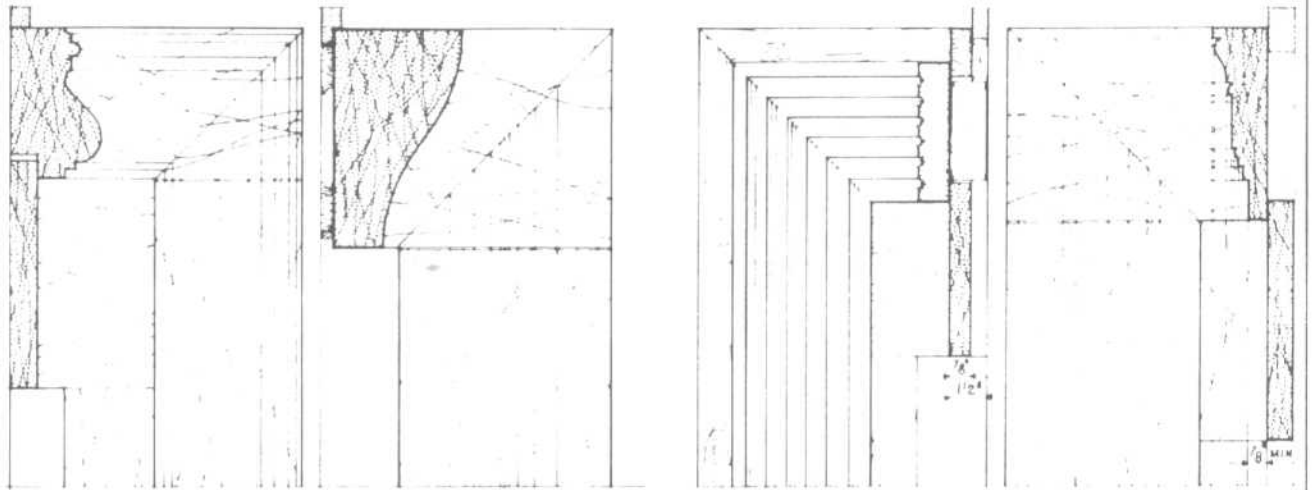
FIREPLACES

Marble Mantels

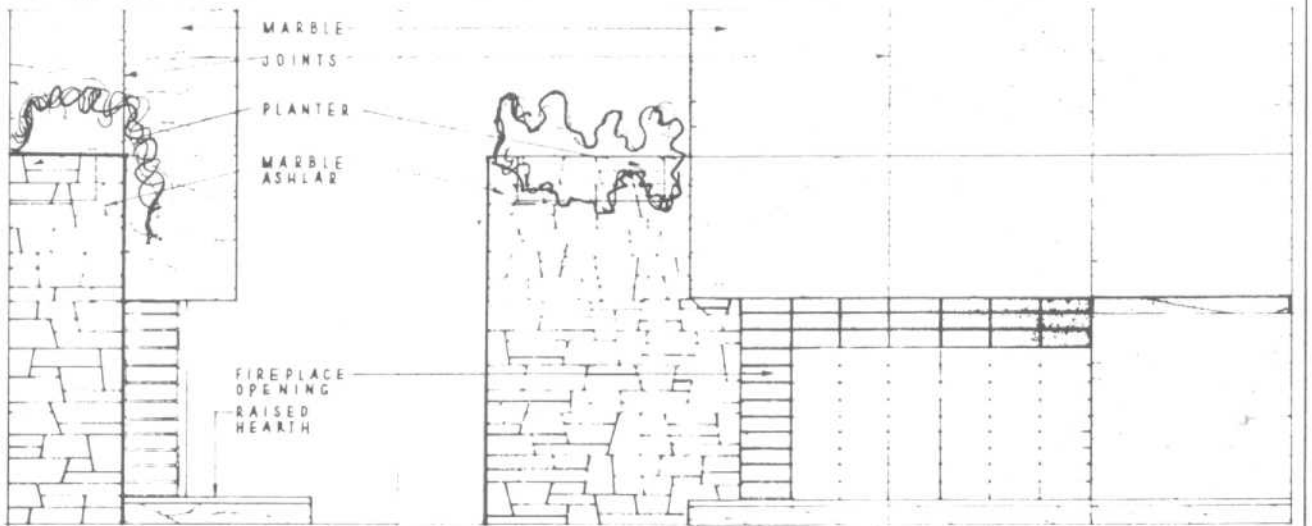


Section 'A-A' Elevation  
FIREPLACE DESIGN 'A'

Elevation Section 'B-B'  
FIREPLACE DESIGN 'B'



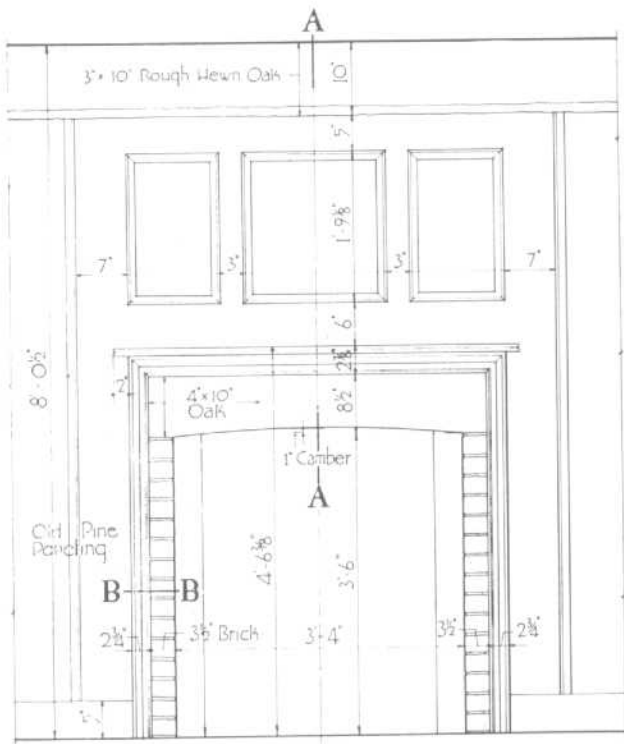
Design 1 Design 2 Design 3 Design 4  
MARBLE MANTEL FACING DETAILS



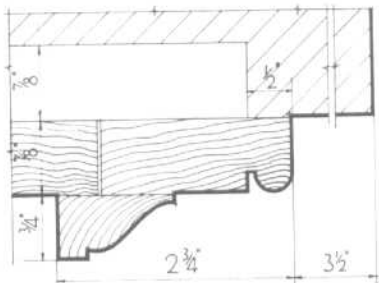
Side elevation Front elevation  
DETAIL OF CORNER FIREPLACE IN MARBLE

FIREPLACES

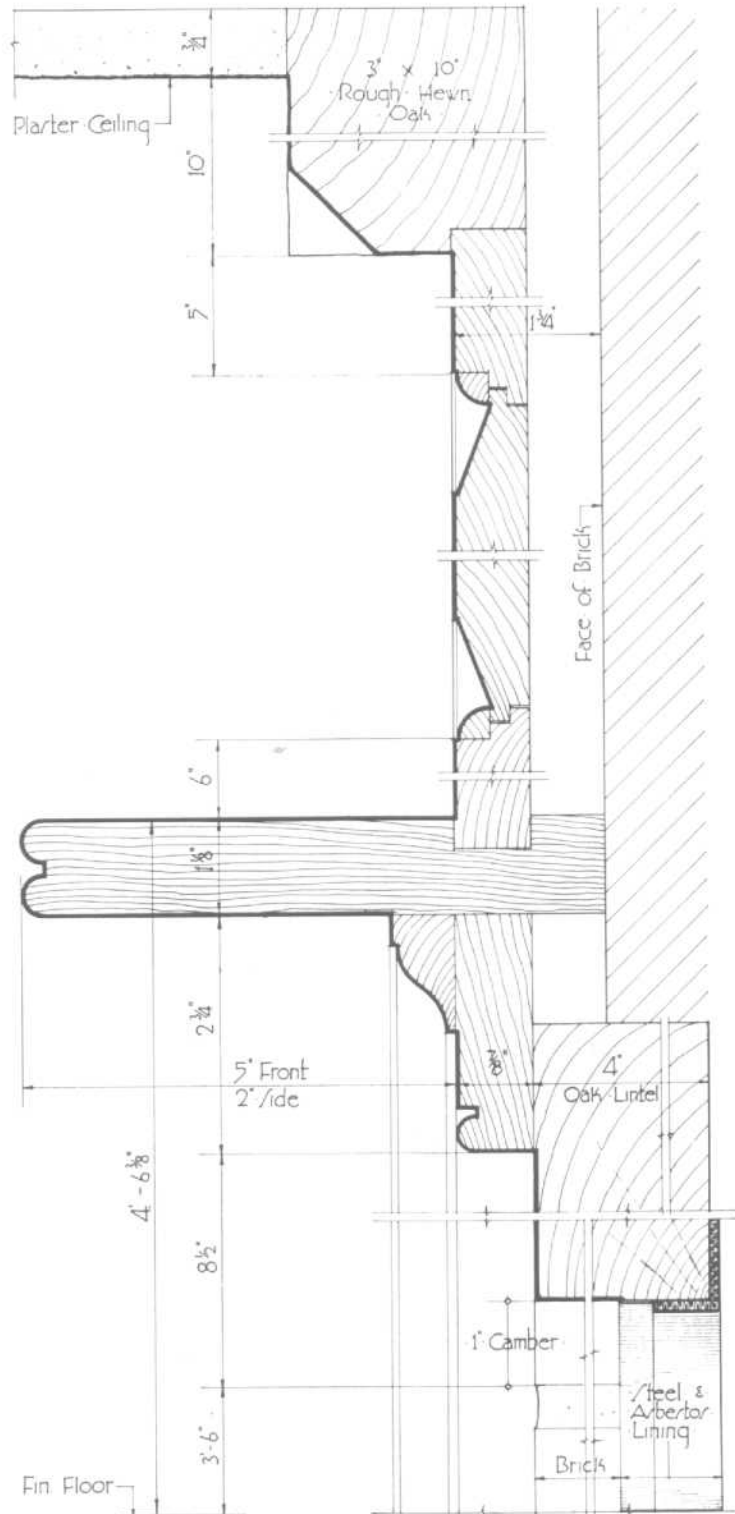
Wood Mantels



ELEVATION



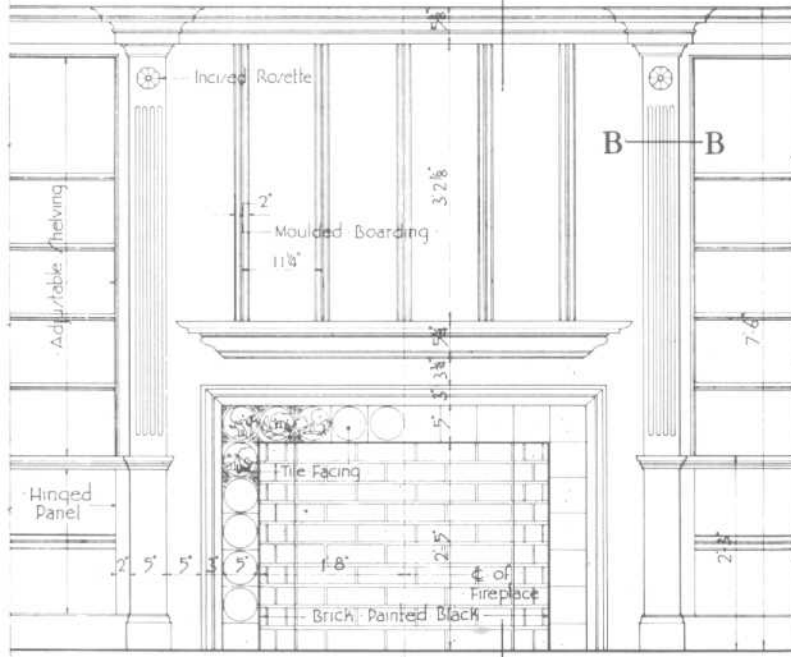
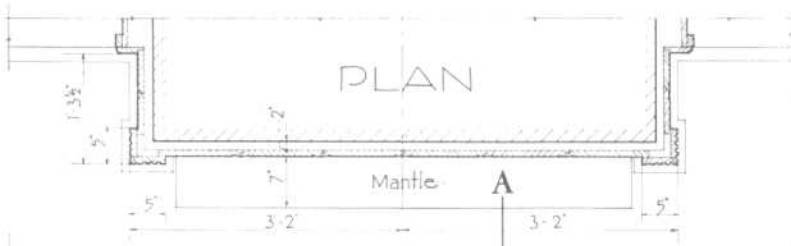
SECTION B-B



SECTION A-A

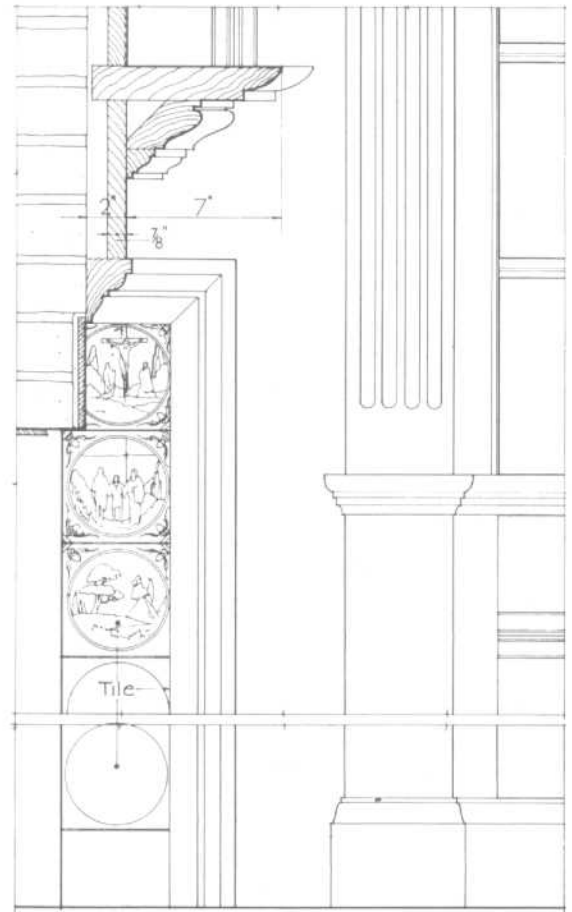
**FIREPLACES**

Wood Mantels

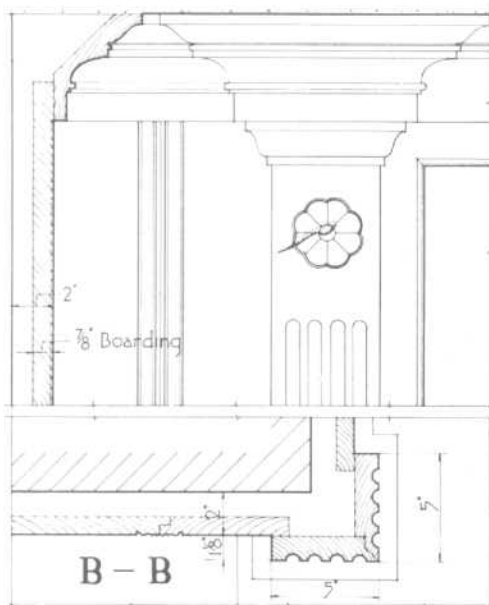


ELEVATION ·

A



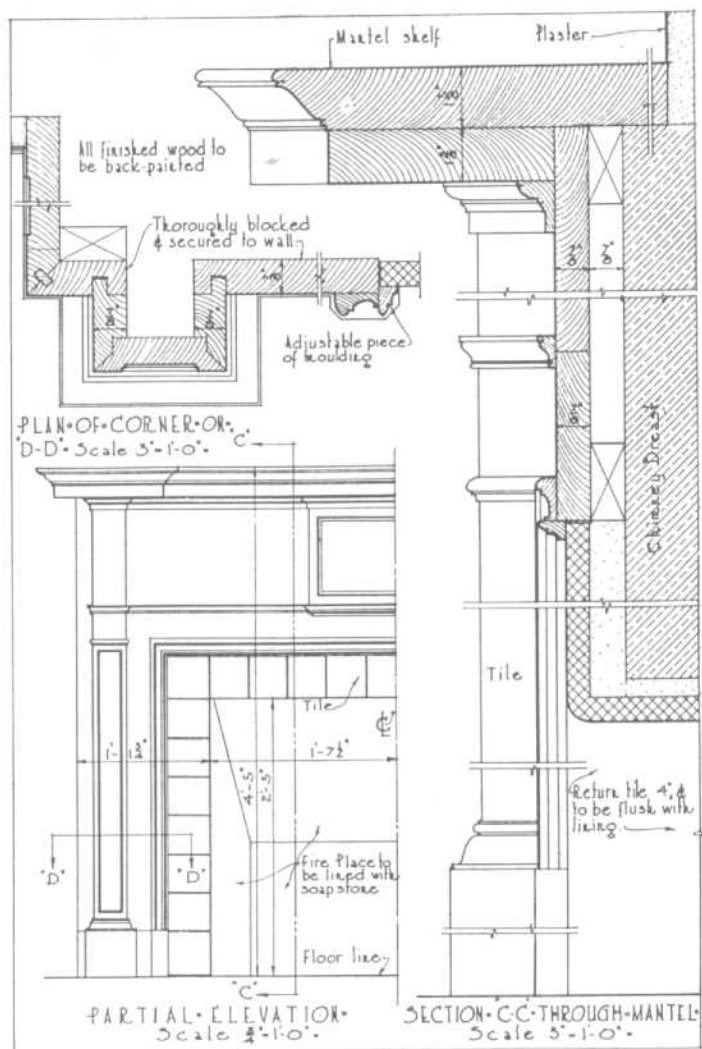
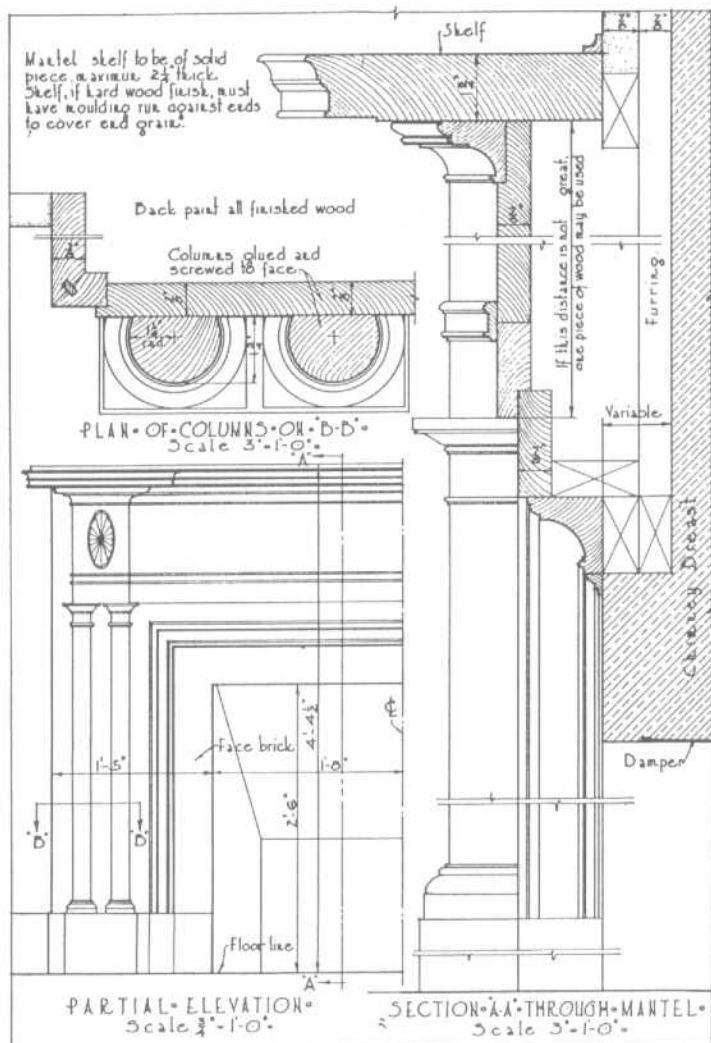
SECTION · A-A



B-B

FIREPLACES

Wood Mantels



FIREPLACES

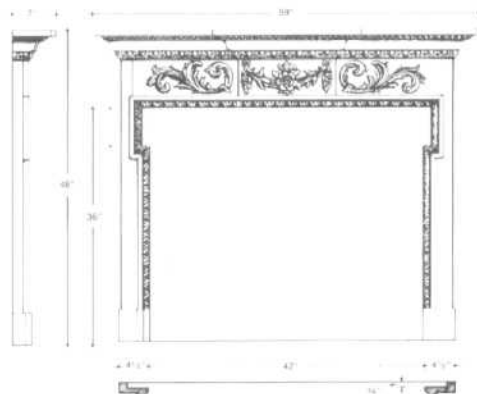
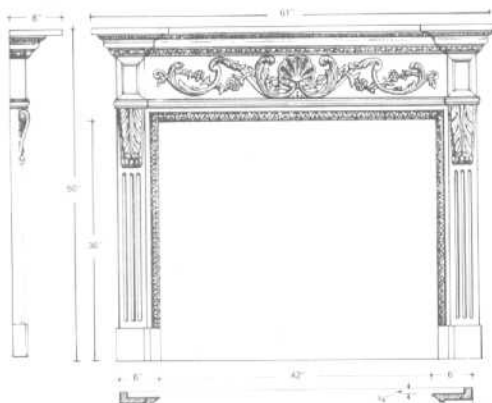
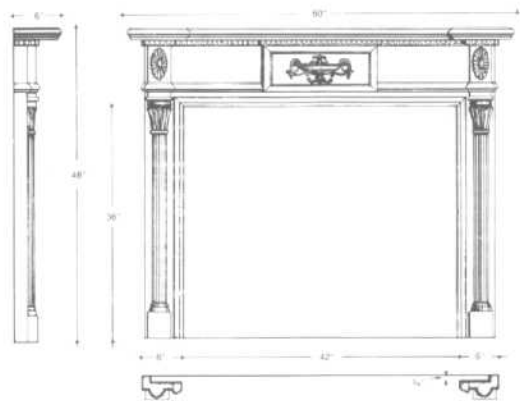
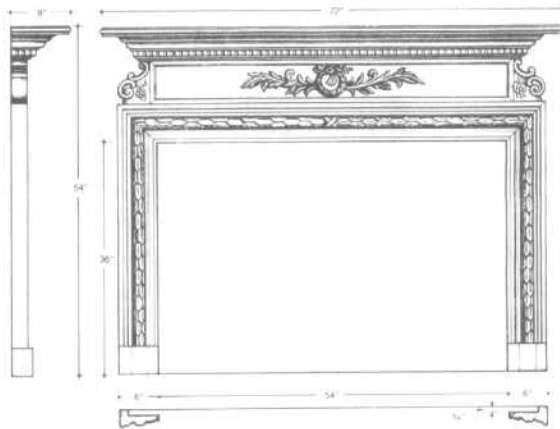
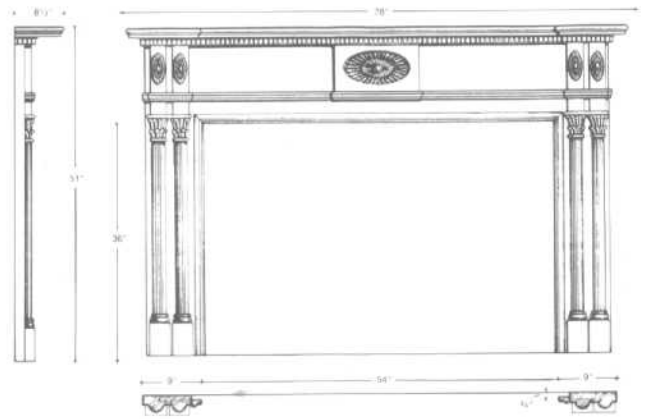
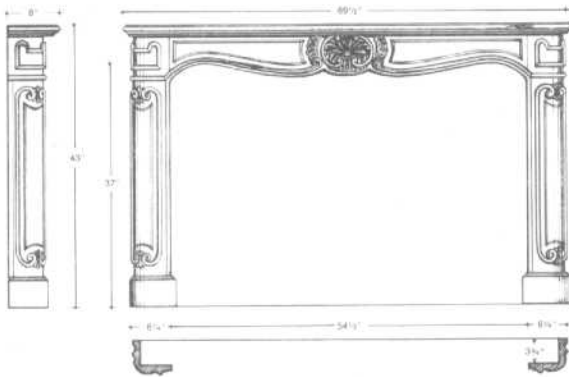
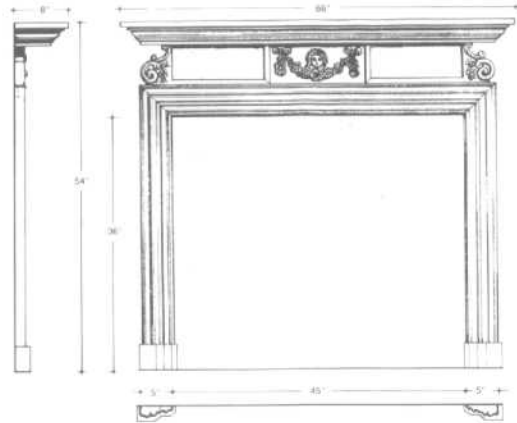
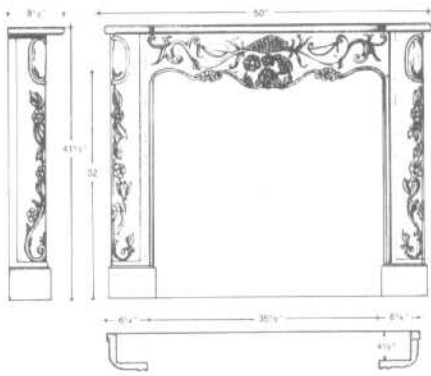
Wood Mantels



Fig. 6 These wood mantels are readily available.

FIREPLACES

Wood Mantels





FIREPLACES

Wood Mantels

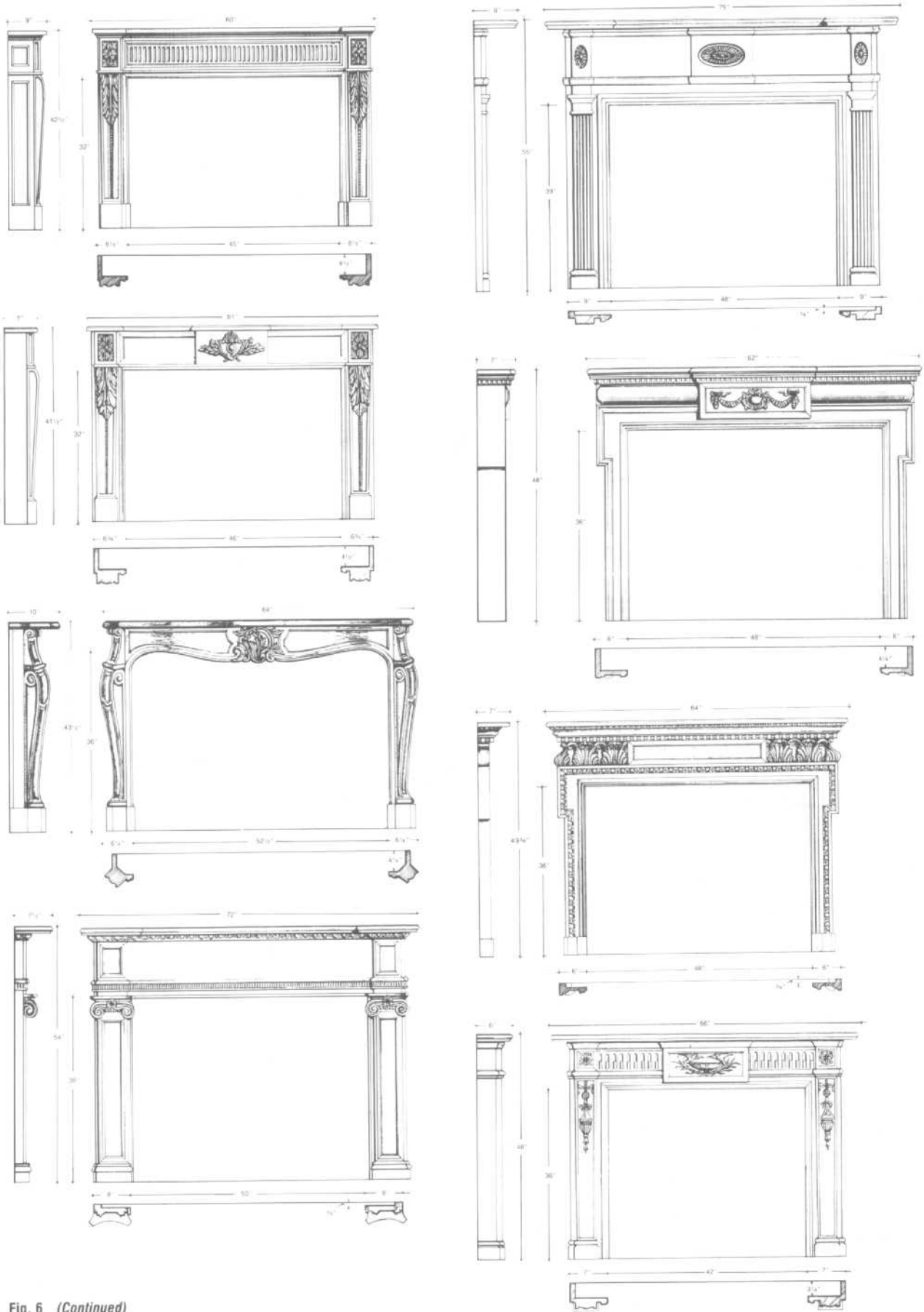
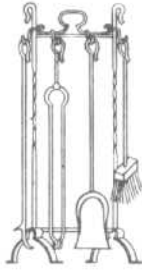


Fig. 6 (Continued)

FIREPLACES

Fireplace Accessories



Fire set of wrought metal, stand and four tools.



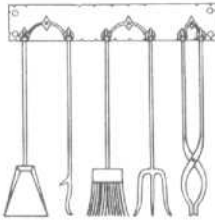
Fire set, polished brass, stand and four tools.



Andirons of wrought metal, smooth or hammered black finish.



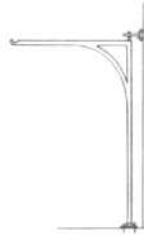
Andirons of wrought and cast metal, smooth or hammered black, or polished brass finish.



Fire set, wrought metal, back plate with jamb hooks, five tools.



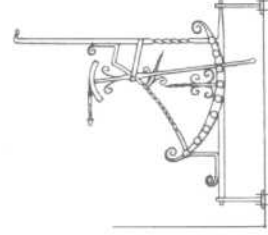
Fire set, wrought metal stand and three tools.



Crane, pivoted, of wrought metal.



Crane, pivoted, of wrought metal, movable hook.



Crane, pivoted, of wrought metal, ornamental adjustable hook.



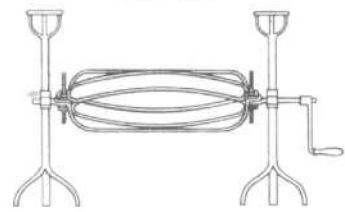
Footman, wrought metal.



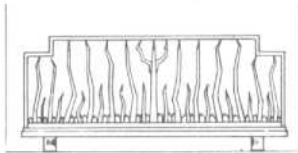
Trivet, wrought metal.  
SCALE  $\frac{3}{4}$ " = 1'-0"



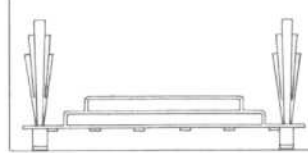
Fire lighter, kerosene torch, can and drip pan, wrought metal.



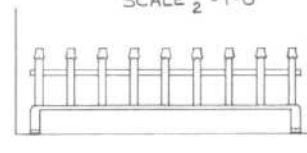
Spit with removable clamps. Hand turning crank may be replaced by pulley and operated by weight or spring clock mechanism.  
SCALE  $\frac{1}{2}$ " = 1'-0"



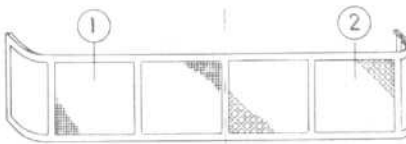
Log grate, wrought metal



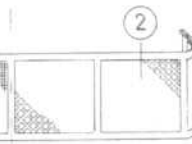
Log grate, wrought metal



Log grate, wrought metal



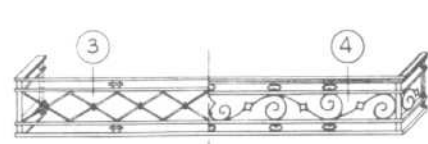
Fender with wire mesh screen.



Fender with stamped grille.



SCALE  $\frac{1}{2}$ " = 1'-0"



Fender of wrought metal

Fender of wrought metal. Moulding on top may be replaced by padded seat.

Fig. 7 Fireplaces offer opportunities for the use and display of a variety of metal items of decorative value. These may be selected or designed to match other material in the room. Metals used for wrought and cast fireplace products are usually cast iron, steel in a dark hammered finish, or polished brass. Combinations of these metals and other metals may be used very effectively.

LIGHTING

Planning Data: Minimum Shade Heights

Although lighting design is a discipline in and of itself, the interior designer and architect must be knowledgeable about the interface between lighting elements and the interior architecture. This section, therefore, focuses primarily on the detailing of this interface. Details from actual contract drawings, prepared by various interior design and architectural firms, are provided for the reader's reference. Among the details are those for valence and cove lighting and for the lighting of stairs, columns, and skylights. This section also provides some basic planning data including illuminance values for residences, offices, stores, and industrial spaces.

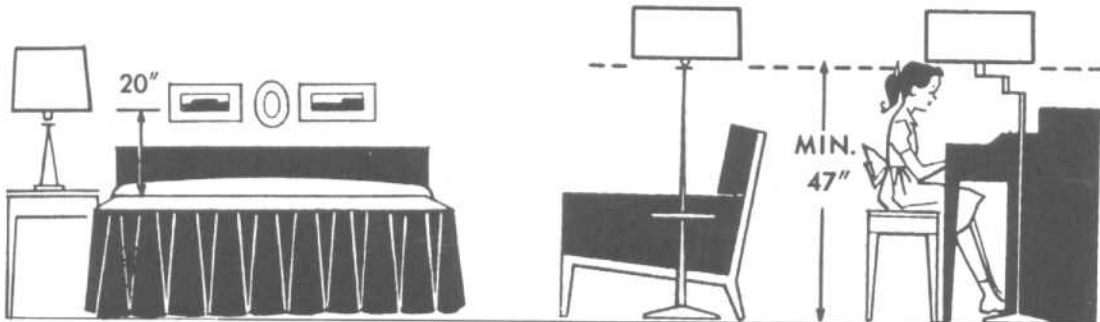


Bottom of shade at eye level when seated — approx. 40"–42" off floor.

APPROX.  
40"–42"

Exceptions:  
Sewing, Piano

Light colored shade should transmit light generously.



20"

MIN.  
47"

Fig. 1 Measuring when the lamp is at the side — when sitting, lying down, or playing the piano.



When bottom of shade is above eye level, lamp stem should be about 10" behind shoulder — near rear corner of chair

MIN.  
47"

Fig. 2 Measuring when the lamp is behind — when sitting.

LIGHTING

Planning Data: Minimum Shade Heights



Recommended Minimum Shade Dimensions

LAMP TYPE	Top Dia. "	Depth "	Bottom Dia. "
Sr. Floor	10	10	18
Swing Type	10	10	16
Jr. Floor — Swing Type	10	9	16
Diffuser Type	14	6	16
Bridge	8	8	13
End Table	8	10	16
Diffuser Type	14	6	16
Sr. Table	14	13	18
Wall Lamp	8	8	13
Diffuser Type	4	6	14
Study Type — pair	6	7	10
Make-Up — pair	7	7	9-10
Double Dresser — pair	8	8	12-14

Base Height (measure from table to shade bottom)

+ Table Height

= Seated Eye Height

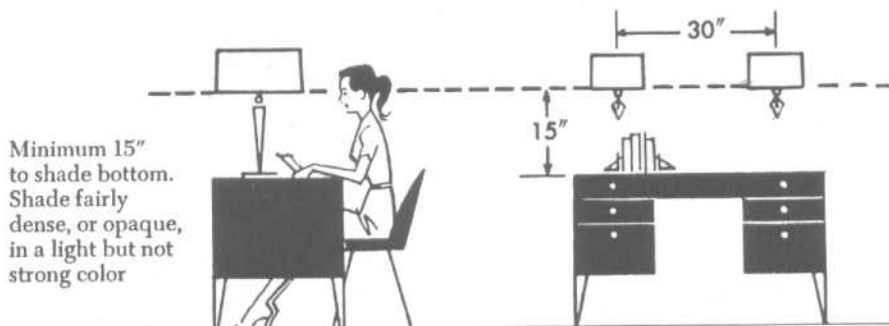
(approx. 40"-42" off floor)

FLOOR LAMPS

Measure from floor to bottom of shade.

SHADES

Measure top and bottom diameters, and depth vertically through center.



Exception: Make-Up White or ivory highly translucent shades

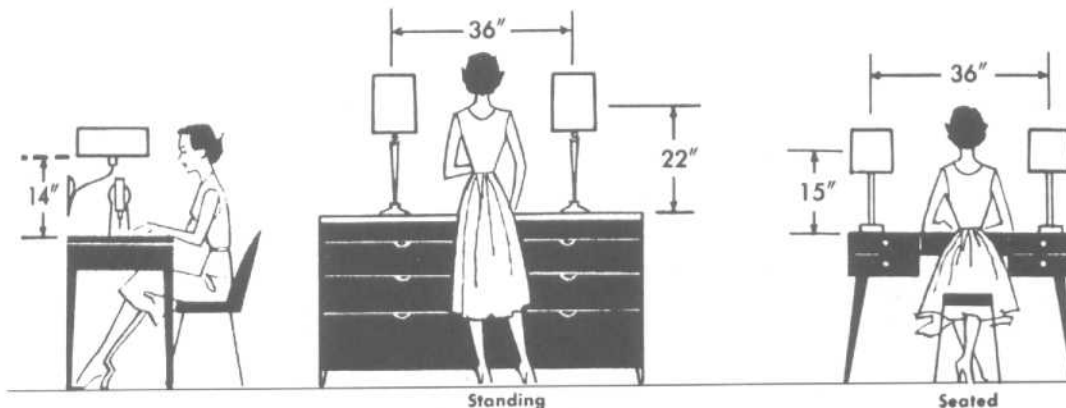
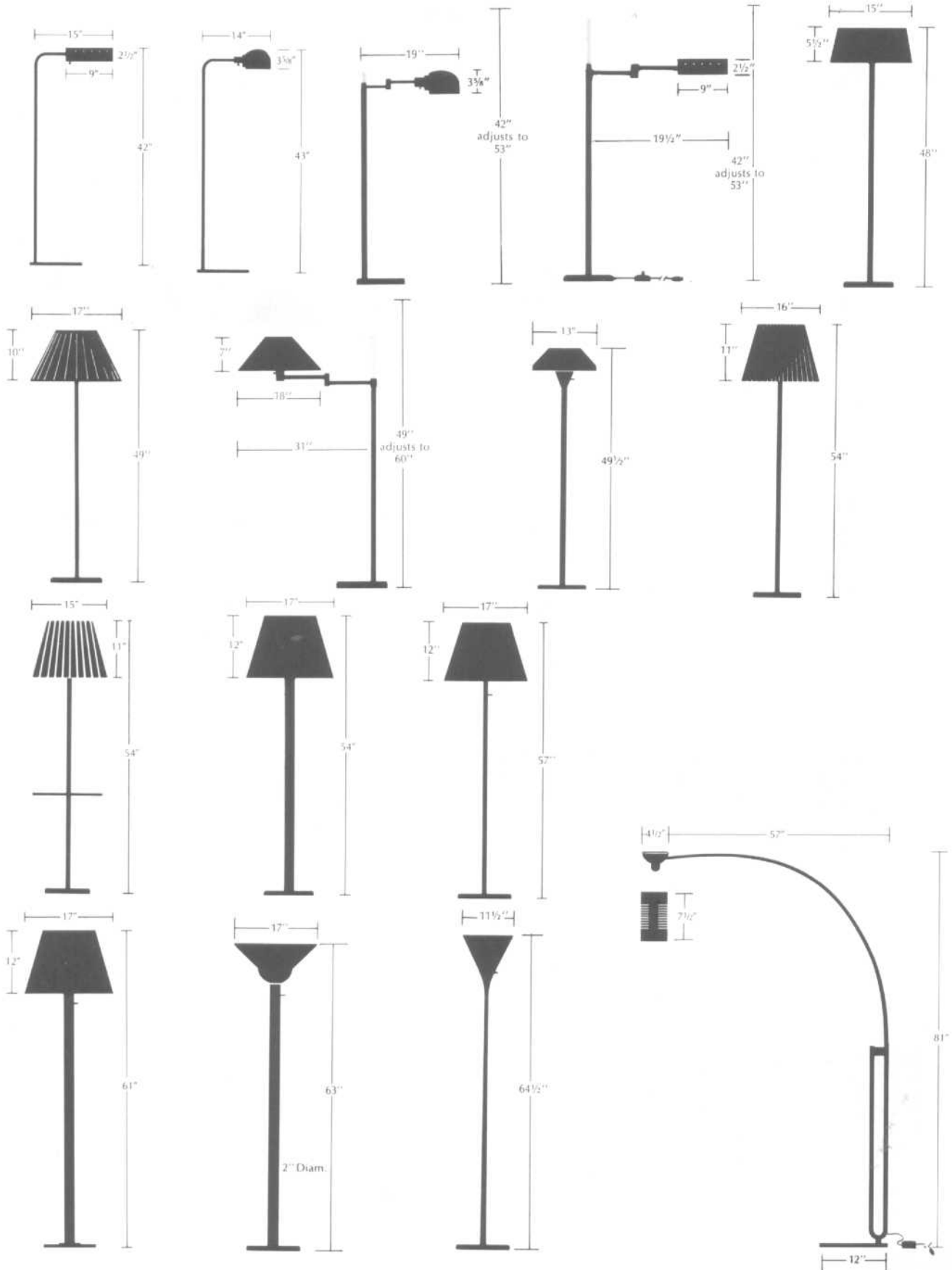


Fig. 3 Measuring when the lamp is in front — when studying, sewing, or grooming oneself.

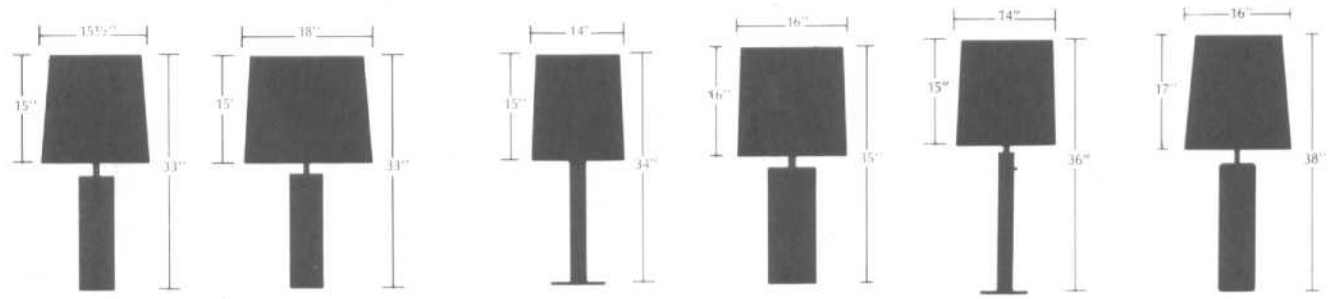
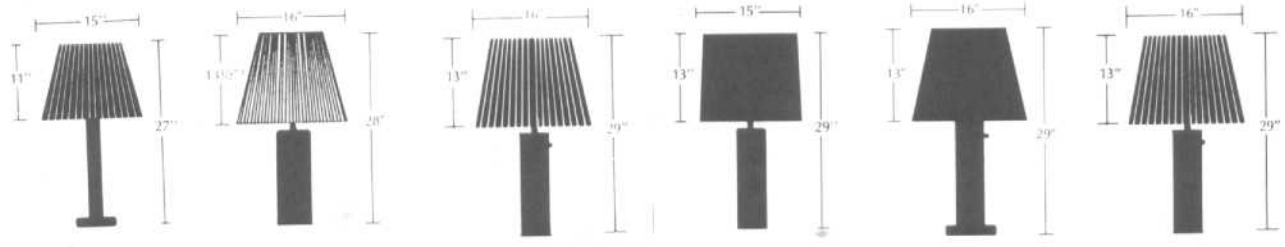
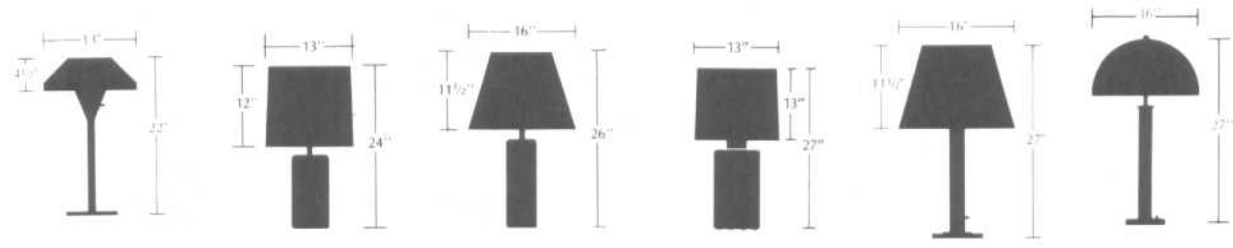
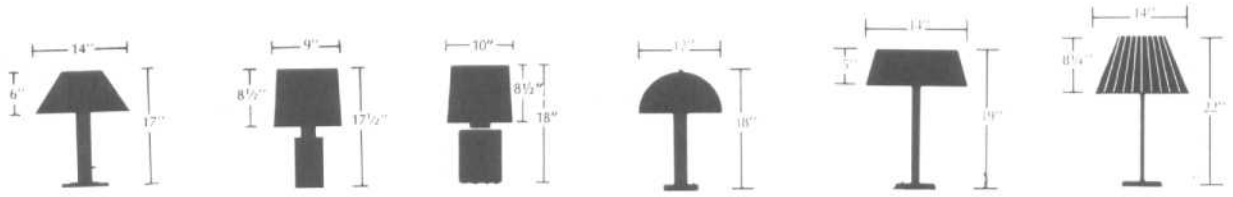
LIGHTING

Floor Lamps

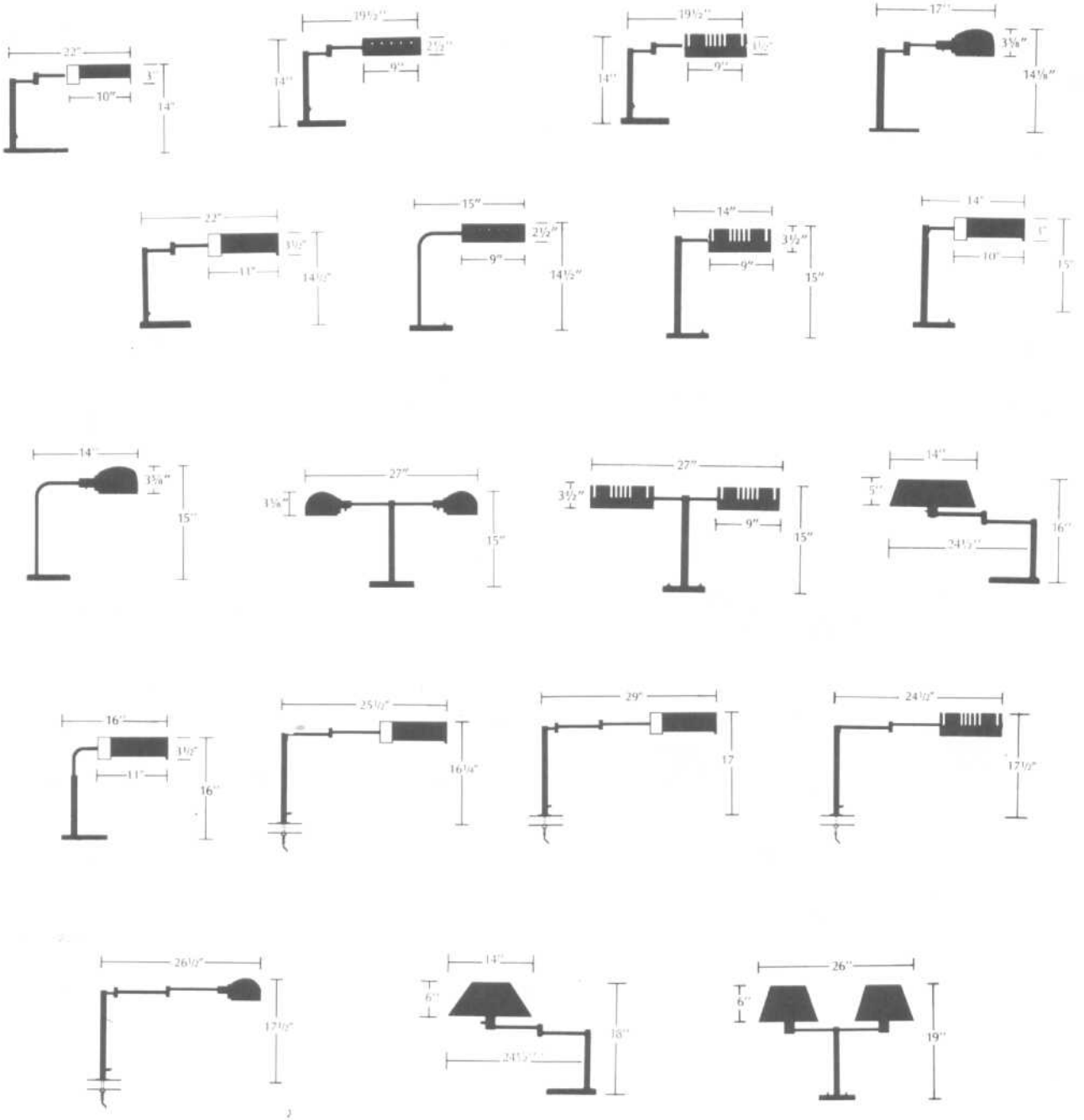


LIGHTING

Table Lamps

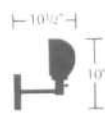
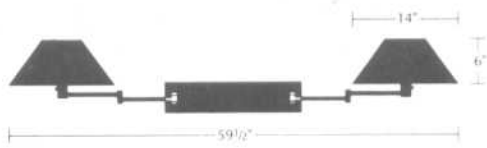
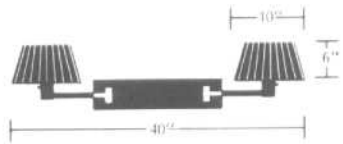
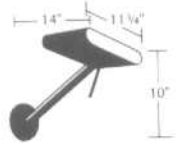
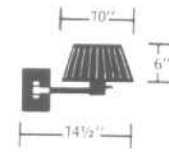
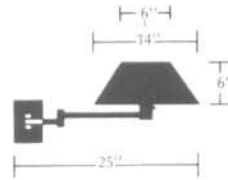
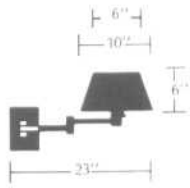
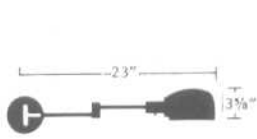
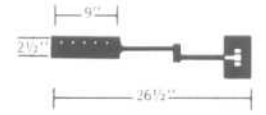
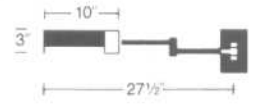
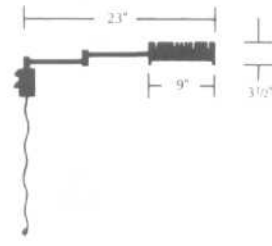
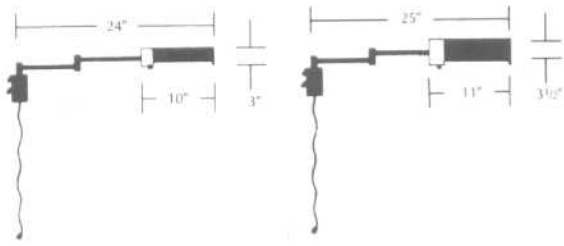


**LIGHTING**  
Desk Lamps



LIGHTING

Wall-Mounted Task Lamps





LIGHTING

Planning Data: Residential Valance Lighting

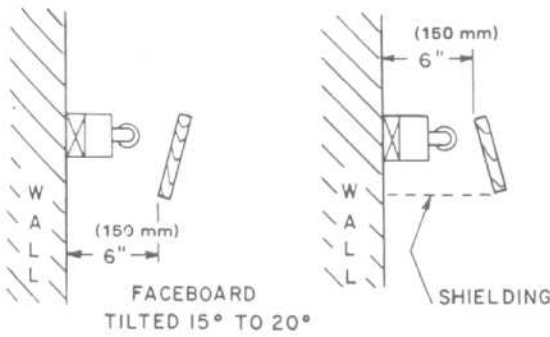


Fig. 4 Valance faceboard may be tilted.

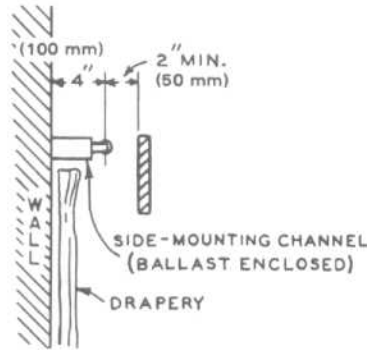


Fig. 5 With side-mounting channels, no extender is necessary.

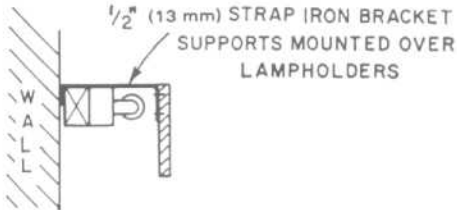


Fig. 6 Intermediate brackets are required to support long faceboards.

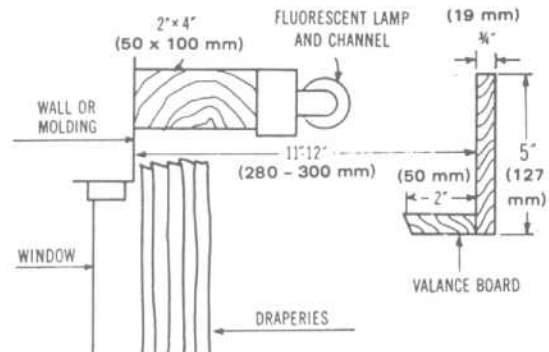


Fig. 7 Variation of valance lighting. (If distance between wall and lamp is increased, light will be distributed more evenly, but shielding may be required at the bottom of the faceboard.)

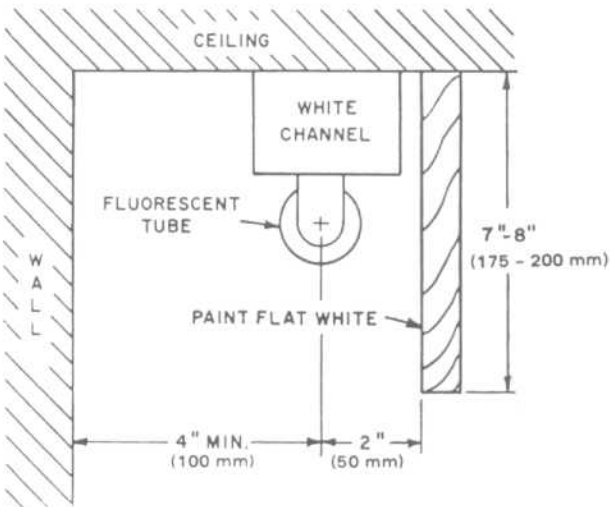


Fig. 8 Minimum dimensions for cornice lighting installation.

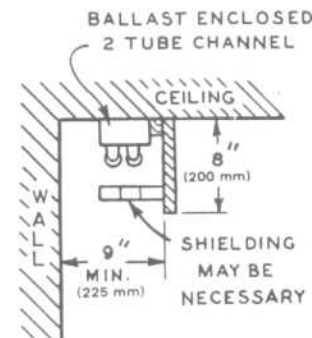


Fig. 9 Cornice lighting with two tubes may require shielding.

LIGHTING

Planning Data: Residential Down Lighting

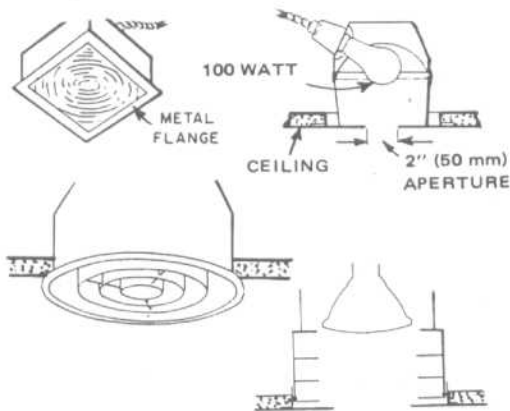


Fig. 10 Common types of downlights.

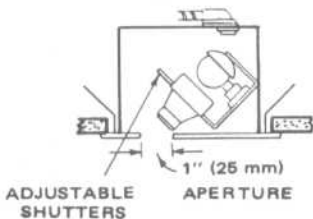


Fig. 11 Pinhole spot, a recessed downlight with adjustable shutters to shape beam pattern.

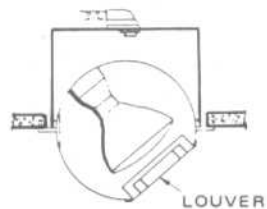


Fig. 12 "Eyeball" semirecessed fully adjustable downlight.

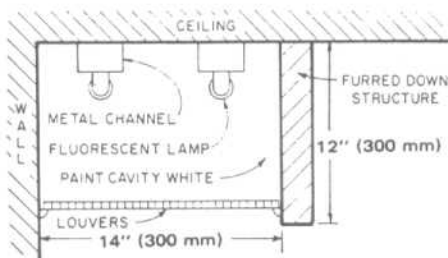


Fig. 13 Luminous panel or soffit lighting, used over a kitchen or bathroom counter.

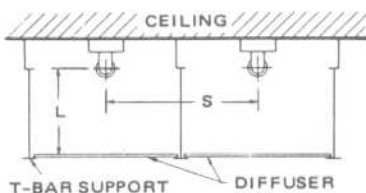


Fig. 14 Critical dimensions for luminous panel and luminous ceiling lighting. (S should not exceed 1½ to 2 times L.)

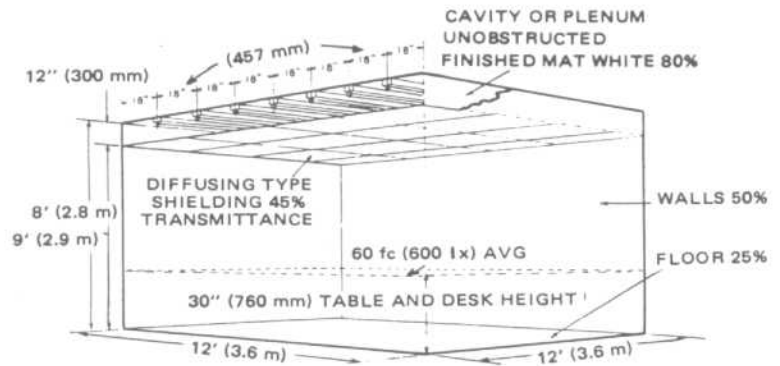


Fig. 15 Basic relationship for the design of luminous panels. [A light level of 60 fc (600 lx) is produced by seven rows of three 40-W fluorescent tubes on 18-in (457 mm) centers. Light distribution and surface luminance are approximately uniform.]

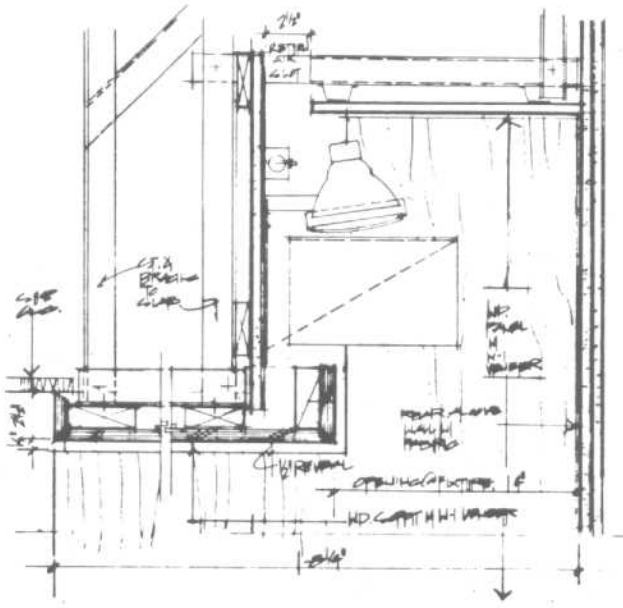
TABLE 1 Illuminance Values for Residences\*

Specific visual tasks	Illuminance	
	Foot-candles	Lux†
Dining	15	150
Grooming, shaving, makeup	50	500
Handcraft		
Ordinary seeing tasks	70	700
Difficult seeing tasks	100	1000
Very difficult seeing tasks	150	1500
Critical seeing tasks	200	2000
Ironing (hand and machine)	50	500
Kitchen duties		
Food preparation and cleaning	150	1500
Serving and other noncritical tasks	50	500
Laundry		
Preparation, sorting, inspection	50	500
Tub area—soaking, tinting	50	500
Washer and dryer areas	30	300
Reading and writing		
Handwriting, reproductions, and poor copies	70	700
Books, magazines, newspapers	30	300
Reading piano or organ scores		
Advanced (substandard size)	150	1500
Advanced	70	700
Simple	30	300
Sewing (hand and machine)		
Dark fabrics	200	2000
Medium fabrics	100	1000
Light fabrics	50	500
Occasional—high contrast	30	300
Study	70	700
Table games	30	300
General lighting		
Conversation, relaxation, entertainment	10	100
Passage areas, for safety	10	100
Areas other than kitchen involving visual tasks	30	300
Kitchen	50	500

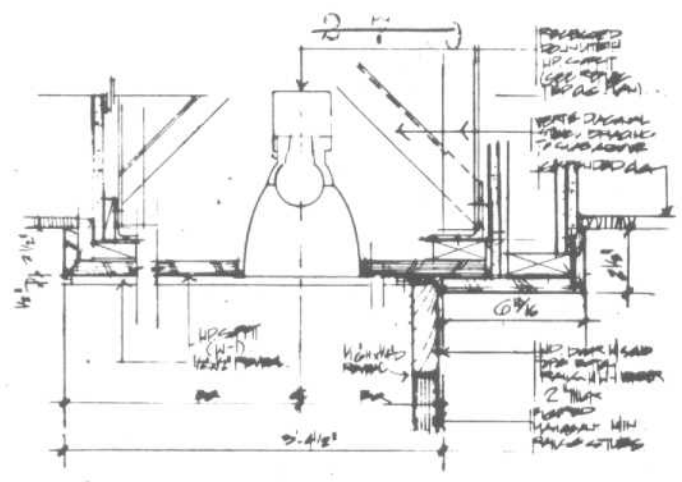
\*Minimum on the task at all times.

†Lux is an SI unit equal to 0.0929 footcandle.

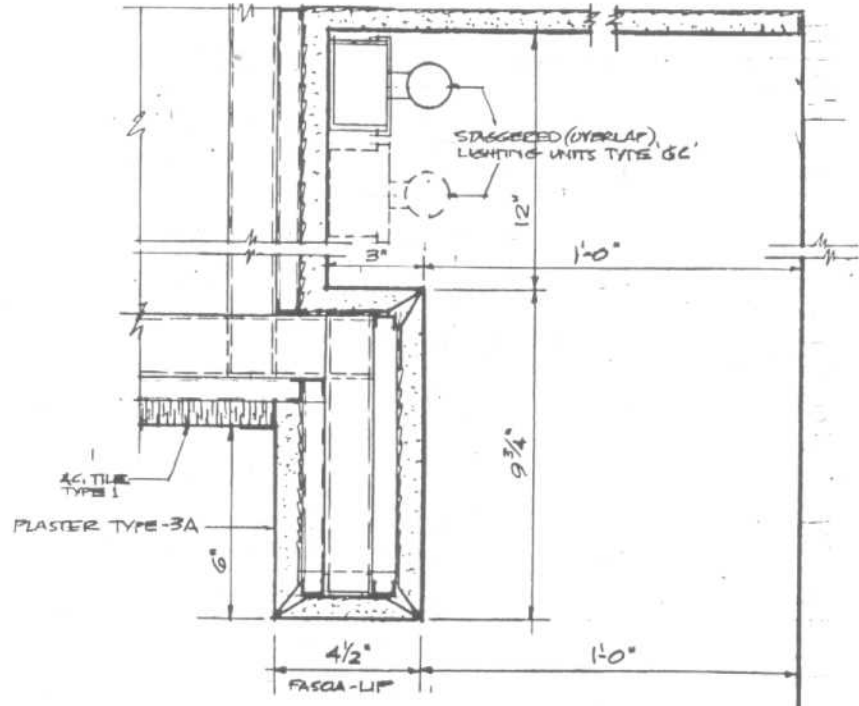
**LIGHTING**  
Cove Lighting Details



① WED CORNER LIGHTING DETAIL



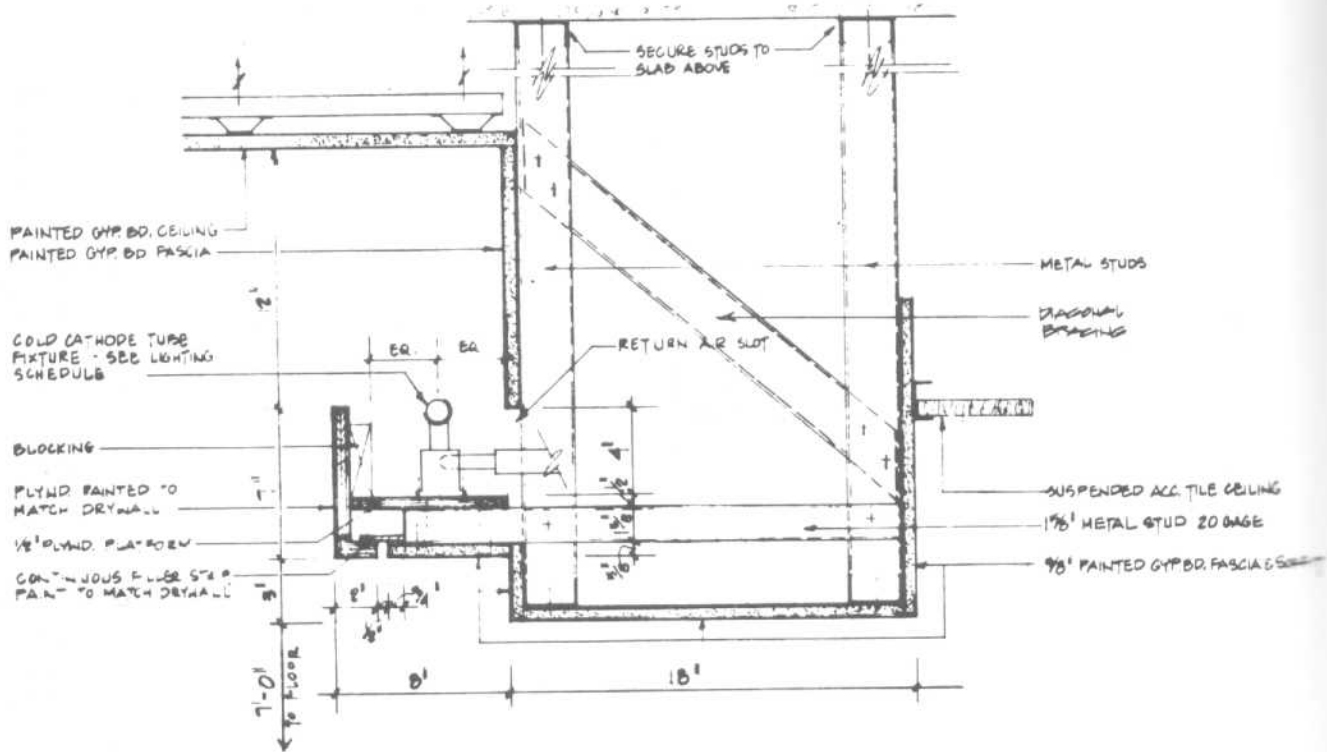
② WED CORNER LIGHTING DETAIL



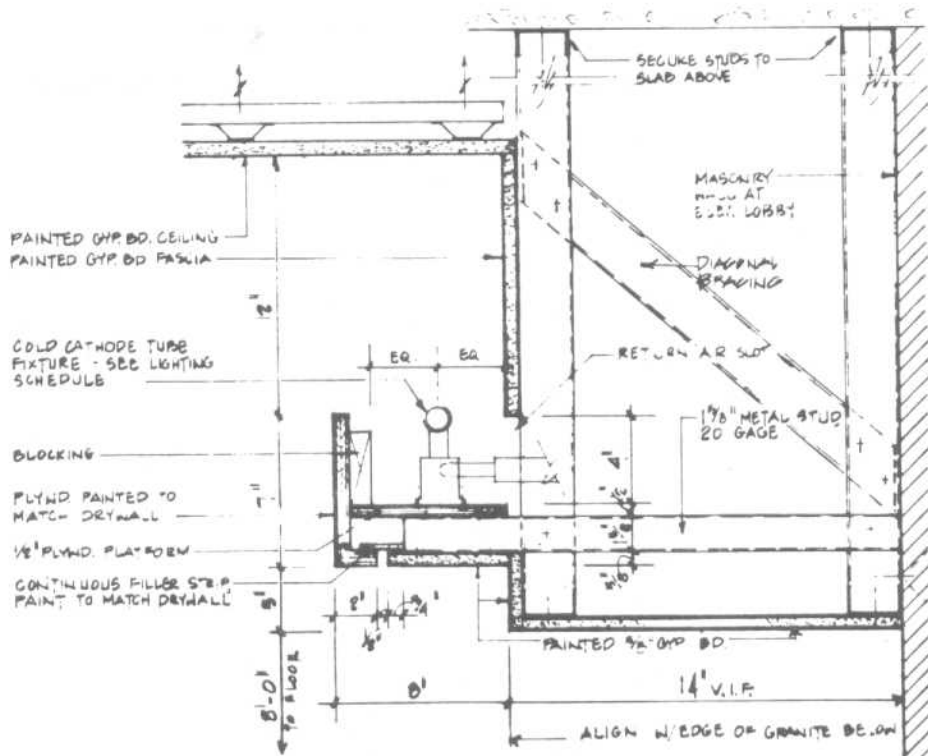
**DETAIL OF LIGHT COVE RECESS  
IN SANCTUARY @ 3\"/>**

LIGHTING

Cove Lighting Details

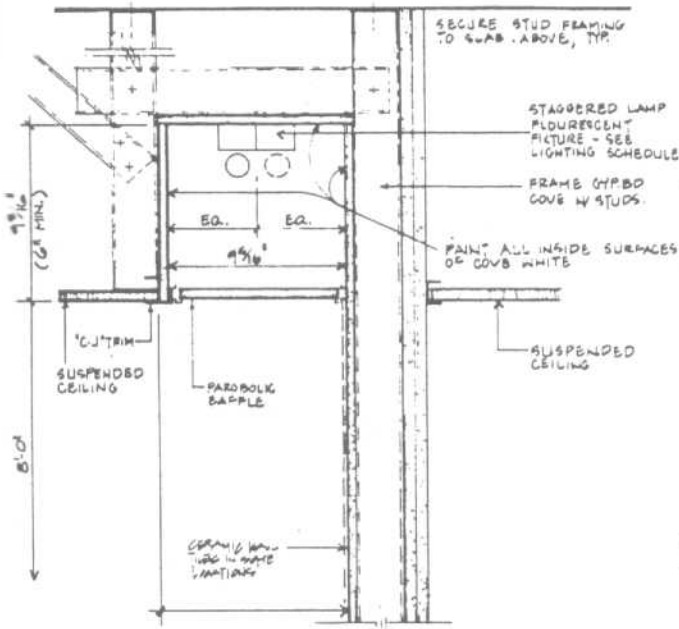


④ DETAIL - LIGHT COVE @ RECEPTION AREA

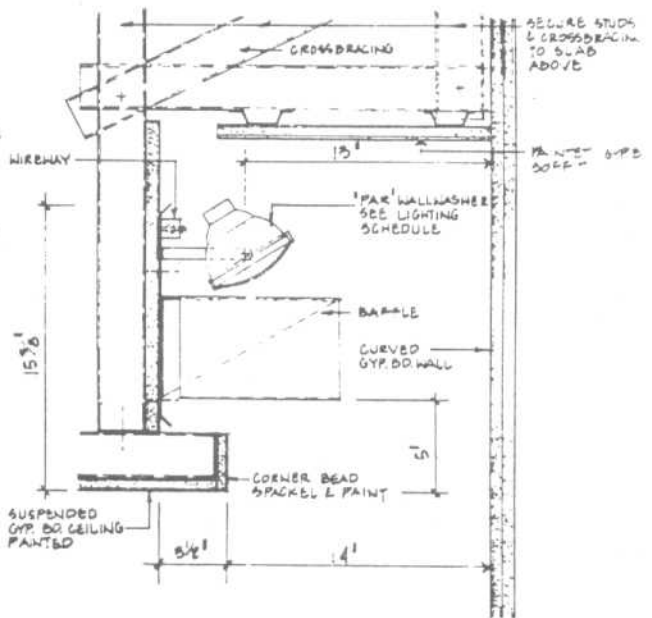


⑤ DETAIL - LIGHT COVE @ ELEVATOR LOBBY

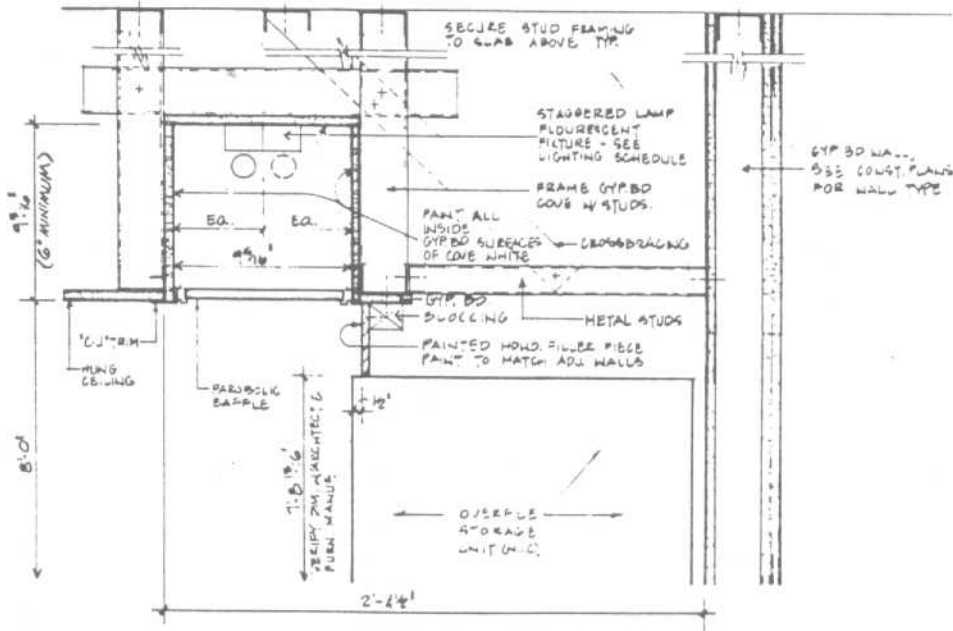
**LIGHTING**  
Cove Lighting Details



① DETAIL - LIGHT COVE @ TYPE "D" FIXTURE AT WALLS  
3'-10"



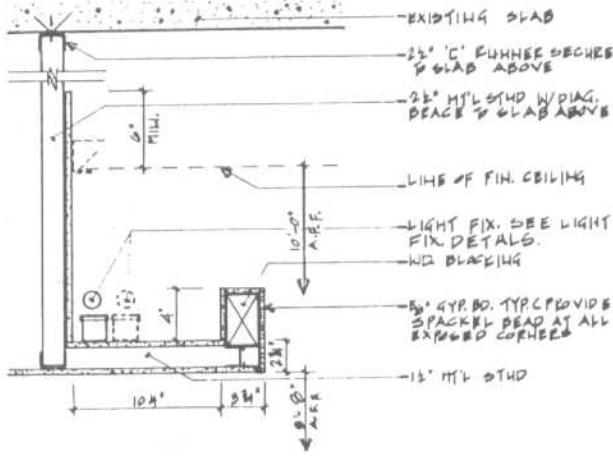
⑤ DETAIL - LIGHT COVE @ STAIR, TYPE "K" FIXTURE  
3'-10"



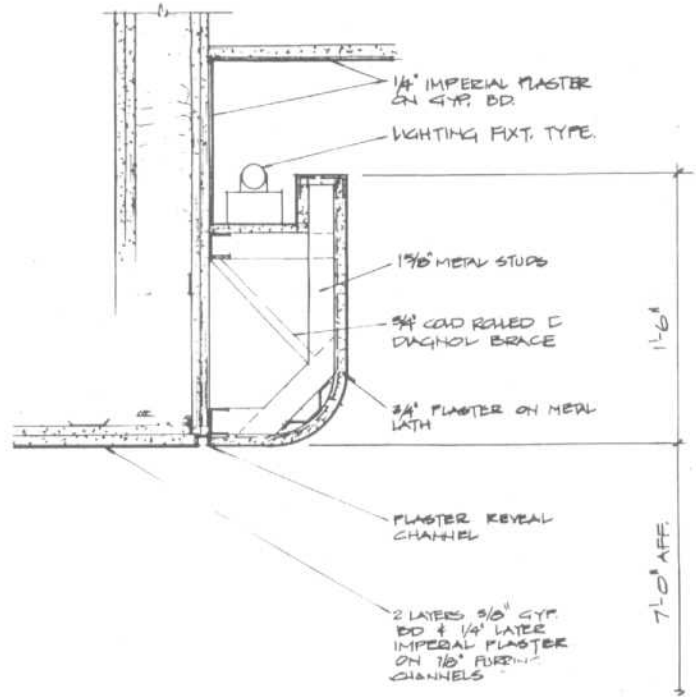
② DETAIL - LIGHT COVE @ TYPE "D" FIXTURE AT FILES  
3'-10"

LIGHTING

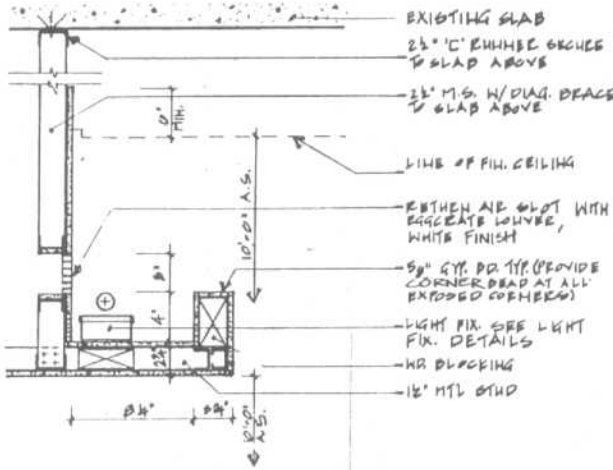
Cove Lighting Details



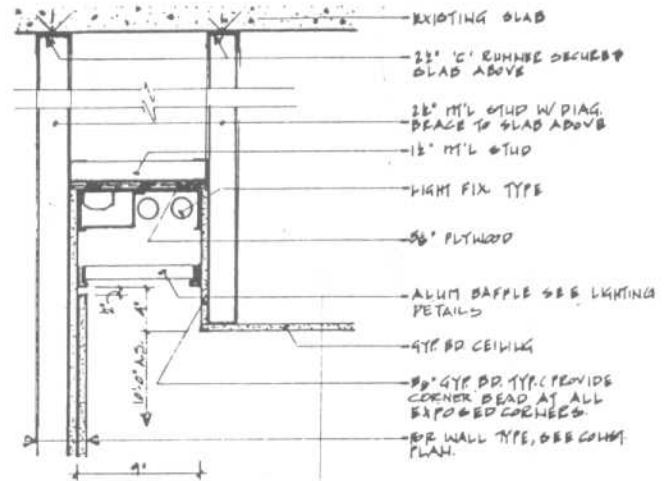
SECTION AT LIGHT COVE



SECTION AT TROUGH AND SOFFIT  
11 1/2" AFF.

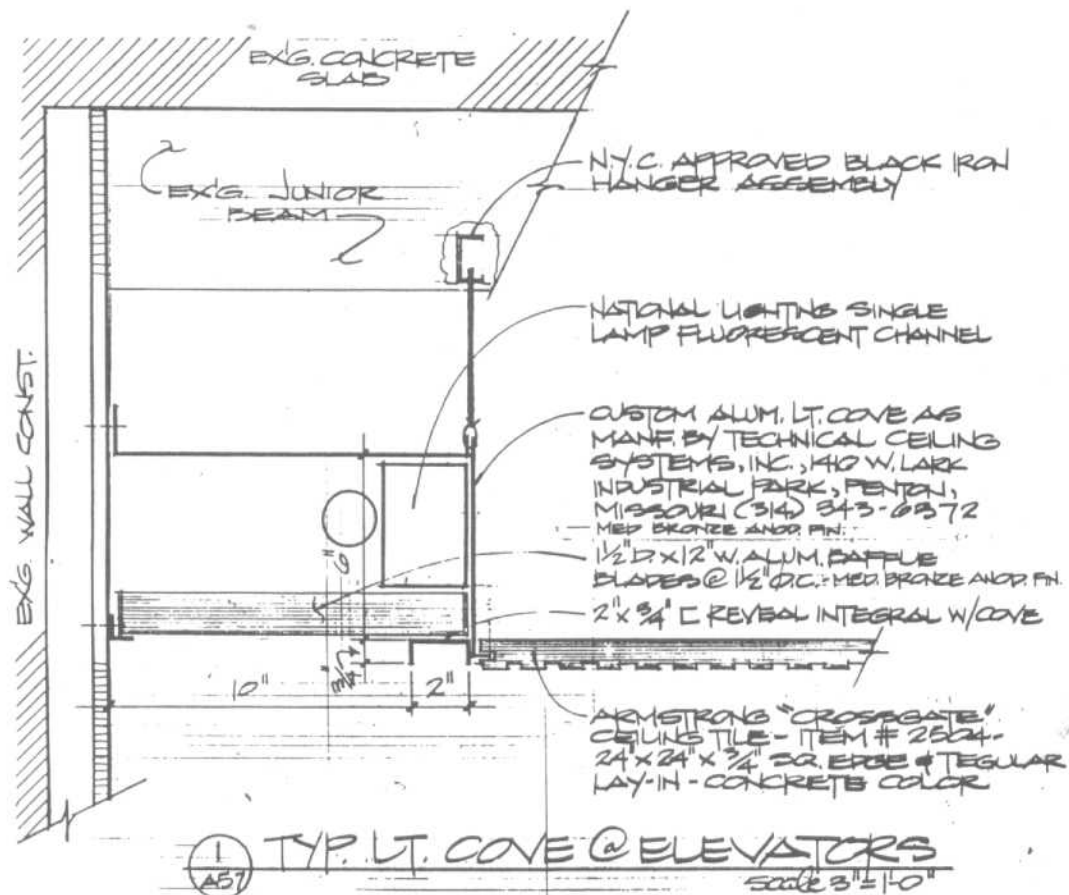
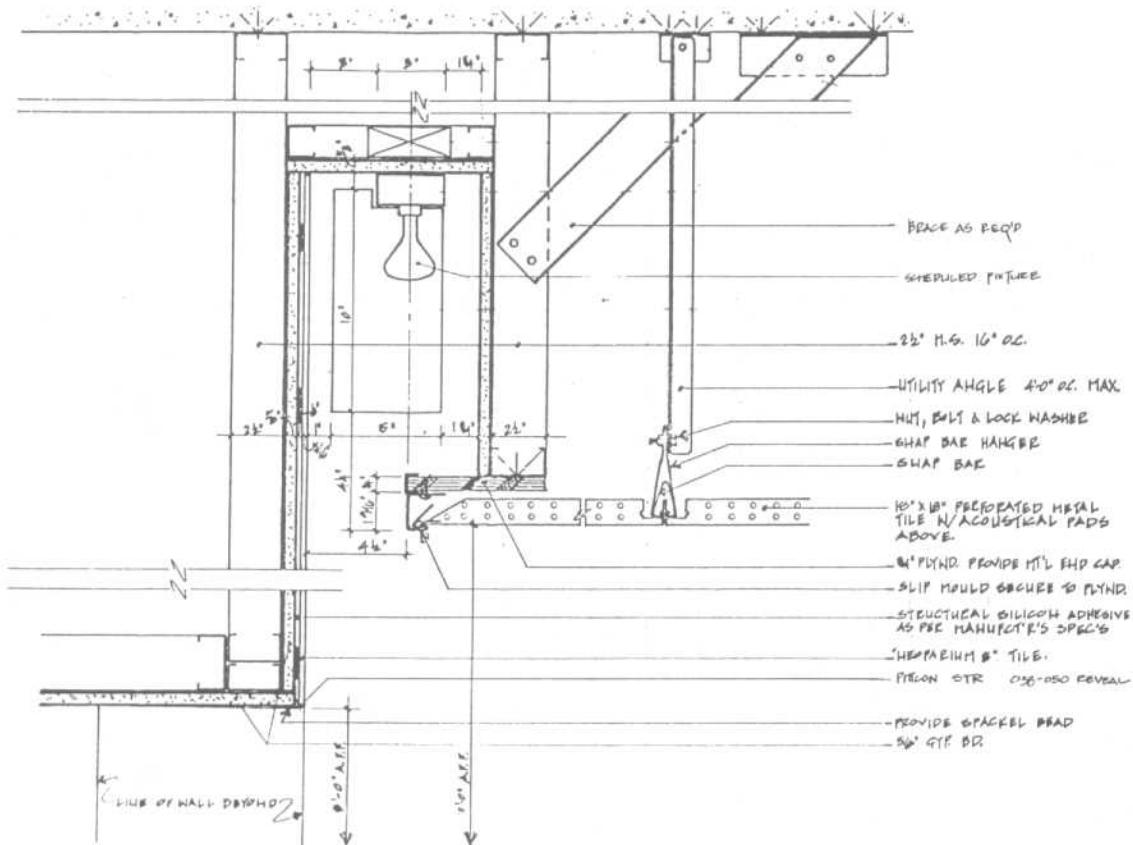


SECTION AT LIGHT COVE



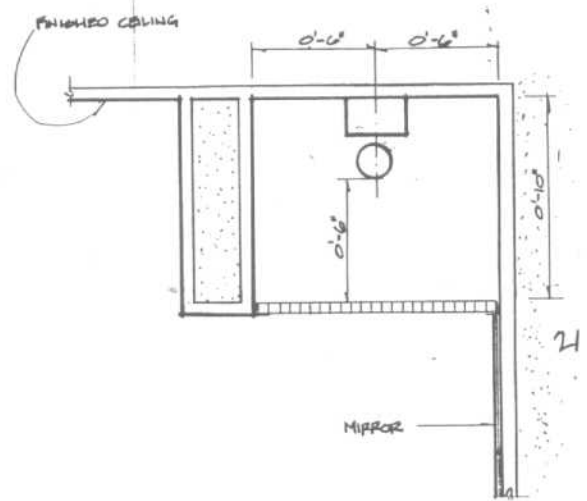
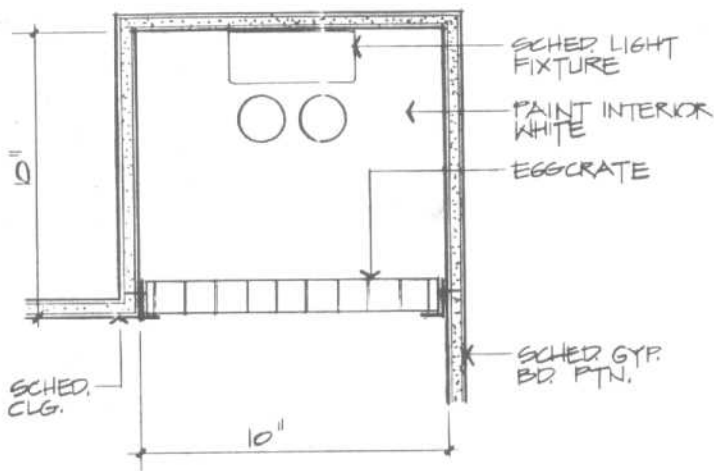
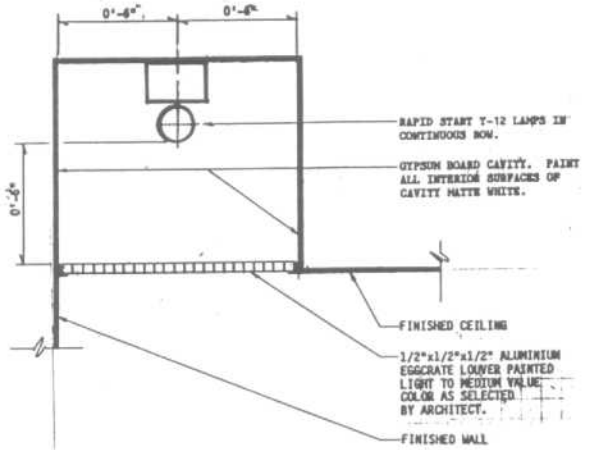
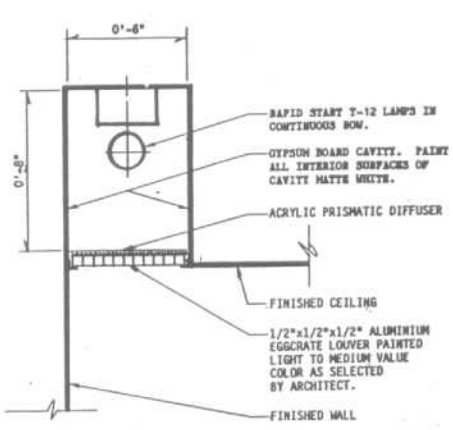
SECTION AT LIGHT COVE, DINING ROOM

**LIGHTING**  
Cove Lighting Details



LIGHTING

Fluorescent Cove Lighting Details



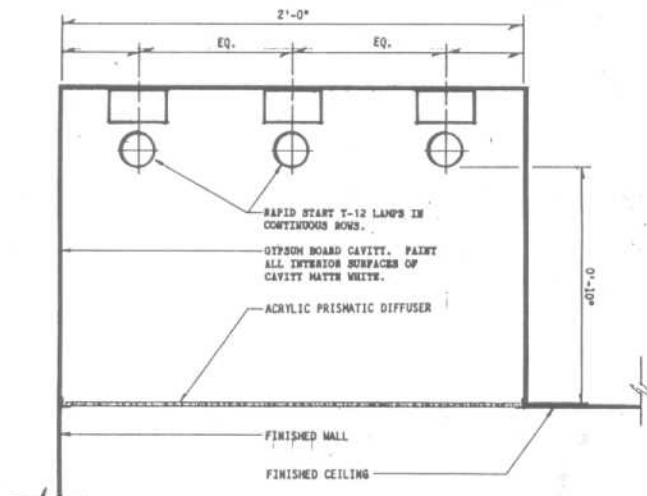
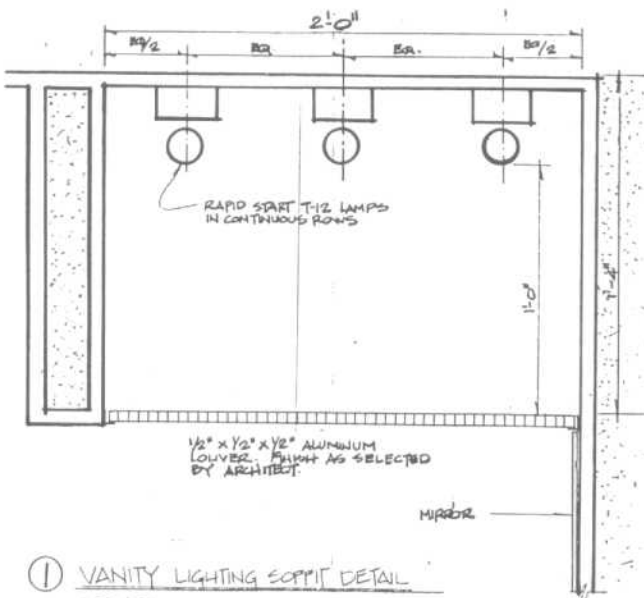
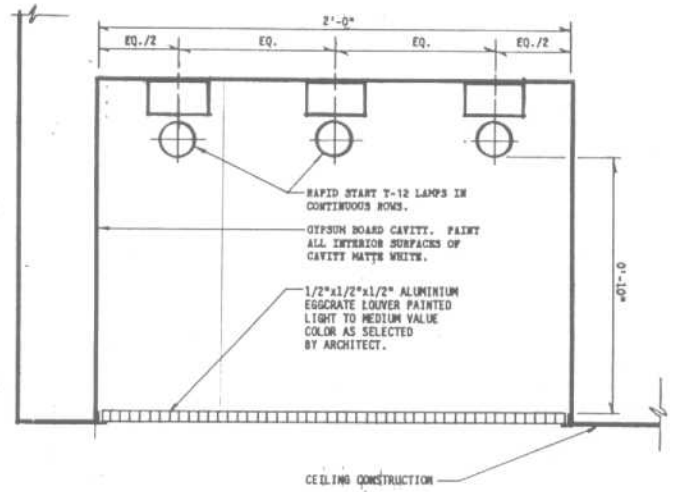
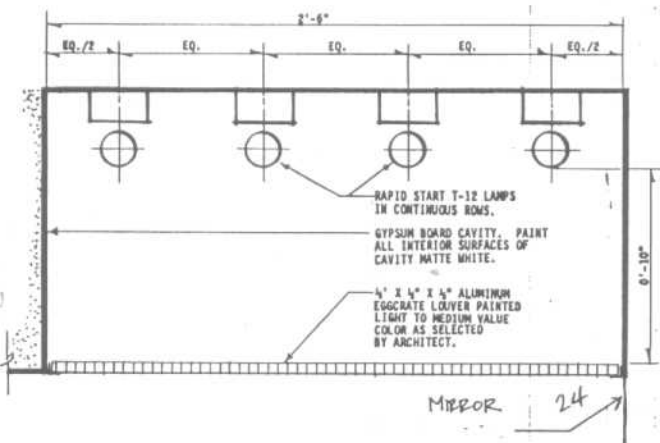
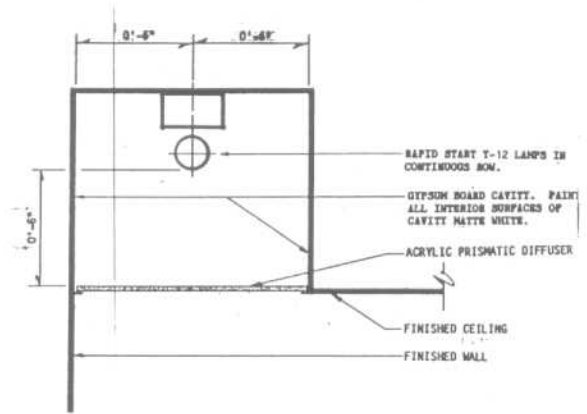
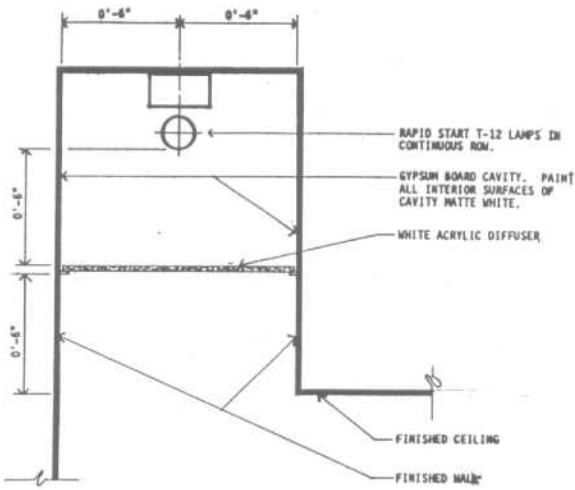
3'-1'-0"

SECTION THRU CONTINUOUS COVE LIGHT



LIGHTING

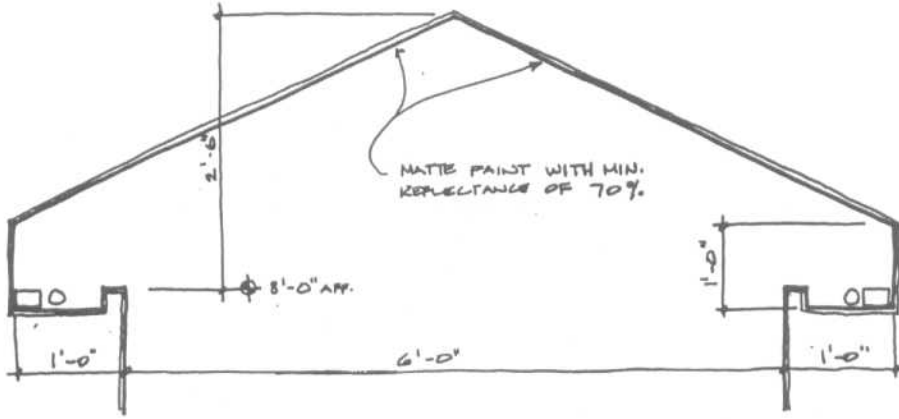
Fluorescent Cove Lighting Details



① VANITY LIGHTING COFFIT DETAIL  
3'-1'-0"

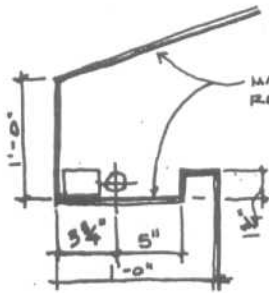
LIGHTING

Fluorescent Cove Lighting Details

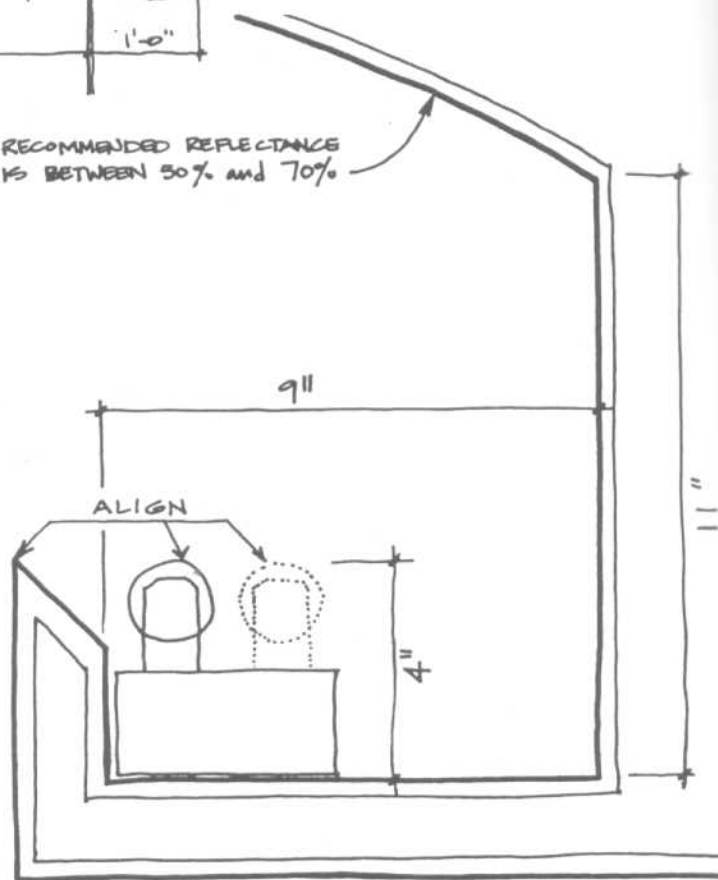


SECTION THRU COVE UPRIGHT

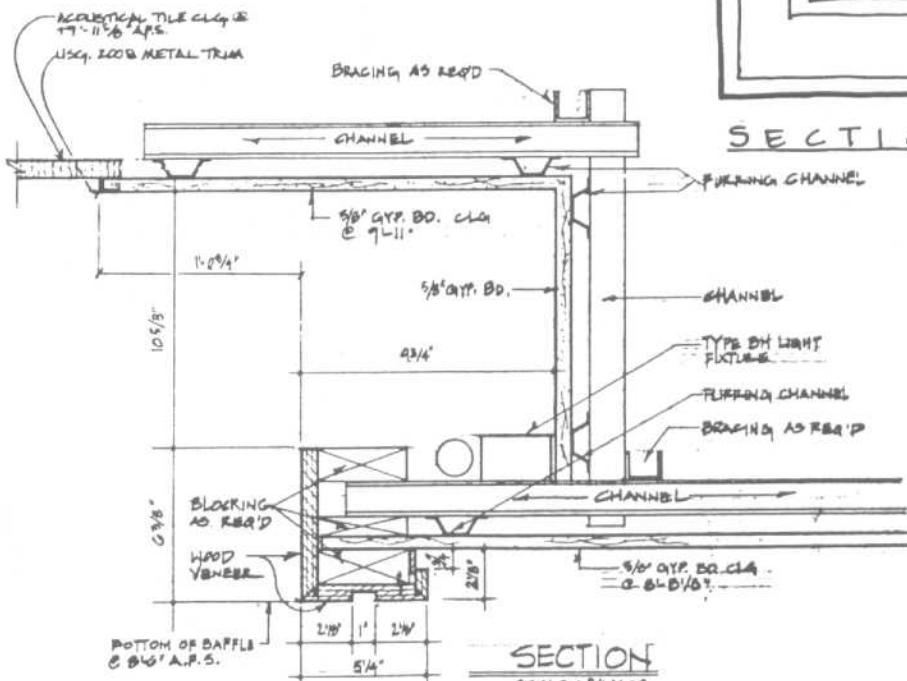
RECOMMENDED REFLECTANCE IS BETWEEN 50% AND 70%



ENLARGED DETAIL



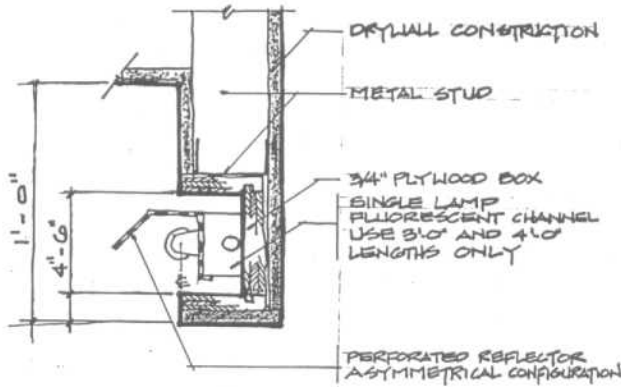
SECTION THRU COVE



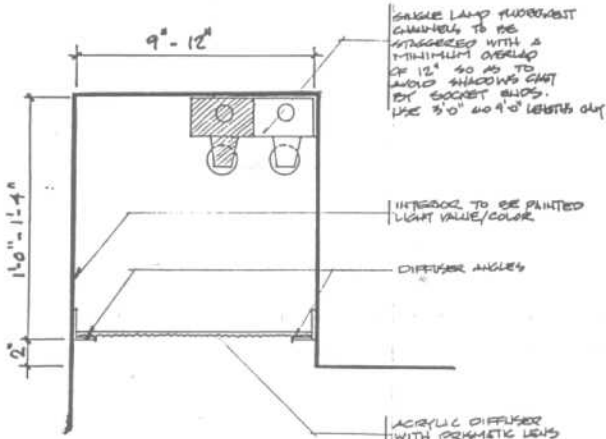
SECTION  
SCALE: 3/4"=1'-0"

LIGHTING

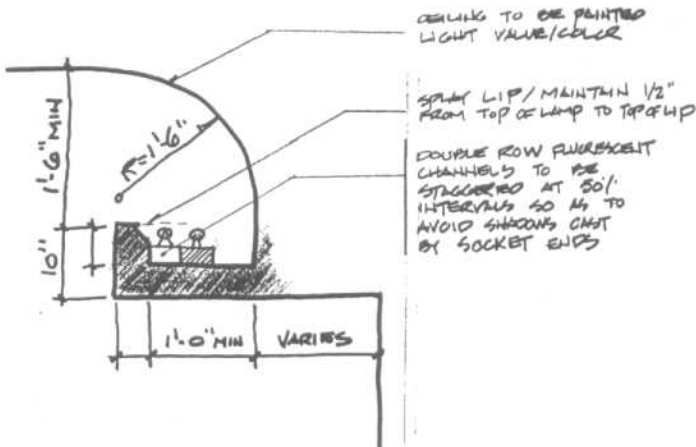
Cove Lighting for Merchandise Displays



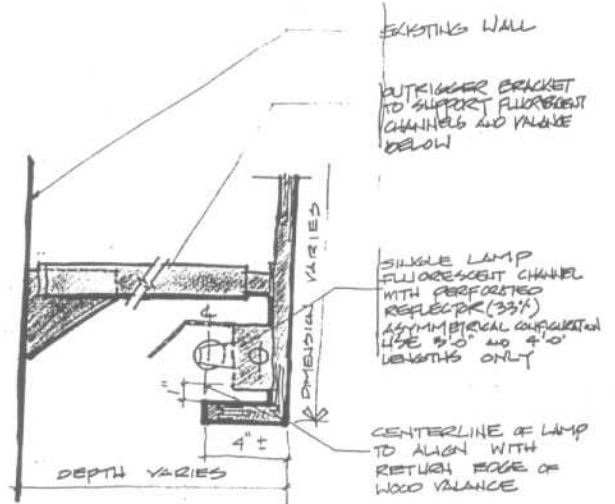
SHIELDED VALANCE WITH SINGLE LAMP FLUORESCENT CHANNEL CURTAIN WALL TYPE



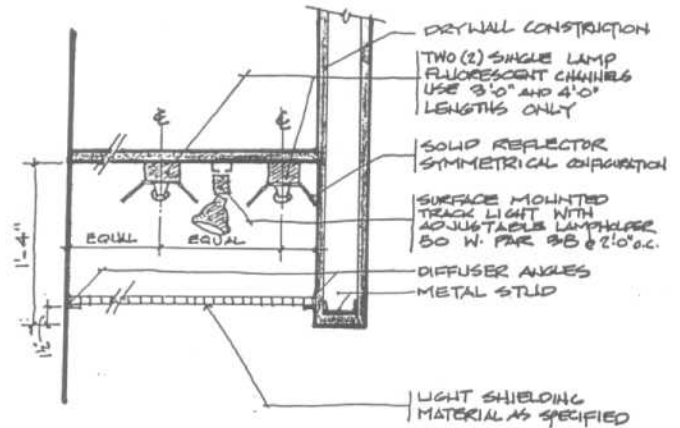
DIRECT COVE SINGLE/DOUBLE ROW STAGGERED FLUORESCENT



INDIRECT/CURVED COVE DOUBLE ROW FLUORESCENT



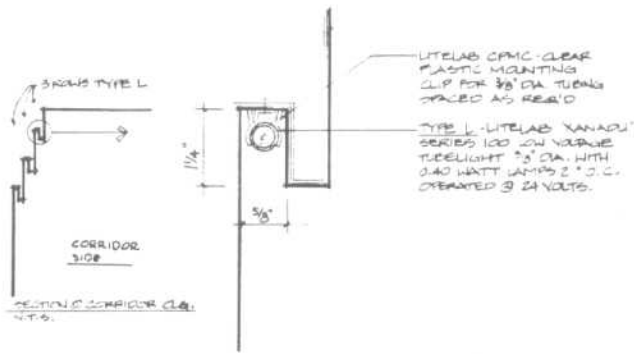
VALANCE WITH SINGLE LAMP FLUORESCENT CHANNEL



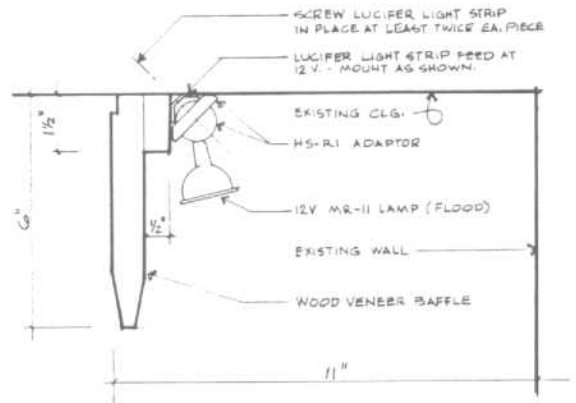
SHIELDED VALANCE WITH TWO (2) SINGLE LAMP FLUORESCENT CHANNELS AND TRACK LIGHT WITH INCANDESCENT "CURTAIN WALL" TYPE

LIGHTING

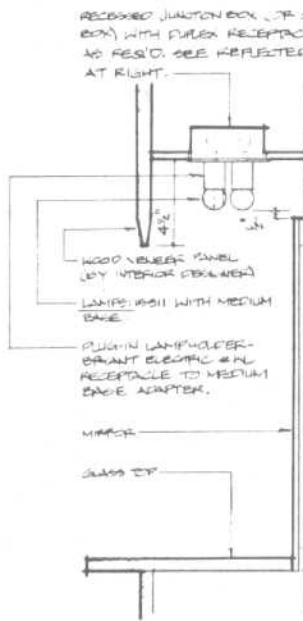
Miscellaneous Lighting Details



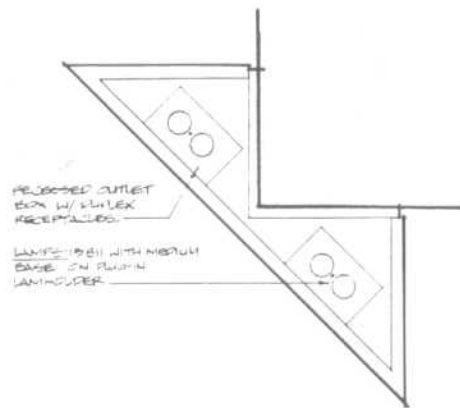
SECTION - TYPE L  
SCALE: 3/4" = 1'-0"



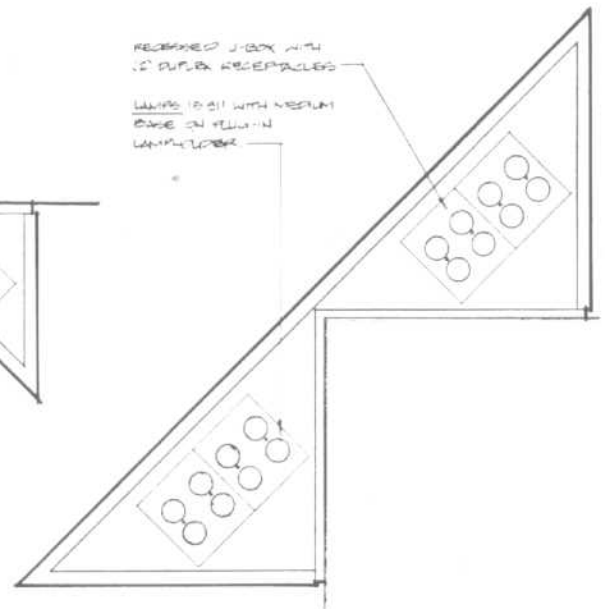
SECTION - TYPE M  
SCALE: HALF SIZE



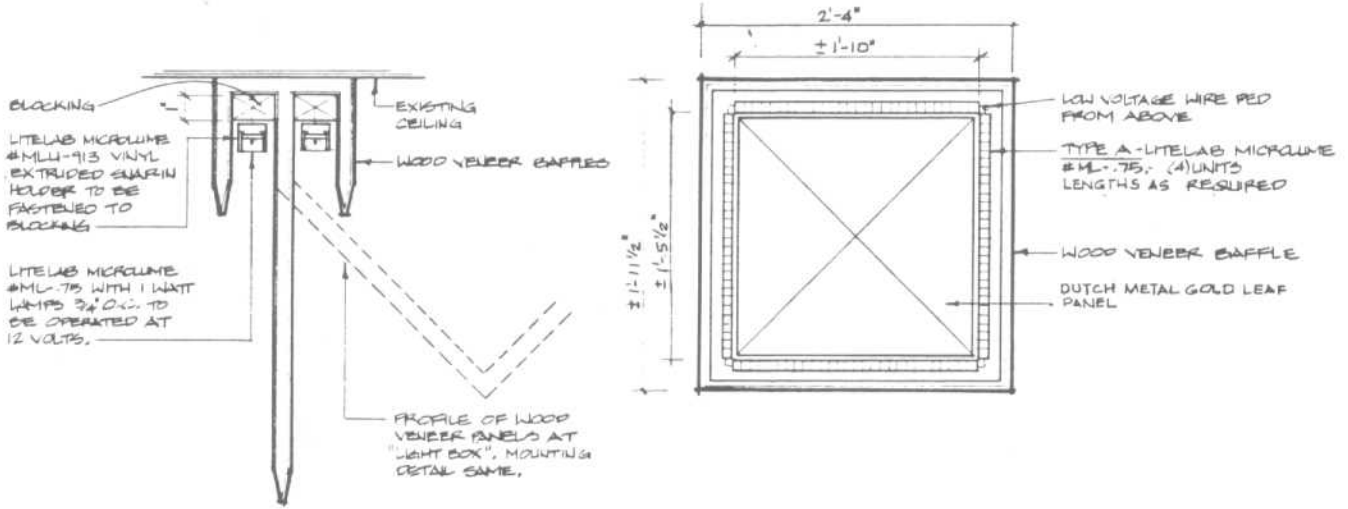
SECTION - TYPE G  
SCALE: 3/4" = 1'-0"



REFLECTED PLAN DINING ROOM  
SCALE: 3/4" = 1'-0"

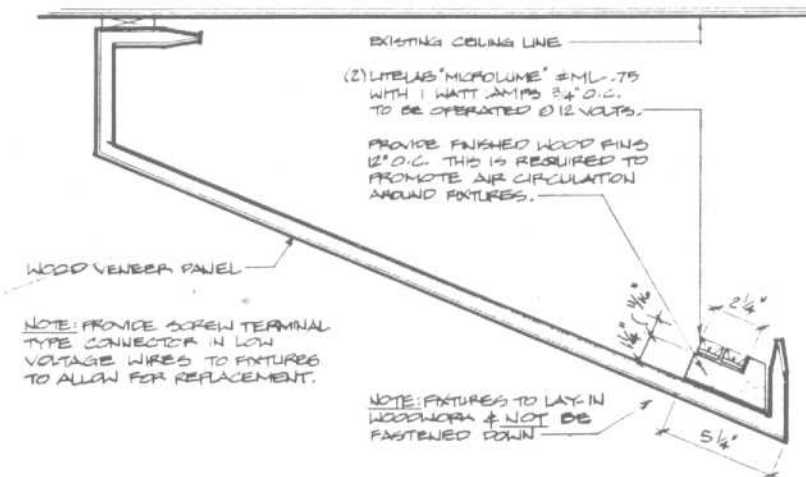


REFLECTED PLAN 2 AUDIO VISUAL AREA  
SCALE: 3/4" = 1'-0"

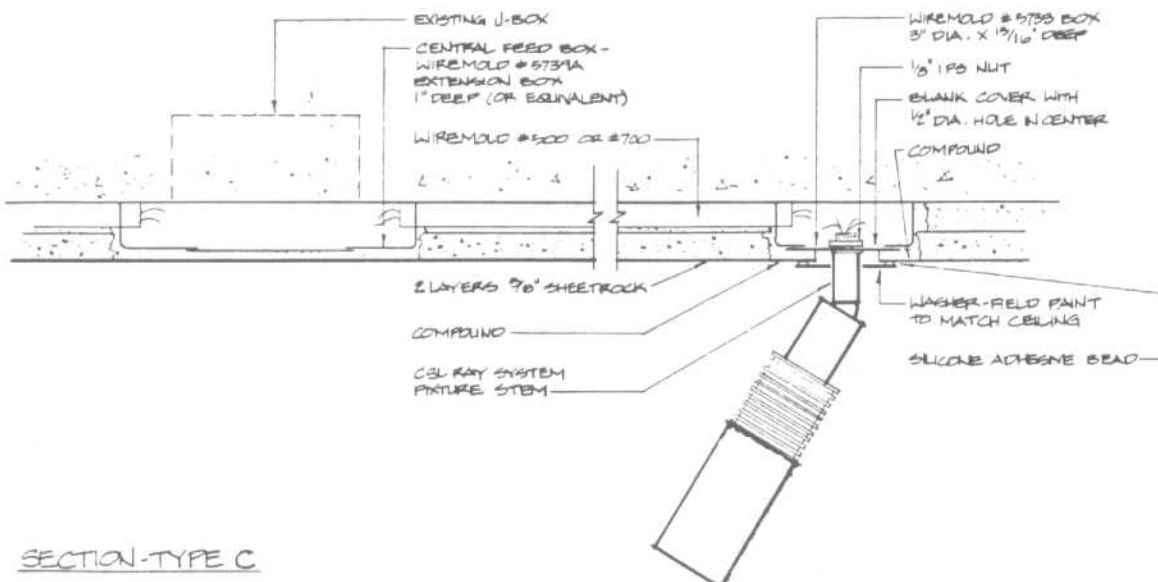


SECTION-TYPE A

REFLECTED PLAN @ LIGHT BOX-



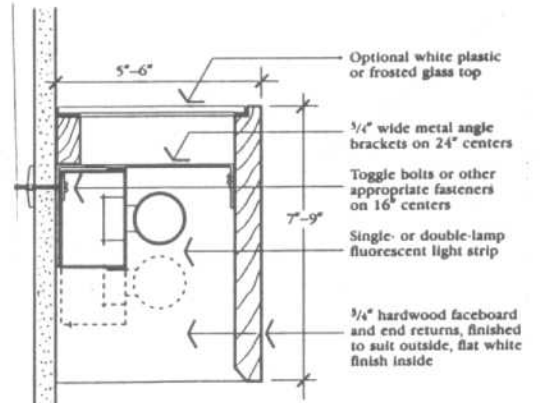
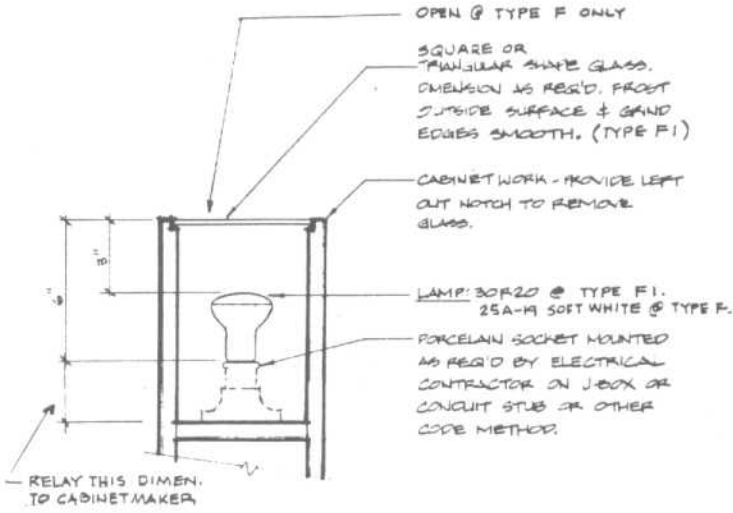
SECTION-TYPE B



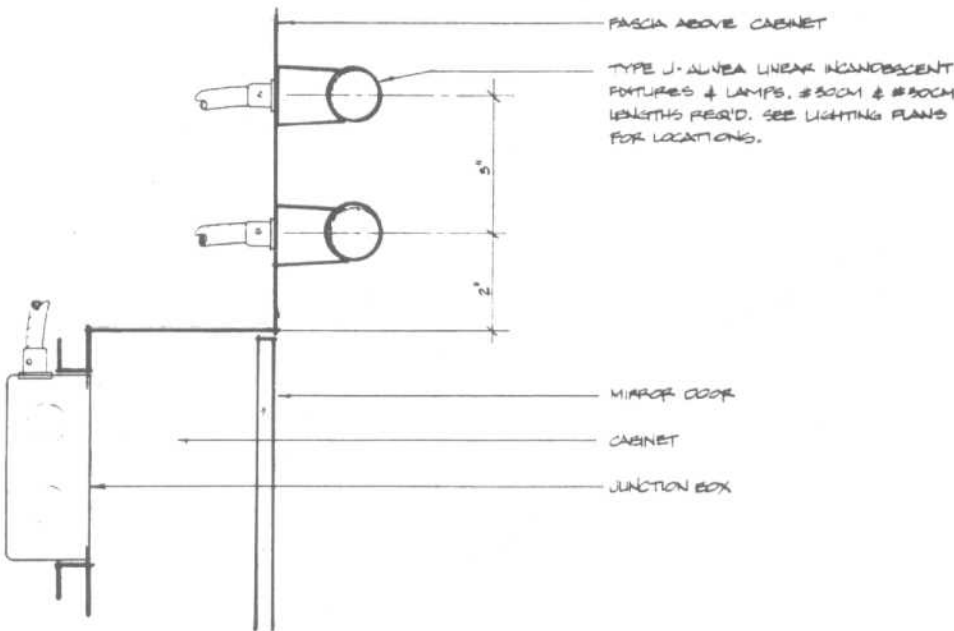
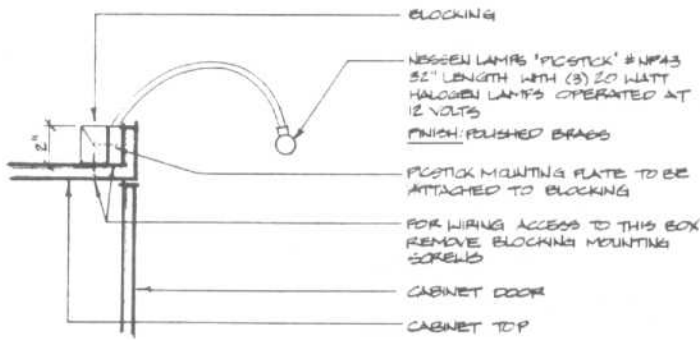
SECTION-TYPE C

LIGHTING

Miscellaneous Lighting Details

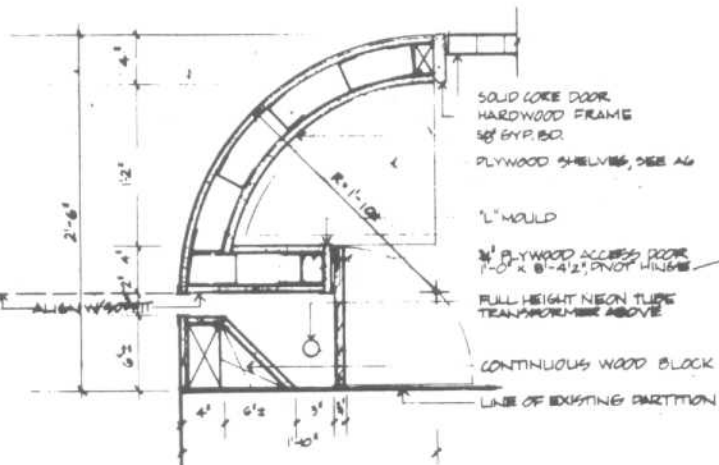


Wall bracket cross section

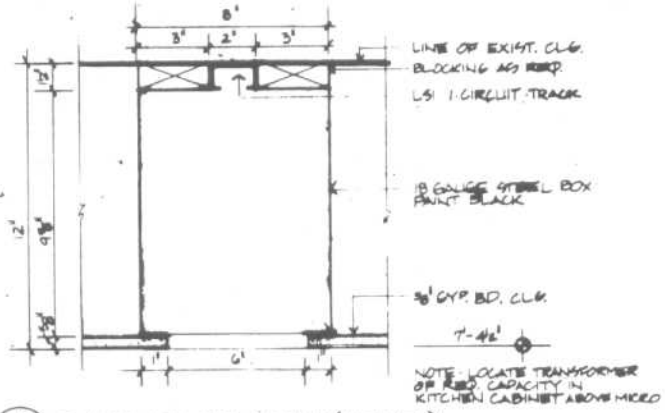


**LIGHTING**

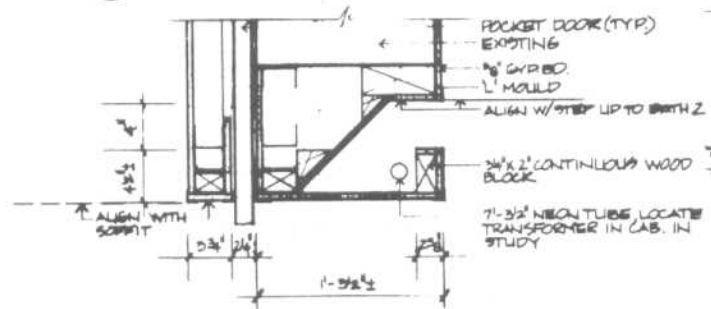
Miscellaneous Lighting Details



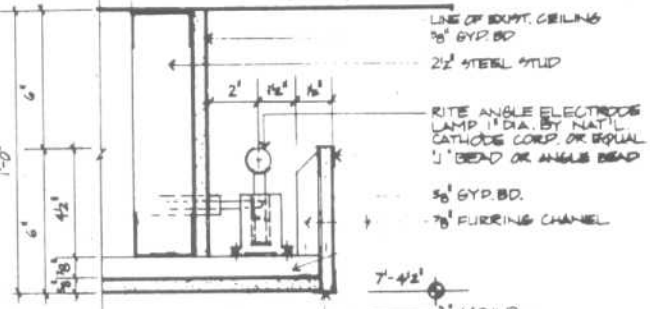
1 PLAN: NEON/NICHE: ENTRY  
A4 1/2" x 1'-0"



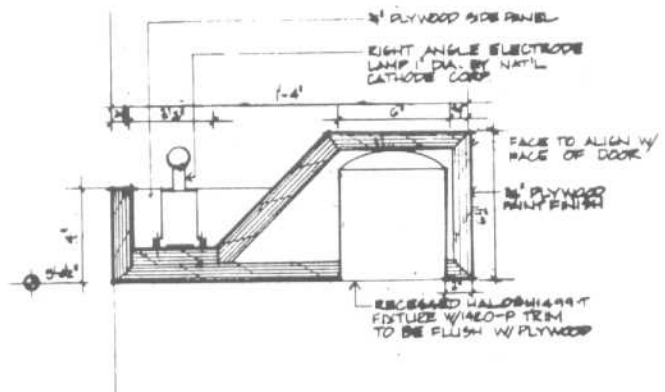
3 RECESSED LIGHT THROUGH (KITCHEN)  
A4 3/4" x 1'-0"



2 PLAN: NEON NICHE: STUDY  
A4 1/2" x 1'-0"



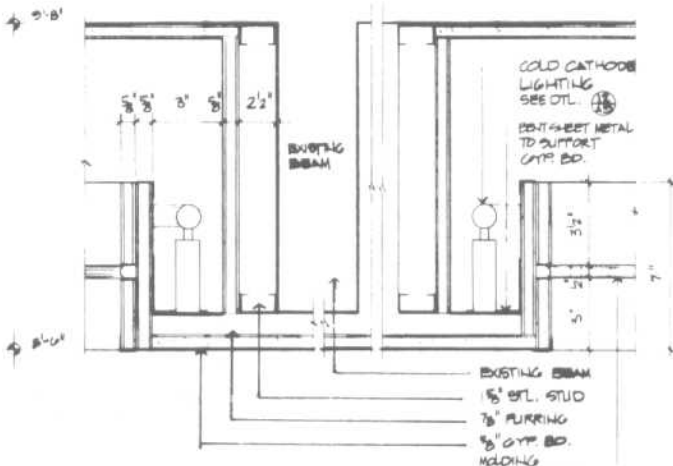
4 COVE LIGHTING: TYPICAL SECTION  
A4 3/4" x 1'-0"



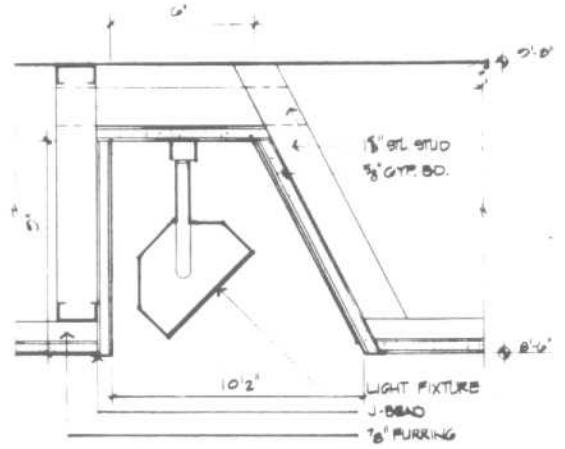
5 LIGHT FIXTURE OVER BED: BDRM I  
A4 3/4" x 1'-0"

LIGHTING

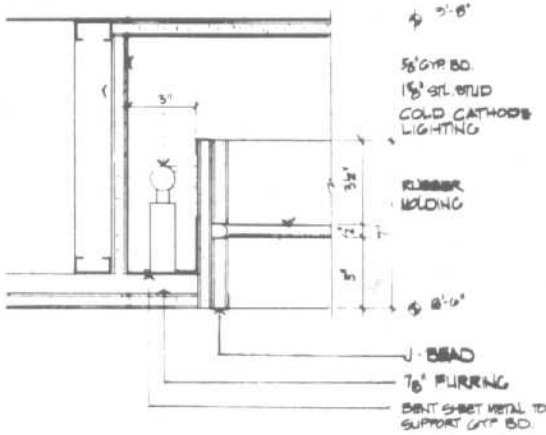
Miscellaneous Lighting Details



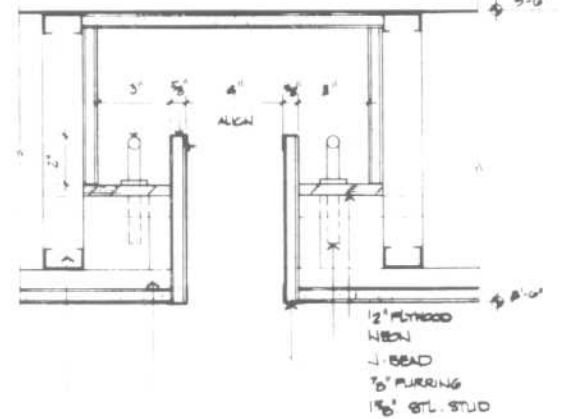
11 DETAIL: COVE LIGHTING IN LIVING ROOM  
3" x 1'-0"



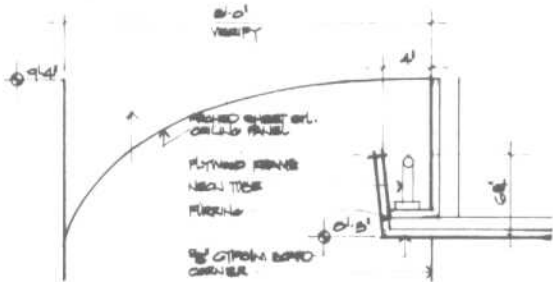
13 DETAIL: COVE LIGHTING @ SLOPED WALL & WALL  
3" x 1'-0"



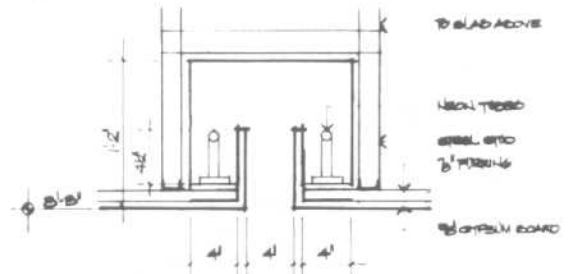
12 DETAIL: COVE LIGHTING IN LIVING, DINING & PAR. RMS.  
3" x 1'-0"



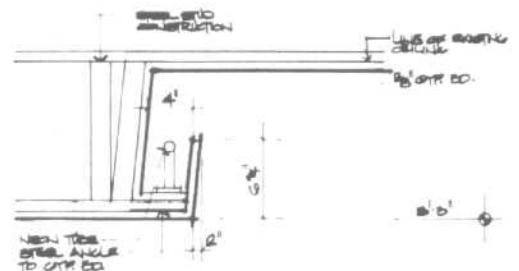
14 DETAIL: NEON RECESSED @ ENTRY  
3" x 1'-0"



DETAIL: COVE LIGHT @ BAR  
1 1/2" x 1'-0"



DETAIL: NEON @ FOYER  
1 1/2" x 1'-0"

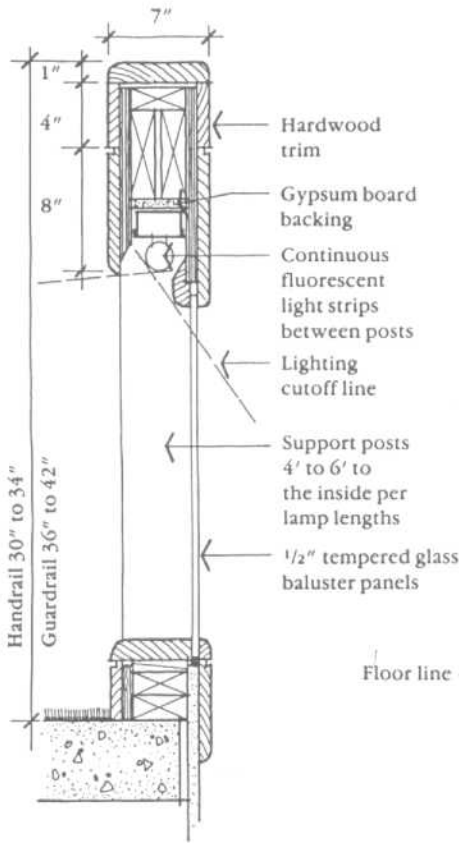


DETAIL: COVE LIGHTING  
1 1/2" x 1'-0"

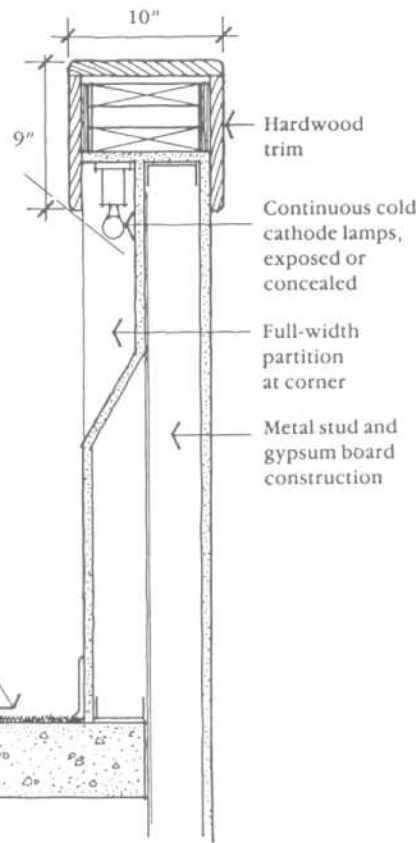


**LIGHTING**

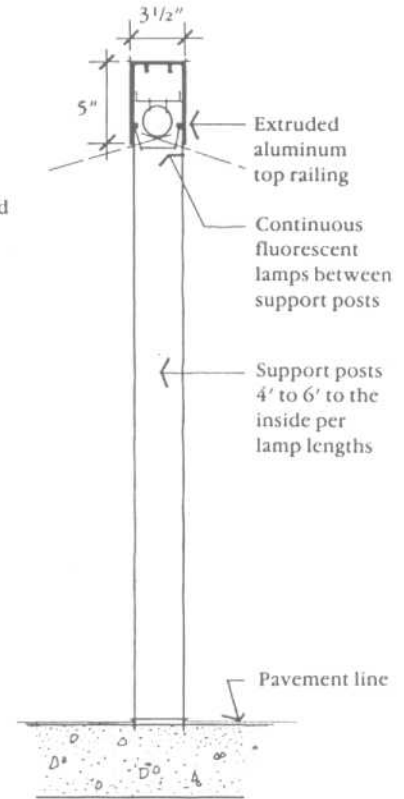
Handrail Lighting Details



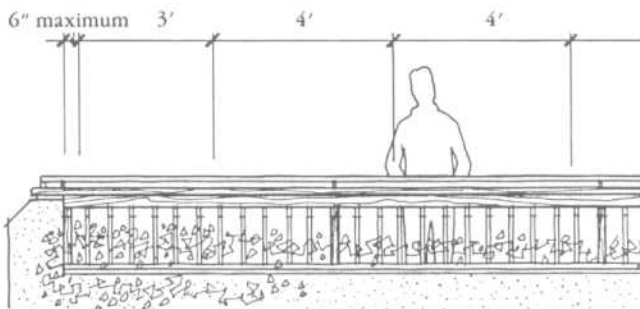
**Lighted wood and glass guardrail**



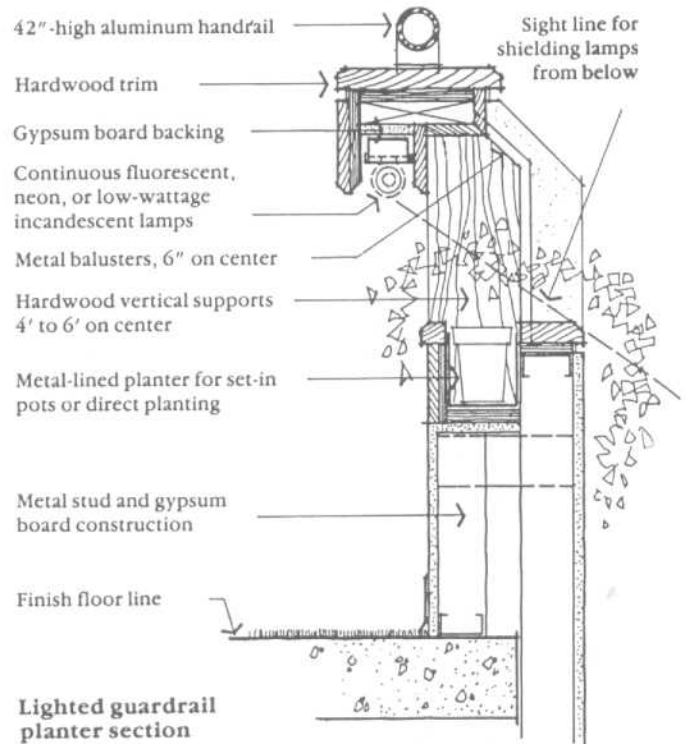
**Lighted low-partition guardrail**



**Extruded aluminum light rail**



*Elevation of lighted guardrail planter demonstrates the use of combined 3-foot and 4-foot fluorescent light strips to achieve overall lengths in 1-foot multiples. To minimize dark areas between lamps, use strips without end caps and install lamps back to back.*

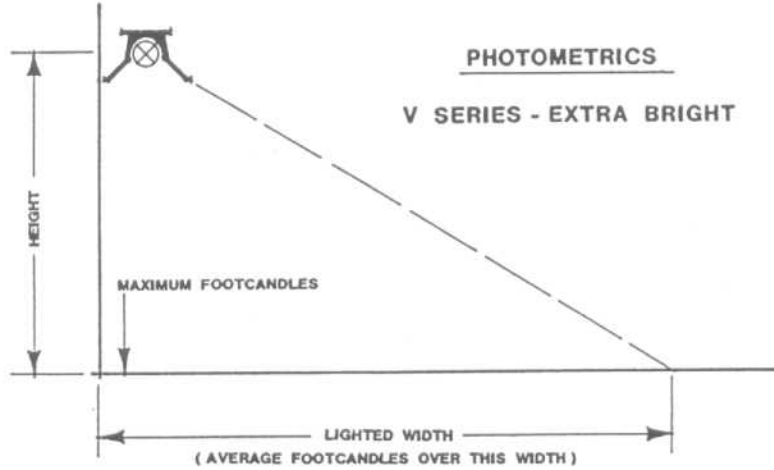


**Lighted guardrail planter section**

*Open circulation areas can be illuminated with lighted railings, as shown in this section of a lighted guardrail planter.*

LIGHTING

Stair Lighting Photometrics



FOOTCANDLES

HT. ABOVE FLOOR IN.	LIGHTED WIDTH IN. (1)	AVERAGE (2)	MAXIMUM (3)
6	11	5.0	13.0
8	14	3.8	9.8
10	18	3.0	7.8
12	21	2.5	6.5
18	32	1.7	4.4
24	42	1.3	3.3
30	53	1.0	2.6
36	63	0.8	2.1

NOTES:

1. LIGHTED WIDTH TO POINT FOOTCANDLE LEVEL FALLS TO 10% OF MAXIMUM
2. AVERAGE FOOTCANDLES OVER LIGHTED WIDTH
3. FOOTCANDLES DIRECTLY BELOW LIGHT FIXTURE

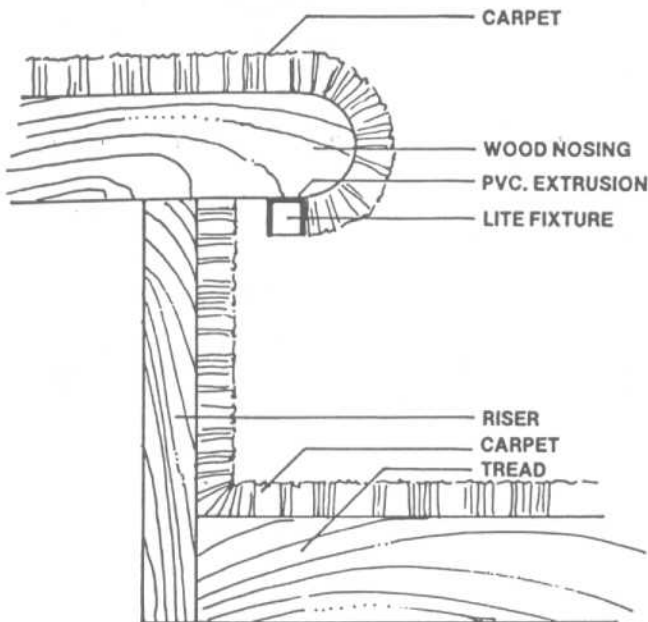


Fig. 16 Surface-mounted step light.

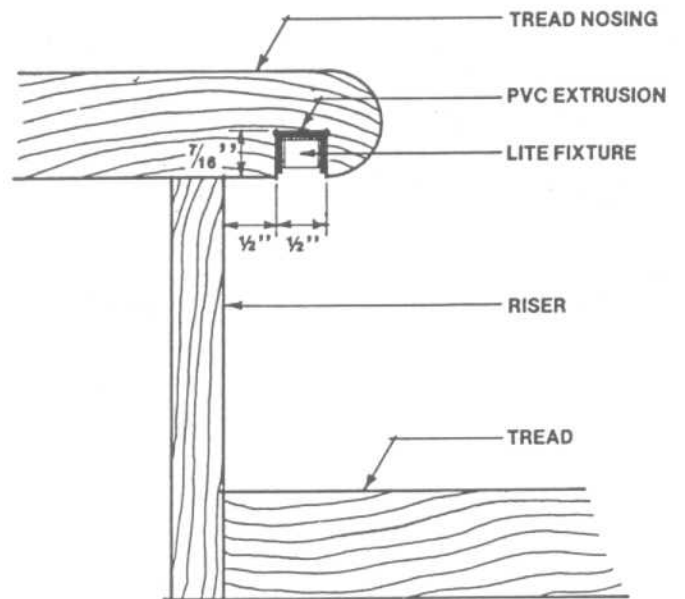
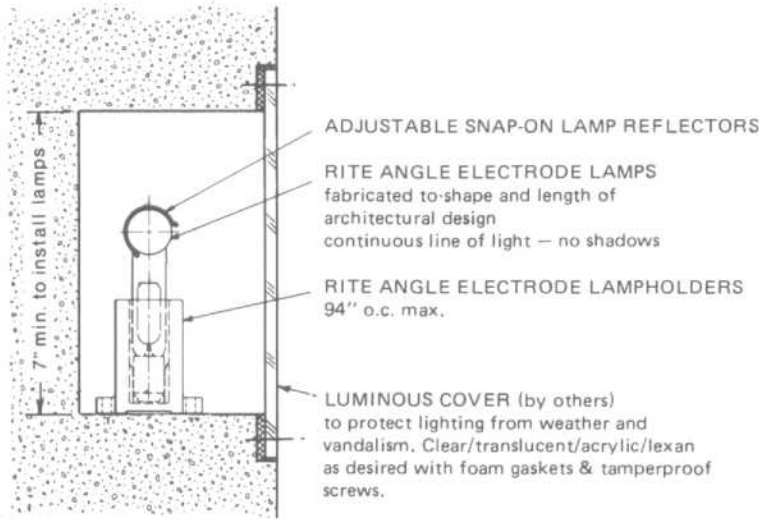
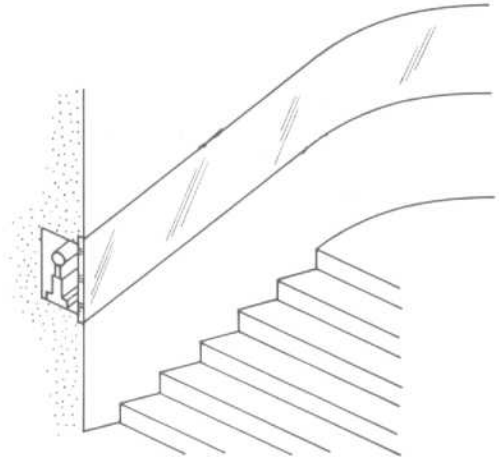


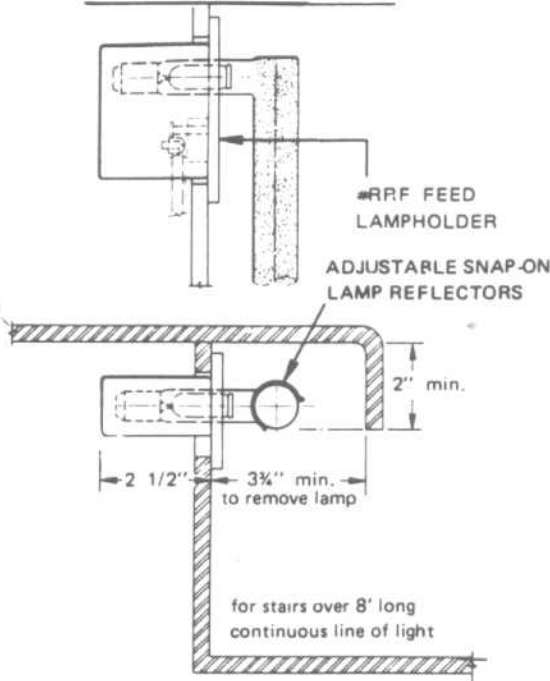
Fig. 17 Recessed step light.



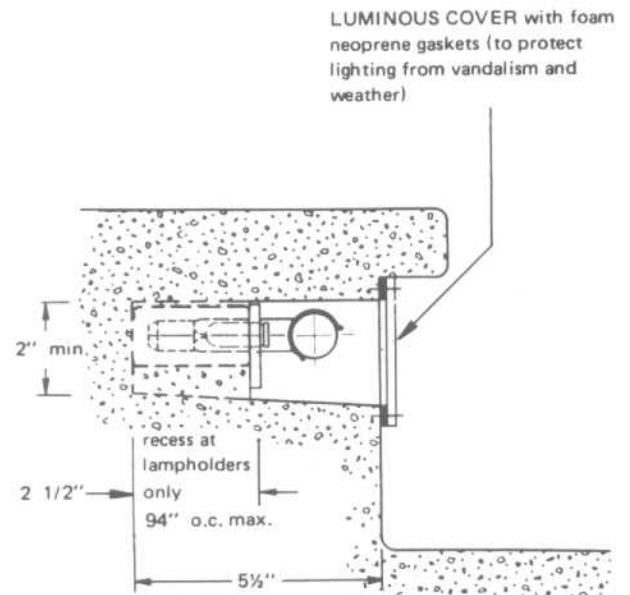
Wall recessed stair lighting



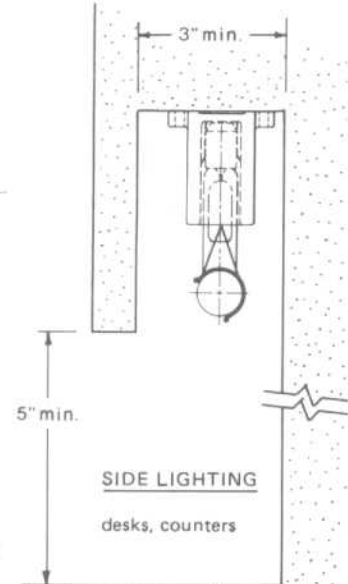
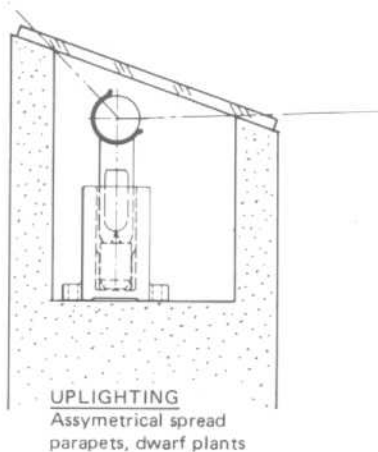
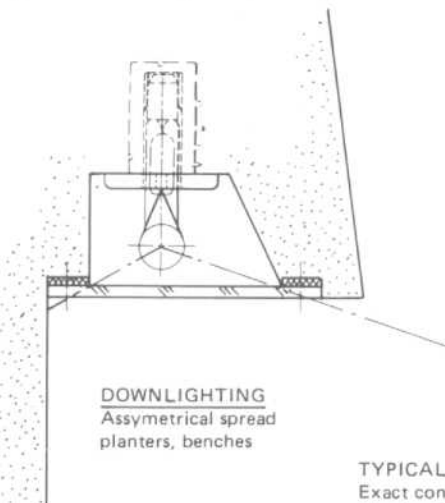
Schematic perspective



Typical section through riser (interior)



Typical section through riser (exterior or interior)

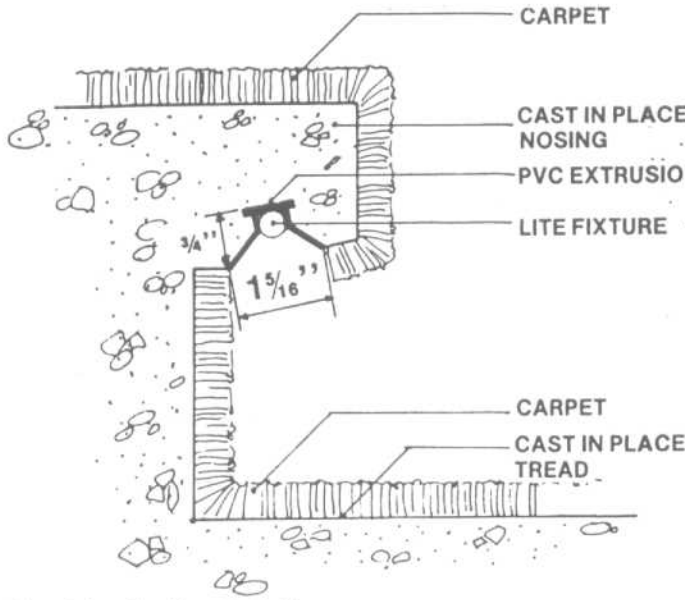


TYPICAL DESIGNS/SUGGESTED CONSTRUCTIONS  
Exact construction as required within parameters of illumination desired, lamps and lampholders.

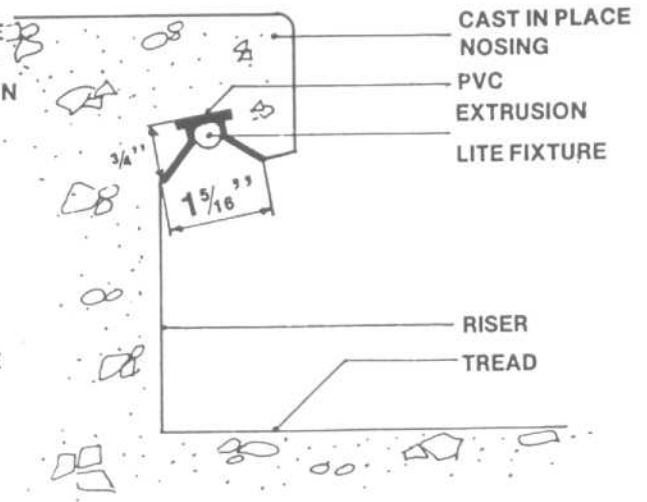
Alternate stair lighting designs

LIGHTING

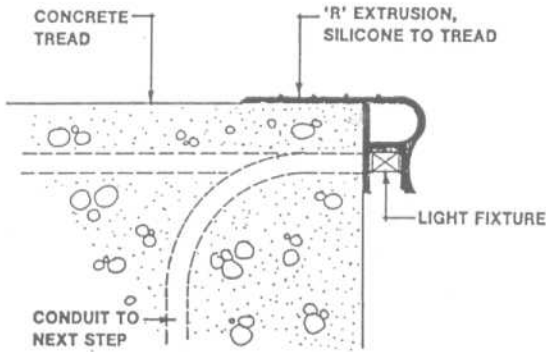
Stair Lighting Details



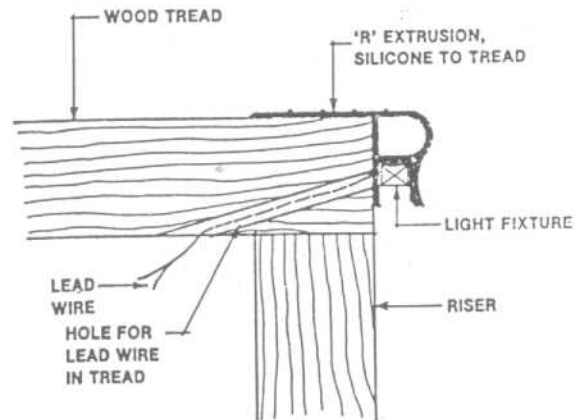
Carpeted cast-in-place step light



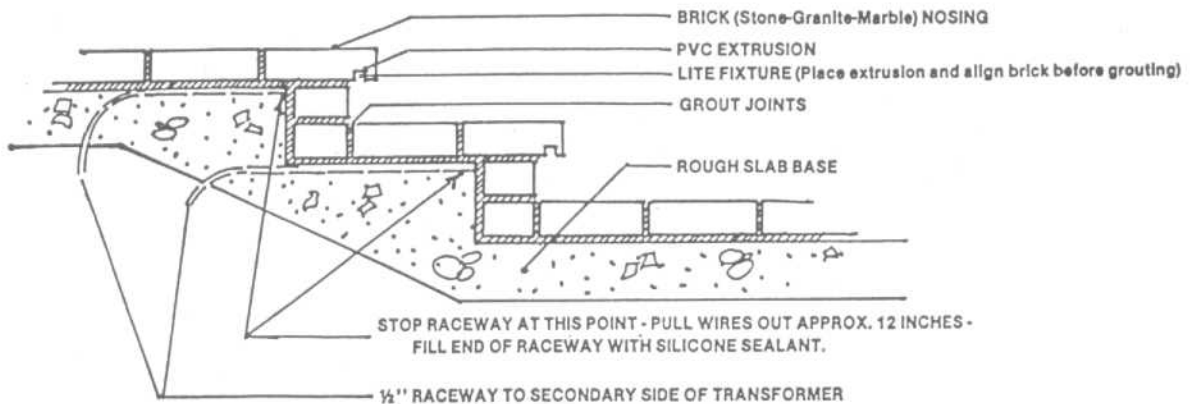
Exposed cast-in-place step light



Concrete surface-applied bonded extrusion

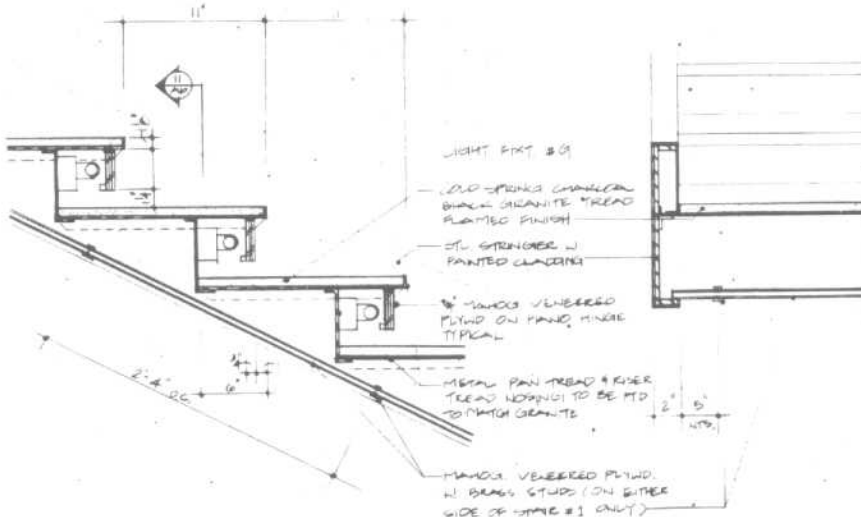


Wood surface-applied bonded extrusion



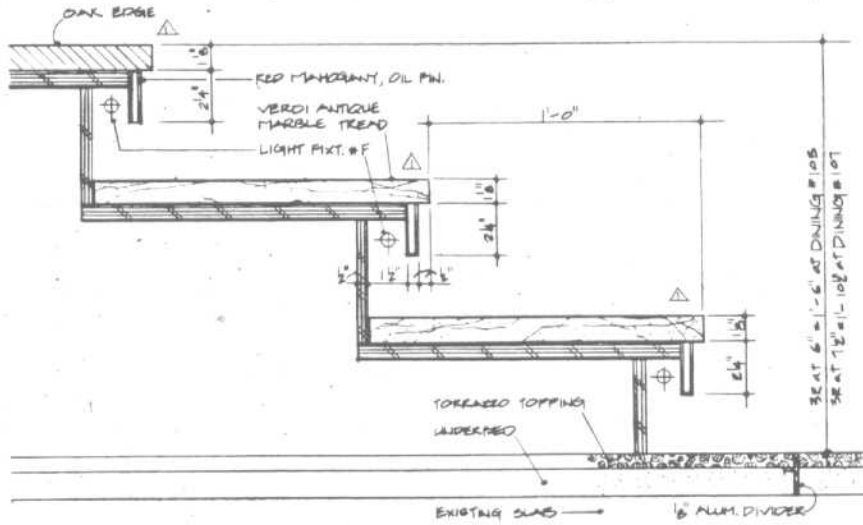
Brick steps with recessed light

**LIGHTING**  
Stair Lighting Details

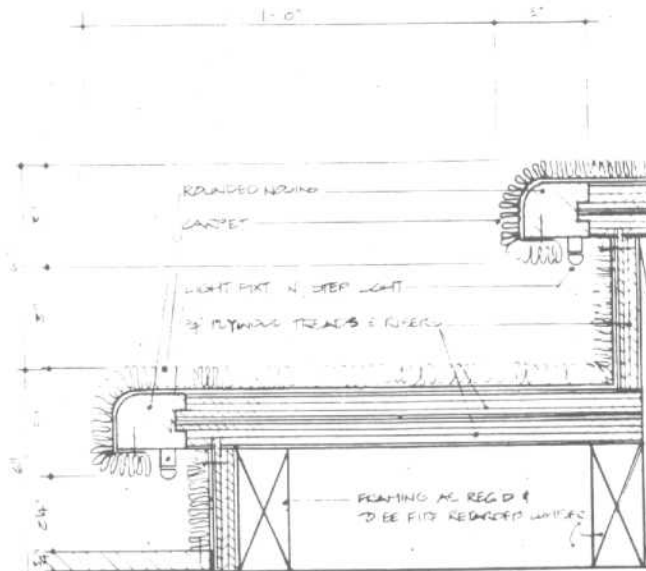


10  
A10  
DETAIL OF TREAD & RISER AT STAIRS #1 & #2

11  
A10  
DETAIL OF STRINGER AT STAIRS #1 & #2



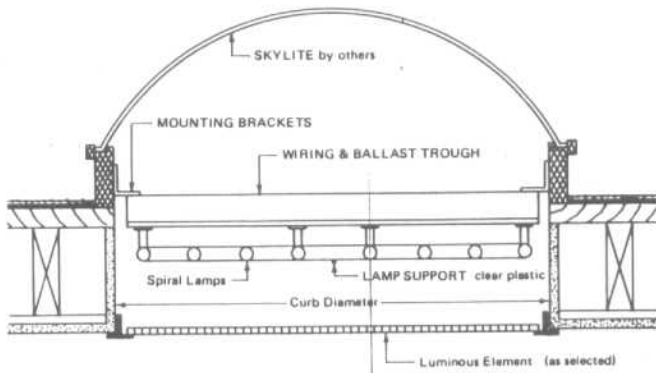
21  
A1  
DETAIL OF MARBLE STEP



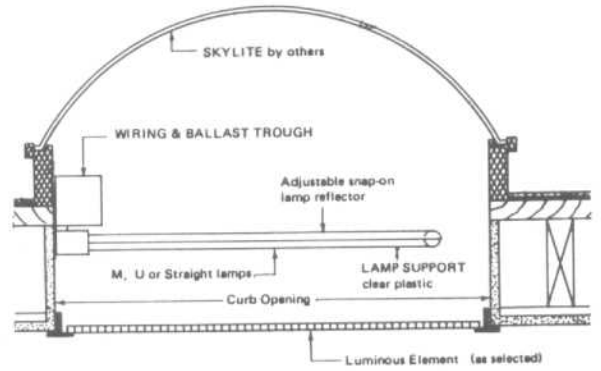
22  
A1  
DETAIL OF STEP LIGHTS AT LOUNGE # 08

LIGHTING

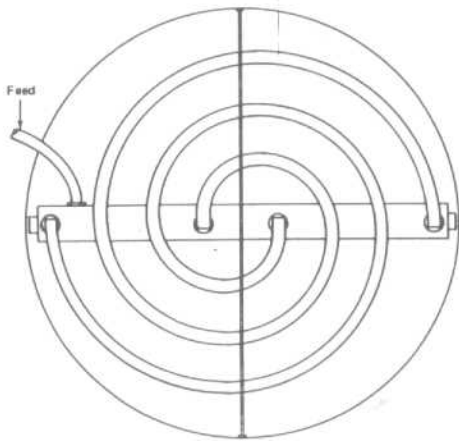
Skylight Lighting Details



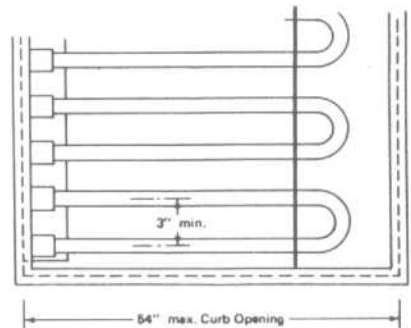
SECTION THRU TYPICAL SKYLITE



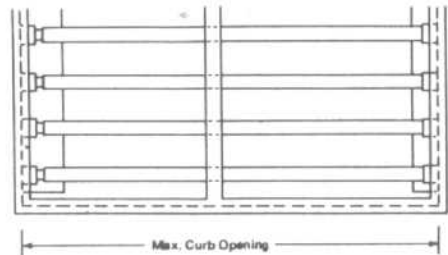
SECTION THRU TYPICAL SKYLITE



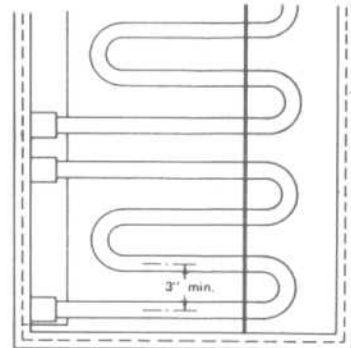
TYPICAL PLAN - 2 SPIRAL LAMPS  
(without luminous element)



TYPICAL PLAN - U LAMPS



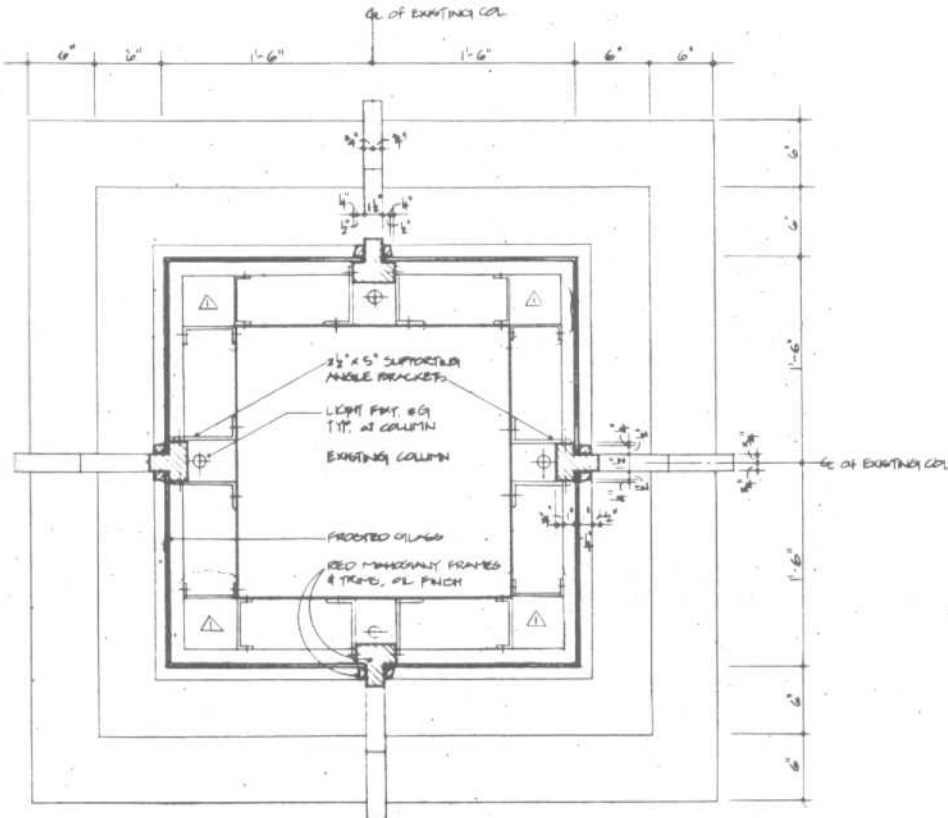
TYPICAL PLAN - STRAIGHT LAMPS



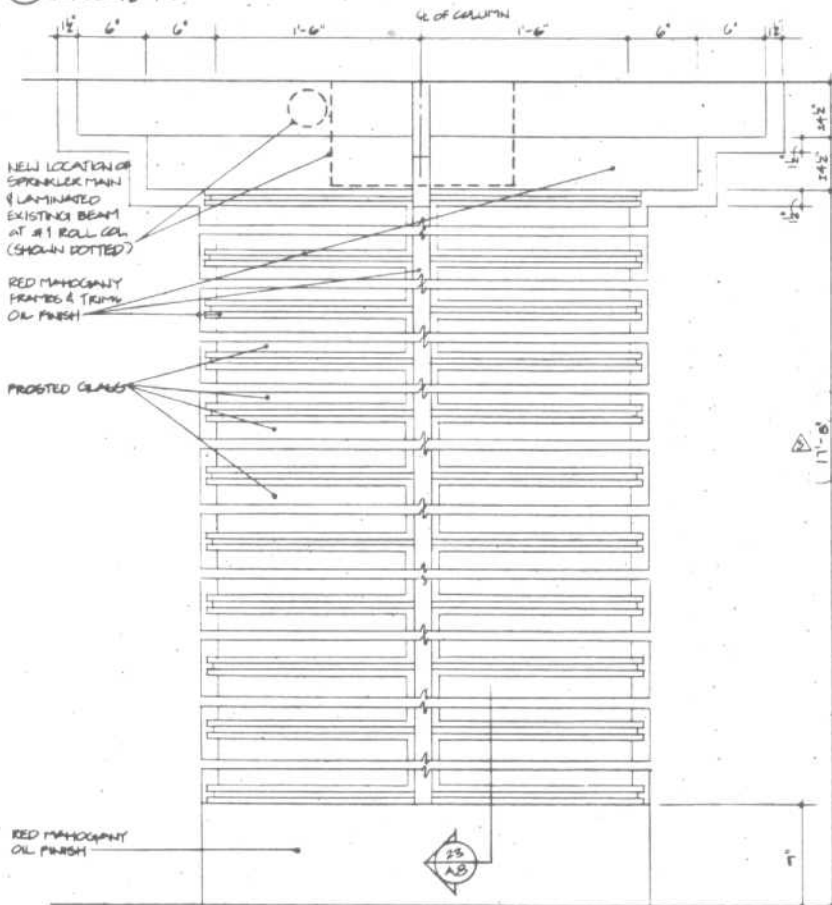
TYPICAL PLAN - M LAMPS

Fig. 18 Skylight lighting. Skylight serves as fixture — does not interfere with natural lighting, will not cast shadows on luminous element. Spiral, M, U, and straight lamps fabricated to fit curb opening.

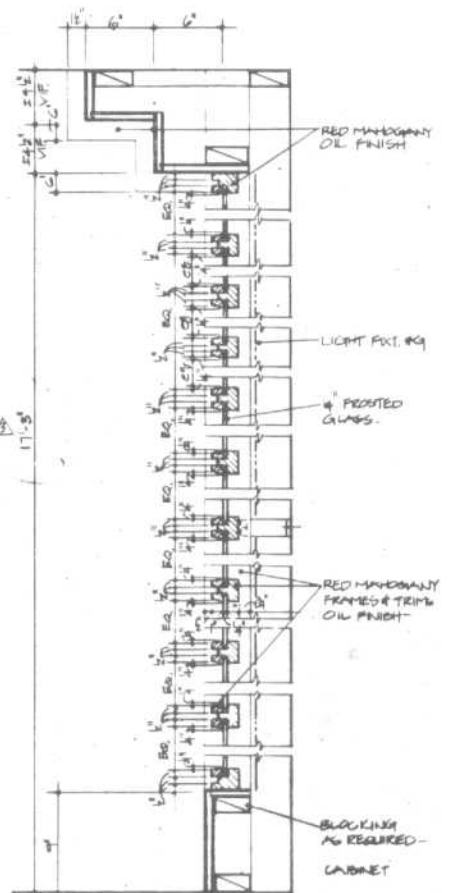
**LIGHTING**  
Lighted Column Details



21 PLAN DETAIL OF LIGHTED COLUMN  
SCALE: 1/8" = 1'-0"



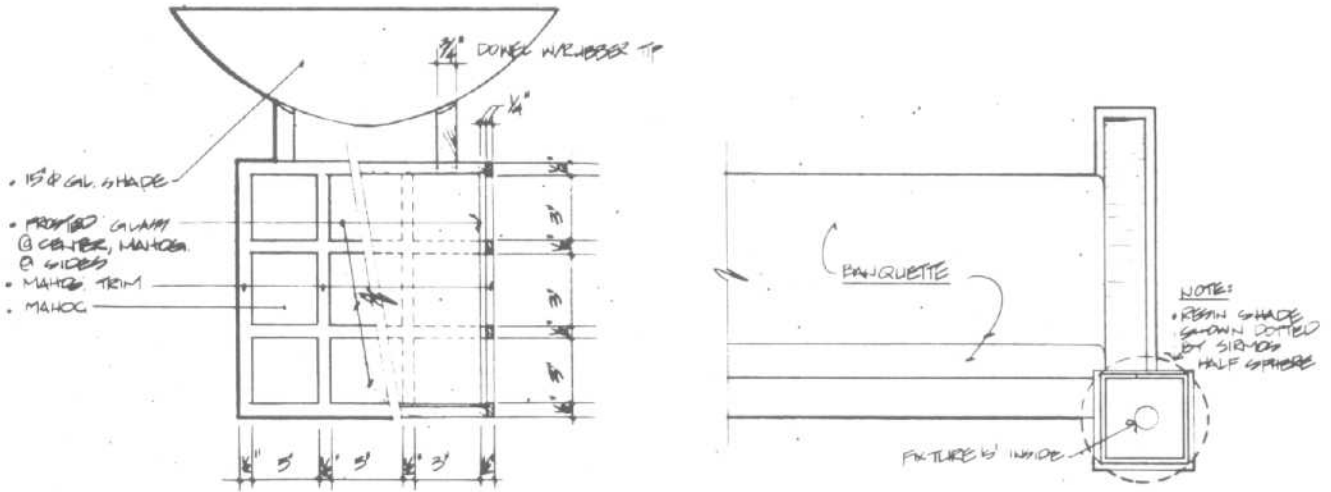
22 ELEVATION OF LIGHTED COLUMN  
SCALE: 1/8" = 1'-0"



23 SECTION OF LIGHTED COLUMN  
SCALE: 1/8" = 1'-0"

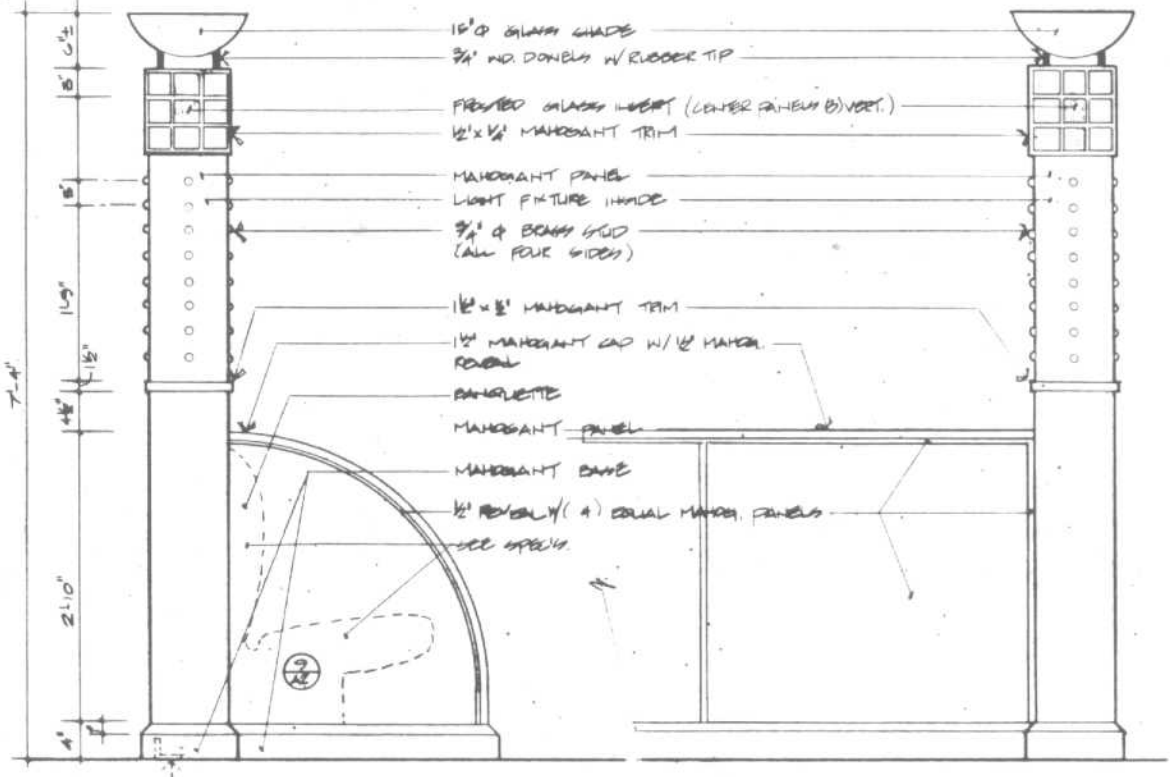
LIGHTING

Lighted Column Details



11 AS BLOW-UP DETL. OF UPLIGHT - SEE DETL. 12 AS  
SCALE: 3"=1'-0"

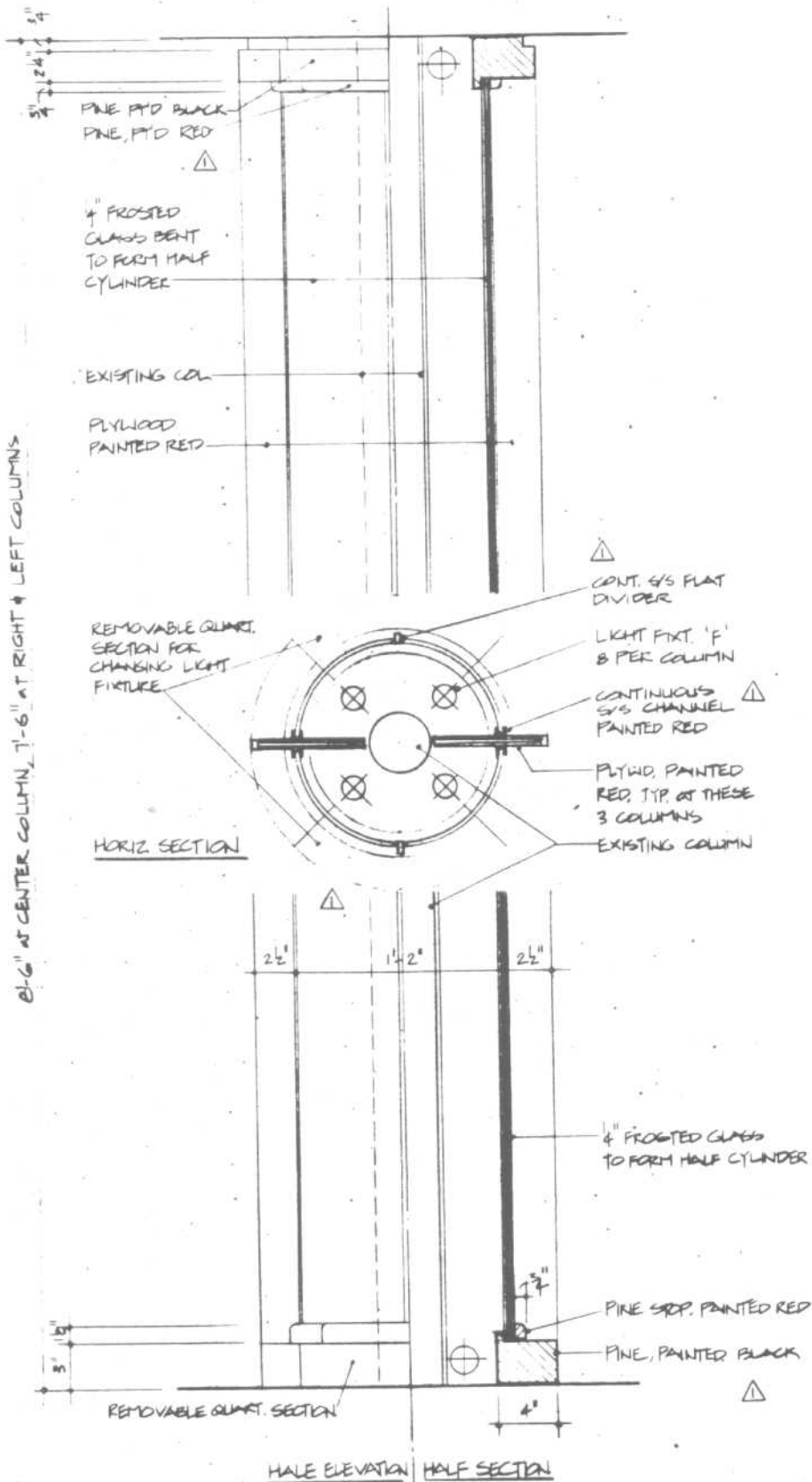
PLAN VIEW



12 AS CENTER BANQUETTE @ DINING OR - SIDE/BACK PLAN VIEW - SEE DETL. 11 AS  
SCALE: 1/4\"/>



**LIGHTING**  
Lighted Column Details



21'-6" AT CENTER COLUMN, 7'-6" AT RIGHT & LEFT COLUMNS

14  
A4  
DETAIL OF LIGHT COLUMN  
SCALE: 1/2" = 1'-0"

**LIGHTING**

**Ceiling-Mounted Cold Cathode Lighting Details**

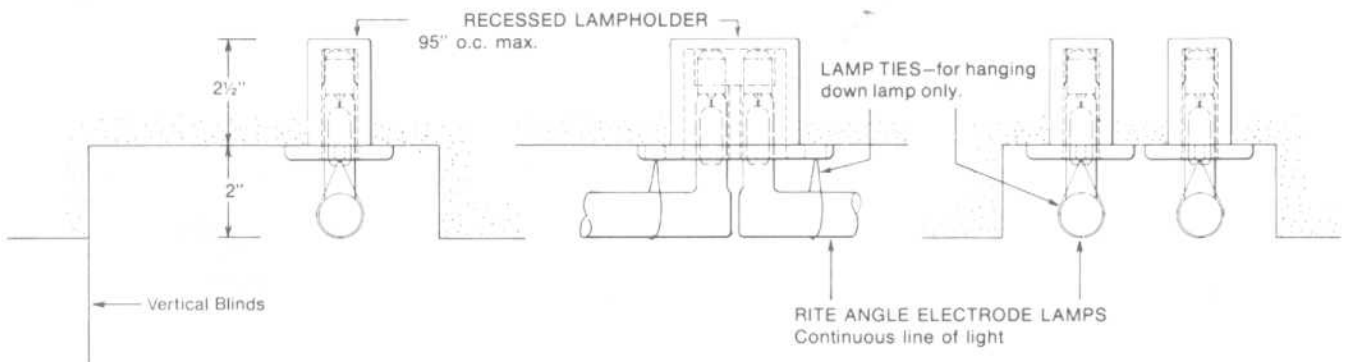
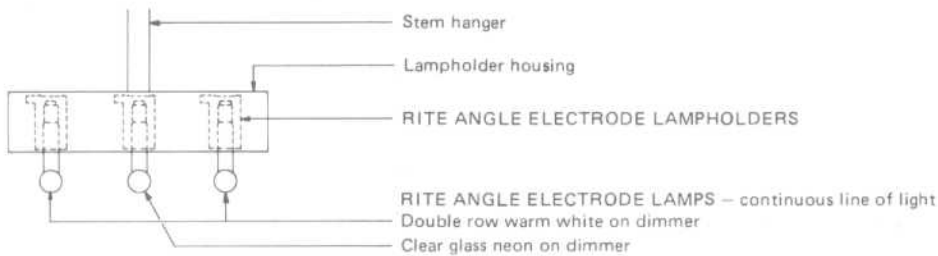
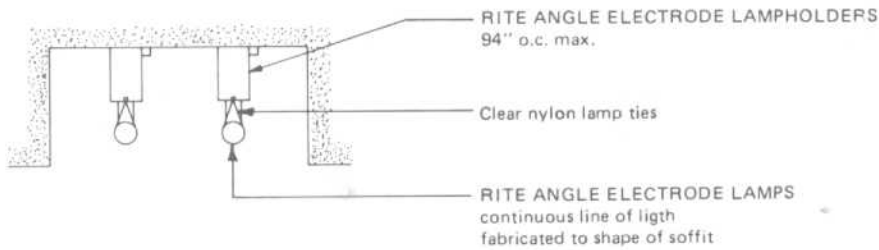
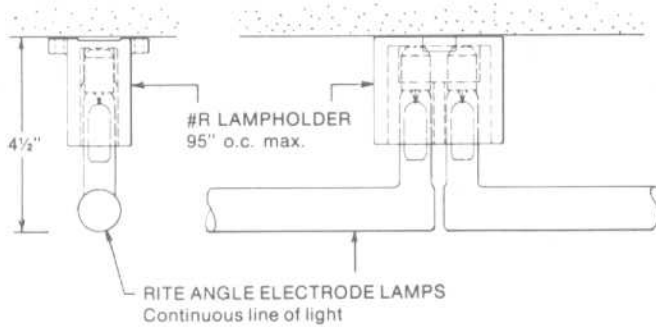
**Exposed/sculpture lamp lighting**

Cold cathode lighting, an architectural lighting tool with unusual flexibility.











Lamps fabricated to the architectural design, continuous line of light — low brightness — no glare — high efficiency — long life — approaches a permanent light source.

Remote transformers — no wiring troughs, ballasts, ballast failures, or hum. Only 2 leads for up to 120 feet of lamps.

Excellent uniform dimming — no premature flickering of individual lamps as with hot cathode lighting.



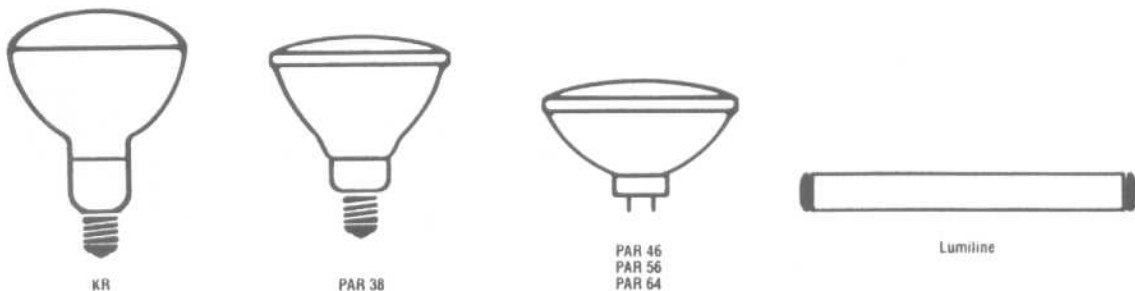
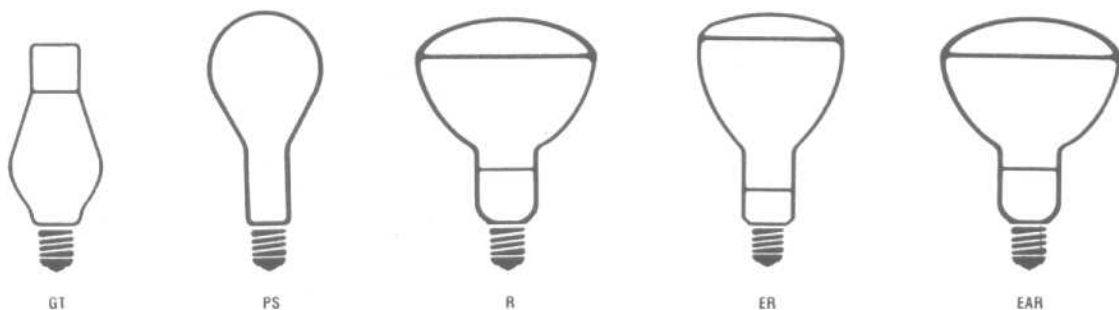
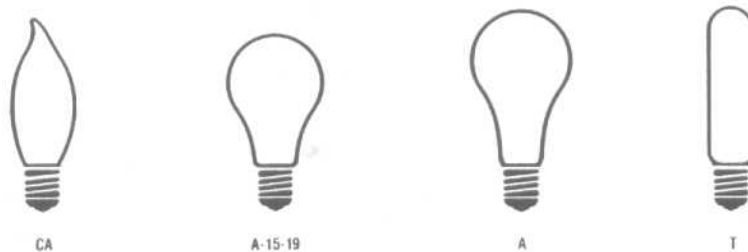
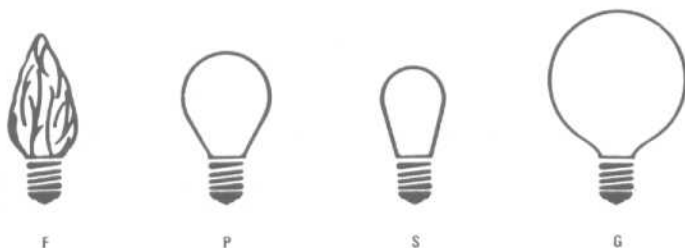
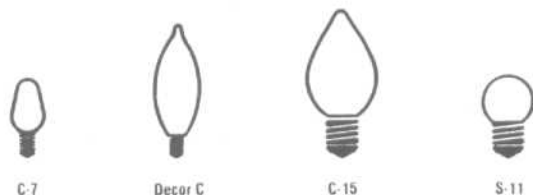
## Principal types of lamps for general lighting purposes

Category	Type	Maximum lamp efficacy lm/W	Average life hrs	Characteristic features	Typical application areas
Incandescent Lamps 	Normal incandescent lamps and reflector lamps	22	1,000	Easy to install, easy to use; many different versions; instant start; low cost price; reflector lamps allow concentrated light beams	General lighting in the home; decorative lighting; localized lighting; accent and decorative lighting (reflector lamps)
	Halogen	27	2,000	Compact; high light output; white light, easy to install; long life compared with normal incandescent lamps	Accent lighting; floodlighting
Fluorescent Lamps 	Tubular	104	20,000	Wide choice of light colors, high lighting levels possible; economical in use	All kinds of commercial and public buildings; streetlighting; home lighting
	SL*	61	10,000	Energy-effective; direct replacement for incandescent lamps	Most applications where incandescent lamps were used before
	PL*	80	10,000	Compact; long life; energy-effective	To create a pleasant atmosphere in social areas, local lighting; signs, security, orientation lighting and general lighting
Gas-Discharge Lamps 	Self-ballasted	28	12,000/16,000	Long life, good color rendering; easy to install; better efficacy than incandescent lamps	Direct replacement for incandescent lamps; small industrial and public light projects; plant irradiation
	High pressure mercury	63	24,000 +	High efficacy; long life; reasonable color quality	Residential area lighting; sports grounds; factory lighting
	Metal halide	94	15,000	Very high efficacy combined with excellent color rendering; long life	Floodlighting, especially for color TV; industrial lighting; road lighting; plant irradiation
	High pressure sodium	125	24,000 +	Very high efficacy; extremely long life; good color rendering	Public lighting; floodlighting; industrial lighting; plant irradiation. EL: direct replacement for mercury lamps
	Low pressure sodium	200	18,000	Extremely high efficacy; very long life; high visual acuity; poor color rendering; monochromatic light	Many different application areas: wherever energy/cost-effectiveness is important and color is not critical

LIGHTING

Planning Data: Incandescent Bulb Sizes

INCANDESCENT BULBS



A Bulb designation consists of a letter(s) to indicate the shape and a figure(s) to indicate the approximate major diameter in eighths of an inch. Bulbs are measured through their greatest diameter, in eighths of an inch. Thus, a F-15 bulb is a flame shape, 15/8 of an inch or 1 7/8 inches in diameter.

**BASES**



Mini-Can  
Screw  
Mini-Can



Candelabra  
Cand



E-14 Screw  
European Base



Intermediate  
Inter



B-15 Bayonet  
European Base



B-22 Bayonet  
European Base



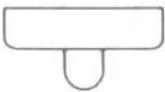
Single Contact  
Bayonet  
Candelabra  
S C Bay



Double Contact  
Bayonet  
Candelabra  
D S Bay



Candelabra  
Prefocus  
S C Pl  
D C Pl



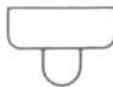
Single Pin  
IT 12 Slimline



Miniature Bipin  
Min. Bipin  
IT 5 F Lamp



Single Pin  
IT 6 Slimline



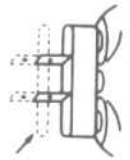
Single Pin  
IT 8 Slimline



Mini Screw  
M S



Screw  
Terminal  
Scr. Term.



Ext Mog  
End Prong  
Mogul  
End Prong  
Mog E Pr



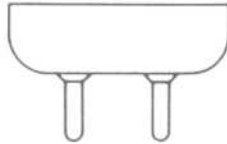
Medium  
Prefocus  
Med Pl



Standard



3 Contact  
Medium  
3 C Med



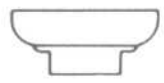
Mogul Bipin  
Mog. Bipin  
IT 17 F Lamp



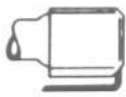
Rect RSC  
Recessed Single  
Contact



Disc  
Luminaire



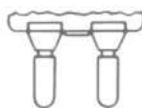
Recessed  
Dbl Contact  
IT 12 F Lamp



Metal Sleeve



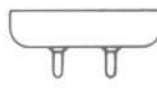
Medium 2 Pin



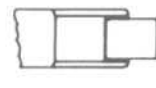
Med Bipost



Medium Bipin  
Med Bipin  
IT 8 F Lamp



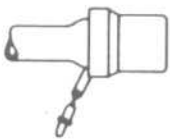
Medium Bipin  
Med Bipin  
IT 12 F Lamp



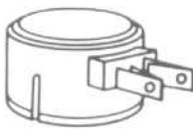
RSC  
Recessed Single  
Contact



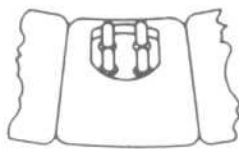
Mini Can  
Socket



Ceramic Tubular



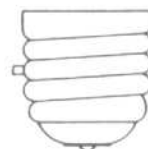
Medium  
Side Prong



4 Pin  
IT 10 F Lamp



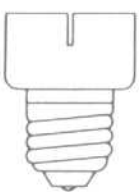
Mogul Bipost  
Mog. Bip.



Position Oriented  
Mogul  
Pos Or Mog



Type G  
Axial Lead



Medium  
Skirted  
Med Skt



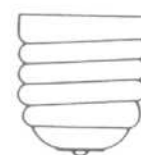
Medium  
Skirted  
Med Skt



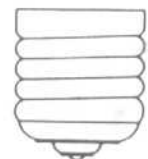
Admedium  
Skirted  
Admed



Mogul  
Prefocus  
Mog Pl



Mogul  
Mog



Three Contact  
Mogul  
3 C Mog

**LIGHTING**

Planning Data: Light Level Recommendations

**OFFICE**

**LIGHT LEVEL RECOMMENDATIONS**

Type of Work	Foot Candles*
Corridors, lobbies	10-15-20
Easy tasks (Typed originals, ball-point pen handwriting, large print)	20-30-50
Medium tasks (Poor copies, medium hard pencil, small print)	50-75-100
Difficult tasks (Very poor copies, hard pencil writing)	100-150-200

\*Choose an illuminance value in the mid-range for your type of activity. Then decide upon a specific value (Same, lower, or higher) within that range by considering the age of the workers and the importance of the work.

**SELECTING THE PROPER FIXTURE**

- **Light Output/Efficiency**  
The more light, the fewer fixtures needed in new lighting systems and lower operating cost.
- **Visual Comfort**  
Fixtures should direct light to the task and away from the eyes. The fixture's VCP rating, available from the fixture manufacturer, should be 70 or above.
- **Maintainability**  
Check ease of lamp replacement, cleanability, and permanence of finishes.
- **Fit In Application**  
Should look right and cover the area to be lighted (consider smaller fixtures closer together, such as 2 x 2s instead of 2 x 4s, for lower ceilings, or lower light levels or high-panelled work stations).

**STORE**

LIGHT LEVEL RECOMMENDATIONS			
	Circulation	Merchandising	Feature Displays
High Activity Area (Mass Merchandiser)	30	100	500
Medium (Family Dept. Store)	20	70	300
Low (Boutique, Specialty Stores)	10	30	150

● **Shielding Materials**

Comparison of lighting characteristics for typical 2 x 4 troffer luminaries:

Shielding Material	Efficiency Range (%)	VCP Range
Clear Lens	50-70	55-85
Polarizer	55-60	60-70
Deep Cell Parabolic Louver	45-60	70-85
Diffuser	40-60	40-50
Plastic Louver Panel (45°)	45-55	50-70
White Metal Louver (45°)	35-45	65-85
Parabolic Louver Panel (45°)	40-50	99
Toned Lens	30-60	70-85
Dark Metal Louver	25-40	70-90

**INDUSTRIAL**

LIGHT LEVEL RECOMMENDATIONS	
	Footcandles Maintained on the Task
<b>GARAGES—SERVICE</b>	
<input type="checkbox"/> repair	50-100fc
<input type="checkbox"/> active traffic areas	10-20fc
<b>LOADING PLATFORM</b>	20fc
<b>MACHINE SHOPS AND ASSEMBLY AREAS</b>	
<input type="checkbox"/> rough bench/machine work, simple assembly	20-50fc
<input type="checkbox"/> medium bench/machine work, moderately difficult assembly	50-100fc
<input type="checkbox"/> difficult machine work, assembly	100-200fc
<input type="checkbox"/> fine bench/machine work, assembly	200-500fc*
<b>RECEIVING &amp; SHIPPING</b>	20-50fc
<b>WAREHOUSES, STORAGE ROOMS</b>	
<input type="checkbox"/> active-large items/small items, labels	15fc/30fc
<input type="checkbox"/> inactive	5fc

\*Higher illuminance values may be achieved through a combination of supplementary and general lighting.

# 3

## Architectural Woodwork

Standard joinery and casework details	781
Woodwork details	804
Cornices and mouldings	866
Furniture hardware	887

## INTRODUCTION

Most residential and commercial projects require the design of a certain amount of architectural woodwork. Such woodwork may be in the form of built-in furniture, cabinets, display cases, reception desks, credenzas, work counters, kitchen cabinets, etc. The extent of detail necessary to intelligently communicate and identify the scope and character of required woodwork is an important consideration in the preparation of contract drawings. It is necessary, therefore, that the designer have a knowledge of basic wood joinery and understand how to apply it in the preparation of construction details.

Accordingly, the information in this section can be used as a general guide in the detailing of most woodwork items and addresses four areas of concern. The first deals with basic joinery and typical casework details. This information is fundamental to an understanding of the detailing of woodwork. The typical joints illustrated vary in sophistication and structural integrity and represent the most common methods of joining any two wood members. The casework details are intended to illustrate the construction of routine casework and are divided into three categories: exposed face frame, flush overlay, and reveal overlay. The second area deals with custom woodwork and includes details of woodwork items selected directly from contract drawings contributed by various interior design and architectural firms. This information should prove helpful in providing the reader with a more global perspective of how different firms approach the detailing of some common types of woodwork items and the extent of that detailing. The third area of this section deals with standard cornices and mouldings, and is intended to simply provide the designer with dimensional and design information relative to the many standard items available on the market. Since many woodwork items involve some moveable elements, the fourth area of this section deals with furniture hardware.



## STANDARD JOINERY AND CASEWORK DETAILS

Typical Joints

## Characteristics of Joints

Joints may be divided into four general types: *butted*, *shiplapped*, *tongued-and-grooved*, and *mitered*. Used in their simple basic form, none is satisfactory for cabinet work except the *tongued-and-grooved* type in certain instances. However, when variously combined or when reinforced with gluing and dowels or splines, satisfactory joints can be developed.

**Butt joint** A simple but weak joint that opens easily and may show end wood when used at angles. Strength and range of use is greatly increased by use of the *mortise and tenon* and *dowels* and even more when a *straight spline* is included. Use of a *glued butterfly spline* with a butt joint produces an extremely strong joint. These variations are widely used to produce large flush surfaces of solid wood or backing for veneers.

**Shiplap joint** Stronger than a butt joint but subject to opening from shrinkage. Rarely used in a simple form in cabinet work except for door rebates. It is often moulded to conceal shrinkage in quirks or combined as a *miter and shoulder* for corners. Another variation is the *shoulder joint*.

**Tongue-and-groove joint** A strong joint, widely used for re-entrant angles. Effect of

wood shrinkage is concealed when the joint is beaded or otherwise moulded. In expensive cabinet work *glued dovetail* and *multiple tongue-and-groove* are used.

**Miter joints** are weak and difficult to fit if used alone. Joints with *miter brads* are sufficiently strong for short lengths. Joints made in combination with other forms, as a *tongue-and-groove miter*, are tight and sturdy.

## Use of Joints

Use of certain types of joints depends to a large degree upon the type of work and skill involved. The following notes indicate use of joints in various categories, but cannot be regarded as an inclusive check list.

**For panels, shelving, etc.,** or wherever the end of one piece butts against the face of another; *housed joint*, with or without cover mould, or some type of *tongue-and-groove joint*. Omit glue to avoid splitting due to swelling or shrinkage.

**For joining stiles and rails:** *mortise and tenon*, glued in better work. Dowels may be used or hardwood wedges may be driven and glued into ends of tenons in high grade work.

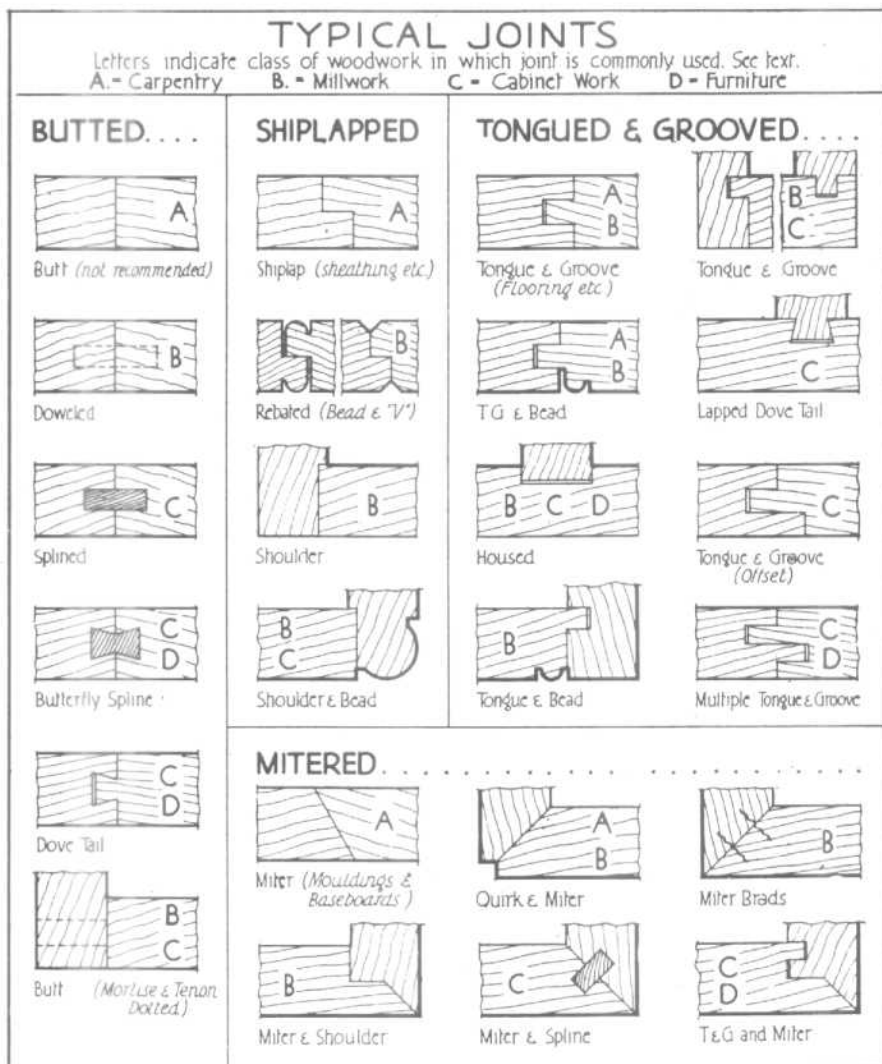
**For re-entrant corners:** *shoulder joints* for

inexpensive work. *Tongue-and-groove* is sturdier. Both should be glued, are often screwed together, and may be glued to a rough frame.

**For external corners:** simple *miter* and *quirk and miter* both lack strength. *Miter brads* are practical only for short lengths. *Miter and shoulder* glued and face-screwed or nailed is satisfactory (generally "millwork"). *Miter and spline* is preferable. In high grade work exterior corners are reinforced by gluing to a corner post or short lengths of blocking.

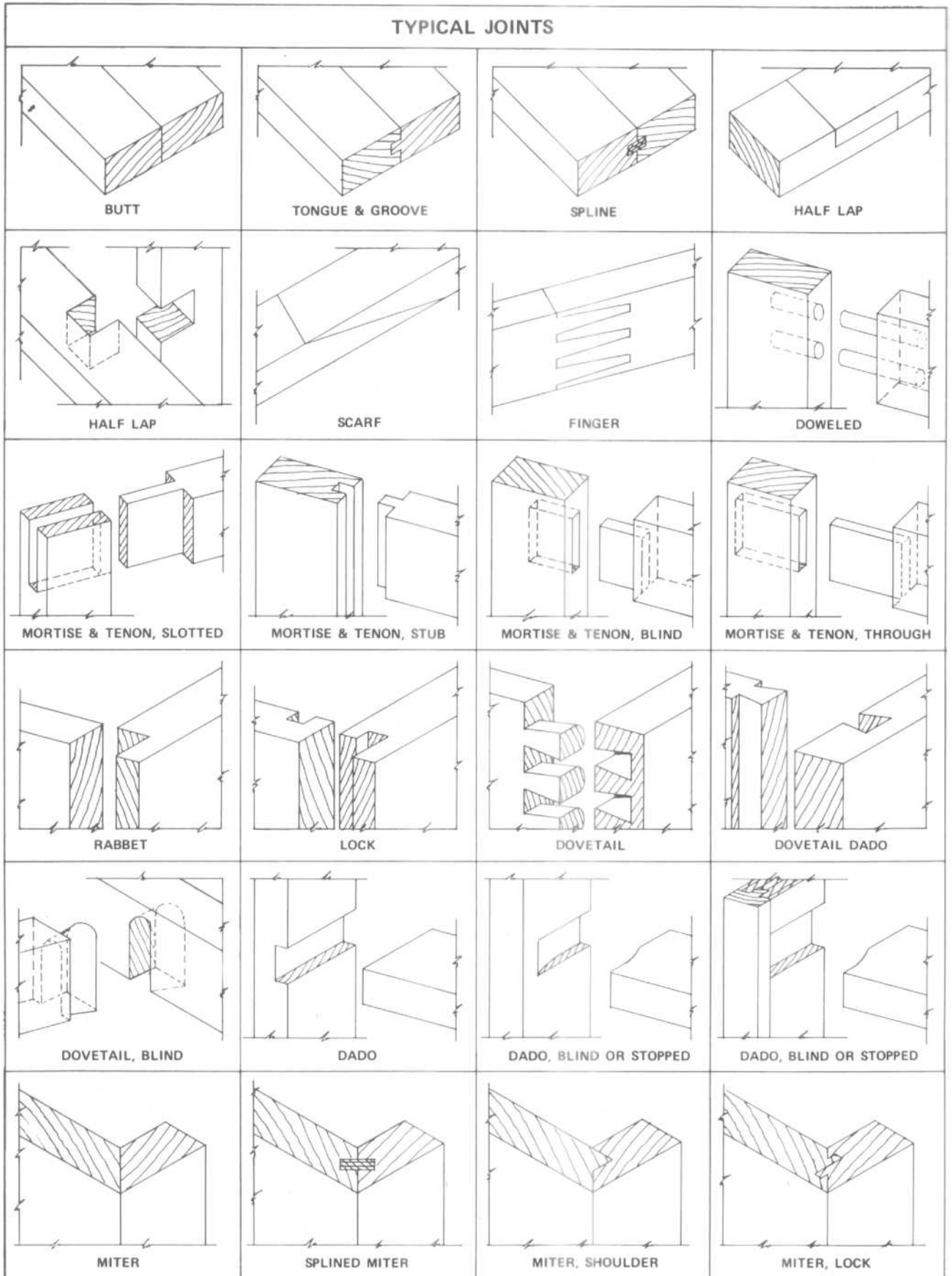
**Glued joints:** when screws, nails, etc., cannot be used, or when fine work is to be veneered, strength of the joint depends on accuracy of milling and total glue surface. Glue surface may be tremendously increased by using multiple or offset tongues and grooves, by forming miter cuts into waves, multiple shoulders, tongues and grooves, etc. Such work is cabinet work. If done by a reliable cabinet maker, a guarantee should be obtained and joint detail and composition of glue left to him or her.

**Mouldings** should be applied in continuous lengths if possible. Use simple miter for necessary joints, cope re-entrant angles unless excessively undercut, miter external corners.



STANDARD JOINERY AND CASEWORK DETAILS

Typical Joints



STANDARD JOINERY AND CASEWORK DETAILS

Typical Joints

**Terminology**

**Spline joint** Used for gluing plywood in width or length. Since the spline serves to align faces, this joint is also used for items requiring site assembly.

**Stub tenon** Joinery method for assembling stile and rail type frames that are additionally supported, such as web or skeleton case frames.

**Conventional mortise and tenon joint** Joinery method for assembling square-edged surfaces such as case face frames.

**Dowel joint** Alternative joinery method for serving same function as conventional mortise and tenon.

**Haunch mortise and tenon joint** Joinery method for assembling paneled doors or stile and rail type paneling.

**French dovetail joint** Method for joining drawer sides to fronts when fronts conceal metal extension slides or overlay the case faces.

**Conventional dovetail joint** Traditional method for joining drawer sides to fronts or backs. Usually limited to flush or lipped type drawers.

**Drawer lock-joint** Another joinery method for joining drawer sides to fronts. Usually used for flush type installation but can be adapted to lip or overlay type drawers.

**Edge banding** Method of concealing plys or inner cores of plywood or particleboard when edges are exposed. Thickness or configuration will vary with manufacturers' practices.

**Through dado** Conventional joint used for assembly of case body members – dado usually concealed by application of case face frame.

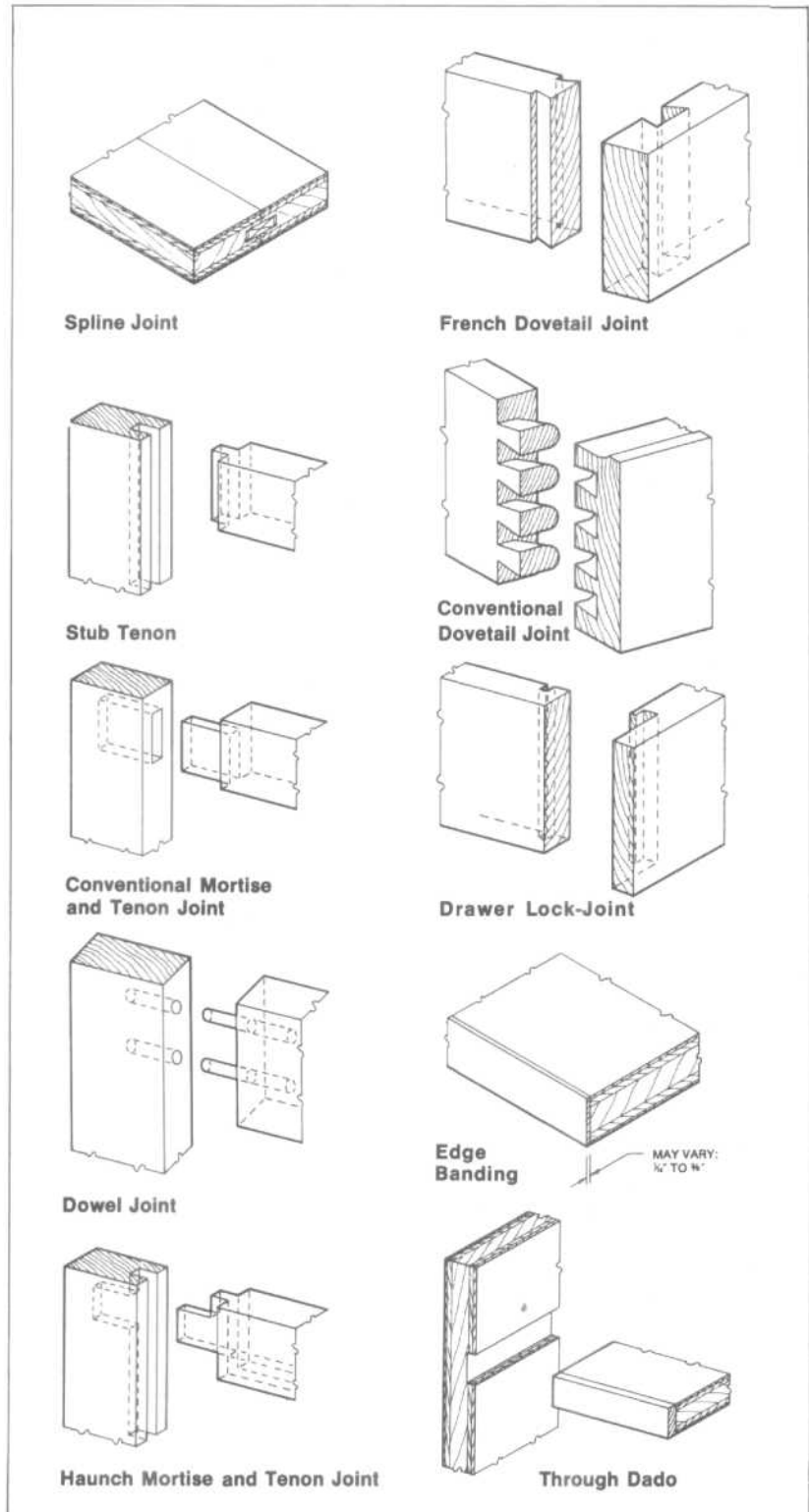
**Blind dado** Variation of conventional dado with applied edge "stopping" or concealing dado groove. Used when case body edge is exposed.

**Stop dado** Another method of concealing dado exposure. Applicable when veneer edging or solid lumber is used.

**Exposed end detail** Illustrates attachment of finished end of case body to front frame using butt joint.

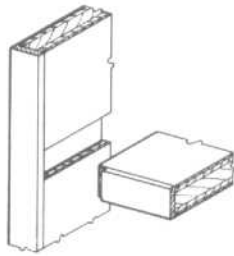
**Exposed end detail** Illustrates attachment of finished end of case body to front frame using mitered joint.

**Paneled door details** Joinery techniques when paneled effect is desired. Profiles are optional as is the use of flat or raised panels. Solid lumber raised panels may be used when width does not exceed 10 in. Rim raised panels recommended when widths exceed this dimension or when transparent finish is used.

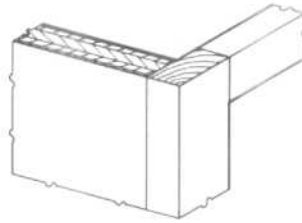


STANDARD JOINERY AND CASEWORK DETAILS

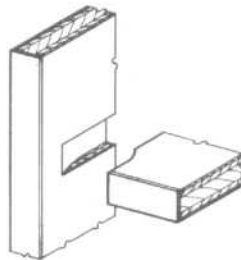
Typical Joints



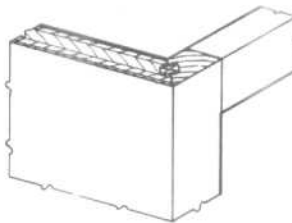
Blind Dado



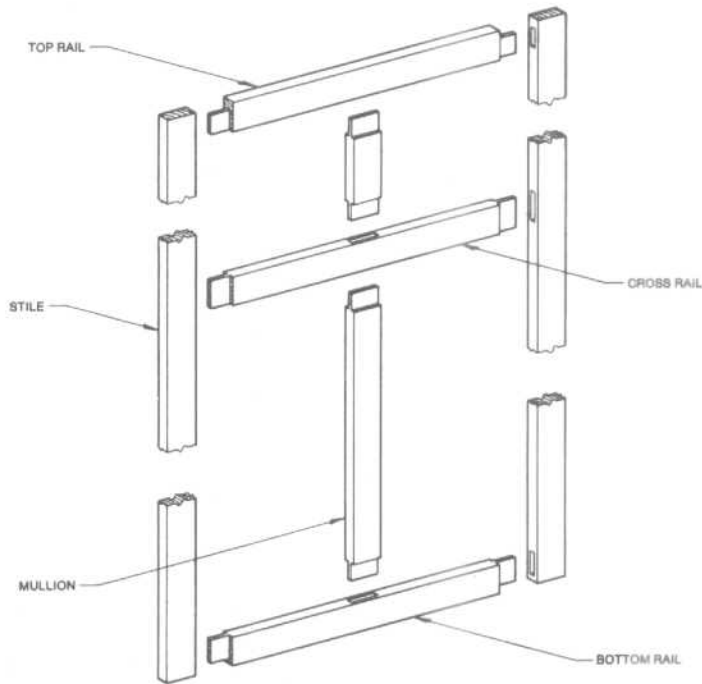
Exposed End Detail



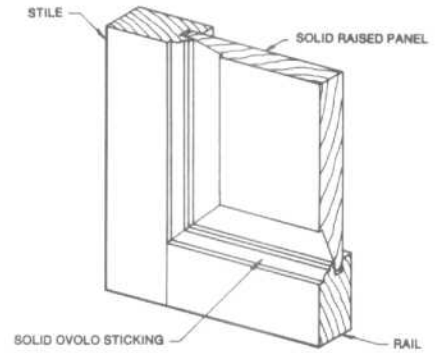
Stop Dado



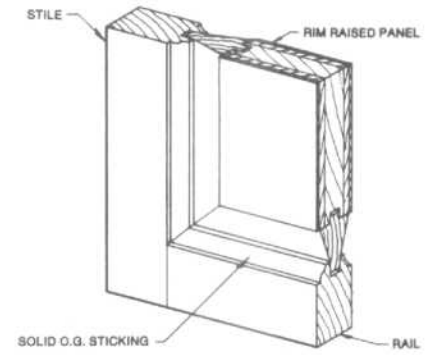
Exposed End Detail



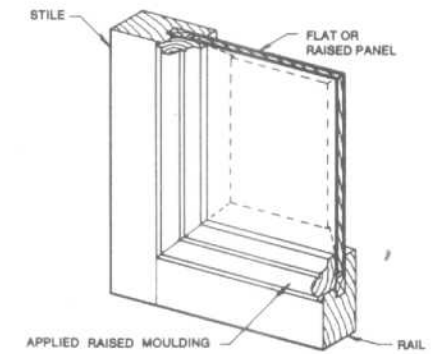
Typical Frame Parts



Paneled Door Detail



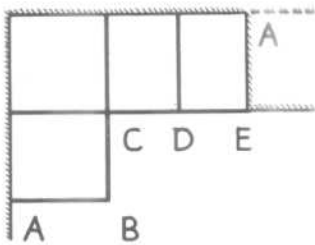
Paneled Door Detail



Paneled Door Detail

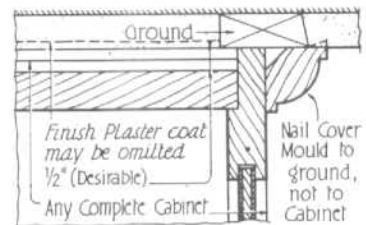
STANDARD JOINERY AND CASEWORK DETAILS

Cabinet Work

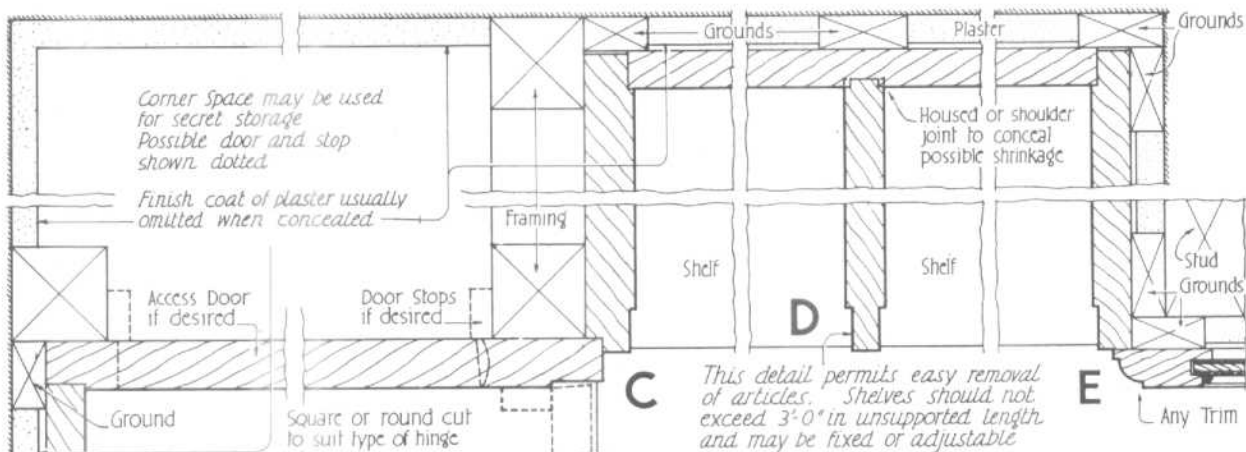


DIAGRAMMATIC PLAN  
(No Scale)

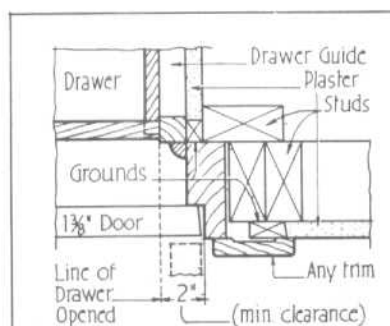
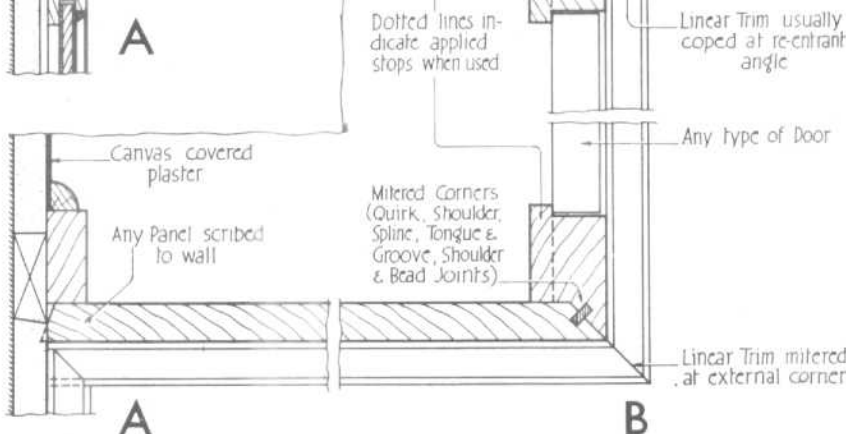
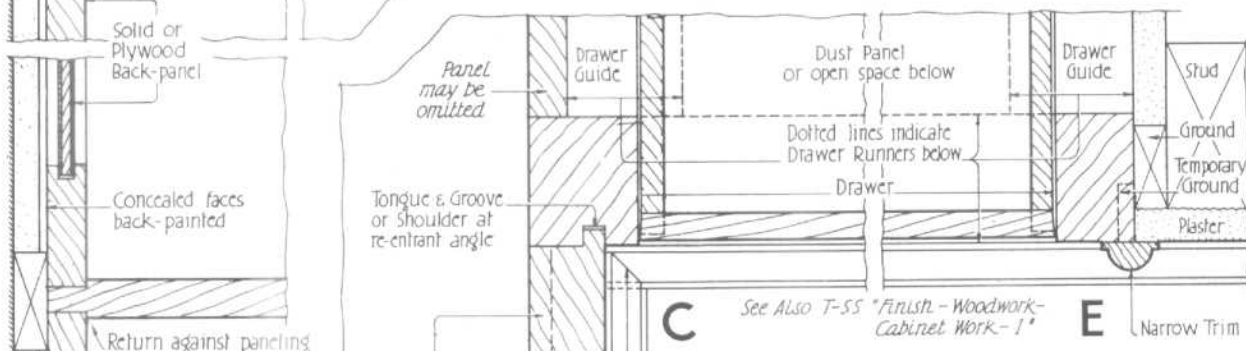
TYPICAL  
CABINET CONSTRUCTION



Grounds are carefully located before erecting  
**A**  
GROUNDS & COVER MOULD



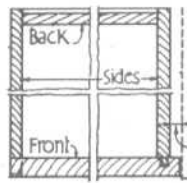
This detail permits easy removal of articles. Shelves should not exceed 3'-0" in unsupported length and may be fixed or adjustable



**DRAWER CLEARANCE FOR CLOSET CABINET**

STANDARD JOINERY AND CASEWORK DETAILS

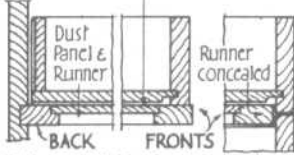
Cabinet Work



SECTIONAL PLAN

When any type of patented drawer slide is used, consult man's catalogue for this dimension. The lapped front conceals slide

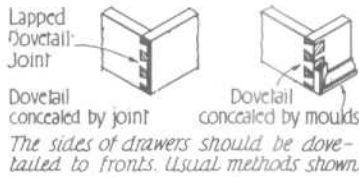
Dust-Panels & top face of drawer Runners should be flush



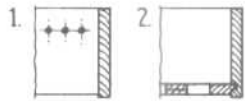
Bottom rabbeted to front and sides; secured to front only.

Runners & Guides preferably hardwood; Panels either veneer or solid

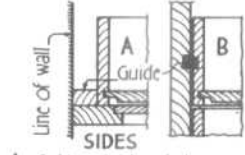
DRAWERS



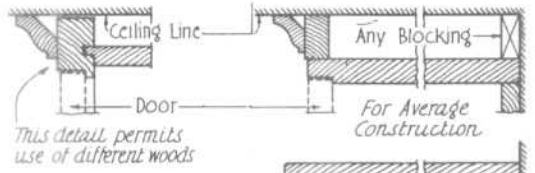
Lapped Dovetail Joint  
Dovetail concealed by joint  
Dovetail concealed by moulds  
The sides of drawers should be dovetailed to fronts. Usual methods shown



1. Bottomless - For towels, etc
2. Flush Lattice Bottom - Permits air circulation for linens, etc.

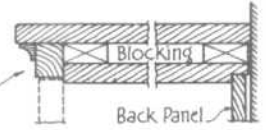


- A Guide at side of drawer, fastened to Drawer Runner  
B Guide (Hardwood) rabbeted into side of Drawer.

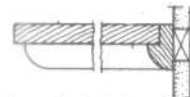


This detail permits use of different woods

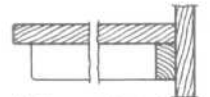
Detail where Cabinet does not extend to Ceiling



CORNICE

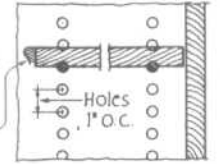


Shelf on cleats fastened to grounds in plaster wall

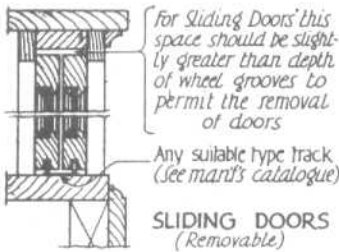


Shelf on nailing strips

When any type of patented Shelf-Adjusters are used, consult man's catalogue for recommended dimensions. Shelf edge may be Hardwood. Adjustable Shelf on Wood Pegs



SHELVES



For Sliding Doors this space should be slightly greater than depth of wheel grooves to permit the removal of doors

Any suitable type track (See man's catalogue)

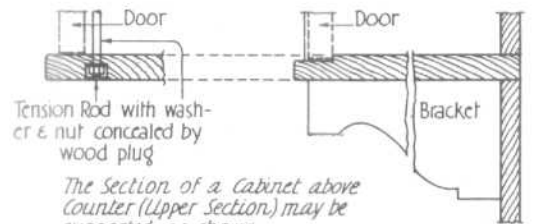
SLIDING DOORS (Removable)



Flush Front Panel Doors



DOOR WITH MIRROR



Tension Rod with washer & nut concealed by wood plug

The Section of a Cabinet above Counter (Upper Section) may be supported as shown.

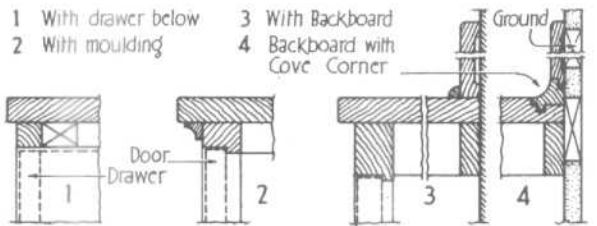
SUPPORTS



DETAILS FOR GLAZED DOORS

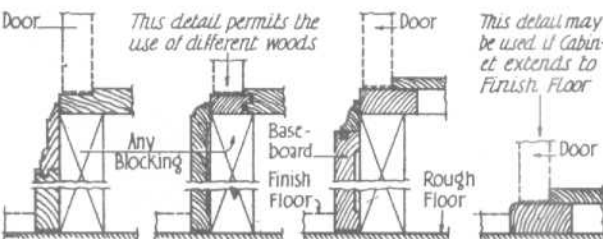


DETAILS FOR PANELED DOORS (Panels may be either plain or ply-wood)

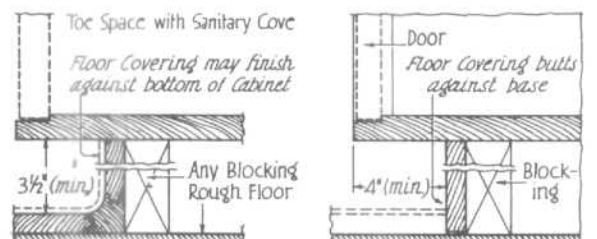


COUNTERS

DOORS



BASES



TOE SPACE



**Purpose**

The following information outlines methods of assembly and installation of common cabinet work. Solutions of typical problems are presented without attempting to detail specific cabinets.

**Assembly**

High-grade cabinet and veneered work is assembled as far as possible at the shop. Joints are glued and blocked, and sometimes secured with finishing nails or screws. Carpentry and millwork are generally put together with finishing nails if of soft wood, or with screws if of hardwood. Hardwood should be drilled to prevent splitting before using nails or screws, and heads should be countersunk and concealed by cover moulds, moulding quirks, or putty, plastic wood, or other filler, colored to match the finish. No nails, screws, or joints should be visible unless they are intentionally incorporated in design.

**Shrinkage and warping** effects can be largely eliminated by proper detailing and construction. *Wide flat surfaces* (solid or veneered) should be made up of several narrow strips glued and doweled, splined, or dovetailed together. Cleats may also be screwed or keyed to backs of wide surfaces. *Joints in corners, sheathing, etc.*, should be con-

cealed within quirks of moulds (as in moulded tongue-and-groove) or return faces (shoulder joints). *Panels* should be rigidly secured on one side only, and are often left entirely loose. Housed joints, not glued, permit panels to expand and contract without splitting.

**Large moulded surfaces** (such as cornices or mantels) should always be shop-assembled and delivered with scribe-moulds (see "Scribing" below) loosely tacked to assembled units.

**Installation**

All grades of woodwork should be preservative treated or back painted before erection, preferably before delivery to the job. Satisfactory priming coats are aluminum paint or white lead in linseed oil, thinned with turpentine or mineral spirits.

**Preparation** On frame walls plaster may be limited to one or two coats, may be recessed between studs, or may be omitted. In the latter case, building paper should be used between woodwork and studs. On masonry, plaster may consist of one or two coats or may be omitted. Masonry surfaces, particularly exterior walls, should be waterproofed or woodwork should be protected by a layer of waterproof paper and should always be furred out. When finish of the interior of

cabinets is plaster, either plain or canvas covered, the final coat of plaster is applied after erection of cabinet.

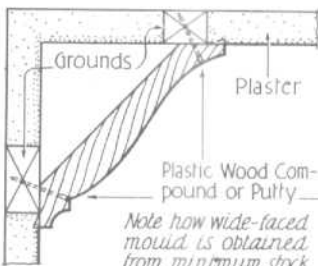
**Grounds** of soft wood for attaching cabinet work must be accurately located, are secured directly to framing members or furring, and must be concealed.

**Blocking** of rough lumber should be erected for supporting raised floors and large or heavy cabinet work, if it can be concealed. Blocking must be accurately placed and secured with nails.

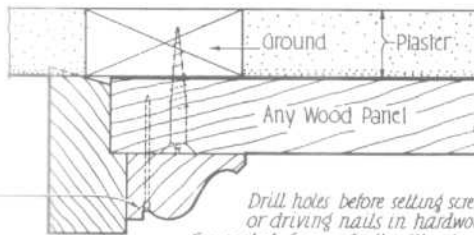
**Shimming** Minor irregularities in blocking, furring, or placement of studs may be corrected by using shims (wedge-shaped pieces of wood, often shingles) to bring completed work to plumb and level lines. Shimming should be concealed.

**Scribing** is the practice of fitting edges of cabinet work accurately to all irregularities of finish plaster, masonry, or other abutting surfaces. Wood mouldings, panel frames, or cabinet returns to be scribed should be provided with a beveled edge.

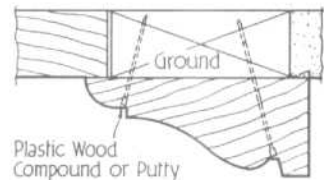
**Prefabricated woodwork** is generally delivered knocked down for assembly on the job and is erected similarly to custom-made work. Consult manufacturers' data.



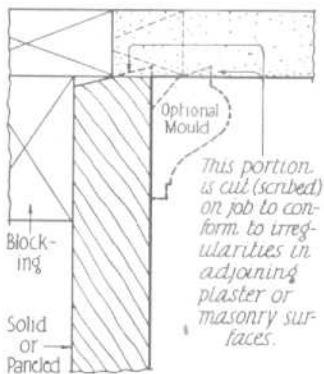
**NAILING TO GROUNDS**



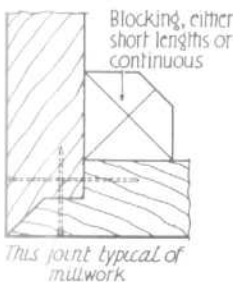
**CONCEALING ATTACHMENT OF HARDWOODS**



**NAILING IN QUIRKS**



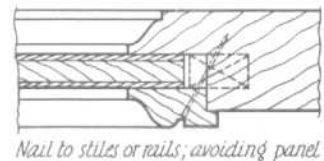
**SCRIBING AGAINST PLASTER OR MASONRY**



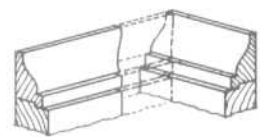
**GLUING AND BLOCKING**



**SECURING MORTISE & TENON**



**NAILING PANEL MOULD**



**COPING MOULDINGS RE-ENTRANT ANGLE**

STANDARD JOINERY AND CASEWORK DETAILS

Plastic-Covered Casework

Casework Definitions

- A. Exposed portions
  - 1. All surfaces visible when doors and drawers are closed.
  - 2. Underside of bottoms of cabinets over 4'0" above finished floor.
  - 3. Cabinet tops under 6'0" above finished floor or if over 6'0" and visible from an upper building level or floor.
  - 4. Visible front edges of web frames, ends, divisions, tops, shelves, and hanging stiles.
  - 5. Sloping tops of cabinets that are visible.
  - 6. Visible surfaces in open cabinets or behind glass for premium grade only.
  - 7. Interior faces of hinged doors for premium grade only.
  - 8. Visible portions of bottoms, tops, and ends in front of sliding doors in custom and premium grades only.
- B. Semi-exposed portions
  - 1. Shelves.
  - 2. Divisions.
  - 3. Interior face of ends, backs, and bottoms.
  - 4. Drawer sides, subfronts, backs, and bottoms.
  - 5. The underside of bottoms of cabinets between 2'6" and 4'0" above the finished floor.
  - 6. Interior faces of hinged doors, except premium grade.
  - 7. Visible surfaces in open cabinets or behind glass for economy and custom grades and all rooms designated as storage, janitor, closet, or utility.
  - 8. Visible portion of bottoms, tops, and ends in front of sliding doors in economy grade only.
- C. Concealed portions
  - 1. Toe space unless otherwise specified.
  - 2. Sleepers.
  - 3. Web frames, stretchers, and solid subtops.
  - 4. Security panels.
  - 5. Underside of bottoms of cabinets less than 2'6" above the finished floor.
  - 6. Flat tops of cabinets 6'0" or more above the finished floor, except if visible from an upper building level.
  - 7. The three nonvisible edges of adjustable shelves.
  - 8. The underside of countertops, knee spaces, and drawer aprons.
  - 9. The faces of cabinet ends of adjoining units that butt together.

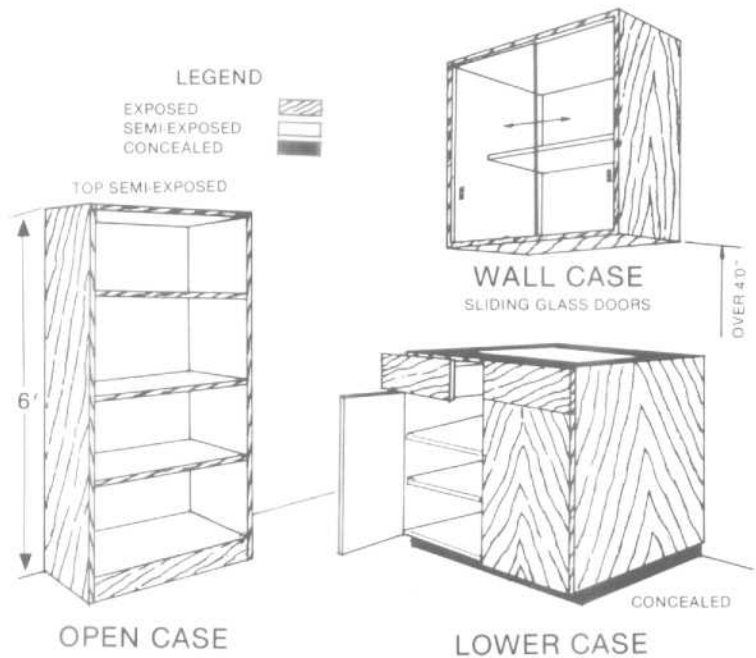


Fig. 1 Inside surfaces of open shelf cabinets and behind glass are considered exposed for premium grade and tops of tall cabinets and upper cabinets 6 ft above the floor that are exposed from upper levels are considered exposed.



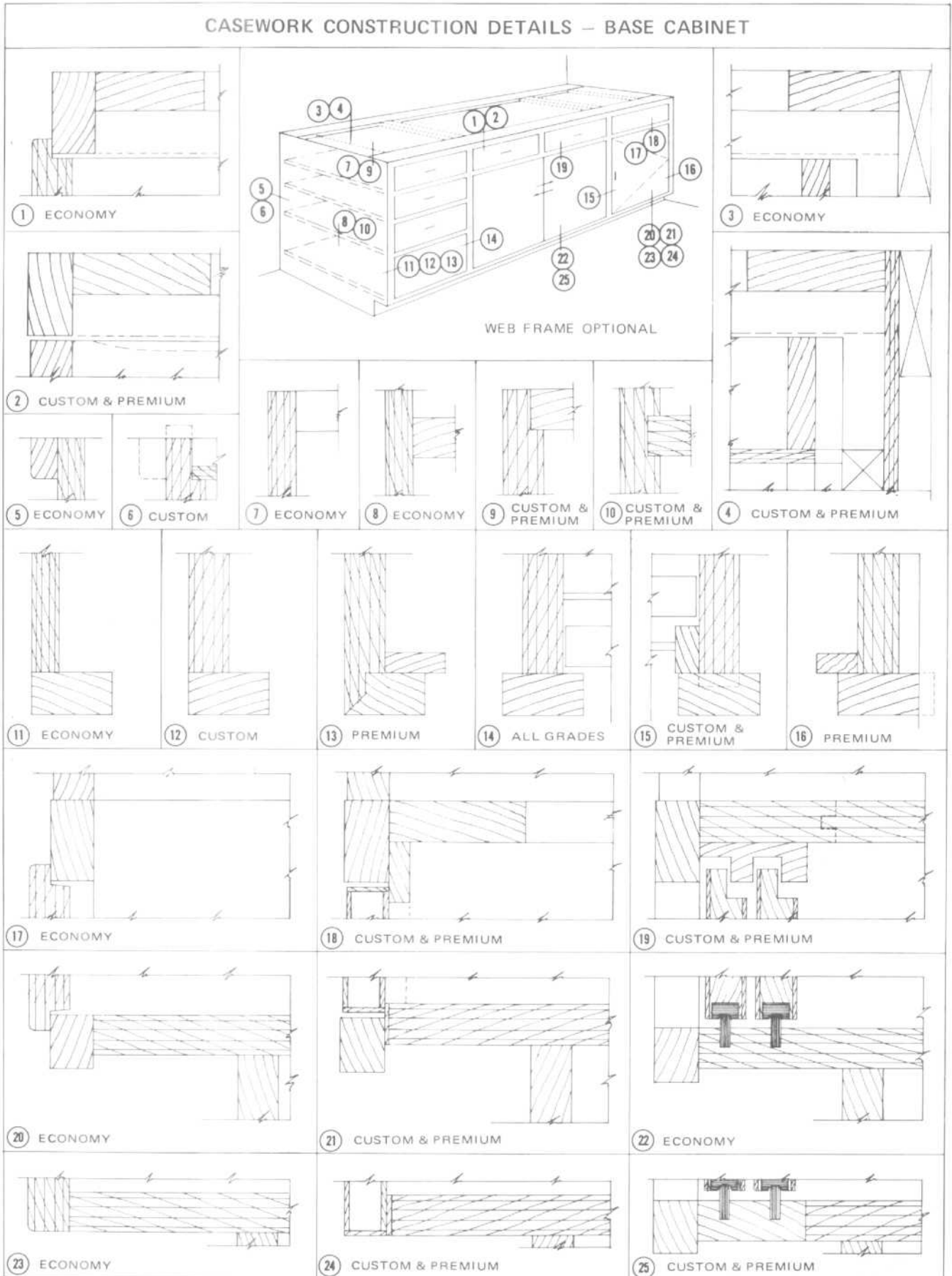


Fig. 2 Casework construction details – base cabinet.

STANDARD JOINERY AND CASEWORK DETAILS

Typical Upper Cabinet Details

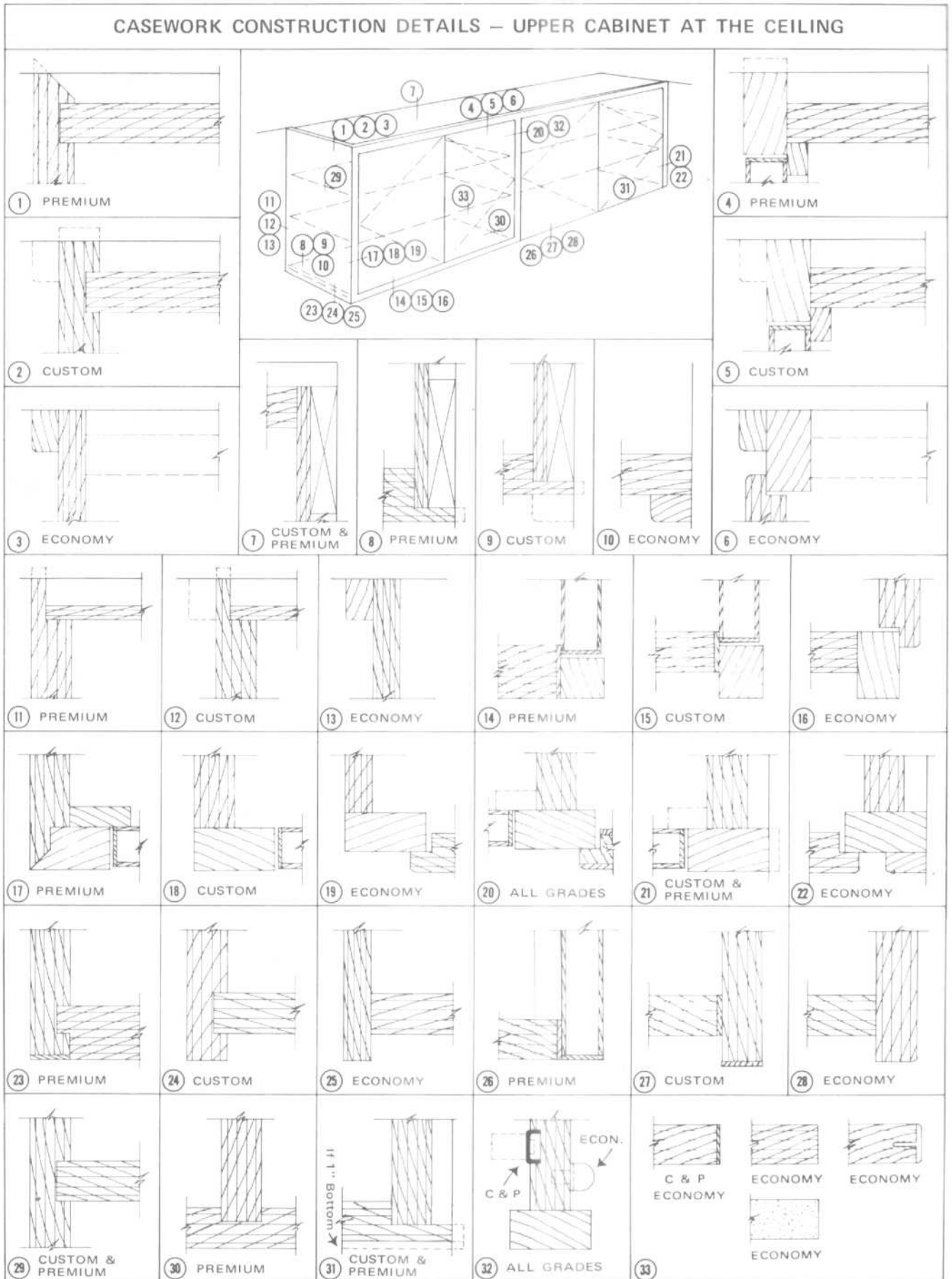


Fig. 3 Casework construction details – upper cabinets at the ceiling.

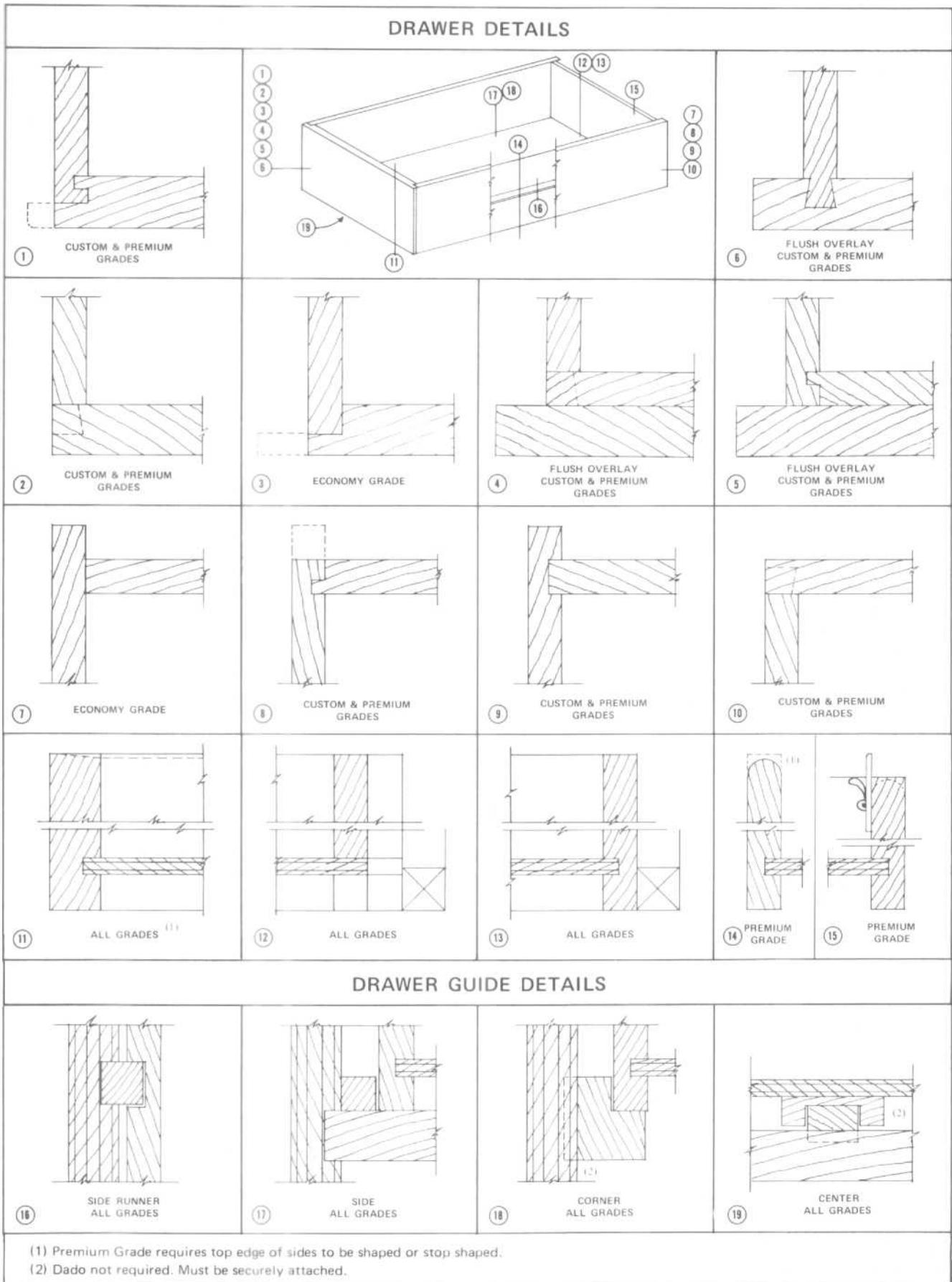
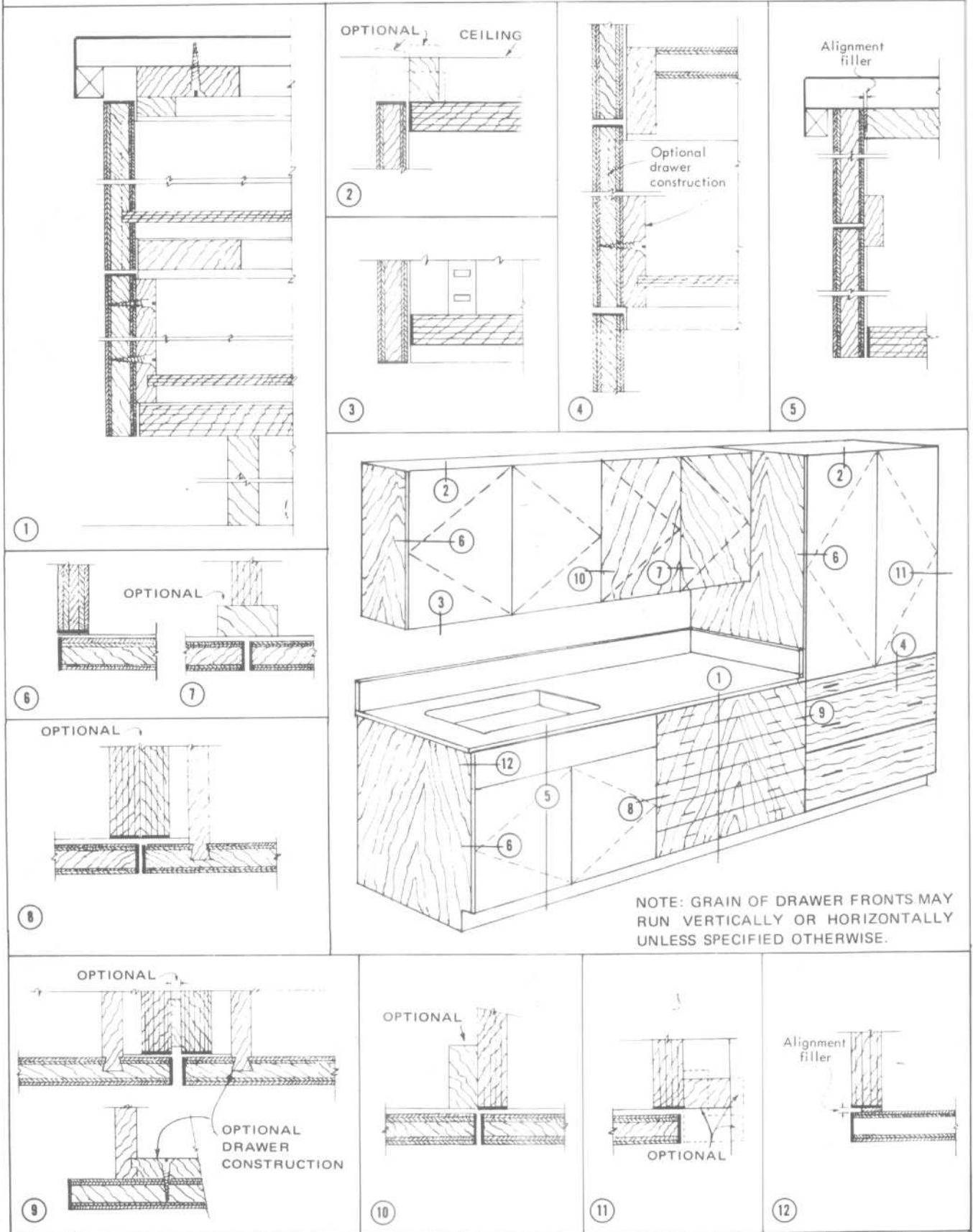


Fig. 4 Drawer details.

STANDARD JOINERY AND CASEWORK DETAILS

Typical Flush Overlay Casework Construction

FLUSH OVERLAY TYPE CASEWORK CONSTRUCTION DETAILS

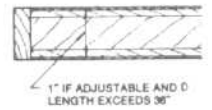
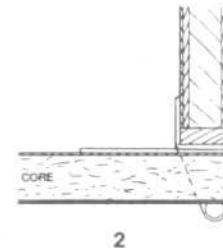
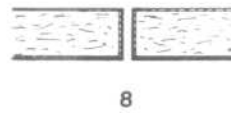
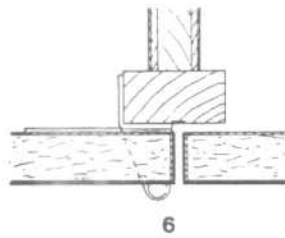
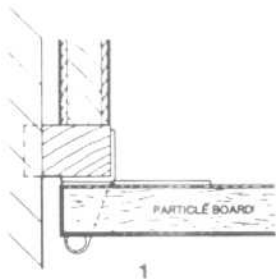
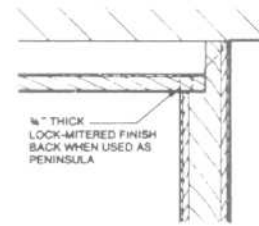
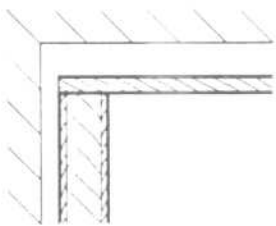
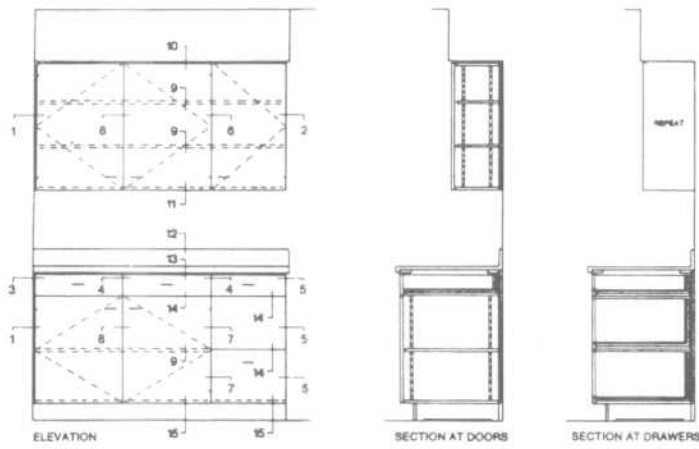


Sections shown are typical; however, variations are permitted as provided in the standard established for each grade.

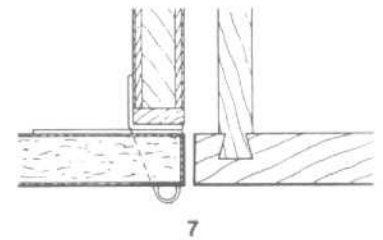
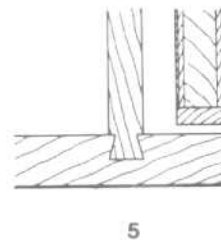
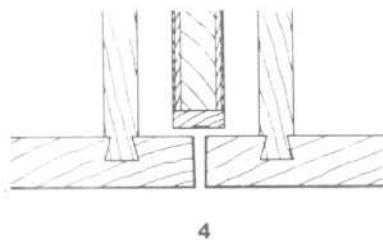
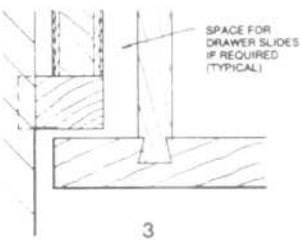
Fig. 5 Flush overlay type casework construction details.

STANDARD JOINERY AND CASEWORK DETAILS

Typical Flush Overlay Casework Construction



9



3

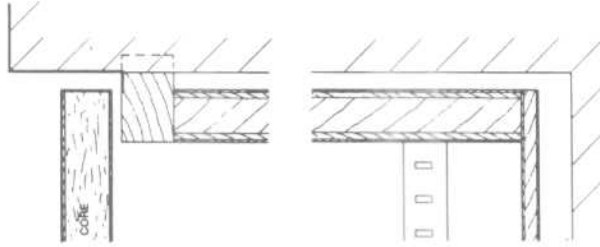
4

5

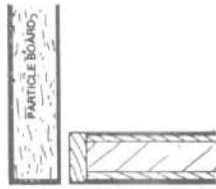
7

STANDARD JOINERY AND CASEWORK DETAILS

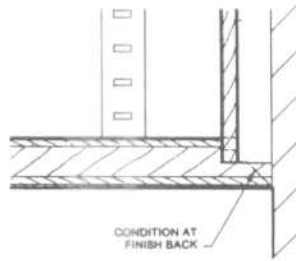
Typical Flush Overlay Casework Construction



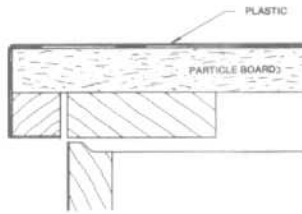
10



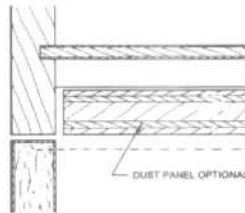
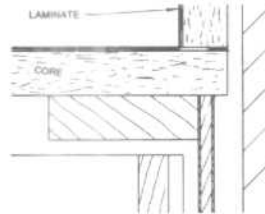
11



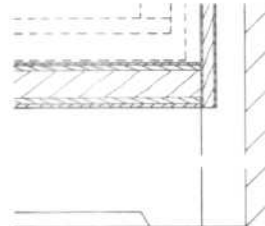
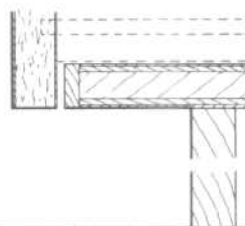
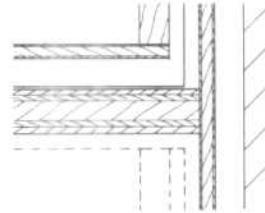
12



13



14



STANDARD JOINERY AND CASEWORK DETAILS

Solid Core Wood Flush Doors

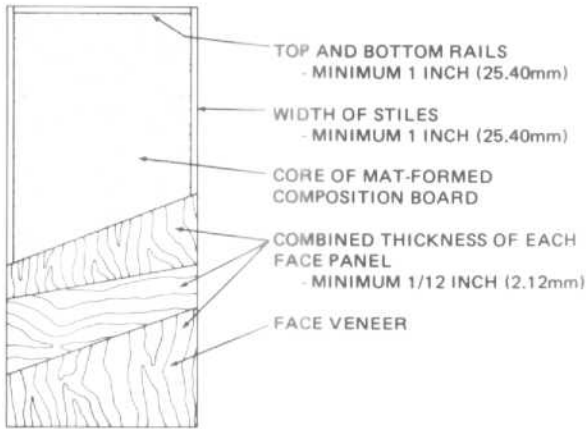


Fig. 6 Mat-formed wood particleboard core (7-ply construction illustrated).

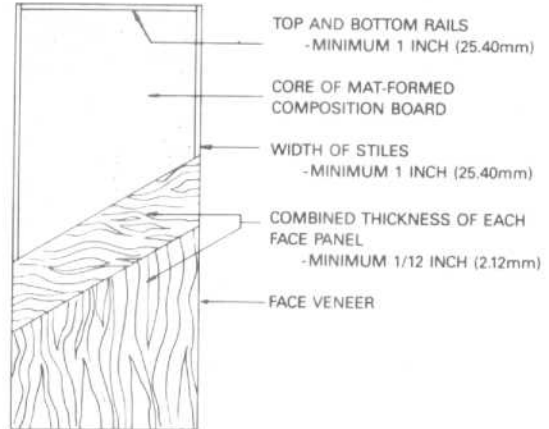


Fig. 7 Mat-formed wood particleboard core (5-ply construction illustrated).

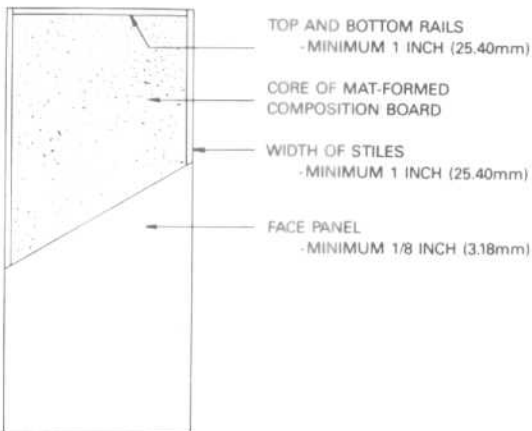


Fig. 8 Mat-formed wood particleboard core (3-ply construction illustrated).

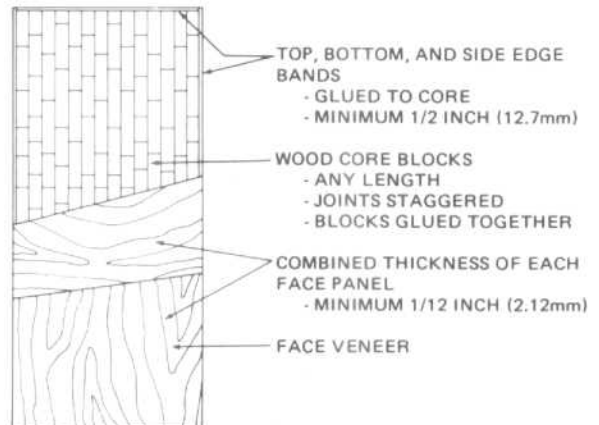


Fig. 9 Glued block core (5-ply construction illustrated).

STANDARD JOINERY AND CASEWORK DETAILS

Solid Core and Hollow Core Wood Flush Doors

SOLID CORE WOOD FLUSH DOORS

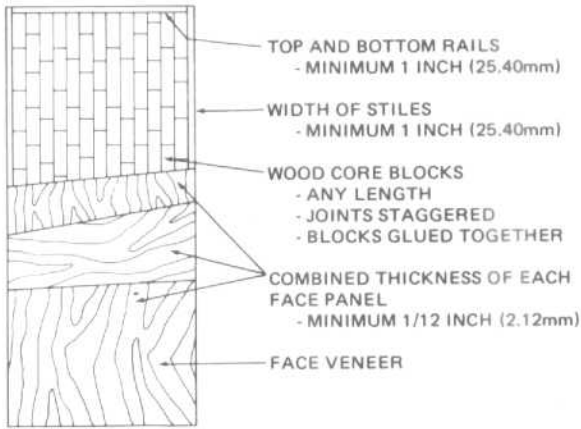


Fig. 10 Framed block glued core (7-ply construction illustrated).

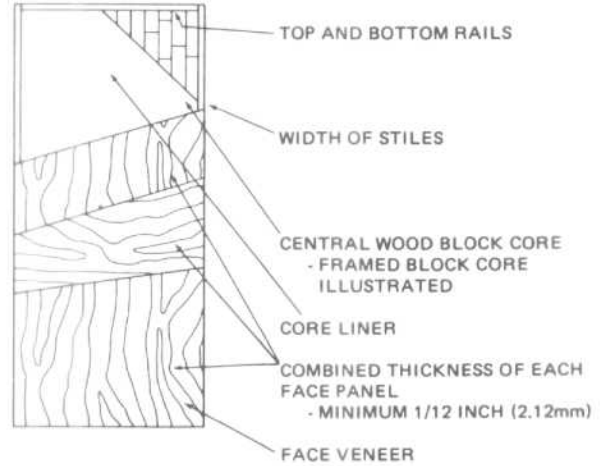


Fig. 11 Wood block lined core (7-ply construction illustrated).

HOLLOW CORE WOOD FLUSH DOORS

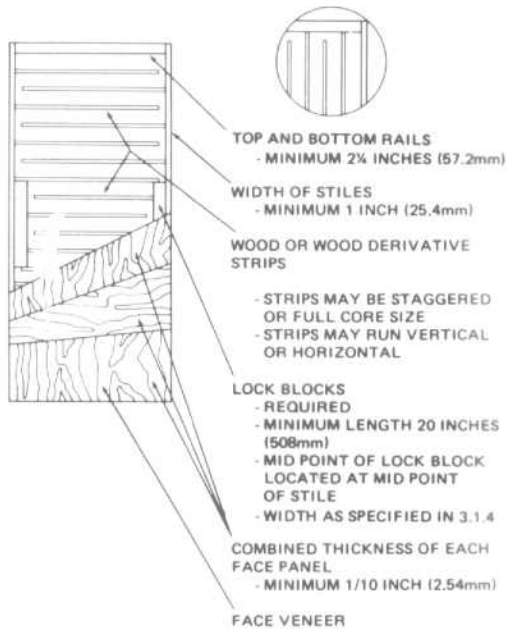


Fig. 12 Ladder core (7-ply construction illustrated).

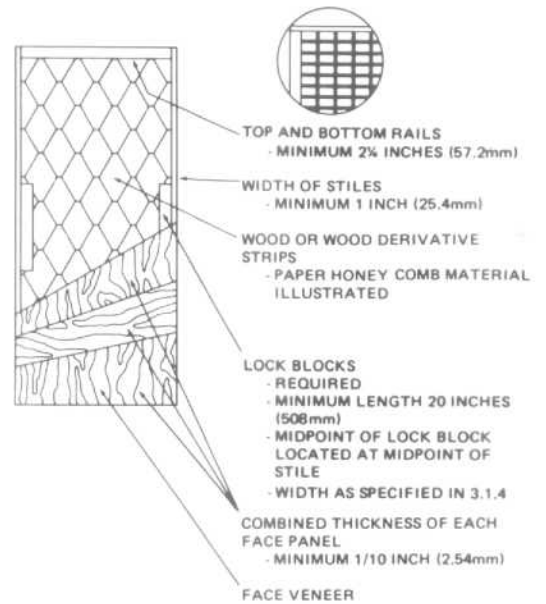


Fig. 13 Mesh or cellular core (7-ply construction illustrated).



STANDARD JOINERY AND CASEWORK DETAILS

Cabinet Door and Banding Types

a. **FLUSH CABINET DOORS. All WIC Grades.**

**TYPE "1"**

Veneer/tape banding, 1/16" maximum.

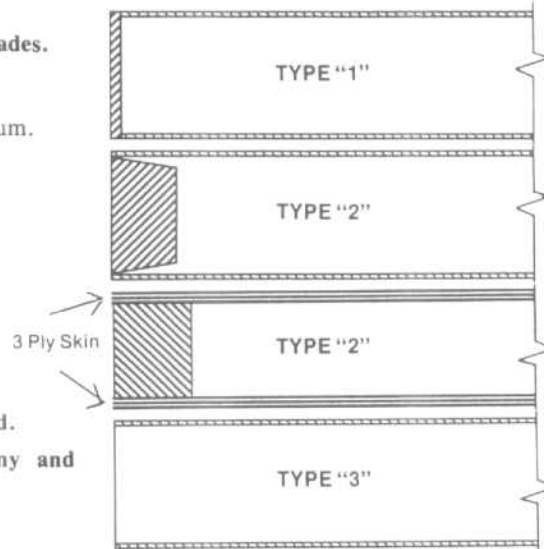
**TYPE "2"**

Solid banding.

**TYPE "3" — Medium Density Fiberboard.**

Banding not required for **Economy and Custom Grades.**

**Band required for Premium Grade.**



b. **LIPPED CABINET DOORS.**

**TYPE "4"**

Veneer/tape banding, 1/16" maximum, required.

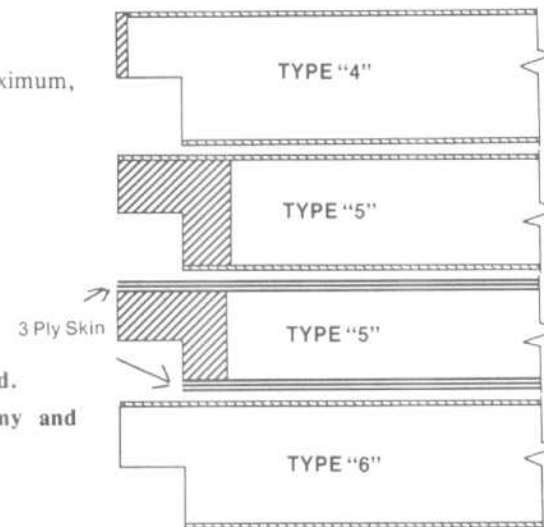
**TYPE "5"**

Solid banding.

**TYPE "6" — Medium Density Fiberboard.**

Banding not required for **Economy and Custom Grades.**

**Band required for Premium Grade.**



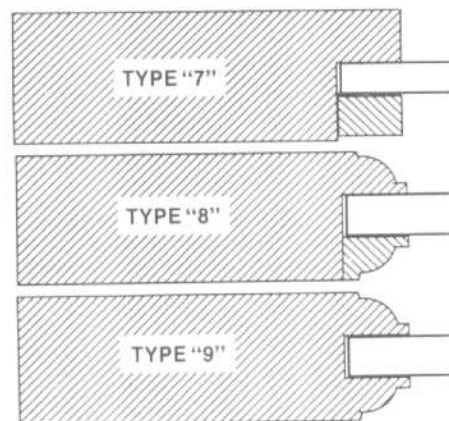
c. **STILE AND RAIL CABINET DOORS. All WIC Grades.**

**TYPE "7", S4S Stop.**

**TYPE "8", Solid Stuck.**

**TYPE "9", Moulded Stop.**

d. The top and bottom edges of sliding doors do not require an edge band.



STANDARD JOINERY AND CASEWORK DETAILS

Stile and Rail Joinery Details

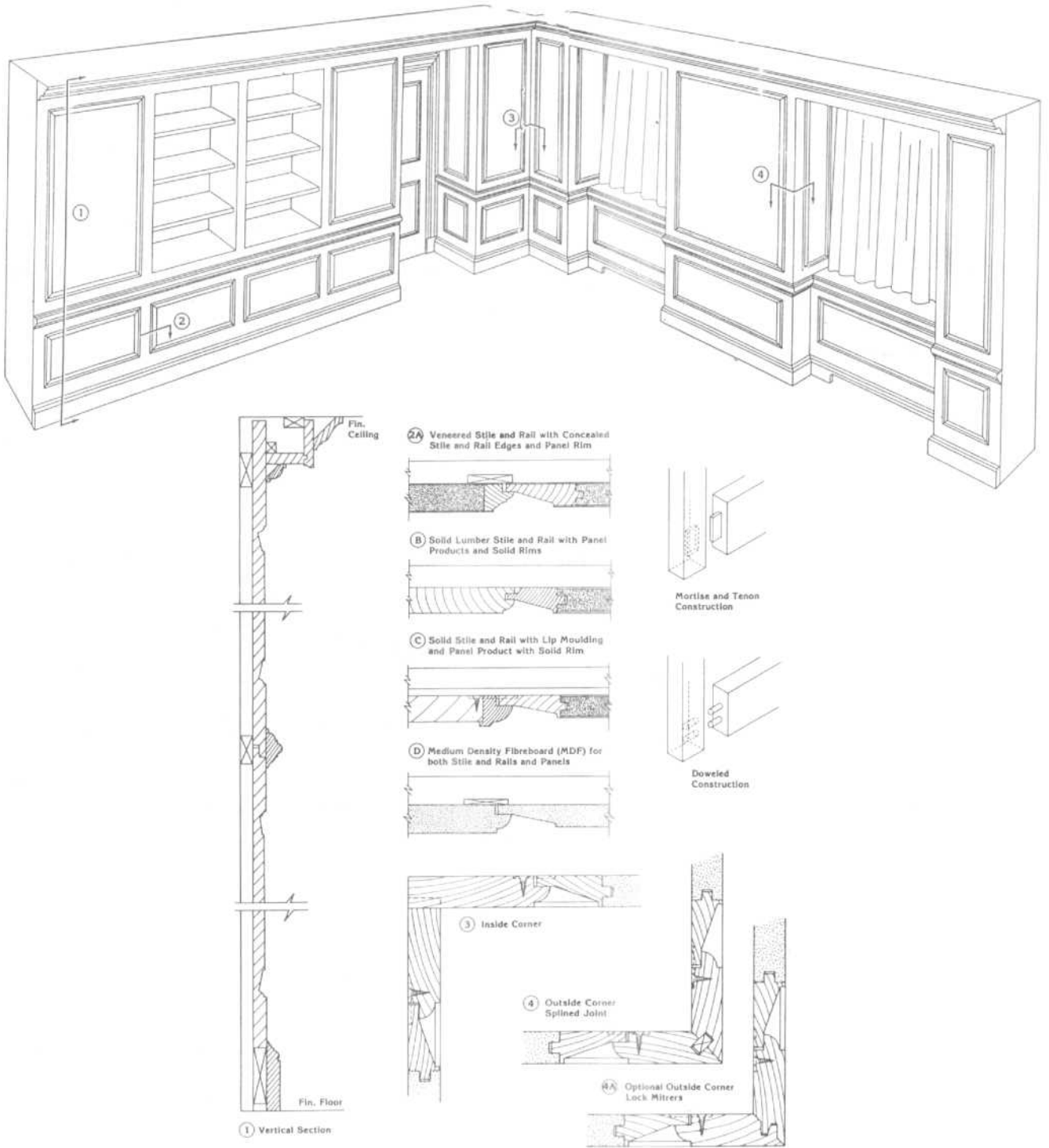


Fig. 14 Full-height stile and rail raised paneling. Stile and rail wall paneling accented by raised panels creates a beautiful effect of traditional architectural woodwork. Framed within the stiles and rails and accented by the shadow lines, this construction offers limitless opportunities for various effects through the use of different wood species and veneer cuts. Each design creates a unique atmosphere complimented by the finely proportioned paneling.

STANDARD JOINERY AND CASEWORK DETAILS

Paneled Wainscot and Doors

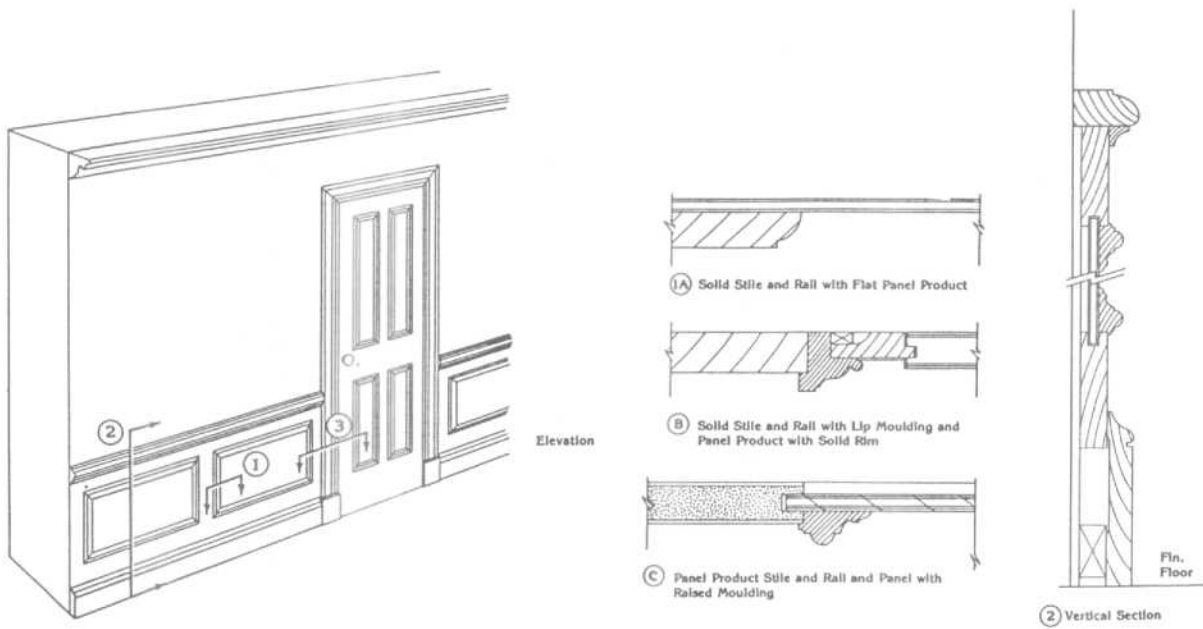


Fig. 15 Flap paneled wainscot. Flat panels set within the frame of the stile and rail create a rich effect of traditional architectural woodwork. Different results can be produced through the use of veneer selections with transparent finish or painted finishes chosen by the architect or designer.

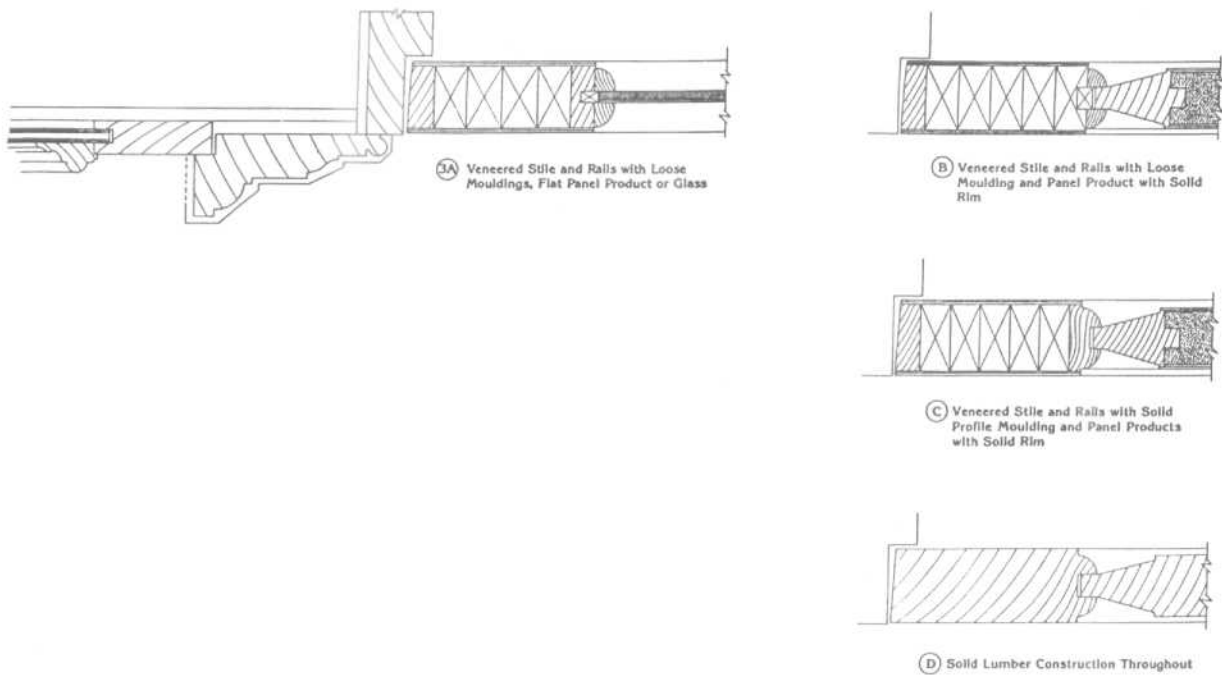


Fig. 16 Paneled doors. Stile and rail doors designed to accent the adjacent wall paneling whether traditional or contemporary, or used alone, beautify an entryway or area.

STANDARD JOINERY AND CASEWORK DETAILS

Raised Paneling

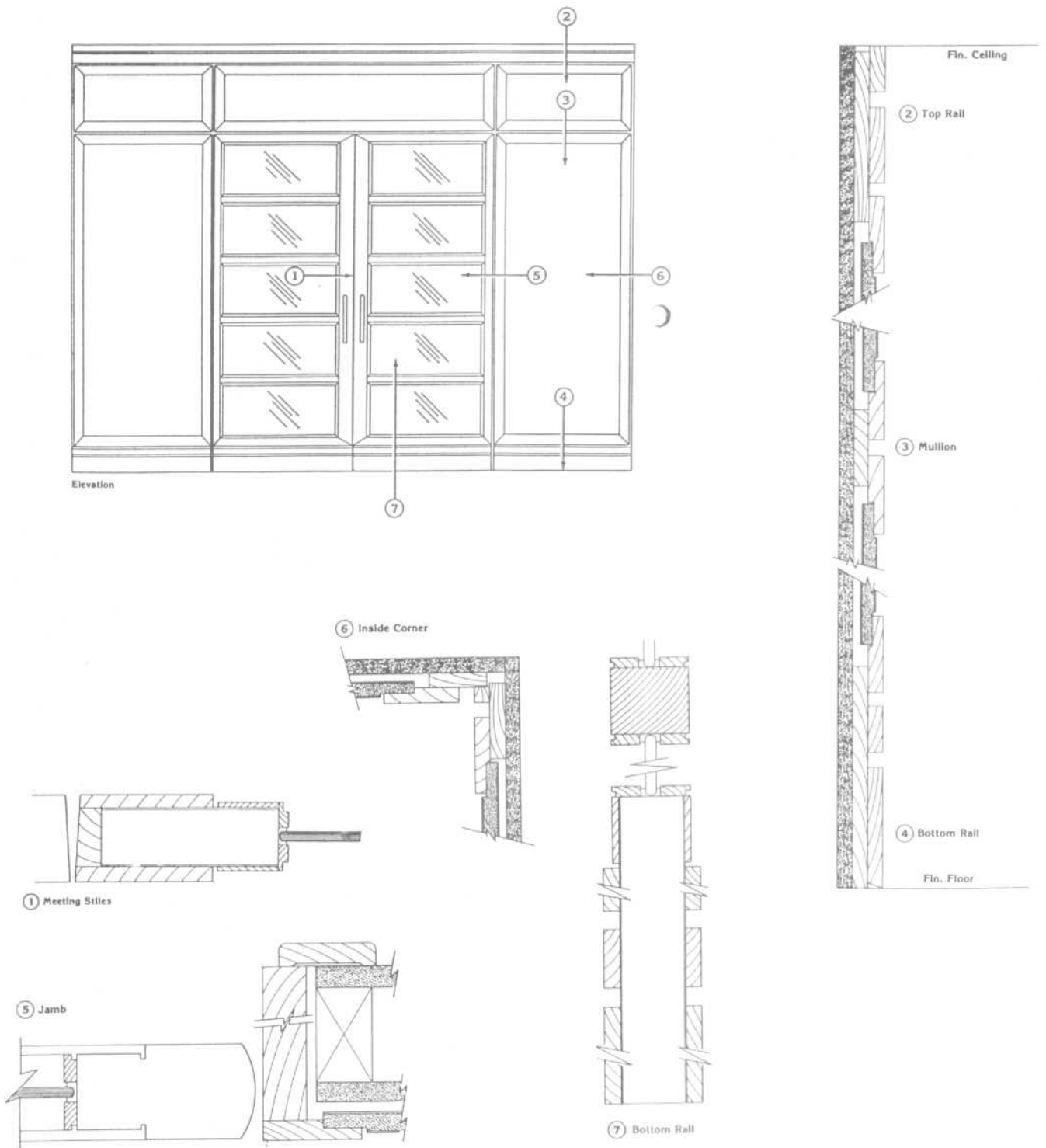
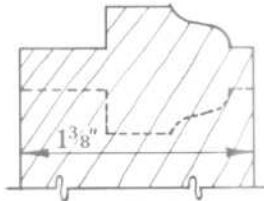
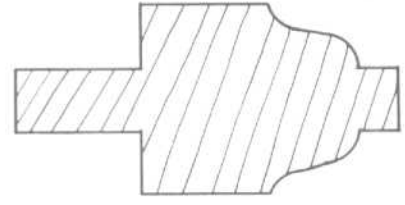
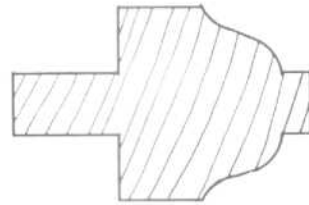
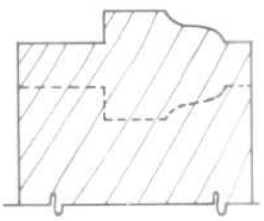
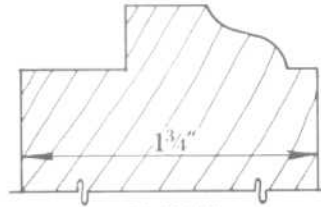


Fig. 17 Full-height contemporary raised paneling. This design, distinguished by its simplicity, is a contemporary expression of the stile and rail construction.

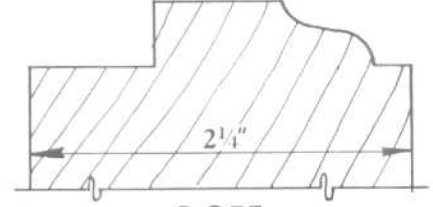
### PROFILES OF STOCK STICKING FOR SASH & DOORS



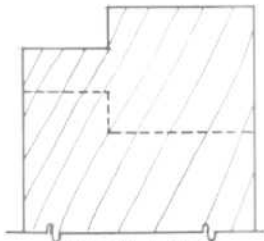
OGEE



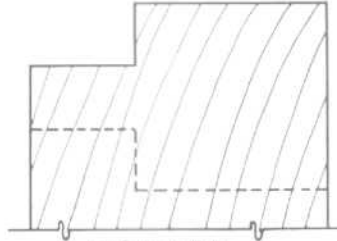
OGEE



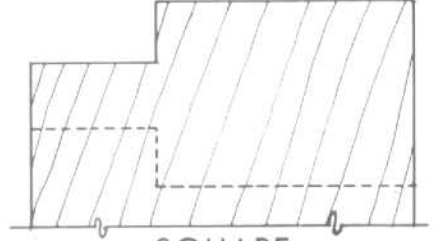
OGEE



SQUARE

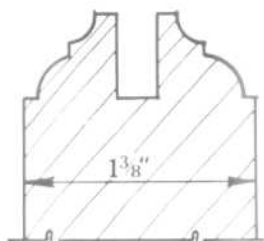


SQUARE

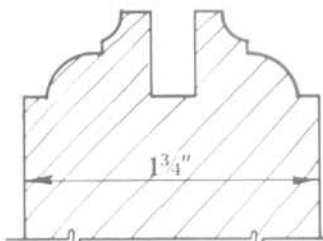


SQUARE

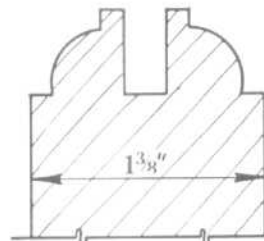
### SASH & FRENCH DOORS



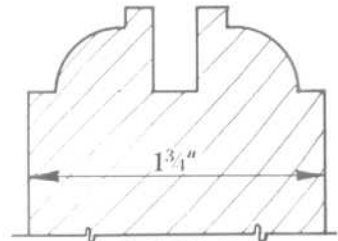
B & C



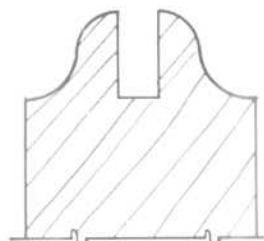
B & C



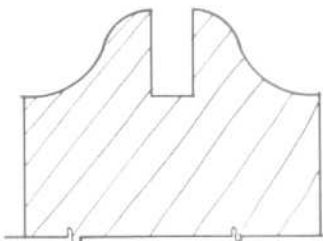
OVOLO



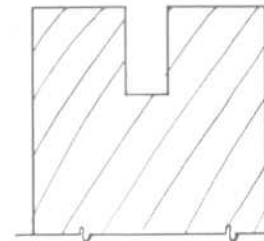
OVOLO



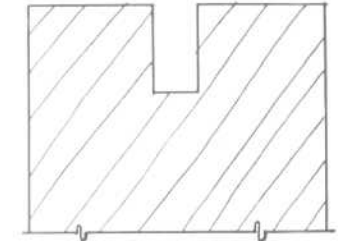
OGEE



OGEE



SQUARE



SQUARE

### PANEL DOORS

STANDARD JOINERY AND CASEWORK DETAILS

Double Hung Windows

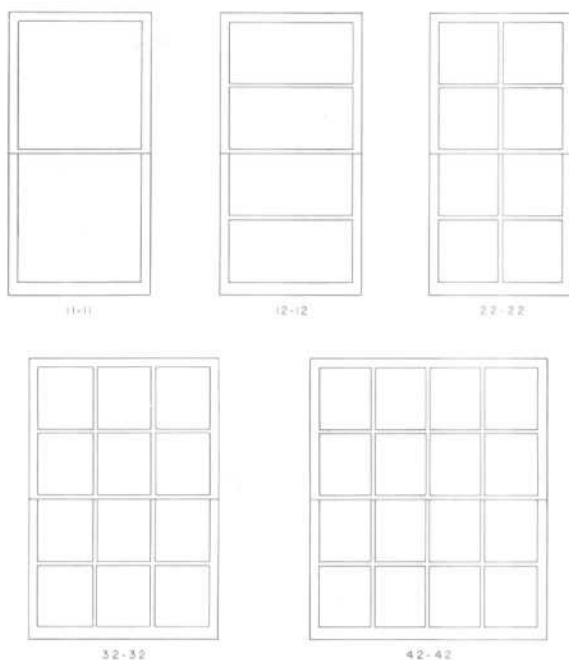


Fig. 18 Double hung windows: stock designs. Standard widths are 1'6", 2'0", 2'6", 3'0", 3'6", 4'0", 4'6", and 5'0". Standard heights are 2'0", 2'6", 3'0", 3'6", 4'0", 4'6", 5'1", 5'6", and 6'0". Standard thicknesses are 1 3/8" and 1 3/4". Stock thickness is 1 3/8". Standard glazing is s.s.b. glass — not bedded.

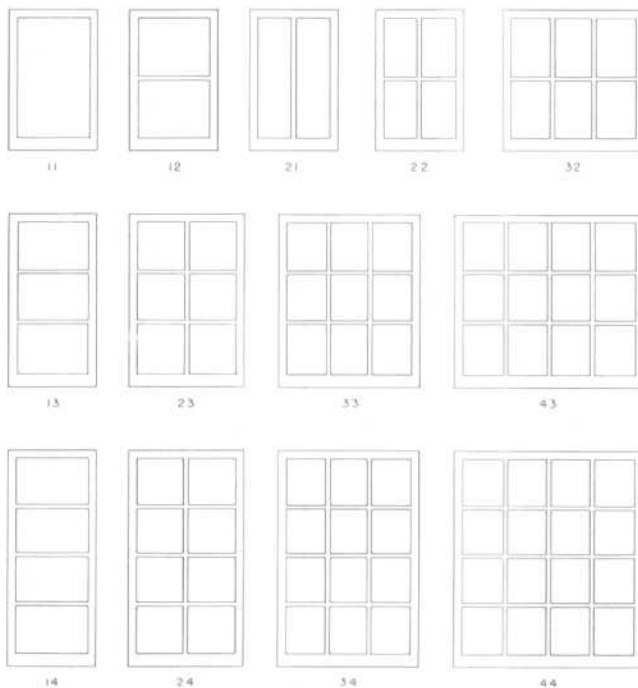
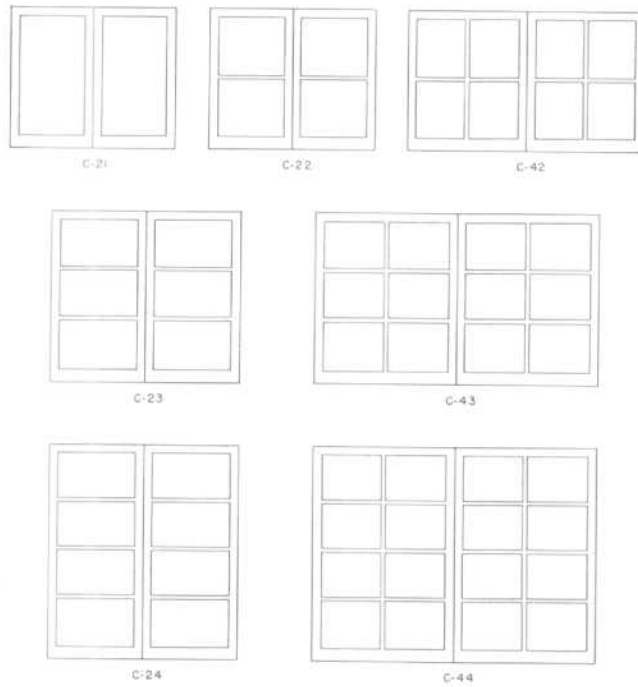


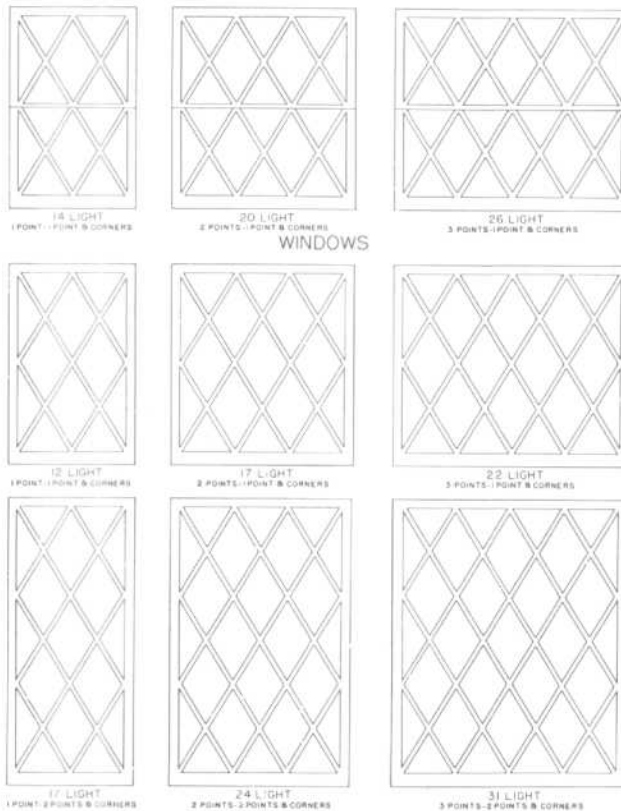
Fig. 19 Single sash: stock designs. Standard widths are 2'0", 2'6", 3'0", 3'6", 4'0", 4'6", 5'0", 5'6" and 6'0". Standard heights are 2'0", 2'6", 3'0", 3'6", 4'0", 4'6", 5'1", 5'6", 6'0", 6'6", and 7'0". Standard thicknesses are 1 3/8" and 1 3/4". Stock thickness is 1 3/8". Standard glazing is s.s.b. glass — not bedded.

STANDARD JOINERY AND CASEWORK DETAILS

Casement Windows



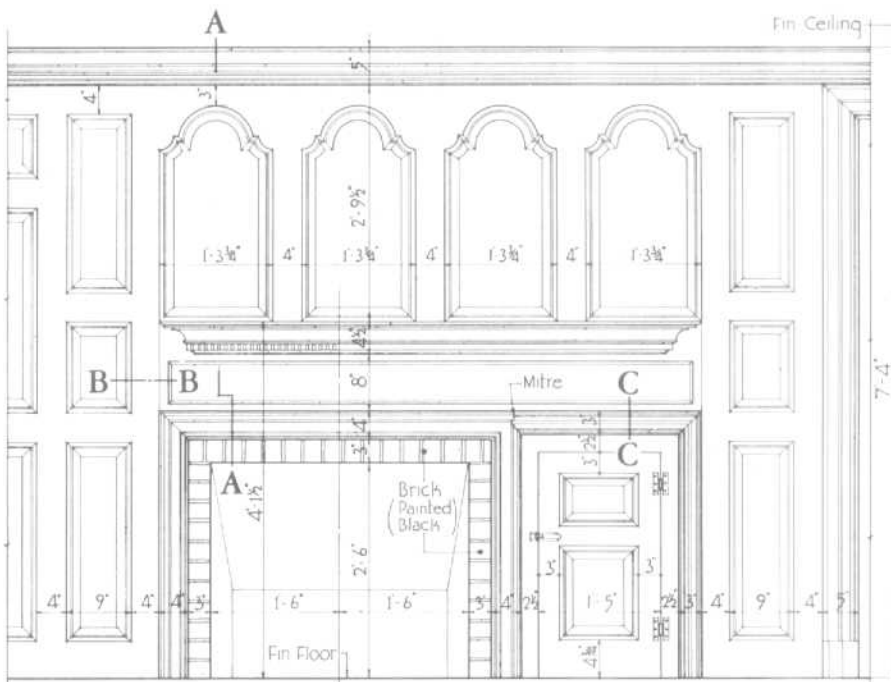
**Fig. 20 Casements in pairs: stock designs.** Standard widths are 2'6", 3'0", 3'6", 4'0", 4'6", and 5'0". Standard heights are 2'0", 2'6", 3'0", 3'6", 4'0", 4'6", 5'1", 5'6", and 6'0". Standard thicknesses are 1 1/4" and 1 3/4". Stock thickness is 1 3/4". Standard glazing is s.s.b. glass — not bedded.



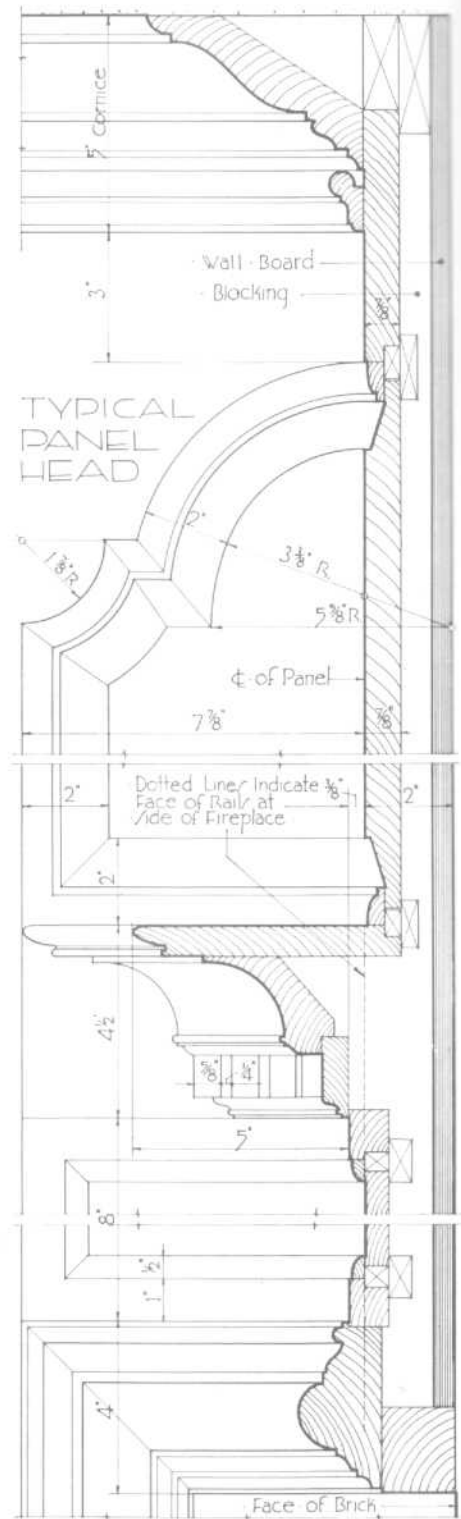
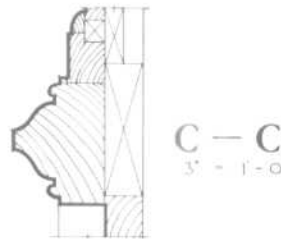
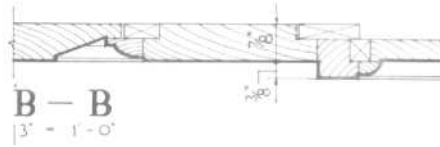
**Fig. 21 Windows and sash: typical diamond light cut-ups.**

WOODWORK DETAILS

Wood Paneling

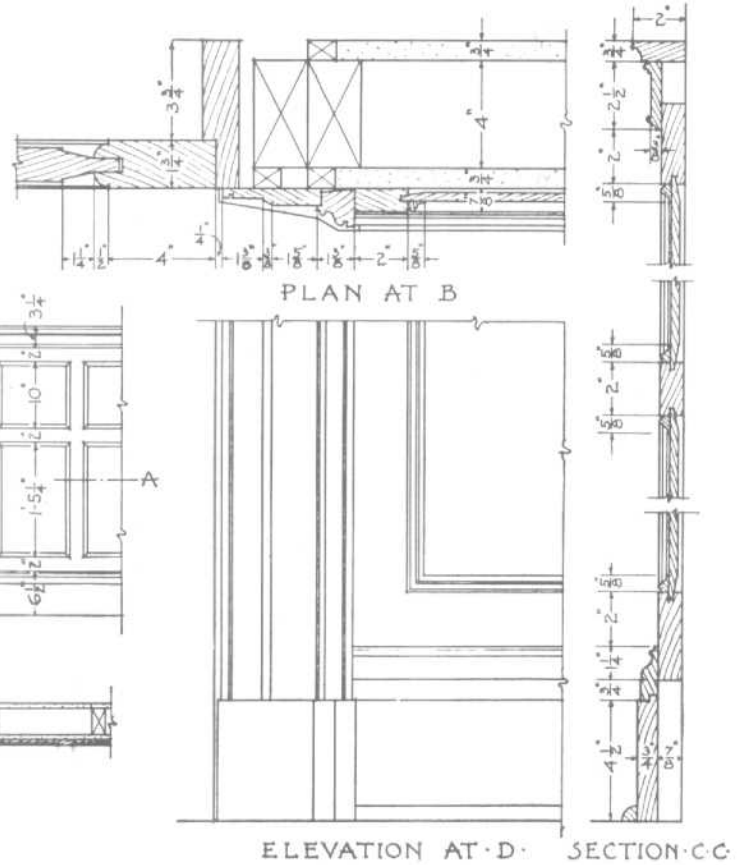
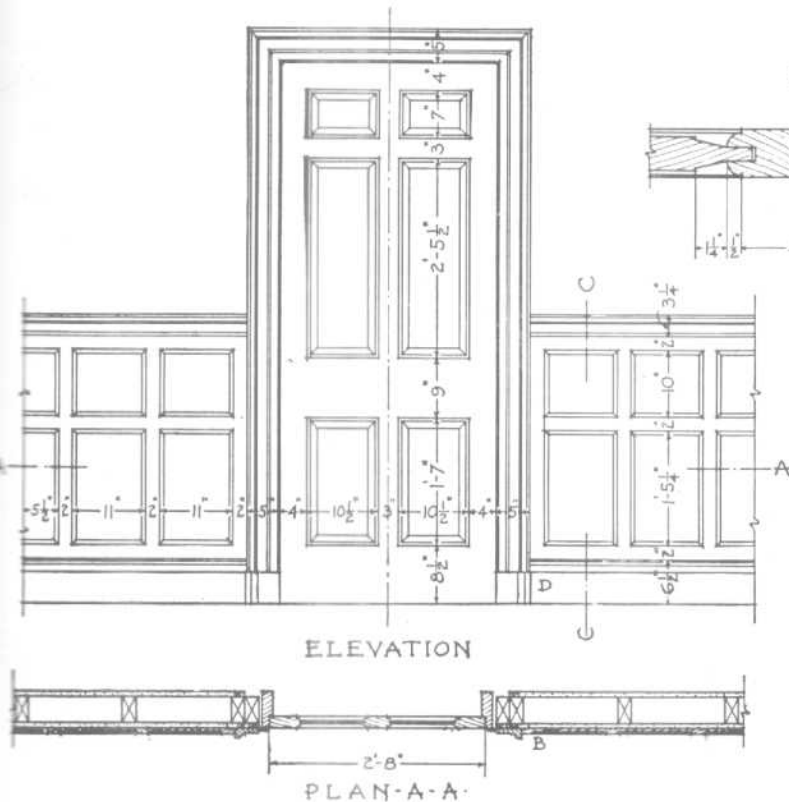


ELEVATION  
 Scale: 1/2" = 1'-0"

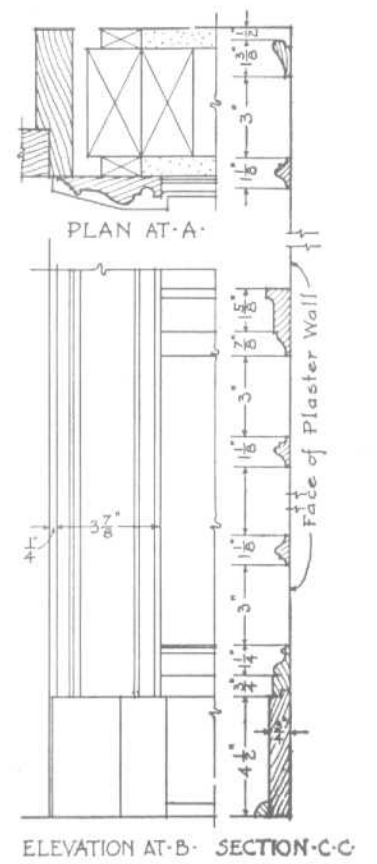
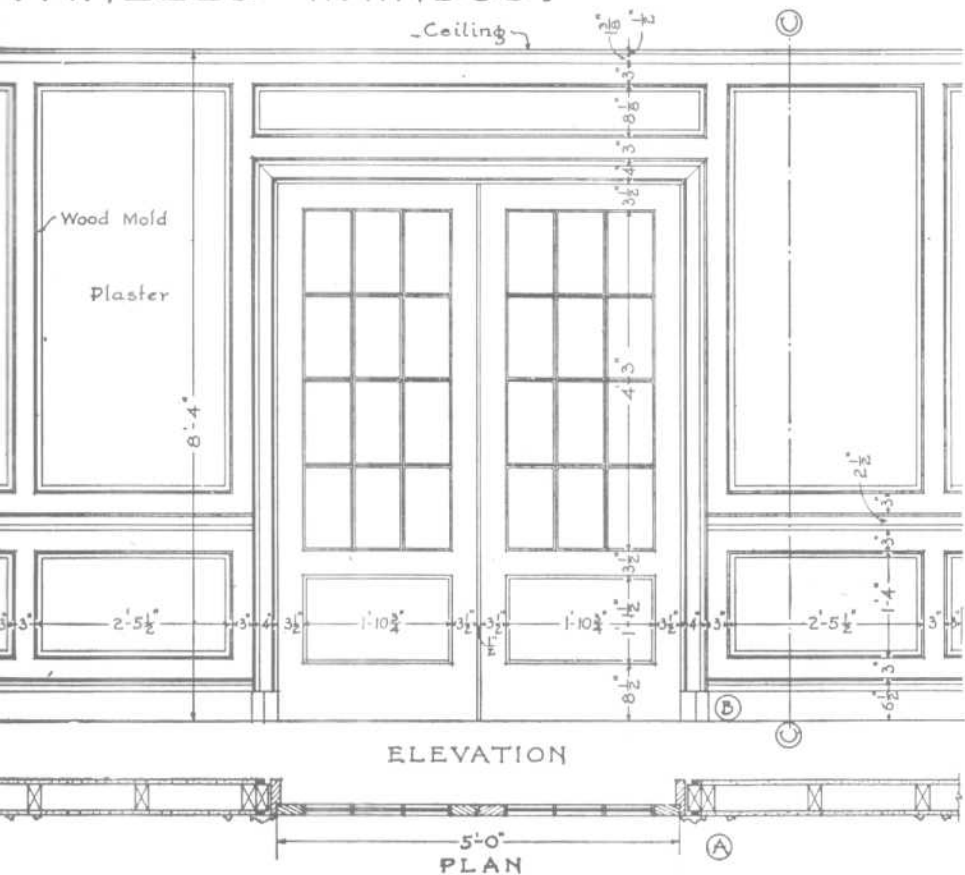


DETAIL ON LINE A-A





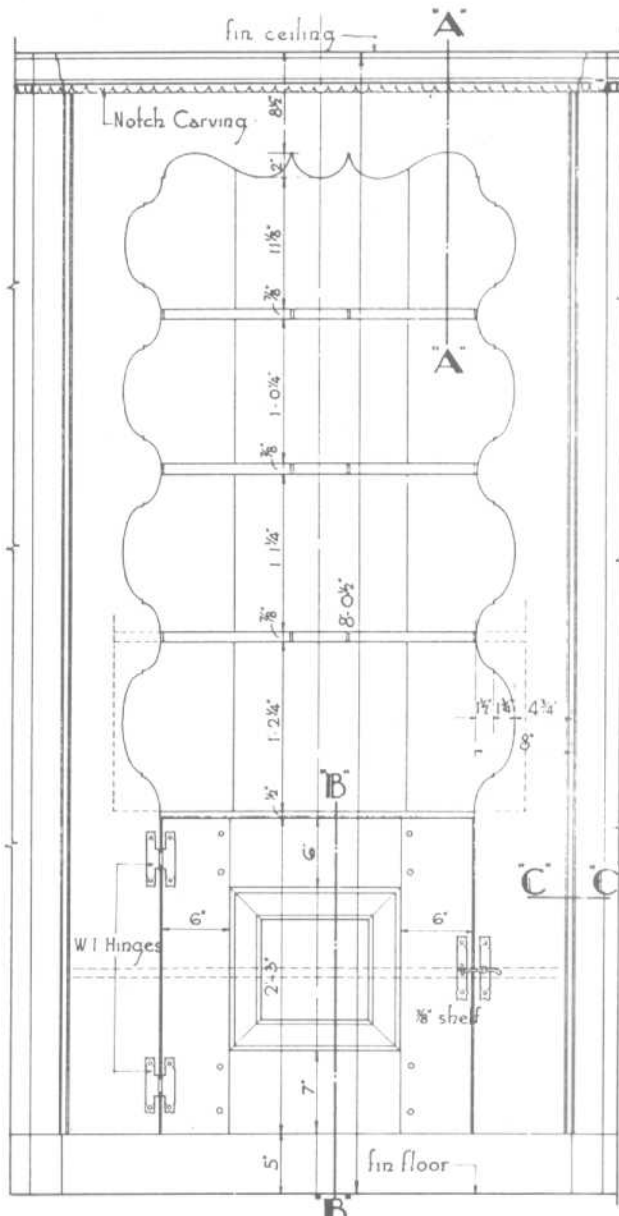
PANELED WAINSCOT



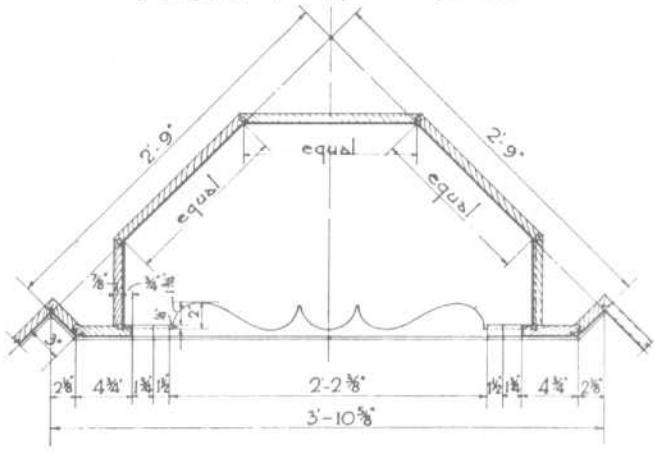
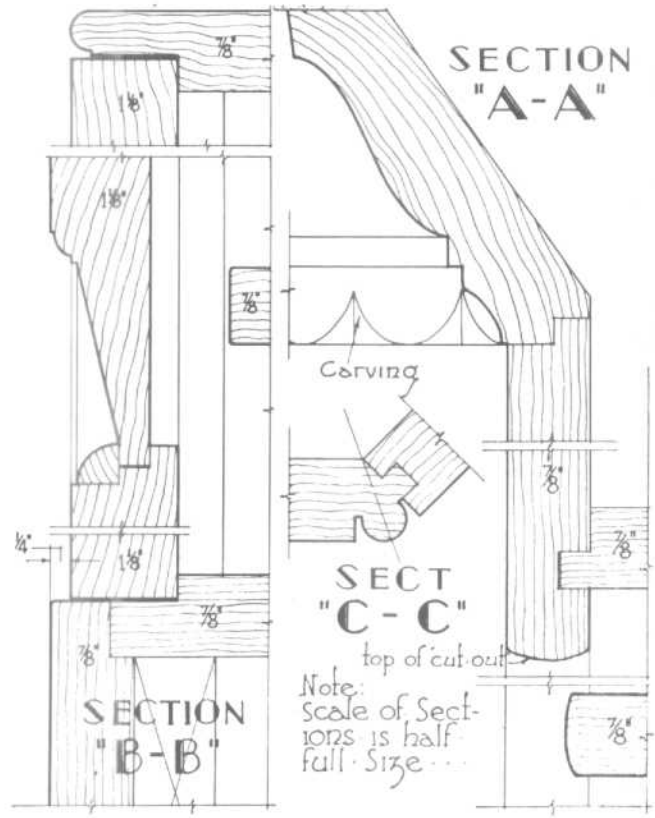
FRENCH PANELING

WOODWORK DETAILS

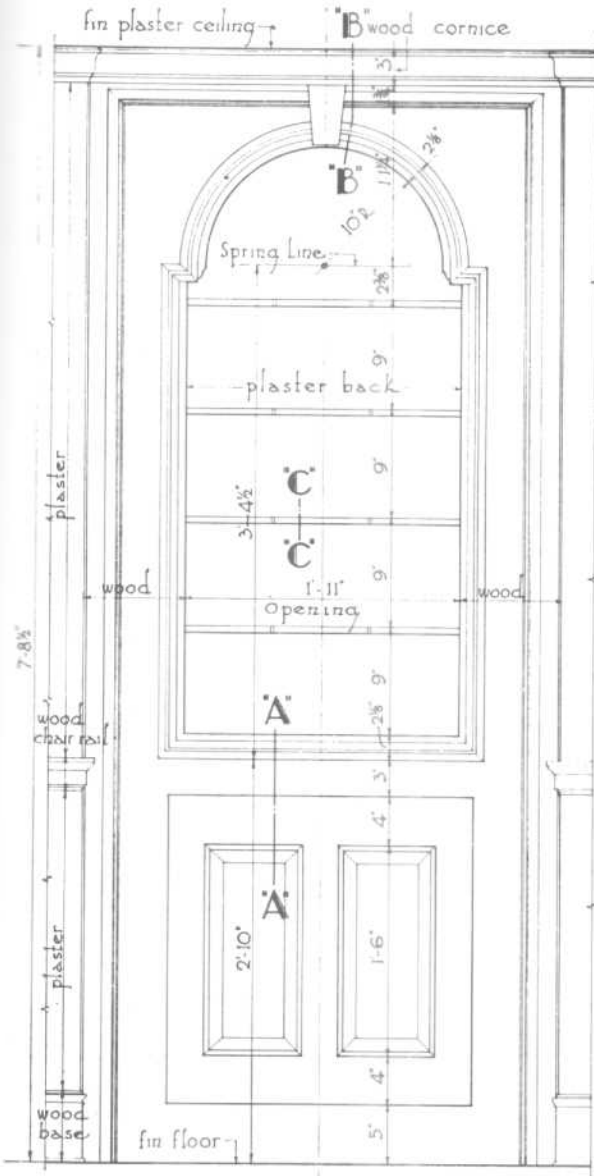
Corner Cupboard



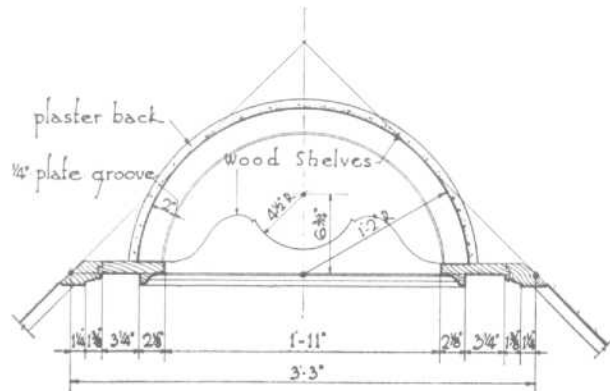
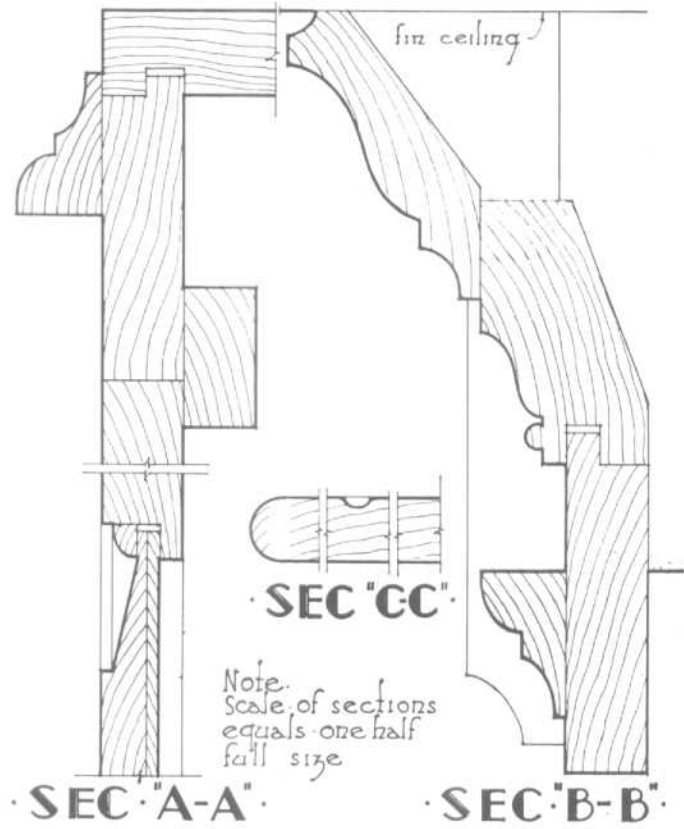
**ELEVATION**  
 scale :  $\frac{3}{4}'' = 1'-0''$



**PLAN**  
 $\frac{3}{4}'' = 1'-0''$



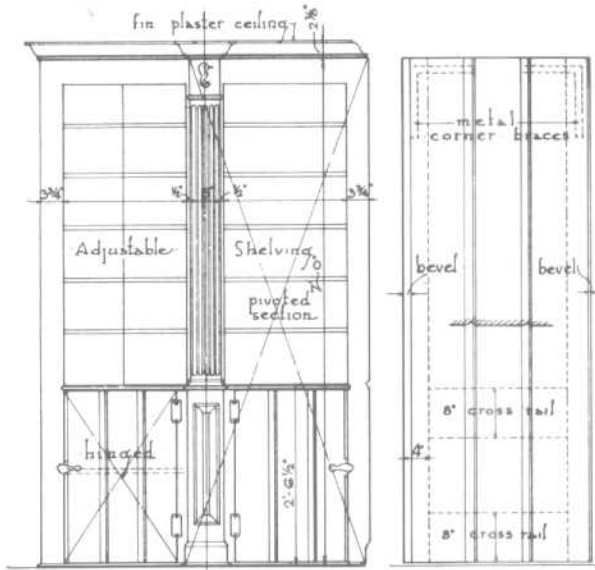
**ELEVATION**  
Scale 3/4" = 1'-0"



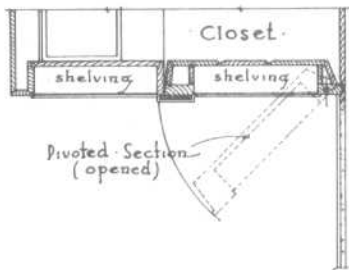
**PLAN**  
3/4" = 1'-0"

WOODWORK DETAILS

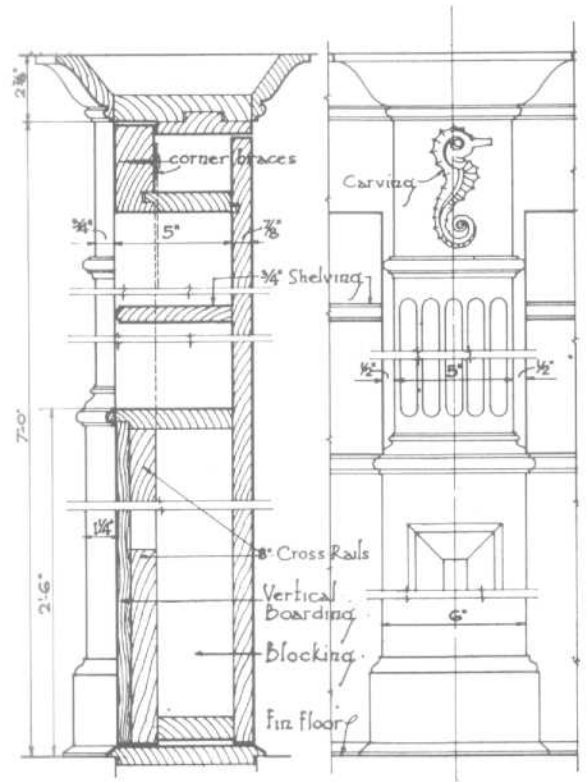
Bookcases



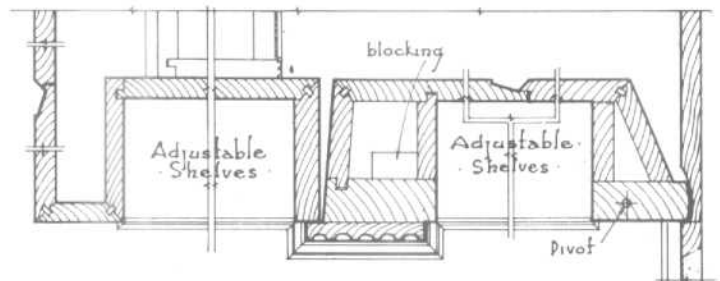
3/8" SCALE ELEVATION · DOOR BACK ·  
Showing book shelving and secret  
Door to silver closet



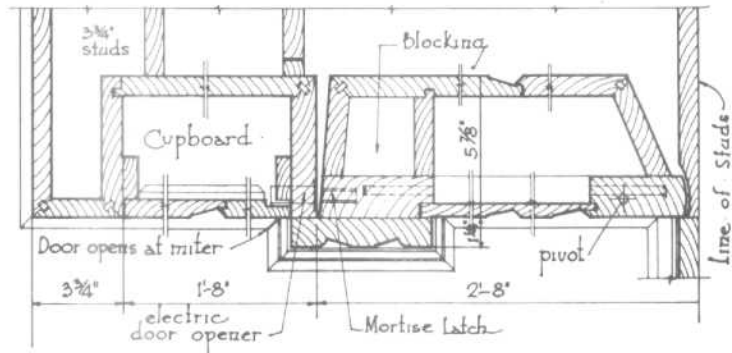
3/8" SCALE PLAN ·  
of  
BOOK SHELVES ·  
& SECRET DOOR



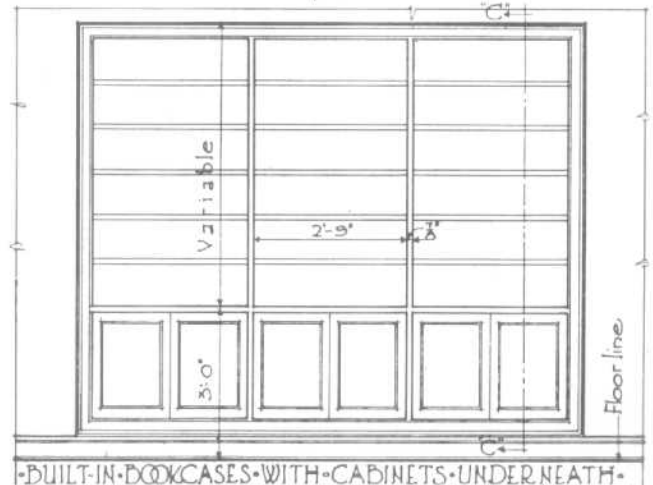
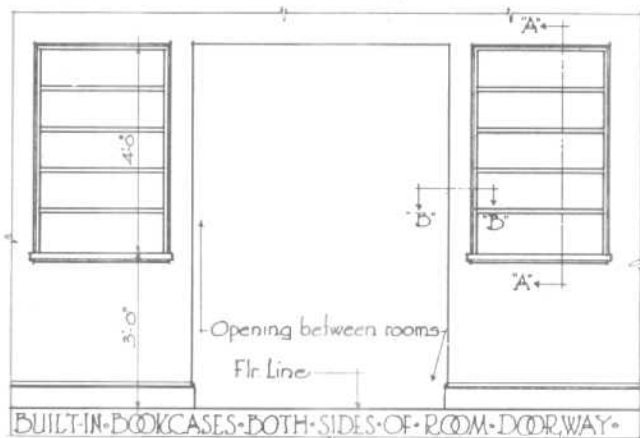
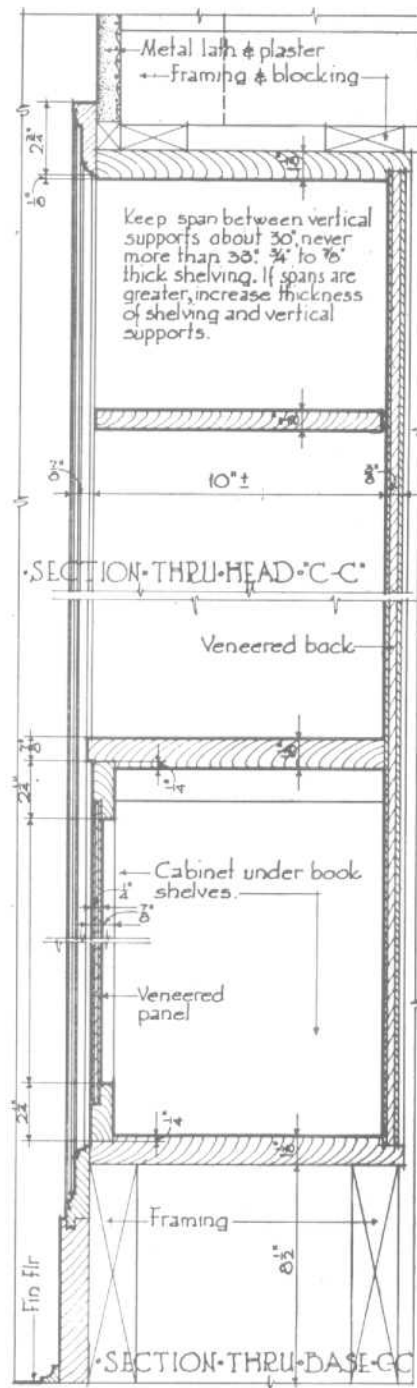
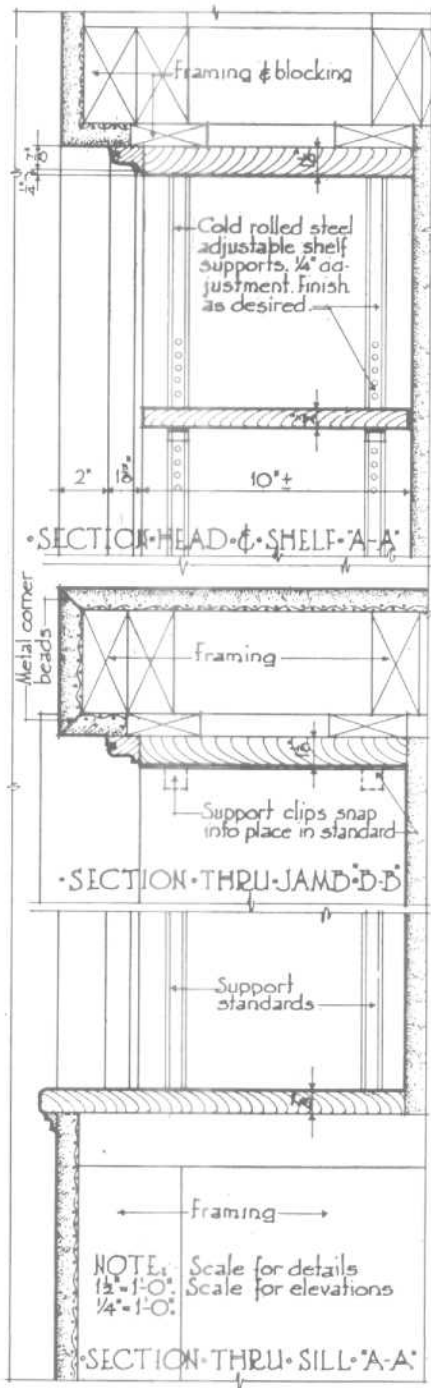
VERTICAL SECTION · ELEVATION ·  
THROUGH DOOR · OF PILASTER ·  
Scale: 1 1/2" = 1'-0"



SECTION ON LINE "A-A" THRU SHELVING ·  
scale: 1 1/2" = 1'-0"

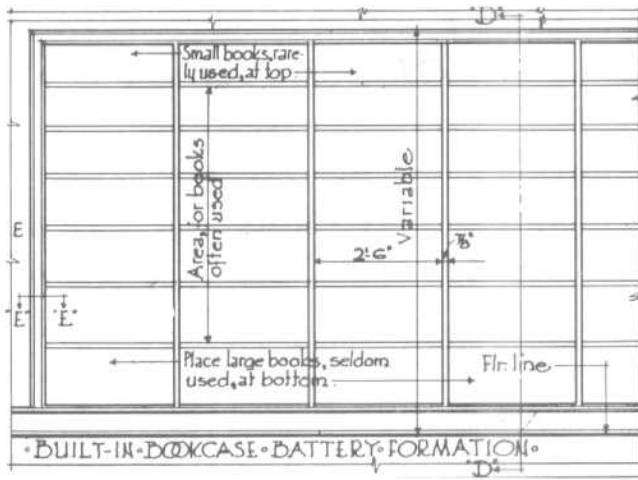


SECTION ON LINE "B-B" THRU CUPBOARD ·  
Scale: 1 1/2" = 1'-0"

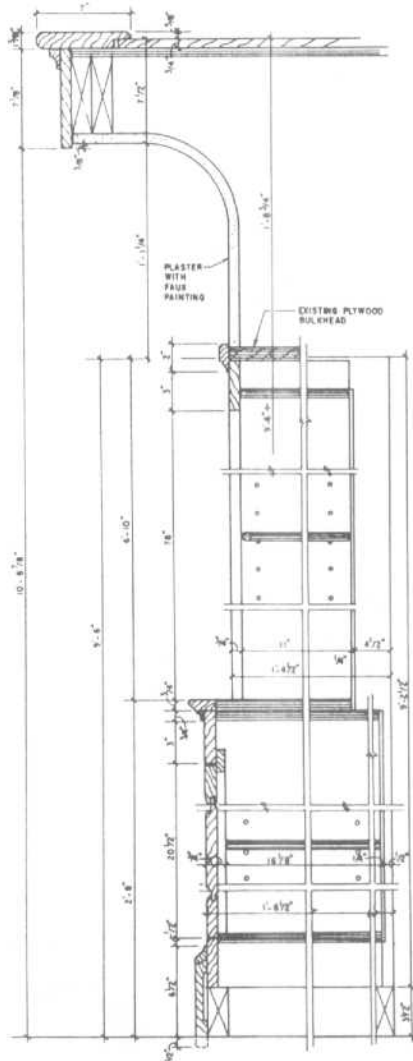


WOODWORK DETAILS

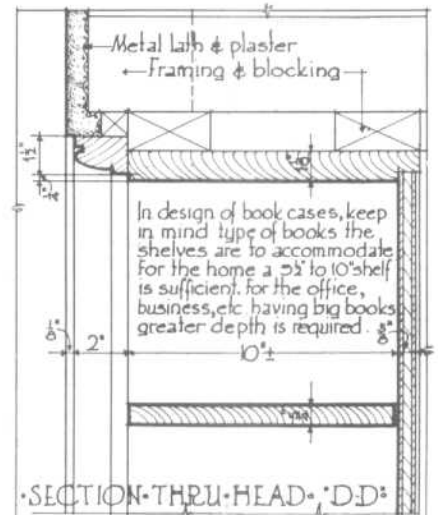
Bookcases



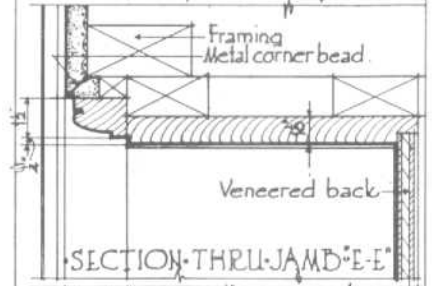
BUILT-IN BOOKCASE BATTERY FORMATION



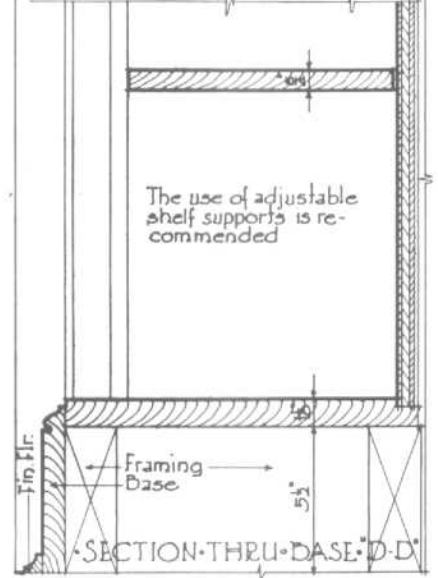
SECTION - BOOKCASE UNIT



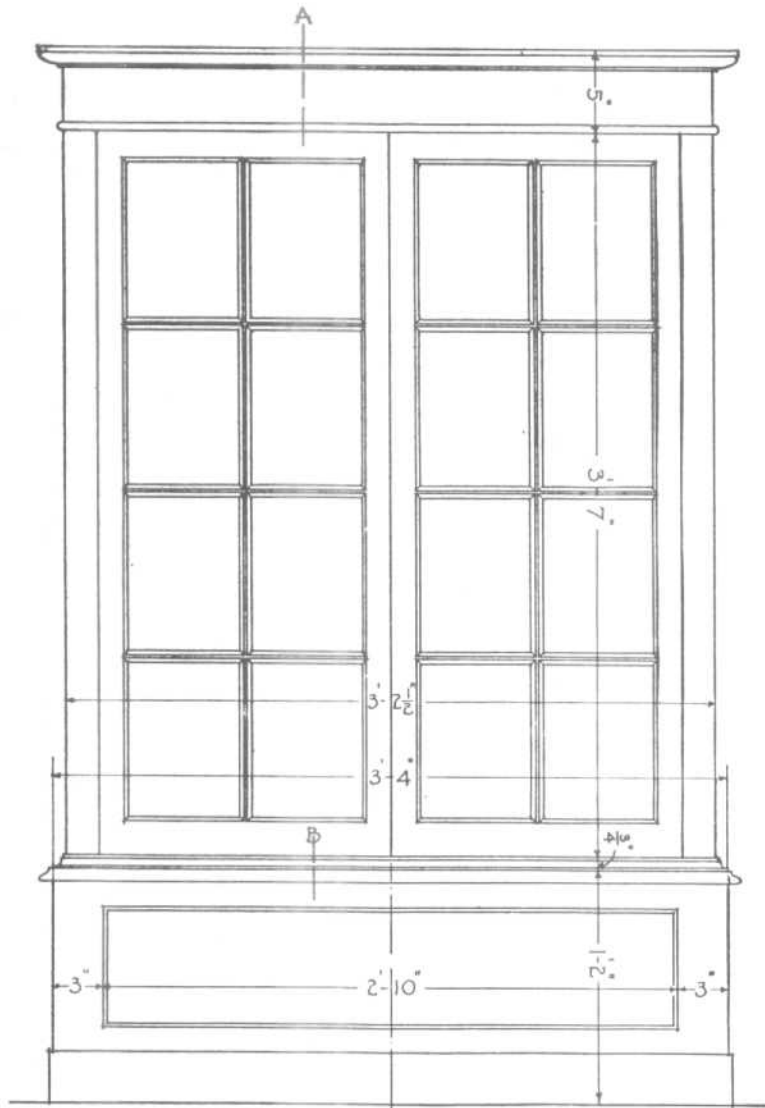
SECTION THRU HEAD - D-D



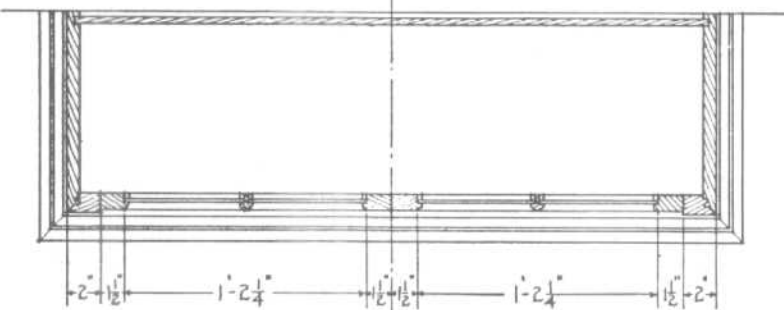
SECTION THRU JAMB - E-E



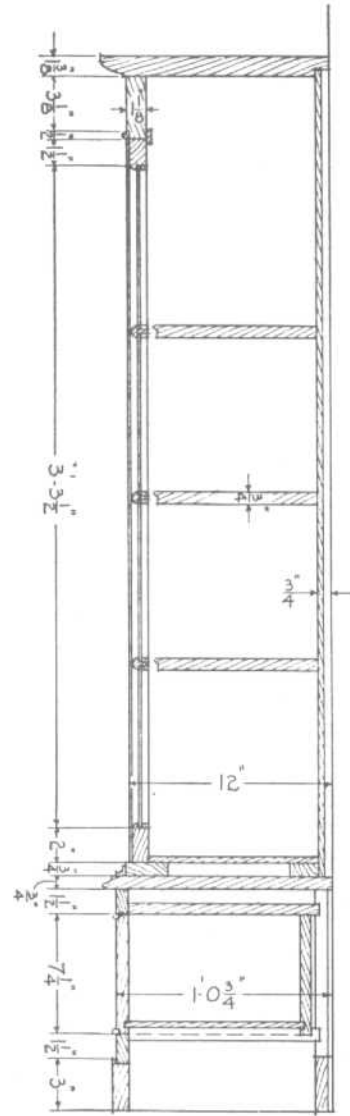
SECTION THRU BASE - D-D



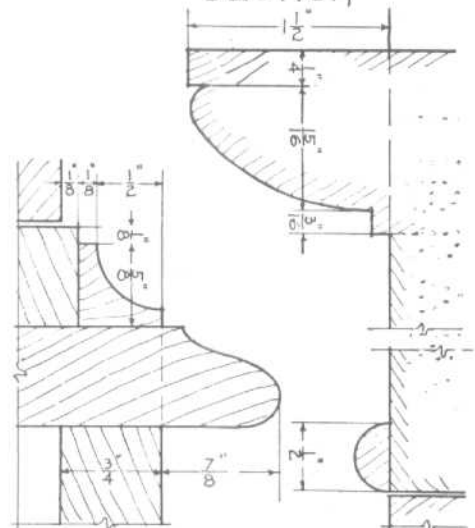
ELEVATION



PLAN



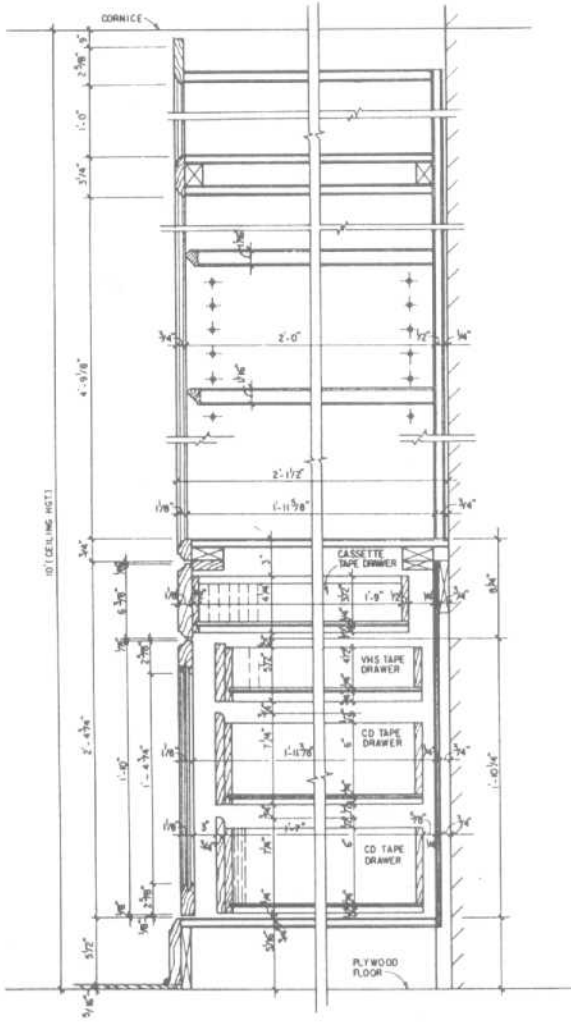
SECTION



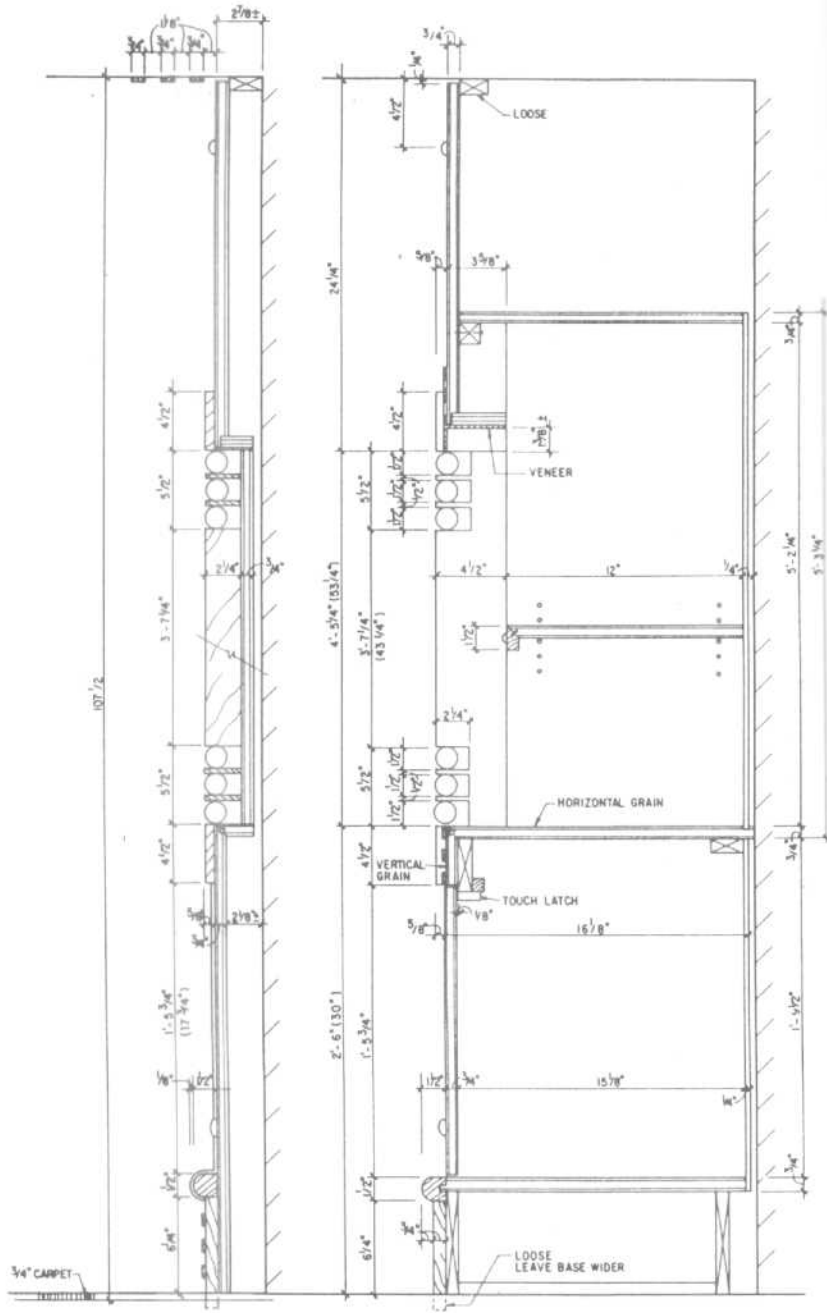
FULL SIZE SECTION · B · F.S. SECTION A

WOODWORK DETAILS

Library Cabinets and Bookcases



VERTICAL SECTION  
LIBRARY CABINETS



VERTICAL SECTION - LIBRARY BOOKCASE



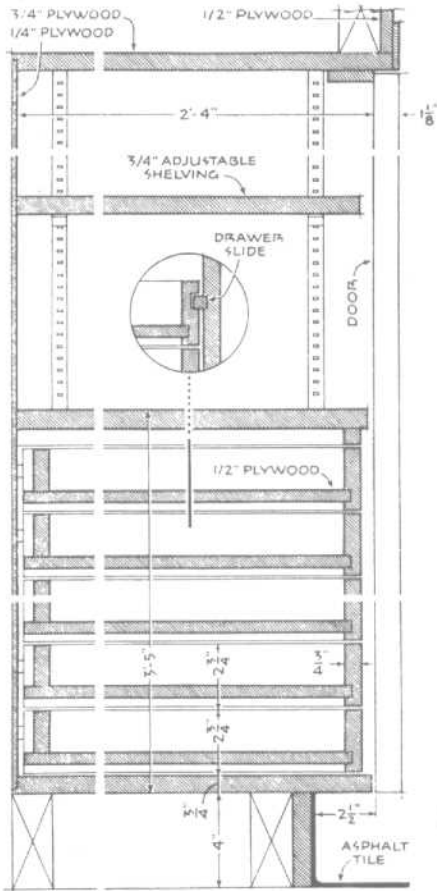




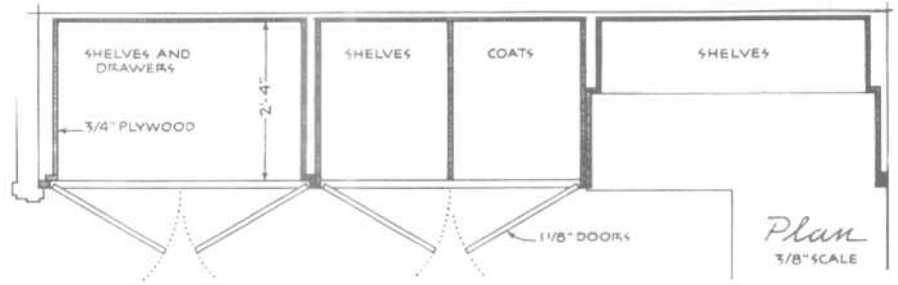


WOODWORK DETAILS

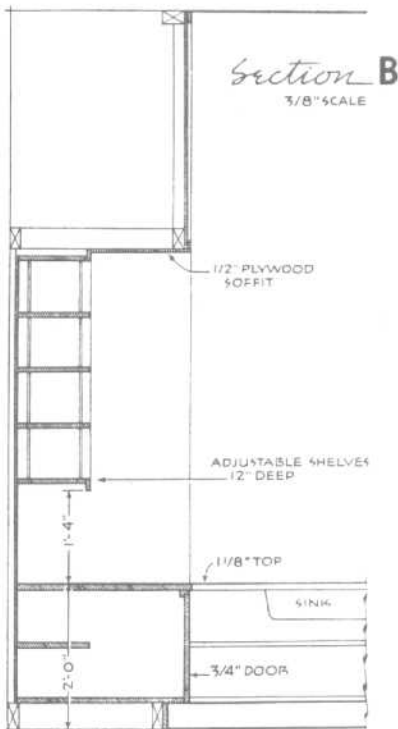
Storage Cabinets



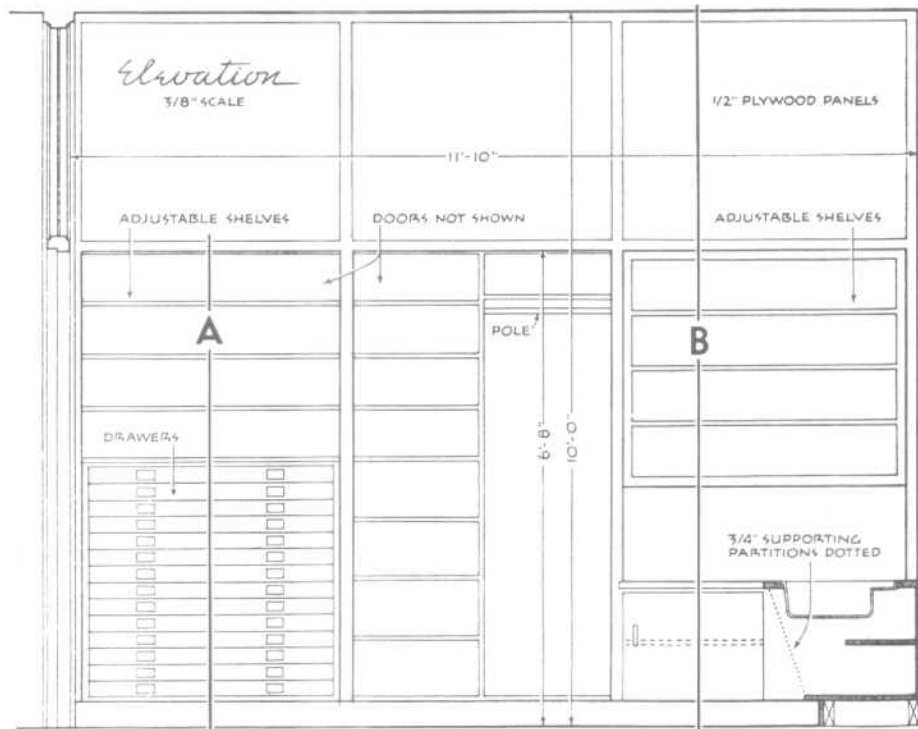
Section A 1/2" SCALE



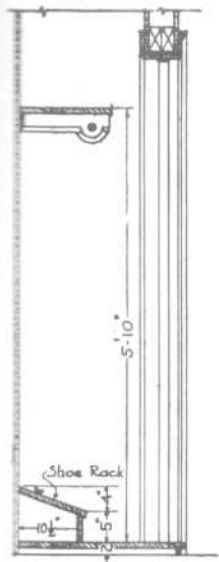
Plan 3/8" SCALE



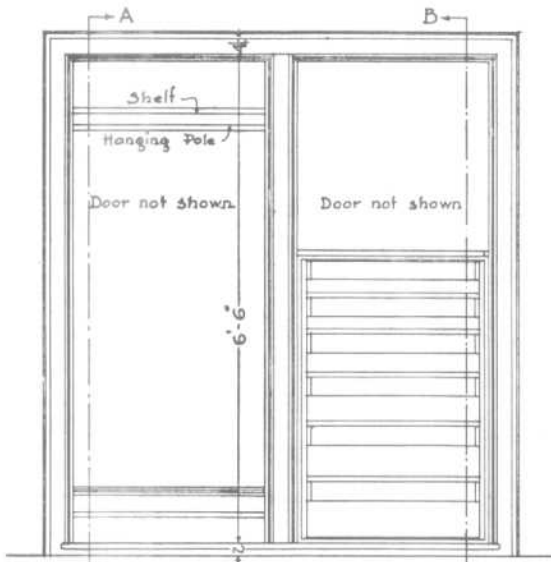
Section B 3/8" SCALE



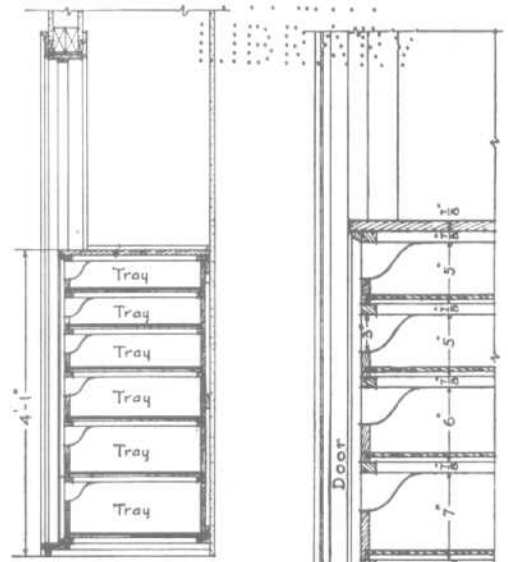
Elevation 3/8" SCALE



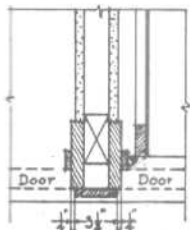
SECTION A-A



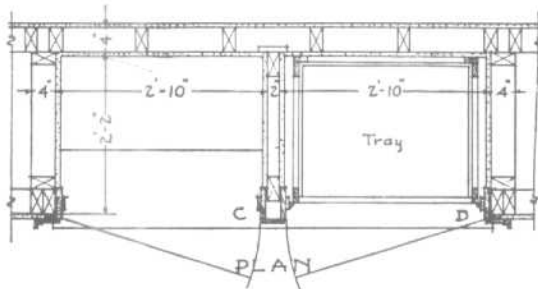
ELEVATION



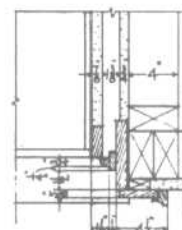
SECTION B-B



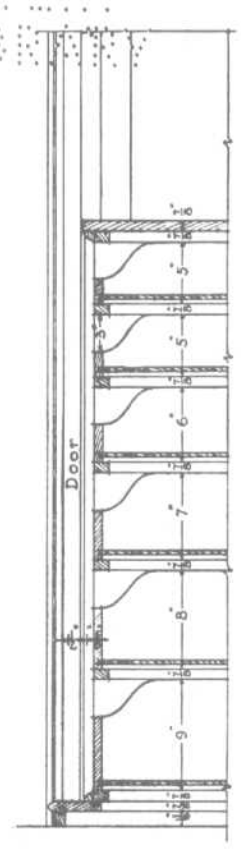
DETAIL PLAN C



PLAN

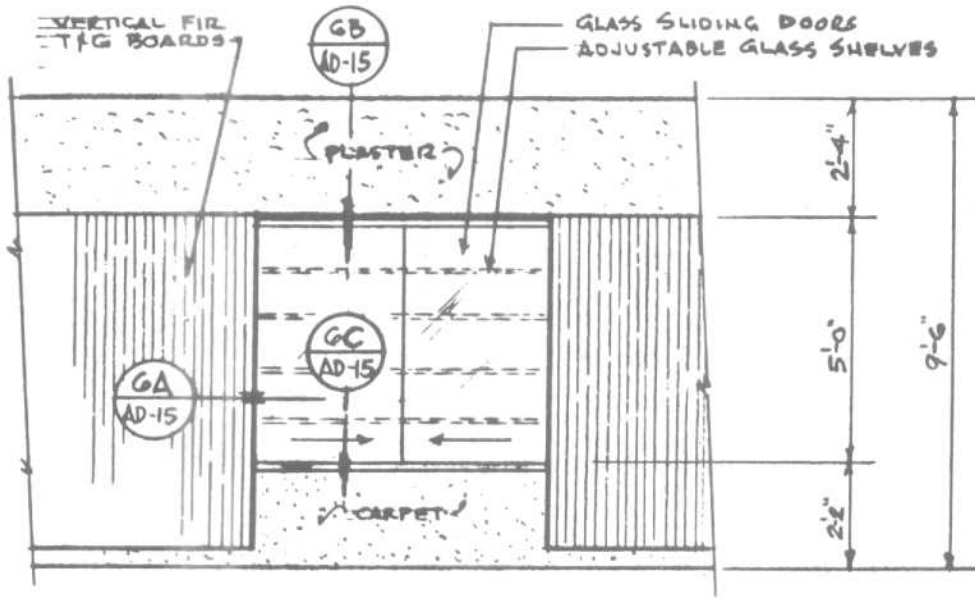


DETAIL PLAN D

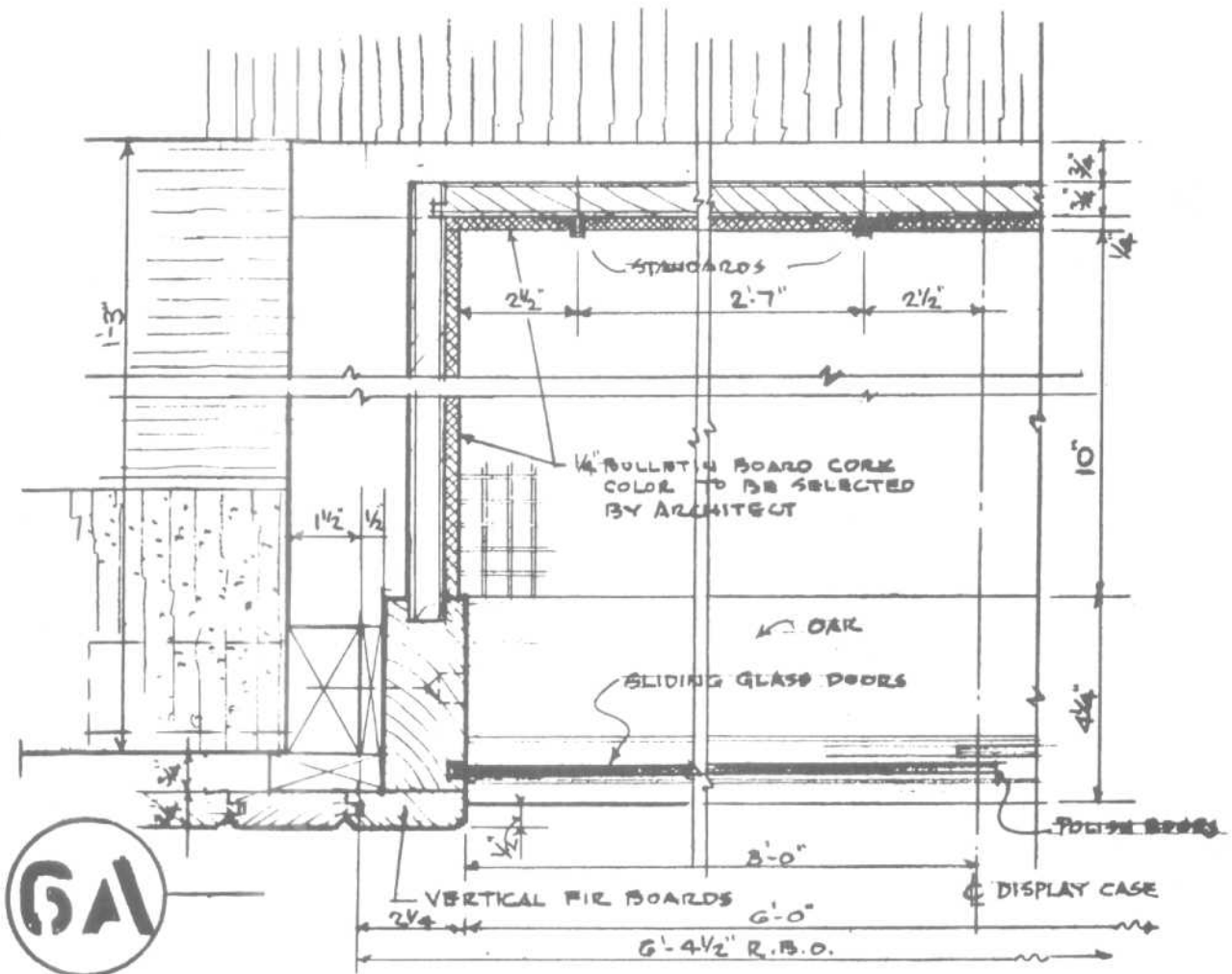


DETAIL SECTION



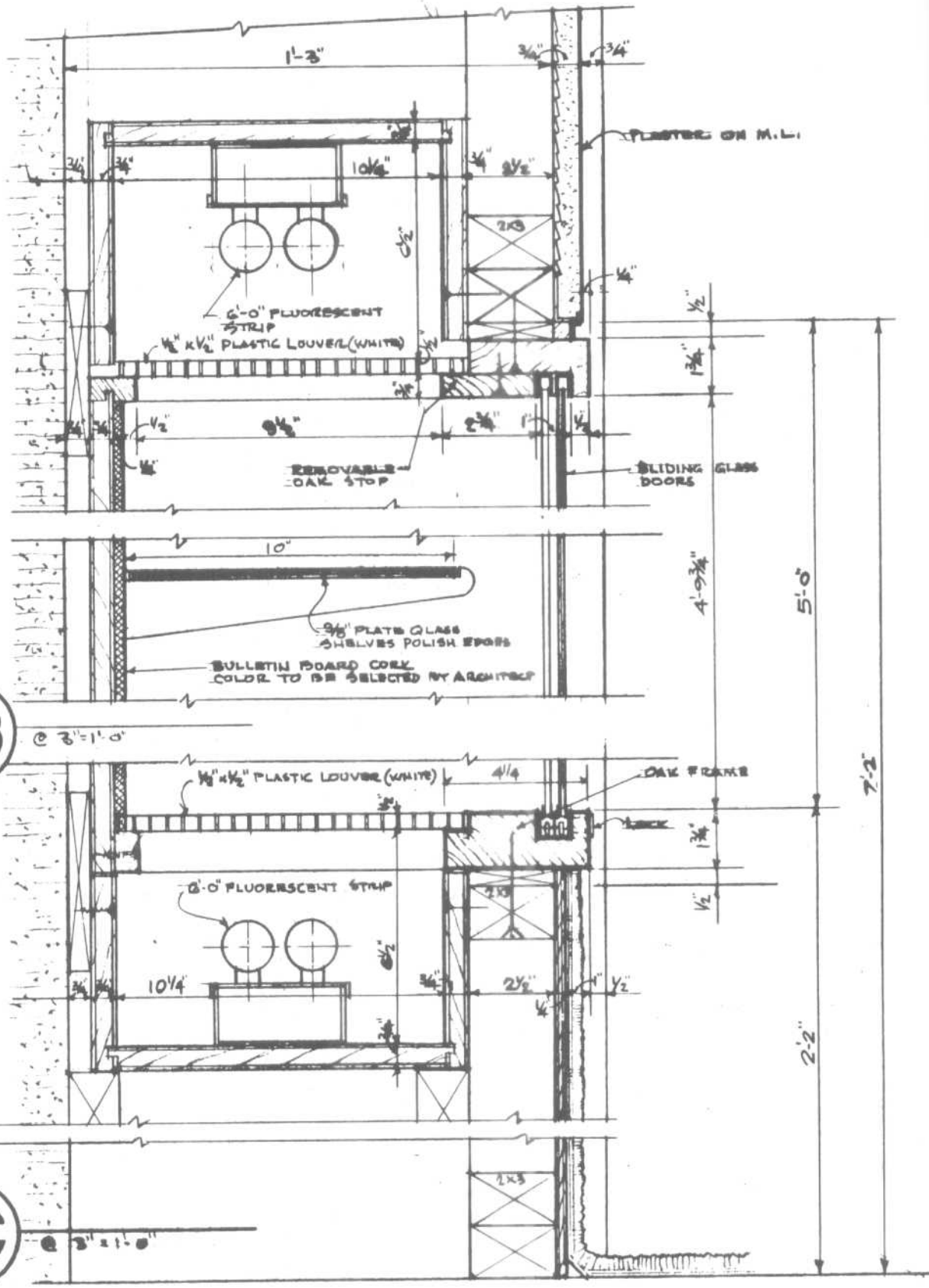


ELEVATION OF GIFT DISPLAY CASE



WOODWORK DETAILS

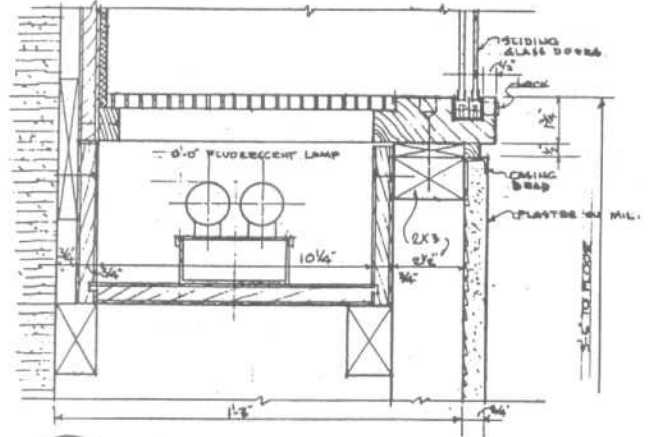
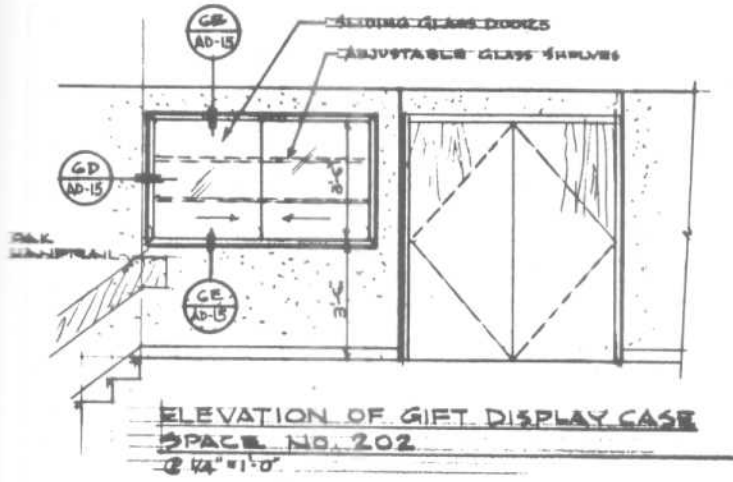
Display Case



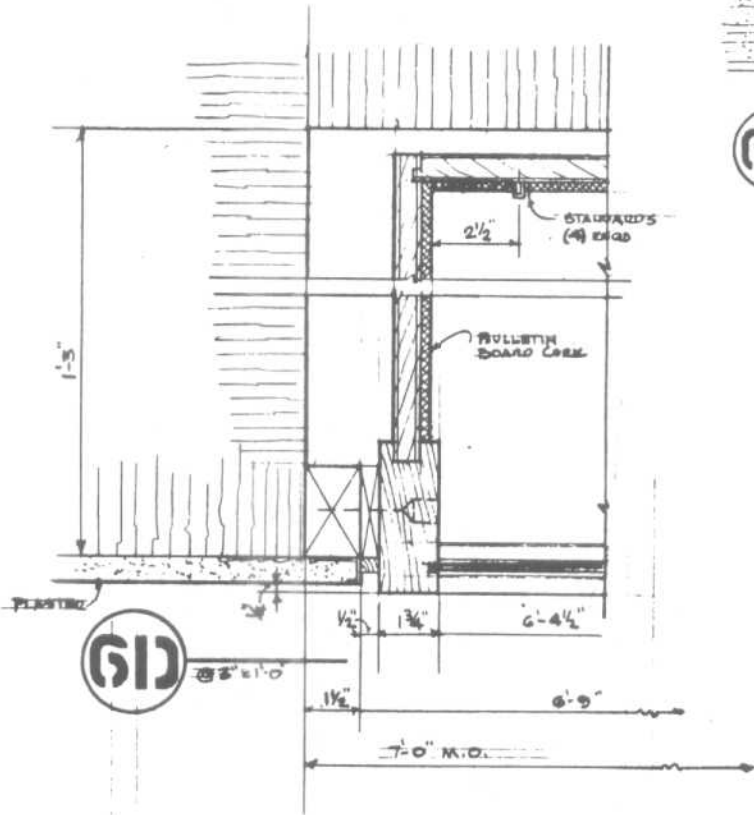
613

615





**GE**  
 @ 5/16" = 1'-0"



**GD**  
 @ 5/16" = 1'-0"

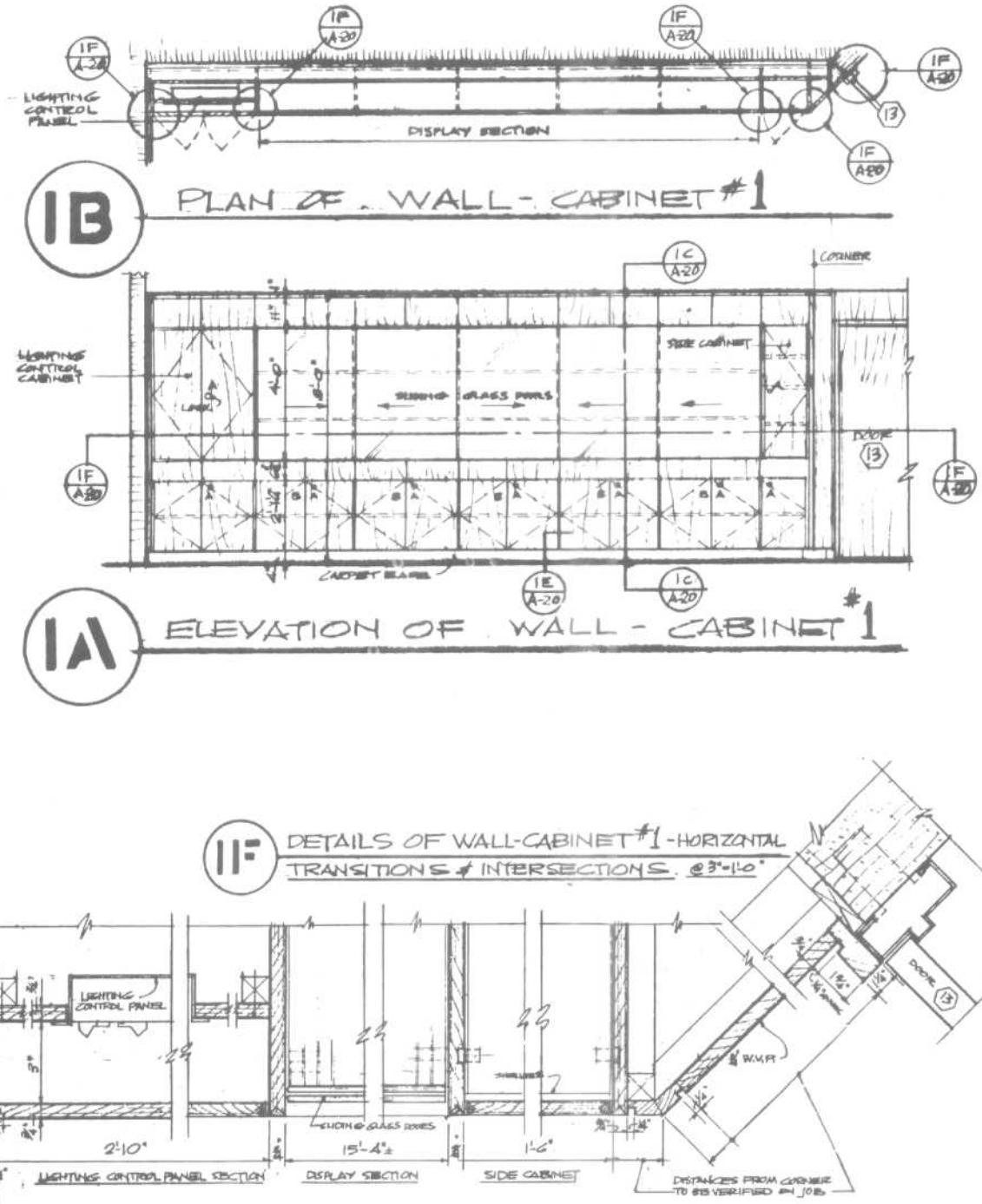


Fig. 2



WOODWORK DETAILS

Work Counter

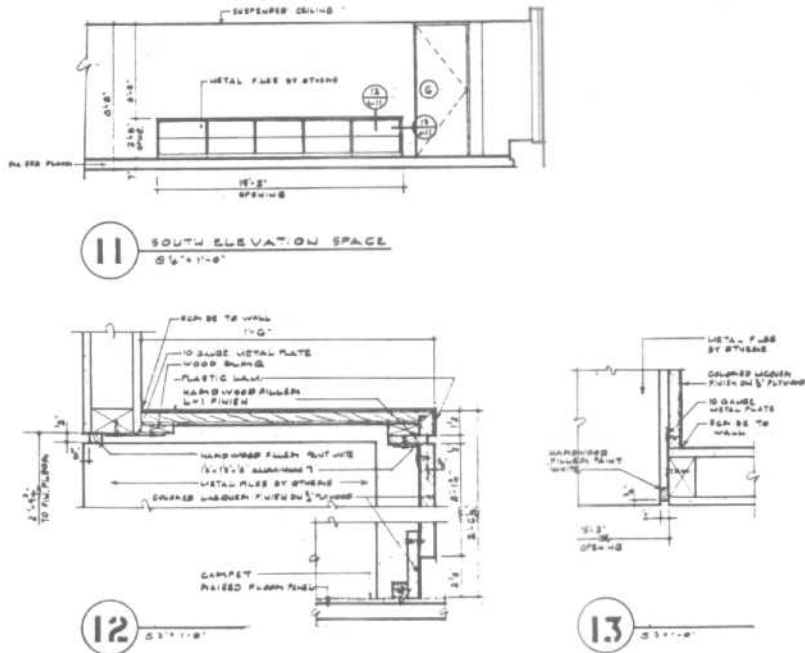


Fig. 3 Countertop.

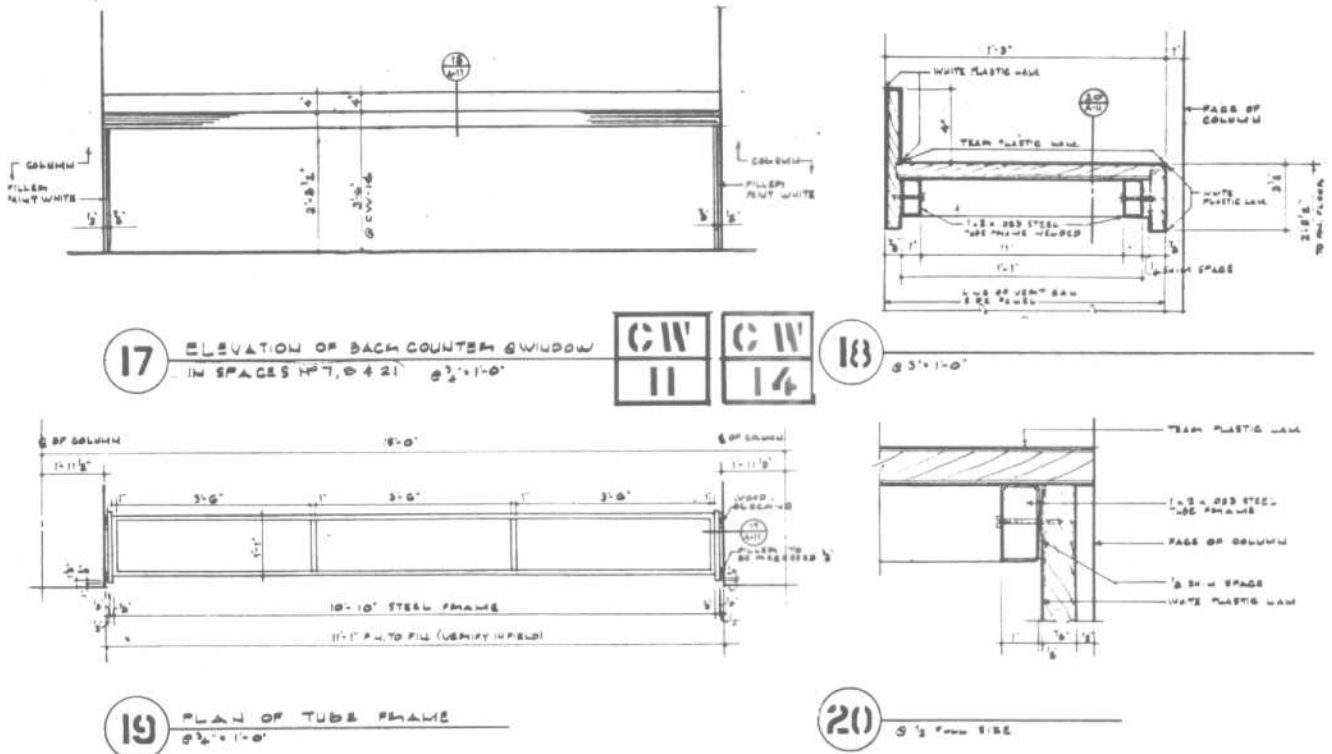


Fig. 4 Back counter.

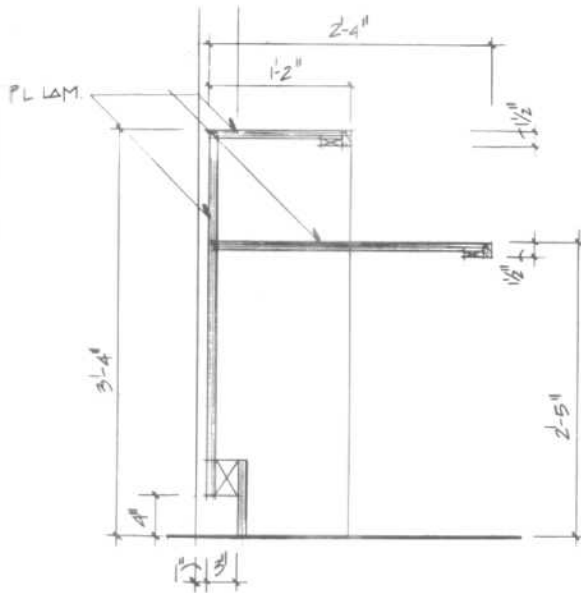


Fig. 5 Word processing counter.

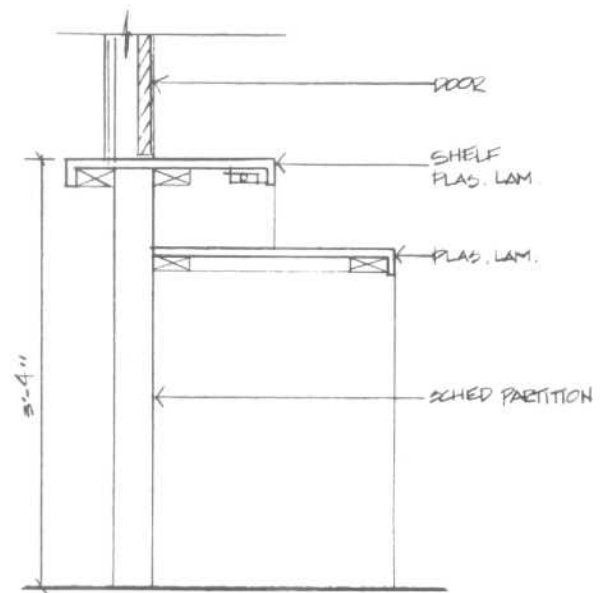


Fig. 6 Cashier counter.

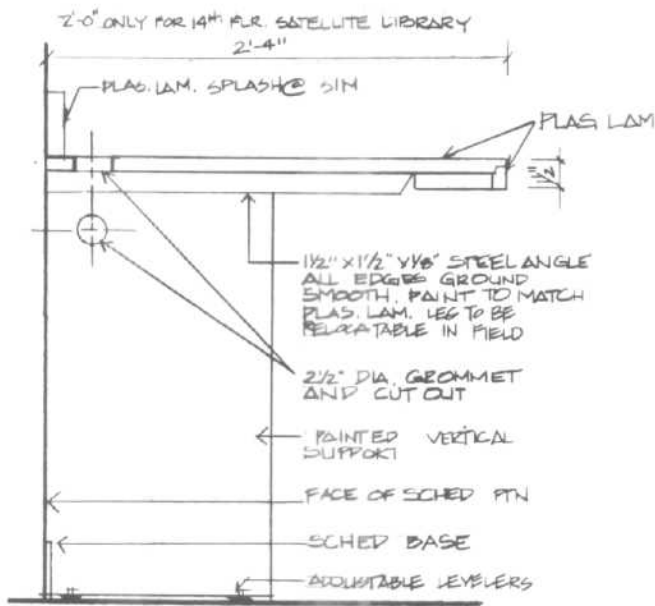


Fig. 7 Base and work counter.

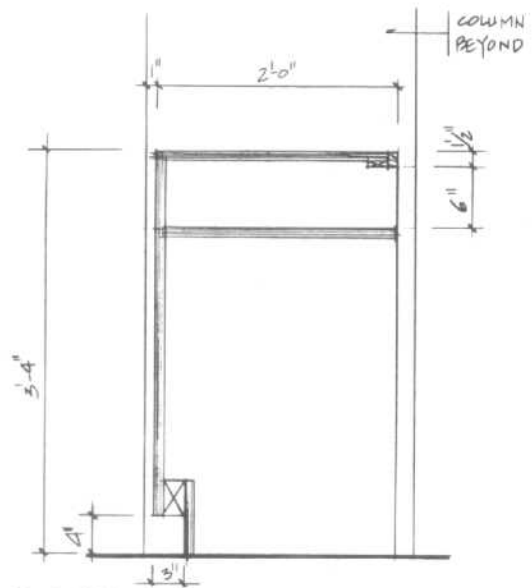
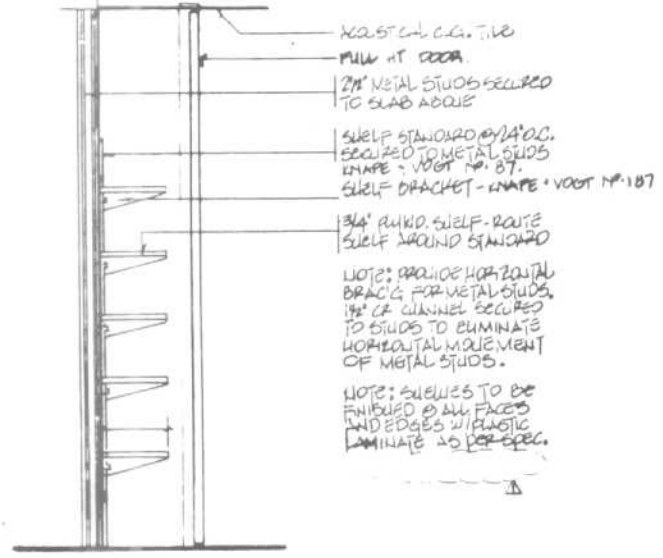
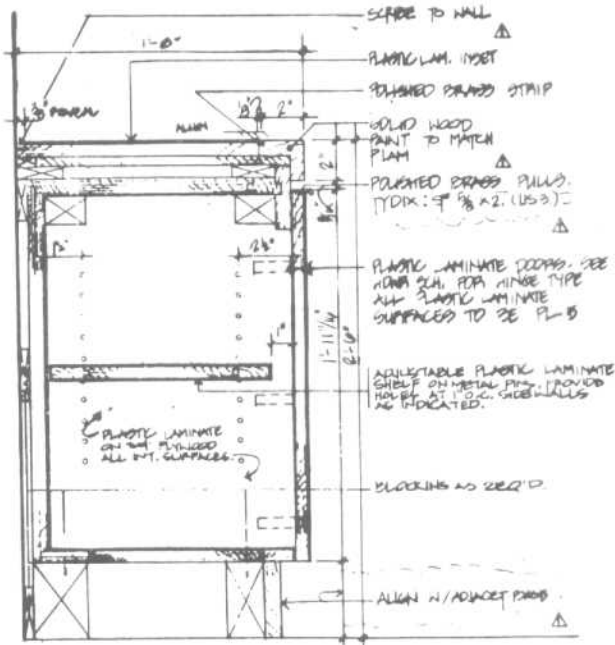


Fig. 8 Walkup counter.

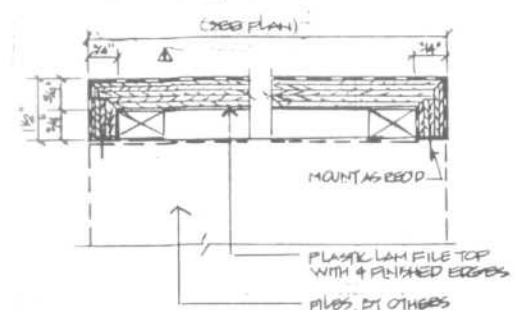
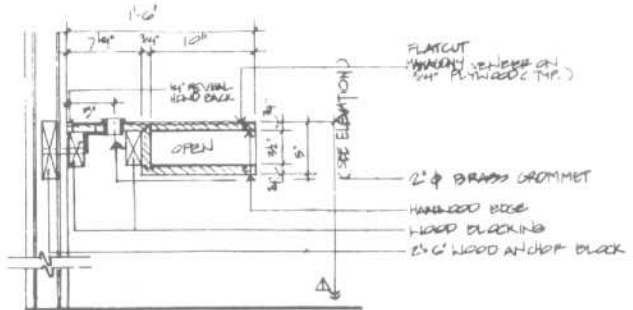
WOODWORK DETAILS

Work Counter



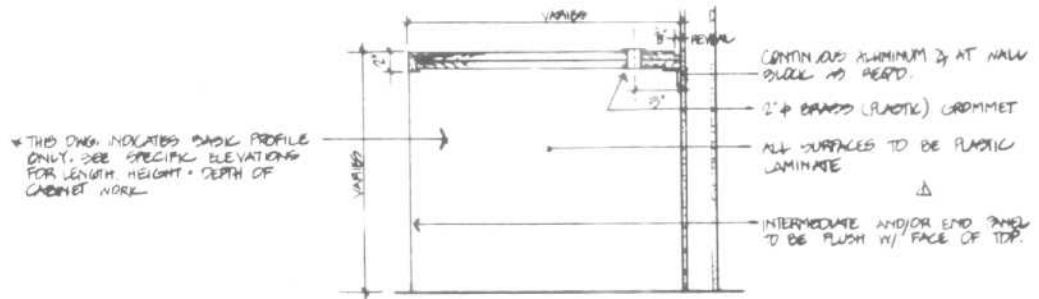
3 CONF. RM. CREDENZA @ RM. 45/68  
 NTS

5 SHELF UNIT  
 NTS



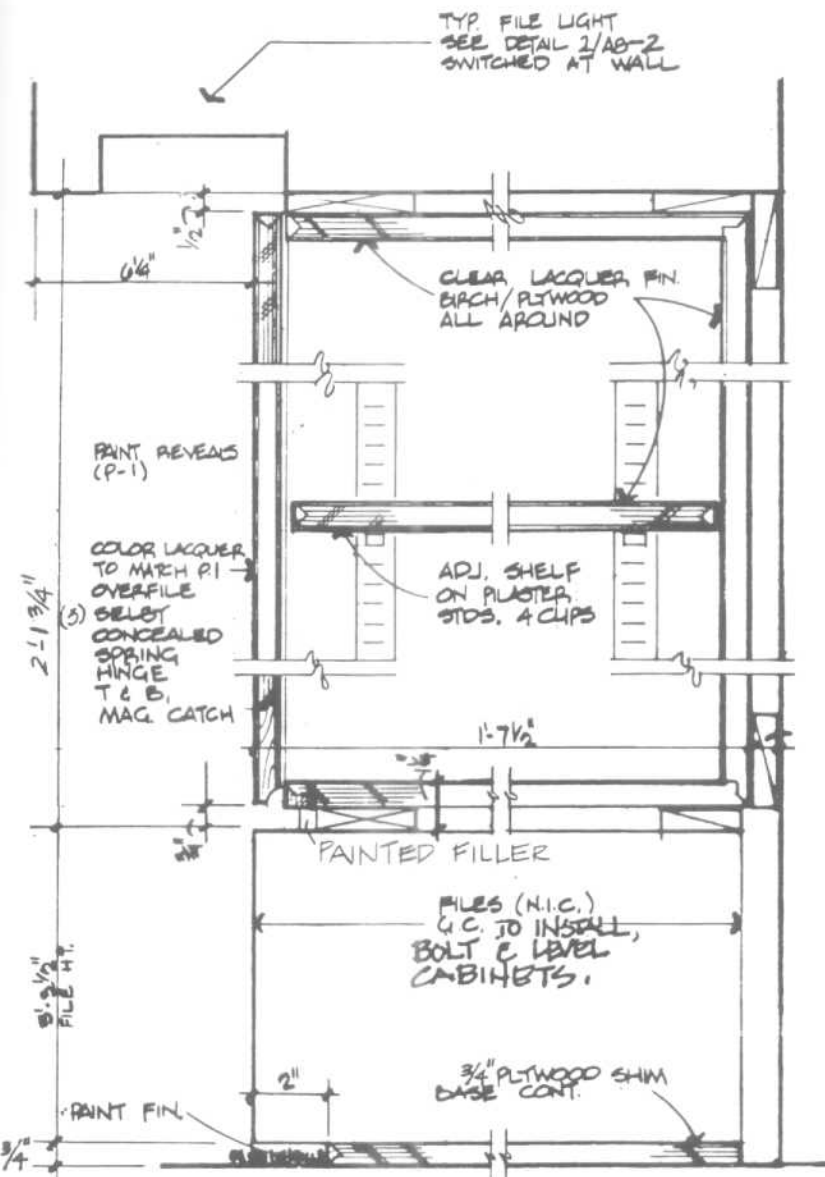
4 DET. SECTION THRU TELEPHONE COUNTER  
 1/2" = 1'-0"

6 TYP. SECTION OF FILE COUNTER TOP  
 HALF SCALE

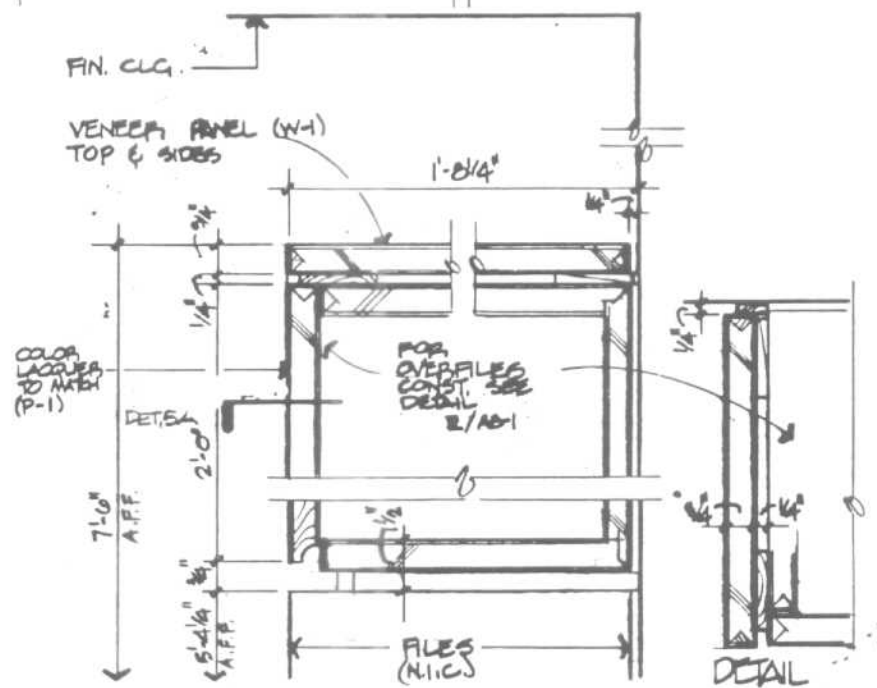


THIS DIM. INDICATES BASIC PROFILE ONLY. SEE SPECIFIC ELEVATIONS FOR LENGTH, HEIGHT, & DEPTH OF CABINET WORK.

12 TYP. COUNTER UNIT - TAX LIBRARY & LITIGATION CENTER  
 NTS



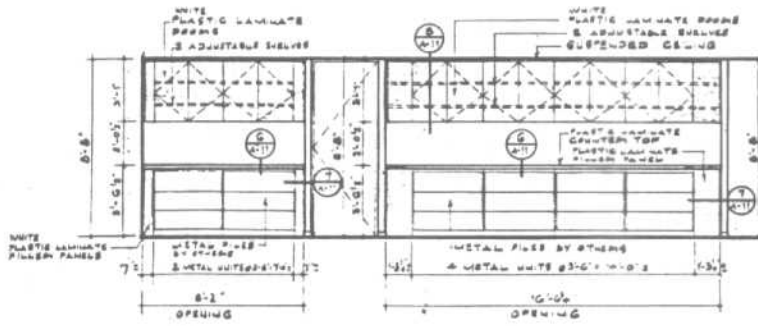
OVERFILE



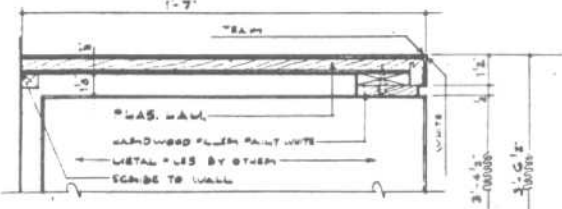
FILE END  
PNL

WOODWORK DETAILS

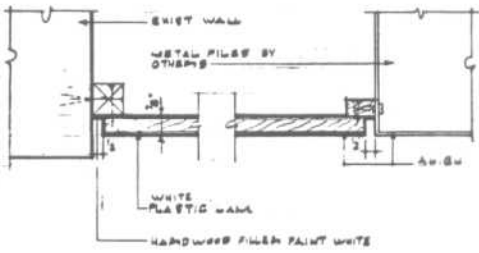
Overfile Cabinet



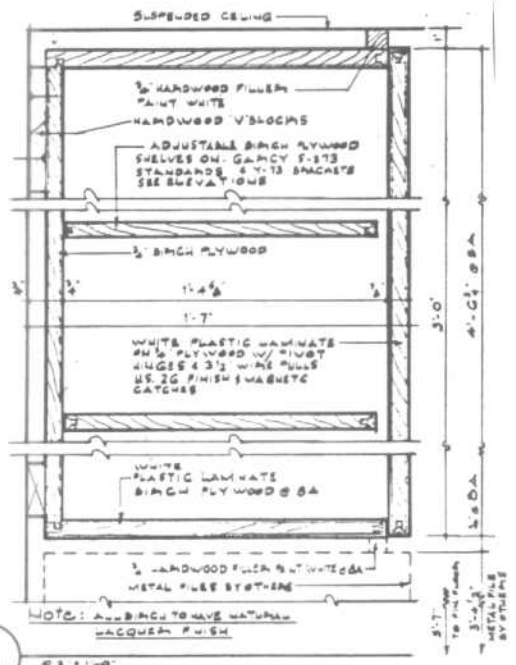
2 SOUTH ELEVATION  
8' 0" x 1'-0"



6 8' 0" x 1'-0"



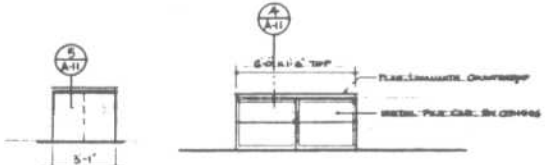
7 8' 0" x 1'-0"



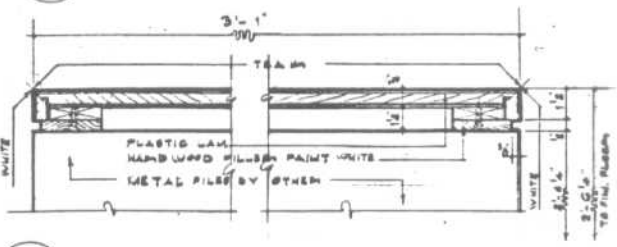
8 8' 0" x 1'-0"

NOTE: ALL BRICK TO HAVE NATURAL LACQUER FINISH

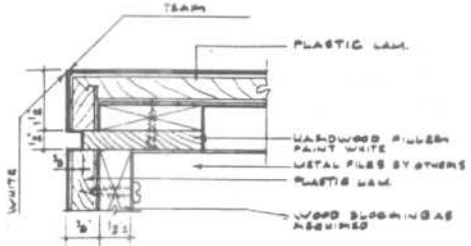
Fig. 9 Wall unit with overhead cabinets.



3 ISLAND UNIT  
3' 1" x 3' 1"



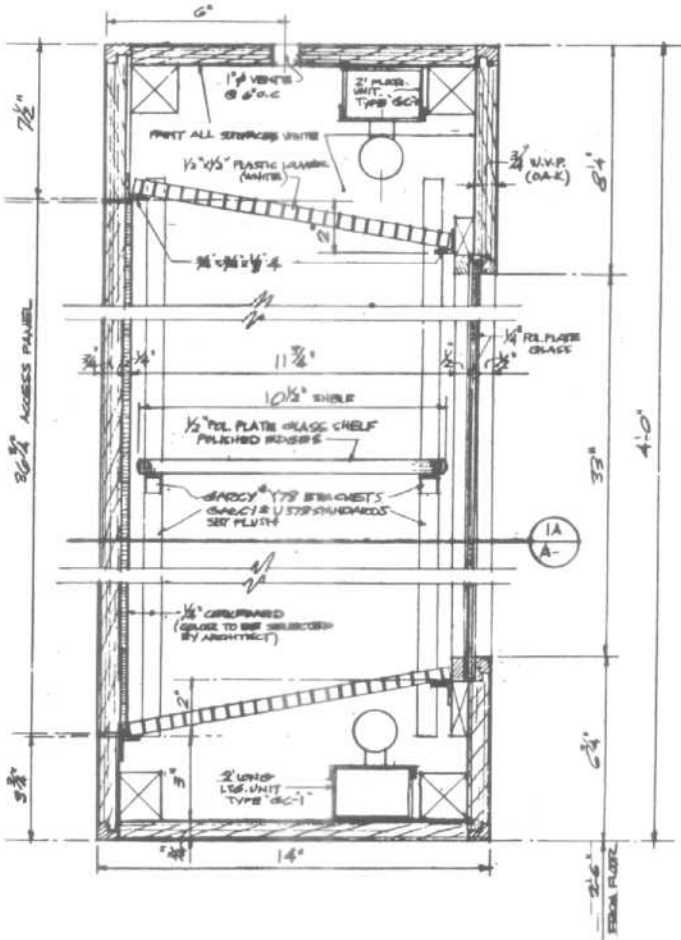
4 3' 1" x 1'-0"



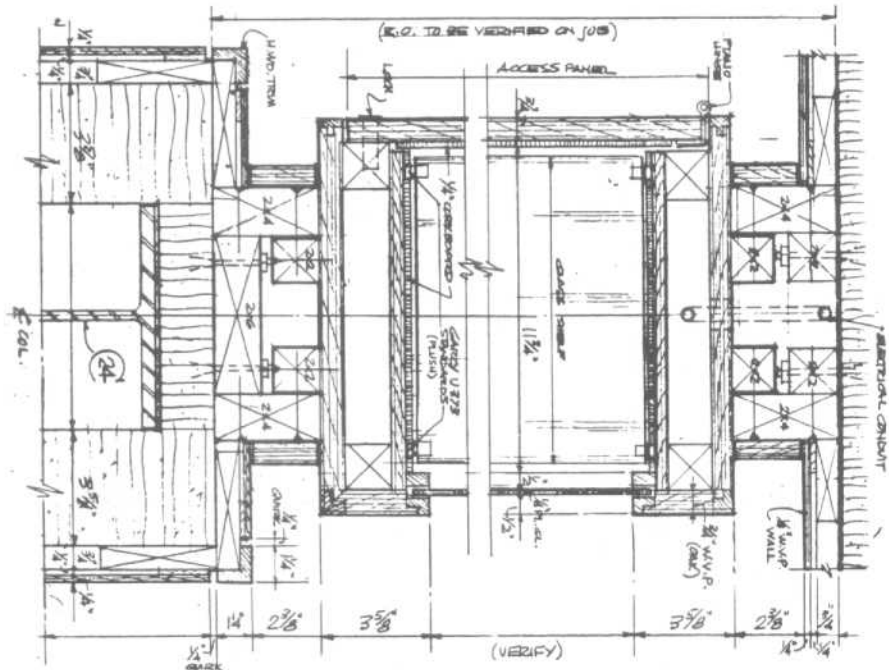
5 3' 1" x 1'-0"

Fig. 10 Free-standing island unit.





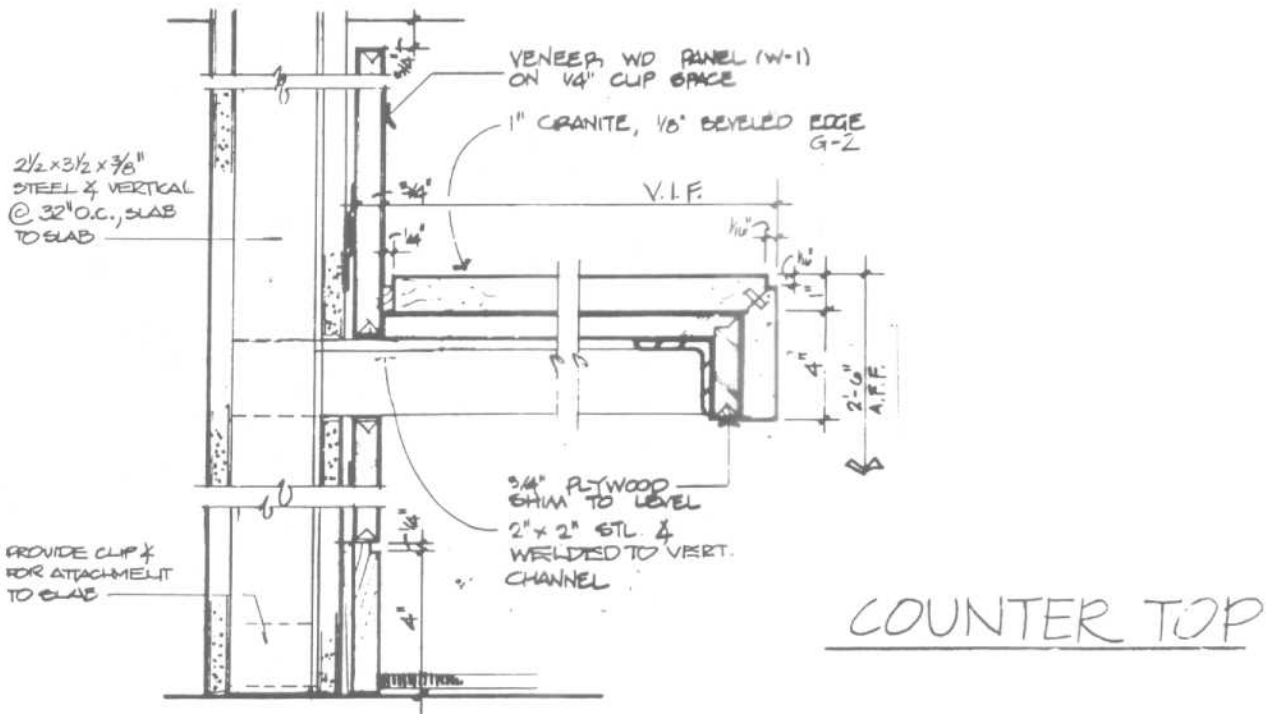
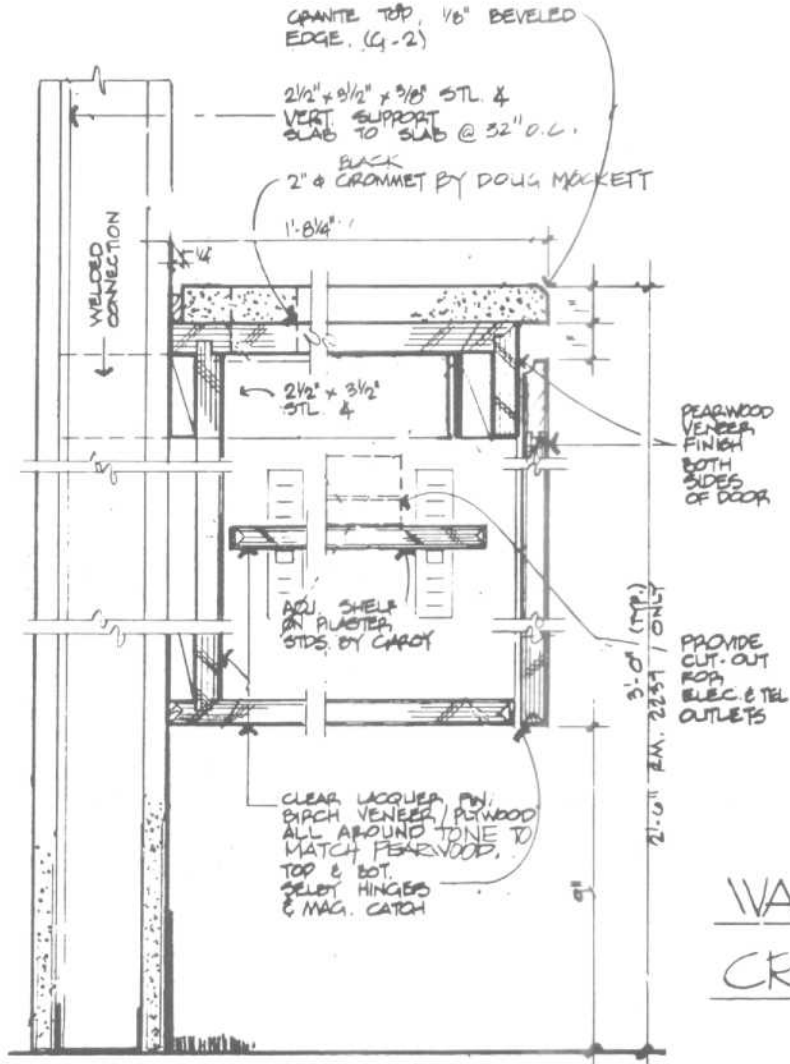
I LOBBY DISPLAY CABINET #1  
VERTICAL SECTION @ 3'-10"

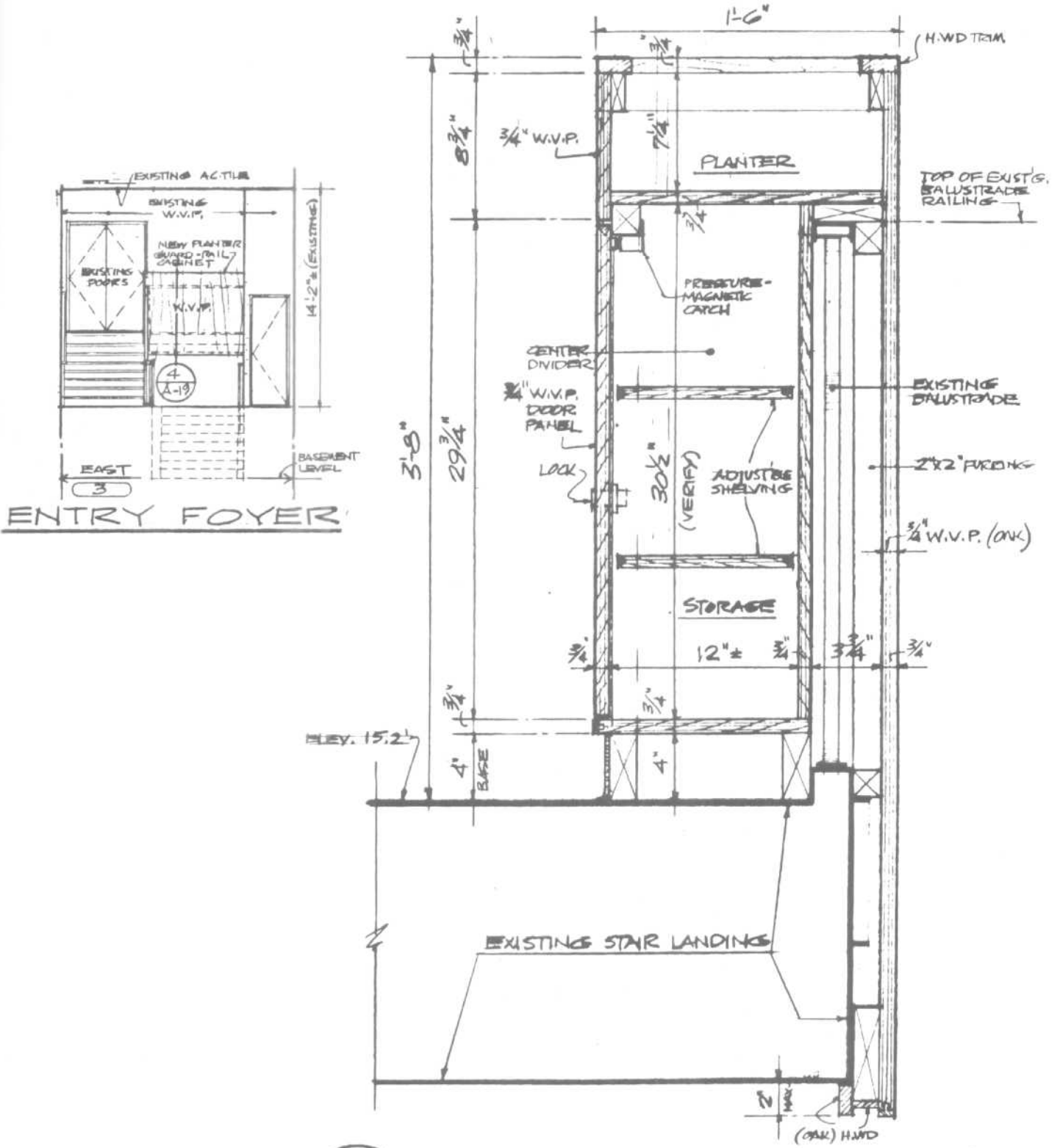


IA LOBBY DISPLAY CABINET #1  
HORIZONTAL SECTION @ 3'-10"

WOODWORK DETAILS

Credenza

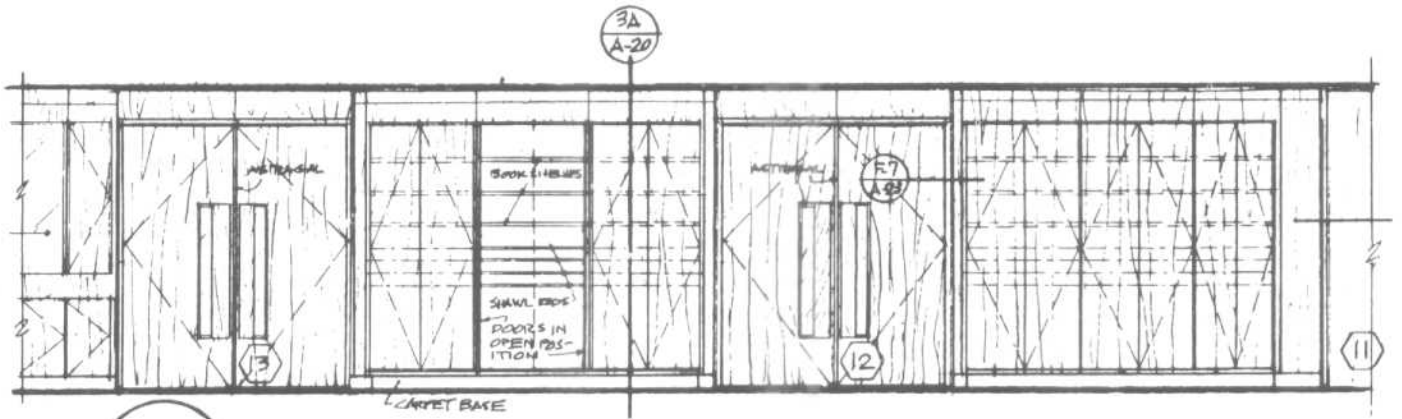




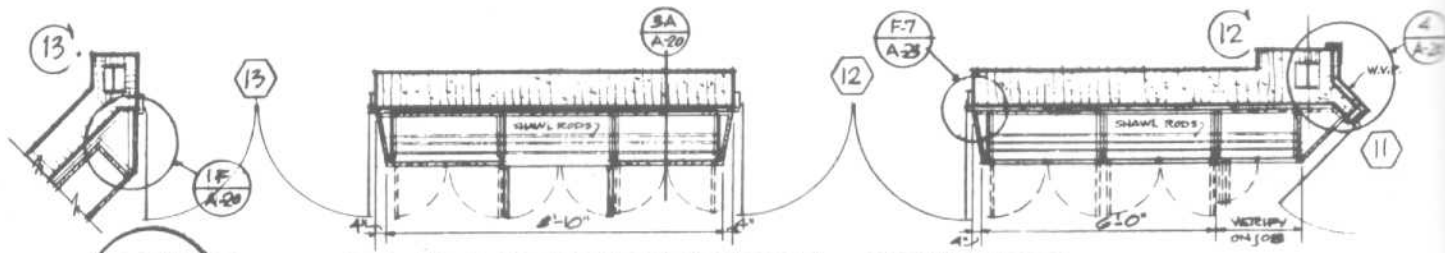
**4** SECTION THRU PLANTER-CABINET

WOODWORK DETAILS

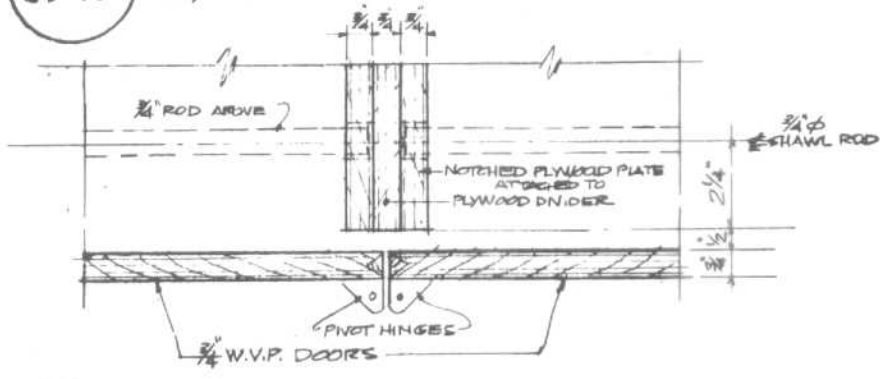
Book and Shawl Cabinet



**313** ELEVATIONS OF BOOK & SHAWL CABINETS  
 @ 1/4" = 1'-0"



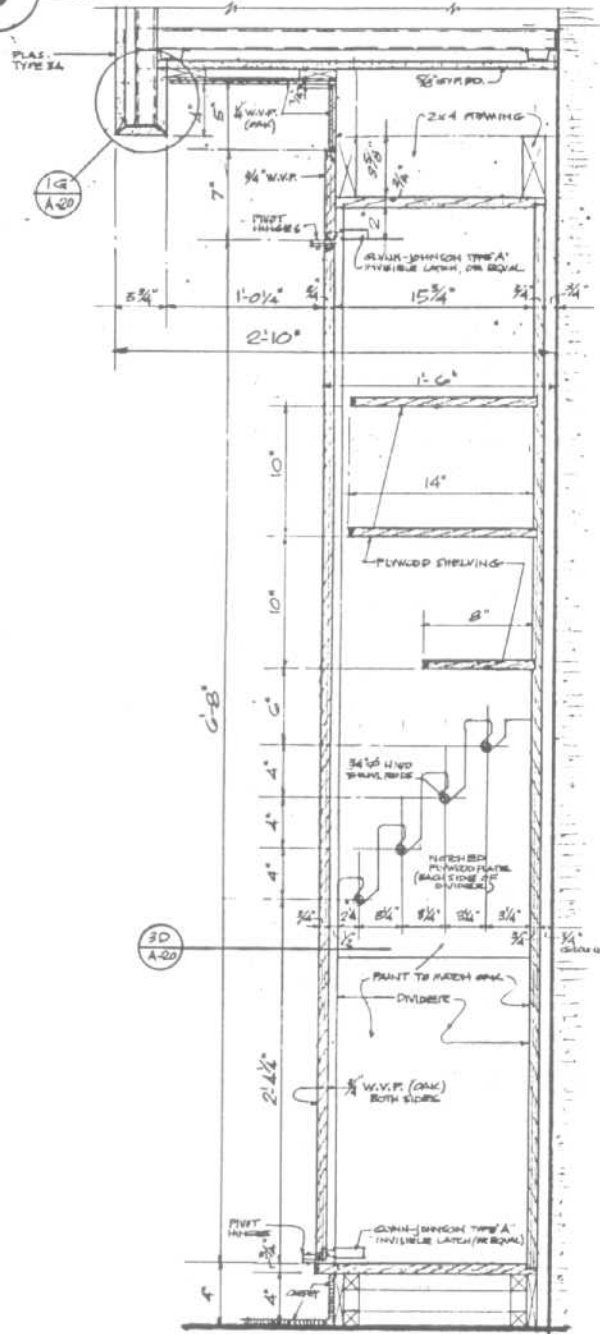
**310** PLAN OF BOOK & SHAWL CABINETS  
 @ 1/4" = 1'-0"



**311** TYPICAL STILE DETAIL  
 @ 3/4" = 1'-0" BOOK & SHAWL CABINETS

Fig. 11

### 3 BOOK & SHAWL CABINET DETAILS

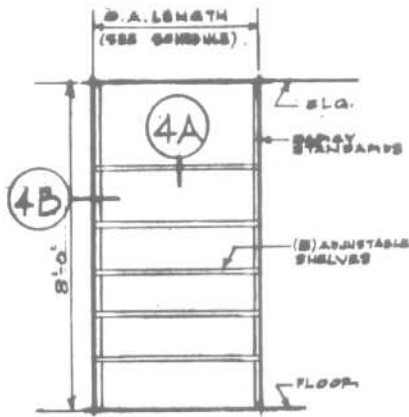


### 3A VERTICAL SECTION THRU BOOK & SHAWL CABINET

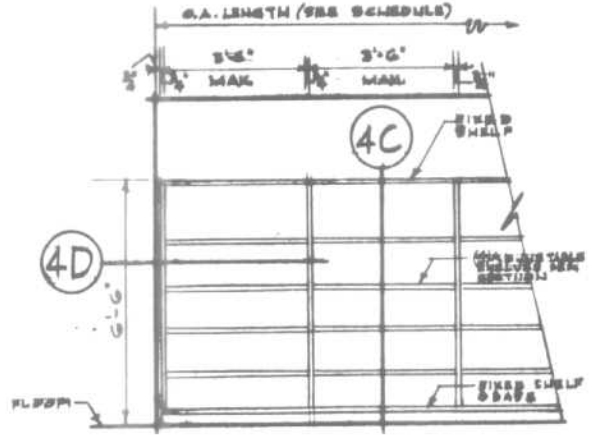
Fig. 11 (Continued)

WOODWORK DETAILS

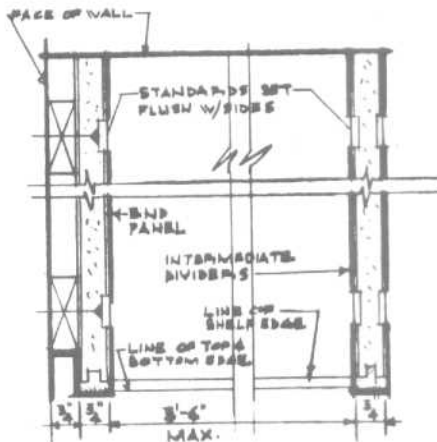
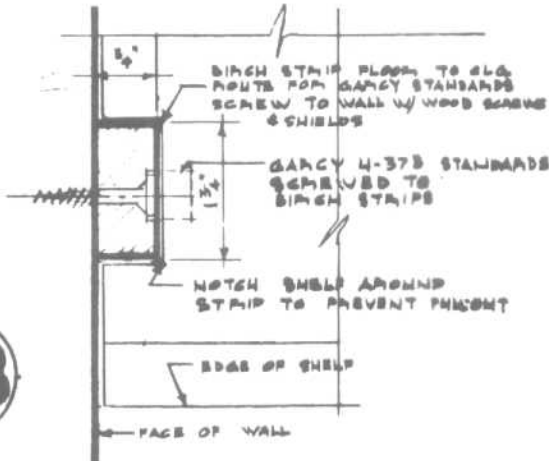
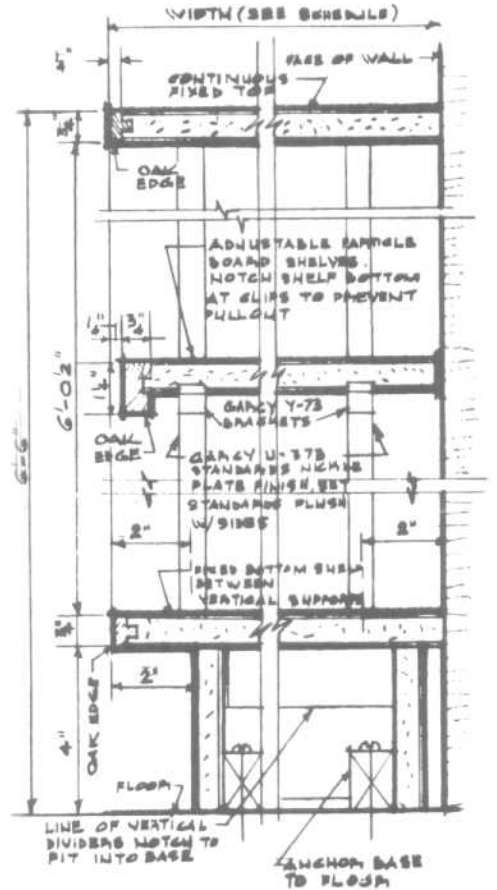
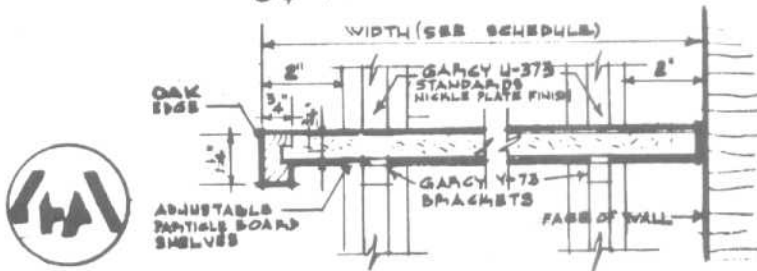
Storage Shelves



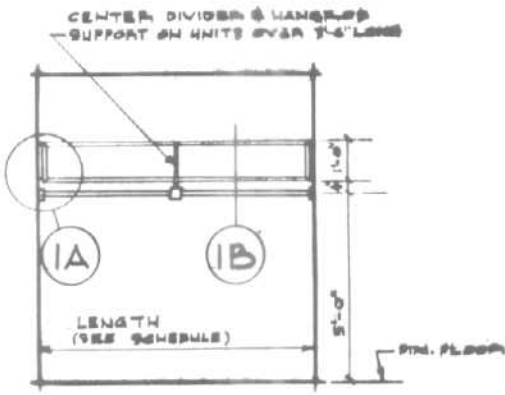
ELEVATION OF STORAGE CLOSETS 4'-0" OR LESS IN LENGTH @ 1/4" = 1'-0"



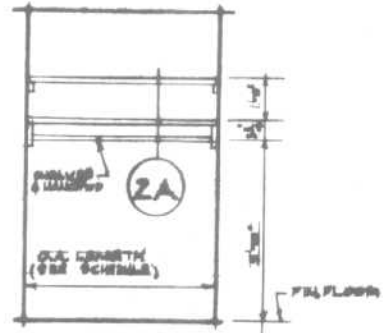
ELEVATION OF STORAGE CLOSETS OVER 4'-0" IN LENGTH @ 1/4" = 1'-0"



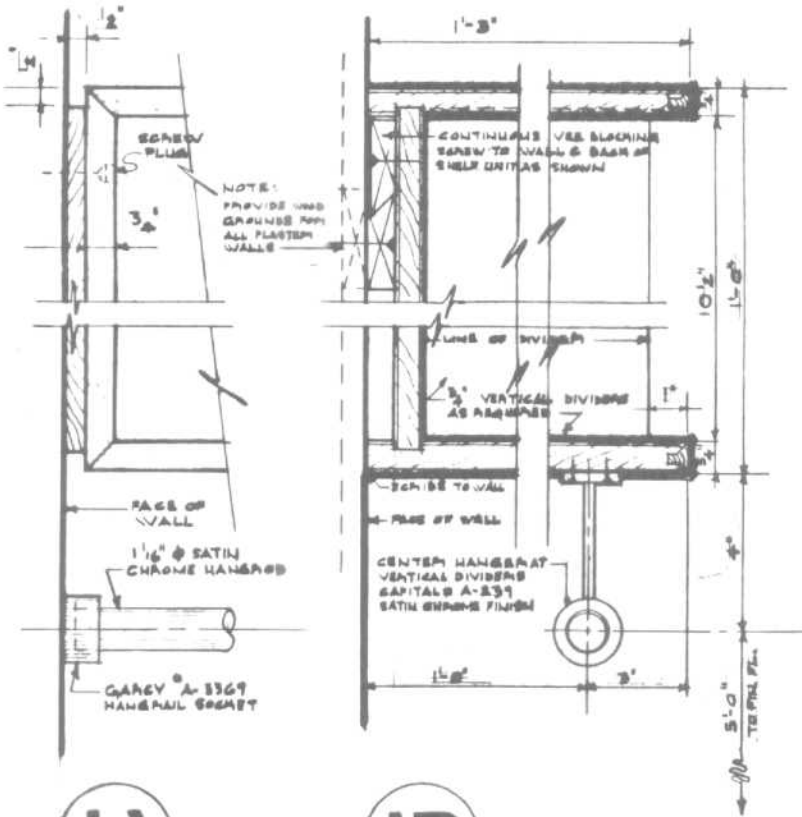
4C @ 3" = 1'-0"



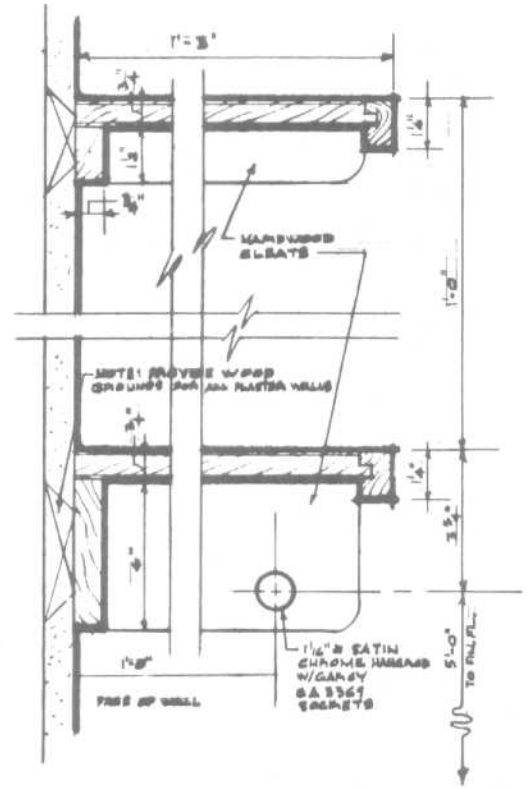
**ELEVATION OF UNIT**  
 @ 1/4" = 1'-0"



**ELEVATION OF UNIT**  
 @ 1/4" = 1'-0"

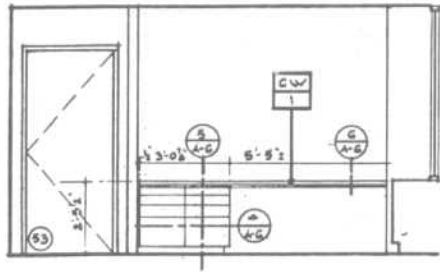


**IA** @ 3/8" = 1'-0"      **IB** @ 3/8" = 1'-0"

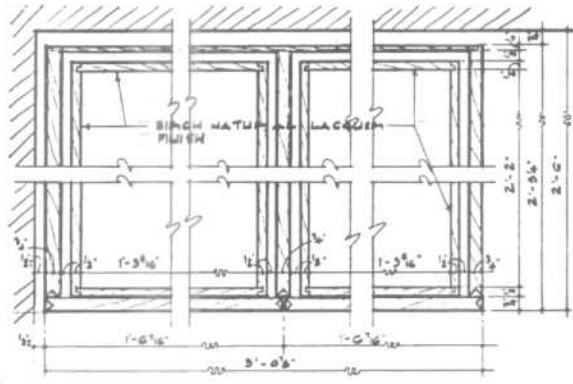


**2A** @ 3/8" = 1'-0"

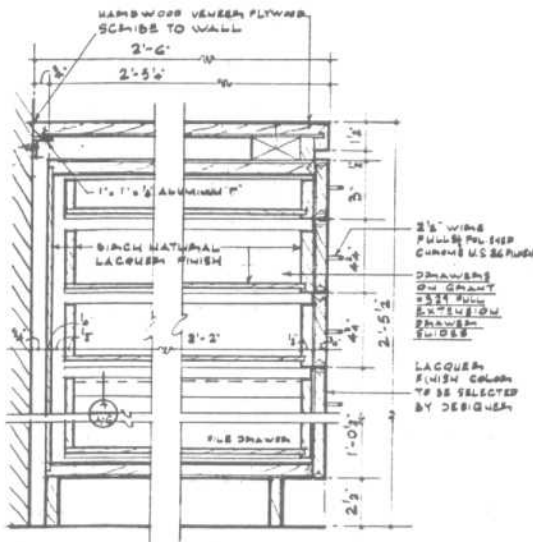
WOODWORK DETAILS



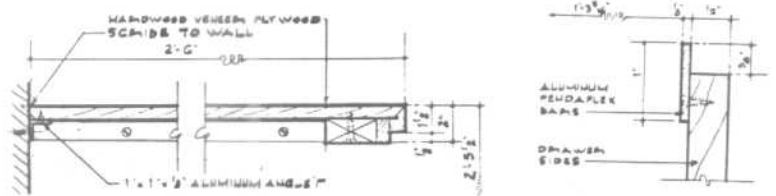
7 NORTH ELEVATION SPACE No. 19  
@ 1/2" 1'-0"



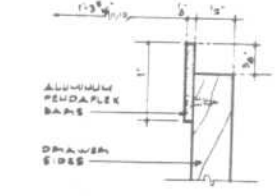
4 @ 3/4" 1'-0"



5 @ 3/4" 1'-0"

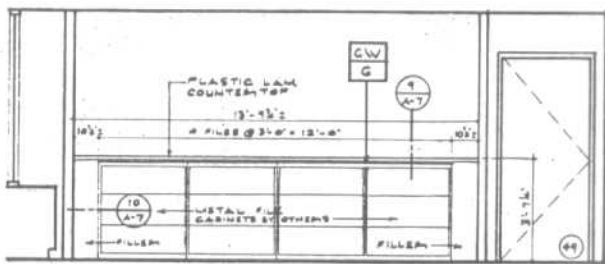


6 @ 3/4" 1'-0"

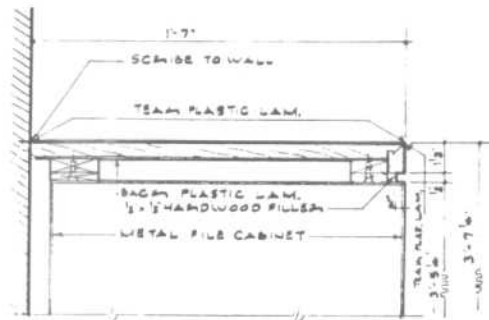


7 @ FULL SIZE

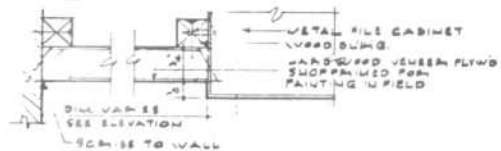
Fig. 12 Credenza.



4 NORTH ELEVATION SPACE No. 10  
@ 1/2" 1'-0"



9 @ 3/4" 1'-0"



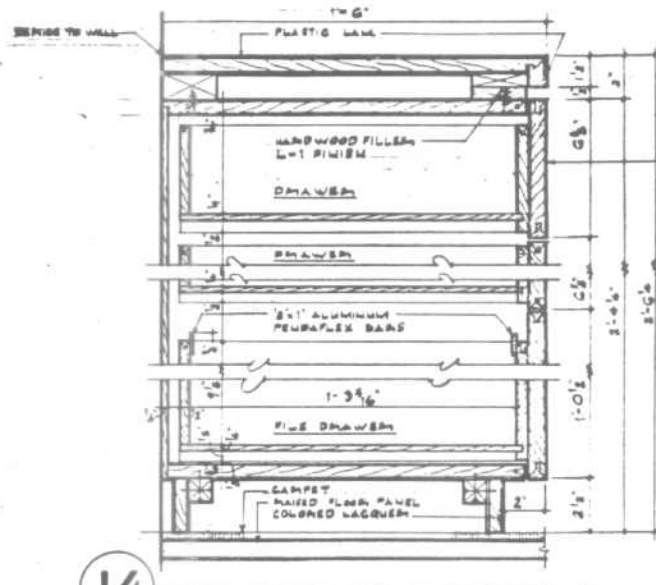
10 @ 1/2" FULL SIZE

Fig. 13 File countertop.



WOODWORK DETAILS

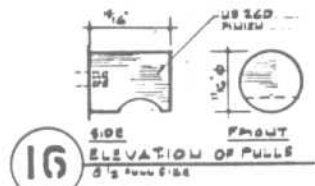
Base Cabinets



14

@ 3' x 1'-0"

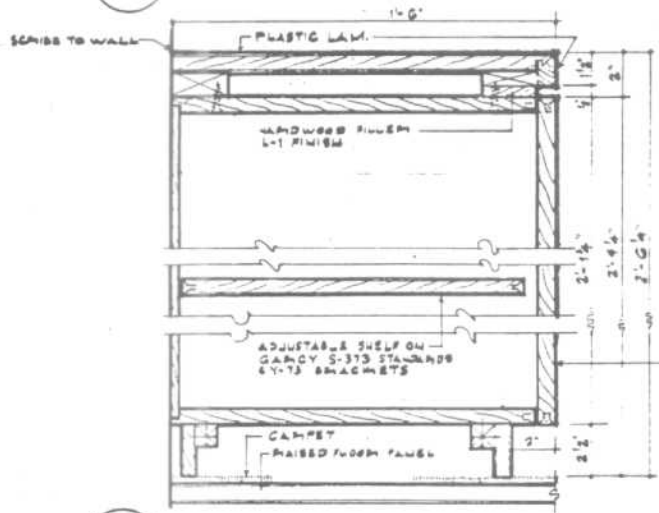
COLORED LACQUER FINISH



16

NOTES:

- 1. LOWER DRAWERS SHALL HAVE GRANT 338 FULL EXTENSION DRAWER SLIDES
- 2. FILE DRAWER SHALL HAVE GRANT 321 FULL EXTENSION DRAWER SLIDES



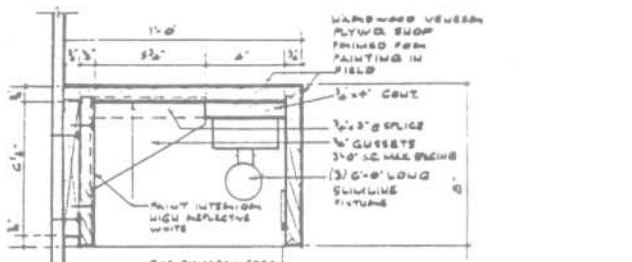
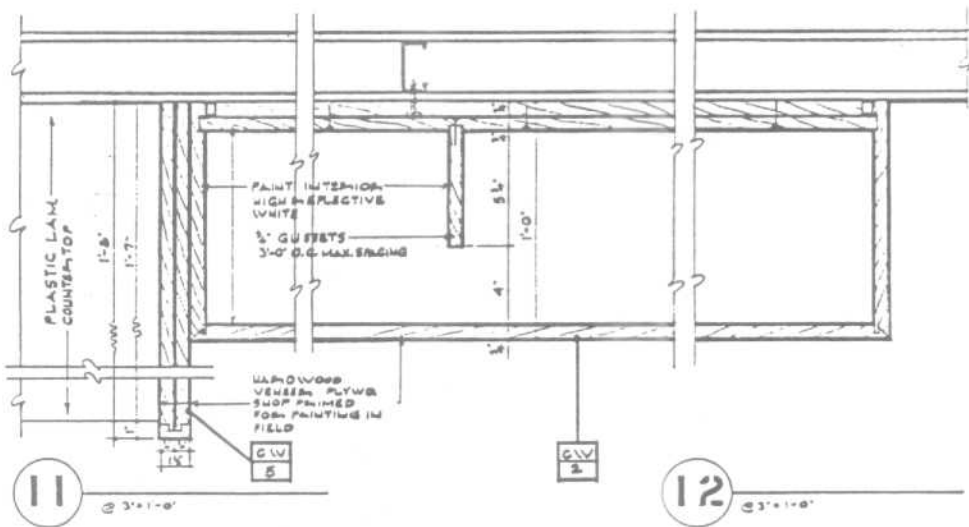
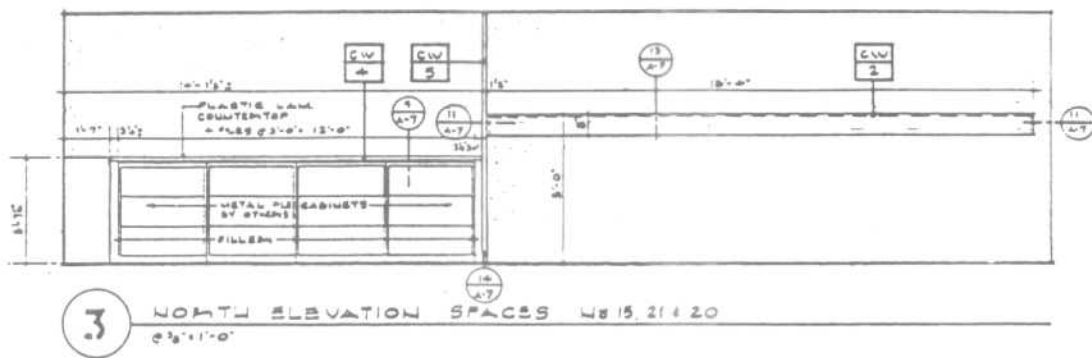
15

@ 3' x 1'-0"

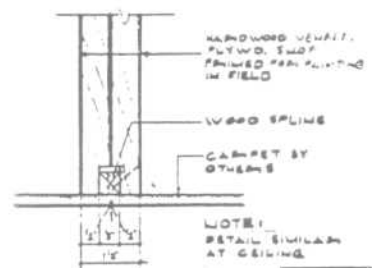
ALL PLASTIC LAMINATE FOR THESE ITEMS TO BE: PLYWOOD # 81202# INDIA TEAM

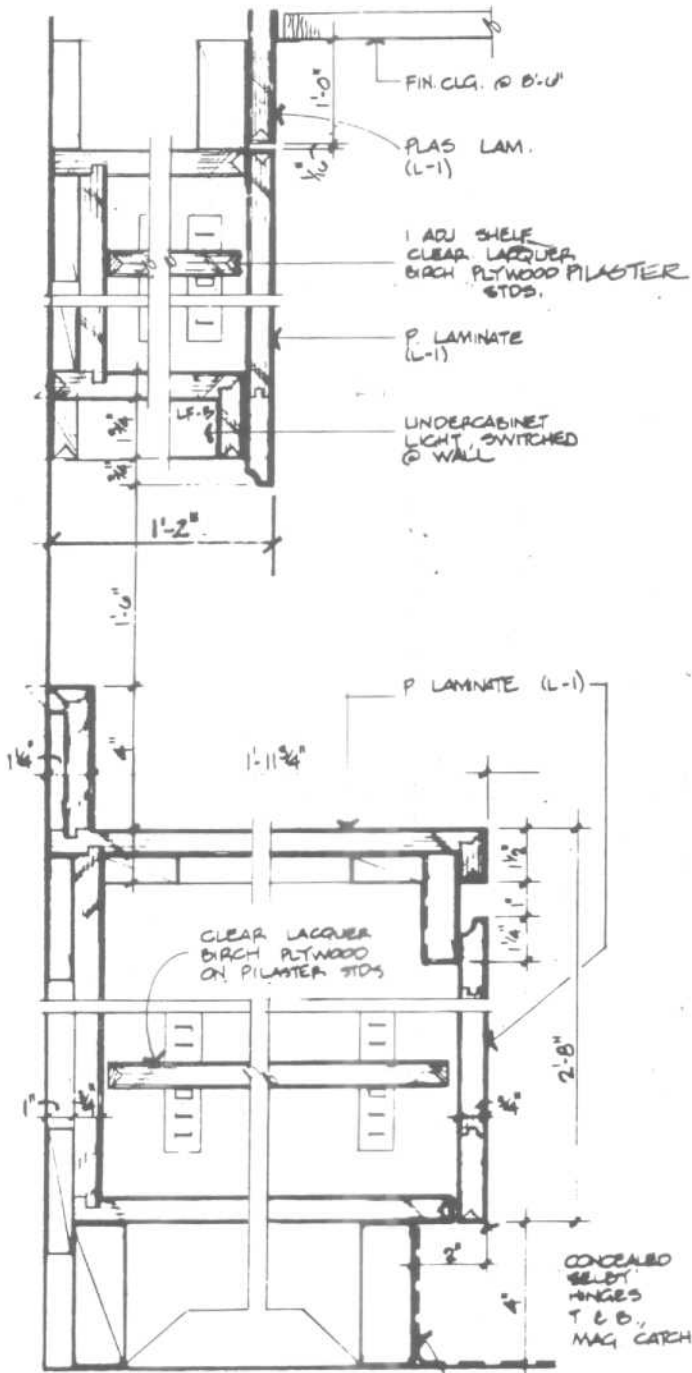
ALL INTERIORS TO HAVE NATURAL LACQUER FINISH

COLORED LACQUER DOORS W/ PIVOT HINGES



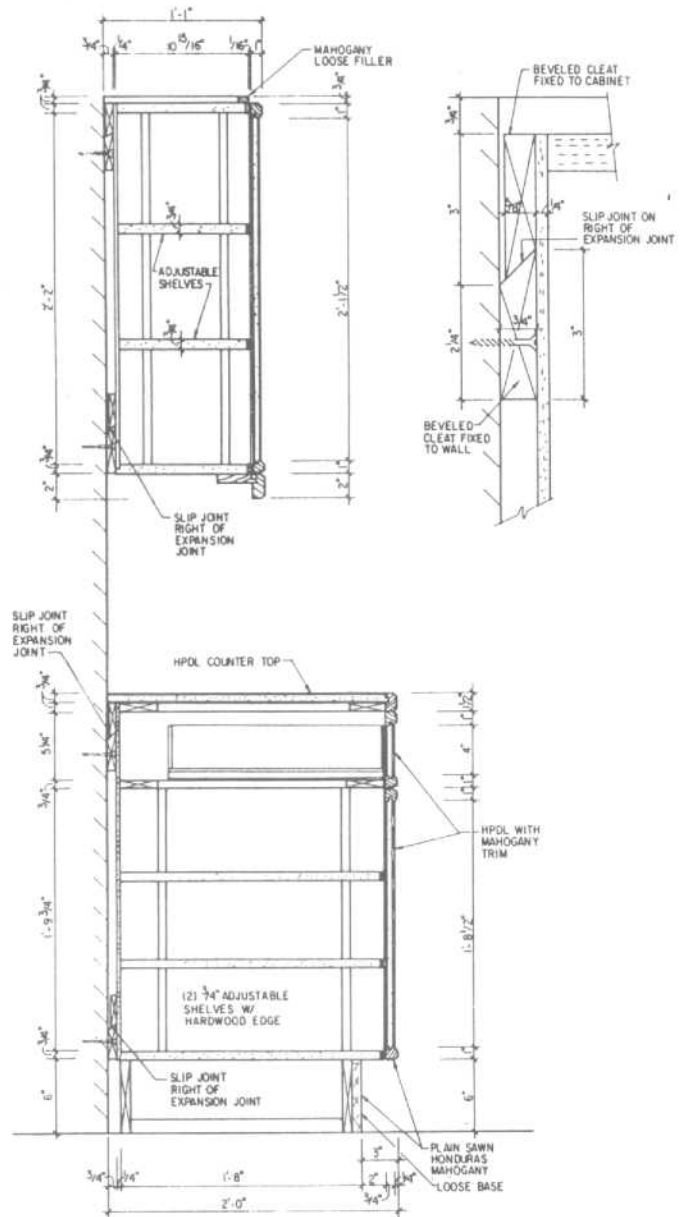
NOTE:  
 C.V. 2 & C.V. 5 SHALL BE  
 PAINTED W/ MATTE LAMBERT  
 # C134 TIGER LILY SEMI-GLOSS





NOTE: SEE 9/18-1 FOR CABINET WITH DRAWER

CERAMIC TILE @ TILE FLOOR OR VINYL BASE @ VCT FLOOR



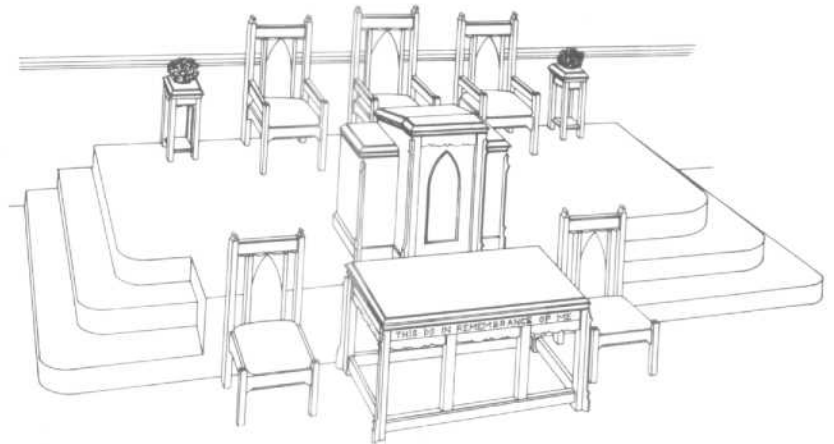
VERTICAL SECTION-PANTRY CABINETS

PANTRY CABINETS

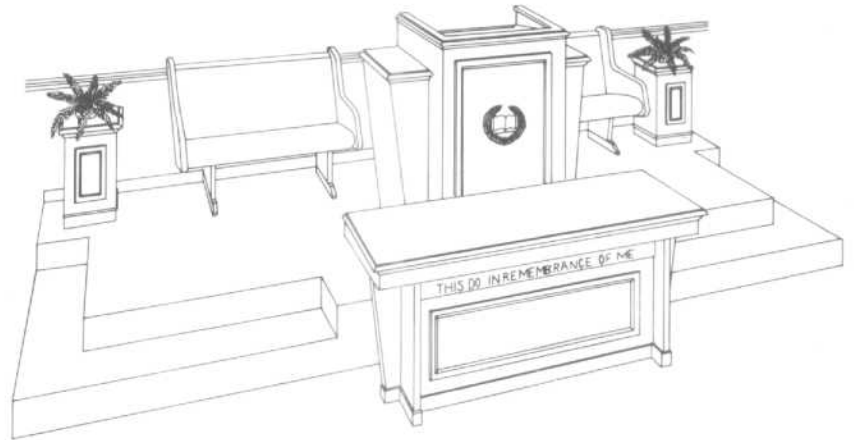
WOODWORK DETAILS

Altars

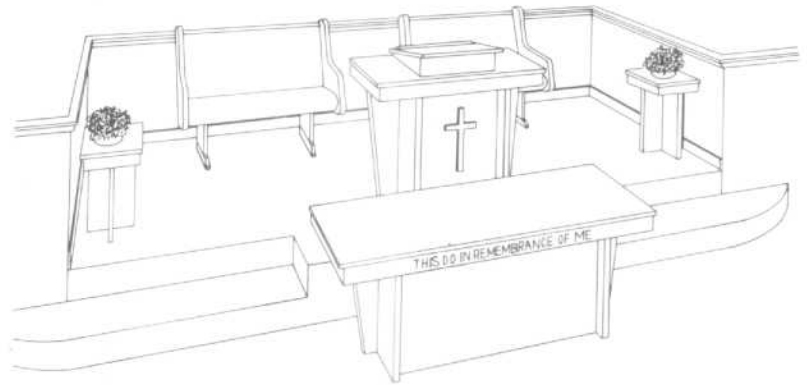
- Pulpit  
3'9" High x 3'6" Wide x 1'8½" D
- Table  
2'7" High x 5'0" Long x 2' D
- Center Pulpit Chair  
4' High x 2'2½" Wide x 1'10" D
- Side Pulpit Chair  
3'9" High x 2'2½" Wide x 1'10" D
- Communion Chair  
3'4" High x 1'8½" Wide x 1'7½" D
- Flower Stand  
2'6" High x 1'3" Square



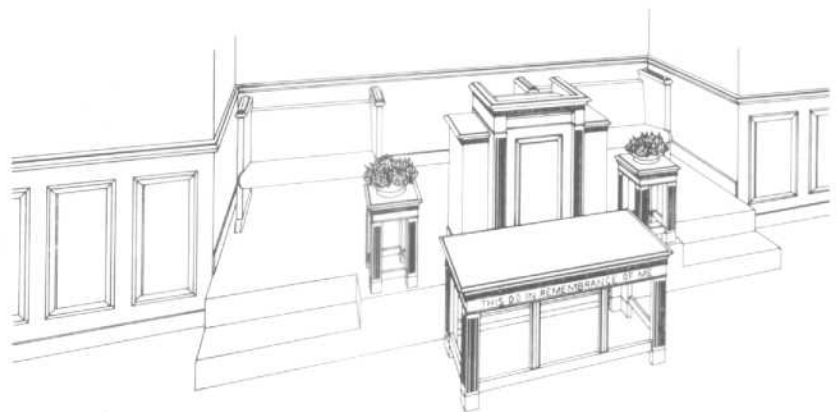
- Pulpit  
4'0" High x 3'6" Wide x 1'8" D
- Table  
2'9" High x 6'0" Long x 2'0" D
- Flower Stand  
2'0" High x 1'2" Square



- Pulpit  
3'9" High x 3'4" Wide x 1'8" D
- Table  
2'9" High x 6'0" Long x 2'0" D
- Flower Stand  
2'0" High x 1'2" Square
- Clergy Pew End



- Pulpit  
4'0" High x 3'8" Wide x 1'9" D
- Table  
2'9" High x 4'6" Long x 2'0" D
- Flower Stand  
2'0" High x 1'2" Square
- Clergy Pew End



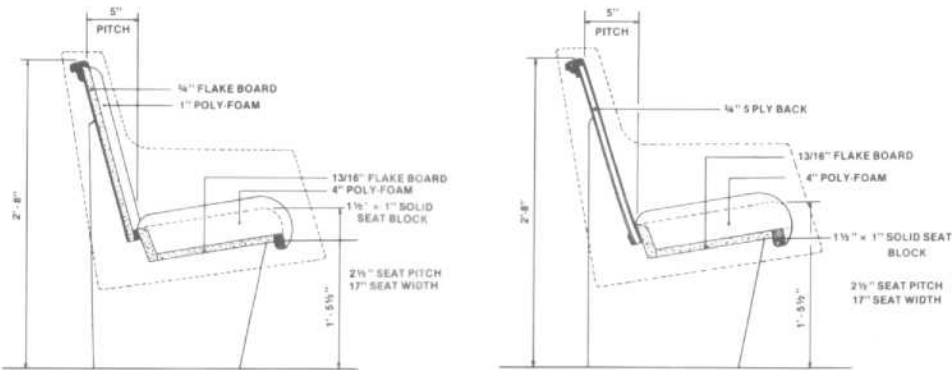
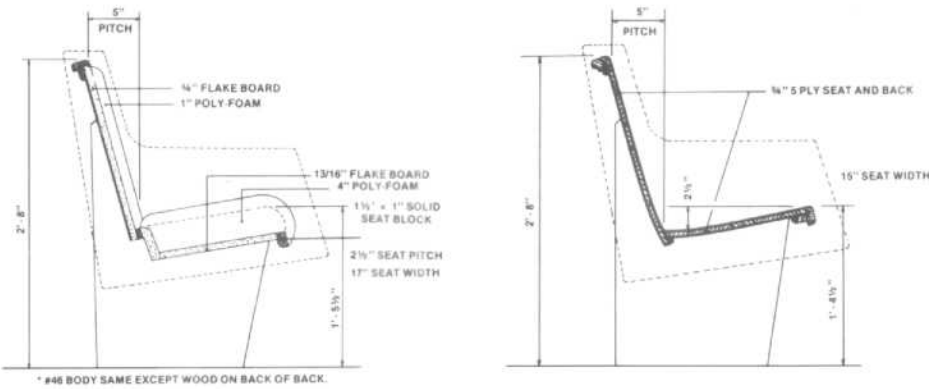


Fig. 15 Fully upholstered seat. All exposed surfaces of the seat and back are fully upholstered.



\* #46 BODY SAME EXCEPT WOOD ON BACK OF BACK.  
 Fig. 16 Combination upholstered/wood seat. An upholstered seat with a wooden back (either solid or veneer laminate).

Fig. 17 All wood seat. Either solid wood or veneered seat and back. Generally the most expensive option. Wood seats and back can be contoured for increased comfort.

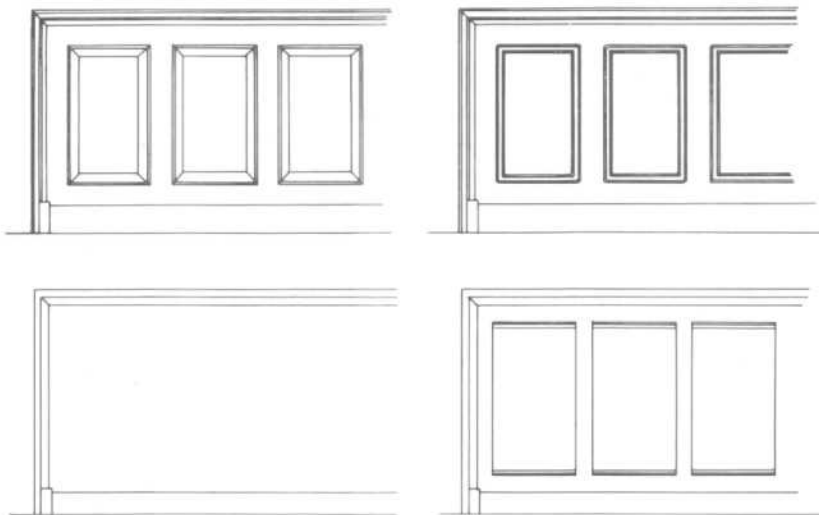
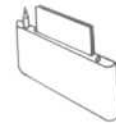


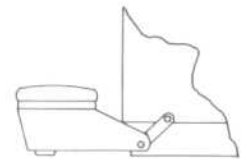
Fig. 19 Screens are adaptable for many uses in the sanctuary. They serve as modesty screens in front of the first row of pews, or they can be adapted for use as communion rails, as choir boxes, or as wainscoting.



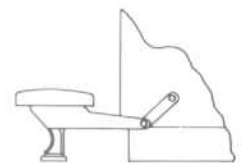
Cup holder



Card and pencil holder



Wood, with bonded foam, upholstered pad

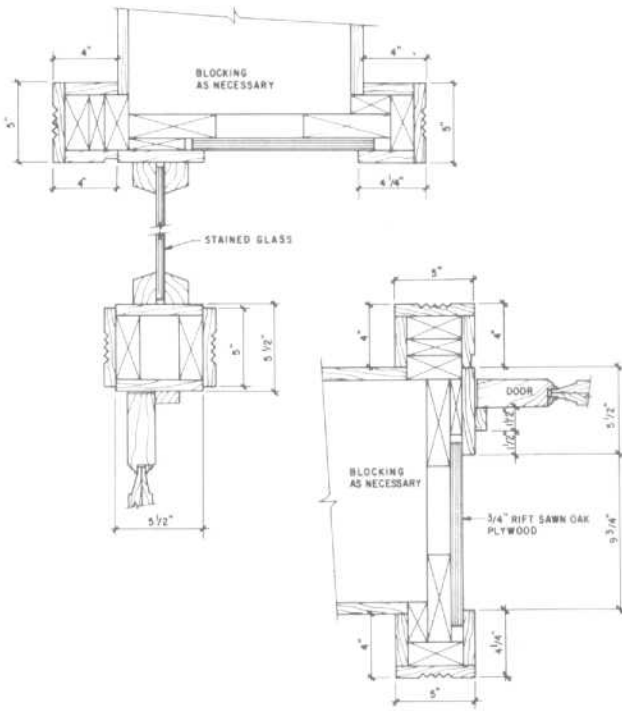


Metal, with bonded foam, upholstered pad

Fig. 18 Pew accessories.

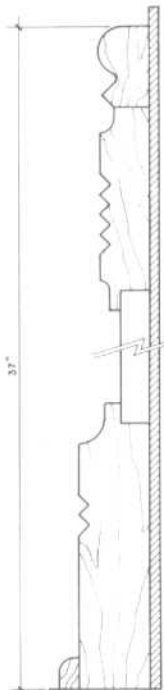
WOODWORK DETAILS

Sanctuary Doors and Miscellaneous Details

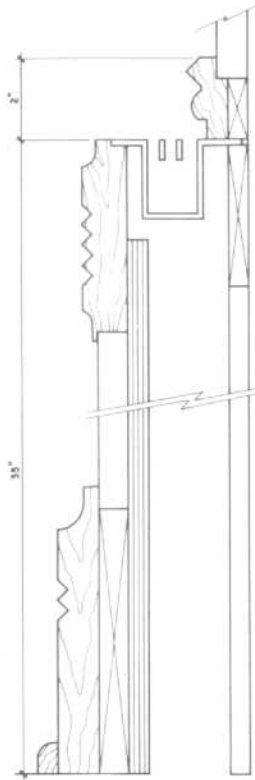


ELEVATION - SANCTUARY DOORS

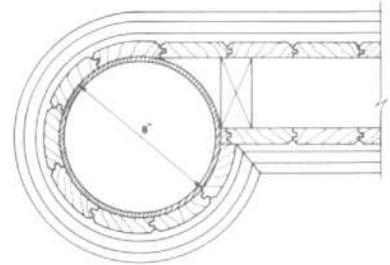
SECTIONS - SANCTUARY DOORS



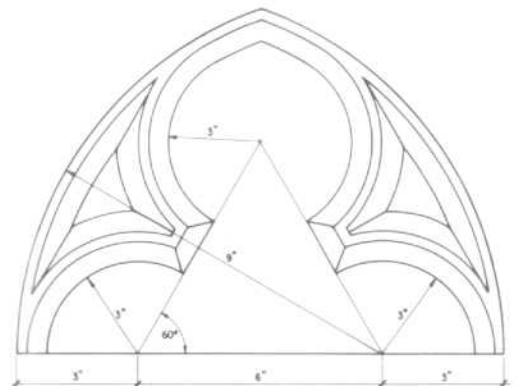
SECTION AT SANCTUARY COLUMN



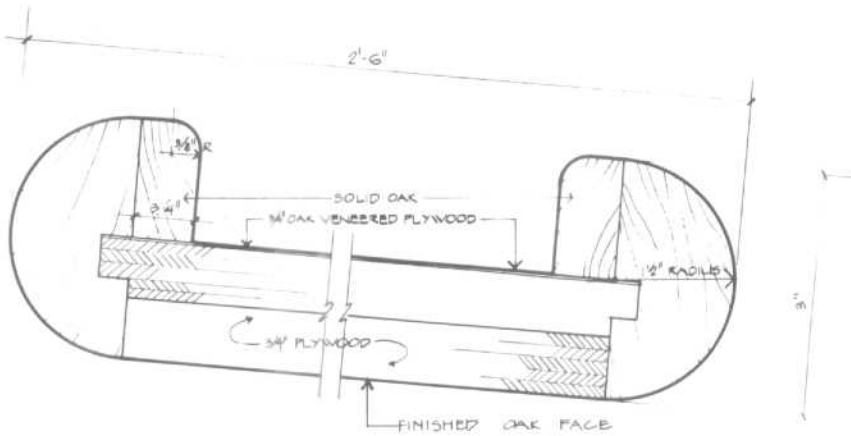
SECTION AT WAINSCOT



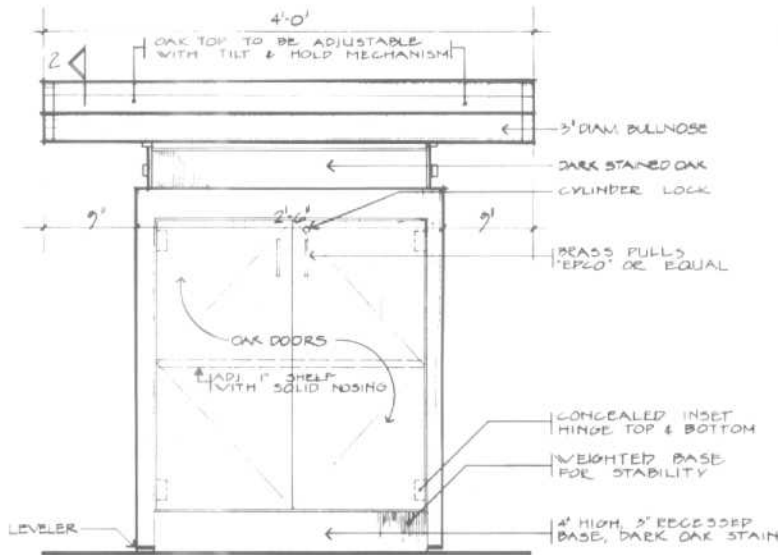
PLAN AT INTERSECTION OF CHANCEL RAIL AND COLUMN



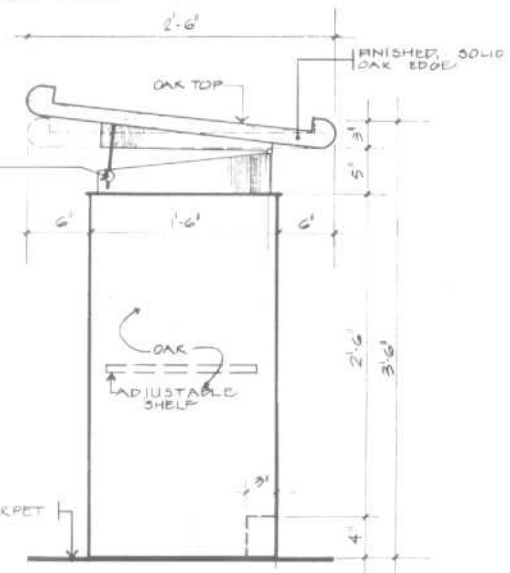
TREFOIL LAYOUT



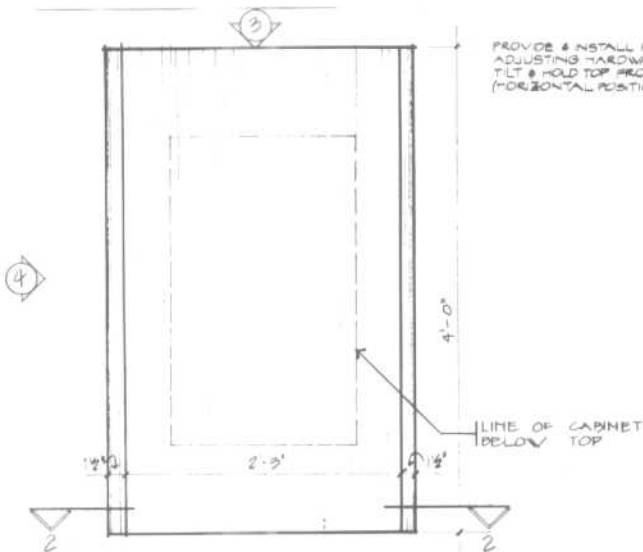
2 FULL SIZE SECTION THRU BIMAH TOP



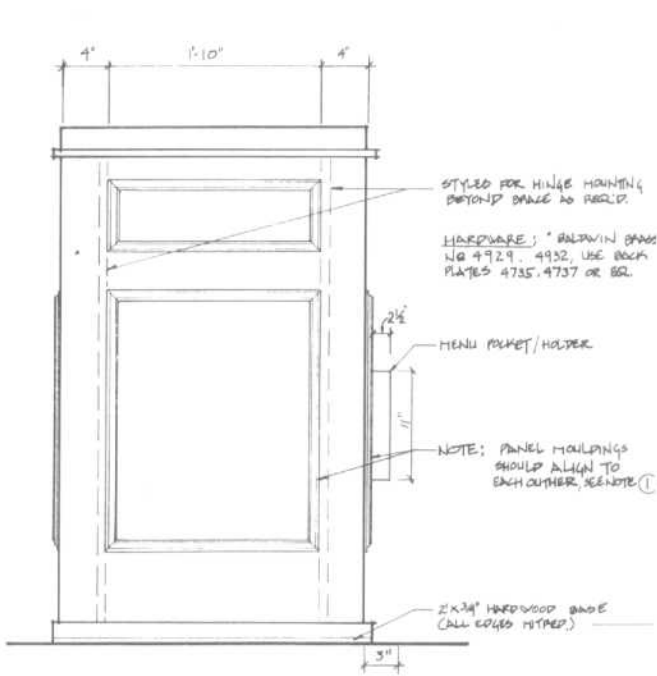
4 FRONT ELEVATION (EAST SIDE)  
SCALE: 1/2" = 1'-0"



3 SIDE ELEVATION (SOUTH SIDE)  
SCALE: 1/2" = 1'-0"

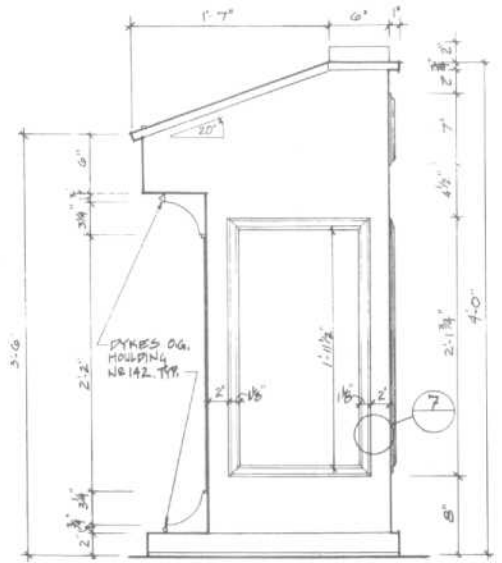


1 PLAN OF BIMAH TOP  
SCALE: 1/2" = 1'-0"



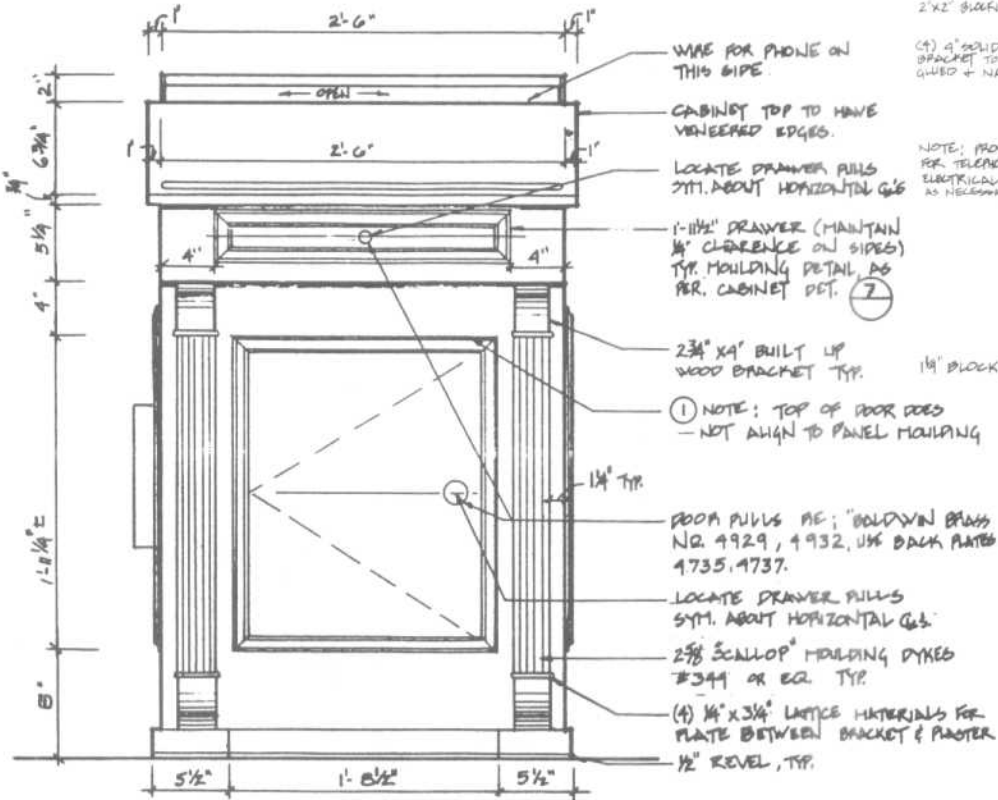
ELEVATION FRONT VIEW

5



ELEVATION SIDE

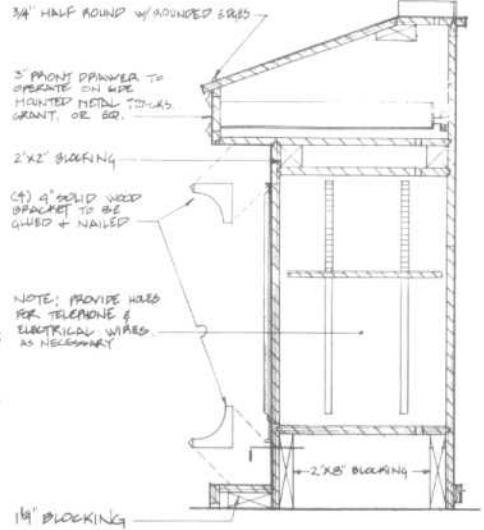
2



ELEVATION BACK VIEW

1

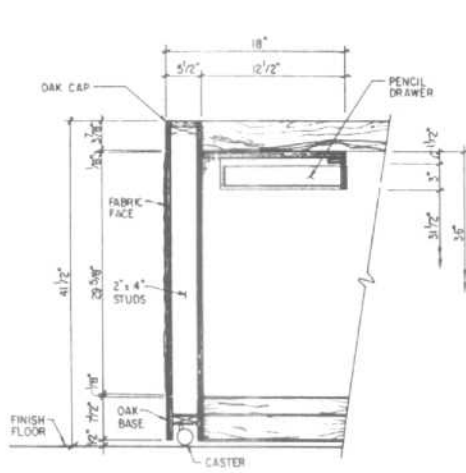
ALL EXTERNAL CORNERS TO BE MITERED. ALL JOINTS TO BE GLUED.



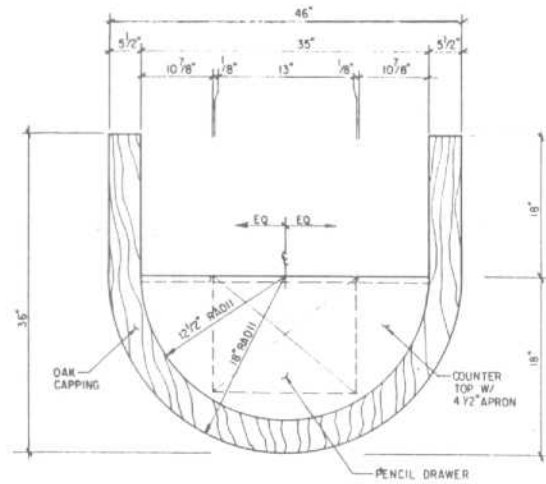
SECTION

3

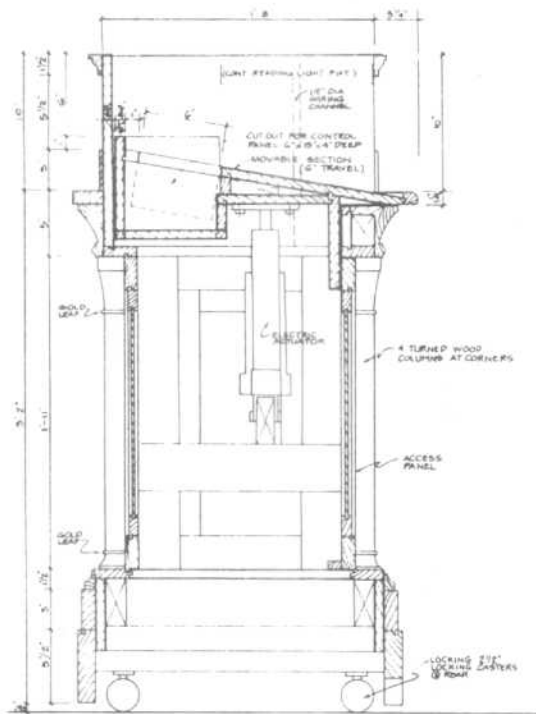




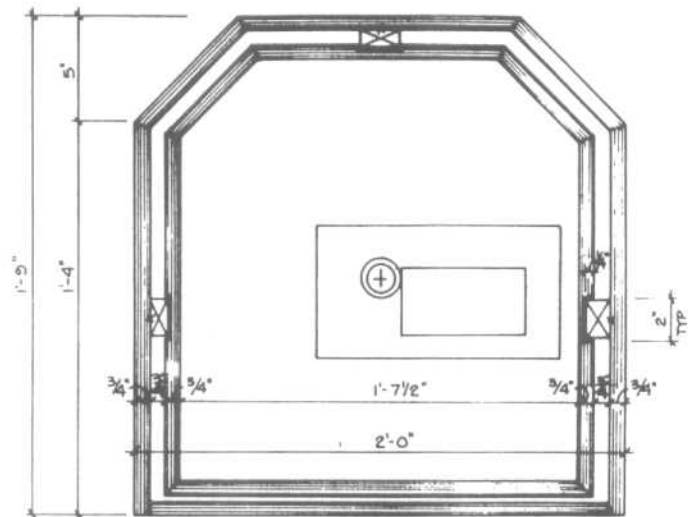
SECTION VIEW THRU  
LECTERN STANDS



PLAN VIEW OF LECTERN STANDS



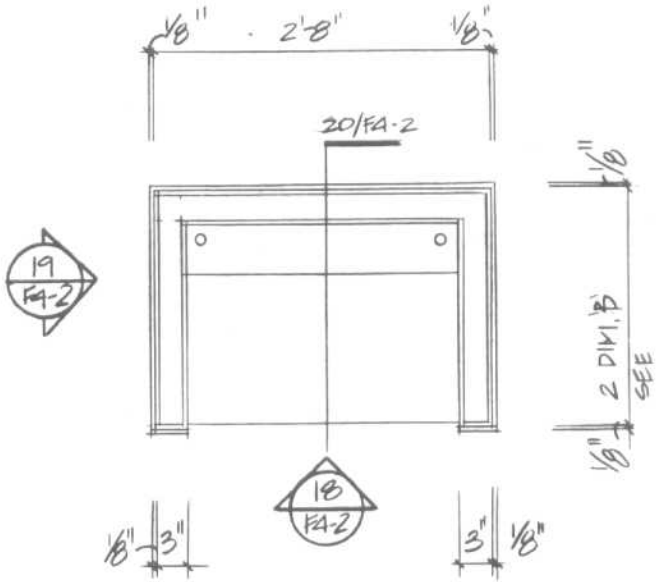
CROSS SECTION @ PODIUM



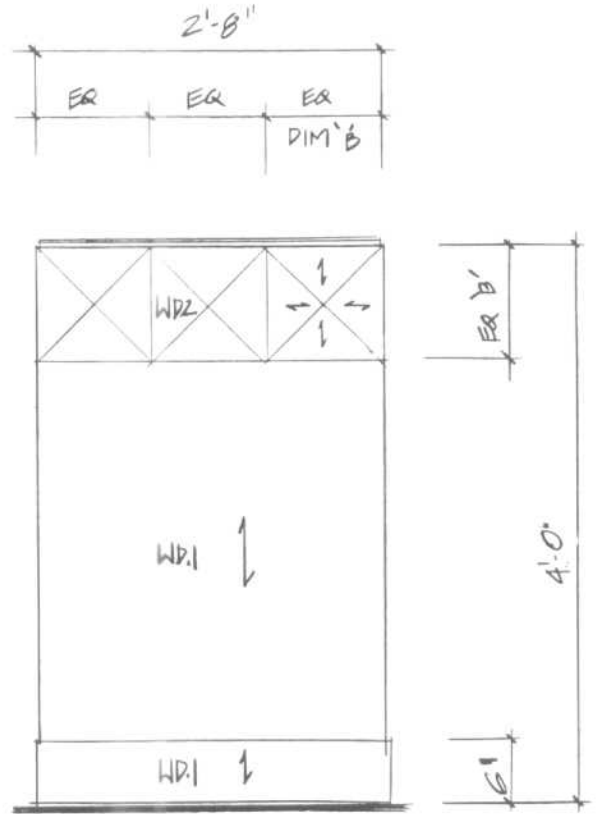
PLAN SECTION

WOODWORK DETAILS

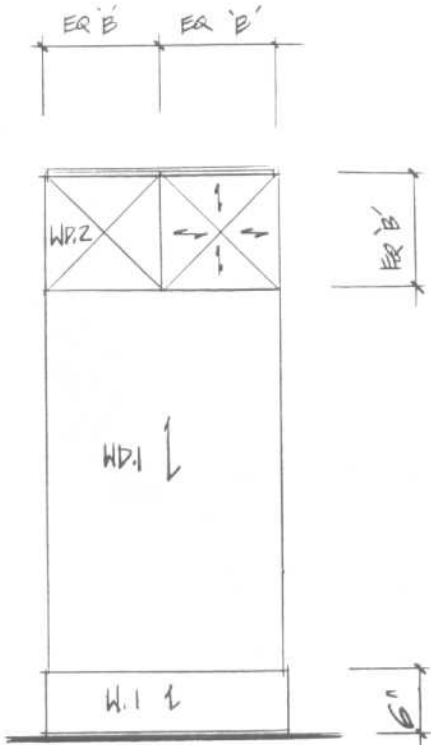
Lectern



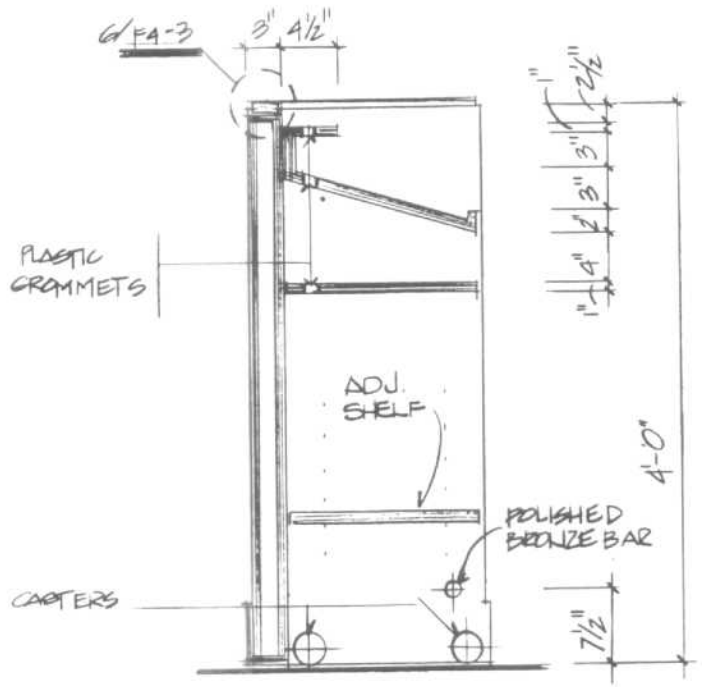
17 LECTURN  
F4-2 PLAN



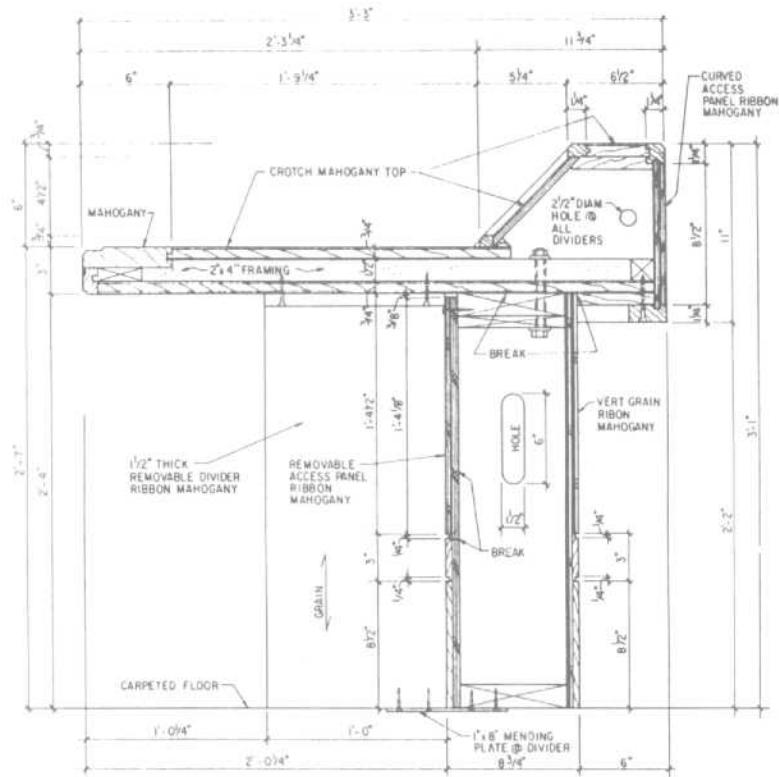
18 FRONT VIEW  
F4-2



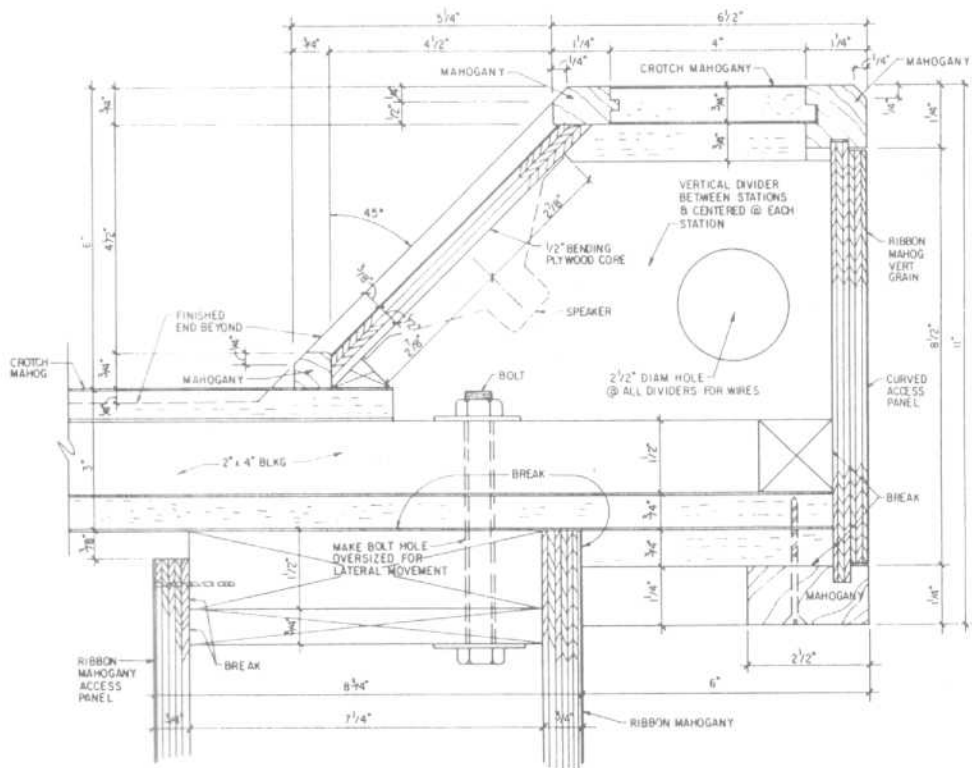
19 M. 317 SIDE VIEW  
F4-2



20 M. 317 SECTION  
F4-2



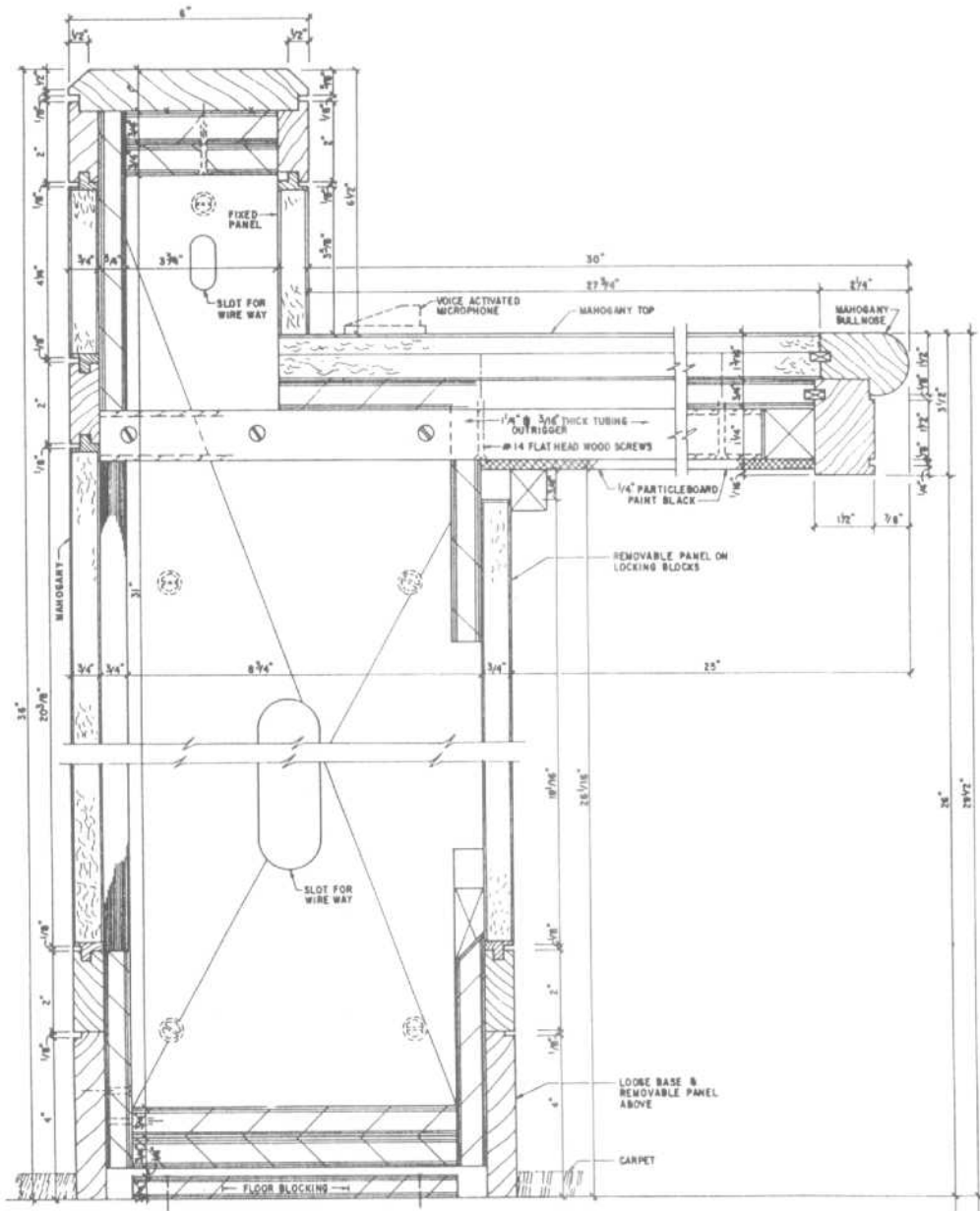
VERTICAL SECTION- BOARDROOM TABLE



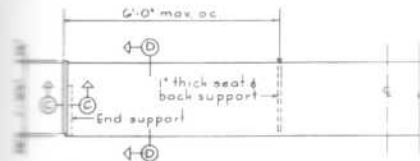
SECTION

WOODWORK DETAILS

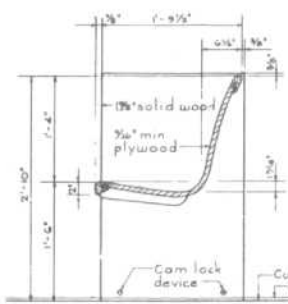
Boardroom Table



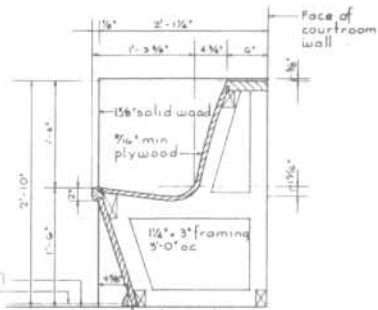
CROSS SECTION AT BOARDROOM TABLE



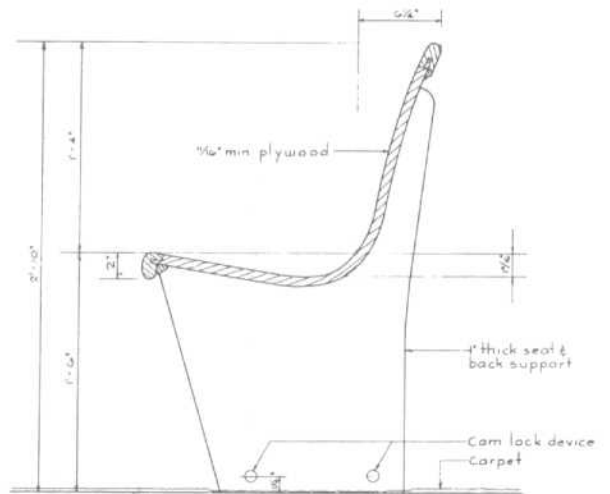
PARTIAL PLAN OF BENCH



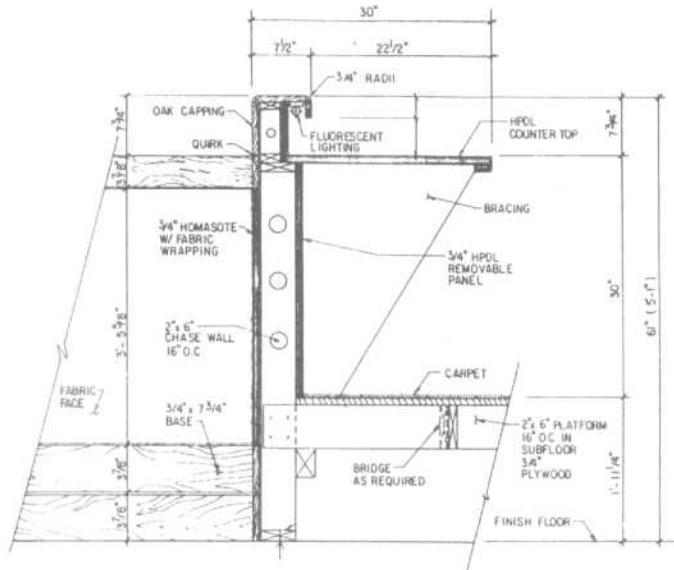
SECTION D - D



TYPICAL SECTION THRU REAR BENCH



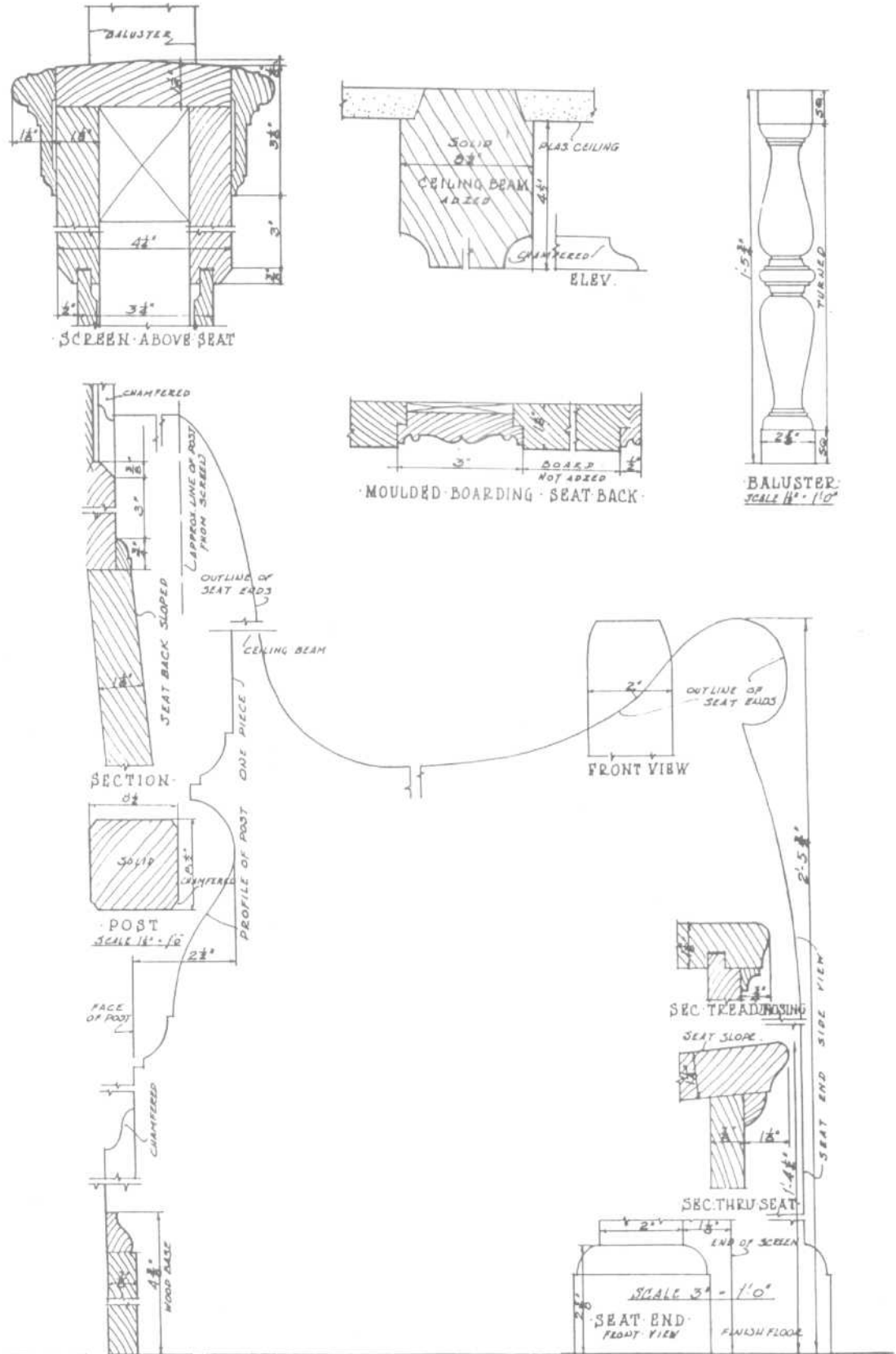
SEAT AND BACK SUPPORT



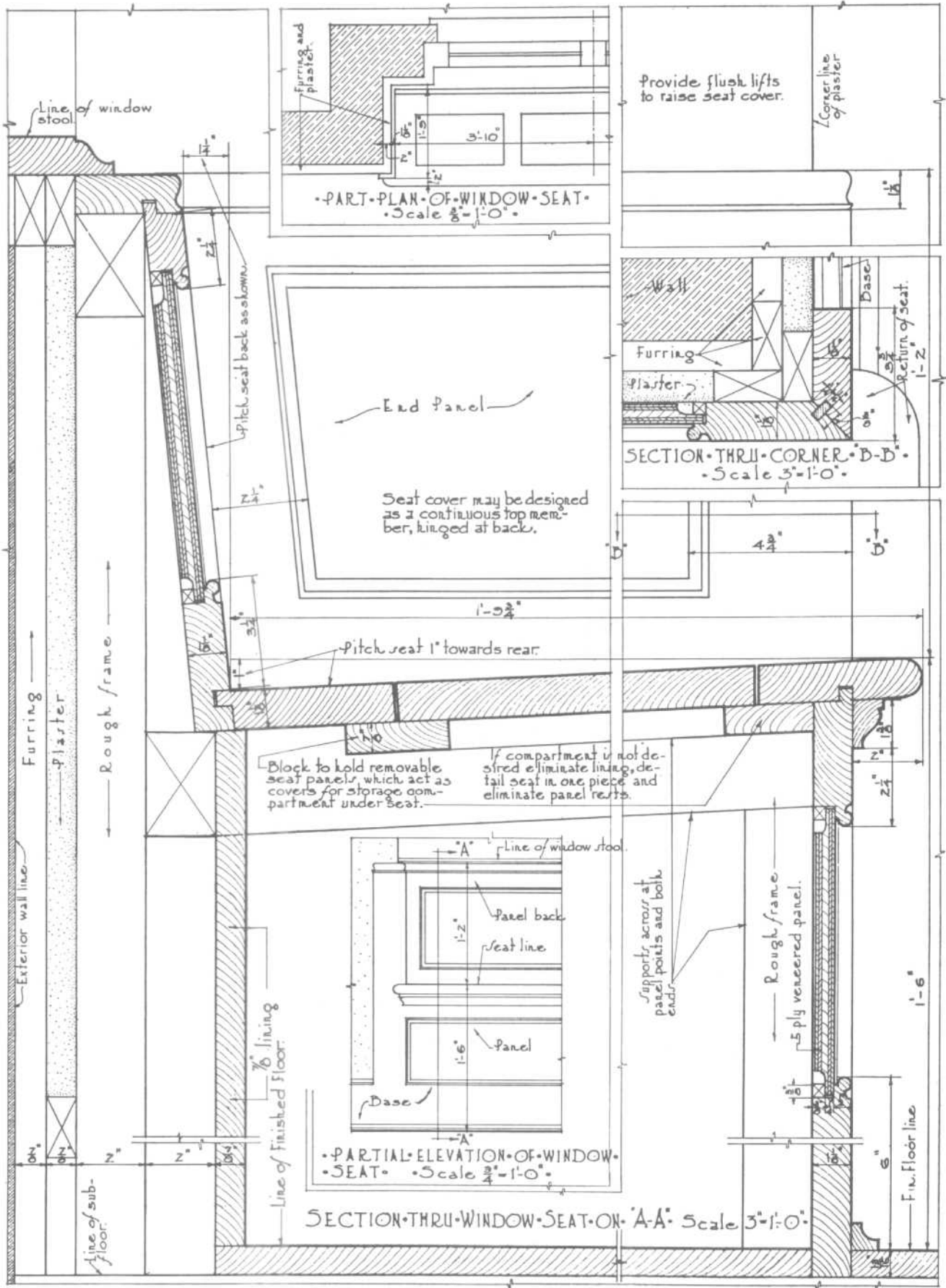
SECTION THRU JUDGES BENCH

WOODWORK DETAILS

Stair Screen and Seat

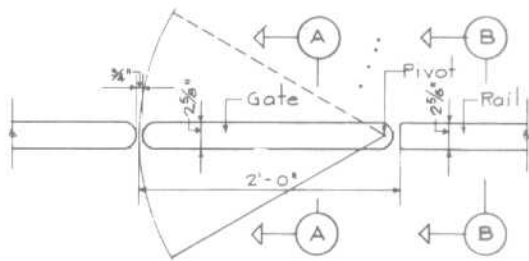


DETAIL OF STAIR SCREEN & SEAT MAIN HALL

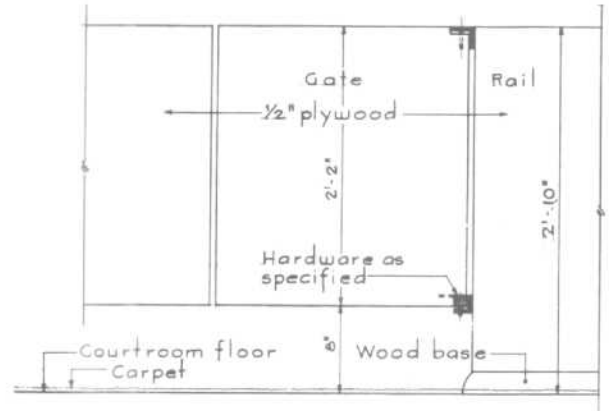


WOODWORK DETAILS

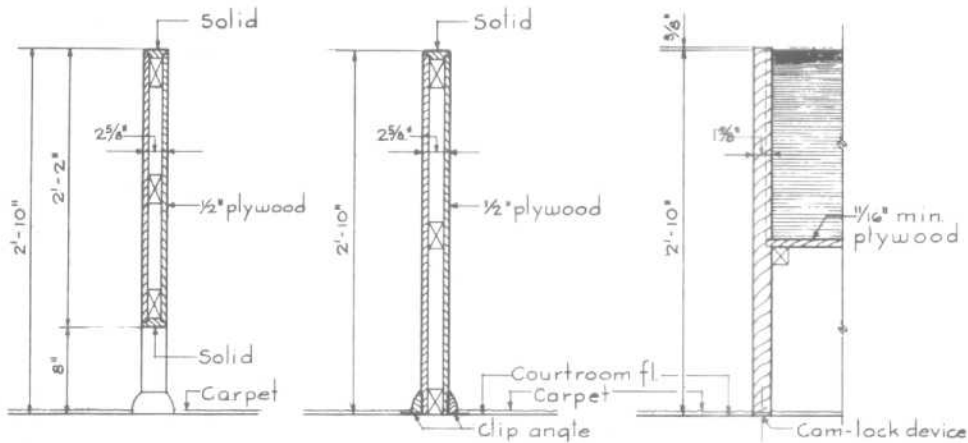
Wood Railing and Gate



PLAN OF  
RAIL AND GATE



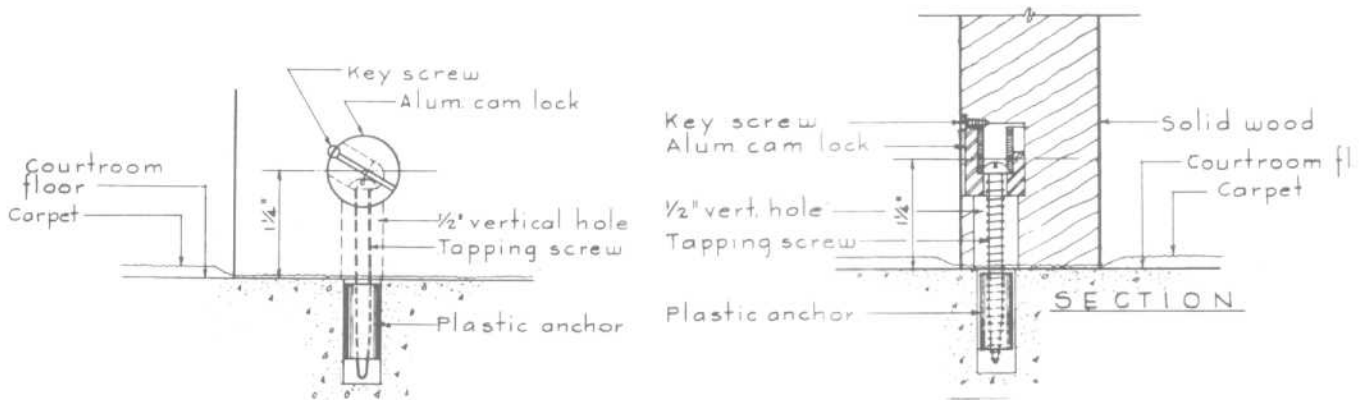
ELEVATION OF  
RAIL AND GATE



SECTION  
A - A

SECTION  
B - B

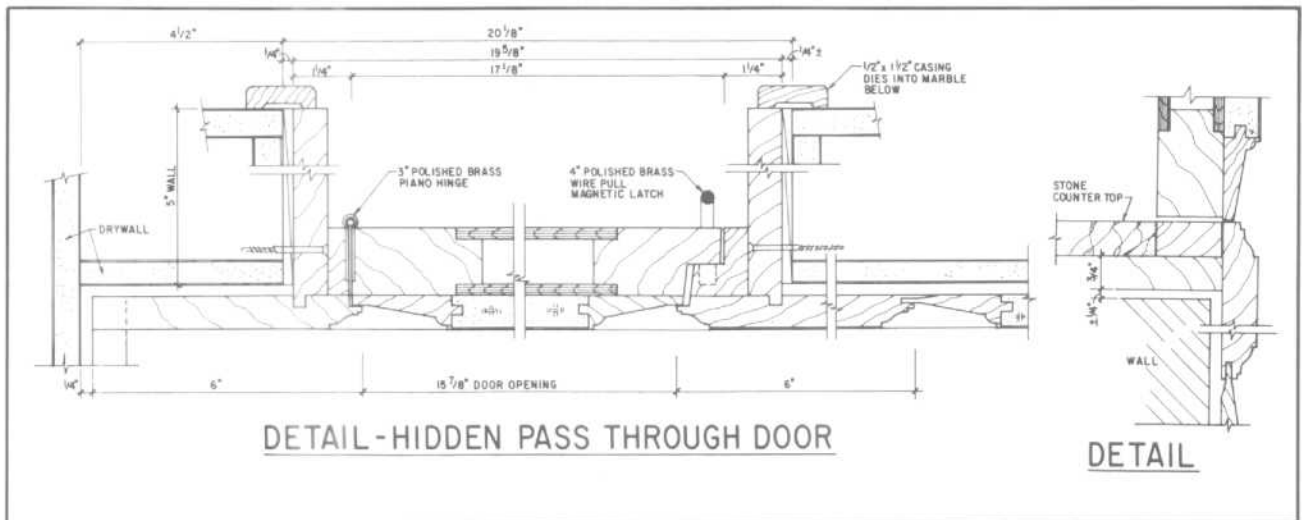
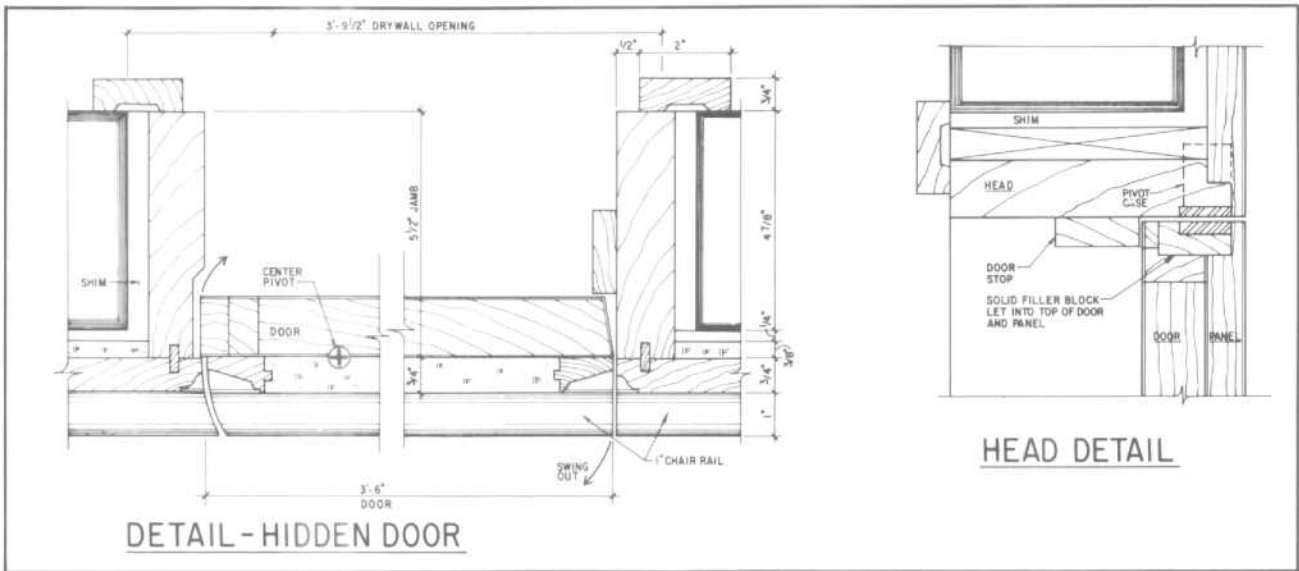
SECTION  
C - C



ELEVATION

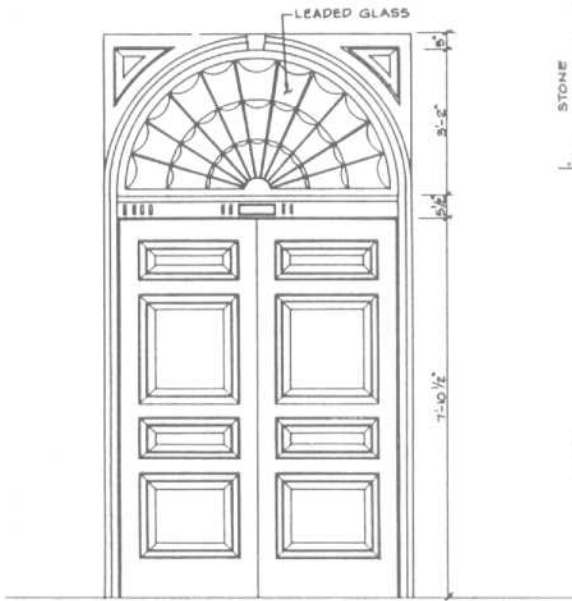
CAM LOCK ASSEMBLY



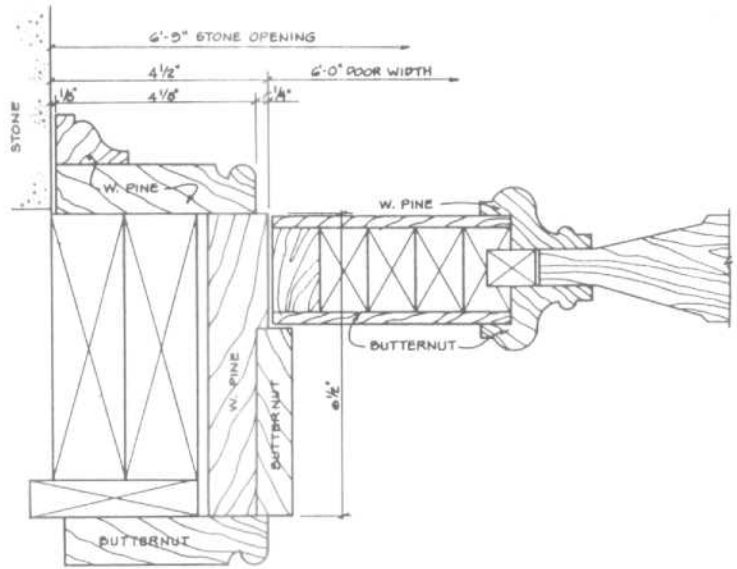


WOODWORK DETAILS

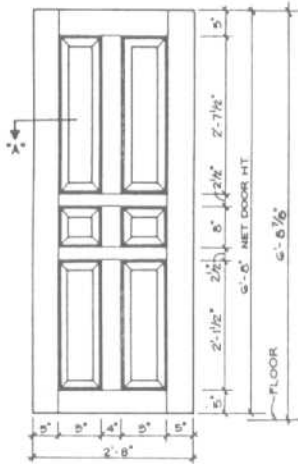
Raised Panel Wood Doors



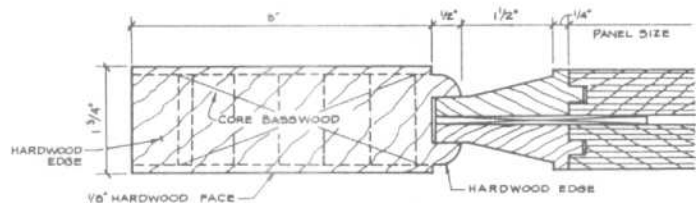
ELEVATION-FRONT ENTRY



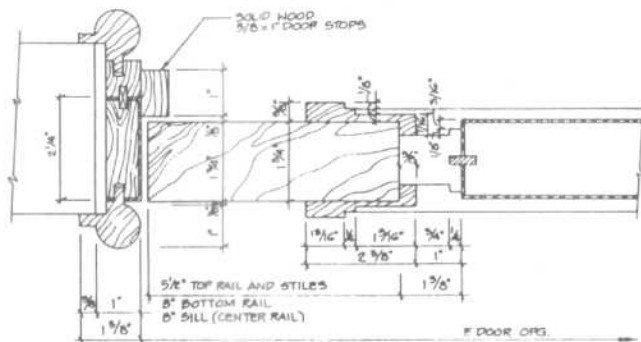
JAMB DETAIL AT ENTRY



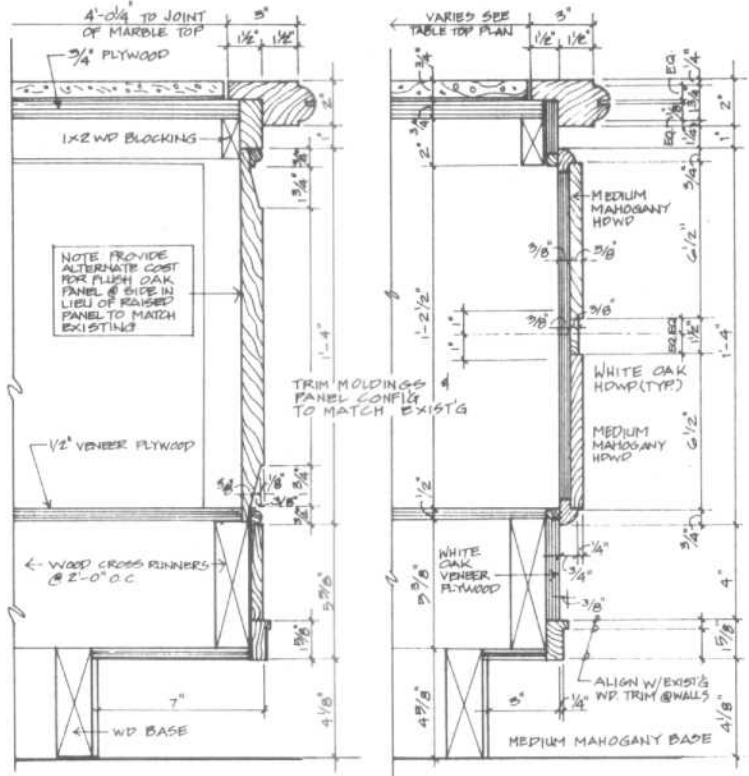
ELEVATION OF SPECIAL DOOR



SECTION "A" TYPICAL DOORS

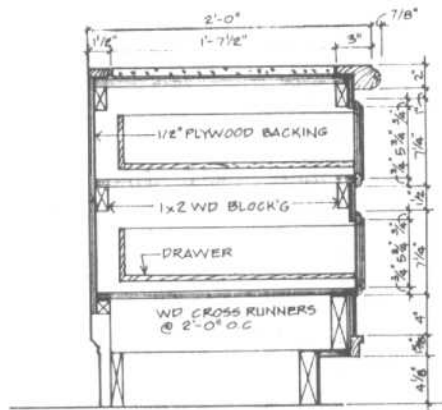


JAMB DETAIL AND DOOR DETAIL



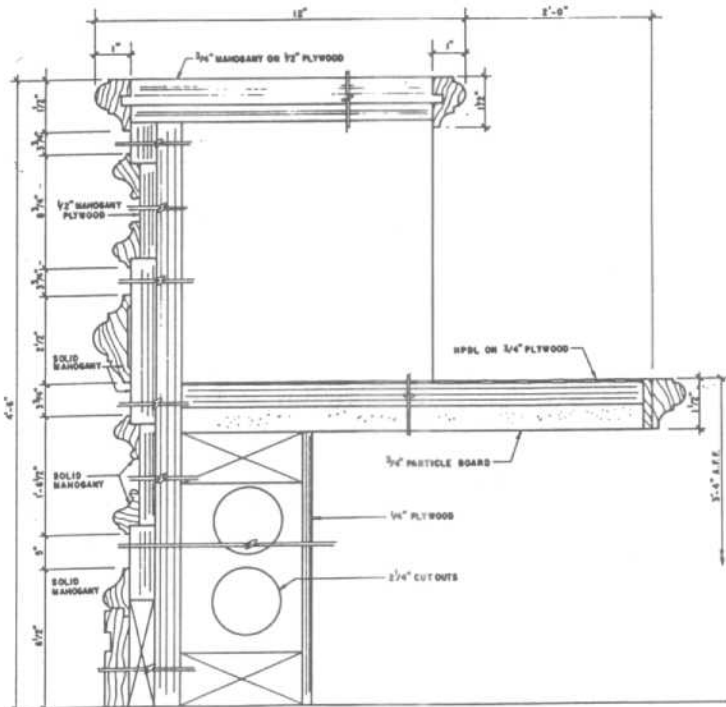
SECTION

SECTION

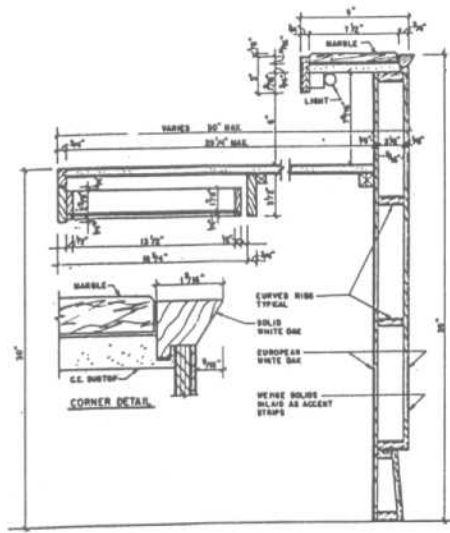


SECTION

CREDENZA



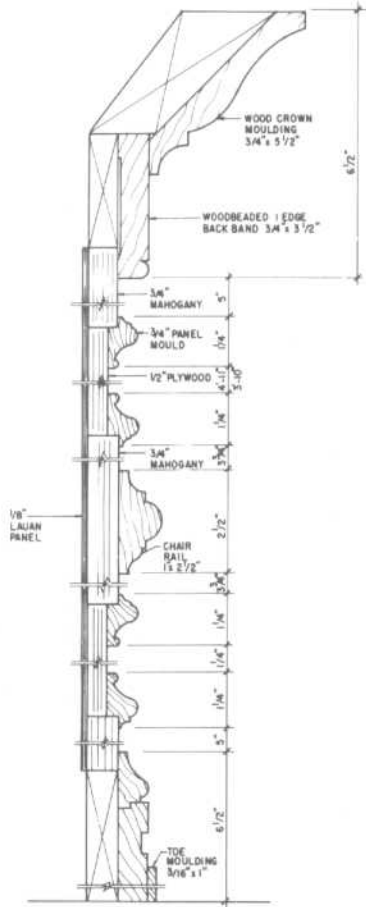
VERTICAL SECTION AT TELLERS COUNTER



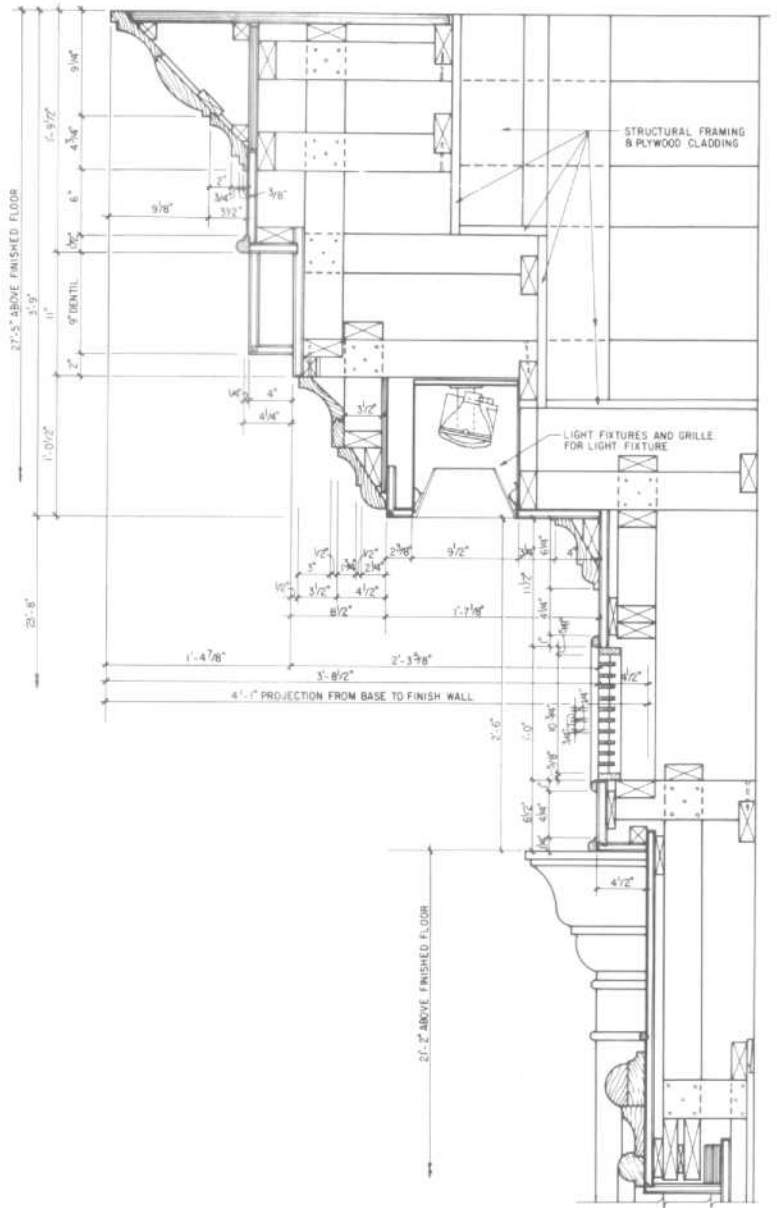
VERTICAL SECTION-RECEPTION DESK

WOODWORK DETAILS

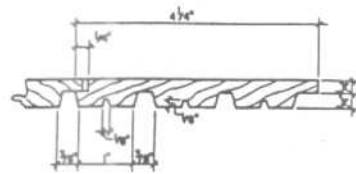
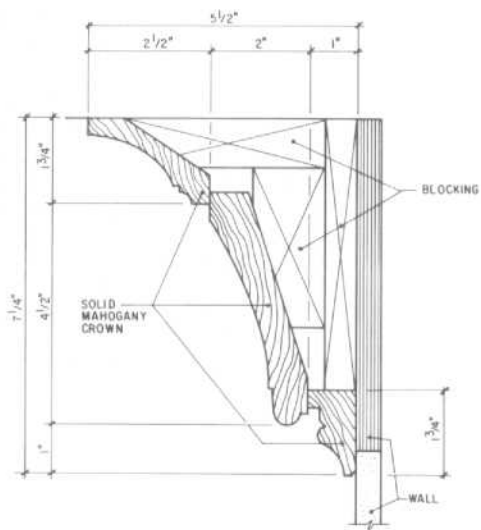
Cornices



TYPICAL TRIM AND CORNICE

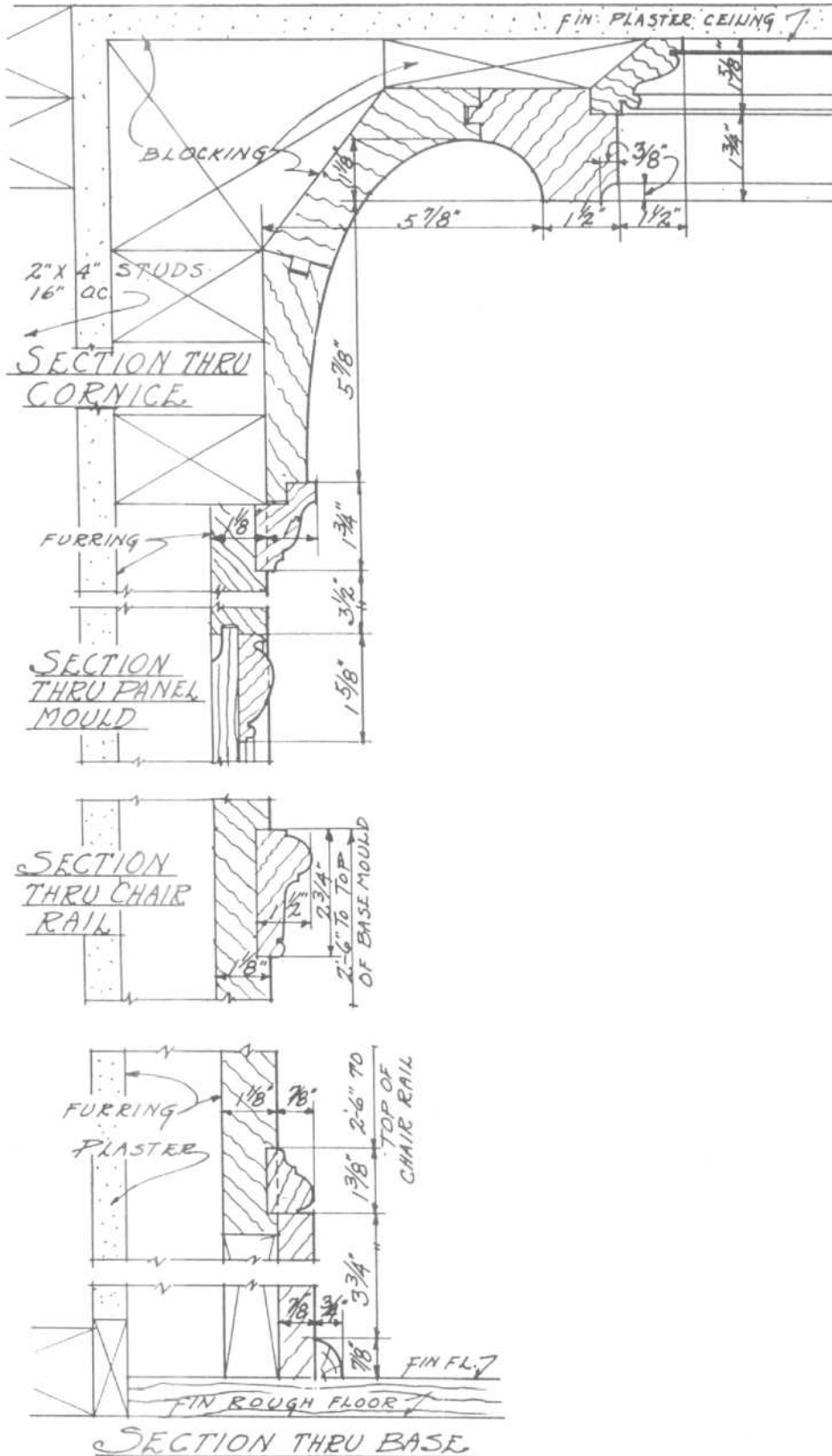


SECTION AT ENTABLATURE



PANELING

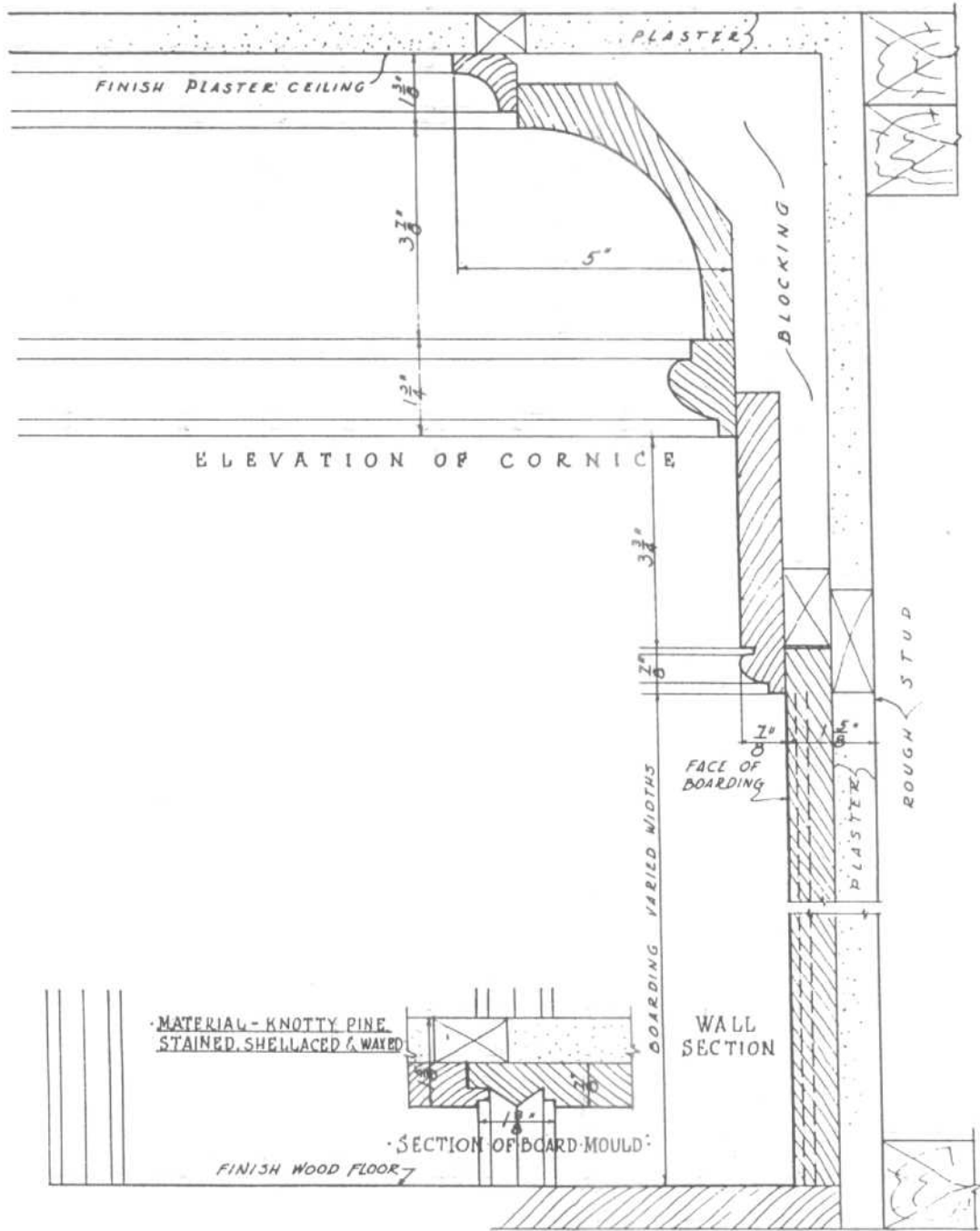
SECTION-TYPICAL CEILING MOULDINGS



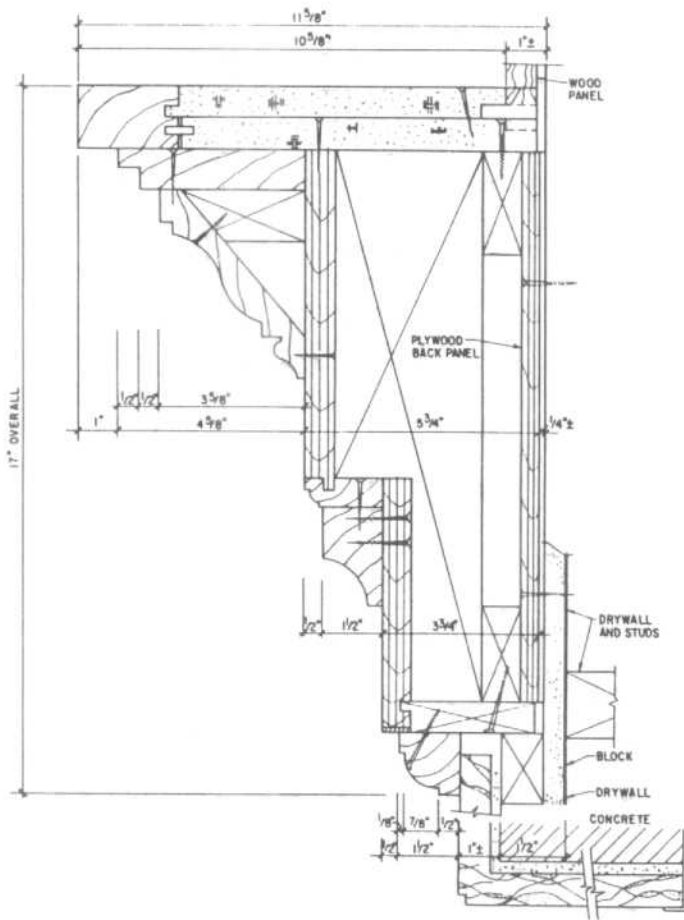
DETAIL OF WOOD CORNICE AND PANELING

WOODWORK DETAILS

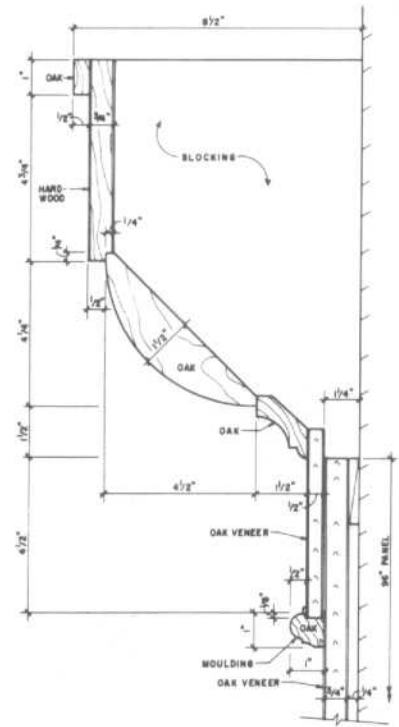
Cornices



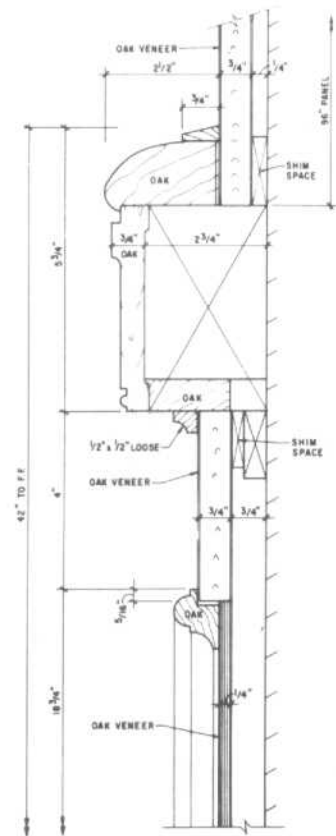
DETAIL OF WOOD WALL & CORNICE LIBRARY



DETAIL-FIREPLACE MANTEL



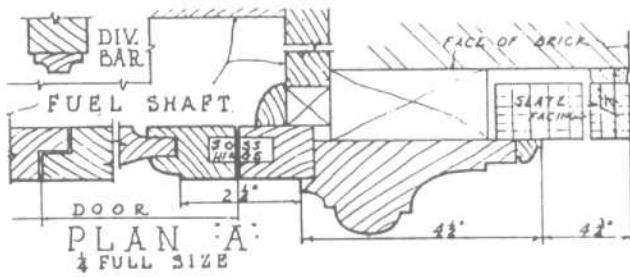
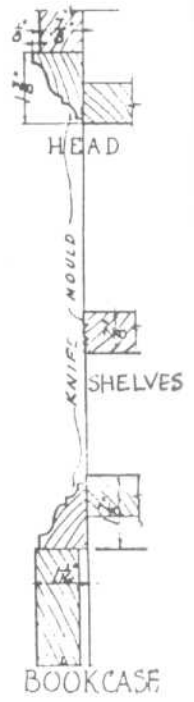
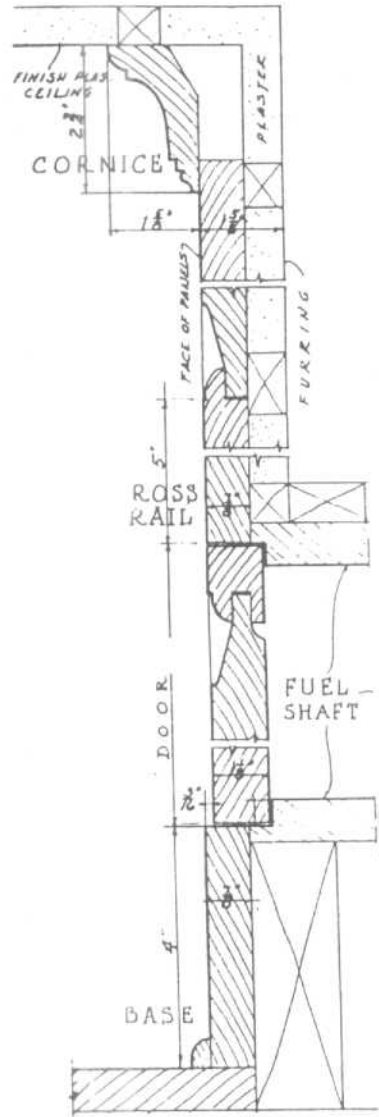
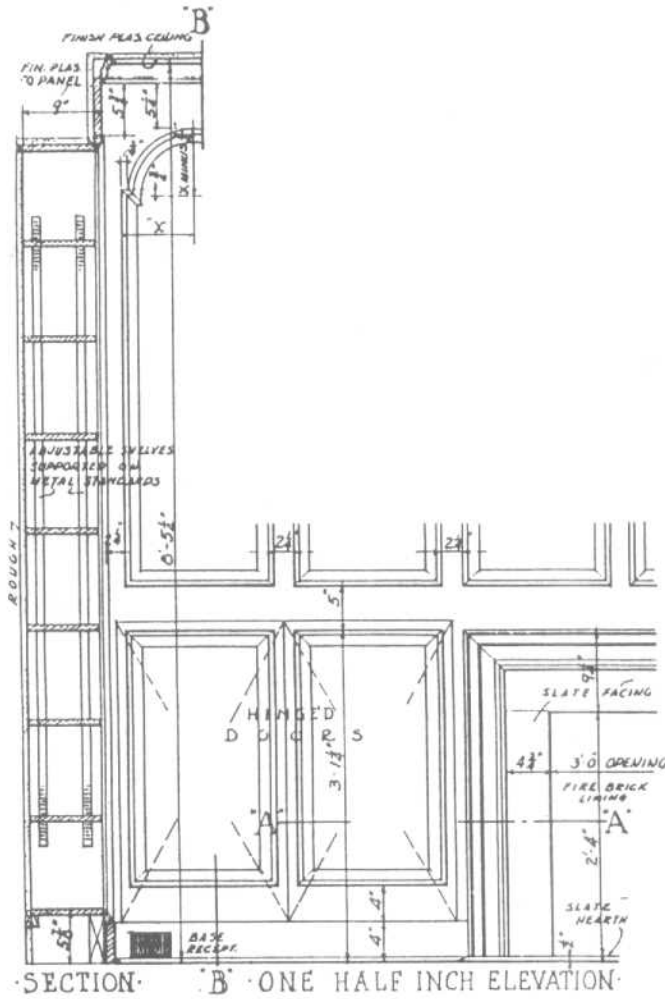
DETAIL AT COLUMN CAPITAL



DETAILS AT COLUMN

WOODWORK DETAILS

Detail of Wood-Paneled Wall and Bookcase



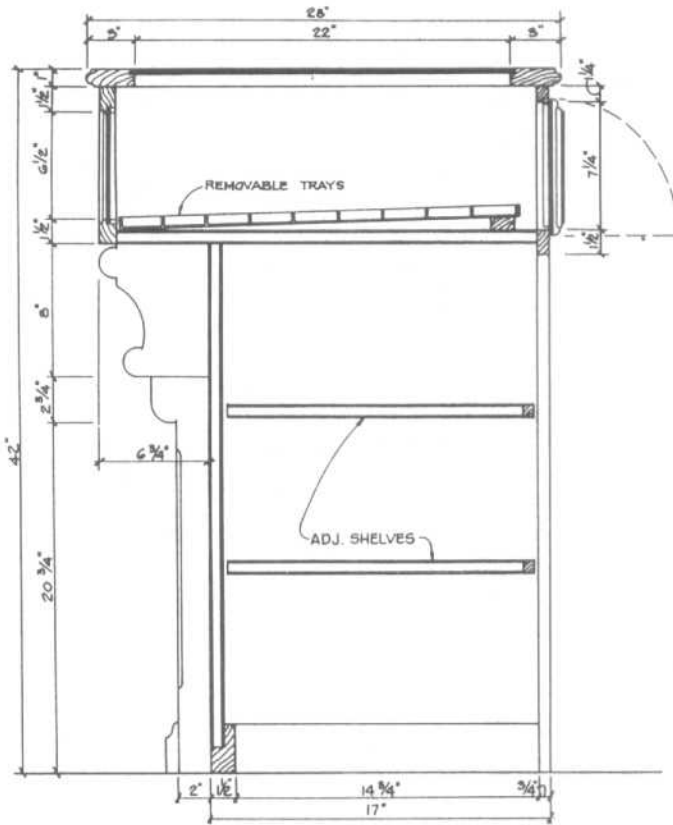
SECTION B:  
1/4 FULL SIZE  
MATERIAL-KNOTTY PINE  
STAINED AND WAXED.



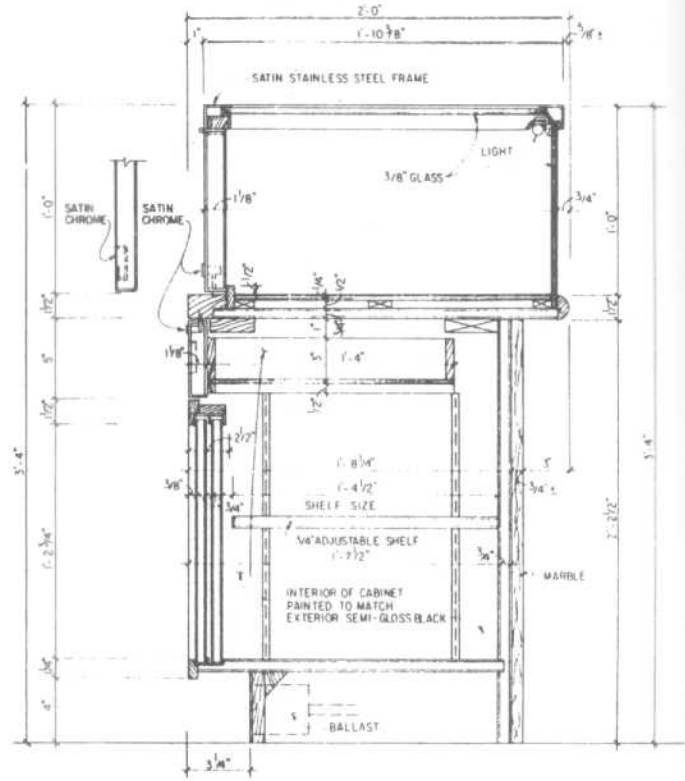


WOODWORK DETAILS

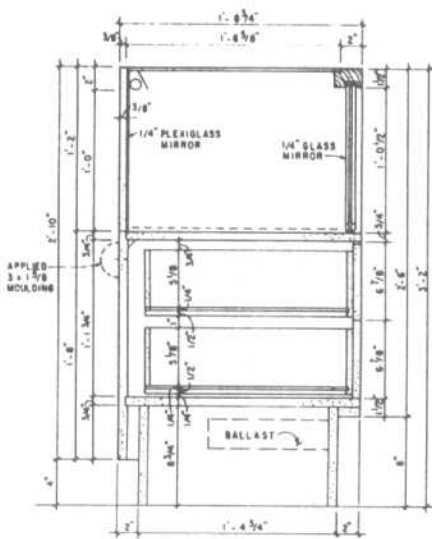
Display Cases



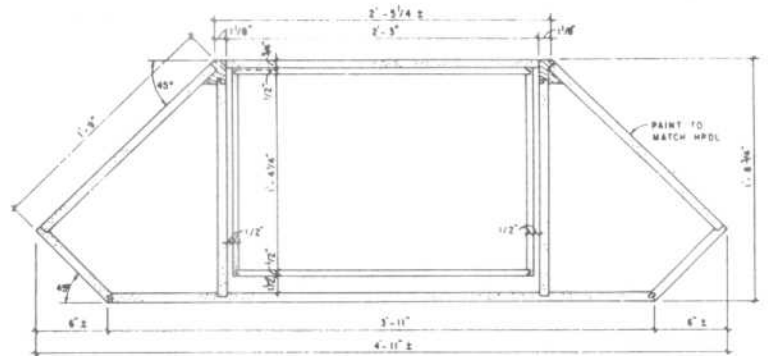
SHOWCASE SECTION



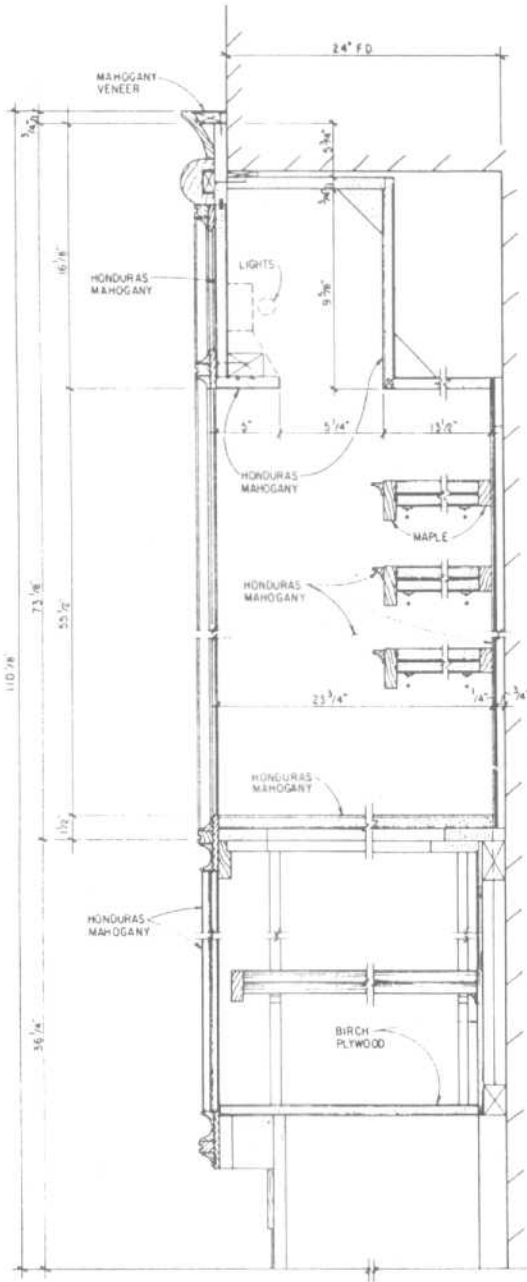
VERTICAL SECTION-DISPLAY CASE



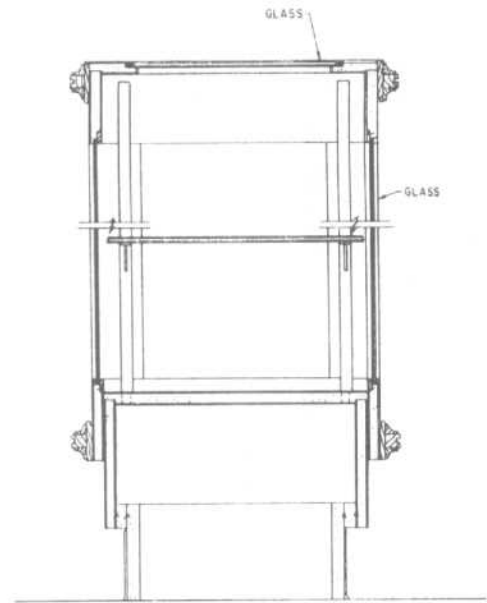
VERTICAL SECTION  
JEWELRY CASE



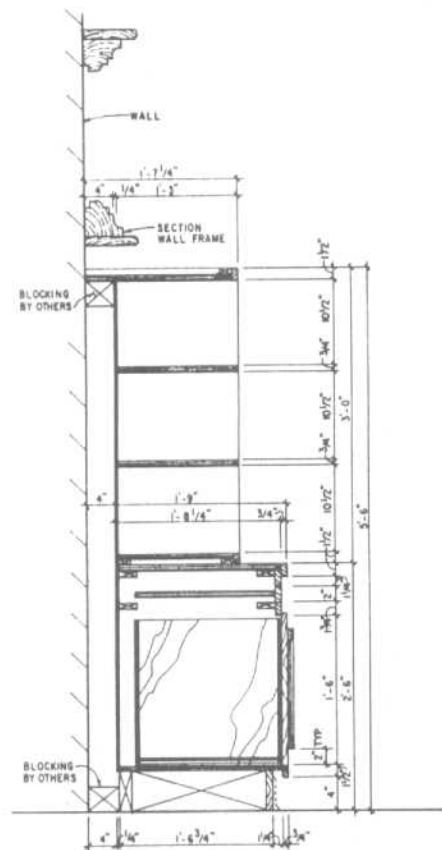
PLAN SECTION JEWELRY CASE



TYPICAL VERTICAL SECTION  
AT WALL UNIT



VERTICAL SECTION  
AT DISPLAY CASE



VERTICAL SECTION  
SHIRT DISPLAY



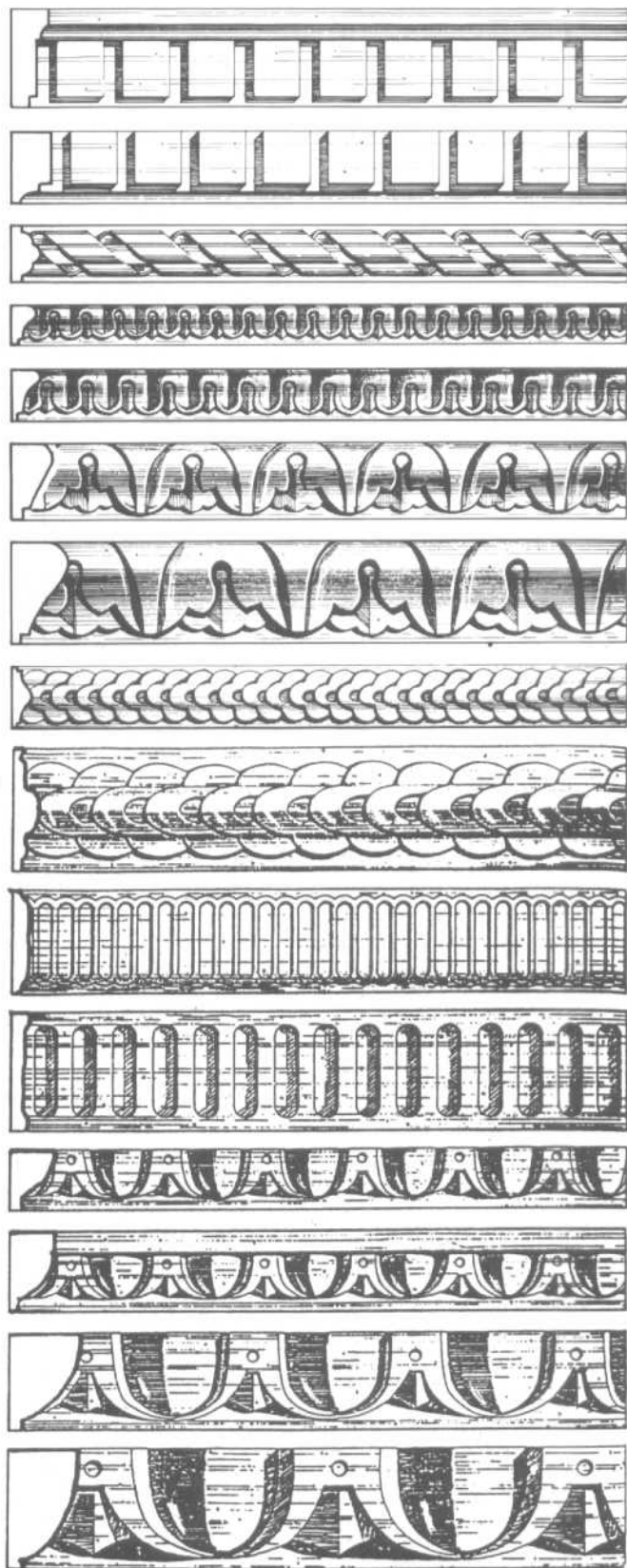
## FINISHING MATERIALS

GENERIC TYPE	RECOMMENDED USAGE	CHARACTERISTICS
<b>System #1</b> Lacquers  Catalyzed Lacquers	For all wood surfaces except medium to heavy acid areas; Interior use.  For wood surfaces requiring medium acid resistance; Interior use.	Good coverage; Easy to apply; Sands easy; Poor water resistance.  Tough wearing surface; Good water resistance; Can be repaired.
<b>System #2</b> Varnishes  Conversion Varnishes	For all wood surfaces; Interior use; Exterior use — spar varnishes.  For all wood surfaces; Some acid resistance; Interior use.	Good build; Tends to amber with age; Slow drying.  Good build and solids; Can be repaired.
<b>System #3</b> Polyurethane  Catalyzed Polyurethane	For all wood surfaces; Interior use.  For all wood surfaces; High acid resistance; Interior use.	Tough surface; Excellent wear and abrasion resistance; Can be repaired.  Tough surface; Excellent wear and abrasion resistance; Can be repaired.
<b>System #4</b> Epoxy	For all wood surfaces; High acid resistance; Interior use.	Very hard surface; Excellent wear and abrasion resistance; Limited pot life; High water resistance.
<b>System #5</b> Penetrating Oils	For all wood surfaces; Performs well on Oak, Teak, Walnut, etc.	Easy to apply; Makes touch-up easy; Average wear and abrasion qualities; Easy to repair.
<b>System #6</b> Synthetic Enamels	Most wood and wood product surfaces; Interior use; Most colors available.	Good coverage; Tough wearing; Can be re-coated or repaired; Easy to apply.
<b>System #7</b> Vinyl Lacquer  Catalyzed Vinyl	For all wood products; Interior use; Light acid resistance.  For all wood products; Interior use; Excellent for residential kitchens, etc.; Better acid resistance.	Tough surface; Good wearing; Resists light chemicals.  Tough surface; Good wearing; Repairs not easy.
<b>System #8</b> Fire Retardant Coatings (Intumescent)	For surfaces of wood products requiring flame spread protection. (See WIC Technical Bulletin No. 423 — Section 19.) Interior use only. UL Rated-UL-723; NFPA-255; and ASTM E-84; Tested for flame spread, fuel contributed, and smoke developed.	Leaching will result if exposed directly to high humidity or direct water. Can be coated with compatible overcoat system or waterproofing materials. Available for transparent and opaque finishes.

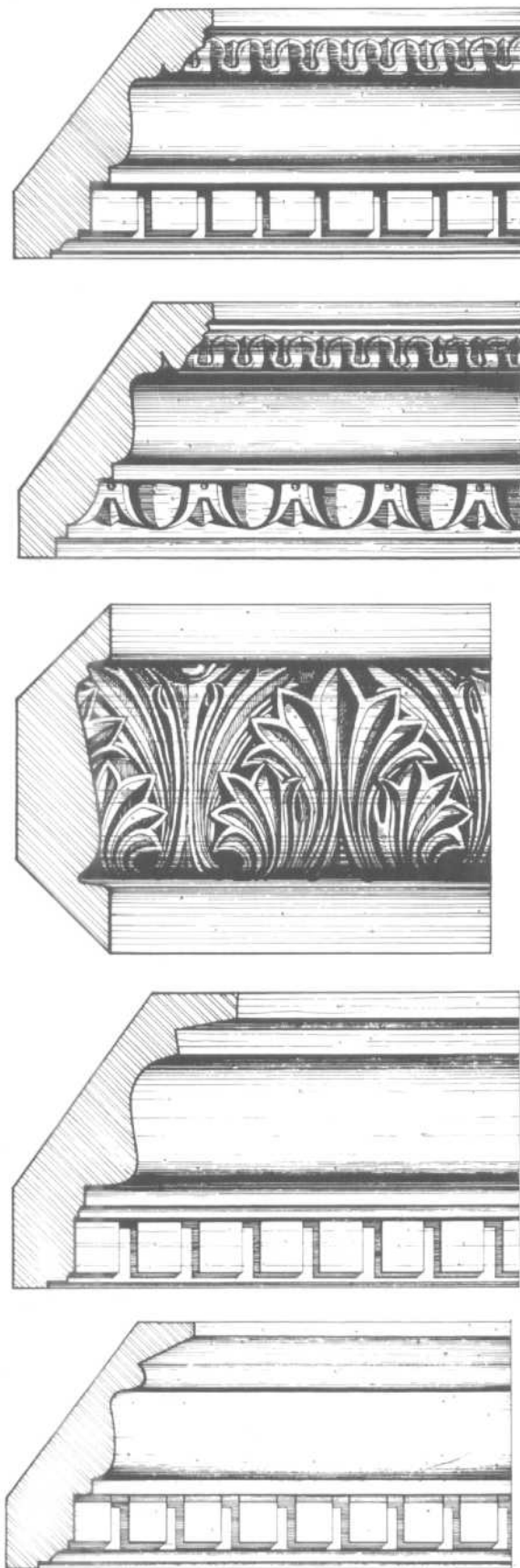
CORNICES AND MOULDINGS

Deep Sculpt and Crown Mouldings

Deep Sculpt Mouldings

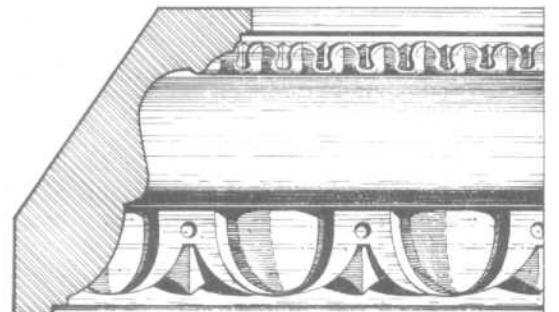
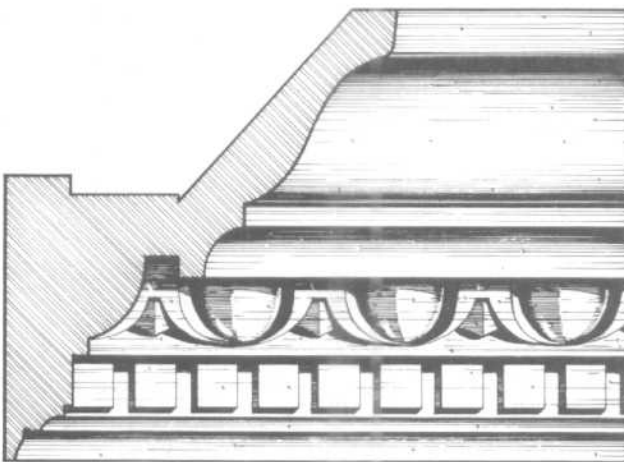
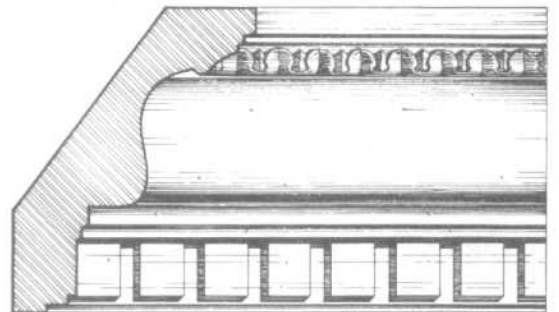
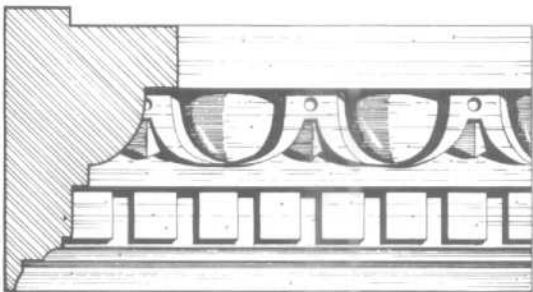
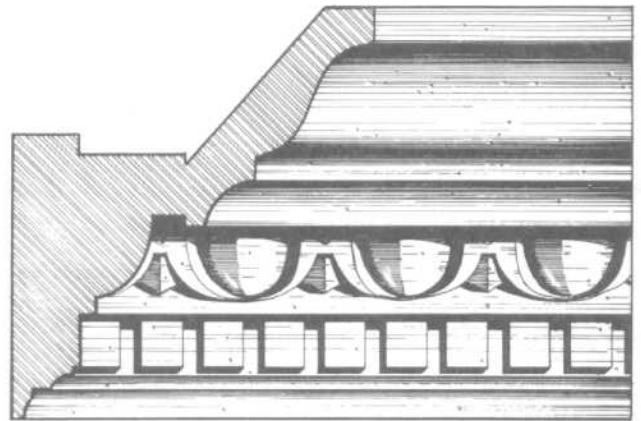
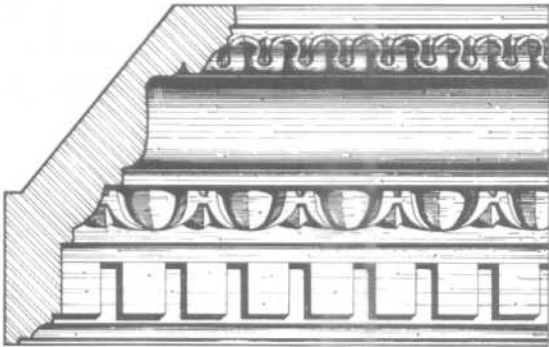
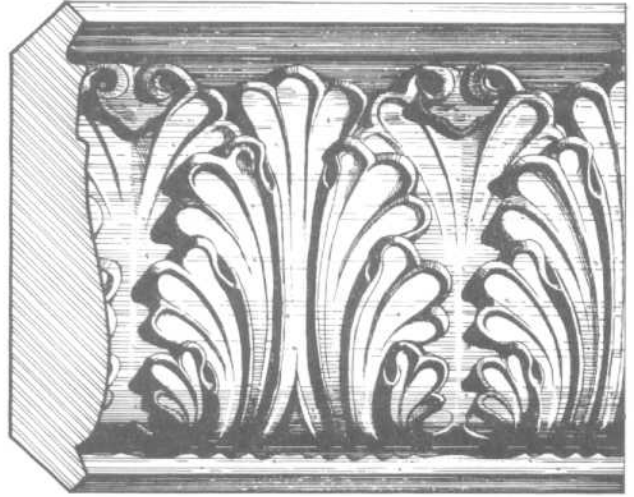
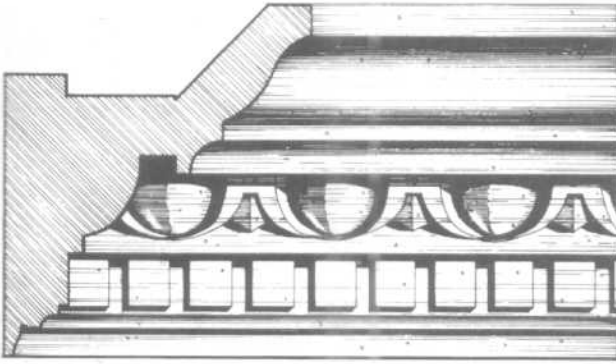


Crown Mouldings



CORNICES AND MOULDINGS

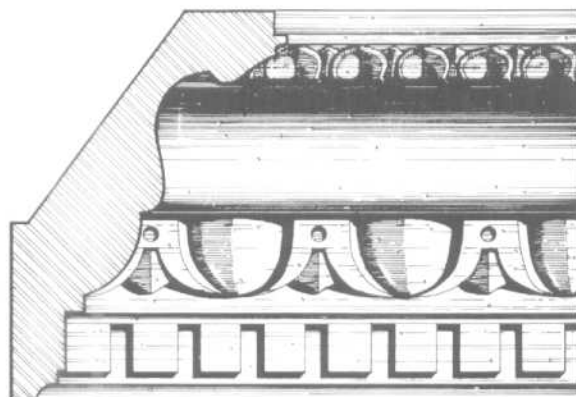
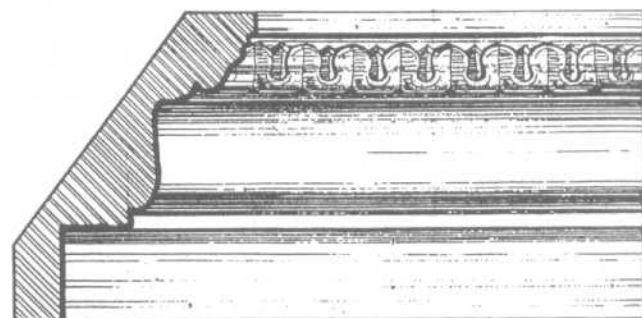
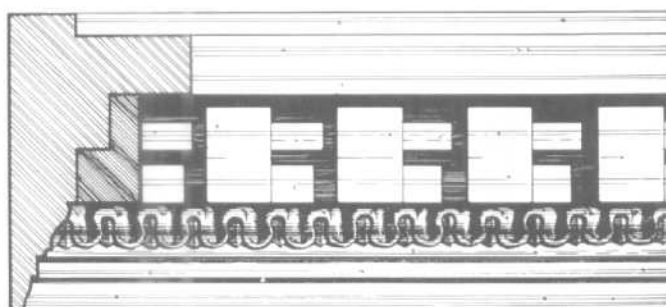
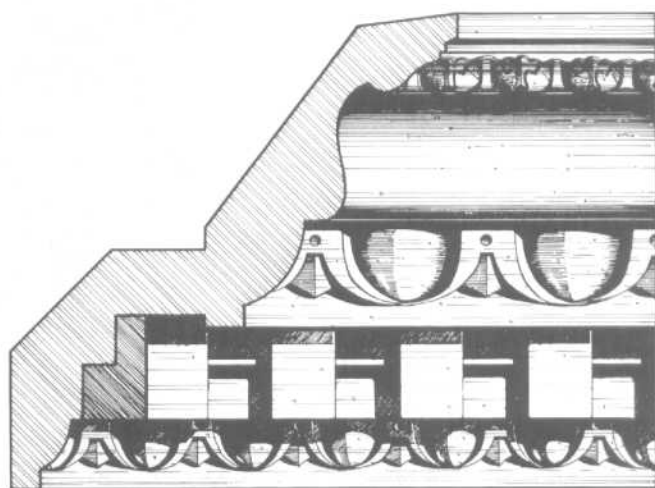
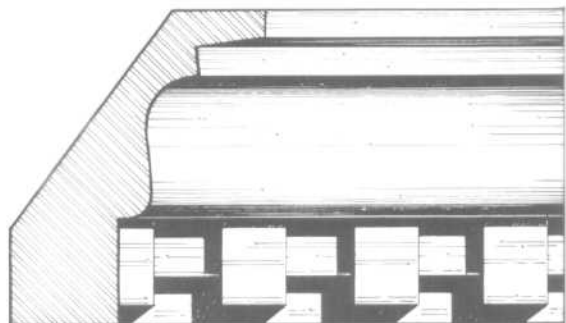
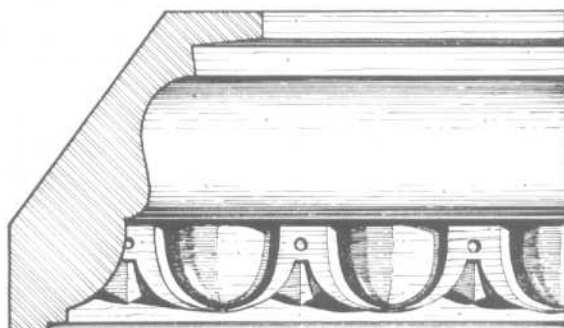
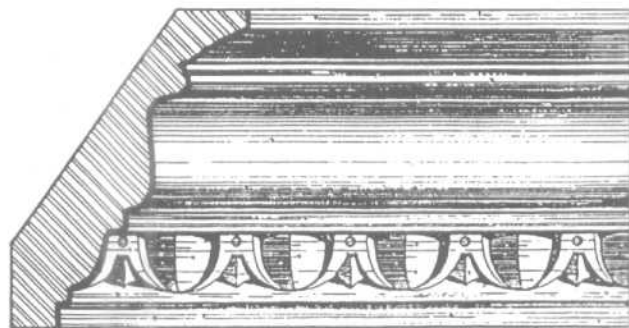
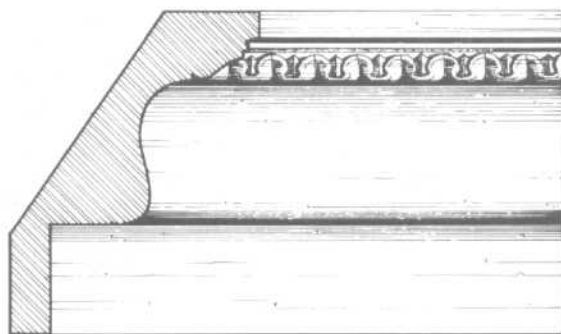
Crown Mouldings





CORNICES AND MOULDINGS

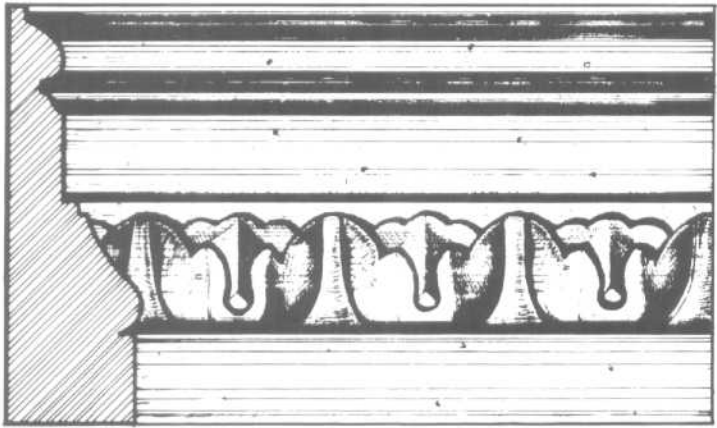
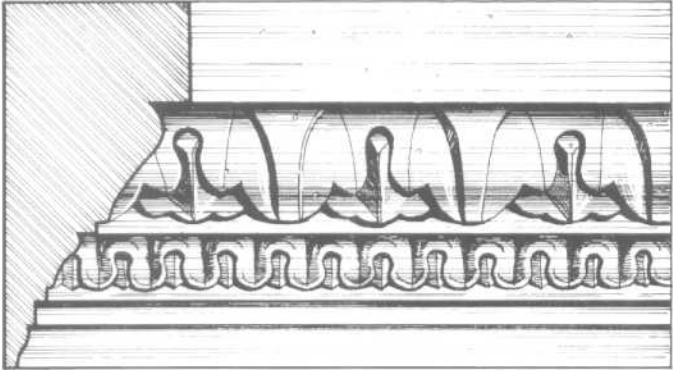
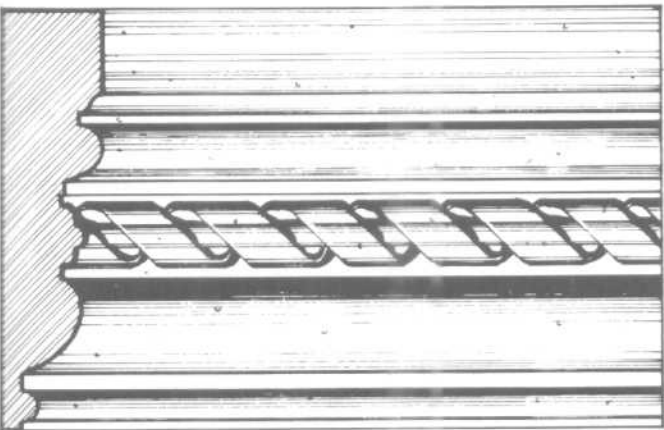
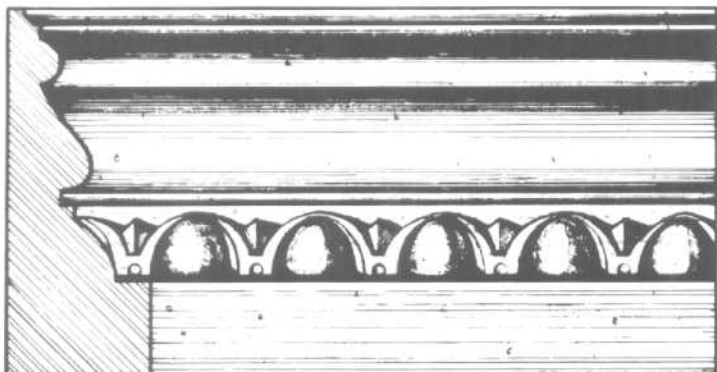
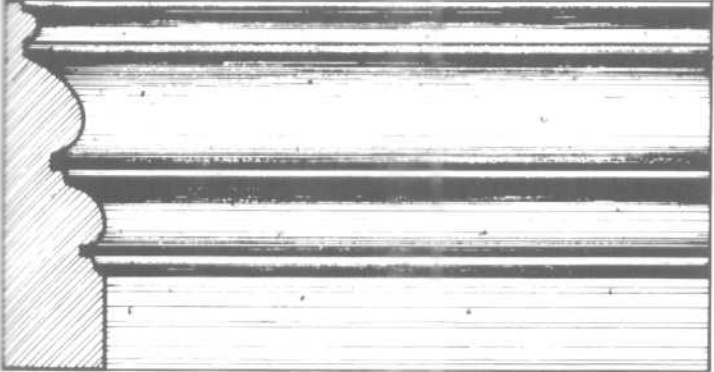
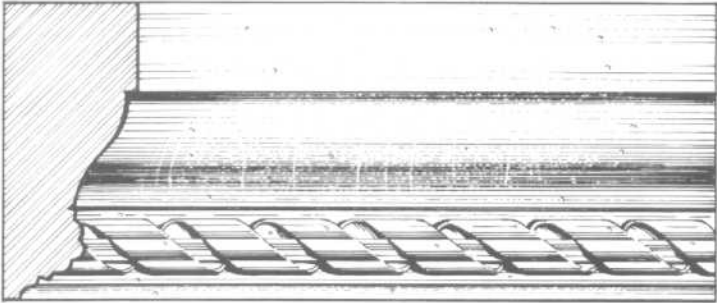
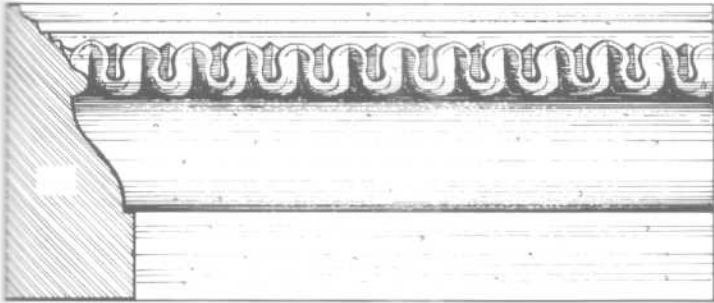
Crown Mouldings





CORNICES AND MOULDINGS

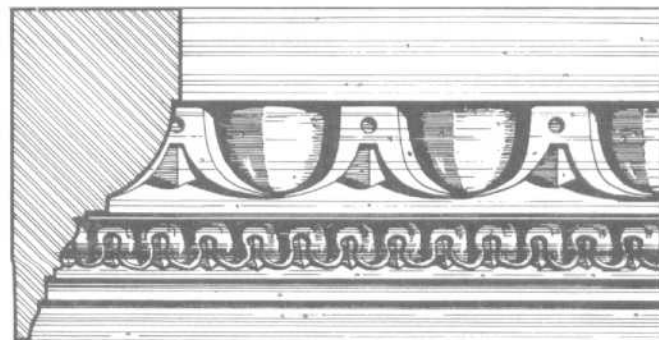
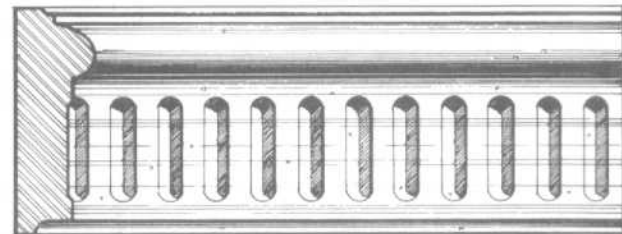
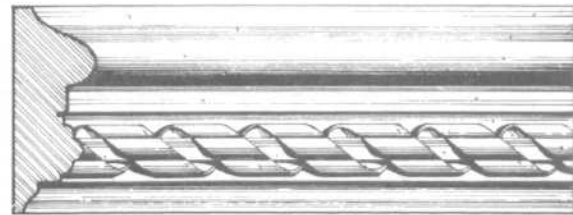
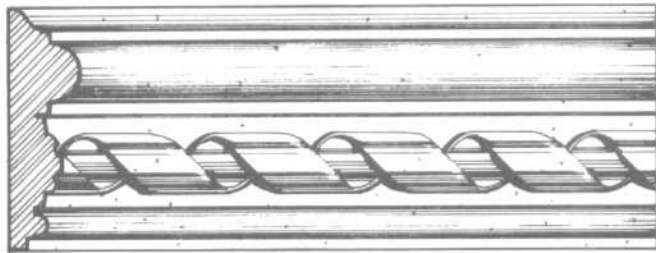
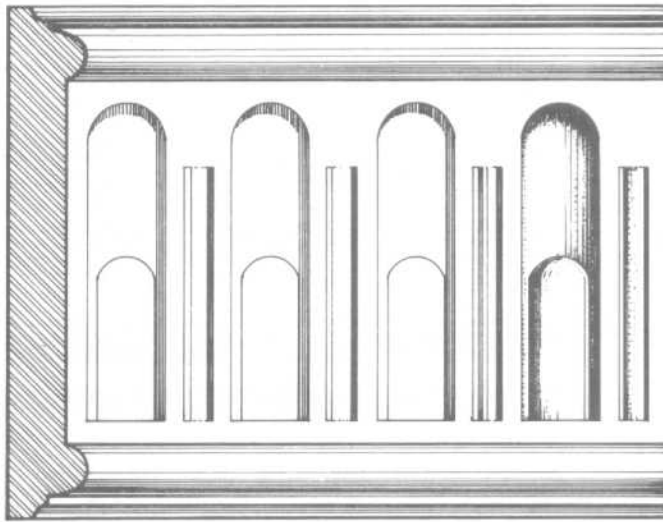
Door Trim Mouldings



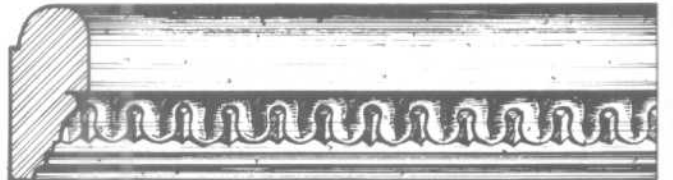
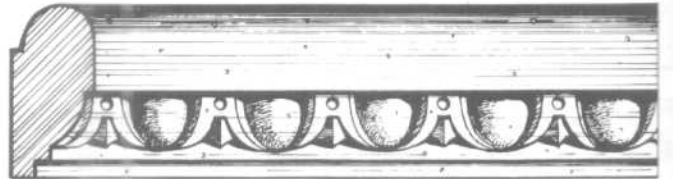
CORNICES AND MOULDINGS

Miscellaneous Mouldings

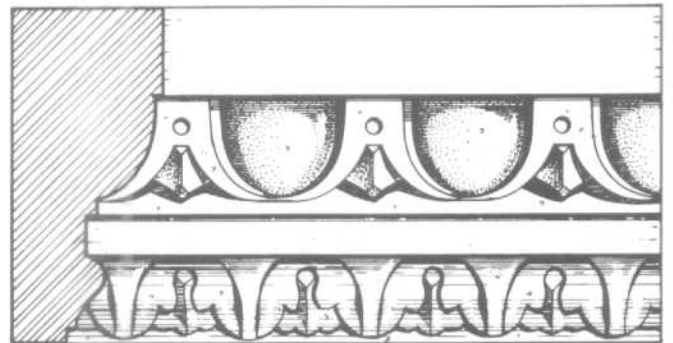
Chair Rail Mouldings



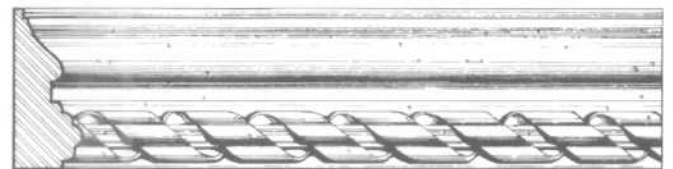
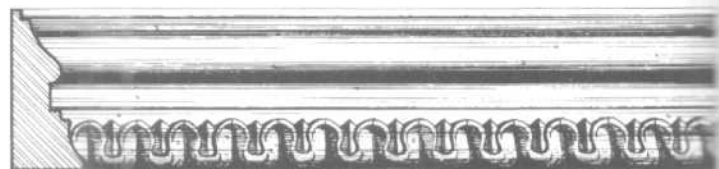
Picture/Mirror Hanging Mouldings



Door Trim Moulding

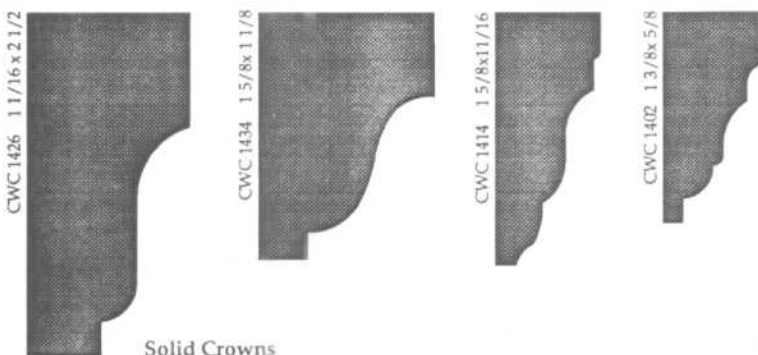
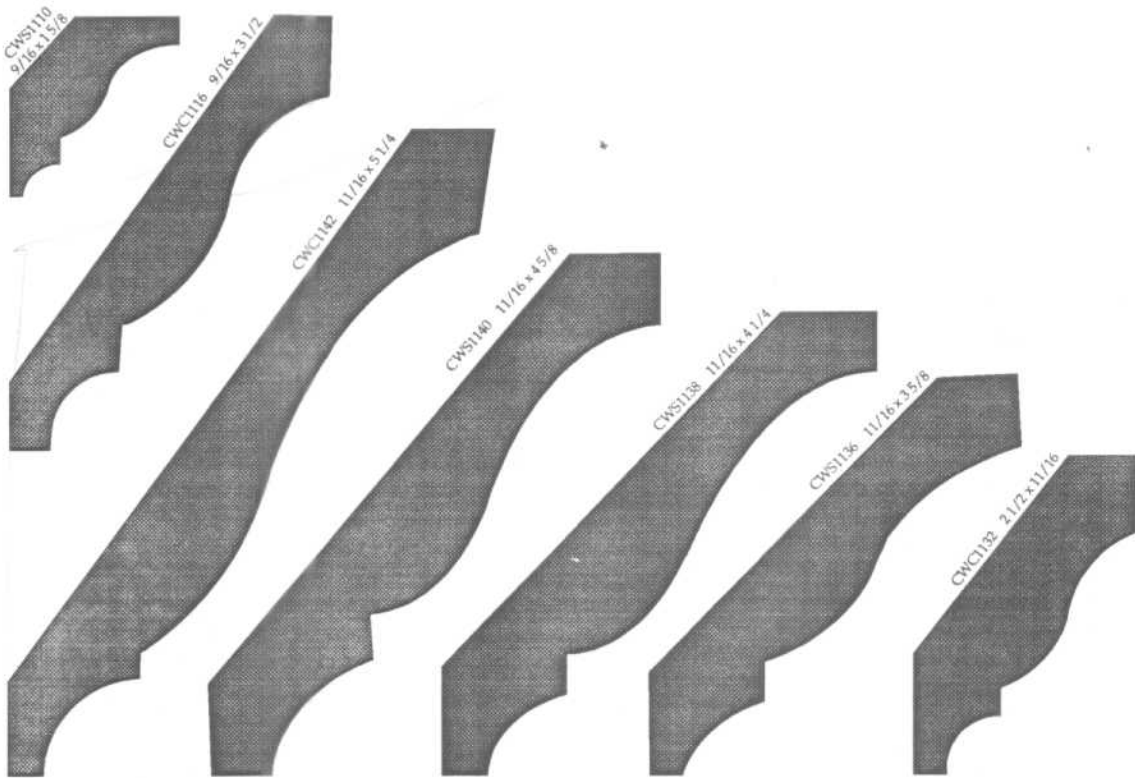
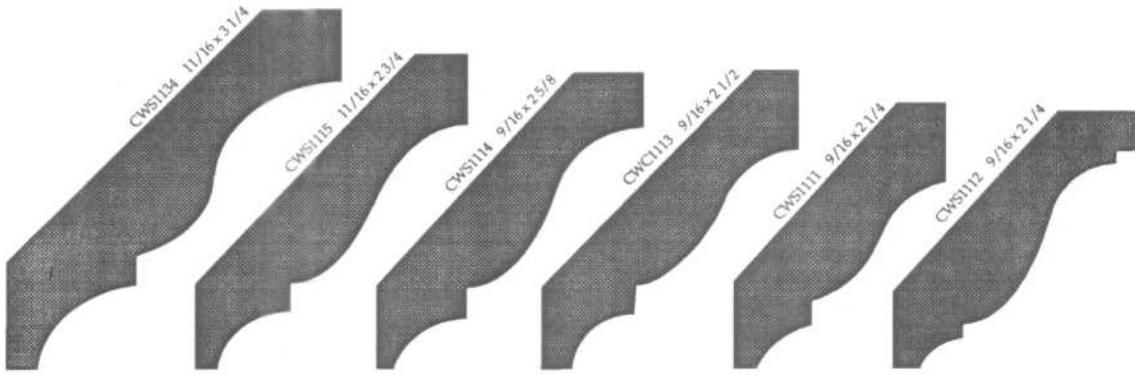


Panel and Trim Mouldings



CORNICES AND MOULDINGS

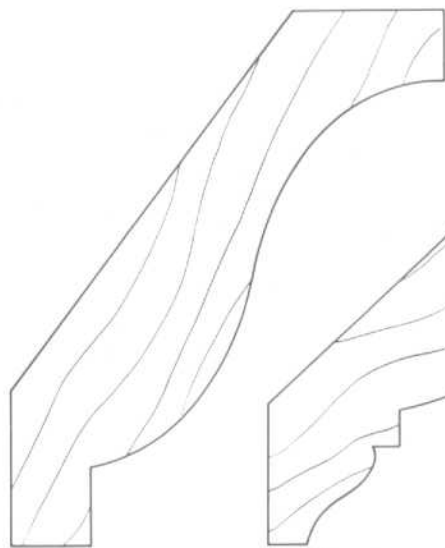
Crown Mouldings



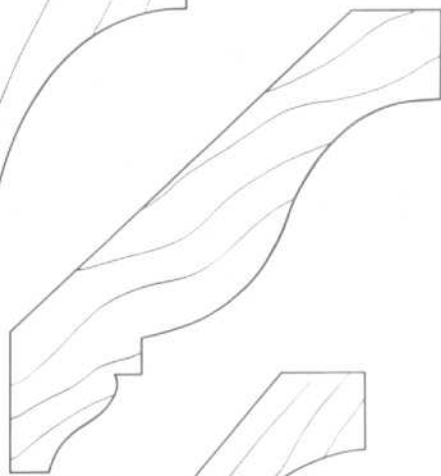
Solid Crowns

CORNICES AND MOULDINGS

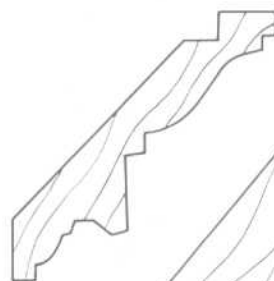
Crown Mouldings



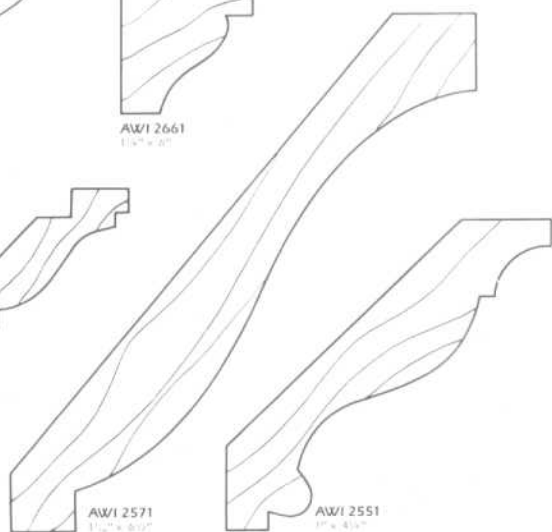
AW/I 2871  
1 1/2" x 3 1/2"



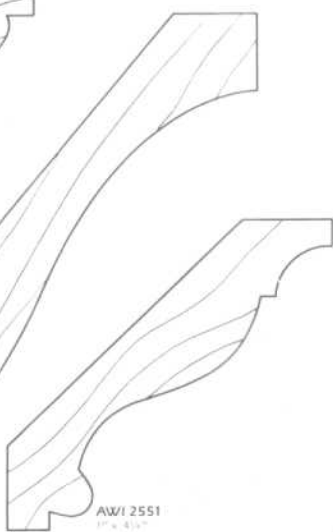
AW/I 2661  
1 1/2" x 3"



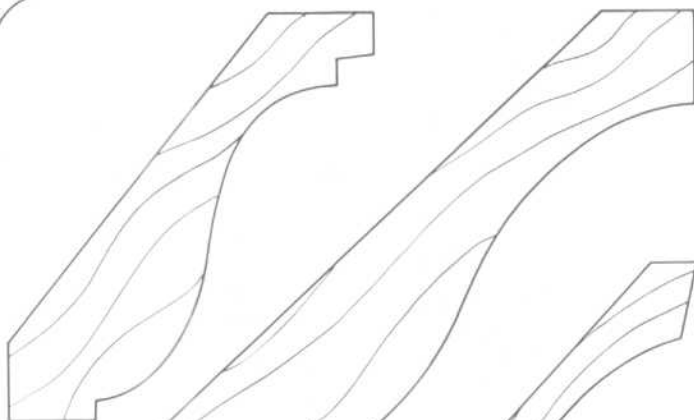
AW/I 2541  
3/4" x 3 1/2"



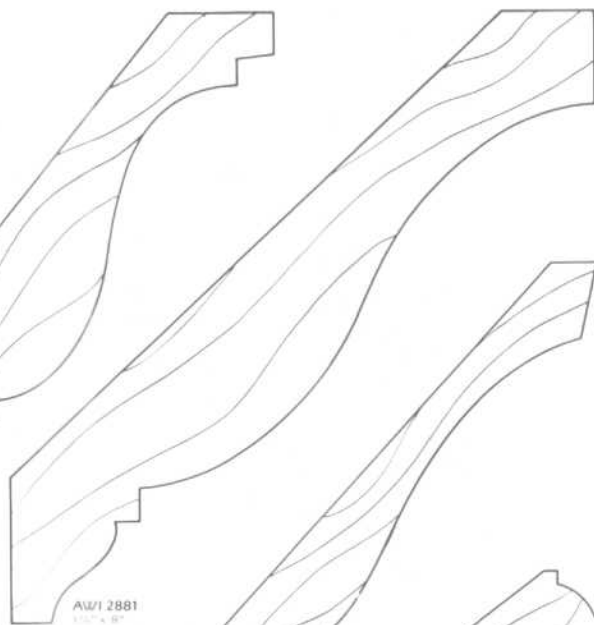
AW/I 2571  
1 1/2" x 3 1/2"



AW/I 2551  
1" x 4 1/2"



AW/I 2662  
1 1/2" x 3 1/2"



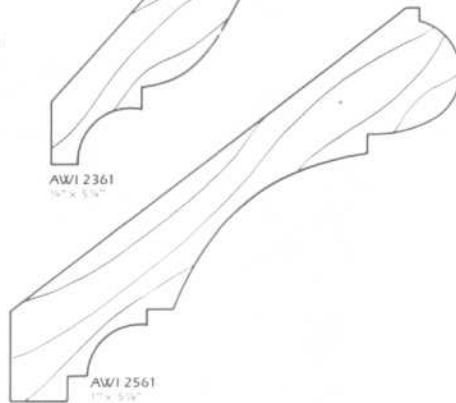
AW/I 2881  
1 1/2" x 3"



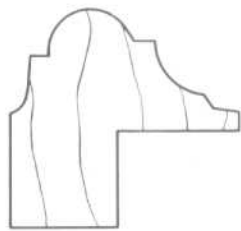
AW/I 2361  
3/4" x 5 1/4"



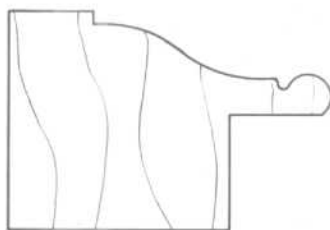
AW/I 2831  
1 1/2" x 2 1/2"



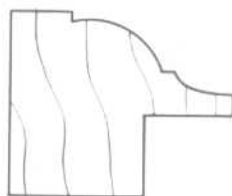
AW/I 2561  
1" x 5 1/4"



AWI 5821  
1 3/8" x 1 3/4"



AWI 5832  
1 3/8" x 2 3/8"



AWI 5822  
1 3/8" x 1 3/8"



11/16 x 1 3/4



11/16 x 1 3/4



11/16 x 1 3/8



AWI 5522  
1 1/2" x 2"



AWI 5831  
1 1/2" x 2 1/2"



AWI 5521  
1" x 2"

Picture Mouldings

Picture Moulds



11/16 x 2 1/16



11/16 x 1 3/8

Picture Frame



AWI 11421  
W" x 1 1/2"



AWI 11521  
1 1/4" x 1 1/2"



AWI 11522  
W" x 1 1/4"



7/8 x 1 7/8



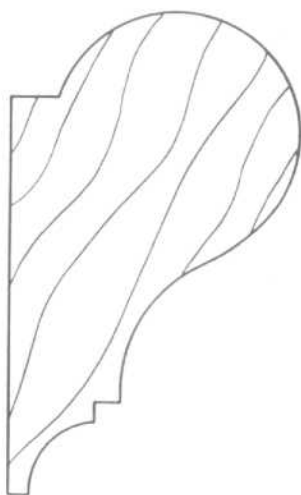
11/16 x 1 5/8



AWI 11631  
1 1/2" x 2 1/4"



AWI 11831  
1 1/4" x 2 3/4"



AWI 11941  
2 3/4" x 4"



1 1/8 x 2 1/4



1 x 2 1/2

Back Bands

Step Moulds

CORNICES AND MOULDINGS

Miscellaneous Mouldings



1 1/8 x 5 1/2 & 1 1/8 x 7 1/2

Pilaster



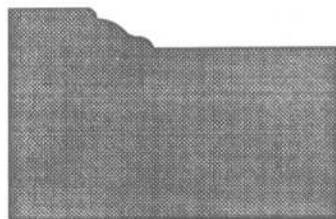
3/16 x 1 3/4



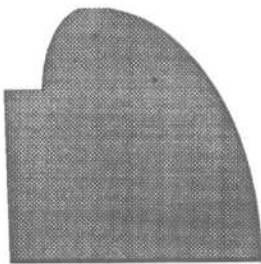
1 1/16 x 1 3/4

Tongue and Groove Siding

Fluted Pilaster



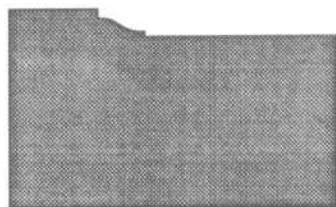
1 5/16 x 2



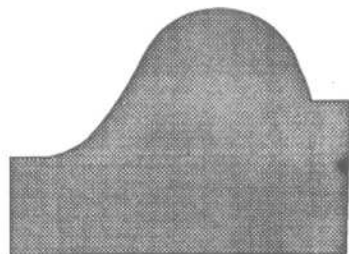
1 5/8 x 1 1/2



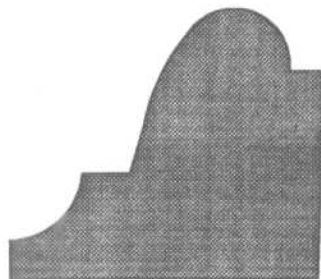
1 1/8 x 1 1/4



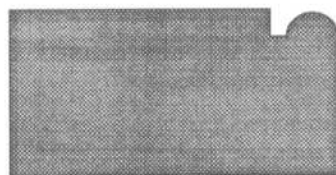
1 1/4 x 2



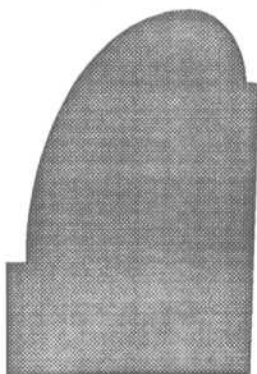
1 1/2 x 2



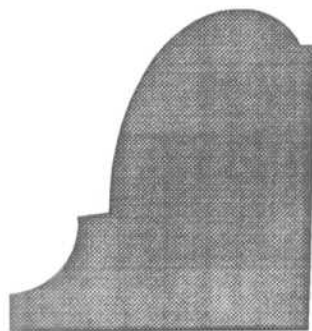
1 11/16 x 1 7/8



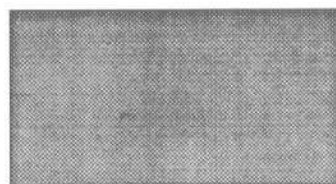
1 1/16 x 2



2 1/4 x 1 1/2



1 7/8 x 2



1 3/32 x 2

Brick Moulds



1 5/8 x 1 1/16



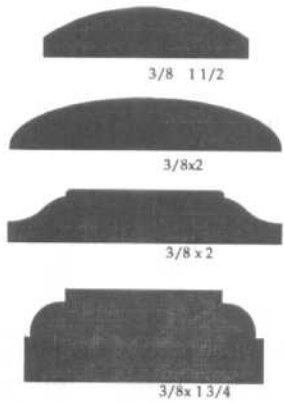
1 1/16 x 1 5/8

Drip Caps

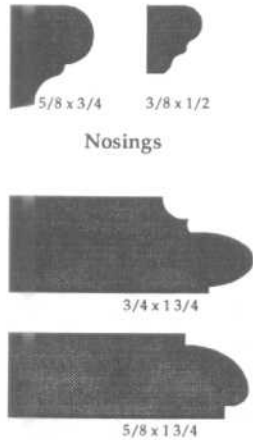


CORNICES AND MOULDINGS

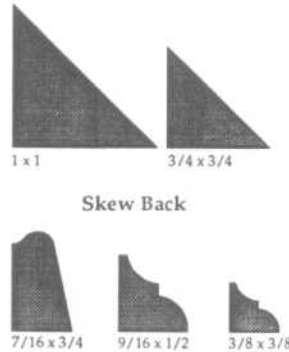
Miscellaneous Mouldings



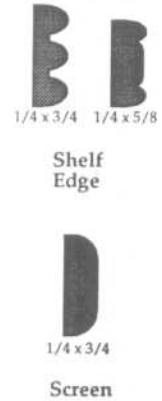
Mullion Centers



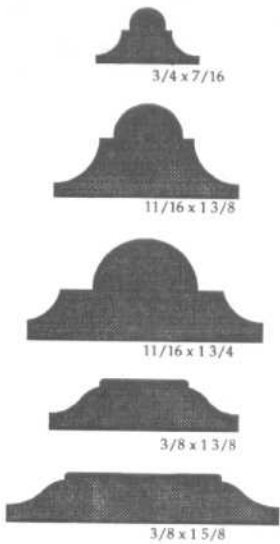
Sash Stops



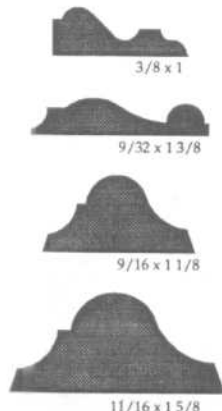
Sash Beads



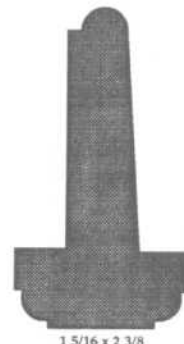
Screen



Astragals



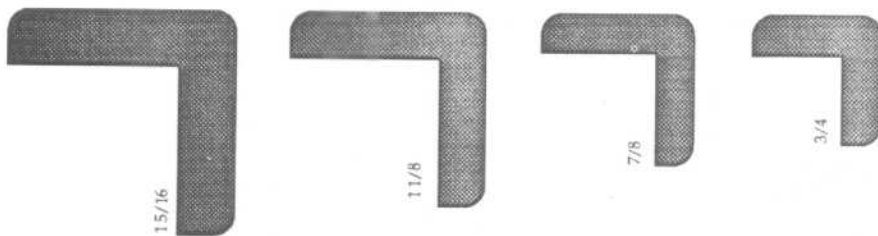
Panel Mouldings



"T" Astragal



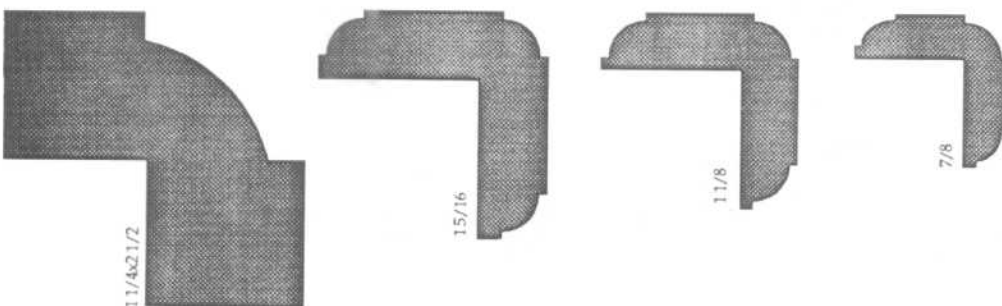
Sanitary Cap



Cornerguards



Back Band

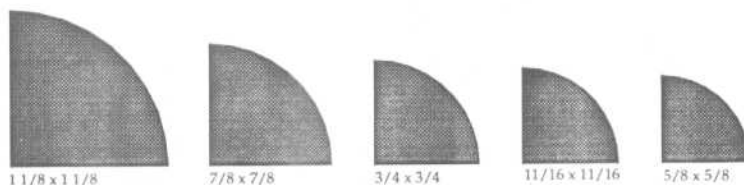
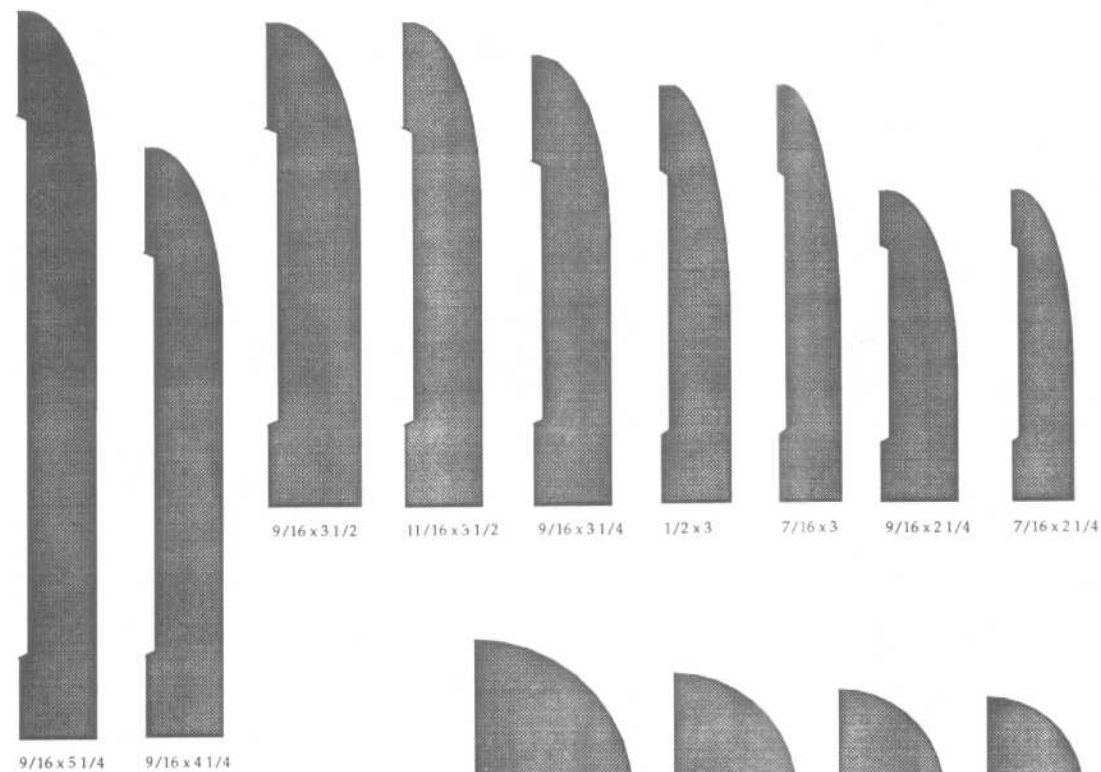
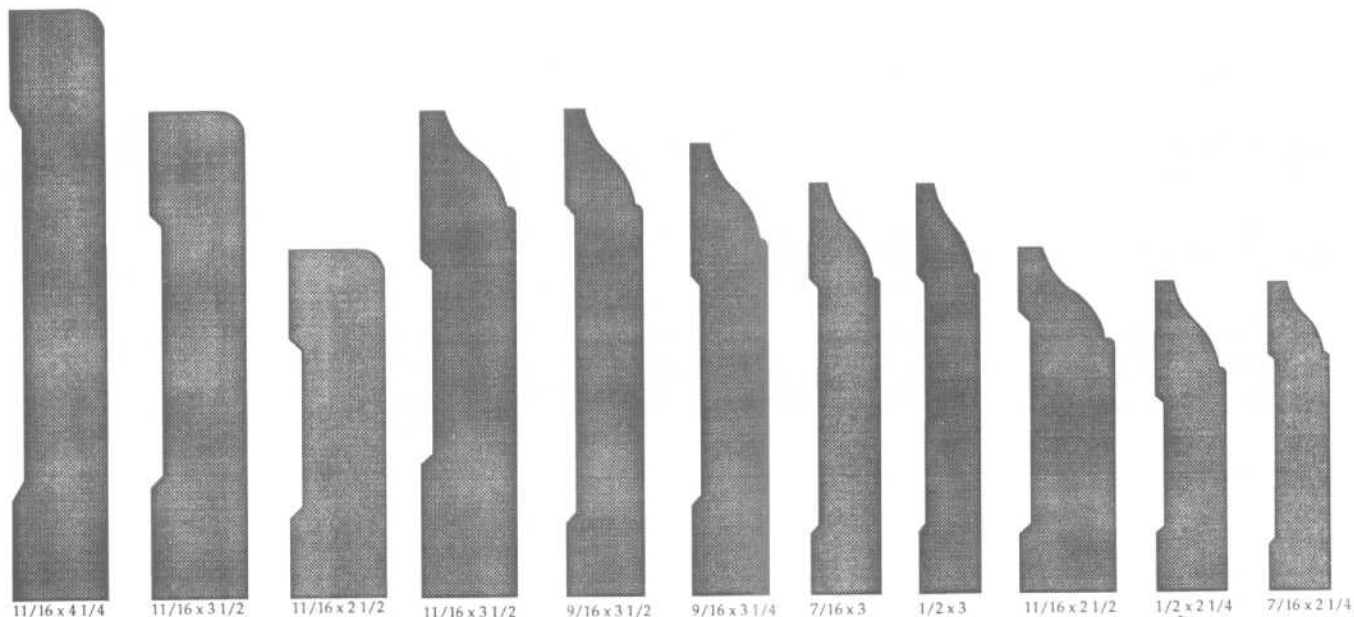


Parting Strip

1/2 x 3/4

CORNICES AND MOULDINGS

Base Mouldings



Quarter Round Moulds

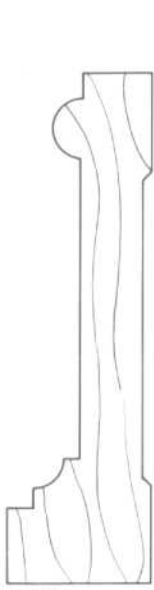


Base Shoe & Floor Moulds



CORNICES AND MOULDINGS

Base Mouldings



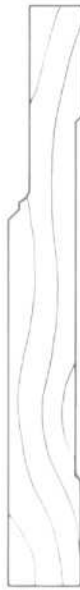
AWI 1861  
1 1/2" x 5 1/2"



AWI 1561  
1" x 4"



AWI 1661  
1 1/2" x 8"



AWI 1461  
1" x 8"



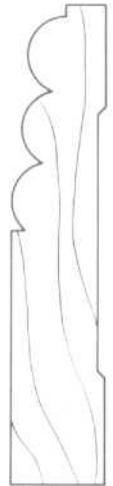
AWI 1441  
1" x 8"



AWI 1451  
1 1/2" x 4 1/2"



AWI 1551  
1" x 4 1/2"



AWI 1552  
1" x 3"



AWI 6421  
3/4" x 1 1/2"



AWI 6422  
3/4" x 1 1/2"



AWI 6521  
3/8" x 1 1/2"



AWI 6531  
1" x 2 1/4"



AWI 1341  
1" x 1 1/2"



AWI 1342  
1" x 1 1/2"



AWI 1343  
1" x 1 1/2"



AWI 1344  
1" x 1 1/2"



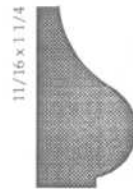
1 1/4 x 2



3/4 x 1 1/2



1 1/16 x 1 3/8



1 1/16 x 1 1/4



1 1/16 x 1 1/8



5/8 x 3/4



3/4 x 1 7/8



3/4 x 1 9/16



1 1/16 x 1 5/8



5/8 x 1 3/8



1 1/16 x 1 3/8



1 1/16 x 1 1/8



5/8 x 1 1/4

Base Cap Moulds

CORNICES AND MOULDINGS

Casings



11/16 x 2 1/4



11/16 x 2 1/4



11/16 x 2 1/2



3/4 x 2 1/2



11/16 x 2 1/2



11/16 x 2 5/8



11/16 x 3 1/2



11/16 x 3 1/2



5/8 x 3 1/4



1/2 x 3 1/4



9/16 x 3 1/4



9/16 x 3 1/4



11/16 x 3 1/2



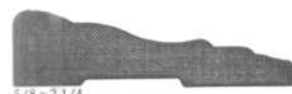
5/8 x 2 1/4



5/8 x 2 3/8



9/16 x 2 1/4



5/8 x 2 1/4



11/16 x 2 1/4



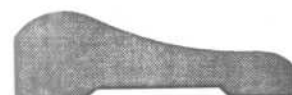
11/16 x 2 1/4



11/16 x 2 1/2



11/16 x 2 1/2



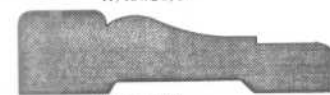
11/16 x 2 1/4



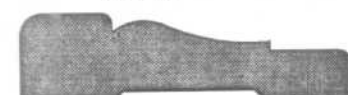
11/16 x 2 1/4



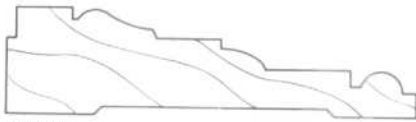
11/16 x 2 3/8



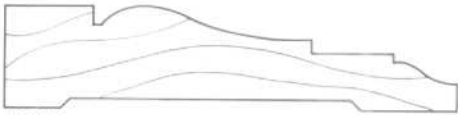
11/16 x 2 1/2



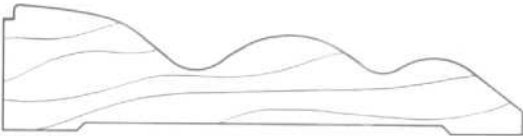
11/16 x 2 5/8



AW/14551  
11 1/2" x 4 1/4"



AW/14552  
11" x 4 1/2"



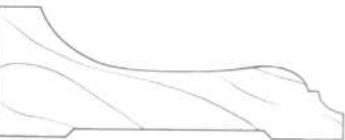
AW/14661  
13 1/2" x 5 1/2"



AW/14662  
13 1/2" x 5 3/4"



AW/14861  
13 1/2" x 5 1/2"



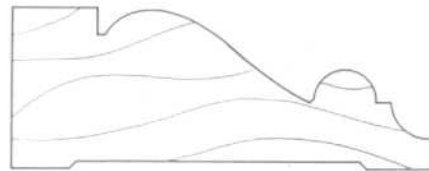
AW/14641  
11 1/2" x 3 1/4"



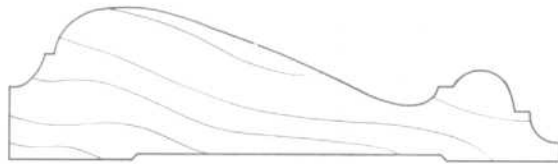
AW/14531  
11" x 3 1/4"



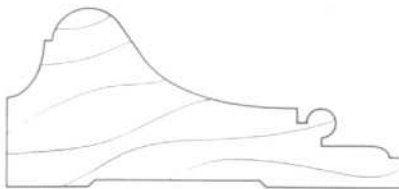
AW/14532  
11" x 2 1/2"



AW/14851  
13 1/2" x 4 1/4"



AW/14862  
11 1/2" x 5 1/4"



AW/14842  
11 1/2" x 3 3/4"



AW/14321  
10" x 3 1/4"



AW/14841  
11 1/2" x 3 1/4"



AW/14332  
10" x 2 1/4"



AW/14842  
11" x 4"



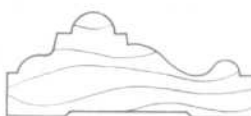
AW/14331  
10" x 2 1/4"



AW/14431  
10" x 2 1/4"



AW/14441  
10" x 3 1/4"



AW/14533  
11" x 2 1/4"

CORNICES AND MOULDINGS

Beaded Casings



11/16 x 2 1/4



11/16 x 2 1/4



11/16 x 2 1/4



11/16 x 2 1/2



11/16 x 2 1/2



11/16 x 2 1/2



11/16 x 2 3/4



11/16 x 2 3/4



3/4 x 2 1/4



11/16 x 3 1/4



11/16 x 3 1/4



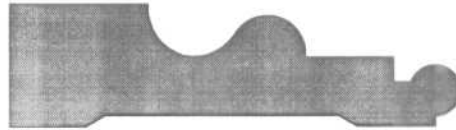
11/16 x 3 1/4



9/16 x 3 1/4



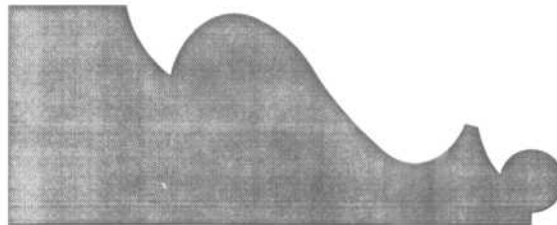
11/16 x 3 1/2



1 1/4 x 4 3/4



7/8 x 4 3/4



2 1/4 x 5 1/2

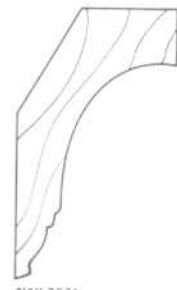
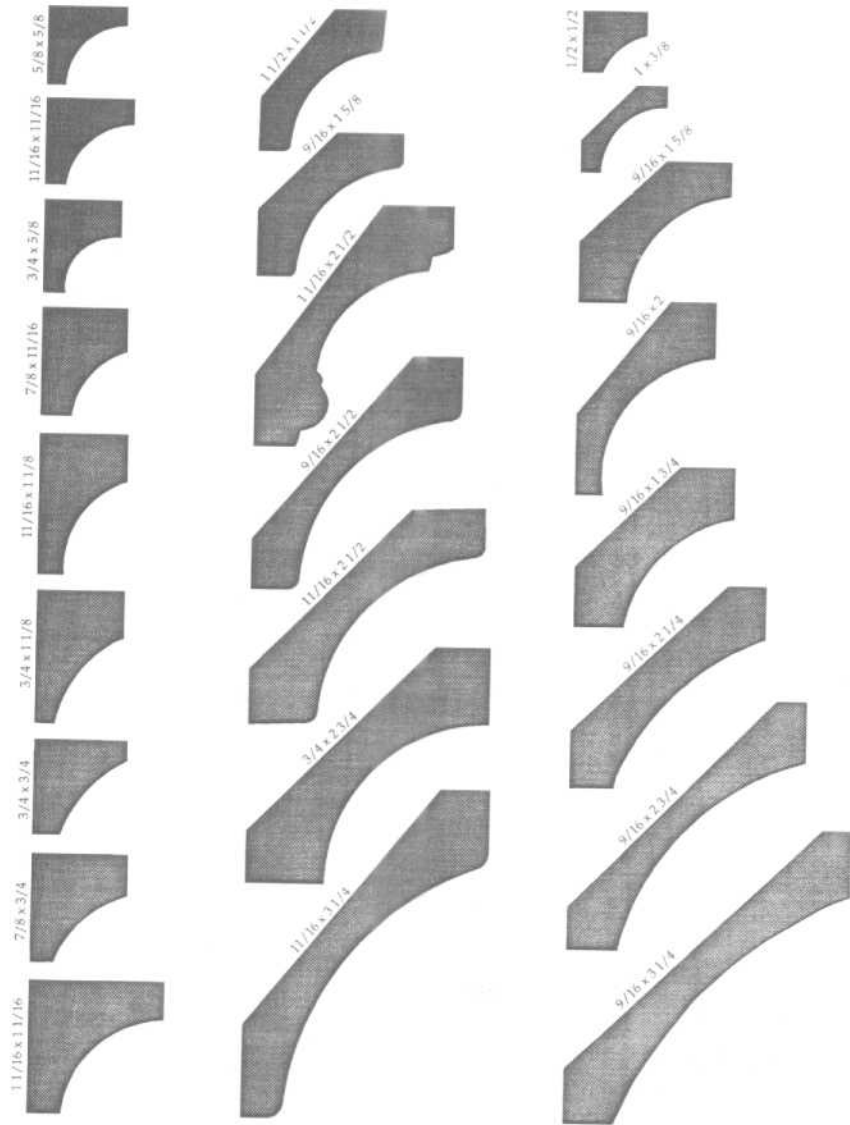


1 1/4 x 6 1/8

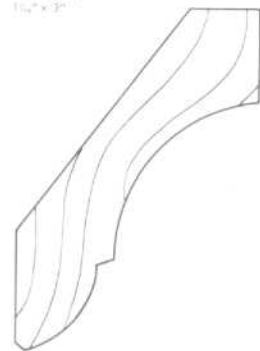
Specialty casings

CORNICES AND MOULDINGS

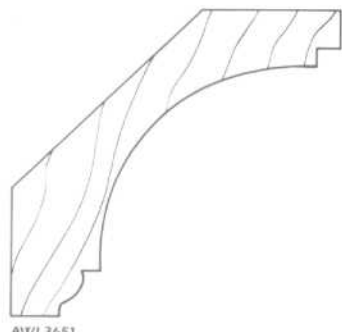
Cove Mouldings



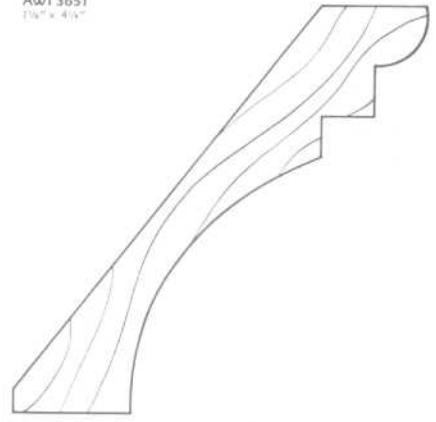
AW/I 3531  
1 1/4" x 2"



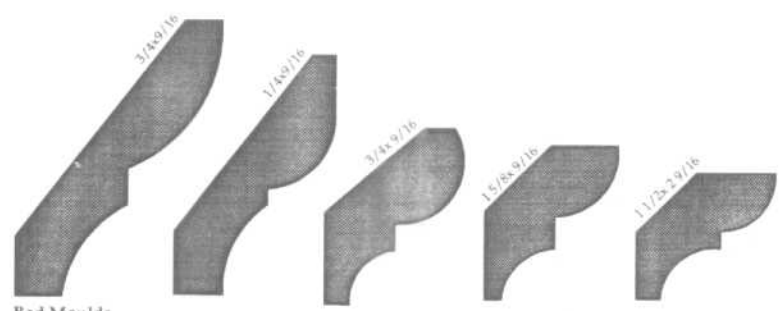
AW/I 3542  
1 1/2" x 3 1/2"



AW/I 3651  
1 1/2" x 4 1/2"



AW/I 3561  
1 1/2" x 5 1/2"



Bed Moulds

CORNICES AND MOULDINGS

Panel Mouldings



AW/I 12631  
1 1/4" x 3"



AW/I 12531  
1" x 2 1/2"



AW/I 12522  
1" x 2"



AW/I 12523  
1" x 1 1/2"



AW/I 12321  
3/4" x 1 1/2"



AW/I 12322  
3/4" x 1 1/2"



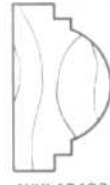
AW/I 12521  
3/4" x 2"



AW/I 12421  
3/4" x 1 1/2"



AW/I 12422  
3/4" x 1 1/2"



AW/I 12423  
3/4" x 1 1/4"



AW/I 12424  
3/4" x 1 1/4"



AW/I 12323  
3/4" x 1 1/2"



AW/I 12221  
3/4" x 1 1/4"



11/16 x 1 5/8



11/16 x 1 5/8



11/16 x 1 1/2



5/8 x 1 5/8



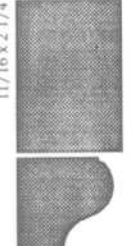
5/8 x 1 3/4



9/16 x 2



11/16 x 2 1/2



11/16 x 2 1/4



11/16 x 2



11/16 x 2 1/2



1 x 2



1 x 2



7/8 x 2



7/8 x 2



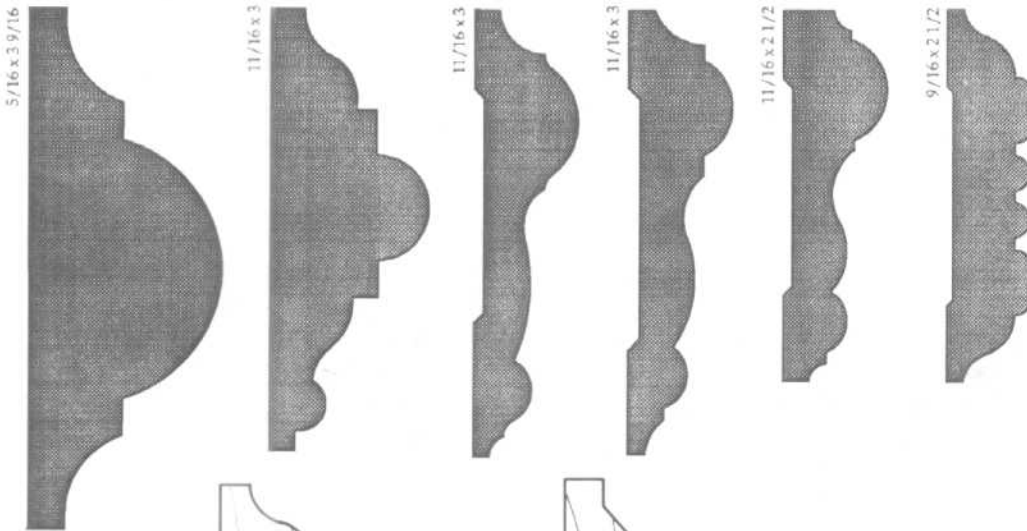
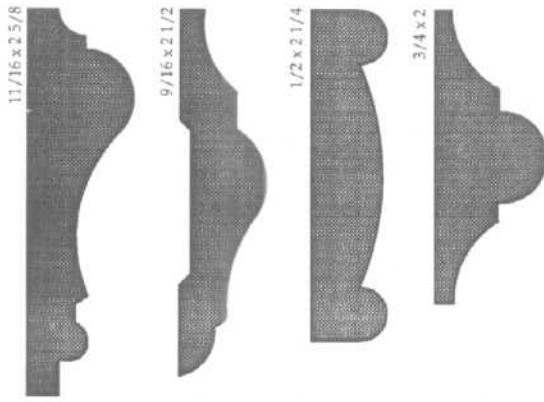
7/8 x 7/8



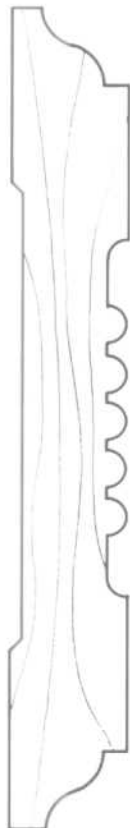
11/16 x 2

CORNICES AND MOULDINGS

Chair Rail Mouldings



AWI 10461  
3/4" x 6"



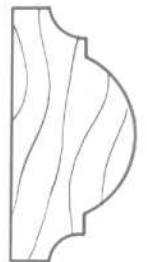
AWI 10462  
1/4" x 5 3/8"



AWI 10463  
1 3/16" x 5 1/16"



AWI 10431  
3/4" x 2 1/2"



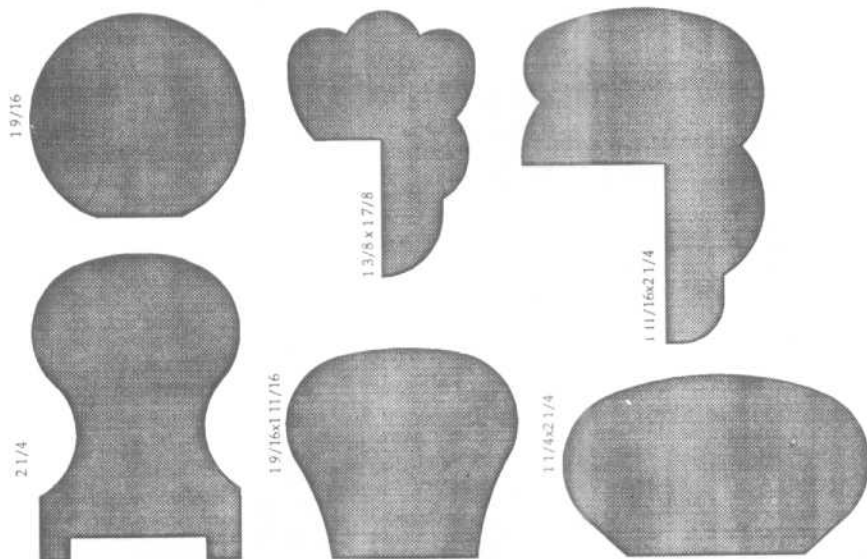
AWI 10421  
1 1/16" x 1 5/8"



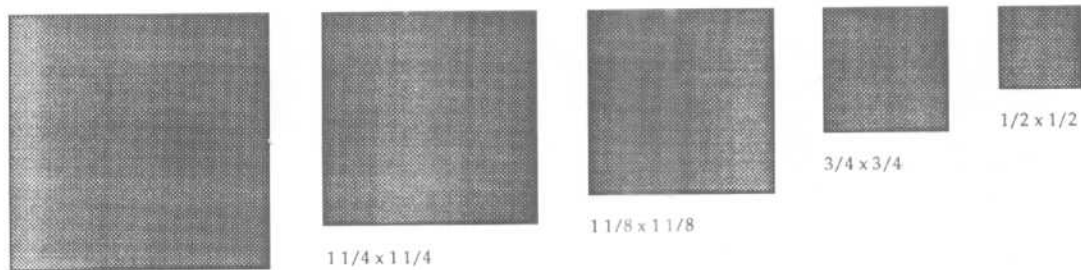
AWI 10432  
3/4" x 2 1/2"

CORNICES AND MOULDINGS

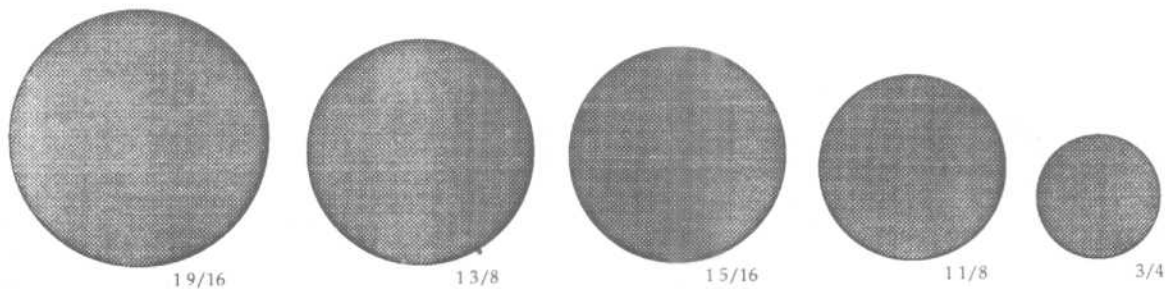
Handrails, Balusters, and Rounds



Handrails



Baluster



Round Moulds



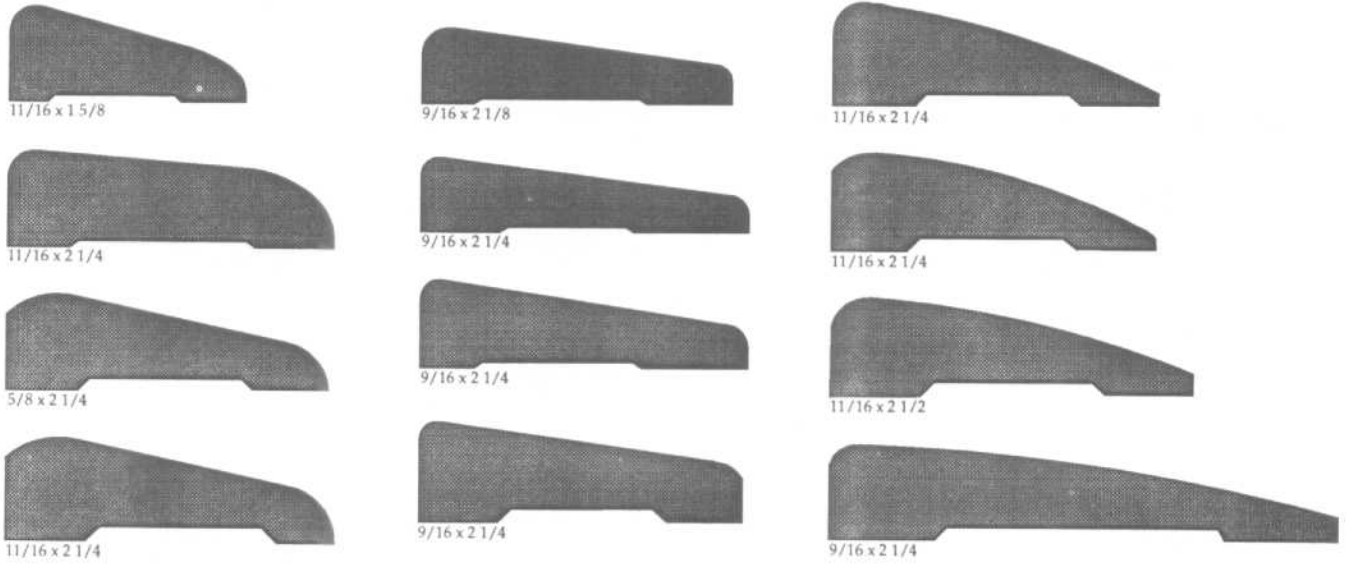
Half Rounds



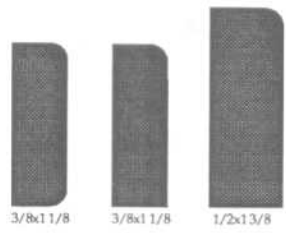
**CORNICES AND MOULDINGS**

Clam Shell and Stop Mouldings

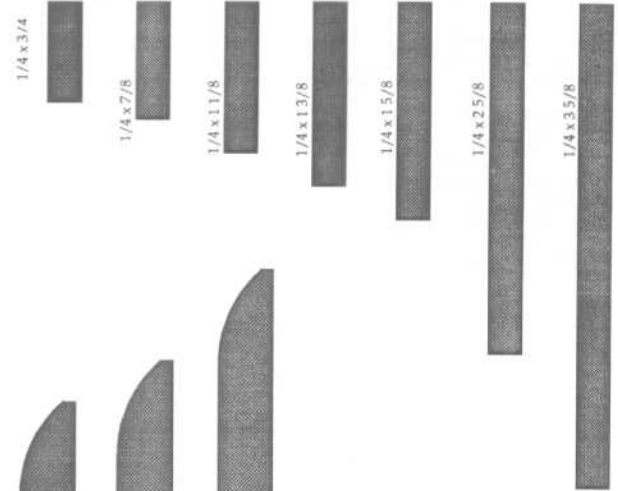
**CLAM SHELL MOULDINGS**



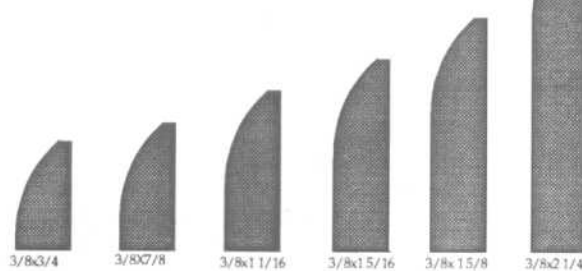
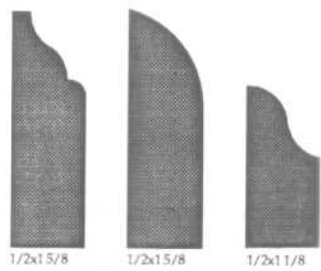
**STOP MOULDINGS**



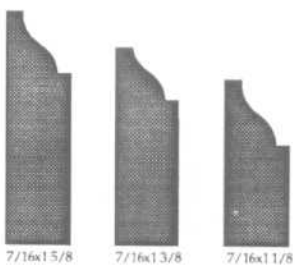
**Lattice**



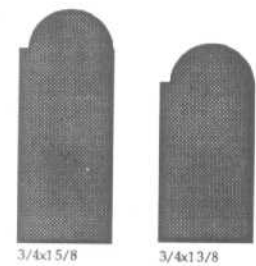
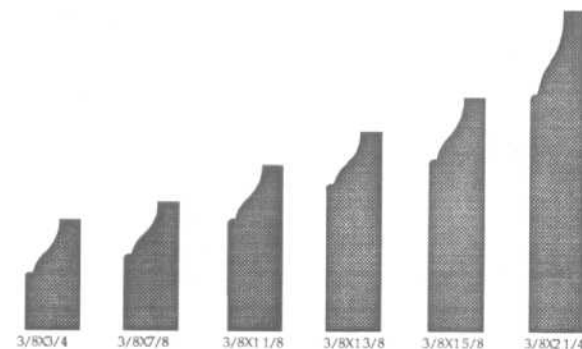
**Sanitary**



**Sash**



**Clam Shell**



**Sash**

**Sash**

**Colonial**

CORNICES AND MOULDINGS

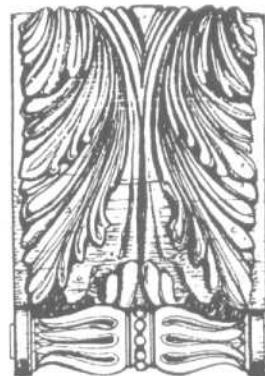
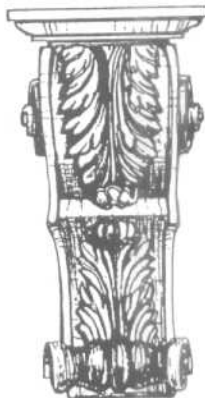
Hand-Carved Brackets



Flute & Lyre  
10½"W x 11"H



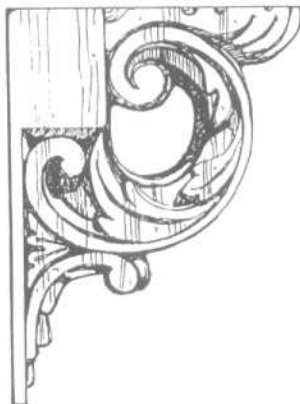
Bracket  
6½"W x 12½"H x 5¼"D.



Bracket  
8"W x 12"H x 4"D.



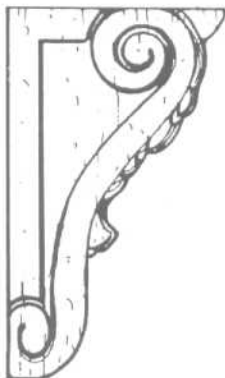
Left & Right Scroll  
8¾"W x 11½"H



Bracket  
4½"W x 13"H x 9½"D.



Bracket  
4"W x 8½"H x 1¾"D.



Bracket  
2¾"W x 12"H x 7"D



Bracket  
7½"W x 14"H x 7½"D



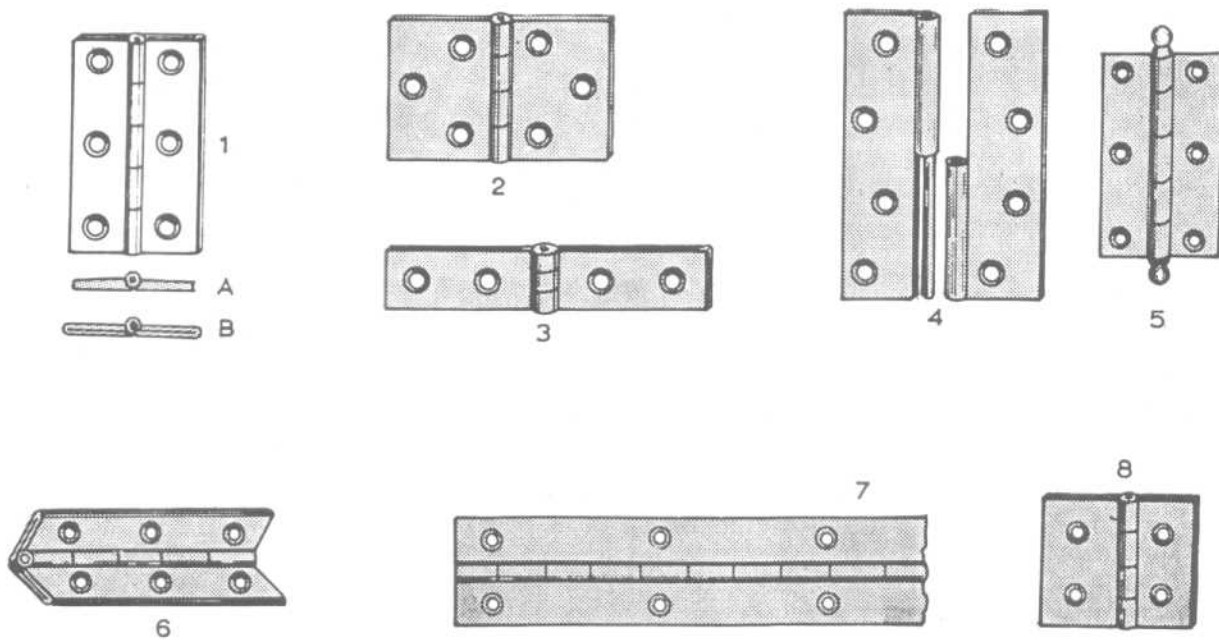
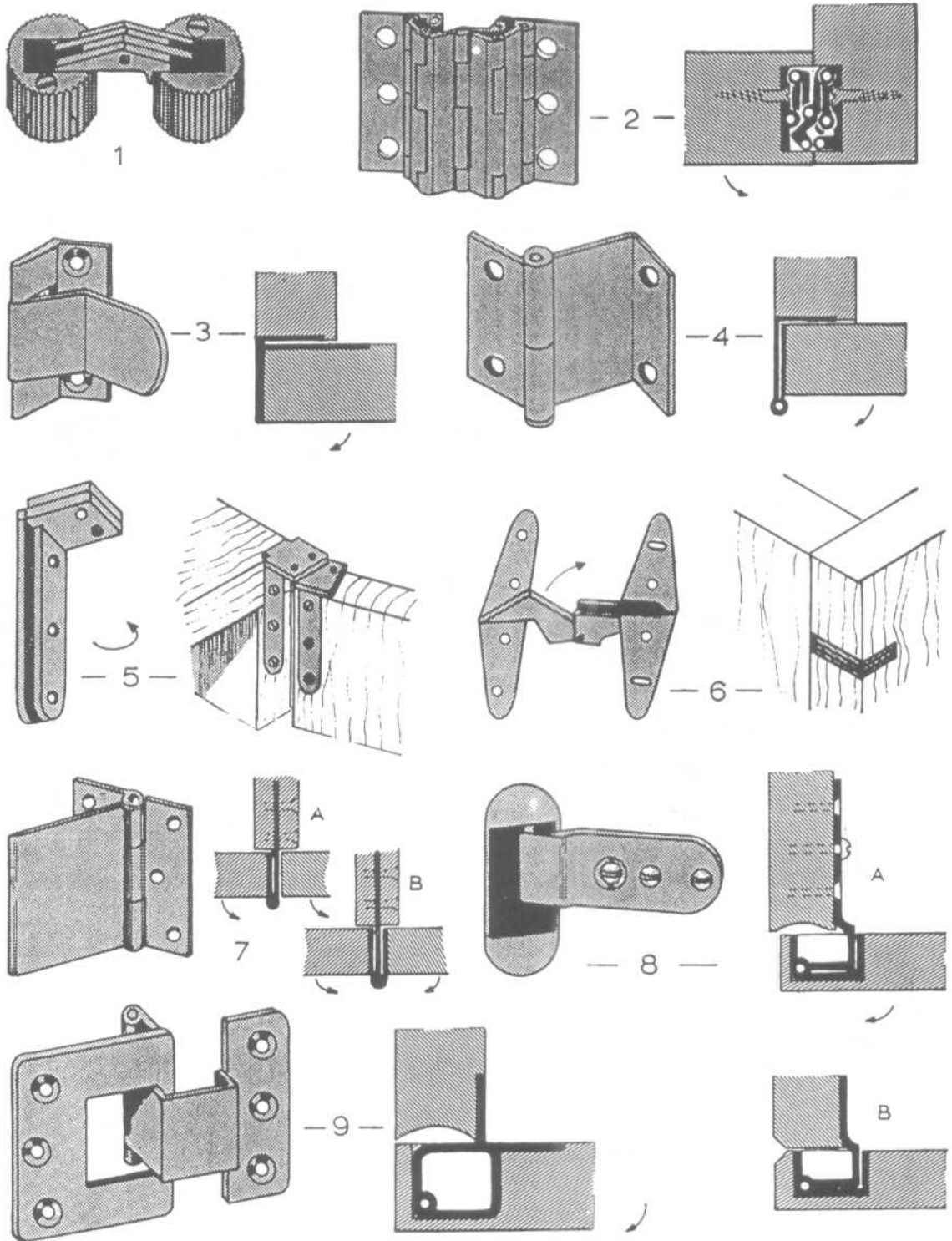


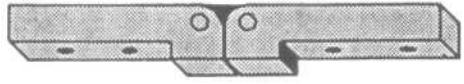
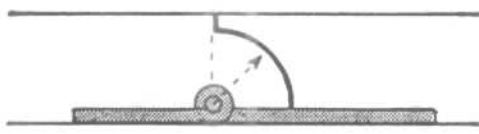
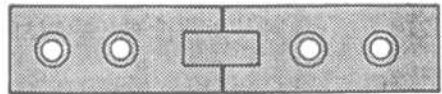
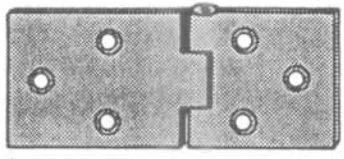
TABLE 1 Butt Hinges

No.	Type	Comments
1	Standard brass butt: A, solid drawn type; B, pressed pattern	General usage
2	Back flap hinge	With wide plates for table leaves and rebated or rabbeted fallflaps
3	Strap hinge	For narrow sections
4	Lift-off butt	For doors which have to be removed from time to time without disturbing setting
5	Loose pin hinge; ball-tipped hinge	Where it is necessary to throw door clear of carcass frame with the whole or the hinge knuckle protruding
6	Stopped hinge	Opens through 90° only for box lids, etc.
7	Piano hinge	Continuous strip form for supporting long lengths; supplied in drilled and countersink or undrilled blanks
8	Clock case hinge	One plate is wider to allow for a projecting door

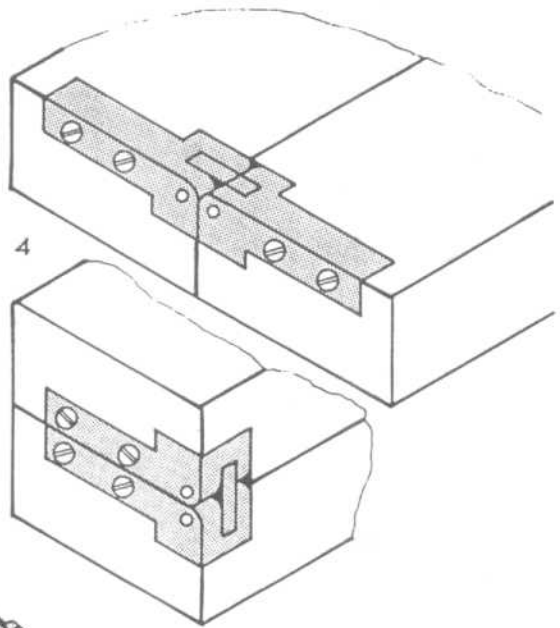
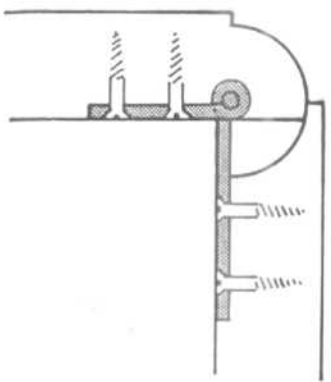
FURNITURE HARDWARE

Hinges

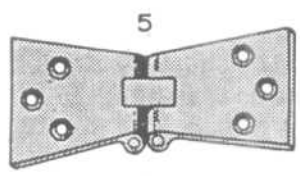




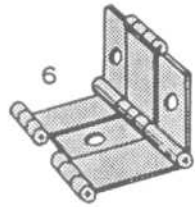
2



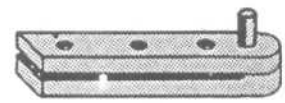
4



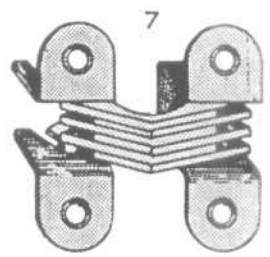
5



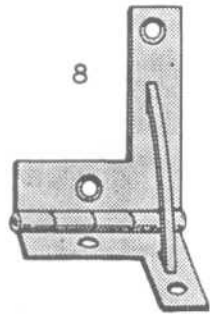
6



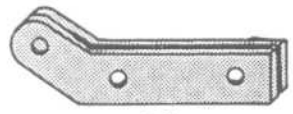
9



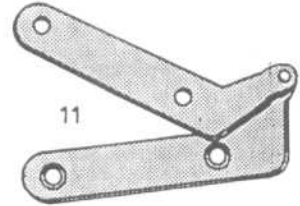
7



8



10



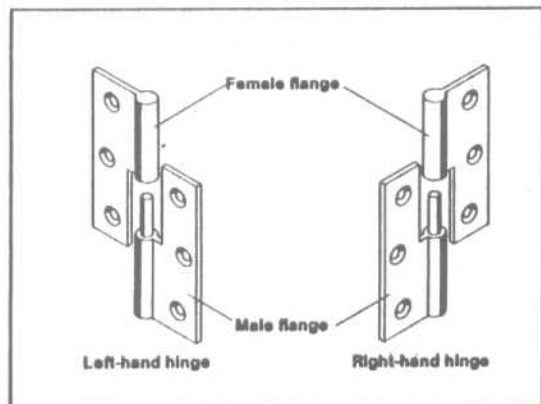
11

FURNITURE HARDWARE

Hinges

**Left- and Right-Hand Hinges**

Hinges with screw-mounted flanges should be viewed as if in mounted condition with the countersunk screw holes facing you. If the female flange is uppermost on the left, the hinge is a left-hand hinge and vice versa.

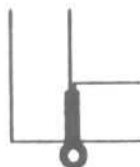


**Cranked Hinges and Their Uses**

The position of the door relative to the side panel can vary considerably, being decided at the design stage in accordance with the final effect required. A wide variety of hinge types has developed from variations in door mounting methods, which must be coordinated at the design stage.

**Straight hinge**

For butting, flush or front-hung doors. The barrel is positioned centrally between the two flanges.



**Crank B**

Mounting with set-back doors. One flange is cranked by an amount equivalent to the thickness of the material.



**Crank C**

Similar to crank B but for forward-set doors.



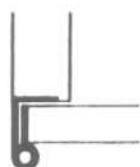
**Crank D**

Mounting with rebated doors with flanges of non-uniform width (reduced female flanges).



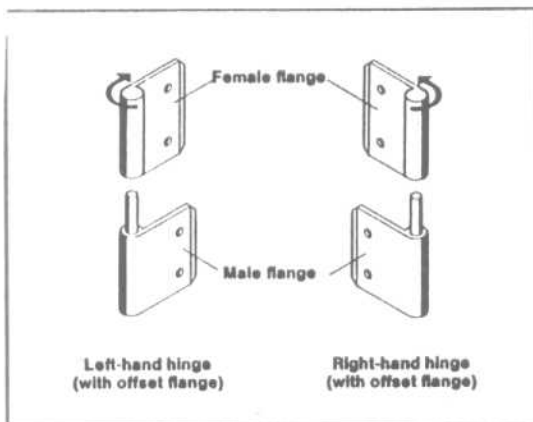
**Crank L1**

Mounting with butting front-hung doors. Door opening range 270°. Crank features internal roll.



**Butt Hinge Designations**

Butt hinges for cupboards, windows, and doors, and hinges with mortise-type flanges should be viewed with the barrel facing you. If the female flange is positioned on the left of the barrel, it is a left-hand hinge and vice versa.



The same rule applies to hinges with symmetrical flanges.

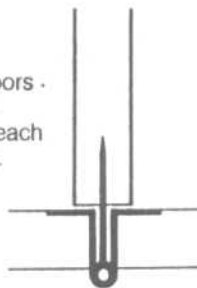
**Butt hinge**

The hinge is made with offset flanges for mortised mounting. The door-mounted flange is secured with screws or pins from the rear or front (giving exposed heads).



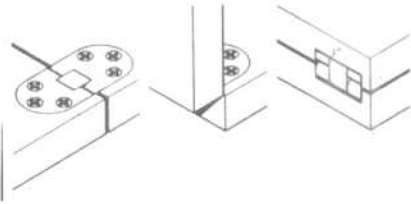
**Double butt hinge**

Suitable for mounting two doors to a single centre panel. The door opening range is 180° each (centre flange only mortised).

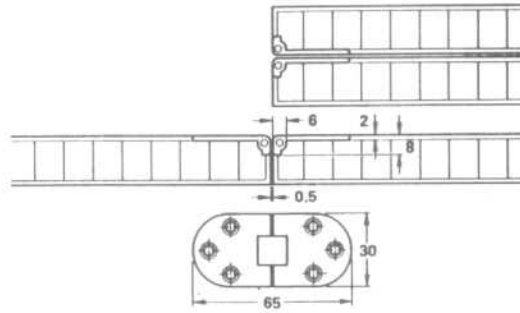


FOLDING TABLE HINGE

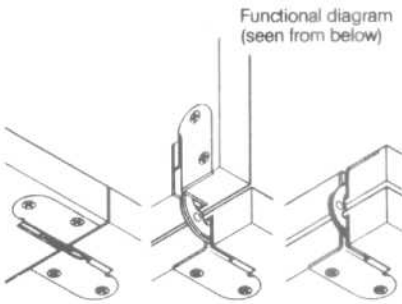
Functional diagram



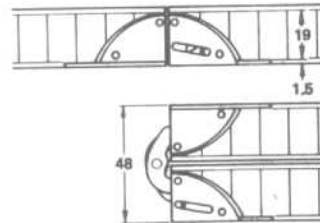
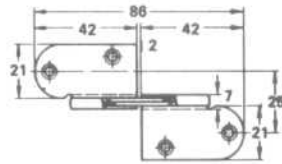
Self-supporting hinge, for folding and sewing machine tables, flush-mounted



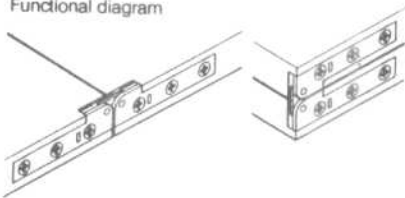
Functional diagram (seen from below)



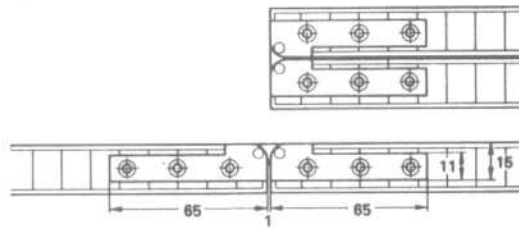
Folding table hinge, flush-mounted



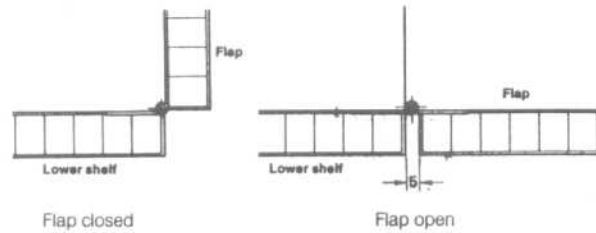
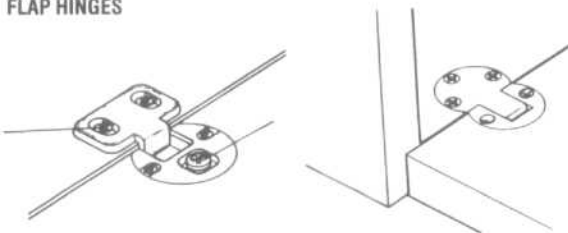
Functional diagram



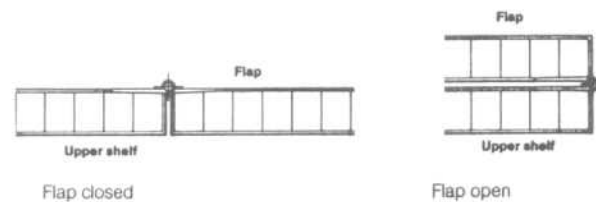
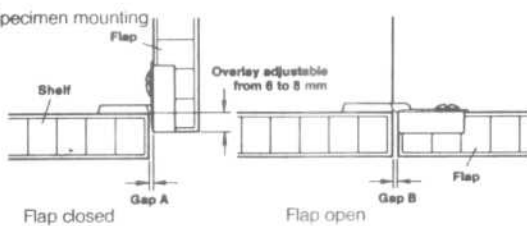
Card table hinge Two-way table-leaf hinge, flush-mounted



FLAP HINGES



Specimen mounting

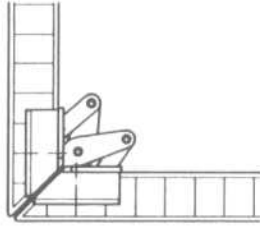


**FURNITURE HARDWARE**

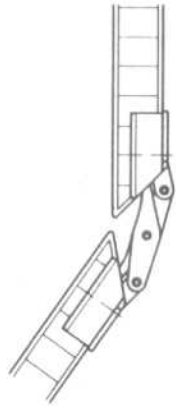
Mitred and Concealed Hinges

**MITRED HINGE**

The hinges are suitable for wooden doors and side panels from 16 mm to 22 mm in thickness, chamfered at an angle of 45°.



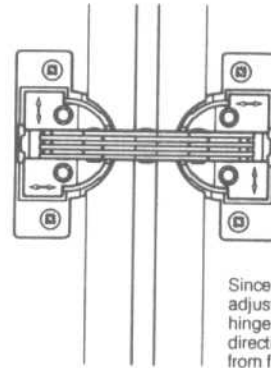
Door closed



Door open

For the first time a concealed hinge is available for modern furniture incorporating 45° mitre angles.

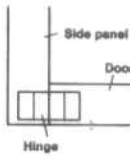
An all-metal mitred hinge, specially designed to enable door and carcass edges to meet at an angle of 45°.



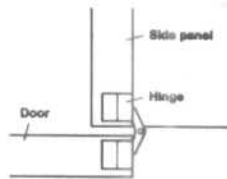
Since both bosses have the same adjustment facilities, the complete hinge can be adjusted in three directions, vertically, laterally and from front to back.

**CONCEALED HINGES**

Specimen installation of a butting, flush-fitting cupboard door. Doors may, however, be set back or forward if preferred, provided the housing recesses are appropriately offset. If doors are set back, care must be taken to ensure that the opening angle is restricted as little as possible.

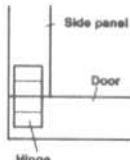


Door closed

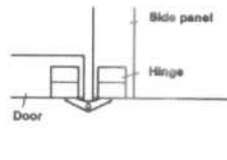


Door open

Specimen installation of a butting, front-hung door, fitting flush with the cupboard side in the conventional manner. Doors may, however, be hung with inset edge if preferred, provided the housing recesses are offset accordingly. It is important in such cases to ensure that centre doors are not mounted with groove gap clearance.

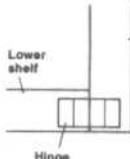


Door closed



Door open

Specimen installation of a butting, front-hung, flap-type door. On opening, the flap projects downwards by its own thickness. Thus, if doors or other panels are situated below the flap, a degree of clearance exceeding the flap thickness will be necessary.



Flap closed

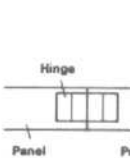


Flap open

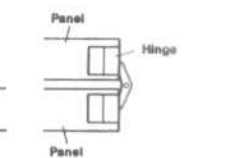
Specimen installation joining two panels. In this way folding doors can be constructed for furniture or room dividers:



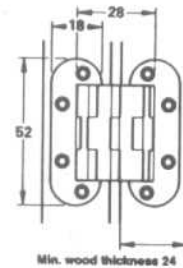
Typical folding door



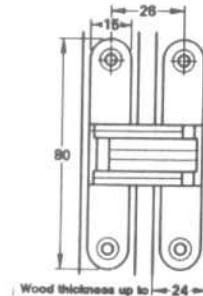
Door closed



Door open



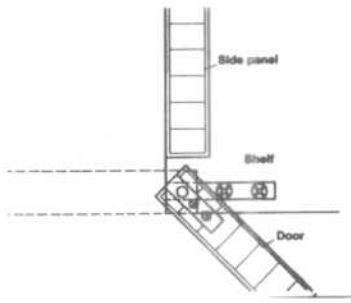
Min. wood thickness 24



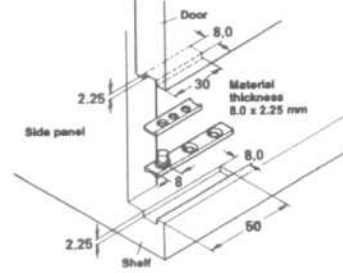
Wood thickness up to 24

Dimensions in mm.

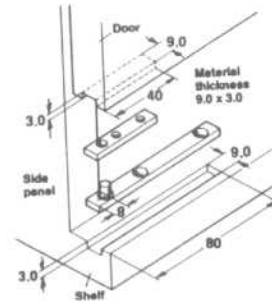
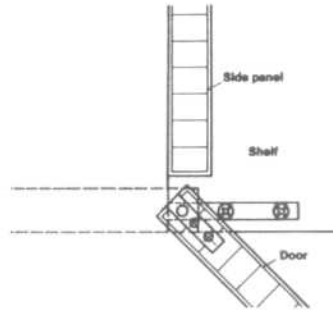




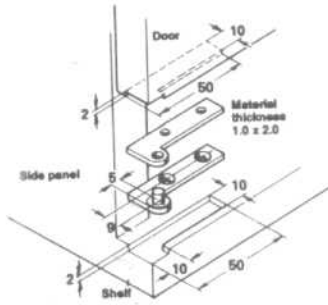
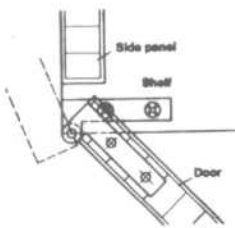
Dimensions in mm



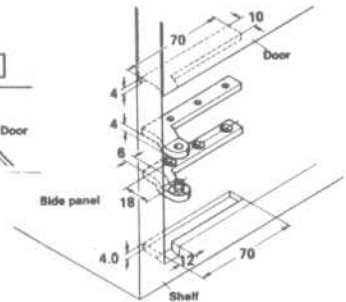
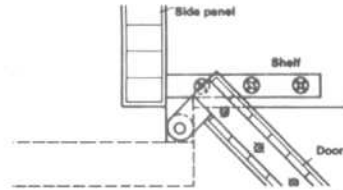
Pivot hinge, without stop  
Hollow drawn, with one short flange



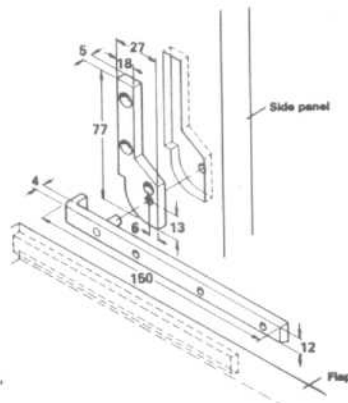
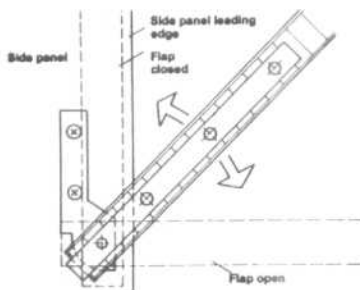
Pivot hinge, without stop  
Smooth drawn, with one short flange



Corner pivot hinge, without stop  
With outer knuckle, straight



Corner pivot hinge, without stop  
With outer knuckle, cranked

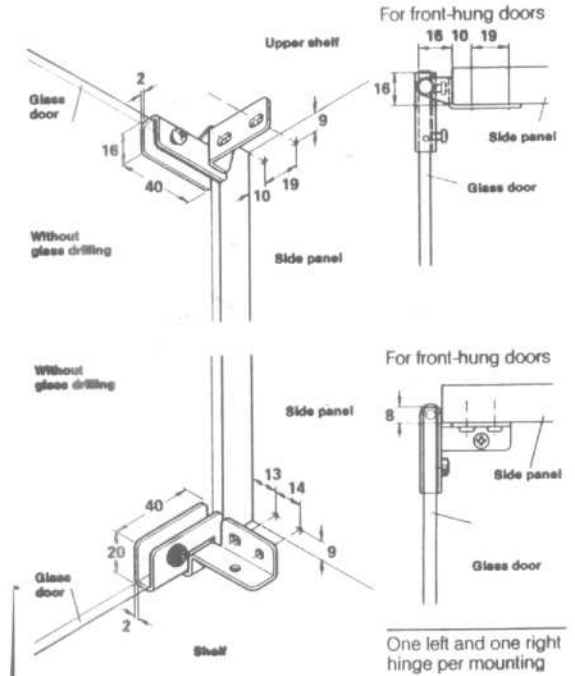
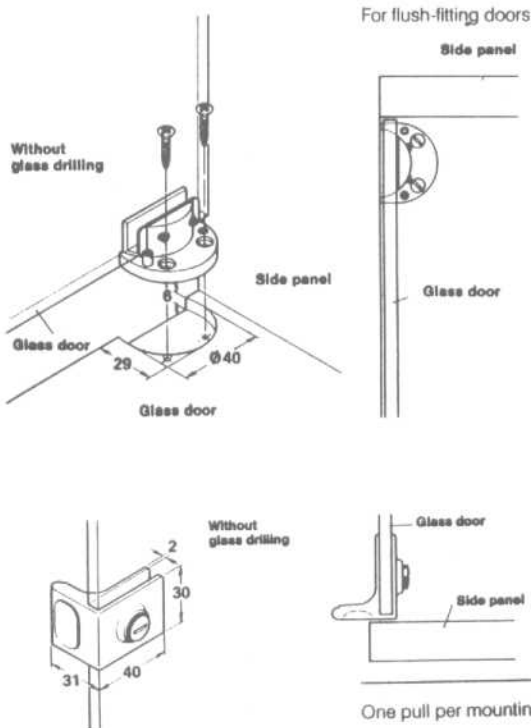
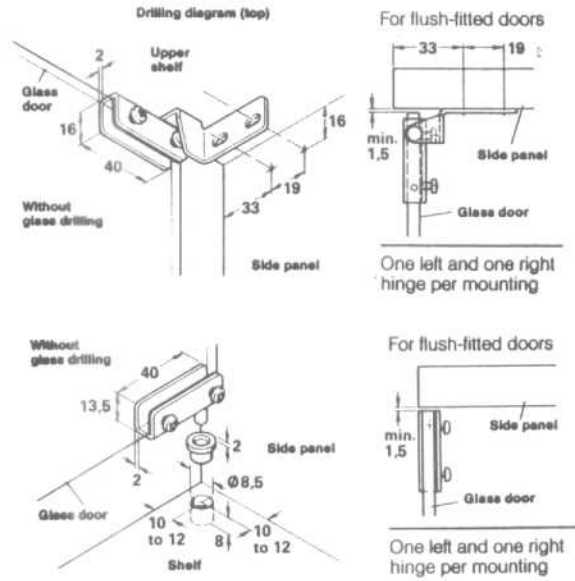
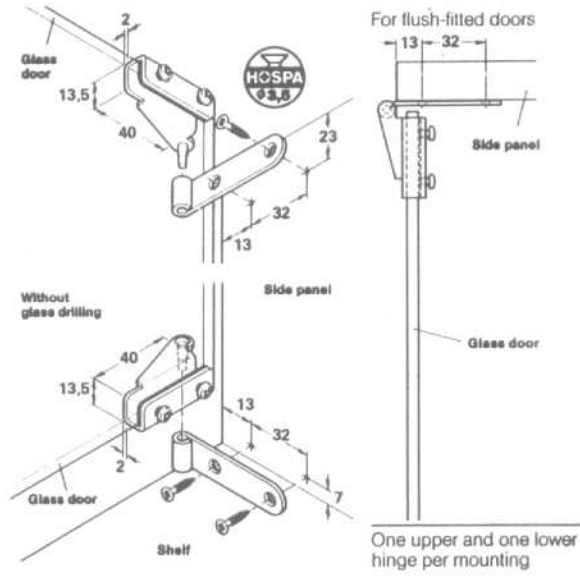


Pivot hinges for writing bureau drop leaf mounting,  
smooth drawn.

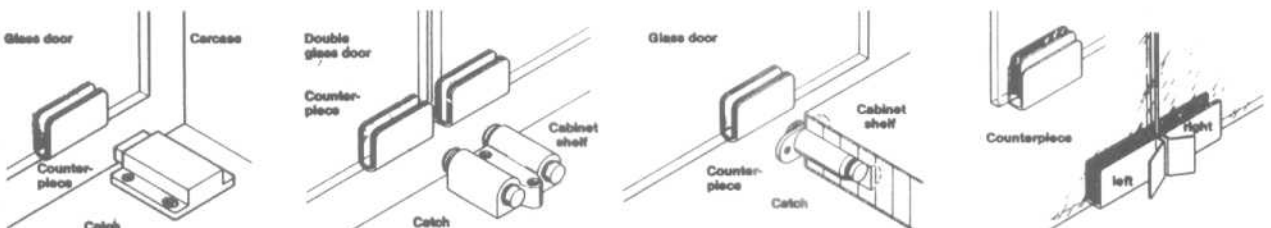
Dimensions in mm.

FURNITURE HARDWARE

Glass Door Hinges



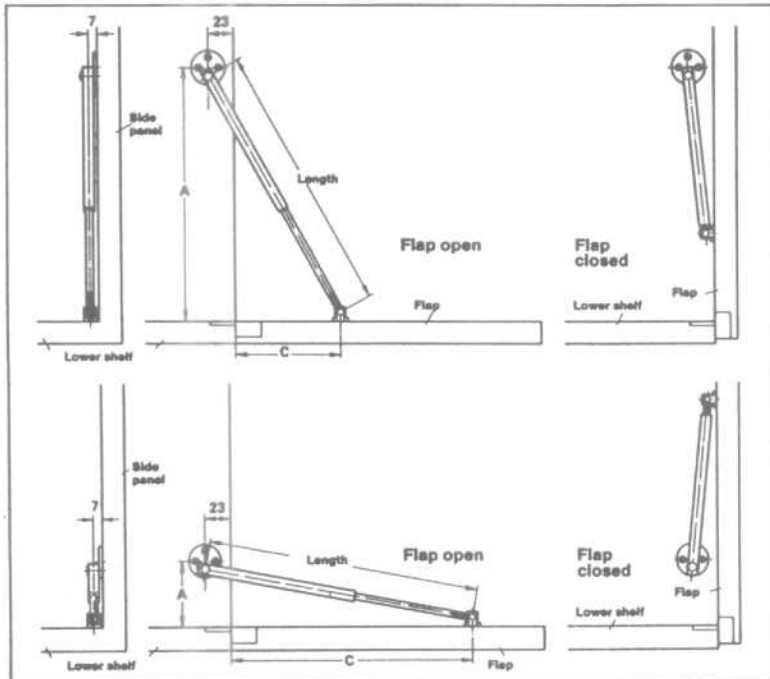
Magnetic Pressure Catches



Dimensions in mm.

FURNITURE HARDWARE

Flap Stays with Brake

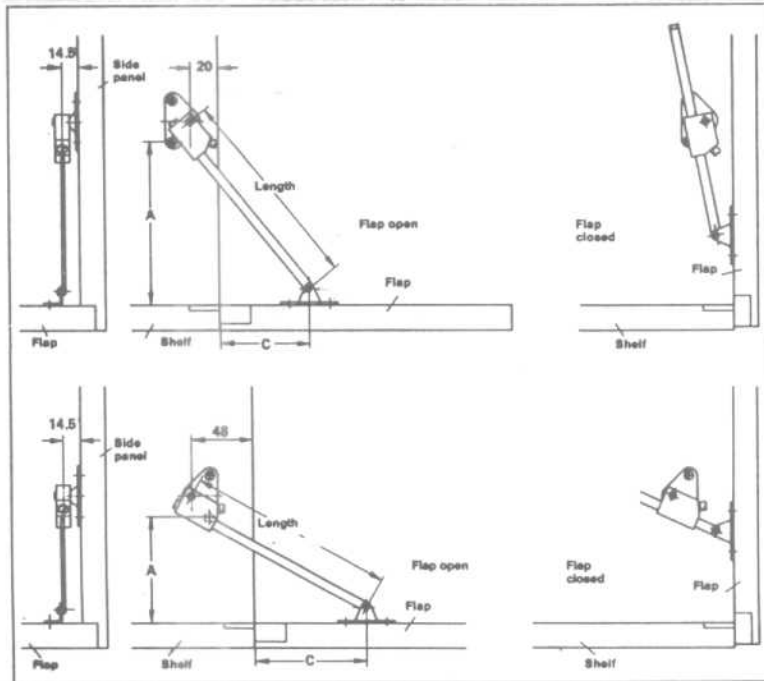


Vertical mounting

Length (mm)	Internal carcass height (mm)	Distance A (mm)	Distance C (mm)
250	300 to 400	240	Determine by trial mounting
325	350 to 450	308	
450	400 to 500	430	

Horizontal mounting

Length (mm)	Internal carcass height (mm)	Distance A (mm)	Distance C (mm)
250	300 to 400	65	Determine by trial mounting
325	350 to 450	100	
450	400 to 500	150	

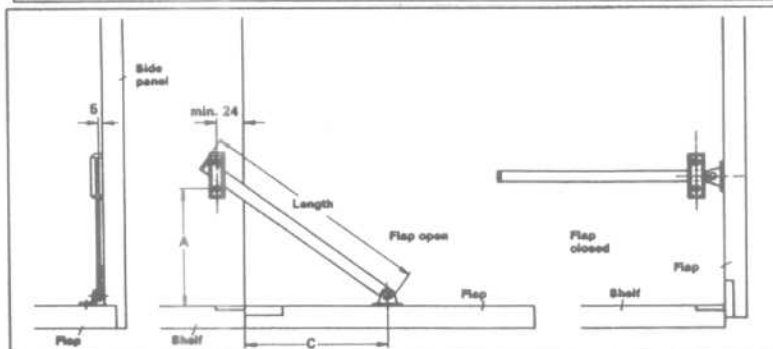


Vertical mounting

Length (mm)	Internal carcass height (mm)	Distance A (mm)	Distance C (mm)
160	250 to 350	127	Determine by trial mounting
190	300 to 400	151	
220	350 to 450	175	
250	400 to 500	198	
280	450 to 550	222	

Horizontal mounting

Length (mm)	Internal carcass height (mm)	Distance A (mm)	Distance C (mm)
160	200 to 300	82	Determine by trial mounting
190	230 to 330	105	
220	260 to 360	127	
250	290 to 430	148	
280	320 to 460	171	

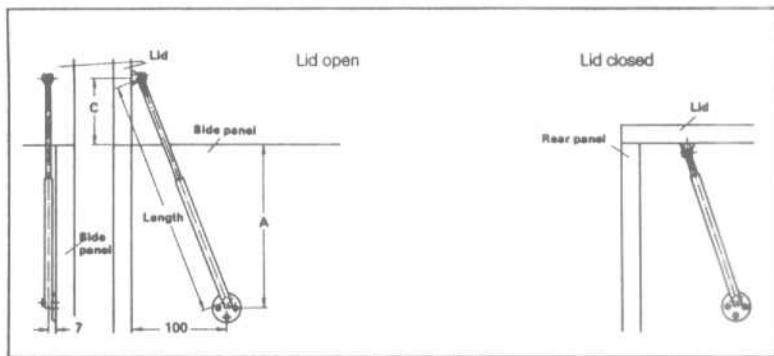


Length (mm)	Internal carcass height (mm)	Distance A (mm)	Distance C (mm)
150	min. 130	70	Determine by trial mounting
200	min. 170	105	
250	min. 210	140	

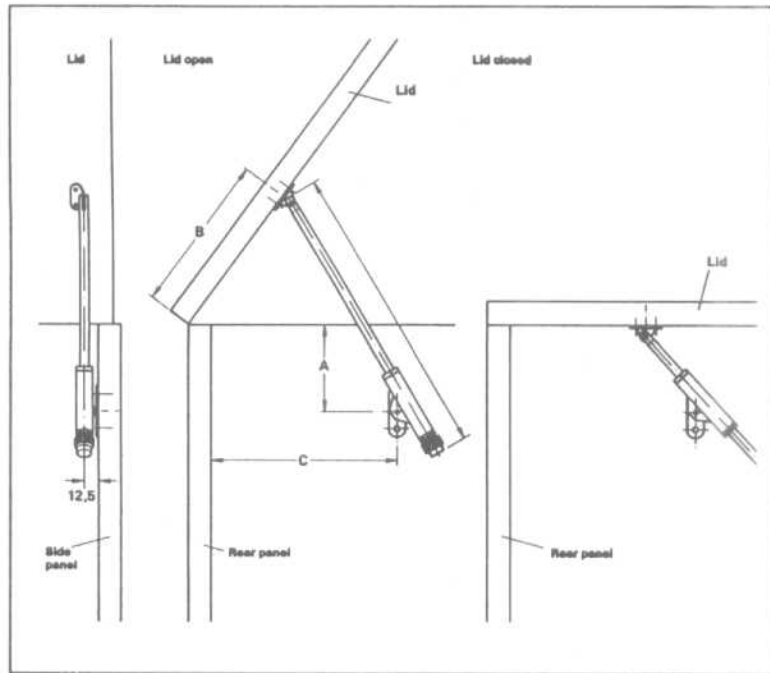
Dimensions in mm.

FURNITURE HARDWARE

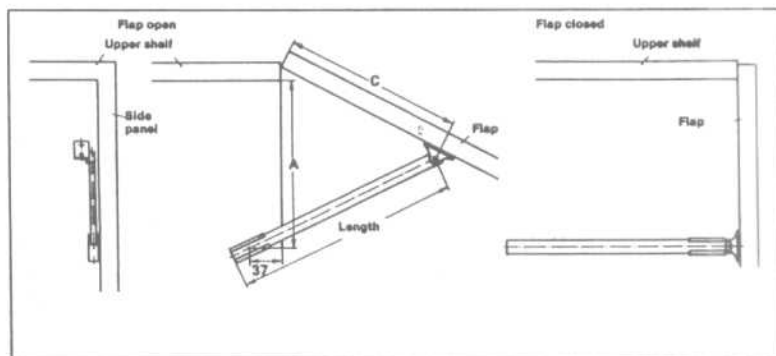
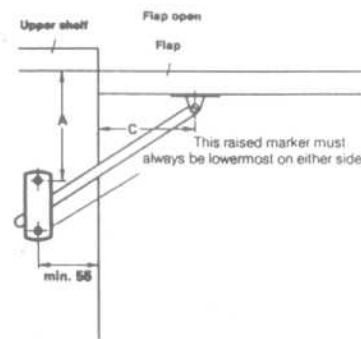
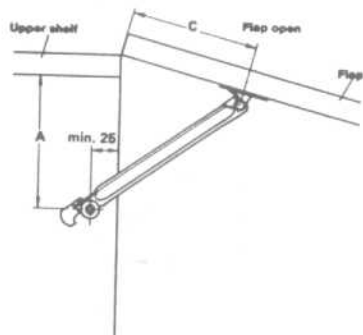
Lid Stays



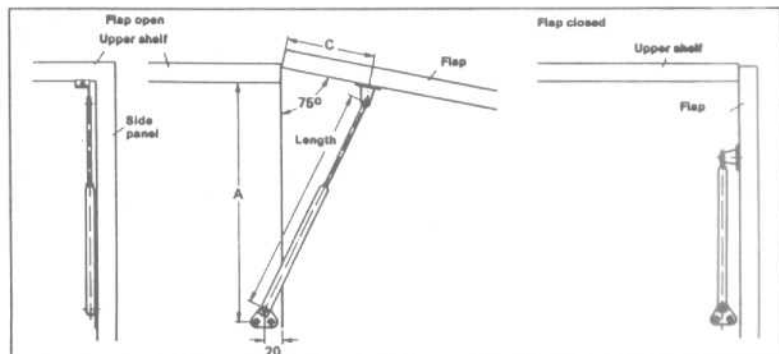
Length (mm)	Lid height (mm)	Distance A (mm)	Distance C (mm)
250	up to 300	170	Determine by trial mounting
325	up to 450	205	
450	over 450	275	



Length (mm)	Distance A (mm)	Distance B (mm)	Distance C (mm)
145	Determine by trial mounting		
260	depending on opening angle of lid.		
330			



Length (mm)	Carcass depth (mm)	Distance A (mm)	Distance C (mm)
200	210	150	Determine by trial mounting
250	260	180	
300	310	230	



Length (mm)	Distance A (mm)	Distance C (mm)
130	150	Determine by trial mounting
250	260	

Dimensions in mm.

**Extension type**

Soft-Roller systems are capable of varying degrees of extension, depending on design. Basically, three types are employed:

**E – Single extension**

The withdrawal distance offered by single extensions is designed to be less than the installation length. Drawers cannot be opened clear of the carcass.



**V – Full extension**

The full extension model incorporates a pull-out distance as great as, or greater than, the installation length. Drawers can be opened completely clear of the carcass.



**T – Telescopic extension**

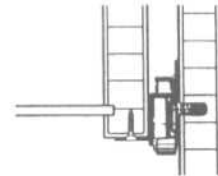
Telescopic extensions are fully extending systems. Their particular design is such that all the elements travel on a central axis resulting in a particularly neat, space-saving, compact assembly.



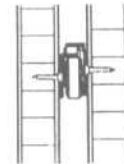
**Mounting method**

An indication as to how the rails are secured to the drawer or pull-out element.

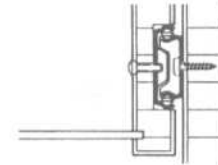
**A – Base mounted**



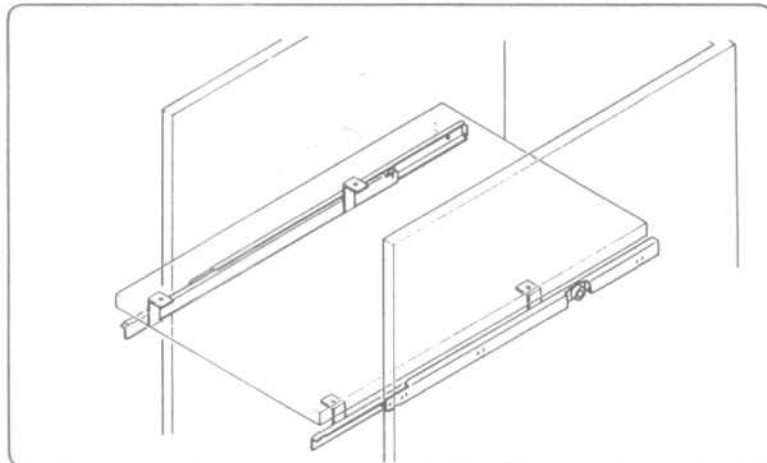
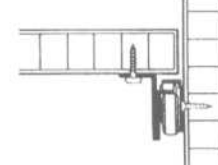
**S – Side mounted**



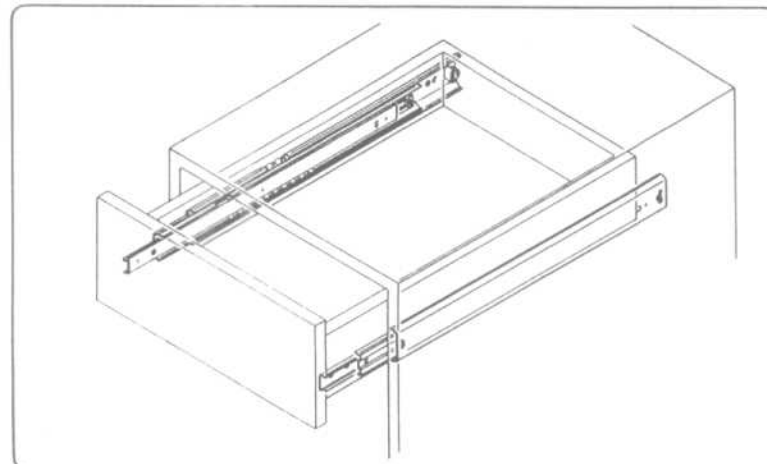
**N – Groove mounted**



**T – Shelf mounted**



Single extensions with friction bearing mounted nylon rollers

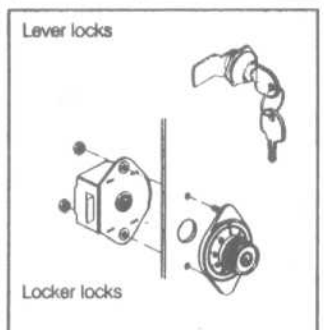
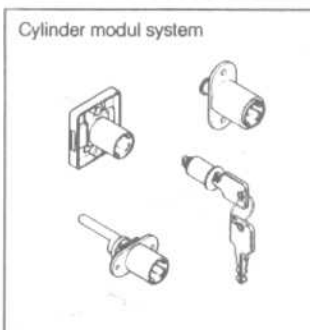
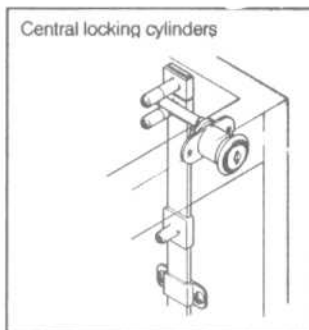
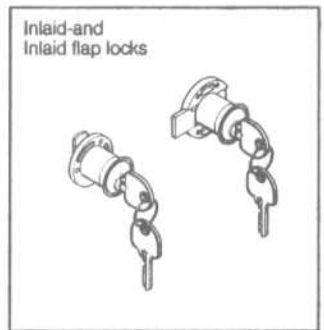


Telescopic extensions guided by means of ball cages

FURNITURE HARDWARE

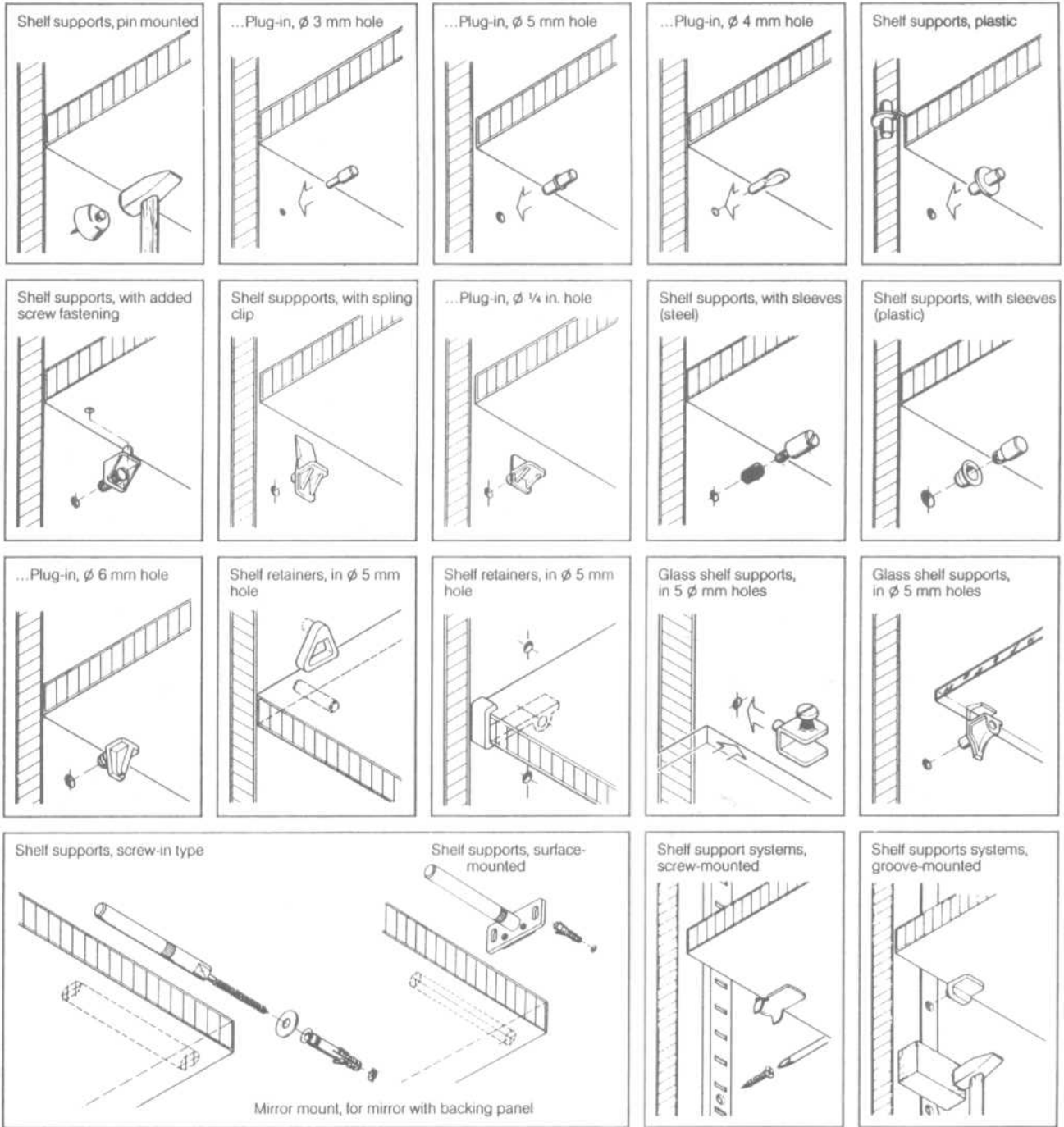
Magnetic and Spring Catches; Bolts





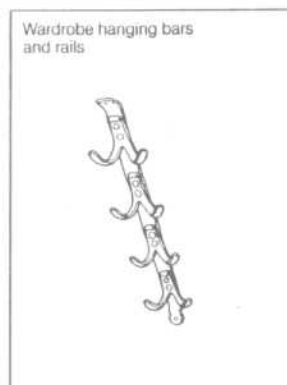
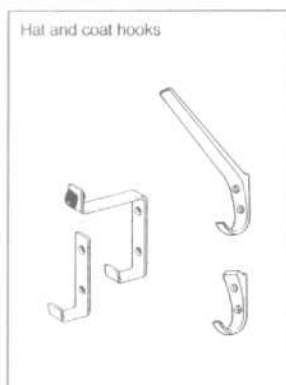
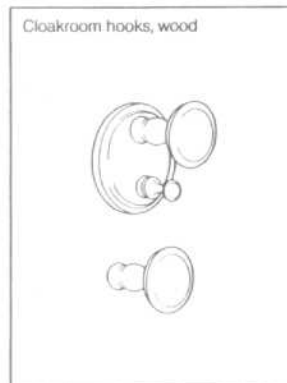
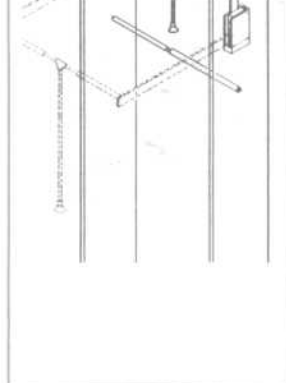
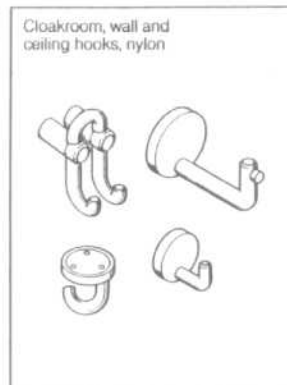
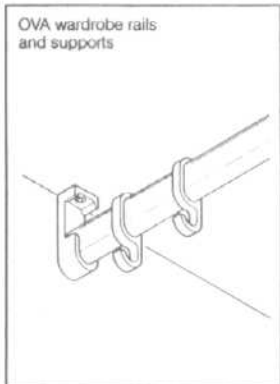
FURNITURE HARDWARE

Shelf Supports

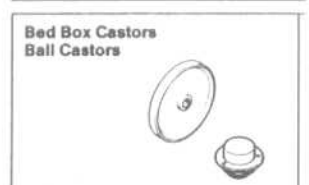
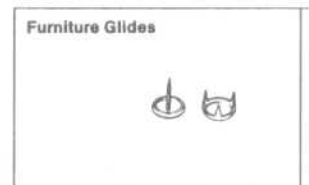
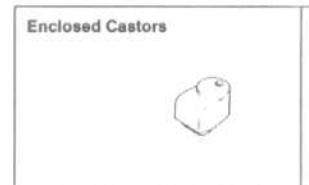
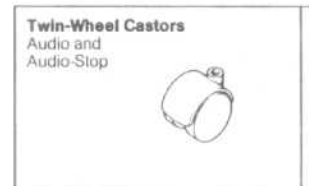




**WARDROBE RAILS AND SUPPORTS**



**CASTORS AND GLIDES**



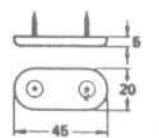
FURNITURE HARDWARE

Furniture Glides

knock-in furniture glides

Furniture glide  
With two pins  
Finish: white plastic

Size 45 × 20 × 5 mm



Dimensions in mm

Chairleg glide (pin type)

Finish: nickel-plated steel



Size	13 mm	15 mm	18 mm	20 mm	23 mm	25 mm	30 mm
------	-------	-------	-------	-------	-------	-------	-------

Chairleg cups with three lugs

Finish: nickel-plated steel



Size	13 mm	15 mm	18 mm	20 mm	
------	-------	-------	-------	-------	--

Glide (pin type)

With rubber washer

Finish: nickel-plated steel; black rubber



Size		18 mm	20 mm	23 mm	25 mm	30 mm
------	--	-------	-------	-------	-------	-------

Felt glide

Finish: felt, in plastic case, grey



Size		20 mm		24 mm	30 mm
------	--	-------	--	-------	-------

Plastic glide

Finish: white plastic



Size	10 mm	13 mm	16 mm	19 mm	22 mm	
------	-------	-------	-------	-------	-------	--

Plastic glide (pin type)

With rubber washer

Finish: white plastic; black rubber



Size		15 mm		20 mm		25 mm	30 mm
------	--	-------	--	-------	--	-------	-------

# 4

## Specialties

<b>Plantscaping</b>	<b>906</b>
<b>Signage and graphics</b>	<b>931</b>
<b>Audio-visual systems</b>	<b>949</b>
<b>Auditorium seating</b>	<b>961</b>
<b>Security</b>	<b>977</b>
<b>Color theory</b>	<b>998</b>
<b>Window treatments</b>	<b>1015</b>
<b>Elevators</b>	<b>1060</b>
<b>Indoor recreation</b>	<b>1069</b>
<b>Accessories</b>	<b>1075</b>



In most instances, the design process requires a knowledge of, or at the very least, an awareness of, certain specialized elements that can contribute heavily to the success or failure of a project in terms of aesthetics or function, or both. These elements may take the form of manufactured "off-the-shelf" products or consist of design theories, standards, and guidelines for certain areas of expertise. Accordingly, this section deals with ten such elements, ranging from landscaping to accessories.

Information can be found concerning the height, spacing, and diameter of indoor trees and floor plants. Also included are planting standards, details, and maintenance information. The section dealing with signage and graphics provides information on signage systems, symbols, mounting heights, and locations. Other sections provide data on audio-visual systems, including projection room layouts and details, and auditorium seating arrangements and sightlines. The section dealing with security includes information on door and window hardware, mailbox rooms, lighting, and security systems. Still other sections provide information on color theory and window treatments, including draperies and curtains, shutters and shades, and rods, holdbacks, and ties.

## PLANTSCAPING

## Design Guidelines

## DESIGNING WITH PLANTS

Any successful design uses plants that are compatible not only in an aesthetic design sense, but also in their growing requirements. No matter how beautiful the design, if neighboring plants are not matched to the correct growing conditions, parts of the design will either deteriorate or require elaborate maintenance. The aesthetic design considerations involve choosing the proper variety of plant textures, heights, and spacing to give the desired effect. The growing considerations involve the proper matching of light intensity, soil, and water, as well as proper container size, to the plant environmental requirements.

Of all the growing conditions, the most important is the light intensity. It is easy to underestimate the amount of available light, since the human eye can easily see in 20 footcandles of light, while even the plant needing the lowest light requires 50 to 75 footcandles to remain healthy. If the light intensity is to be below 100 footcandles, even these "low-light" plants must be slowly acclimatized prior to installation.

No matter if the space to be planted is a small office, a large interior garden, or a cafeteria, the first step is to ascertain the actual level of the existing or planned lighting. To allow maximum creativity in the planting design, the light intensity should be considered in the initial planning stages, especially in large areas such as those in shopping malls or corporate interior gardens. Adding the needed lighting fixtures after the initial electrical installation is often expensive or impossible. In smaller-scale situations, such as offices or homes, extra light fixtures should be added or the plants should be chosen according to the available light. If the plants do not have the proper light intensity, they will die. The lower the light intensity below the minimum needed by the species, the faster they will do so.

Since the light source (incandescent, fluorescent, sun, or other) is not important, but the light intensity is, accurate intensity measurements are essential. For these measurements we recommend the General Electric Model 213 or 214 light meter or its equivalent. The measurements must be made at the level of the plant foliage; they must be made several times a day on several days typical of the location if sunlight is used; and they must take curtains, tinted glass, and other light-shielding devices into account. Only light hitting the top of the leaves is effective. While underlighting with spotlights can create dramatic effects, it does very little to help the plant.

After the light intensity is determined, the plants should be selected from the appropriate light-level group (see Fig. 7), consistent with the design aims. Plants that will be growing near one another should also have similar water requirements (also given in Fig. 7). If plants with different watering requirements must be close, they should be kept in their own growing containers so they can be watered separately.

An interior planting designer creates the mood through the interplay of plant texture

and plant height, working only with those plants that will live under the predetermined light intensity. Color cannot really be used as a design element, since the average interior light intensity is seldom more than 100 footcandles and brightly colored plants or blooming flowers need up to 1000 footcandles. If flowering plants are used where the lighting conditions are normal, they will generally have to be replaced every few days.

## Plant Texture

The good designer will provide for design variety through the clever use of plant texture. The term is used here to describe the general structure, shape, and appearance of the plant, regardless of height. It includes the size, shape, edging, and thickness of the plant's leaves, as well as its overall shape and the arrangement and number of leaves on the plant.

Five general rules concerning texture should be kept in mind.

1. Juxtapose fragmented foliage (such as that of a palm) with solid foliage (say, that of a dracaena).

2. Avoid too much of the same type of foliage (e.g., large flat leaves) in one area, unless a border or hedge effect is desired.

3. An exception to these previous rules on groupings is the palm. Although all palms have similar foliage, they vary slightly in color and interest, so that different types of palms may be planted together.

4. To create interest, mix small-leaved with large-leaved plants, and narrow-leaved with broad-leaved plants.

5. When using plants as specimens, especially as interior design elements in offices or homes, pick the plant with the background fabric, carpet, or wallpaper in mind. For example, a "busy" foliage plant will fight with a "busy" fabric.

## Plant Height

Plant height not only determines the scale of the design, but it adds variety to the plant groupings. There are six general rules regarding plant height selection to keep in mind.

1. In the plant grouping, build up with the low plants in front. If the grouping can be seen from all sides, the grouping must be well balanced throughout and built up to the center height.

2. If a plant has canes with no lower foliage, try to place the lower plants in front to conceal the absence of foliage of the taller plants in the rear.

3. Uneven sizes throughout a grouping add more interest than consistent levels of foliage.

4. If a single plant is desired to hide a column or some other object, be sure that the plant height, including its container, is about three-fourths the height of the object to be concealed.

5. Keep the scale of the surroundings in mind when choosing the plant height. A 3-foot plant is fine next to a desk, but a plant of at least 6 feet should be selected if it is to be viewed when entering a room.

6. By convention, interior plant heights are

measured from the bottom of the root ball or planter, while exterior plant heights are measured from the top of the root ball. The reason is that interior plants are usually placed in a container or raised planter, and the total available height from floor to ceiling is fixed.

## Plant Spacing

Under certain conditions, the plants of an interior landscaping design will grow. Therefore, any possible change in the plant size must be considered by the designer. If the lighting intensity is at or below the recommended level, there will be little or no plant growth and the plant size and relationships will change little over time. If the lighting intensity is well above the required level, there will be plant growth, with different plant species growing at different rates.

Unlike outdoor plants, indoor tropical plants seldom grow outward; most of their growth occurs upward. The main exceptions are the *Ficus* family, the schefflera, and the *Philodendron Selloum*, which will spread somewhat outward. If a full plant design is desired, the required number of plants should be placed close together at the time of installation since future growth will seldom fill in the bare spots.

Even if the light intensity is high enough, before the plant can grow significantly, its root system must be able to expand. Thus, the best way to ensure that the size relationships of the plants do not change is to keep them in their original growing containers and not to replant them into a growing medium. If they are kept in the original containers, they will become pot-bound and future growth will be automatically limited.

Plant material is sold on the basis of height or growing-container size, and one must be familiar with the particular species to know what the spread will be. For each plant species considered here, Fig. 1 lists the height range for each plant in each standard growing-container size and gives a recommended minimum center-to-center plant spacing. This recommended spacing is based on experience with the plant's branching habits and growth patterns and will give a full plant design. If an open or a less full design is called for, the spacing should be increased.

When the plants are to be displayed in individual planters or decorative containers, each plant, still in its growing can, is placed directly into the planter or container, on top of a layer of drainage material of the appropriate depth. However, many standard planters have lips that reduce the interior diameter to less than the overall diameter. This inner diameter should be larger than the growing cans diameter so that the plant can be placed directly into it without being repotted and risking the attendant danger of root damage. To emphasize this requirement, Fig. 2 gives the standard planter diameter needed for each standard size of growing container. The size of the lip changes when a nonstandard type is used. If space is limited, this measurement should be carefully checked.

## PLANTSCAPING

Plant Height, Spacing, and Diameter

INDOOR TREES			
Species	Height Range	Recommended Center-to-Center Plant Spacing	Growing Can Diameter
Fiddle-leaf fig ( <i>Ficus lyrata</i> )	3- 4 ft	24-36 in	10 in
	4- 6 ft	30-42 in	14 in
	6-11 ft	42 in & up	17 in
Indian laurel ( <i>Ficus retusa</i> )	5- 7 ft	42-54 in	14 in
	7- 9 ft	48-60 in	17 in
	9-12 ft	60 in & up	22 in
Rubber plant ( <i>Ficus elastica</i> cv. 'Decora'), tree standard	4-5 ft	48-60 in	10 in
	5-6 ft	54-66 in	12 in
	6-7 ft	60-72 in	14 in
Rubber plant ( <i>Ficus elastica</i> cv. 'Decora'), bush type	1½-2 ft	12-18 in	6 in
	2 -2½ ft	12-24 in	8 in
	3 -4 ft	24-36 in	10 in
	4 -5 ft	36-48 in	12 in
	4 -5 ft	48-60 in	14 in
Weeping fig ( <i>Ficus benjamina</i> )	3- 4 ft	24-36 in	10 in
	4- 5 ft	30-42 in	12 in
	5- 7 ft	36-48 in	14 in
	6- 8 ft	48-60 in	17 in
	9-10 ft	60 in & up	22 in
	9-12 ft	60 in & up	28 in
	10-12 ft	72 in & up	36 in
Norfolk Island pine ( <i>Araucaria heterophylla</i> )	1½-2 ft	18-30 in	6 in
	2 -3 ft	24-36 in	8 in
	3 -5 ft	30-42 in	10 in
	4 -5 ft	36-48 in	12 in
	4 -6 ft	42-54 in	14 in
	6 -7 ft	54-66 in	17 in
Schefflera ( <i>Brassaia actinophylla</i> )	3- 4 ft	36-48 in	10 in
	4- 5 ft	36-48 in	10 in
	5- 7 ft	55-66 in	14 in
	7- 8 ft	60-72 in	17 in
	8- 9 ft	60 in & up	22 in
	9-12 ft	72 in & up	Metal tubs
FLOOR PLANTS			
Bamboo palm ( <i>Chamaedorea erumpens</i> )	3-4 ft	30-42 in	10 in
	4-6 ft	36-48 in	12 in
	5-7 ft	42-54 in	14 in
	7-9 ft	48-60 in	17 in
Corn plant ( <i>Dracaena fragrans</i> cv. 'Massangeana')	1½-2 ft	24-30 in	6 in
	3½-4 ft	24-36 in	10 in
	4½-6 ft	30-42 in	12 in
	5 -7 ft	36-48 in	14 in
Corn plant bush ( <i>Dracaena fragrans</i> cv. 'Massangeana')	1 -1½ ft	18-24 in	6 in
	1½-2½ ft	18-30 in	8 in
	3 -4 ft	24-36 in	10 in
	4 -5 ft	30-42 in	14 in
	5 -7 ft	36-48 in	17 in
Dwarf date palm ( <i>Phoenix Roebelenii</i> )	2-3 ft	30-42 in	10 in
	3-4 ft	36-48 in	12 in
	4-5 ft	42-54 in	14 in
	5-6 ft	48-60 in	17 in
	5-6 ft	54-66 in	22 in

Fig. 1 Spacing recommendations.

## PLANTSCAPING

Plant Height, Spacing, and Diameter

Species	Height Range	Recommended Center-to-Center Plant Spacing	Growing Can Diameter
Dwarf dragon tree ( <i>Dracaena marginata</i> )	3-4 ft	24-36 in	10 in
	4-5 ft	30-42 in	12 in
	5-7 ft	36-48 in	14 in
	7-9 ft	48 in & up	17 in
Dwarf schefflera ( <i>Brassia arboricola</i> )	1 - 1½ ft	18-24 in	6 in
	1½-2½ ft	30-42 in	8 in
	3 - 4 ft	36-48 in	10 in
	4 - 5 ft	42-54 in	14 in
False aralia ( <i>Dizygotheca elegantissima</i> )	1½-2 ft	18-30 in	6 in
	3 - 4 ft	30-42 in	10 in
	5 - 7 ft	36-48 in	14 in
	7 - 8 ft	42-54 in	17 in
Green dracaena ( <i>Dracaena deremensis</i> cv. 'Janet Craig')	1 - 1½ ft	18-24 in	6 in
	1½-2½ ft	18-30 in	8 in
	3 - 4 ft	24-36 in	10 in
	4 - 5 ft	30-42 in	14 in
	5 - 7 ft	36-48 in	17 in
Green pleomele ( <i>Dracaena reflexa</i> )	1½-2 ft	12-18 in	6 in
	3 - 4 ft	18-30 in	10 in
	4 - 5 ft	30-45 in	14 in
	5 - 6 ft	36-48 in	17 in
Kentia palm ( <i>Howea Forsterana</i> )	3-4 ft	36-48 in	10 in
	4-5 ft	42-54 in	12 in
	5-8 ft	48-60 in	14 in
Lady palm ( <i>Rhapis excelsa</i> )	3-4 ft	36-48 in	10 in
	4-5 ft	42-54 in	12 in
	5-7 ft	48-60 in	14 in
Mock orange ( <i>Pittosporum Tobira</i> )	1½-1½ ft	24-36 in	10 in
	1½-2½ ft	30-42 in	12 in
	2 - 3 ft	36-48 in	14 in
Narrow-leaved pleomele ( <i>Dracaena angustifolia honorail</i> )	3-4 ft	24-36 in	12 in
	5-6 ft	30-42 in	14 in
	6-7 ft	36-48 in	17 in
Neantha bella palm ( <i>Chamaedorea elegans</i> )	1 - 1½ ft	18-30 in	6 in
	1½-2½ ft	24-36 in	8 in
	2½-3½ ft	30-42 in	10 in
	4 - 5 ft	36-48 in	14 in
Ponytail ( <i>Baucarnea recurvata</i> )	1½-2 ft	24-36 in	10 in
	2 - 3 ft	30-42 in	12 in
	3 - 4 ft	36-48 in	14 in
	4 - 5 ft	42-54 in	17 in
Reed palm ( <i>Chamaedorea Seifrizii</i> )	4-6 ft	36-48 in	12 in
	6-7 ft	42-54 in	14 in
	7-9 ft	48-60 in	17 in
Self-heading philodendron ( <i>Philodendron Selloum</i> )	3 ft	30-42 in	10 in
	4 ft	42-54 in	14 in
	5 ft	54-66 in	17 in
Southern yew ( <i>Podocarpus macrophyllus</i> var. Maki)	4-5 ft	36-48 in	10 in
	5-6 ft	42-54 in	12 in
	5-6 ft	48-60 in	14 in
	6-7 ft	54-66 in	17 in

Fig. 1 (Continued)



## PLANTSCAPING

Plant Height, Spacing, and Diameter

Species	Height Range	Recommended Center-to-Center Plant Spacing	Growing Can Diameter
<b>TABLE OR DESK PLANTS—GROUND COVER</b>			
Boston fern ( <i>Nephrolepis exaltata</i> cv. 'Bostoniensis')	1 ft	24-30 in	6 in
	1 - 1½ ft	30-36 in	8 in
	1½-2 ft	36-42 in	10 in
Common philodendron ( <i>Philodendron scandens oxycardium</i> )	1 ft	18-24 in	8 in
	1½-1¾ ft	24-30 in	10 in
	1¾-1½ ft	24-36 in	12 in
Chinese evergreen ( <i>Aglaonema commutatum</i> var. <i>maculatum</i> )	1½-1¾ ft	18-24 in	6 in
	1¾-2 ft	24-30 in	8 in
	2 - 2½ ft	30-36 in	10 in
Dumb cane ( <i>Dieffenbachia maculata</i> cv. 'Rudolph Roehrs')	1 ft	18-24 in	6 in
	2 ft	24-30 in	8 in
	3 ft	30-36 in	10 in
	3 - 3½ ft	36-42 in	12 in
Golden pothos ( <i>Epipremnum aureum</i> or <i>Scindapsus aureus</i> )	3½-4 ft	42-48 in	14 in
	1 ft	12-18 in	6 in
	1 ft	18-24 in	8 in
	1½-1¾ ft	24-30 in	10 in
Grape ivy ( <i>Cissus rhombifolia</i> )	1½-1¾ ft	30-36 in	12 in
	1 ft	18-24 in	6 in
	1 - 1½ ft	18-30 in	8 in
	1¾-1½ ft	24-36 in	10 in
Jade plant ( <i>Crassula argentea</i> )	1½-1¾ ft	24-36 in	12 in
	1 ft	18-24 in	8 in
	2 ft	24-36 in	10 in
	2 - 2½ ft	30-42 in	12 in
Prayer plant ( <i>Maranta leuconeura</i> )	2½-3½ ft	36-48 in	14 in
	1 ft	18-24 in	8 in
	1 ft	24-30 in	10 in
	1-1½ ft	24-30 in	12 in
Swedish ivy ( <i>Plectranthus australis</i> )	1 ft	18-24 in	6 in
	1 - 1½ ft	18-30 in	8 in
	1½-1¾ ft	24-36 in	10 in
	1¾-1½ ft	24-36 in	12 in
Wax plant ( <i>Hoya carnosa</i> )	1 ft	12-18 in	6 in
	1 ft	18-24 in	8 in
	1 ft	24-30 in	10 in
White flag ( <i>Spathiphyllum</i> cv. 'Clevelandii')	1½-1¾ ft	24-36 in	6 in
	2 - 3 ft	30-42 in	8 in
	2½-3½ ft	36-48 in	10 in
	3 - 4 ft	48-54 in	14 in
White-striped Dracaena ( <i>Dracaena deremensis</i> cv. 'Warneckii')	1½-1¾ ft	18-24 in	6 in
	2 ft	24-30 in	8 in
	3 - 4 ft	24-36 in	10 in
	4 - 5 ft	30-42 in	12 in
	4 - 7 ft	36-48 in	14 in
Green dracaena ( <i>Dracaena deremensis</i> cv. 'Janet Craig')	1 - 1½ ft	18-24 in	6 in
	1½-2½ ft	24-30 in	8 in
	3 - 4 ft	30-42 in	10 in
Neantha bella palm ( <i>Chamaedorea elegans</i> )	1 - 1½ ft	18-30 in	6 in
	1½-2½ ft	24-36 in	8 in
	2½-3½ ft	30-42 in	10 in
Self-heading philodendron ( <i>Philodendron Selloum</i> )	1 ft	18-24 in	6 in
	2 ft	24-36 in	8 in
	3 ft	30-42 in	10 in

Fig. 1 (Continued)

Plant Growing Container Diameter	Recommended Planter Exterior Diameter
4 in	6 in
6 in	8 in
8 in	10 in
10 in	12 in
11 in	14 in
12 in	14 in
13 in	16 in
14 in	16 in
17 in	18-22 in
22 in	24 in

Fig. 2 Planter selection. These recommendations are based on the fact that most standard planters have either a 1-inch lip or no lip at all. Because the growing cans sometimes have ridges or have become deformed, it is always best to allow for a little extra leeway, even for planters with no lip. Some manufacturers, however, put 2-inch lips on their planters, a possibility that should be checked. If the planter is an automatic watering type, the inside and outside diameters will be quite different, depending on the manufacturer.

## PLANTSCAPING

## Design Guidelines

## Writing Specifications

The interior landscaping business is very competitive, and a common practice is for the architect or designer to send out the landscaping specifications for bids. Unless the specifications for the job are well-written, however, there are many ways for the contractor to cut corners and still be within the specifications. Consequently, the final installation may not be what the designer had in mind. The lowest bid is not necessarily the best bargain, unless the specifications are very tightly written or unless the architect is dealing with a well-established landscape contractor with a reputation for high-quality work.

The following are some suggested guidelines to use in writing specifications. If they are observed, the bids received will accurately reflect the design requirements of the job.

1. Specify the plant heights within a 6-inch bracket. For example, designate 5 to 5½ feet or 5½ to 6 feet. If the specification were simply "5 to 6 feet," the supplier could use all 5-foot plants, which are considerably less expensive than 6-foot plants.

2. For corn plants, dwarf dragon trees, and the like, specify the number of canes and approximate number of foliage heads, as well as the height. The difference in cost between a two-cane and a three-cane corn plant of the same height is not minor.

3. For reed palms, bamboo palms, and the like, specify the number of stems desired, five to six being medium full.

4. For the green dracaena and white-striped dracaena, list the number of main foliage stems desired. They range from one to three stems.

5. For ficus trees, it should be specified whether the bush style or standard tree style is desired. In the bush style, the plant has multiple stems (ranging from two to five in number) branching out from the base of the plants. The standard tree or "lollipop" style has one main 5- to 6-foot stem with a sheared, ball-shaped foliage head.

6. Small plants should be specified as to single plants or combinations or several plants. Examples are dumb cane, Chinese evergreen, and white flag.

7. If ivy trailers are desired, their length should be specified. The trailers take up to eight months to grow, depending on the length, so the designer must plan for these up to a year before installation. Examples are grape ivy, swedish ivy, golden pothos, common philodendron, and wax plant.

8. Perlite should call for plant cleaning and spraying before installation.

9. Perlite should be specified as the drainage material for both planters and decorative containers. Styrofoam, which is much cheaper, is often used but has little long-term value.

10. The amount of ingredients in large planters (soil mixture, drainage material, soil separator) should be specified, as should the composition of each of the ingredients.

11. If bark chips, moss cover, or other soil coverings are desired, they should be specified.

12. Special attention should be given to the description of specimen plants, including the number of heads, stems, or canes, and any unusual stem structure that is desired. If

canes with character (such as angle and peculiarity of growth), tufts of foliage at various heights, or other unusual features are wanted, they should be specifically mentioned.

13. If the landscape contractor will not maintain the plants after installation, provision should be made for a training program for the maintenance crew. Also, the contractor should provide for two weeks' initial maintenance of the plants and replacement of any that fall below specifications during the period.

14. If the landscape contractor is to maintain the plants after the installation (usually the best all-around solution), such an agreement should be reached before the plants are installed and a maintenance contract should be signed. This contract should include a provision for the replacement of any plant that falls below specifications because of faulty maintenance. This stipulation gives the contractor incentive for professional-quality maintenance.

15. If a large garden is planned and the landscape contractor is given design responsibility for it, the contractor should provide a floor plan of the garden for the designer's approval, before the installation.

16. If the architect or designer provides the landscape contractor with a detailed planting floor plan and the contractor finds it impossible to meet all the specifications (because of unavailability of certain species, etc.), the contractor and the designer or architect should agree in writing on any changes.

## USE OF INTERIOR PLANTS AND PROCEDURES

The general rule of interior planting design is to vary the plant heights, shapes, and textures to give the desired design feeling consistent with the available light level and planting space. The best way to learn to apply this rule to specific situations is to study successful designs.

Interior planting designs have usually been found to fall into one of two categories: (1) interior gardens, both large and small, such as those seen in residential and hotel lobbies, corporate headquarters reception areas, and enclosed shopping mall public spaces; and (2) open plan or specimen design, like office landscaping designs and designs that use individual plants as living sculptures. In both categories of design, the main requirements to be considered are the available light intensity, the scale of the design, and the client's wishes and budget. After these basic requirements are determined, however, the design considerations are somewhat different for the two types of design.

## Interior Gardens

Interior gardens are planting areas, sometimes contained in built-in planters, that have a variety of plants and that convey their design feeling through plant arrangements rather than through individual plant specimens. Small gardens generally contain only a single grouping of plants, act as a single design element, and have uniform lighting

and watering requirements throughout. Large gardens have a variety of plant groupings and varying design feelings among the groupings, and they can encompass areas of different lighting and watering requirements. Since any garden conveys its effects through the juxtaposition of different plants, a single dominant plant cannot be considered a garden from the design point of view, even if it is in a built-in planter with ground-cover plants.

In designing any built-in planter, enough planter depth must be provided to allow the root ball or the planting can to be covered with soil and to rest on 4 to 8 inches of drainage material. Since soil and gravel are expensive, it is best not to overdesign the planter, by making it larger than necessary, and not to buy too much soil to fill in between the plants. (For example, a depth of 1½ to 2 feet is usually enough for most small gardens.) Figure 1 lists the size of the growing can for different sizes of plants of each species. The depth of the largest growing can, plus the depth of the drainage material, yields the minimum planter depth for the garden. The volume of the planter minus the total volume of all the growing cans indicates the amount of additional soil and drainage material to be provided.

If the planter is already in place, its depth may limit the size of the plants that may be used. Since soil must reach to the top of the root ball or can, the only way to utilize too shallow a planter is to put the large plant in the center and to build up from the edge inward. The planter must be wide enough to slant the soil gradually so that the slope is not too great.

**Small gardens** While a garden may be large enough to have only a single design function, that function can be quite varied, provided that the lighting intensity is appropriate. It can serve as a small glen or a space separator, or it can be simply a large decorative planter. The garden can be airy and open or it can be dense and closed. Planter depth of 1½ to 2 feet is usually sufficient.

Also, some small gardens can be designed to be changed with the seasons. Often, flowering plants, such as chrysanthemums or azaleas, are used, but the plants must then be replaced every two weeks. If the seasonal or flowering plant changes are desired, the plants should be left in their containers so that they may be easily moved. Some care should be given to the planter design so that the growing cans are not obvious and do not detract from the arrangement.

Creative additions of volcanic rocks, small ponds, or fountains can be quite attractive and set off and enhance the plants. However, with the usually limited space in the small garden, these additions can produce a crowded or overdone appearance. Overcrowding will give a jungle effect that is rarely desired.

Just as in other design fields, good proportion and good sense will create a pleasing design that is neither overlooked or overbearing.

**Large gardens** Large gardens are simply larger versions of small gardens, but their very size opens up more design possibilities, since they may be subdivided into related sections. The shape, height, and texture of the planters may be varied from section to

section. The plants may be chosen to reflect varying design moods and functions. The lighting and watering requirements may differ between sections. In fact, variety is often necessary for good large-garden design, since a large mass of similar plants or plant groupings will create the impression of a monotonous forest or field.

Because large indoor gardens usually are in areas of high ceilings, the light level must be very carefully considered. Just the presence of windows or skylights does not guarantee enough light. In addition, if the light sources are distant from the plants, the taller plants may effectively block some of the light from reaching the lower plants and foliage.

When large areas are to be planted, there is a tendency to use rocks, pools, gravel, or fountains to cut down the plant costs and simplify the maintenance. Care is essential when using these elements to prevent the plant arrangement from looking bare and sterile.

Large gardens are most commonly used in shopping malls. The skilled designer will take this illumination into account, as well as design the garden to enhance the shopper's view of the stores.

The designer will always remember that large gardens achieve their effectiveness by both the proper variation of plant groupings and the proper variation of plants within the groupings.

**Procedures for planting gardens** As pointed out earlier, a successful garden needs proper planting, since improper procedures can inflict severe damage. Correct planting involves not only correct technique and design but also correct organization.

The techniques of proper drainage, spacing, and handling will ensure that the plants remain healthy once they are installed. Experienced supervision of the installation staff will be important in this regard, since a large installation of expensive plants is no place for the on-the-job training of the supervisor.

Proper planning and organization will ensure that the plants remain healthy between unloading and planting. If the plants are left on an unheated loading dock or stored in an unlighted or unheated room until they are installed, irreversible damage may occur.

**Drainage** Overwatering of plants leads to root rot and is often more harmful than underwatering. To minimize this danger, the planter or container should be installed with proper drainage. The simplest technique is to provide a porous reservoir below the planting soil; any excess water will then drain into it from the root ball and be slowly fed back to the soil as the soil dries out.

To prepare the planter or decorative container, the drainage material is poured into the bottom and leveled. The plant growing can is placed on top of the drainage layer and surrounded with more of the drainage material. For the smaller plants (in pots 6 inches or less in diameter), a 1-inch depth of drainage material is usually enough. For the larger plants, a layer of 3 to 4 inches is suggested. For very large gardens, about one-third of the planter depth should be the drainage layer, provided it leaves enough room for the root ball or planting can.

The drainage material can be perlite (a readily available synthetic material) alone or

mixed with small pebbles or gravel. The perlite is suggested since it is porous enough to feed back the excess water to the soil as the soil dries out. If only gravel or pebbles are used, the excess water will sit and stagnate in the reservoir and will not be fed back to the plants.

Even with the proper drainage layer, overwatering is possible if so much excess water is used that it fills up the reservoir. The water level in a small container can be determined by tapping the container at various intervals and listening for the change in sound. In large planted areas, it is wise to provide for "dipstick" readings of the water level. To take such a reading, rigid hollow plastic tubes, with a cloth over their lower ends, are "planted" at intervals along with the plants. The hollow tubes reach from the top of the container to just above the drainage layer and the cloth on the bottom prevents soil or drainage material from entering the tube. A dipstick is lowered into the tube until it touches the cloth. If the stick, upon removal, shows more than  $\frac{1}{2}$  inch of water, there is too much water in the bottom of the planter.

If gravel is used as part of the drainage material, it should be  $\frac{3}{8}$  inch to  $\frac{1}{2}$  inch in diameter. Under no circumstances should limestone be used, since it is alkaline and will raise the pH of the water to a level that is too high for most tropical plants.

**Soil separator** If the plants are removed from their growing cans and replanted in growing soil, it is usually best to use a soil separator between the drainage layer and the planting soil. The separator is a semiporous sheet, often composed of fiberglass wool, which serves to keep the soil from falling into the drainage material. If the separator is not used, soil will clog the drainage material. Fiberglass wool of building material grade should not be used, as it contains chemicals that will damage the plant (Fig. 3).

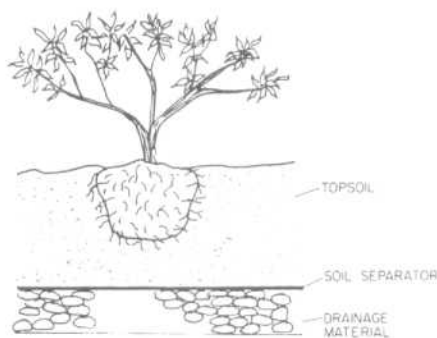


Fig. 3 Soil separation.

**Planting medium** Because the root systems of tropical plants are much finer than those of outdoor plants, pure topsoil is too heavy and too easily compacted to be used as a planting medium. It will constrict the plant roots and will retain too much water.

For the common tropical plants discussed here, we recommend the use of the foliage plant mix developed by Cornell University. Because it is easiest to calculate the quantity of needed soil in terms of the volume of the planter to be filled, the formula given here is

for 1 cubic yard of soil. For conversion purposes, 1 cubic yard equals 21.7 bushels, 765 liters, or 27 cubic feet.

*Sphagnum peat moss:*  $\frac{1}{2}$  cu yd = 383 lit  
*Vermiculite #2:*  $\frac{1}{4}$  cu yd = 191 lit  
*Perlite, medium fine:*  $\frac{1}{4}$  cu yd = 191 lit  
*Ground limestone, dolomitic:* 0.85 gal = 13.5 cup = 3.2 lit  
*Superphosphate 20 percent solution:* 0.21 gal = 3.4 cup = 0.79 lit  
*10-10-10 fertilizer:* 0.32 gal = 5.1 cup = 1.2 lit  
*Iron sulphate:* 0.11 gal = 1.7 cup = 0.41 lit  
*Potassium nitrate:* 0.11 gal = 1.7 cup = 0.41 lit

While this Cornell foliage plant mix gives the best all-around results, a simpler mix that gives good results in most cases is as follows:

$\frac{1}{2}$  by volume sterilized commercial mix of peat moss and vermiculite  
 $\frac{1}{3}$  by volume sterilized topsoil  
 $\frac{1}{3}$  by volume perlite

This mix is particularly effective for container planting. If it is to be used in a larger garden planting, such as a shopping mall garden, more perlite should be added for improved drainage.

The peat and topsoil mix is considerably heavier than the Cornell mix and both are heavier wet than dry. If the garden is not situated at grade level, this weight can be an important consideration. Figure 4 gives guidelines to be used in estimating the weight of the planting medium.

**Planting organization** The basic ingredients for a large planting installation are drainage material, planting medium, soil separator, plant material, material-handling equipment, light, water, and labor. Organization of all these ingredients is important since every one must be ready and available for a successful installation. Arrangements for all these factors should be made ahead of time, and they should be ready and waiting when the plants are delivered.

The amount of interior volume in the planters and containers determines the amount of needed drainage material, soil separator, and planting medium. If detailed blueprints are not available, actually measuring the planters is generally a good way to obtain this volume. The relationship between planting medium, drainage material, and soil separator can be determined using the guidelines of the previous subsection. If the plants are to be left in their cans (as generally recommended), the space between the plants is filled with drainage material. If they are removed from their cans, the space between plants is filled with planting medium. In either case, the amount of volume displaced by the plants is simply the sum of the volume contained in the growing cans. Information for each standard size of growing container is given in Fig. 5.

The installation should not be started unless all lights and water connections are operating, as the plants will need both light and water during the installation — especially the light. If the plants are delivered dry, they should be watered in their cans unless they are to be planted at once and watered immediately after planting. If the plants are removed from their cans and placed into dry planting medium, they and the planting medium should be thoroughly watered immedi-

## PLANTSCAPING

## Plant Use and Procedures

ately afterward.

Fewer design mistakes will be made if the plants are installed one section at a time, under the direction of a supervisor familiar with the design of the section. If the installation is in an office building, it may be necessary to arrange for a workroom and a freight elevator with access both to the loading dock and the workroom. Depending on the exact arrangements, a crew of four to six workers per supervisor is generally optimum.

It is recommended that each section be planted in the following order. First, leftover building material and other debris are removed from the planting areas. Second, drainage material is added to the proper depth and leveled. Third, the plants, either in or out of their growing containers, are placed on top of the drainage material and the soil separator if present, and arranged according to the design. The spaces between the plants are then filled in with drainage material or planting medium, depending on whether the plants are in or out of their growing containers. If planting medium is used, it should be lightly compacted to prevent its settling later. (If the light intensity is below specifications and periodic replacement of the plants is expected, the plants should be left in their cans.)

After the spaces between the large plants have been filled in, the groundcover, if any, is planted. The use of decorative bark or marble chips on top of the soil is not recommended as they easily mix with the soil and are hard to remove if the plants are replaced.

After all the spaces have been filled, the plants should be thoroughly watered and the maintenance schedule begun. If dry planting medium is used, it should be watered thoroughly several times during the first week to ensure that it is completely wet.

**Removing plants from cans or burlap** A healthy root system is necessary for the maintenance of a healthy plant. It is the new, very fine, feathery roots that are the most important and also the most easily damaged. This damage is very likely if the soil between the fine roots is dislodged in the course of repotting. Whether the tropical plants are delivered in growing cans or with their roots wrapped in burlap, the root system must be handled with care.

The best procedure for removing a plant from its container is to lean the pot on its side, tap on the container sides and bottom, and carefully slide out the plant. In large container-grown plants (in 17-inch or larger cans), the root system may be held very tightly in the can. In this case, a can cutter, which works on either metal or rubber cans, may be the most gentle way of removing the can. Once the can is removed, the root ball of soil and roots should be scored by making ¼-inch-deep vertical cuts at 3-inch intervals around the root ball from top to bottom. If the can removal and ball scoring are done near the planting site, the exposed root system is subjected to minimum handling.

Very large plants and trees are frequently field-grown rather than container-grown. The root balls of such plants will come wrapped in burlap. When planting them, only the upper half of the burlap should be removed. The lower portion will disintegrate in the soil after the plant is installed.

Planting Bed Material	Dry Weight	Wet Weight
Cornell foliage mix	12-18 lb/cu ft	25-35 lb/cu ft
Peat/topsoil mix	38-42 lb/cu ft	70-90 lb/cu ft
Topsoil (loam)	80-100 lb/cu ft	100-120 lb/cu ft
Gravel	120-135 lb/cu ft	120-135 lb/cu ft
Sand	95-110 lb/cu ft	120-130 lb/cu ft

Note: For conversion to metric system: 1 lb = 0.454 kg; 1 cu ft = 0.028 cu m.

Fig. 4 Planting material weight. These figures are the normal weight for each of the materials in both the dry and the wet state. The exact weight depends on the degree of compaction of the material.

Pot Size	Soil Volume	Pot Diameter x Height
6 in	1 gal	6½ in x 6 in
8 in	2 gal	8 in x 7 in
10 in	3 gal	10 in x 9½ in
12 in	4 gal	11 in x 10½ in
14 in	7 gal	13½ in x 12 in
17 in	10 gal	17 in x 16 in
22 in	20 gal	21 in x 17 in
30 in	35 gal	29 in x 17 in
32 in	65 gal	32 in x 22 in
36 in	95 gal	36 in x 24 in

Note: For conversion to different units, use the following factors. 1 gal = .00495 cu yd = .0038 cu m = .134 cu ft = 3.79 lit; 1 in = 2.54 cm.

Fig. 5 Pot-size and volume proportions.

**Rock formations and decorative pools** Natural elements, such as rock formations, decorative pools, water fountains, and waterfalls, can add an artistic touch and turn an unimaginative large planting arrangement into a full garden. Unfortunately the overuse of such design elements is tempting, since they are usually inexpensive compared with the cost of filling the same area with plants. Provided they are not overused, they can serve as natural sculpture or as the answer for areas with too little light to support plants or where conditions limit the variety of plants that can be used.

In rock formations, volcanic rock is the most commonly used type because it is much lighter than ordinary rock. This weight factor can be of considerable importance when the weight of the garden must be limited. This type of rock is also easy to shape with a hammer and chisel.

Although a large decorative pool or fountain must be custom-designed, there are small fiberglass pools that can be purchased in a variety of sizes and are available in kidney, free-form, or rectangular shapes. They are usually no longer than 6 feet, but they are of a standard 16-inch depth, which is deep enough to accommodate any water plants, recirculating pump, and a filter tray with mat

and gravel. Their high-capacity, low-pressure pumps are usually adequate for small fountains and waterfalls.

If decorative pools are used, some thought might be given to using water plants in them. These plants are very attractive and can be easily grown indoors. As with all plants, different species have different growing and flowering habits. A reputable dealer should be consulted for information.

The use of fish in pools should be carefully studied in light of the plant maintenance requirements. Fertilizer, plant chemicals, and limestone runoff from the planting area may enter the circulating water system and kill the fish. Fish can be an attractive design element, but their maintenance requirements must be considered along with the maintenance requirements of the plants.

#### Open Plan and Specimen Design

Modern offices are sometimes sterile places in which to work. The introduction of live plants into such an environment is one way of making the space seem less austere and more comfortable without disrupting the integrity of the original design. For windowless offices, plants provide an attractive natural setting appreciated by the occupants. For offices and other windowed areas, the



plants provide a transition which makes indoors and outdoors seem to flow together.

In all locations, however, the light intensity must be at the proper level before the plants are introduced. The intensity cannot be taken for granted, since artificial lighting designed for office vision is seldom enough for any but the lowest-light plant species. Even a large window will not provide enough light if it has an overhang or a northern exposure. If the light intensity cannot be directly measured or calculated from detailed ceiling plans, one must assume the worst and use only low-light material. There is sometimes a tendency to use plants to fill in otherwise forgotten spots, such as corners, stairwells, and hallways. Such areas are often poorly lit and no plant will survive there unless additional lighting is installed.

In large areas with barely enough light, the usual design problem is how to arrange the limited number of low-light species so that different areas stand out from one another. Design interest can be accomplished by using different types of foliage (for example, fragmented and solid) in the different areas, varying the plant sizes among the areas or using specimen plants selectively.

Specimen plants usually have fuller foliage or an unusual stem structure and hence appear to be different from other plants of that species. The true specimen plants are more expensive than ordinary plants of the same species, but can solve many a design problem. However, a plant with fuller foliage than most will also require more light than most to maintain the foliage.

If the office has floor-to-ceiling walls, the best design procedure is to select specimen plants that act as living sculptures. Since these plants are used for visual emphasis, the plant height and container size should conform to the scale of the rest of the interior design. The plant texture and container finish should blend with each other and with the wall and floor treatments. The particular plant specimen chosen should have an inherently interesting shape and texture.

If the office area is very large or is designed along an "office landscaping" plan with movable partitions, the plants can become an integral part of the design. They can be used with the partitions as space dividers and are excellent for indicating the importance of the space. They also may be effective in relating widely separated areas with one another. They break the monotony of the partitions with both color and texture. They act as sound absorbers. Also, specimen plants can be used in the office landscaping scheme for visual emphasis.

**Planting into individual planters** Individual decorative containers are used for individual plants or small plant groupings. The plants are left in their growing containers and placed directly into the decorative planter on top of 4 to 6 inches of perlite as the drainage material. The decorative planter or container must be tall enough to accommodate the growing can and the perlite, and wide enough to accommodate the width of the growing can. The space between the growing can and the inner wall of the planter can be filled with additional perlite. (See Fig. 2 for size-selection guidance.) As a decorative finishing, bark chips or sheet moss may be placed on the surface of the soil in the growing can. This decorative cover can be easily removed if the plant is replaced and it does not mix with the soil, as sometimes happens in large gardens.

Removing the plant from the growing can and repotting it directly into the planter is not generally recommended. Replacing the plant, if necessary, is a messy job unless drainage material and soil separator are added to the bottom of the container. Also, once removed from its growing container, the plant may take up to four weeks to adjust fully to its new environment.

## CONTAINERS

### Decorative Containers: Different Types

A plant container should be more than decorative. Its proper selection is the first element of proper maintenance, since the container must provide the plant roots with sufficient growing room and with adequate drainage.

All small to medium-size plants are received from the grower in growing containers, usually metal cans or rubber tubs. Large plants are either in large growing containers or their root balls are wrapped in burlap. As a rule, these growing cans provide the proper volume of soil for the size of the plant and have a hole in the bottom for drainage. There is seldom any need to remove the plant from its growing container, especially since rough handling of the root system can shock the plant. Only the smaller plants, such as ivy, can be repotted without much disturbance of the root system. If it is absolutely necessary to repot a larger plant, it should be done carefully as outlined earlier, and it should be always into a larger volume of soil, never into a smaller volume.

The decorative container should be chosen so that its inside dimensions are large enough that the plant-growing container can be dropped directly into it. In addition, it

should be deep enough for the growing container to rest on at least 2 inches of perlite or other drainage material, and leave about 1 inch between the top of the growing can and the top of the decorative container. Some care must be taken in the choice since the interior dimensions of the decorative container are often not uniformly related to the exterior dimensions. For example, some fiberglass containers have a large lip which limits the size of the growing can that can be dropped directly into them. Also some containers have a large false bottom, which makes the interior depth much less than the outside height.

With these simple size-selection rules in mind, the proper decorative container can be selected using Fig. 6 as a guide. This figure lists the decorative pros and cons of the most common types of containers.

### Excess Water in Container

Overwatering of plants is more harmful than underwatering. This problem is most likely to occur when the plants are in individual decorative containers that do not allow the excess water to flow off. To minimize this danger, we have recommended that a plant in a decorative container be double-potted. In the bottom of the decorative container, below the plant growing can, there should be at least 2 inches of perlite or other drainage material to act as a reservoir for excess water. Nevertheless, if the plant is continually overwatered, this reservoir will fill up and lead to root rot because the roots are in a pool of water.

If the plant soil is continually wet to the touch, excess water may be the problem. The water level in the container may be determined by tapping the sides of the container. If the water level indicates excess water, the container is tilted on its side, the plant gently pulled from the container, and the excess water drained from the perlite. If the perlite is completely saturated or appears old, it must be discarded and replaced with new drainage material. If the plant has been sitting in a pool of water for some time, the root ball should be allowed to dry before repotting.

If a very large container or garden has been overwatered and there is no way to drain out the excess water, not really much can be done short of using a small electric pump. One must simply avoid watering the plant or garden at all until the soil has begun to dry out and feels dry to the touch.

## PLANTSCAPING

## Plant Containers

## Automatic Watering Devices

In areas where regular maintenance would be difficult, the use of automatic watering devices can be of considerable help. Even when they are used, however, the plant must be checked periodically to see that the device is working properly, that its water reservoir is full, and that no other maintenance problems have developed.

Automatic watering devices are either external to the container or are built into the planter. The external devices tend to work well only with small plants, and also, they are likely to detract from the design. For these reasons, the built-in type of device is preferred. The planters with this type come in both cylindrical and rectangular shapes and in several colors. The planter has a hollow space within its double-wall sides which serves to hold a three- to four-week water supply, feeding the water to the plant soil by a wick mechanism, sensor, or capillary action. Most types have a float to indicate the amount of water remaining in the reservoir.

Since the soil must be in contact with the wick or capillary tubes for the device to work, the plant must be removed from its original growing can and repotted directly in the planter. As the soil never dries out, the plant must be watched for symptoms of over-watering. Because different plants use water at different rates under different humidity and temperature conditions, a timetable should be kept for each container so the maintenance staff will know when to refill each reservoir.

The use of automatic watering devices will not eliminate maintenance personnel, but it will reduce the number of workers needed. One person can handle many more plants, devoting more time to cleaning and trimming, since the reservoir has to be refilled only every month or so. Occasionally, however, one will find a client who will resist the use of the automatic devices because he or she likes the assurance of seeing a person with a watering can once a week.

The use of the automatic watering devices is expected to increase in the future as more architects and designers become aware of them and convince their clients of their usefulness, and as the manufacturers produce more colors and styles and improve the efficiency of the devices.

Container Type	Pros	Cons
Fiberglass	Large selection of sizes, shapes, and colors. Light weight, easy to move. Some types have casters. Reasonable prices. Many manufacturers.	Easily scratched. Some types have large lips.
Ceramic	Large selection of sizes, shapes, colors, and textures. Rich appearance. Can be put on casters.	Expensive. Easily broken in shipping and handling.
Metal	Large selection of sizes and styles. Rich appearance. Polished or brushed finish.	Expensive.
Baskets, traditional	Good range of styles and textures. Combines well with all furniture styles. Reasonable prices.	Limited sizes. Tend to sag. Need saucer under plant can to prevent water spillage.
Baskets woven around metal	Good texture range. Reasonable prices. Do not sag. Need no saucers. Combine well with all furniture styles.	Sizes limited.
Plastic	Least expensive. Good for table plants. Versatile.	Available mostly in green or white. Sizes largely limited to standard pot sizes. Need saucers underneath. Cheap appearance.
Hanging planters (Heavy; must be used with a rotating hook which can support the weight and allow for easy plant access.)	Available in ceramic, fiberglass, plastic, and metal. Ceramic in various shapes and textures, metal in various finishes. Plastic and fiberglass are inexpensive. All are versatile.	Makes plants susceptible to drafts from heating and air conditioning. Difficult to water without spilling on floor. Metal very expensive. All need inner pot to allow for drainage. Ceramic is porous and presents condensation problem.

Fig. 6 Comparison of container types.

Design Type	Plant Name	Watering Requirements	Design Type	Plant Name	Watering Requirements
<b>HIGH-LIGHT PLANTS—150 FOOTCANDLES AND UP</b>					
T	Fiddle-leaf fig ( <i>Ficus lyrata</i> )	W	DTP	Boston fern ( <i>Nephrolepis exaltata</i> cv. 'Bostoniensis')	W
T	Indian laurel ( <i>Ficus retusa</i> )	W	DTP	Chinese evergreen ( <i>Aglaonema commutatum</i> var. <i>maculatum</i> )	LF
T	Rubber plant ( <i>Ficus elastica</i> cv. 'Decora')	W	DTP	Common philodendron ( <i>Philodendron scandens oxycardium</i> )	W
T	Weeping fig ( <i>Ficus benjamina</i> )	W	DTP	Dumb cane ( <i>Dieffenbachia maculata</i> cv. 'Rudolph Roehrs')	LF
T	Norfolk Island pine ( <i>Araucaria heterophylla</i> )	LF	DTP	Golden pothos ( <i>Epipremnum aureum</i> )	LF
T	Schefflera ( <i>Brassaia actinophylla</i> )	W	DTP	Grape ivy ( <i>Cissus rhombifolia</i> )	W
FP	Dwarf date palm ( <i>Phoenix Roebelenii</i> )	LF	DTP	Prayer plant ( <i>Maranta leuconeura</i> )	W
FP	Dwarf schefflera ( <i>Brassaia arboricola</i> )	W	DTP	Swedish ivy ( <i>Plectranthus australis</i> )	W
FP	False aralia ( <i>Dizygotheca elegantissima</i> )	W	DTP	White flag ( <i>Spathiphyllum</i> cv. 'Clevelandii')	W
FP	Lady palm ( <i>Rhapis excelsa</i> )	W	DTP	White-striped dracaena ( <i>Dracaena deremensis</i> cv. 'Warneckii')	W
FP	Mock orange ( <i>Pittosporum Tobira</i> )	W			
FP	Ponytail ( <i>Beaucarnea recurvata</i> )	LF	<b>LOW-LIGHT PLANTS—50 TO 100 FOOTCANDLES</b>		
FP	Southern yew ( <i>Podocarpus macrophyllus</i> var. <i>Maki</i> )	LF	FP	Corn plant ( <i>Dracaena fragrans</i> cv. 'Massangeana')	W
DTP	Jade plant ( <i>Crassula argentea</i> )	LF	FP	Dwarf dragon tree ( <i>Dracaena marginata</i> )	LF
DTP	Swedish ivy ( <i>Plectranthus australis</i> )	MF	FP	Green dracaena ( <i>Dracaena deremensis</i> cv. 'Janet Craig')	W
DTP	Wax plant ( <i>Hoya carnosa</i> )	MF	FP	Green pleomele ( <i>Dracaena reflexa</i> )	W
			FP	Kentia palm ( <i>Howea Forsterana</i> )	W
			FP	Neantha bella palm ( <i>Chamaedorea elegans</i> )	W
			FP	Reed palm ( <i>Chamaedorea Seifrizii</i> )	W
			FP	Self-heading philodendron ( <i>Philodendron Selloum</i> )	W
			DTP	Chinese evergreen ( <i>Aglaonema commutatum</i> var. <i>maculatum</i> )	LF
			DTP	Common philodendron ( <i>Philodendron scandens oxycardium</i> )	W
			DTP	White Flag ( <i>Spathiphyllum</i> cv. 'Clevelandii')	W
<b>MEDIUM-LIGHT PLANTS—100 TO 150 FOOTCANDLES</b>					
T	Indian laurel ( <i>Ficus retusa</i> )	W	<b>A Final Word about Lighting Intensity</b> The preceding lighting-intensity recommendations are based on experience and the assumption that these levels will be provided eight hours a day, five days a week, and that the plants have been fully acclimatized. If light can be provided for more hours each day or more days each week, the plant material will look its best for longer periods. On the other hand, often the energy costs of the longer lighting exposure are more than the costs of plant replacement. However, if the plants are not to be maintained by the landscape contractor with a plant replacement guarantee, provision should be made for giving the plants light exposure seven days a week.		
T	Schefflera ( <i>Brassaia actinophylla</i> )	W			
T	Weeping fig ( <i>Ficus benjamina</i> )	W			
FP	Bamboo palm ( <i>Chamaedorea erumpens</i> )	MF			
FP	Corn plant ( <i>Dracaena fragrans</i> cv. 'Massangeana')	W			
FP	Dwarf date palm ( <i>Phoenix Roebelenii</i> )	LF			
FP	Dwarf dragon tree ( <i>Dracaena marginata</i> )	LF			
FP	Dwarf schefflera ( <i>Brassaia arboricola</i> )	W			
FP	Green dracaena ( <i>Dracaena deremensis</i> cv. 'Janet Craig')	W			
FP	Green pleomele ( <i>Dracaena reflexa</i> )	W			
FP	Kentia palm ( <i>Howea Forsterana</i> )	W			
FP	Narrow-leaved pleomele ( <i>Dracaena angustifolia honorail</i> )	W			
FP	Neantha bella palm ( <i>Chamaedorea elegans</i> )	W			
FP	Reed palm ( <i>Chamaedorea Seifrizii</i> )	MF			
FP	Self-heading philodendron ( <i>Philodendron Selloum</i> )	LF			

Fig. 7 Growing requirements. Design type: T = tree; FP = floor plant; DTP = desk or table plant or ground cover. Watering requirements: W = water weekly; MF = water more frequently, as required; LF = water less frequently, as required.



**(False) Aralia**

A plant of grace and elegance with narrow, ribbonlike, notched leaves of dark green, usually born on slender, single stems. The aralia is attractive if two or three plants are planted together in one pot. It grows very quickly, so prune the stem tips from time to time to prevent the foliage from thinning at the bottom.

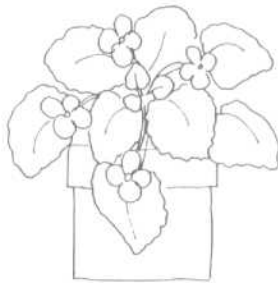
**Temperature** The aralia is tolerant of warm temperatures if there is plenty of humidity.

**Light/sun** The plant likes a semishady to semishady window; an east or west window is ideal.

**Water/humidity** Keep the soil damp but not soggy. The false aralia likes a humid atmosphere. Place your plant on a pebble tray and mist the foliage daily.

**Soil** The soil should be equal parts loam, sand, and peat moss.

**Special care** You can rejuvenate leggy plants by drastically cutting the stems back to four to six inches from the pot. Do this in the spring and leave the plant in a sheltered location, being sure to fertilize and water frequently.



**African Violet**

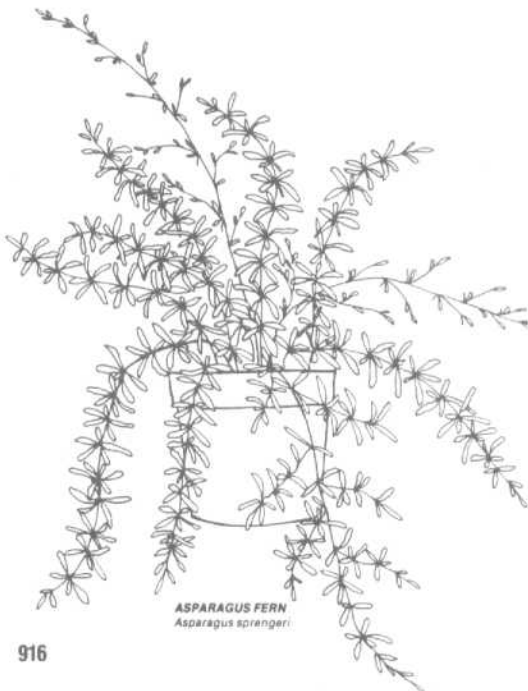
The African violet, a longtime favorite houseplant, does insist on more care and attention, but its beautiful blossoms make the effort worthwhile.

**Temperature** African violets are more contented and grow best within a temperature range of 65 to 80 degrees. Be careful that your plants are not in an open window or a draft.

**Light/sun** The African violet enjoys a place in an east or west window. Direct sun is too strong, unless filtered through a curtain. Excess sun will cause spotting and loss of color, and too little light causes elongated stems and no blooms.

**Water/humidity** African violets should be watered from the saucer underneath in the morning with lukewarm water. Water when the soil begins to dry out. Do not keep it soggy. If the air is dry in your home, place the potted plant in a tray of moistened pebbles.

**Soil** The soil should be porous for good drainage and should contain ample organic matter such as compost or peat moss. Commercial African violet soil mixture is specially prepared for these plants; however, add sand or perlite to ensure adequate drainage. A plastic pot is less likely to cause the lower leaves to rot where they touch the pot.



**Asparagus Fern — Emerald Feather**

The bright feathery green of this delightful plant is best displayed in a hanging container. The long branches drape gracefully and are studded with tiny white flowers that ripen into red-orange berries.

**Temperature** Asparagus fern is not fussy about temperatures, but prefers a range of 60 to 68 degrees.

**Light/sun** The bright filtered sun of an east or west window is a good location for this plant.

**Water/humidity** Soak the soil in the pot thoroughly and allow it to become dry to the touch before rewatering.

**Soil** A well-drained potting soil or a mixture of equal parts of loam, peat moss, and sand or perlite.

**How to start new plants** Allow the berries to ripen and when dry sow the seeds they contain. Asparagus fern can usually be grown from seed quite well.

ASPARAGUS FERN  
*Asparagus sprengeri*





AVOCADO  
*Persea americana*

### Avocado

The avocado comes easily from seed and is grown for its ornamental foliage. It makes a nice tree for your indoor garden. Allow the plant to reach the desired height and then begin regular pinching to force branching and encourage bushy growth.

**Temperature** Temperatures between 60 and 70 degrees suit the avocado well.

**Light/sun** Keep your avocado in bright light but protected from direct sun. Avocados are easily sunburned, especially when they are first moved outside.

**Water/humidity** Use tepid water and keep the soil moist. Place the plant on a pebble tray to raise the humidity level around it. This plant likes a fair amount of humidity and benefits from regular misting. Any signs of browning or crispness at the tips and along the edges of the leaves means the plant needs more humidity.

**Soil** Use a mixture consisting of equal parts of sand, loam, and peat moss.



BOSTON FERN  
*Nephrolepis exaltata*

### Boston Fern

Exaltant is a good adjective for this family of ferns that can fill a corner with rich green foliage. These ferns are excellent for hanging baskets. Initially the ferns may need a lot of attention until the right combination of environmental factors is achieved, but the effort is well worth it. The leaflets grow on a midrib that is covered with fine brown hairs and vary from smooth-edged to feathery and even ruffled. A mature fern can have fronds ranging in length from two to three feet and two to three inches across.

**Temperature** With lots and lots of humidity, ferns will do well in house temperatures in the 60 to 70 degree range.

**Light/sun** Ferns need a location with good bright light, but this means filtered sunlight. *Avoid direct sunlight.*

**Water/humidity** It is essential that the roots of the ferns never dry out at any time. Soak

the soil regularly. Clay pots and hanging baskets can be soaked in a bucket or the sink for half an hour and then drained. The soil should be checked daily to make sure that it is not drying out. Humidity is the most important ingredient to successful fern growing. Place pots of ferns on a pebble tray. Mist the foliage daily with room temperature water.

**Soil** Ferns need a soil that is loose and easily penetrated by their dense root system. The soil mixture should be rich in peat moss and organic matter with a liberal amount of sand for drainage. A sprinkling of charcoal mixed in the soil helps to keep the soil from becoming sour from the frequent waterings. When potting ferns, place a layer of bits of broken pots or gravel in the bottom of the pot. Ferns do not take kindly to having their roots tampered with, so be careful not to damage them when repotting.



CHINESE EVERGREEN  
*Aglaonema modestum*

### Chinese Evergreen

This beautiful foliage plant has waxy dark green leaves. The leaves grow on a canelike stem and are oblong, tapering to a thin tip. Some of the varieties are variegated with splashes of creamy white or yellow. Under optimal conditions, it will produce a flower spike surrounded by a white spathe. The flower is similar to a calla lily. The great thing about this plant is that it will adapt to a variety of environments which makes it a good plant for a beginner or a difficult location.

**Temperature** A range of 60 to 70 degrees suits this plant well.

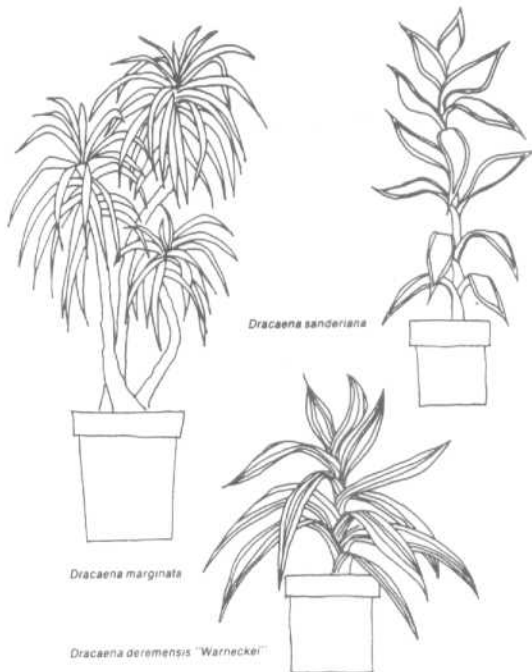
**Light/sun** A shady spot, an artificial light, or any other location will suit this plant. The Chinese evergreen is an excellent plant for a north window.

**Water/humidity** Keep the soil moist but not soggy. To avoid waterlogged soil, allow the surface soil to become dry to the touch before rewatering. The Chinese evergreen can be grown in water. The roots are attractive so a clear glass container shows them off to best advantage. It is important to wash the leaves regularly to keep them dust free.

**Soil** The soil should be equal parts of garden loam, peat moss, and sand.

## PLANTSCAPING

## Typical Plants



Dracaena marginata

Dracaena deremensis "Warneckeii"

Dracaena sanderiana

**Dracaenas**

There are several varieties of dracaenas which vary in foliage color, variegation, and size. Here are three that are commonly available.

*Dracaena deremensis* "Warneckeii": is a good choice for a location without much light. The gray green foliage is striped with white and gray.

*Dracaena marginata*: has clusters of narrow deep green leaves edged with red and gray stems strongly marked with leaf scars. This variety will reach a height of five or six feet.

*Dracaena sanderiana*: resembles a corn plant in the brightness of the green and the size and shape of the leaves with the difference that the leaves are striped with white.

**Temperature** Moderate household temperatures in the 60 to 70 degree range suit

these plants best. It is important to keep plants away from heating vents.

**Light/sun** The marginata and sanderiana should get only filtered sun or bright light. The Warneckeii will fare well in a spot with very little light; it will flourish when more light is available.

**Water/humidity** These plants all like soil that is kept evenly moist but not soggy. Soak the soil in the pot thoroughly and then rewater when the soil surface feels dry to the touch. Humidity is a must. Brown crispy leaf tips and margins mean too little moisture in the air. It is a good idea to place the dracaenas in pebble trays and mist the foliage daily.

**Soil** Commercial potting soil is adequate but added drainage material such as sand or perlite is advisable.

DUMB CANE  
*Dieffenbachia maculata***Dumb Cane**

The cool-looking foliage of this plant is yellow-green, mottled with white. The leaves are pointed ovals that become quite large as the plant matures. The dieffenbachia is known as the "mother-in-law" plant or the dumb cane because when a piece of the stem is placed on the tongue it causes temporary numbness and loss of speech. All joking aside, *this plant is poisonous*.

**Temperature** The dieffenbachia prefers warm temperatures and will tolerate hot dry places with added humidity.

**Light/sun** This plant does well in an east or west window where it can bask in the sun for a few hours.

**Water/humidity** The soil should be allowed to dry out for a few days before rewatering. The plants indicate a need for water when the leaves show signs of drooping. Regular misting keeps the foliage dust-free and luxuriant.

**Soil** A porous soil of equal parts loam, peat moss, and sand is fine.

**Gardenia**

The gardenia is a handsome foliage plant with intensely fragrant blooms, but it has an extremely temperamental nature. It is a challenging plant to grow successfully indoors. The most frequently available varieties are *Gardenia radicans floraplana*, a low spreading plant with small double flowers, and *Gardenia florida*, which blooms in summer.

**Temperature** The temperature must be kept above 65 degrees to maintain healthy foliage and flower buds. These plants hate drafts. Loss of flower buds is often due to sudden changes in temperature.

**Light/sun** The gardenia needs lots of light, but avoid strong sun that might burn the leaves.

**Water/humidity** The soil must be kept constantly moist without becoming soggy. Submerge the pot in a bucket of lukewarm water and allow it to soak for half an hour or until the soil is moist on the surface. Do not allow the pot to sit in water as that will cause the roots to rot. Gardenias need very high humidity at all times. Place the pot in a tray of moistened pebbles. Mist the foliage daily with tepid water. Leaf or bud drops indicate the air is too dry.

**Soil** Potting soil should be a mixture of equal parts peat moss, loam and well-decayed manure with sand or perlite added for drainage.

GARDENIA  
*Gardenia radicans floraplana*



GRAPE IVY  
*Cissus rhombifolia*

### Grape Ivy

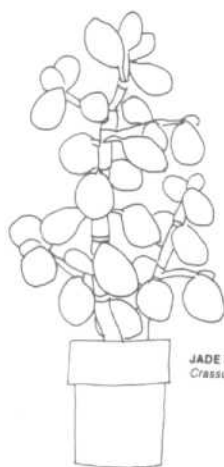
Grape ivy is a climber or trailer. The olive colored green leaves look a bit like those of holly without the stiffness or the sharp tips. The leaves form attractive groups of three and are accompanied by furry tendrils.

**Temperature** The plant is fairly tolerant of a wide temperature range. Increase the amount of humidity as the temperature goes up.

**Light/sun** Grape ivy will do all right in low light and is often used in low light areas. But it flourishes with bright light or filtered sunlight.

**Water/humidity** Soak the pot and soil thoroughly and then allow the soil to become dry to the touch before rewatering. Mist frequently and wash the foliage regularly to remove dust and restore the luster of the leaves.

**Soil** A potting soil that is rich in organic matter is the best. Be sure to add plenty of drainage material to the soil mixture.



JADE PLANT  
*Crassula arborescens*

### Jade Plant

The jade plant is a tough plant well-suited to the hot dry conditions so prevalent in office and apartment buildings. The rounded leaves are in pairs on the branched treelike stem. A plant that is six to eight years old will produce clusters of lacy-looking star-shaped flowers.

**Temperature** Temperatures ranging from 65 to 75 degrees are fine. Lower and higher temperature will be tolerated.

**Light/sun** The jade plant will require full sunlight with shade at midday if possible. A west or south window would be good locations. If you put the plant outside in the summer, place it in a lightly shaded spot.

**Water/humidity** The soil should remain dry for several days between waterings. The fleshy leaves soak up the soil water and store it for future use. Too much water will cause stem and root rot and certain death.

**Soil** The jade plant will do well in rich garden soil that has coarse sand or fine bits of broken pots added to it for drainage. Each year give the pot a top dressing of humus. A new pot will be necessary only after about three or four years.



NORFOLK ISLAND PINE  
*Araucaria excelsa*

### Norfolk Island Pine

The delightful symmetry of this evergreen makes it a desirable house plant. The branches grow in tiers of six, each tier representing a year's growth. The bright green needles are soft and pleasant to touch.

**Temperature** The ideal temperature is between 50 and 60 degrees. High temperatures are tolerated when sufficient humidity is available.

**Light/sun** The filtered sun of an east or west window is best. Yellowing of the needles might mean too much sun.

**Water/humidity** Provide the plant with a well-drained soil and pot. Water thoroughly and allow the soil surface to become dry before rewatering. Daily misting is necessary for the warmer temperatures of most houses and offices. A pebble tray will help to add more moisture to the air around the plant.

**Soil** Garden loam mixed with equal parts of sand and peat moss makes a suitable potting mixture. Repot the Norfolk Island pine only when it has become potbound (the pot is crammed with roots). This would be about every two or three years.

## PLANTSCAPING

## Typical Plants



PARLOR PALM  
*Chamaedorea elegans*

**Parlor Palm**

The palm trees are not the easiest plants to grow. However, once you have discovered their basic needs they are a delightful addition to your indoor garden. This palm grows to about four feet tall. It is most attractive when two or three plants are grouped together in a pot. The long feathery fronds grow out of a single stem. Other varieties to try are *C. seifrizii*, *C. erumpens*, and *C. costaricana*.

**Temperature** The best growing temperatures for palms range between 60 and 75 degrees.

**Light/sun** Palms are good plants for locations without much light. They do not like direct sun light.

**Water/humidity** During the active growing season, between March and October, the palm needs moist soil but it will not tolerate soggy soil. In the winter months, allow the soil to dry on the surface before rewatering. If the foliage shows signs of browning and drying on the tips, it needs more humidity. Misting regularly is recommended to keep the foliage healthy.

**Soil** The palm needs well-drained soil of equal parts rich garden loam, peat moss, and sand. It will need repotting only every two or three years. It prefers being a bit potbound.



COMMON PHILODENDRON  
*Philodendron oxycardium*

**Philodendron**

By nature, the philodendron is a climbing plant, but it also trails. It looks best on a bracket beside the window frame, and for good effect must be kept strongly pinched back so that the plant is full of bushy young growth and does not deteriorate into two or three stringlike stems.

**Temperature** Normal house or office temperatures are fine.

**Light/sun** The philodendron is quite hardy and robust and will grow almost anywhere. However, it will fare better in a well-lighted area.

**Water/humidity** The plant should be kept evenly moist and never allowed to dry out. Be certain water does not remain in the saucer after watering. The foliage should be misted daily and the leaves cleaned of accumulated dust.

**Soil** Potting soil mixed with perlite, vermiculite, or sand and peat moss is recommended.



WINDOWLEAF PHILODENDRON  
*Philodendron pertusum* "Monstera deliciosa"

**Windowleaf Philodendron**

This philodendron has large heart-shaped leaves that are slashed irregularly. It is an enthusiastic climber and needs a piece of bark or totem for support. The aerial roots can be inserted in the soil or encouraged to attach to the totem. Keep the growing tips pinched back so that the plant doesn't get leggy.

**Temperature** The windowleaf prefers temperatures between 65 and 70 degrees.

**Light/sun** Bright light is best for this plant. However, avoid putting the plant in a location where the plant would get direct sun.

**Water/humidity** Soak the plant thoroughly and allow the soil surface to remain dry for a day or two before rewatering. Mist the foliage daily and wash the leaves weekly to remove dust.

**Soil** A soil mixture of equal parts garden loam, peat moss, and sand is fine.



PURPLE PASSION PLANT - VELVET PLANT  
*Gynura aurantiaca*

#### Purple Passion Plant – Velvet Plant

The strikingly rich royal purple coloring and velvety texture of the foliage and stems attract many growers. The green leaves and stems are covered with tiny purple hairs. The straggly growth habit is best kept in check by frequent pruning.

**Temperature** The purple passion plant likes temperatures in the 65 to 70 degree range.

**Light/sun** Direct or partial sun will promote the color.

**Water/humidity** It is important that the velvet plant not dry out. Keep the soil evenly moist at all times. A humid atmosphere is important to keep the brilliant color. Mist the foliage frequently and place the pot in a tray of moistened pebbles to raise the humidity.

**Soil** Use potting soil of equal parts garden loam, peat moss, and sand. This plant will also grow in water.



RUBBER TREE PLANT  
*Ficus elastica decora*

#### Rubber Tree Plant

This house plant with dark green glossy leaves can grow to be four feet high with a little care and not too much water.

**Temperature** Due to its hardy nature, the plant does well in any normal household temperature.

**Light/sun** The plant will do well in almost any light, but a well-lighted area is best for the rich green foliage characteristic of the rubber tree plant.

**Water/humidity** Water only when the soil is completely dry all through the pot. You should set the entire pot in a bucket when

watering, so that moisture can penetrate the deepest roots. Clean the leaves every two weeks or so with a damp cloth. Do not artificially shine the leaves as this clogs the plant's pores and does not allow it to breathe!

**Soil** Soil should be a well-drained mixture of equal parts of sand, peat moss, and garden loam. If pot is plastic or rubber, be sure to provide plenty of drainage material in the bottom of the pot.



WANDERING JEW  
*Zebrina pendula*

#### Wandering Jew

This is a particularly attractive hanging plant. It is hardy and easy to grow with only one special requirement, which is regular pinching to keep it full and bushy. There are several plants called Wandering Jew, distinguished from each other by their different colorings and markings. The illustration is a *Zebrina pendula*. The leaf is a pointed oval with a deep purple underside, and the upperside is dark green striped with pale silvery-green. *Tradescantia fluminensis* has small oval green leaves marked with white, silver and white, or yellow.

**Temperature** These plants prefer warm temperatures.

**Light/sun** Bright indirect sunlight keeps the foliage brilliant. Avoid direct sunlight as they are susceptible to sunburn.

**Water/humidity** Water generously, keeping the soil moist at all times. During the winter months it will not need quite as much water.

**Soil** This plant grows in a well-drained potting soil, or water.

## PLANTSCAPING

## Typical Plants



SCHEFFLERA - UMBRELLA TREE  
*Schefflera venulosa*

**Schefflera — Umbrella Tree**

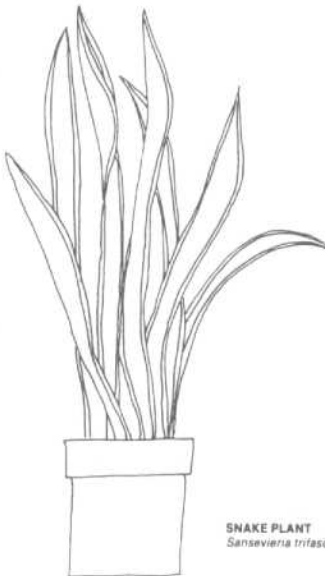
If you are looking for a tree for your indoor garden, a schefflera is a good choice. It has handsome deep green leaves that radiate out from a long slender stalk rather like the ribs of an umbrella.

**Temperature** The umbrella tree does well in a room where the temperature ranges from 55 to 75 degrees.

**Light/sun** The schefflera does not like direct sunlight. It grows best in good light from a shaded window.

**Water/humidity** When watering your schefflera, soak the pot thoroughly and then allow the soil to dry before rewatering. The plant likes a humid atmosphere and responds well to daily misting with warm water. This is essential if the plant is in a room with forced hot air heat. This plant needs a pebble tray.

**Soil** The soil mixture for the umbrella tree should be equal parts of peat moss, garden soil, and sand. The pot should have a layer of gravel or bits of broken pots underneath the soil to ensure good drainage.



SNAKE PLANT  
*Sansevieria trifasciata*

**Snake Plant**

Seen in many homes and offices, this spikey, banded plant will take almost any abuse.

**Temperature** Normal household temperatures are best, *but* do not allow the plant to become suddenly chilled!

**Light/sun** The snake plant is a good low light plant but needs sun in order to bloom.

**Water** The plant likes the dryness of the home and should never be overwatered. The leaves should be cleaned with clear water every two weeks.

**Soil** Garden loam, peat moss, and sand mixed together provides the best soil for the snake plant.



SPIDER PLANT  
*Chlorophytum elatum vittatum*

**Spider Plant**

With its green and white foliage, the spider plant makes one of the best hanging plants. The graceful trailing runners have plantlets and white star-shaped flowers. There are all-green varieties but the more commonly seen one has a green leaf striped with white.

**Temperature** The plant lives best in a warm location.

**Light/sun** This lovely plant does very well hanging in indirect sun or a moderately lighted area.

**Water/humidity** The spider plant should be allowed to dry out before rewatering. Drying leaf tips usually indicates lack of humidity. To tidy up the plant just snip these off.

**Soil** The plant grows contentedly in a rich soil composed of garden loam, sand, and peat moss.



**PLANTSCAPING**

Typical Plants; Planting Detail



**Zebra Plant**

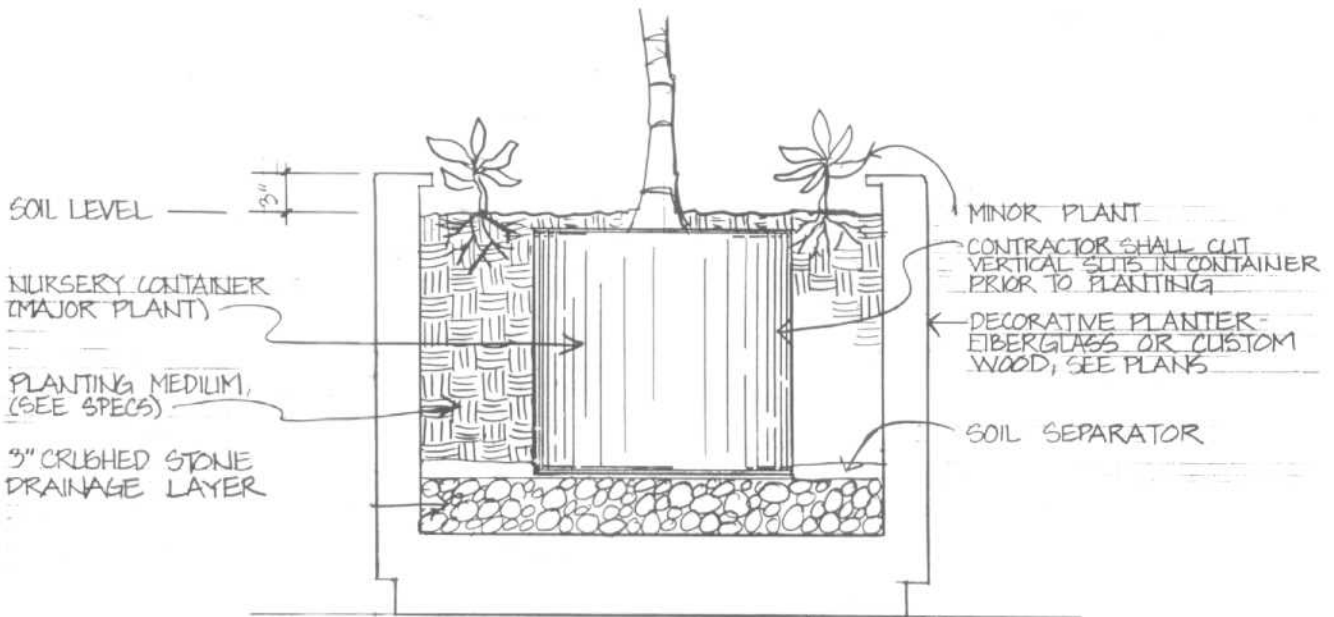
The zebra plant is one of the showiest house plants one can grow. Its spike of waxy yellow flowers and deep shiny green leaves veined in white makes it a striking specimen.

**Temperature** The zebra plant needs warm temperatures free from drafts.

**Light/sun** The plant wants bright light but not direct sunlight.

**Water/humidity** It is important never to allow the soil to dry out. Set the pot in a pebble tray and mist the foliage daily.

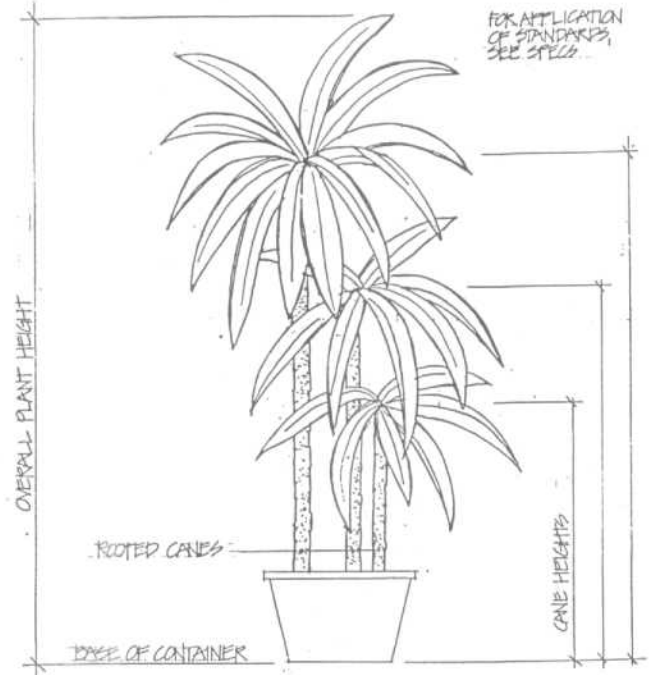
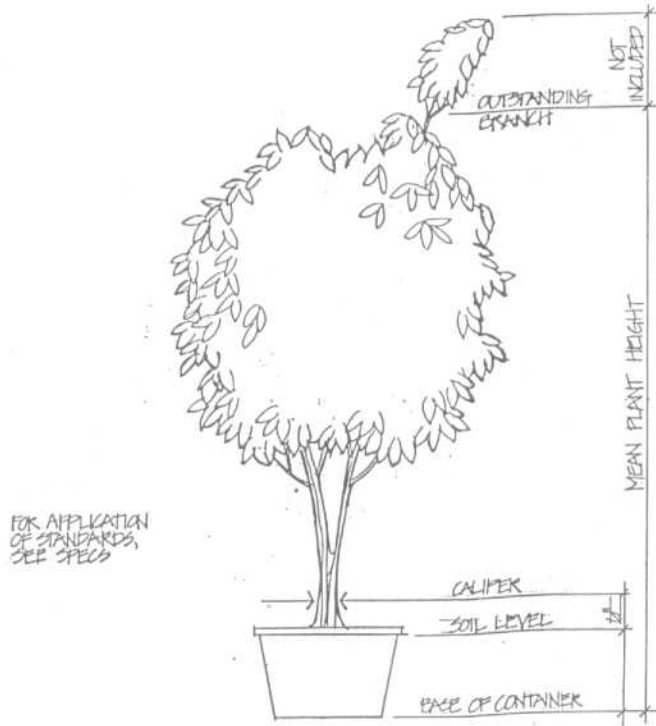
**Soil** The zebra plant likes loose soil consisting of one part garden loam, one part sand or perlite, and two parts peat moss.



TYPICAL PLANTING DETAIL

PLANTSCAPING

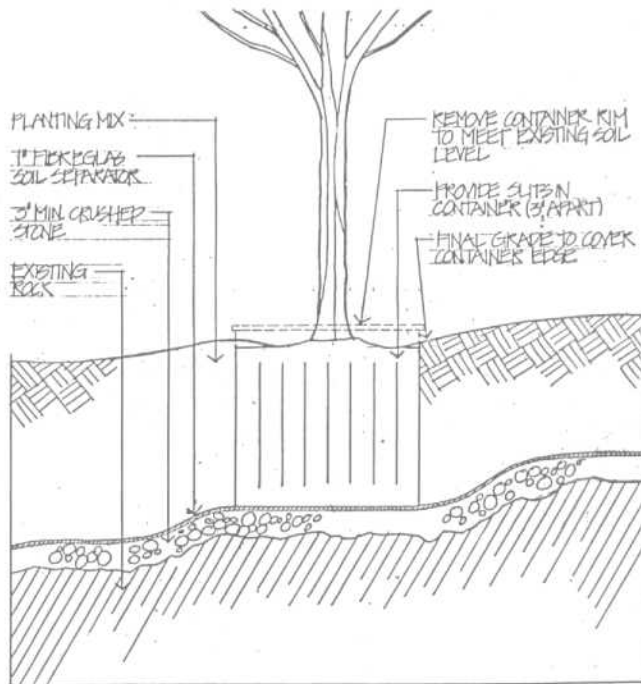
Planting Standards and Details



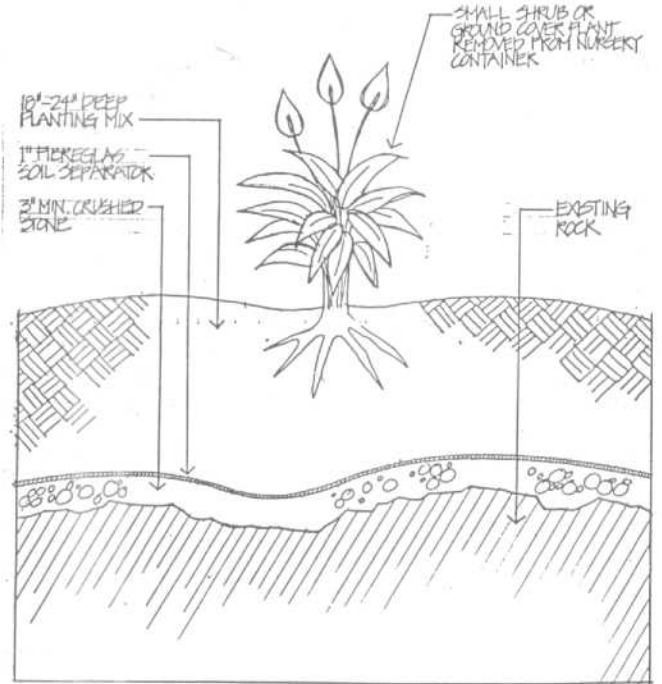
1. PLANT STANDARDS: OVERALL PLANT HEIGHT  
NOT TO SCALE

THIS DETAIL APPLIES TO ALL SHRUBS OVER 9' HIGH

2. PLANT STANDARDS: CANE HEIGHT  
NOT TO SCALE

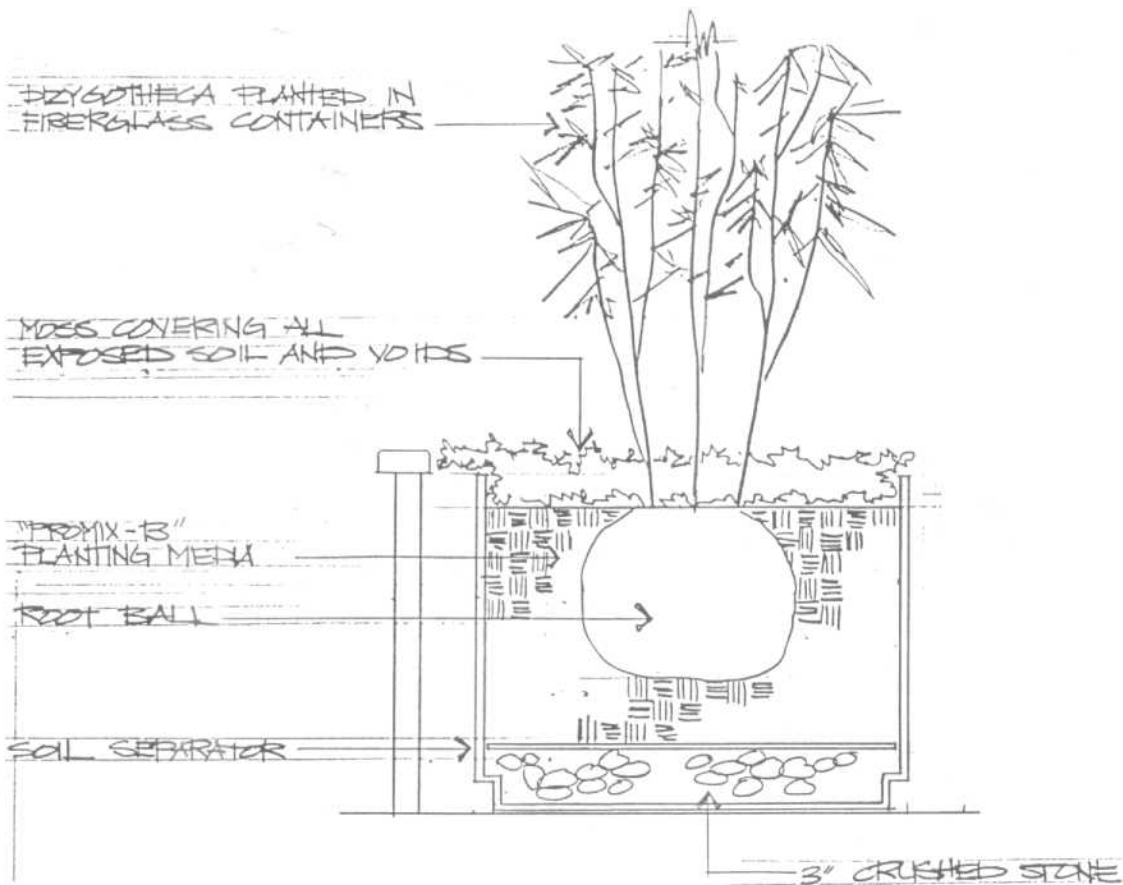
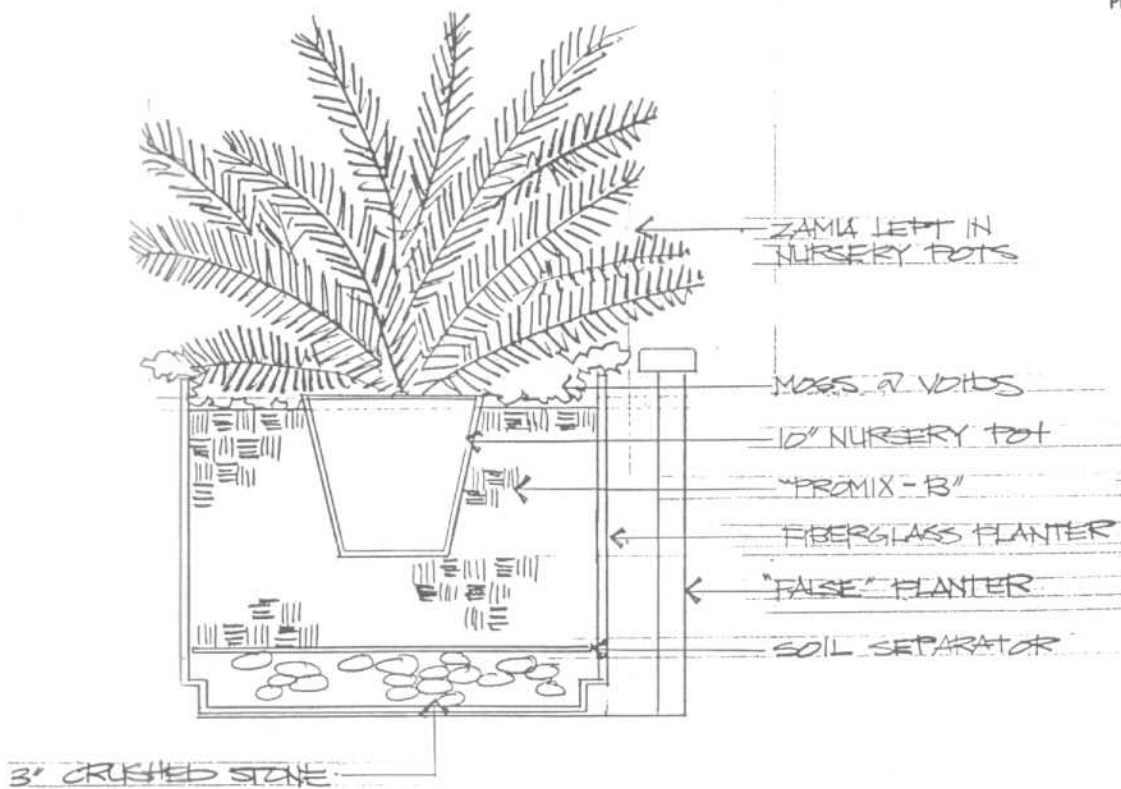


3. TREE PLANTING DETAIL  
NOT TO SCALE



4. SHRUB PLANTING DETAIL  
NOT TO SCALE

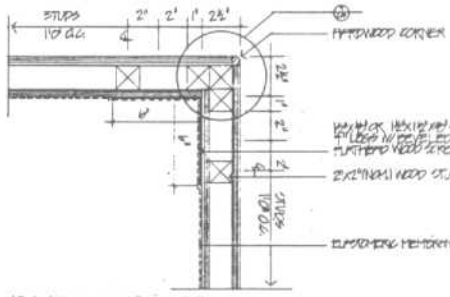




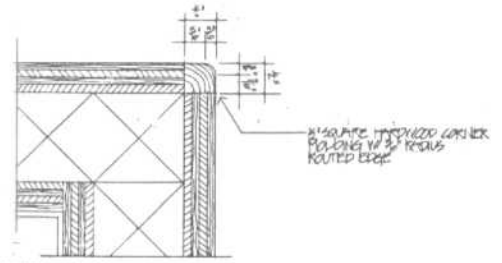
PLANTING DETAIL IN "FALSE" FLANTER

PLANTSCAPING

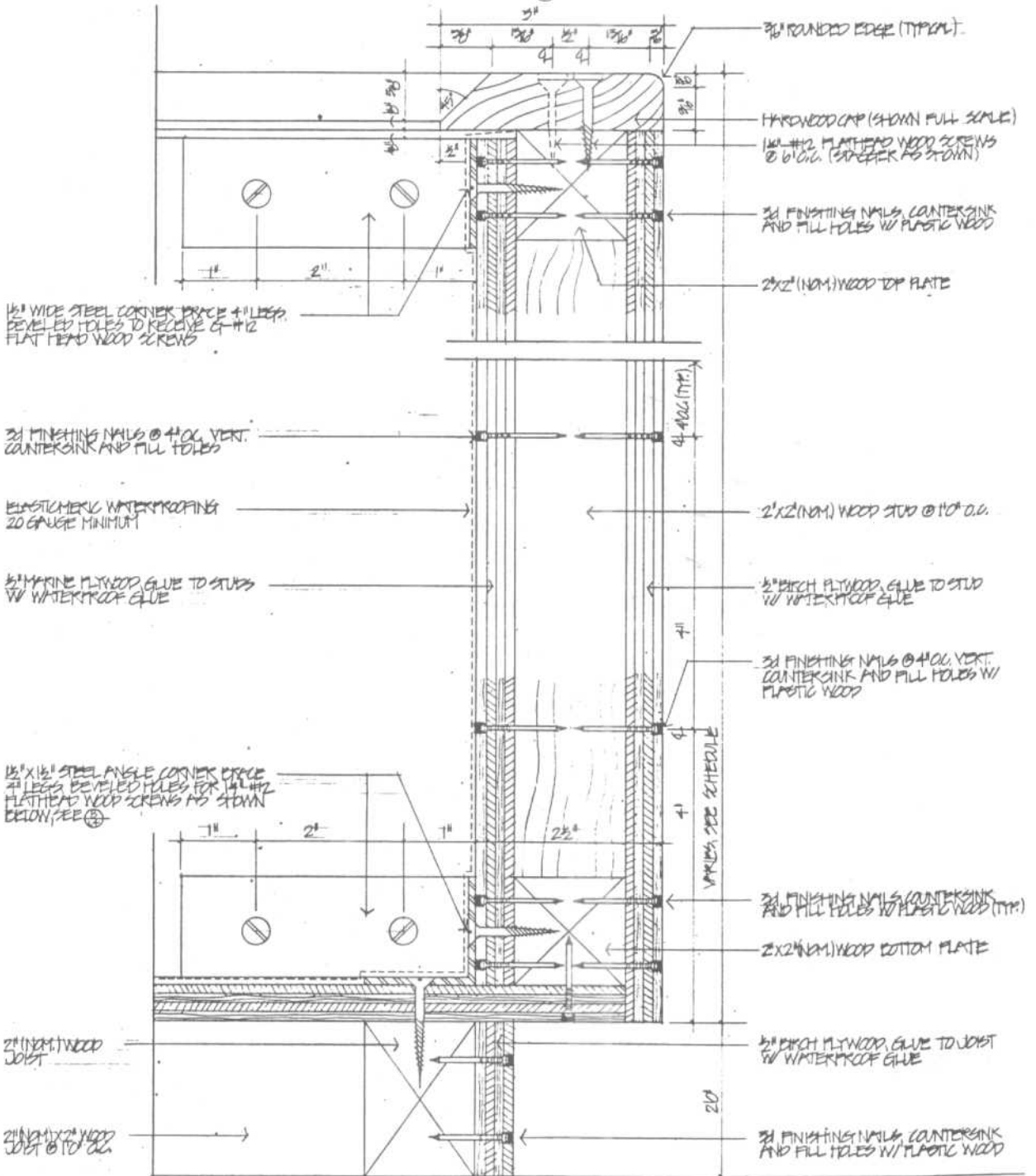
Plant Containers



8 PLANTER CORNER STUD DETAIL



9 PLANTER CORNER DETAIL



7 PLANTER SECTION

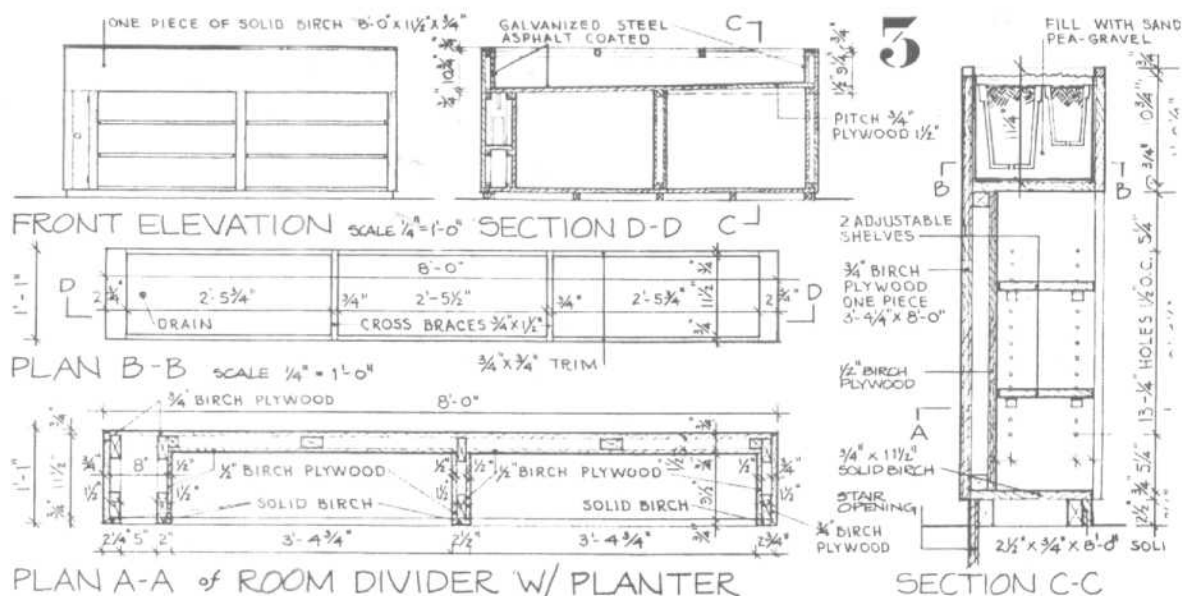
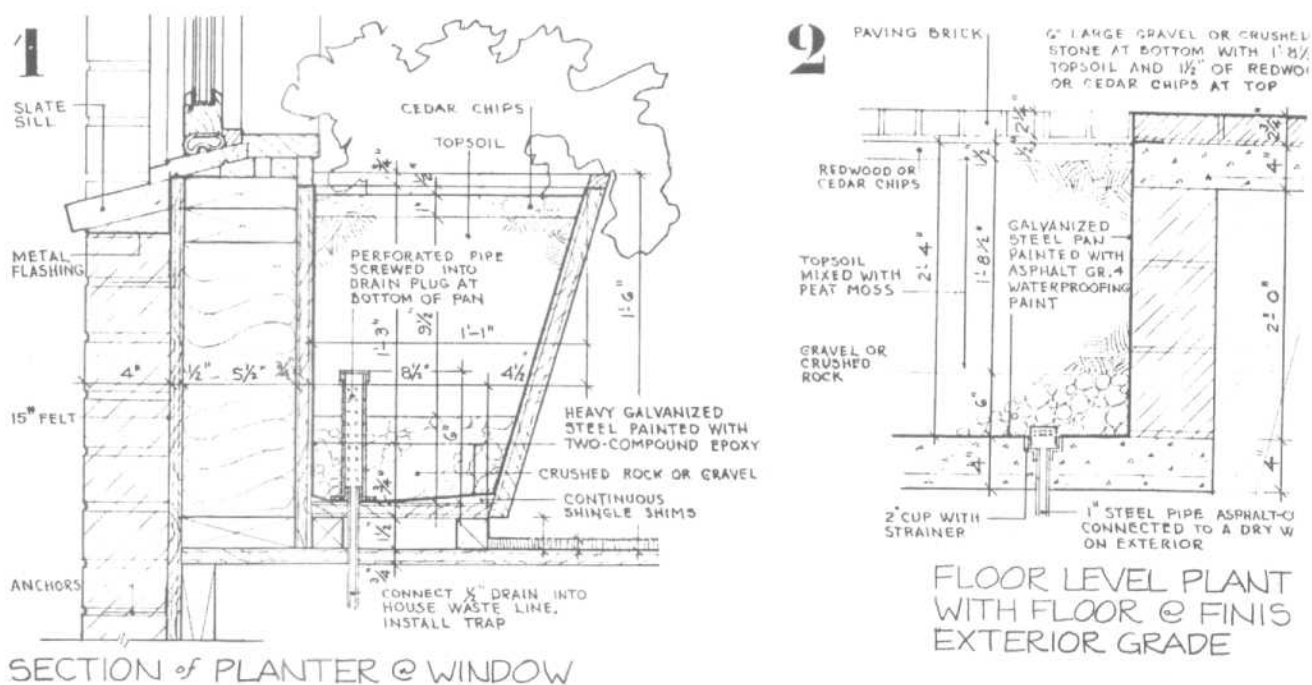
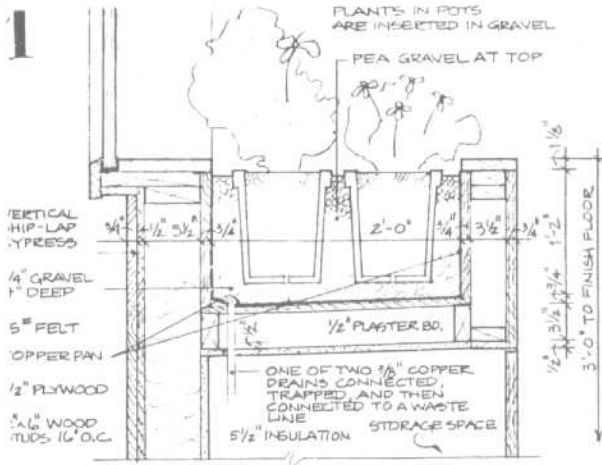


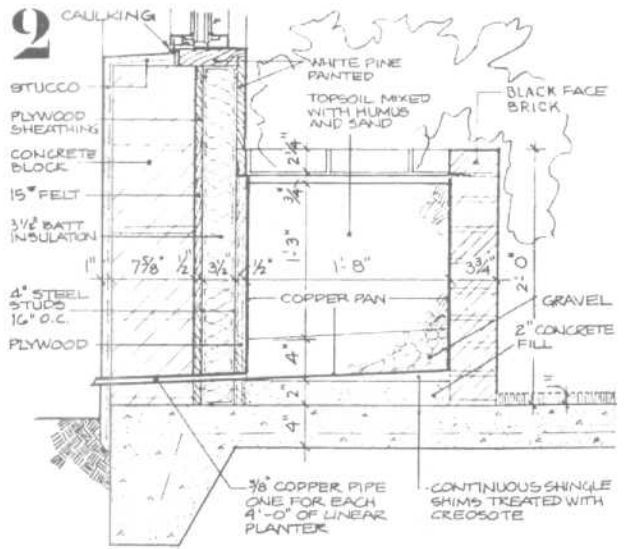
Fig. 8 Detail 1: In this window planter, the plants are placed directly in the earth or growing medium filling the planter and continue to grow and blossom there. The entire planter is contained within a galvanized steel pan with drain. The 6-in-high perforated pipe allows for drainage of excess water over a long period of time before the entire planter has to be cleaned out and started anew. Detail 2: This is a simple floor-level planter where the drainage can easily be connected to the building's drainage system. Here also, plants are installed and grow naturally until a complete planting change is required. Detail 3: A room divider planter for the Ackermann residence, Southampton, New York, consists of a planter-bookcase combination. Here the plants remain in their clay pots and are inserted in the planter with or without gravel or some other type of filler. The entire planter is pitched toward one end, where the drain empties into a small container which catches any extra water.

PLANTSCAPING

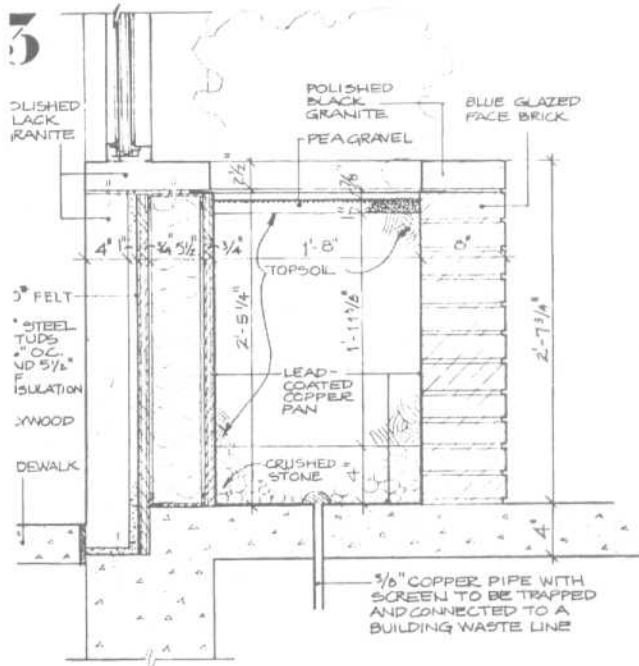
Planters



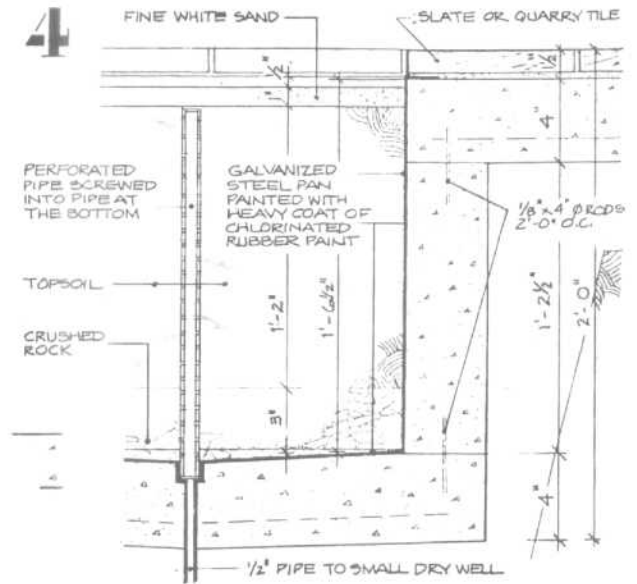
Section of window planter in a south wall



Planter for a warm climate

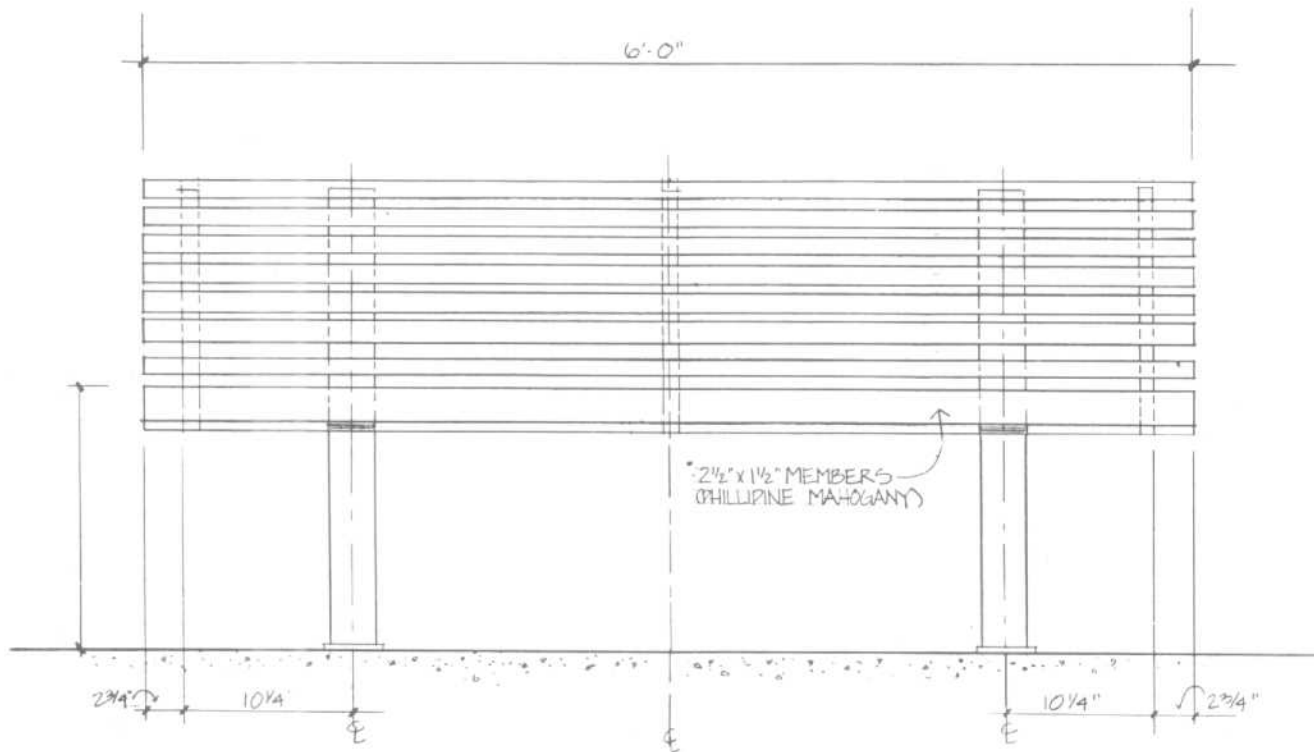


Planter for a restaurant or store

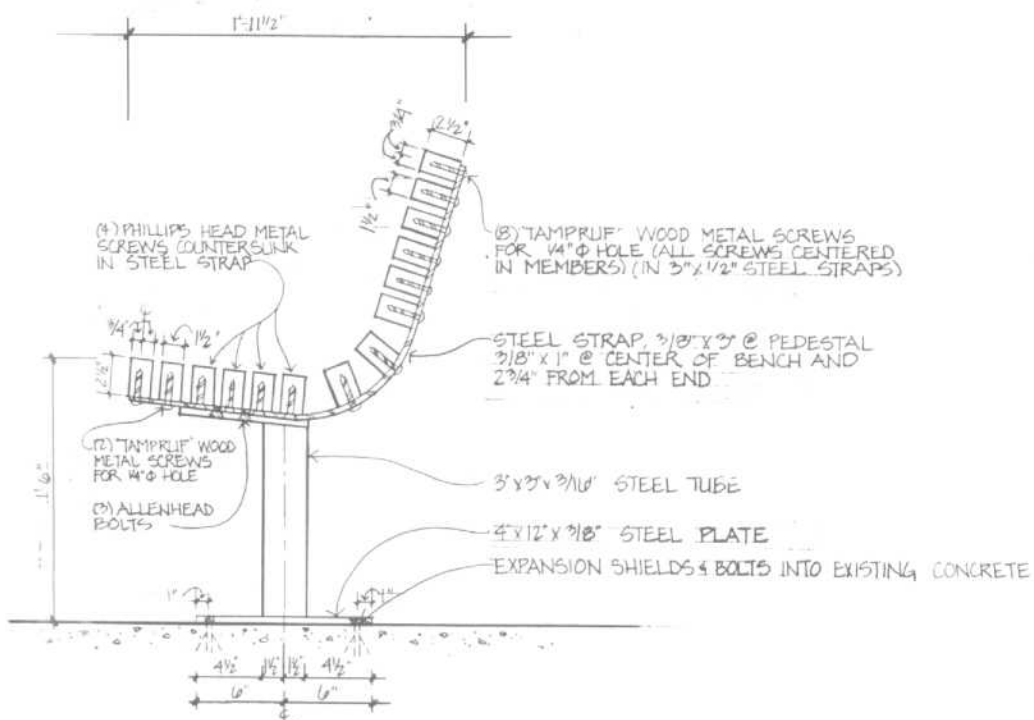


Floor planter

Fig. 9 Detail 1: The plants remain in their own clay pots. The use of pea gravel at top and only 4 in of 3/4-in gravel at bottom permits easy changes of the plants. To take care of watering and drainage, the copper pan is simply sloped to one side and two screened drains are connected, trapped, and joined to a waste line. This takes care of any excess water, as it is eliminated by gravity drainage. Detail 2: This planter is for areas where freezing does not occur, and the drainage of excess water can be taken care of by simply extending small pipes directly to the exterior. Detail 3: In this planter the plants remain within the planter and excess water is carried off by a screened pipe at the bottom. Pea gravel is used as a 1-in topping so that odds and ends dropped into the planter can easily be removed. Detail 4: A planter in a commercial lobby or entrance is shown in this detail. The plants are permanently installed and the tall drainage pipe takes care of any top applied water. The white sand at the top is to bring contrast to the colors of the plants.



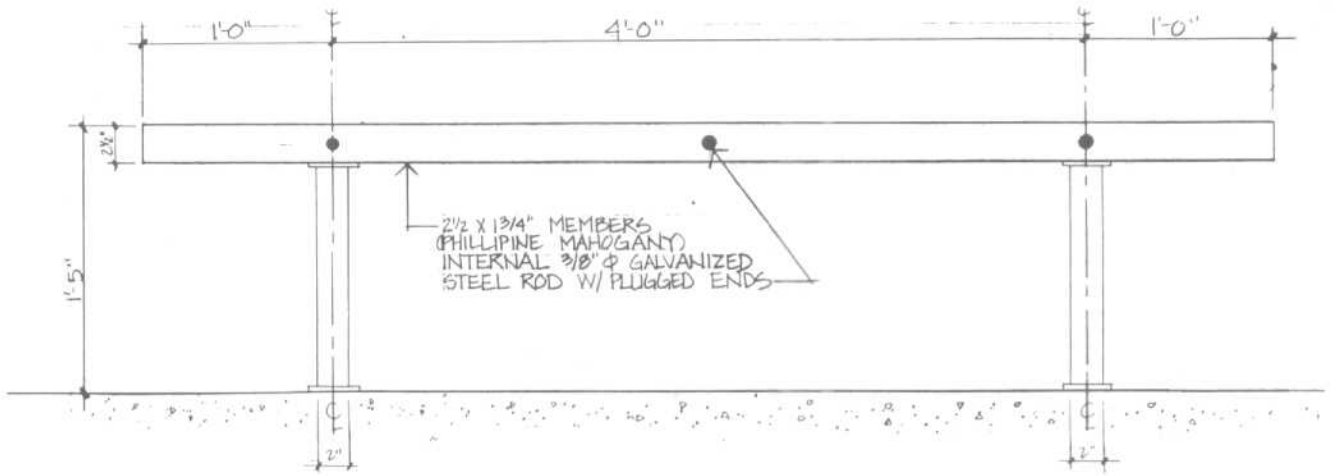
FRONT ELEVATION



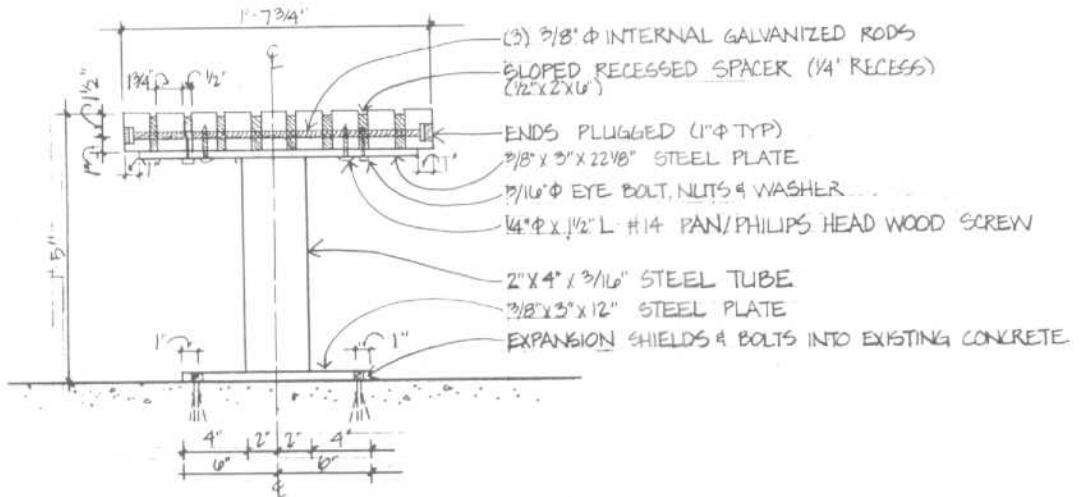
SECTION

PLANTSCAPING

Benches



FRONT ELEVATION



SECTION

## SIGNAGE SYSTEM DESIGN CRITERIA

Initial consideration should be directed toward determining the basic parameters required in developing the sign system. Each of them merits discussion here.

### Performance Requirements

Signs usually must be designed to meet specific performance requirements. The good designer will determine how a system is to perform within given space relationships. The sign system may function entirely on its own merit, or it may be supplemented by staff personnel at major decision-making locations, such as the main lobby and reception areas. Sign devices may become decorative amenities to be featured within the environment, or they may be subtle and low-key elements of minor importance. Supergraphics may be considered in certain areas simply as an art form, or as a functional graphic device presented in large scale for emphasis of context. Certainly, a combination of the two is feasible. These are only several performance considerations that should be addressed prior to the development of the signage system. The designer must evaluate the needs of the client, the unique traffic flow requirements and mounting restrictions dictated by the structure, and the basic performance requirements desired of the signing devices to be utilized.

### Usage Considerations

The general nature of the building complex often defines how signs are to be used. They may be given an appearance of being fixed and an integral part of the architecture by the appropriate selection of materials, colors, and mountings, or they may appear changeable and temporary should need so dictate. Some signage requires constant change to properly relate information to people or people to facility, while most sign devices are considered permanent fixtures within a given space. The designer is responsible for determining how signs are to be used most effectively, and at the same time, for enhancing the environment.

### Durability Requirements

Prior to the selection of materials for a signing system, durability requirements must be considered. The vast assortment of materials available for signs covers a wide spectrum of durability from soft plastics to metals. The sign copy and background material should be evaluated both individually and jointly when considering durability requirements.

### Vandalism Considerations

Signs located in controlled spaces are often free from destructive vandalism; however, in many instances vandalism becomes rampant and uncontrolled. There are no materials that may accurately be labeled "vandal-proof." However, some materials are more

vandal-resistant than others. Where vandalism is of prime importance, only materials and graphic techniques engineered to resist destruction should be considered.

### Flexibility to Accommodate Changes and Additions

Modern architectural structures are designed to accommodate inner spacial changes to meet tenant needs. Partition systems, prehung door units, room dividers, and modular furniture have ensured ease of change in officescapes. The sign system may also require alterations to preserve continuity. Changes and additions to a sign system should be considered by the designer prior to the selection of materials, graphic techniques, and mounting methods to be used.

### Readability Factors

Sign readability is determined by the letter style selected, size of copy, interletter spacing, copy position relevant to background, colors, and angle of observance.

**Letter style** Letter styles are classified as sanserif and serif. Sanserif letters, such as Helvetica, are more contemporary than serif letters, such as Clarendon (Fig. 1). Each letter style has its own unique personality and flavor. Printers carry alphabets in most letter styles, including lowercase letters as well as uppercase (Fig. 2). Test results indicate that messages starting with an initial uppercase letter and followed by lowercase characters are more recognizable than messages formed with uppercase characters only. Lowercase letters have more "personality" because their shape is varied by ascenders and descenders, resulting in characteristic word forms that are much easier to recognize than all-uppercase word forms. Also, people are more accustomed to reading text in upper- and lowercase than in all uppercase. The proper selection of a particular alphabet should be carefully considered, not only from a legibility point of view, but also from a "personality" standpoint. The letter style should make a concise and meaningful impression in the environment it serves.

**Readability** Readability is directly related to the size of copy. Visibility studies indicate that 1-inch-high Helvetica Medium, for example, is readable from a distance of 40 feet. Using this as a measure for comparison, 1-inch-high Clarendon style would be readable from a somewhat lesser distance, approximately 25 feet. The distance visibility per 1-inch height may be used as a guideline to determine distance readability for larger letters; that is, 2-inch-high Helvetica Medium will be readable at 80 feet, and 3-inch-high at 120 feet. This direct proportion may be helpful for determining copy (text) sizes for signs used in pedestrian situations. However, the direct proportion may not hold true for vehicular traffic applications where many other factors are involved. The designer must exercise

caution after selecting the alphabet and copy size to make certain the lettering will fit properly on the sign background. The sign size should be determined using the longest line of copy and the maximum number of copy lines that may be required.

**Letters and line spacing** Interletter spacing and interline spacing of copy greatly affect the overall readability of a sign. Message legibility and ease of recognition are increased when proper visual relationships are established between individual characters, words, and lines of copy. Copy with spacing too tight becomes very difficult to read; copy with too open spacing tends to break the message down into fragments (Fig. 3). Proper spacing depends largely on the distance from which the message is to be read. Messages to be read at close distances should employ tighter spacing than messages that will be read at greater distances. Spacing is also affected by the angle at which the message is to be viewed: Greater angles of observance require wider interletter spacing to prevent the characters of the message from appearing to run together.

**Copy position** The position of copy on the sign background influences the overall readability. Signs on which copy occupies most of the background are not as readable as signs that have sufficient background material surrounding the copy to form a visual barrier separating the message from the environment (Fig. 4 and 5).

Emphasis should be placed on selecting an appropriate sign size to best accommodate the sign message. There are nine basic copy placement positions to be considered in determining the important relationship of copy to sign background. They are: upper left, upper centered, upper right, centered left, centered, centered right, lower left, lower centered, and lower right. Traditionally, the most popular placement selections have been the centered and upper left positions.

**Color** Color of copy and sign background greatly affect readability. Strong contrasting colors are more readable than less dramatic color combinations. White copy on a black background offers the greatest contrast and readability. Color also influences the apparent relationship between the copy size and the background. For example, white copy on a black field appears larger than black copy on a white field, although letter height, size, and copy position remain the same in both examples (Fig. 6).

Colors in a signage system should also relate harmoniously with the pallet of colors selected for the building and its environment. The designer may choose to select colors that blend with the environment or vibrant primary colors that accent the sign system and perhaps contrast with the architectural color scheme.

## Helvetica Medium Clarendon

Fig. 1

## HELVETICA MEDIUM CLARENDON

Fig. 2

## Architectural Signage Systems Architectural Signage Systems Architectural Signage Systems

Fig. 3



## SIGNAGE AND GRAPHICS

## Signage System Design Criteria



Fig. 4



Fig. 5

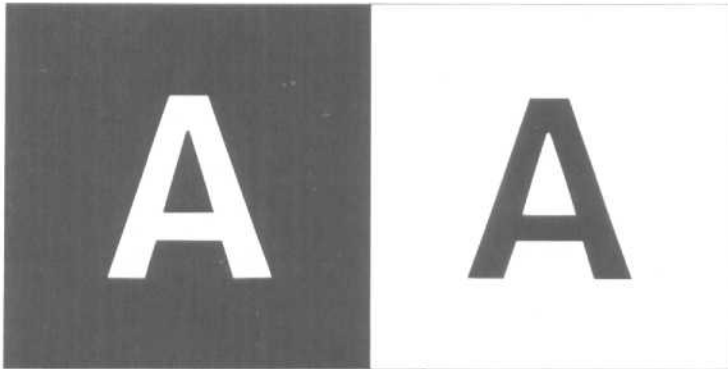


Fig. 6

**The viewing angle** The angle of observance is influential in the design of a signage system, since it affects interletter spacing and overall readability. Normally, interior signs are viewed chiefly from a straight-on position; however, exterior signs are frequently seen from more than one angle. Signs to be read from vehicles moving at varying speeds with different angles of observance may require a compromise in letter spacing to best communicate the message.

#### Multilingual Needs

The jet age is a contributing factor in bringing people together from all over the world to visit and transact business. Transportation terminals and public facilities that may be used by visitors unaccustomed to reading English should employ sign systems that bridge any visual communication gap. Multilingual messages in English and the dominant foreign languages used by visitors may be combined and presented on one sign background. However, sign design and graphic formats become very critical to prevent confusion. A more popular solution involves the use of pictorial symbols as word substitutes. Pictographic signs are bold, recognizable images not bound by language barriers.

#### Regulatory Considerations

The designer should become aware of regulations governing signs. Federal regulations concerning safety signs are enumerated in Occupational Safety and Health Administration (OSHA) publications. American National Standards Institute (ANSI) publishes standards concerning signage for the physically handicapped. Underwriters' Laboratory (UL) issues standards applicable to illuminated signs. State and local codes contain regulatory information concerning sign sizes, mounting locations and heights, quantities of

signs allowable in various zoning areas, and other restrictions relating to exterior signs. These rules, and those of other regulatory bodies, should be taken under advisement prior to completing a comprehensive signage program.

#### Need for Illumination

Many signs are required to relate their messages after dark as well as during natural daylight. The careful designer will determine which signs require artificial illumination and decide on the method of illumination. Signs can be externally illuminated by readily available stock fixtures produced by many manufacturers, or they can be internally illuminated. Fluorescent lighting is the most common source of internal illumination, although metal arc lamps, incandescent lamps, and neon are frequently employed.

#### Need for a Graphics Manual

Many signage programs are developed for institutions that have a continuing need not only to maintain, but also to augment or change, their signage systems. The preparation of a signage manual containing all the information required to create additional signs or components would benefit the client and ensure continuity in the system as changes and additions are made. The designer should determine this potential need and include the manual with other documents developed for the signage program.

#### SIGN TYPES CATEGORIZED BY FUNCTION

Signage systems should be logically broken down into various types of signs to be utilized on a particular project. Many categories of sign types may be developed, but one of the most conclusive listings is based on function. The following discussion of signage system

components, including sign requirements for specific applications, covers these functions.

#### Exterior Signs

Exterior sign system components are normally viewed from vehicles or by pedestrians who have parked their vehicles and are walking toward their destination.

**Primary identification** All architectural projects require some form of identification that is both easily readable and recognizable. A person's first association with a building is the identifying device selected to "label" the structure. The importance of the first impression created by this device should be recognized. A sign that produces an image in keeping with the environment it serves reflects the quality of the people associated with that environment. Major corporations spend large sums of money on corporate identity programs to ensure the visual image presented to the public best reflects corporate philosophy and product desirability. Equal emphasis should be placed upon the image presented by the device employed to identify an architectural structure.

**Secondary identification** Many complexes containing more than one basic structure require secondary identification signs to properly identify the various elements within the complex. A systems approach to design will provide continuity in the relationship of primary to secondary identification signs.

**Vehicular advance notice** A system of road signs suitably located in advance of decision-making points will allow vehicular traffic to execute the proper decisions smoothly and safely at the appropriate times.

**Vehicular directional** Intersections and parking facility entrances are major decision-making locations requiring directional devices to guide drivers toward their destination.

**Traffic regulatory and control** Vehicular traffic can be systematically controlled by employing signing devices. Traffic codes are usually clear as to what signs are required, where they are to be located, and the height at which they are to be mounted. Usually, colors, sizes, and shapes are standardized by the traffic authorities. Stop, yield, and speed limit signs are representative of this classification of signs.

**Instructional** Frequently, signs are required to instruct vehicular and pedestrian traffic. These notices must be properly installed in carefully selected locations to be effective. Examples include parking procedures, delivery and service directions, and the like.

**Informational** Signs are required to present information that is both relevant to the location and important to the viewer. This information may pertain to parking rates, hours of operation, and security, or it may relate to items of interest within the environment.

**Decorative** Decorative graphics may be employed to enhance the beauty or decor of a particular area; form, color, and design may be utilized to create interest and to become features of the exterior landscape.



### Interior Signs

Interior sign system components should assist visitors to travel from the building entrances throughout the complex until they reach their desired destination.

**Identification** Multiple-occupancy buildings require tenant identification; frequently, buildings with only one tenant will also utilize identification in the main lobby or reception areas to reinforce the corporate signature. Criteria for multiple-tenant signage are very important and should be included in lease documents to provide for visual continuity and architectural harmony. When individuals are allowed to implement their own desires concerning signage, each will attempt to outdo the other, resulting in clutter, confusion, and visual pollution. Signs that are too big, too gaudy, too competitive, and poorly conceived and executed will become commonplace unless controls on tenant identification are established and enforced.

**Primary directory** Information relevant to one's location within a complex should be clearly enumerated on the primary directory, usually located in a very visible area of the main lobby. Alphabetized listings of tenants, departments, and individuals should be concise and should designate the floor and room numbers. Such directories may be flush or recessed wall mounts, horizontal projected wall mounts, or pedestal or kiosk mounts, and internally illuminated or not, depending upon the ambient lighting conditions.

**Elevator lobby floor directory** High-rise structures require well-positioned signage that not only identifies each individual floor, but also serves as a secondary directory system for that floor. Frequently, the floor identification, directory, and corridor directional signage may be included in one device. When a visitor exits from an elevator on a chosen floor, a sign showing the floor number and also the direction of the office or room number sought is both helpful and reassuring.

**Pictorial "you are here" indicators** Pictorial schematic maps may become an integral part of directory systems, or they may be utilized separately as visual aids in depicting one's intended passage through a complex. Hospitals, sports complexes, and transportation centers, are good examples of structure that may require pictorial maps to supplement word messages. Caution will be exercised by the expert designer to keep the pictorial map simple and correctly oriented in the building according to where the viewer is standing, and to evaluate the need of color coding as part of the visual aid. Too frequently, designers employ a complicated color-coded system that becomes very confusing to the viewer and, in fact, compromises the effectiveness of the system.

**Primary directional** The maze that often results from interior corridor layouts creates many decision-making points for a visitor. Primary directional signs may be ceiling-mounted, wall-mounted, or floor-mounted as kiosk-type units in open areas. Areas with heavy pedestrian traffic should have directional signs located so that people do not obstruct the line of sight to the sign device.

Normally, ceiling-suspended or kiosk-type units are the best choice to enhance visibility.

**Secondary directional** Directional signs should be considered in locations where traffic flow and corridor layouts do not demand primary directional devices but do require some guidance for direction control. Corridors within suites of offices and corridors that change direction should be considered as decision-making points that may require a secondary directional signage device.

**Area identification** Specific areas within a complex should be properly identified. These areas may be tenant spaces, divisions, or departments. When occurring along main corridors, they are usually designated by wall, door, or transom-mounted devices. Ceiling-suspended signs are a good solution in open office spaces.

**Room identification** Wall- or door-mounted room identification signs are required to "label" the function of a particular room. Work functions are properly identified within tenant areas, while service and maintenance functions should be suitably designated in most situations.

**Desk identification** Reception areas may require a sign device located on a desk or counter to identify a particular service or individual rendering assistance to visitors. Such signs may be permanently affixed or removable, and may provide for changeable name inserts.

**Personnel identification** Persons rendering a service to the public, such as nurses, maintenance personnel, and food service personnel, generally are identified by name badges or pins.

**Regulatory and control signs** Signs that authorize or prohibit certain functions are required, frequently by law or code, to inform people using the facility. Examples include signs for the handicapped and signs relevant to no smoking areas, elevator capacities, "no entry" areas, fire control, and "authorized personnel only" areas. These signs are usually mounted on doors or their adjacent walls; they may employ colors which deviate from the standard colors used in the comprehensive signage system to emphasize a dangerous situation or the need for caution.

**Exits** Exit signs are required by codes to designate exits effectively in times of emergency. Supplemental devices are used to give additional information pertaining to a particular exit such as "Emergency Exit Only" and "Alarm Sounds When Door Is Opened." OSHA-approved exit signs are standard items manufactured by many lighting companies, and are generally provided by the electrical contractor.

**Information exhibit cases** Notices, posters, attractions, and promotional pieces should be contained within an appropriately designed case to control the display of this type of information. Standard units featuring vinyl-covered cork panels housed within extruded aluminum frames with lockable doors are available from many directory manufacturers.

**Decorative features** Decorative designs may be reproduced on walls as interior features. Reproduction processes include appliqué, painting, and screen printing on location; or mural processes, which are applied much like wall-coverings, may be considered. Doors may also receive supergraphic treatments in which copy may become an integral part of the design.

**Dedicatory plaques** Building dedication plaques should be carefully conceived and implemented, using materials that reflect favorably upon the talents involved in the realization of the project. Historically, these plaques have been bronze or aluminum castings. However, modern technology has provided photographic methods and photochemical processes which offer the designer a freedom of size, format, letterform, and color not available in the casting operation.

**Donor recognition** Buildings constructed in part by contributions from donors require special recognition for the donors. Hospitals, performing arts centers, and service institutions rely on gifts to assist in financing buildings, additions, and furnishings, and usually stipulate that donors will be remembered and recognized in some prestigious location in the building. The designer is responsible for establishing controls and developing a system that fulfills promises made by those soliciting funds, while allowing flexibility to expand the system as future needs may dictate. Location selection is very important in the overall effectiveness of the donor recognition signage.

**Mechanical, instrumentation, and control system markings** Many industrial and mechanical installations require equipment, control, and pipe markings to meet codes, assist maintenance and service personnel, and ensure safety. Often, these locations are not public spaces, and require an industrial, rather than an architectural, approach to signage. Elevator floor-indicator panels, however, should receive special attention and be considered in a comprehensive signage program.

### CONCEPTUAL DESIGN OF THE SIGN FACE

Emphasis will not be placed on the graphic design of each sign required in a comprehensive signage program. However, the following considerations will help to ensure continuity, correctness, and aesthetic acceptability.

**Alphabet selection** An alphabet must be carefully chosen that best exemplifies the graphic image to be portrayed to the public without compromising legibility and performance requirements. More than one alphabet may be selected should need dictate. However, good design practices should be maintained in choosing the family of alphabets to be employed.

**Interletter, word, and line spacing** Each alphabet has its own "personality" and visual impact; therefore, spacing between characters, words, and lines of copy must be carefully developed to give the best legibility and visual harmony possible (Fig. 8).

## SIGNAGE AND GRAPHICS

## Signage System Design Criteria

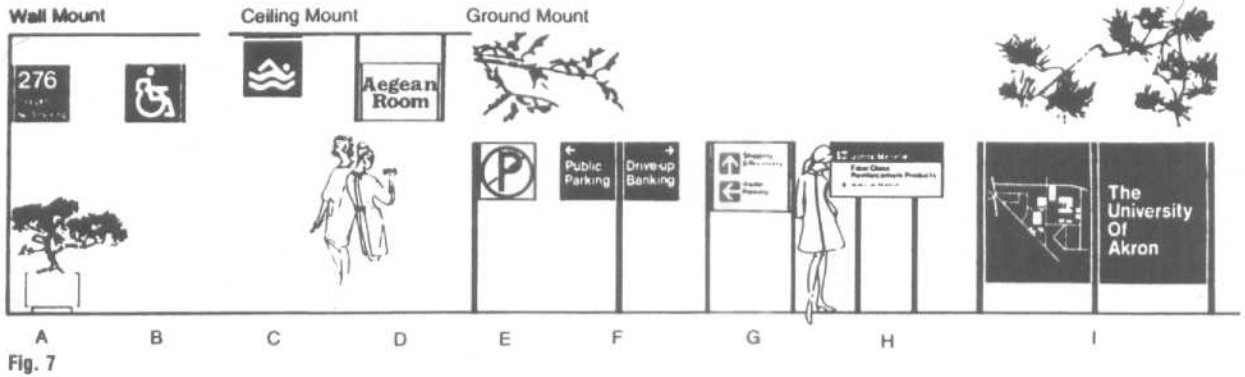


Fig. 7

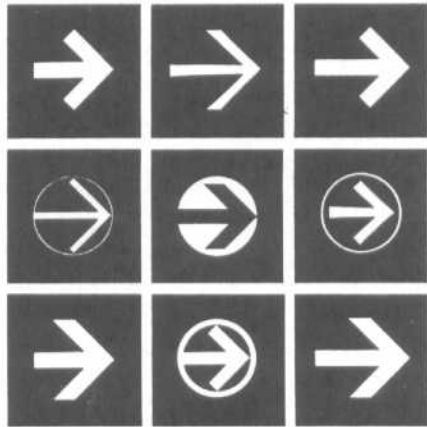


Fig. 9

## Architectural Signage Systems

### Planning · Design · Implementation

Fig. 8

These Doors Should  
Not Be Opened  
Except During  
An Emergency

Fig. 10

Emergency  
Exit Only

Fig. 11

**Arrow selection** Directional arrows should be designed to reflect the "personality" of the letterform selected. Stroke width and size relationships are important considerations (Fig. 9).

**Copy determination** The message for each sign must be accurately determined and the copy condensed to the fewest words that will still relay the desired message. Wordy signs are frequently misread or not read at all. The message must be concise, clear, and informative (Fig. 10 and 11).

**Copy placement format** The placement of copy on a sign face may take one of the nine basic positions or a custom format for special situations (Fig. 12).

**Size determination of the sign face** After the copy for each sign is in final form, the sign with the greatest amount of copy is selected from each of the sign types utilized and the desired copy height is determined for each type. This height should be based upon the distance from which the sign will be read and the graphic design portrayed. Using this letter height, the message should be laid out with photographic type or transfer lettering to scale, incorporating the copy placement and spacing requirements. The most pleasing shape and size for the message to be contained are then determined, realizing that this particular layout is for the maximum copy required for that particular sign type. A shape and size format should be chosen that works well as a module which can be proportioned and become applicable to the entire family of

sign types. While this may be ideal, frequently the proportional system is not applicable. An example of each sign type should be drawn to scale and fully dimensioned to serve as a production guide for signs within that type. (Fig. 13).

**Color selections** Selection is then made of the copy and background colors that offer good contrast and harmoniously blend with the prominent colors in the environment. It is also wise to consider any corporate colors required by the client.

#### SIGNAGE SYSTEM DEVELOPMENT CHECKLIST

The completed sign schedule, location plans, scaled drawings of typical examples from each sign type, construction or assembly details or both, mounting details, and specifications form the documents required to bid competitively or to negotiate signage projects. Well-prepared documents prevent individual interpretation by vendors and result in comparable competitive bids.

The following systematic approach to the design and development of a comprehensive signage program will serve as a guideline to problem solving, employing the concepts contained in this chapter. This checklist may be expanded or condensed to meet individual project parameters. The basic systematic thought process, however, is applicable to all projects.

1. Develop the signage system design criteria based on:

- a. Performance requirements
  - b. Usage considerations
  - c. Durability requirements
  - d. Vandalism considerations
  - e. Flexibility to accommodate changes and additions
  - f. Readability factors
  - g. Multilingual needs
  - h. Regulatory considerations
  - i. Need for illumination
  - j. Need for graphics manual for ongoing implementation and system maintenance
2. Study the traffic flow patterns, determine all sign locations, and draw the location symbols on the site and floor plans.
3. Evaluate and select the sign types required from the following list, categorized by function, that meet the design criteria:
- a. Exterior sign types:
    - Type A – Primary identification
    - Type B – Secondary identification
    - Type C – Vehicular advance notice
    - Type D – Vehicular directional
    - Type E – Traffic regulatory and control
    - Type F – Instructional
    - Type G – Informational
    - Type H – Decorative
  - b. Interior sign types:
    - Type I – Primary identification
    - Type J – Primary directory
    - Type K – Elevator lobby floor directories
    - Type L – Pictorial "You Are Here" indicators
    - Type M – Primary directional
    - Type N – Secondary directional

- Type O – Area identification
- Type P – Room identification
- Type Q – Desk identification
- Type R – Personnel identification
- Type S – Regulatory and control
- Type T – Exit
- Type U – Information exhibit cases
- Type W – Dedicator
- Type X – Donor recognition
- Type Y – Mechanical, instrumentation, and control system markings
- Type Z – Other (to be specified by designer)

4. Select the best signing devices for each sign type designated above from the following lexicon of signage system components

that most effectively satisfy the design criteria established:

- a. Elevated pylons
  - b. Monolithic sign structures
  - c. Panel and post assemblies
  - d. Illuminated sign cabinets
  - e. Directory and informational systems
  - f. Die-cut pressure-sensitive lettering
  - g. Dimensional graphics
  - h. Plaque signage
  - i. Environmental graphics
  - j. Other (to be defined by the designer)
5. Conceptually design the sign face for each sign type selected, indicating:
- a. Alphabet selection
  - b. Interletter, word, and line spacing
  - c. Arrow selection

- d. Copy determination
  - e. Copy placement format
  - f. Size determination of copy and sign face
  - g. Color selections
6. Complete the location plans by filling in the symbol indicating sign number and type.
7. Prepare scaled drawings of typical examples from each sign type.
8. Prepare the detailed sign schedule.
9. Prepare typical construction and assembly details, mounting details, and engineering drawings for wind loading, foundations, and illumination.
10. Prepare detailed specifications for all materials, techniques, and components required in the system.

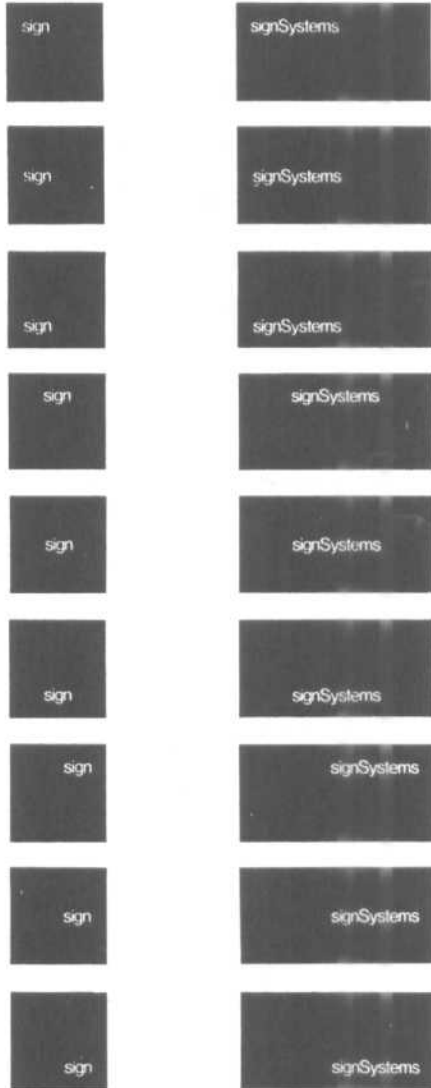


Fig. 12



Fig. 13

**SIGNAGE AND GRAPHICS**

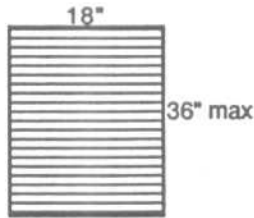
Standard Sign Type and Mounting Heights

**STANDARD SIGN SYSTEM**

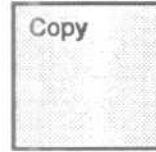


12" x 48"  
12" x 72"

Overhead

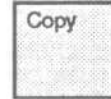


Directional



9" x 9"  
12" x 12"

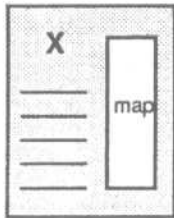
Area



9" x 9"  
6" x 6"

Room

**CODE SIGNS**



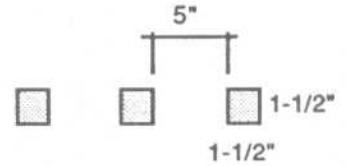
fire evacuation  
map

Elevator



stair markings

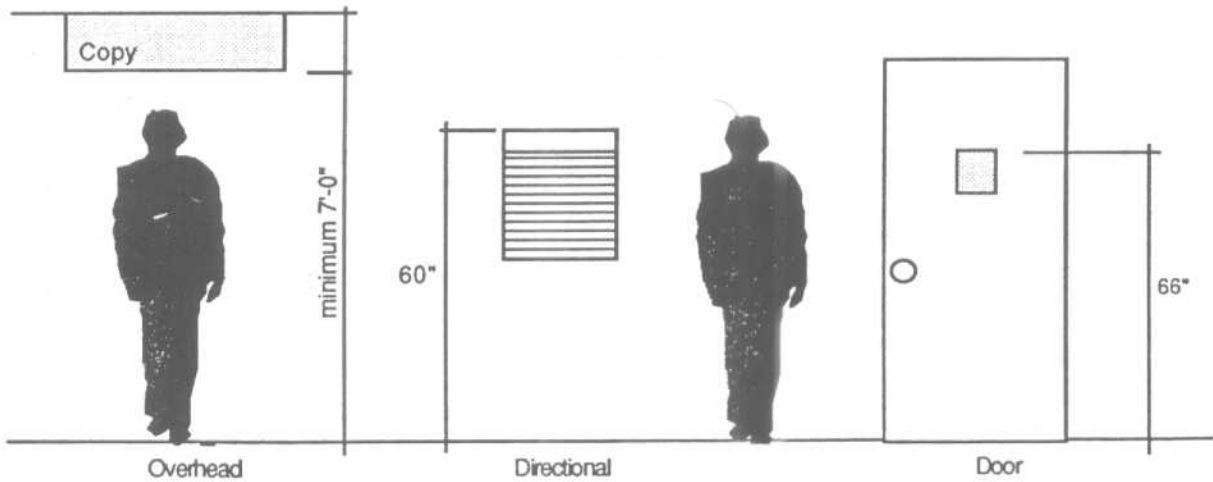
Stair



on glass doors  
and sidelites

Distraction strips

**STANDARD MOUNTING  
HEIGHTS AND LOCATIONS**



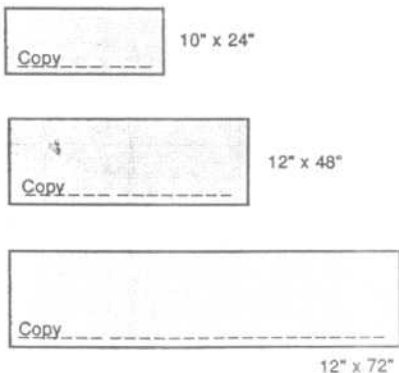
**Sign Type**  
DIRECTIONAL (CEILING-HUNG)

**Material Choices**  
MDO board, acrylic

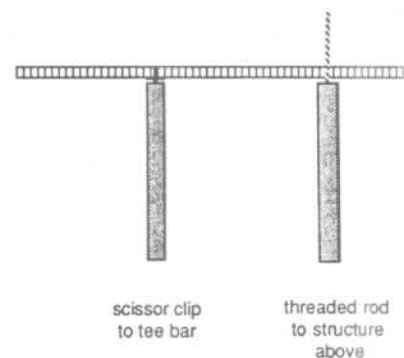
**Finishes**  
Painted, plastic laminate, metal laminate

**Graphics**  
Vinyl die cuts, silkscreen, dimensional applied letters

**Standard Mounting Detail**  
1. Threaded rod: pendant, flush  
2. Scissor clip



Standard sizes



Section

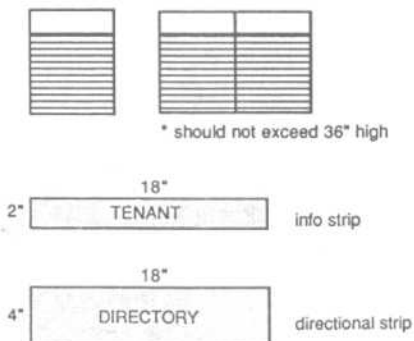
**Sign Type**  
DIRECTIONAL (WALL-MOUNTED)

**Material Choices**  
Acrylic, aluminum, acrylic with metal laminate face

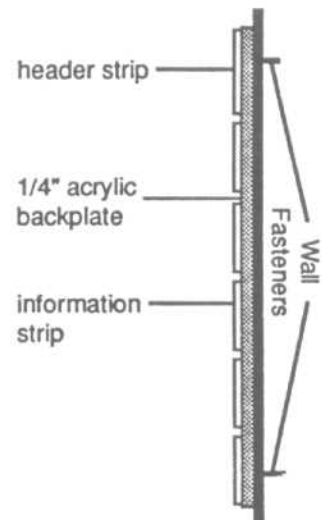
**Finishes**  
Painted acrylic or aluminum, natural aluminum or brass (satin or polished), laminates available in standard laminate finishes

**Graphics**  
Silkscreen, front surface or reverse

**Standard Mounting Materials**  
1. Backpanel: backplate with countersunk screws with shields; magnetic, form, or vinyl tape with adhesive  
2. Strips: vinyl tape



Standard sizes



Section

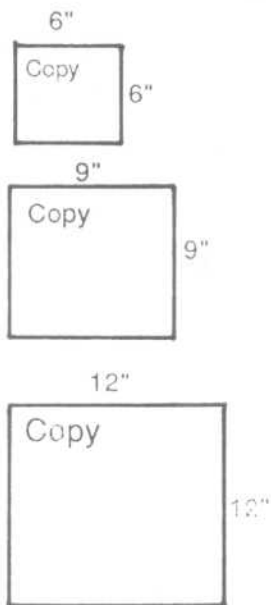
**Sign Type**  
AREA DESIGNATION (WALL-MOUNTED)

**Material Choices**  
Acrylic, aluminum, acrylic with metal laminate face

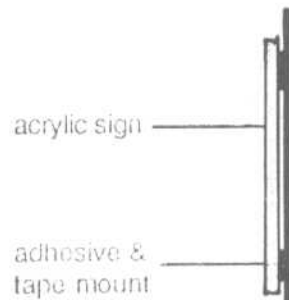
**Finishes**  
Painted acrylic or aluminum, natural aluminum or brass (satin or polished), laminates available in standard laminate finishes

**Graphics**  
Silkscreen, front surface or reverse; vinyl die cuts

**Standard Mounting Materials**  
Vinyl or magnetic tape, foam tape, silastic adhesive



Standard sizes



Section

**SIGNAGE AND GRAPHICS**

**Sign Type**

ROOM IDENTIFIER (WALL-MOUNTED)

**Material Choices**

Acrylic, aluminum, acrylic with metal laminate face

**Finishes**

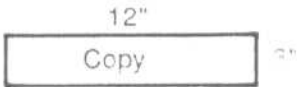
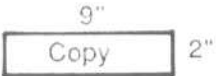
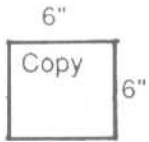
Painted acrylic or aluminum, natural aluminum or brass (satin or polished), laminates available in standard laminate finishes

**Graphics**

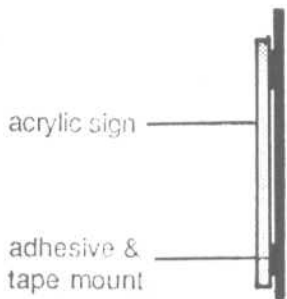
Silkscreen, front surface or reverse

**Standard Mounting Materials**

Vinyl tape, foam tape, magnetic tape, silastic adhesive



Standard sizes



Section

**Sign Type**

ROOM IDENTIFIER, CHANGEABLE MESSAGE (WALL-MOUNTED)

**Material Choices**

Holder, acrylic; insert, vinyl

**Finishes**

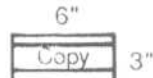
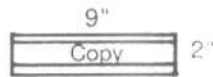
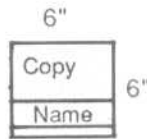
Painted (surface or subsurface)

**Graphics**

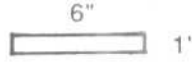
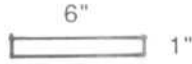
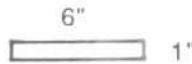
Silkscreen or vinyl die cuts

**Standard Mounting Materials**

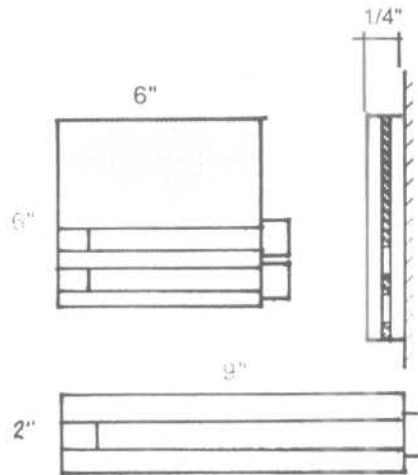
Vinyl tape, foam tape, silastic adhesive



Standard sign sizes



Standard insert sizes



Elevation and section

**Sign Type**

FRAMED PLAQUE SIGNS, WALL-MOUNTED (previous plaque types are insertable into standard frame signs)

**Material Choices**

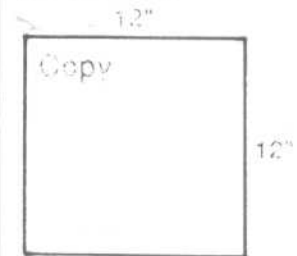
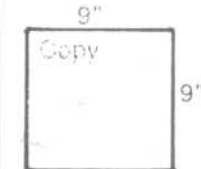
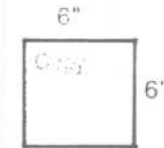
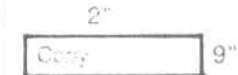
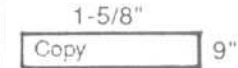
Molded acrylic, aluminum, brass

**Finishes**

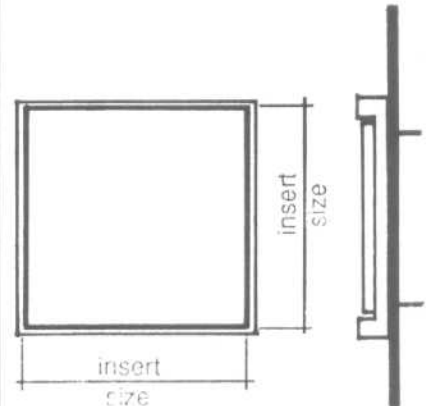
Painted, satin, polished

**Standard Frame Mounting Materials**

1. Frame: screw mount, tape and adhesive
2. Insert: adhesive or magnetic tape, Velcro, magnet



Standard insert sizes



Elevation and section

**Sign Type**

COUNTERTOP/FLAG MOUNT

**Extrusion Material**

Aluminum

**Insert Material**

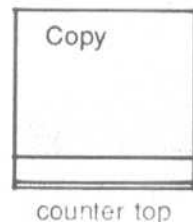
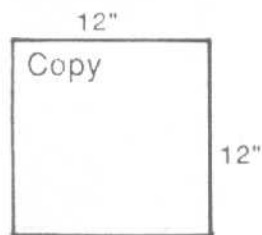
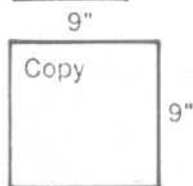
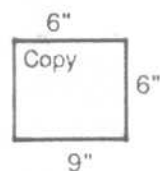
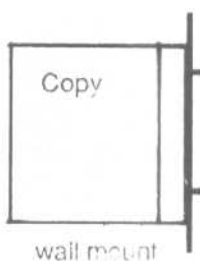
Acrylic, aluminum, acrylic with metal laminate

**Graphics**

See area and room plaques

**Standard Mounting Details**

1. Counter: free-standing with extruded aluminum base
2. Flag mount: countersunk screws and shields

**Standard sizes****Elevation and section****Sign Type**

DESKBAR (DESK TOP)

**Material Choices**

Aluminum, molded acrylic

**Finishes**

Painted, satin, polished

**Graphics**

Vinyl die cuts; silkscreen on acrylic plaque, front surface or reverse

**Standard Mounting Detail**

Free-standing on desks or countertops

**Standard sizes**

Note: Changeable face available by using acrylic sign plaque.

**Sign Type**

CUT LETTERS: FLUSH, PROJECTED

**Material Choices**

Acrylic, acrylic with metal laminate face, brass, aluminum

**Finishes**

Polished, painted, brushed, sand blasted

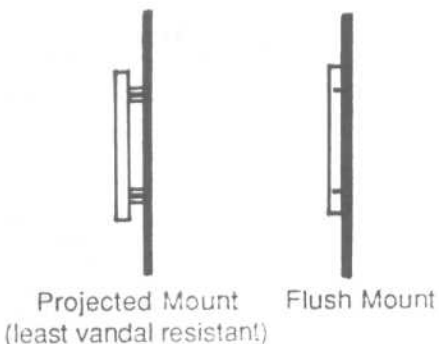
**Standard Mounting Details**

Adhesive mount, flush pin mount, standoff mount

**Standard Letter Sizes**

Varies from 2" to 18"

Front View

**Sections**

**SIGNAGE AND GRAPHICS**

Medical Symbols

**Medical**

**Nursing Homes  
Medical Complexes  
First-Aid Centers**

Pictographs not shown:

- |       |                    |       |         |
|-------|--------------------|-------|---------|
| 1.516 | Parking            | 1.413 | Health  |
| 1.372 | Playroom           | 2.531 | Warning |
| 1.150 | Library or Reading | 1.147 | Chest   |

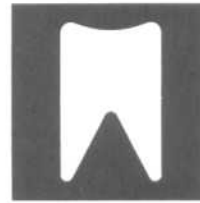
Hospital  
Pharmacy  
Dental Care  
Wheelchair



1.508



1.518



1.184



1.188

X-Ray  
Physiotherapy  
General Medicine, Female  
General Medicine, Male



1.146



1.148



1.440



1.450

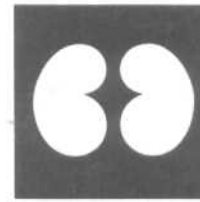
Coronary Care  
Hematology  
Urology  
Eye



1.446



1.417



1.448

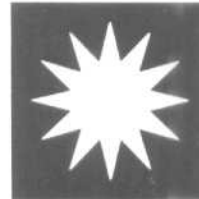


1.123

Podiatry  
Mental Health  
Ear, Nose & Throat  
Oxygen



1.129



1.473



1.137



1.368

Shower  
Isolation  
Nursery  
Laboratory



1.376



1.411

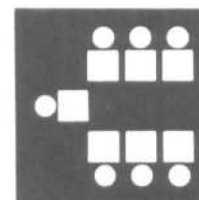


1.302



1.359

Conference  
Occupational Therapy  
Rehabilitation  
Ambulatory Patients



1.406



1.347



1.483



1.152



## Commercial

**Shopping Centers  
Stores & Shops  
Eating Facilities  
Community Services**

Pictographs not shown:  
1.218 Concrete Mixer  
1.219 Cushman Vehicle  
1.222 Dump Truck

1.226 Flatbed Truck  
1.250 Pickup Truck  
1.304 Basket

1.314 Vegetable Produce  
1.363 Newspaper Vendor  
1.370 Record Store  
1.394 Cooking

Cocktail Lounge  
Pub  
Coffee Shop  
Liquor Store



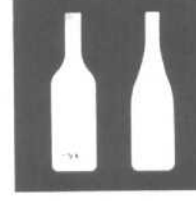
1.344



1.361



1.360

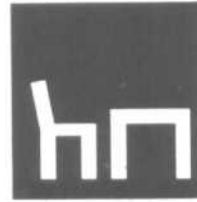


1.307

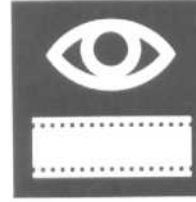
Mens' Furnishings  
Furniture  
Cinema  
Camera Store



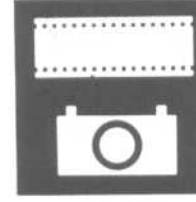
1.352



1.315



1.126

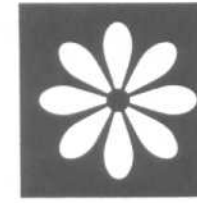


1.338

Gift Shop  
Florist  
Dress Shop  
Shoe Store



1.339



1.393



1.321



1.375

Restaurant  
Soda Fountain  
Grocery Store  
Tobacco Shop



1.354



1.341



1.337



1.316

Bookstore  
Record Shop  
Fuel  
Toy Shop



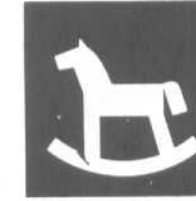
1.305



1.455



1.336



1.372

Theater  
Van  
Beauty Salon  
Barber Shop



1.449



1.290



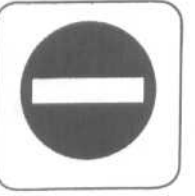
1.192



1.149

SIGNAGE AND GRAPHICS

Commercial and Travel Symbols



# Travel

Picto'grafics not shown:

1.350 Motel

1.266 Seaplane Base

Airport  
Departures  
Arrivals  
Car Rentals



1.253



1.255



1.254



1.202

Bus  
Subway  
Train  
Taxi



1.208



1.268



1.278



1.203

Monorail  
Ferry  
Cable Car  
Automobile



1.239



1.225



1.215



1.201

Lost & Found  
Porter  
Locker  
Fuel



1.310



1.319



1.308



1.336

Baggage Claim  
Customs  
Immigration  
Money Exchange



1.303



1.125



1.464



1.532

Motorcycle  
Moving Sidewalk  
Lodging  
Ice Cubes



1.241



1.145



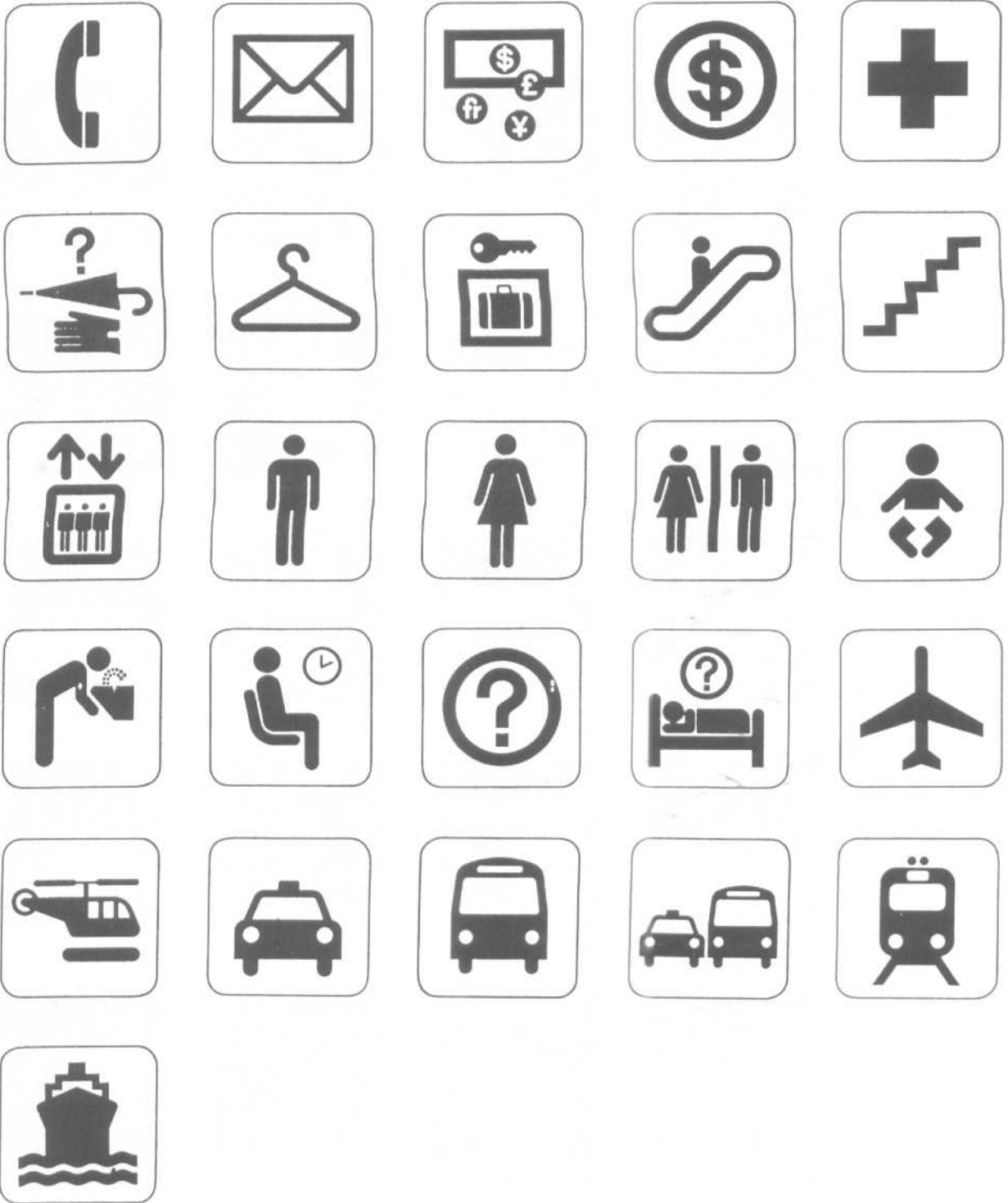
1.173



1.353

SIGNAGE AND GRAPHICS

Travel Symbols



# Recreation and Sports

**Sports Arenas  
Parks  
Recreation Facilities  
Amusement Parks**

Pictographs not shown:  
1.112 Curling  
1.115 Dancing  
1.140 LaCrosse

1.138 Hockey  
1.183 Tobogganing

1.471 Wintersports  
1.387 Outdoor Recreation

Campers  
Picnic Area  
Midway  
Trailer Train



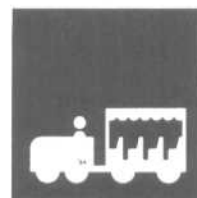
1.276



1.366



1.313



1.185

Water  
Swimming  
Canoeing  
Sailing



1.492



1.177



1.217



1.265

Marina, Boating  
Life Preserver  
Snowmobiling  
Camping



1.401



1.357



1.267



1.385

Judging  
Bicycling  
Women's/Girl's Toilet  
Fishing



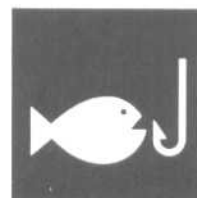
1.370



1.211



1.910



1.334

Skiing  
Soccer  
Ice Skating  
Football



1.172



1.176



1.181



1.130

Hunting, Shooting  
Golf  
Baseball  
Tennis, Badminton



1.170



1.133



1.105



1.182

**SIGNAGE AND GRAPHICS**

Universal Symbols

**Universal**

**Applicable to any building or facility**

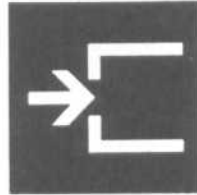
Pictographs not shown:

- 1.110 Children
- 1.144 Man with boy
- 1.340 Fragile

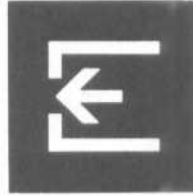
- 1.372 Playroom
- 1.410 Church
- 1.472 Synagogue
- 1.469 Police

- 1.493 Smoke
- 1.516 Parking
- 1.488 Keep Dry
- 1.155 Janitor

Entry  
Exit  
Ramp up  
Ramp down



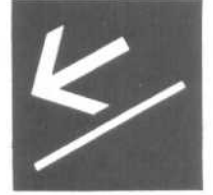
1.403



1.404

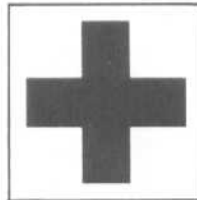


1.461



1.462

Emergency  
Women's Toilet  
Men's Toilet  
Stairs



4.412



1.189



1.143



1.377

Handicapped  
No Smoking  
Telephone  
Escalator



1.188



3.316



1.365

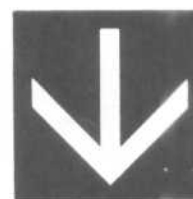


1.328

Elevator  
Down  
No Parking  
Drinking fountain



1.311



1.402B



3.516



1.139

Mail Box  
Check Room  
Up  
No Entry



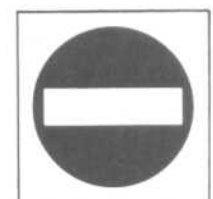
1.326



1.317



1.402A



3.463

Shower  
Waiting Room  
Telegraph Office  
Information



1.376



1.151



1.327



1.530



International symbol of accessibility

**Alternate** GOTHIC NO. 3

Americana

*Americana* ITALIC

Aster

**Avant Garde** GOTHIC MEDIUM

Baker Danmark 2

Baker Sans MONO REGULAR**Baskerville** BOLD ITALIC

Bodoni

Bookman

**Caledonia** BOLD ITALICCaslon BOLDCentury SCHOOLBOOK**Century** SCHOOLBOOK BOLDCheltenham MEDIUM**Columbus**COPPERPLATE GOTHIC LIGHTCraw Clarendon BOOK**Craw Clarendon**

Craw Modern

Delta MEDIUMEastern Souvenir MEDIUM

Eurostile

**Eurostile** BOLDEurostile EXTENDED**Eurostile** BOLD EXTENDED

Firmin Didot

Folio MEDIUM**Folio** MEDIUM EXTENDEDFortuna LIGHT**Franklin Gothic**Futura MEDIUM**Futura** DEMIBOLD**Garamond** BOLDGerstner Program MEDIUM

Gill Sans

**Harry** FAT**Hellenic** WIDEHelvetica LIGHT

Helvetica

**Helvetica** MEDIUMHelvetica MEDIUM OUTLINEHorizon MEDIUM**Karen** BOLD

Korinna

**Korinna** BOLD

Lydian

Melior

**Melior** SEMIBOLDMICROGRAMMA NORMAL**MICROGRAMMA** BOLD**MICROGRAMMA** BOLD EXTENDEDModula MEDIUM**News Gothic** BOLDOlive ANTIQUE

Optima

**Optima** SEMIBOLD

Palatino

**Palatino** SEMIBOLD**Permanent** MEDIUMPerpetua ROMAN

Plantin

Quorum MEDIUMRomana NORMAL**Schadow** ANTIQUA SEMIBOLDSerif Gothic REGULAR**Serif Gothic** BOLDSolltalre BOLDSouvenir LIGHT**Souvenir** MEDIUM ITALIC**Standard** MEDIUM**Stymie** BOLDTimes ROMAN**Times** ROMAN BOLDTrooper ROMAN LIGHT**Trooper** ROMAN

Univers 55

*Univers 56***Univers 65****Univers 67**

Univers 53

**Univers 63***Univers 55* OUTLINE*Univers 65* OUTLINE*Univers 83* OUTLINEVenus MEDIUM**Venus** EXTRABOLD**Venus** EXTRABOLD CONDENSED**Venus** BOLD EXTENDED**Walbaum** MEDIUM**Weiss** ROMAN EXTRABOLD**Windsor***Windsor* OUTLINE





## DESIGNING THE SYSTEM

The formulation of a communications program is based on the functional requirements delineated in the feasibility study. The presentation modes to be utilized are a part of such a program. They might include slides, films, videotape, and a sound-recording and playback system. The detailed design of the facility includes the selection of basic equipment, possible modification of that equipment, and provision for additional optical elements, as well as the engineering of the electrical control circuitry and the design of the electromechanical devices that may be needed.

The implementation of a proposed A-V system is not merely an exercise in mechanical assembly. It is a highly complex process of logistics that involves providing specific functional requirements within architectural and economic constraints. Careful engineering and balancing of the alternatives available will generally achieve optimum results.

A large number of variables is encountered in every A-V design problem. As an example, the dimensions of the presentation room have a significant effect on the audience size, the acoustic characteristics, the size of the projected image, the choice of equipment, and the location and the interrelationship of the components.

The A-V consultant who is responsible for the program planning, the design, and the engineering of this complex, multifaceted discipline should be intimately familiar with the problems of fabrication, installation, and operation of such systems. This knowledge will enable the consultant to plan a facility whose execution will not create difficulties and whose construction and operation can be effected without costly changes. However, even when the consultant has experience as an adviser to members of the architectural and engineering professions, the creation of a well-integrated facility is not necessarily assured. His or her work and the completed facilities should be viewed and evaluated.

## Optical Aspects

It is of critical importance for an A-V system to have the ability to display bright, sharp images to all viewers and to maintain the stability and consistency of those images in a simple and straightforward manner. The picture quality is a function of a number of factors requiring careful attention during all phases of the project. These include:

- The quality of the original photography or artwork
- The density, contrast, and sharpness of the actual material being projected
- The output intensity of the projector light source
- The optical characteristics of each projection unit
- The optical characteristics of the integrated system
- The ratio of the projection distance to the image size
- The centering integrity of the light path from the material being projected to its image on the screen
- The characteristics of the projection screen or other viewing surface

## Projection Engineering

**Room size** Ideally, the dimensions of the viewing room should be an outgrowth of the estimate of the audience size that was established in the original A-V study. In many cases, however, the A-V design engineer must utilize a predetermined space. Given the characteristics of that space, the designer can determine the ideal audience size for each type of seating arrangement, and also ascertain whether a front or rear projection mode is feasible and what the image size should be.

The type of relationship that is desired between the person making the presentation and the audience will determine the seating configuration: theatre, lecture, or conference format. That configuration will in turn dictate the number of viewers that can be comfortably seated for optimum viewing (Fig. 1).

As an illustration, a room 20 feet by 32 feet can accommodate about 49 people in a theatre configuration (Fig. 2); in a lecture arrangement, the audience size would be 24 (Fig. 3); a U-shaped table would seat 18 (Fig. 4); and 15 people could fit comfortably at a conference table (Fig. 5). Circular and multiple arrangements (Figs. 6 and 7) are additional examples of the relationship of seating configuration and audience size.

Other seating configurations have been devised for other types of communication program modes, each with a direct rela-

tionship between room size and audience size. The audience size is also affected by the angle of view between each member of the audience and the screen (Fig. 1).

Whenever the A-V design engineer has the opportunity of establishing the dimensions of the presentation room, he or she should be aware of the important fact that a longer projection throw for a particular image size results in more even light distribution and sharpness as well as a better angle of view. Consequently a larger audience can be accommodated than would be possible using a system with a short projection distance and a narrower angle of view. This question of projection distance applies to both front and rear projection systems. However, as the throw is normally quite short when a rear projection screen is used, this factor of design in rear projection facilities is an extremely critical planning element.

Distortion, sometimes called "keystoning," will result if the viewing surface is not precisely parallel to the plane of the image being projected. Therefore, the light path, which is usually perpendicular to the projected material, must be carefully controlled in relation to the projector and the screen. The size of the audience and the room, as well as the mode of projection, will determine whether the screen will be vertical or at an angle (Fig. 8). Normally, a rear projection screen will permit a vertical viewing surface.

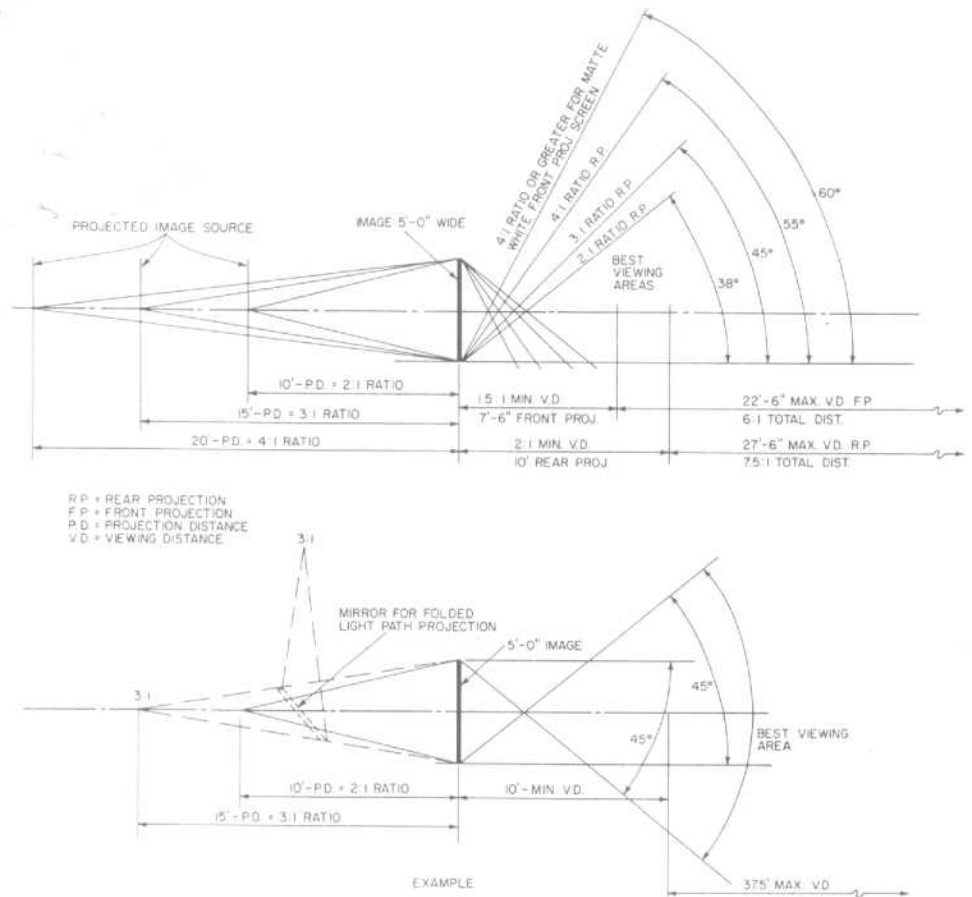


Fig. 1 The interrelationship of projection distance, image size, and viewing area.

## AUDIO-VISUAL SYSTEMS

## Typical Projection Room Layout and Sightlines

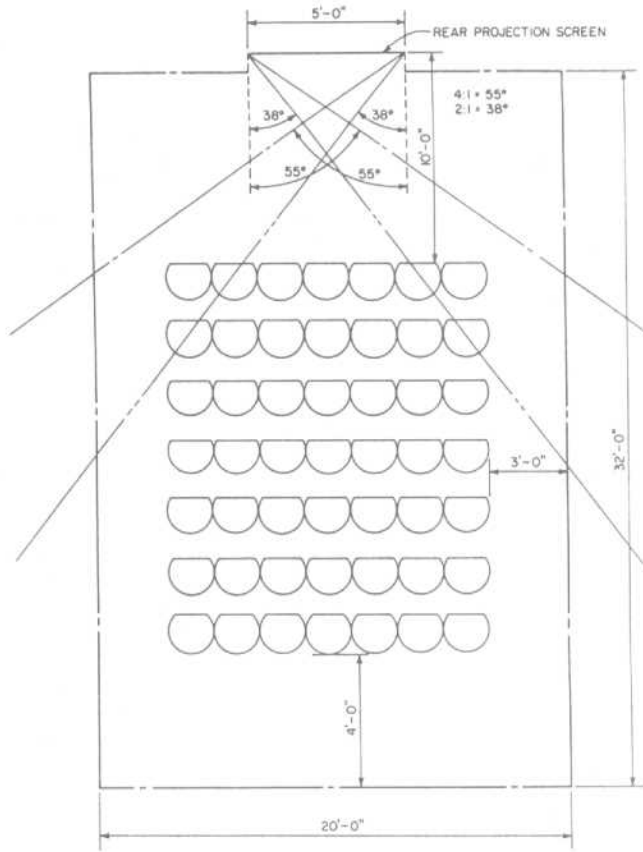


Fig. 2 A room 20 feet by 32 feet, seating 49 people in theatre style.

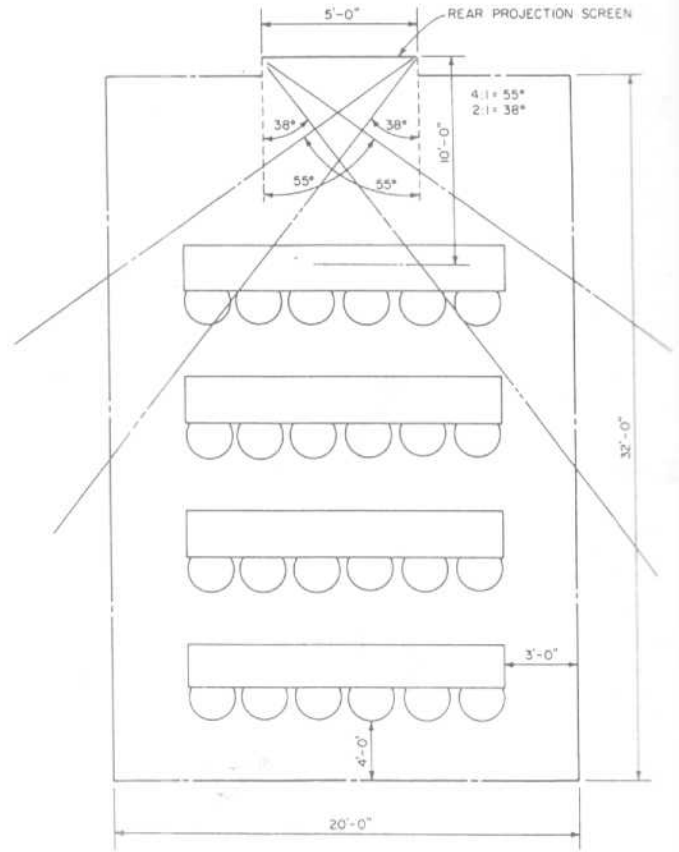


Fig. 3 A room 20 feet by 32 feet, seating 24 people in lecture style.

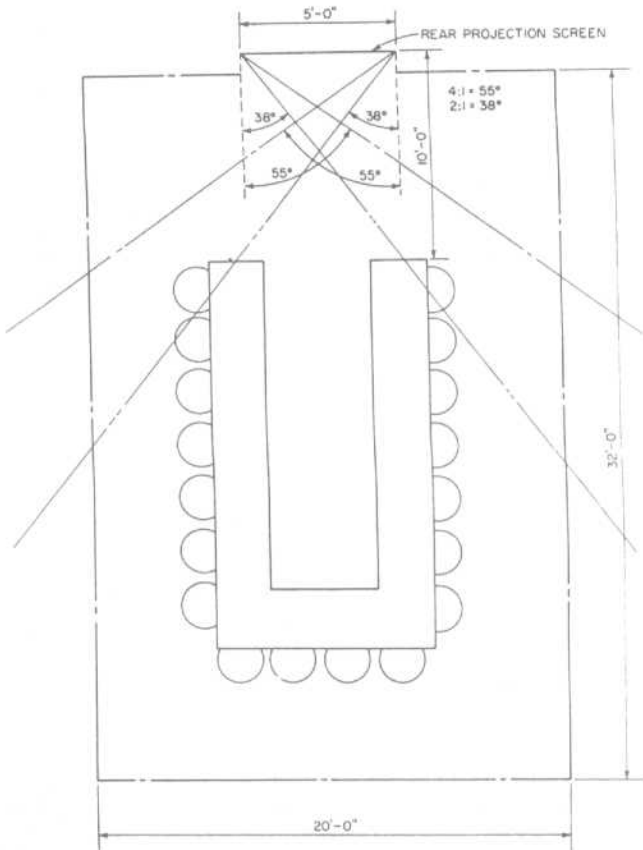


Fig. 4 A room 20 feet by 32 feet, seating 18 people at a U-shaped table.

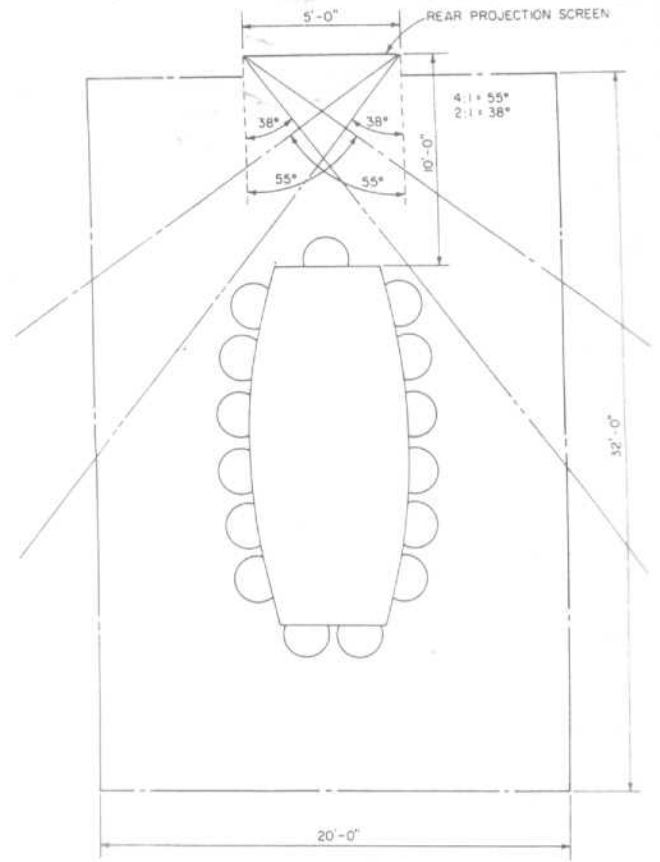


Fig. 5 A room 20 feet by 32 feet, seating 15 people at a boat-shaped conference table.

## AUDIO-VISUAL SYSTEMS

### Typical Projection Room Layout and Sightlines

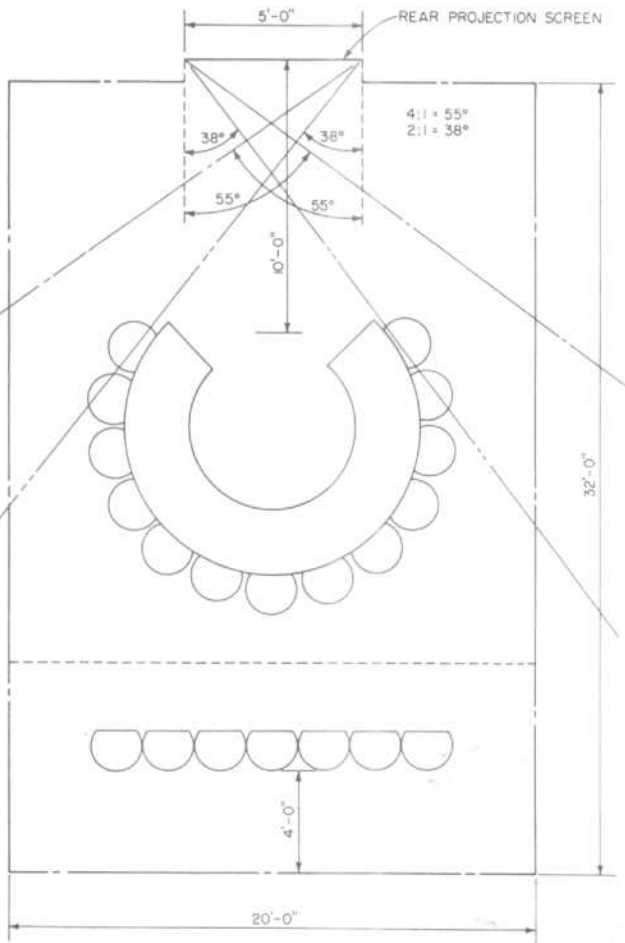


Fig. 6 A room 20 feet by 24 feet, seating 13 people at a circular table. With the depth increased to 32 feet, from 7 to 14 observers can also be accommodated.

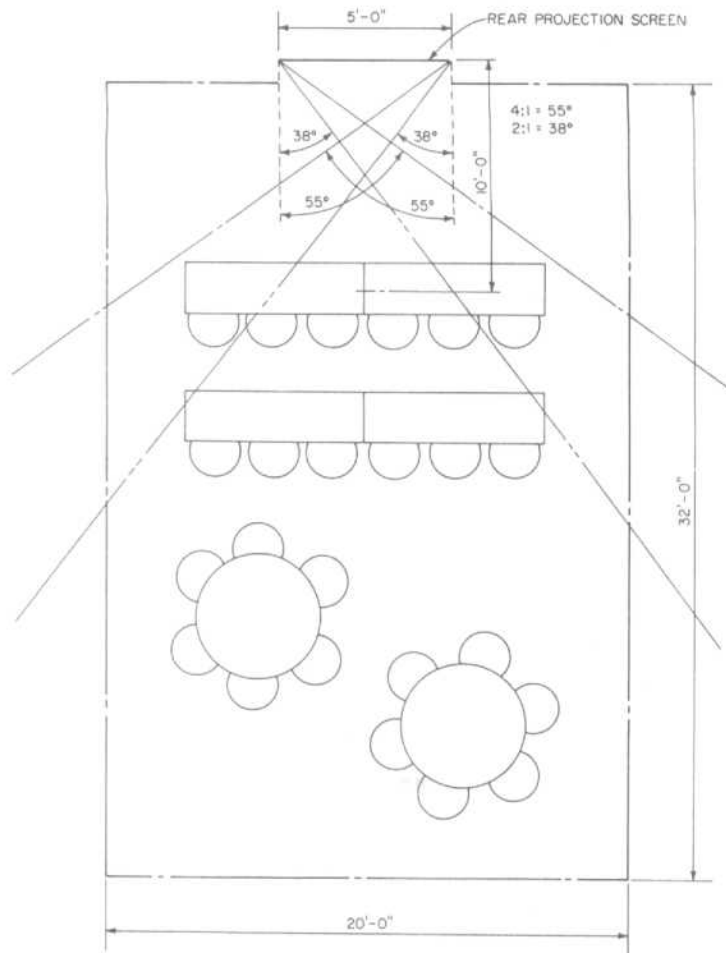


Fig. 7 A modified classroom arrangement including both lecture and separate tables.

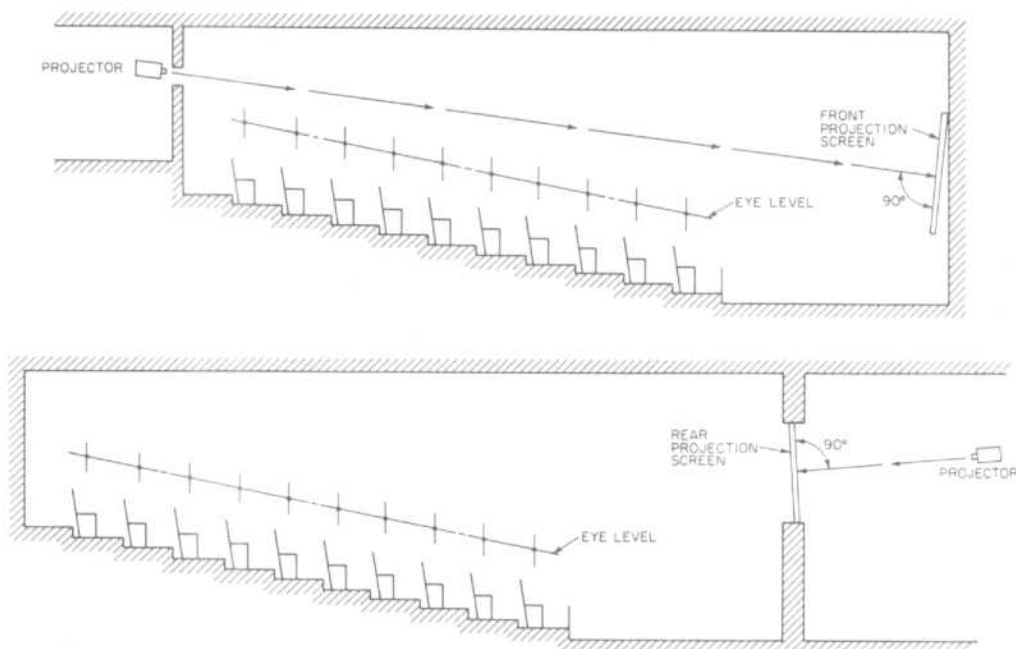


Fig. 8 Cross section of a theatre-style auditorium with stepped seating showing both front and rear projection. Note that the projected light beam is perpendicular to the screen in both cases.

## AUDIO-VISUAL SYSTEMS

## Planning Guideline Summary

**Screen image area** The most useful screen is one that is square, as it will permit both vertical and horizontal images, as well as square ones, of course (Fig. 9). A single image format will need one such screen, while a dual format will have a viewing surface that is the width of two images placed side by side (Figs. 9 and 10).

It is an easy matter to determine the minimum image size necessary for a room of a given size. For a front projection screen the minimum size is the distance between it and the farthest viewer divided by 6. For a rear projection screen, the division factor is 7.5. As illustration: When the distance between the front projection screen and the last row of viewers, is 45 feet, the minimum image size would be 7.5 feet; with a rear projection screen, the minimum image should be 6 feet. These calculations assume that the original artwork from which the projection materials are made meets the generally accepted basic minimum standards.

**Front projection** The projector in a front projection system transmits the image in the form of a light beam to an opaque screen where it is reflected back to the viewers, creating the image. As the screen reflects any light falling on its surface, the general light level in the room during a presentation must be extremely low. If the full color and contrast of the projected image is to be retained, the ambient light should be no greater than 0.3 percent of the average screen brightness.

Projectors are generally noisy and should be separated from the audience to avoid distractions. If the space is available, a separate projection booth can be built behind the room's rear wall. Besides insulating the viewers from unwanted sound and light spill, this arrangement provides the opportunity for equipment to remain in place ready for use. There are other possible arrangements when space is constricted (Figs. 11, 12, and 13).

Creating an A-V front projection system that is both aesthetically pleasing and functionally efficient requires a high level of technical expertise and design skill. The results of such a combination can be effective yet unobtrusive. Fig. 16 provides an example of a multimedia front projection system that is compatible with the decor of the room and its formalized seating arrangement.

**Rear projection** The image in a rear projection system is focused on the back of a translucent screen and is visible to the audience on the other side. Since the light passes through the screen rather than being reflected off its front surface, there can be a reasonable light level in the viewing room during the presentation without affecting the quality of the image. It is only in the immediate vicinity of the screen that the room lights need be dimmed.

As is the case with all projection systems, for minimum distractions the equipment should be separated from the audience. This can be effected by means of a separate projection booth or by an enclosed cabinet within the viewing room. A separate room usually requires more space, but it may be the best solution for a particular situation. A cabinet within the viewing room permits front access to the projectors, enabling the

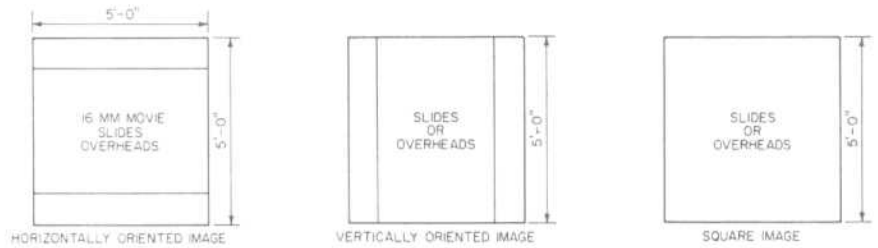


Fig. 9 A square screen will permit horizontal, vertical, and square images to be shown.

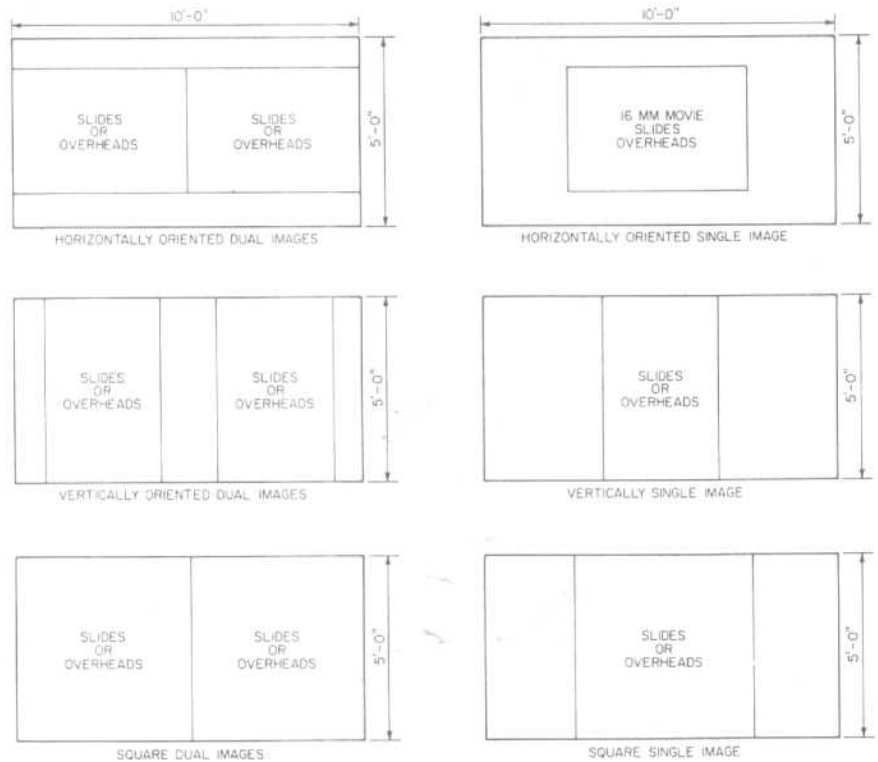


Fig. 10 A dual-image format uses a screen that is a double square — giving the same flexibility of image shape for each of the two images or for a single central image.

presenter to load the equipment without assistance.

While technical expertise and design skill are needed for the creation of a front projection A-V system, they are even more important for a system intended for rear projection, as a rear-mode arrangement has more inherent problems to overcome.

A rear projection system utilizing the indirect deep method in a separate projection booth requires a considerable amount of space. In addition, if more than one projector is used in such a system, either the projectors must be optically aligned each time a change is made (as there is only one true screen axis), or they are permanently positioned a little off axis, resulting in a slight "keystone" or distortion effect in the projected image (Fig. 17).

For good image clarity, the distance between the image source and the screen must be at least twice the picture size. To achieve

this clarity within a limited amount of space, the folded light-path method can be used (Figs. 18 and 19). As the name implies, the light path from the projector is "folded" by means of a large mirror, usually placed some distance away. This arrangement has the advantage of reducing the depth required behind the screen while retaining an adequate projection distance. As a further advantage, several projectors can be aligned in optically true positions by the use of a movable mirror with preset position stops.

The use of the folded light-path method of projection and a movable mirror can also be engineered in a cabinet that is directly accessible from the presentation room for "hands-on" operation by the person making the presentation. Both single-image and side-by-side dual-image systems can be designed in this manner (Figs. 20 and 21).

A great number of variations are possible using the same basic engineering concepts.

These variations can accommodate different functional requirements, spatial limitations, and image-quality parameters. Figures 14, 15, 22, and 23 illustrate some of the possible arrangements. User requirements and job conditions will guide the A-V engineer in the design of a specific system.

### The Optical Design Factor

A projection system — of whatever nature — is only as good as the quality of the image on the screen. The clarity, sharpness, resolution, and angle of view that can be expected are a direct result of the thought and care that go into the optical design of the system. The more complex the system becomes, the more critical is the system optics. The need for larger images, sharper images, multiple images, multiple image sources and the existence of physically constraining parameters all add to the conflicting requirements that must be satisfied. And they must be satisfied if an acceptable image quality is to be achieved.

### The Sound System

The quality and the functional characteristics of the sound system that is part of an audiovisual facility are as important as the quality and functional characteristics of the optical system. The two aspects of a facility are mutually complementary and the one should not be neglected in relation to the other if the goal of an effective and useful facility is to be attained.

The quality of the sound, as perceived by the listener, will be influenced by such factors as:

- The sensitivity of controls
- The quality of the amplifiers
- The quality of the speakers
- The location of the speakers
- The elimination of extraneous sounds
- The overall acoustical characteristics of the space

The design factors that govern the functional characteristics of the sound system might include the following:

- Sound sources:* voice, movie soundtrack, videotape, audiotape
- Telecommunication facilities for outside program sources
- Mixing and control requirements
- Quantity and placement of speakers
- Room size and function:* conference room, classroom, auditorium
- Provision for flexibility and future expansion

### The Remote-Control System

Most people who make informational presentations are not audiovisual specialists. Their primary concern is with the material they are presenting and not with the mechanics of how it is to be presented. As a result, any control devices they may be required to operate should be simple and logical. The presenter should be asked to make only a minimum of effort to determine how to manipulate the controls in order to achieve a desired result. The fewer operations necessary to reach a particular goal, the better. For example, in order for a change to be made from one presentation mode to another, it may be necessary to alter the ambient room lighting, reposition a mirror, turn one machine

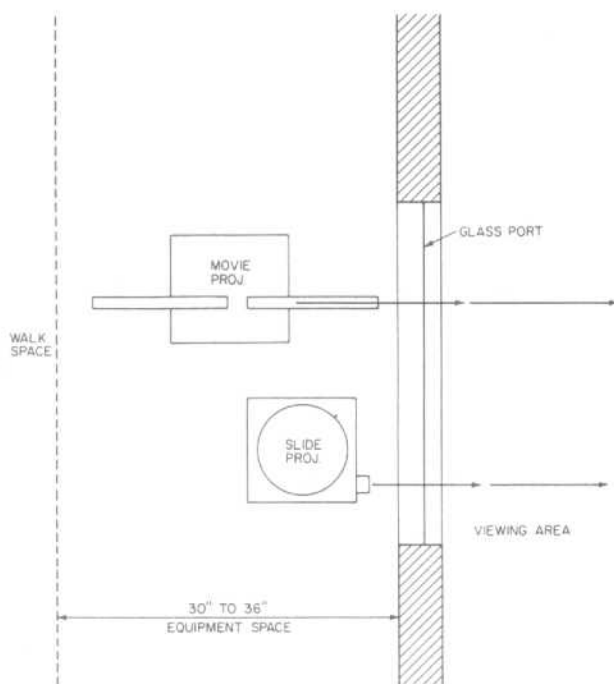


Fig. 11 A typical rear-access equipment arrangement for front projection.

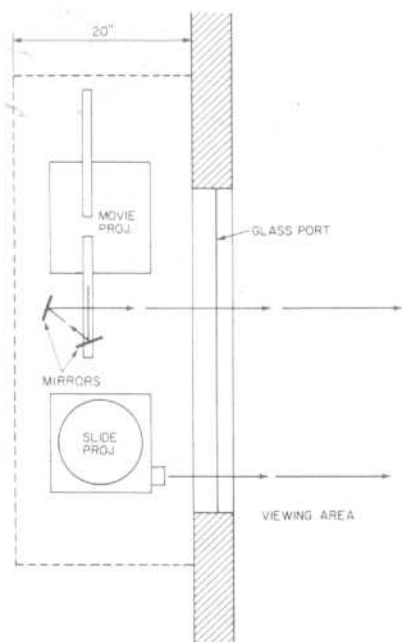


Fig. 12 A rear-access reduced-depth arrangement of equipment for front projection.

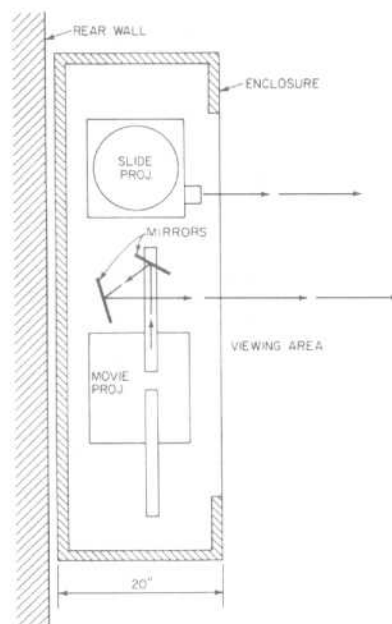
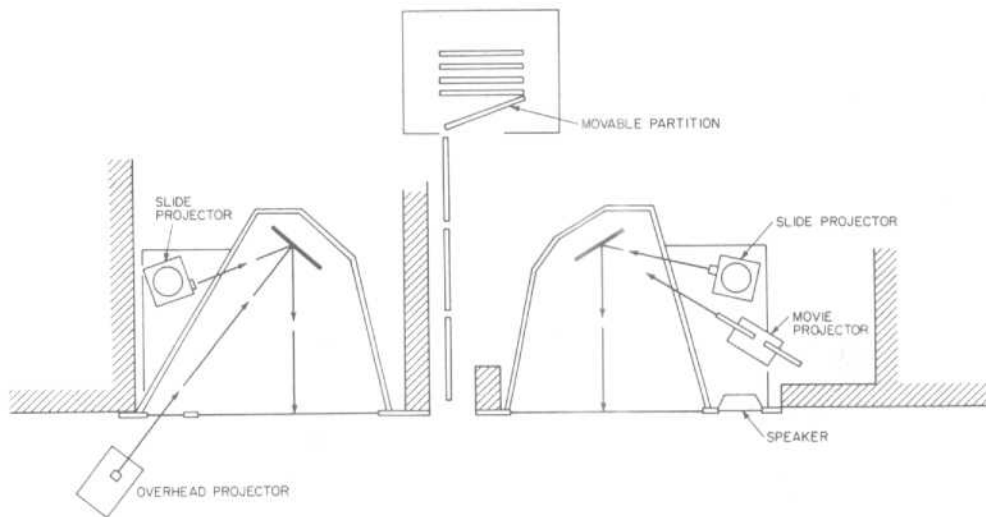


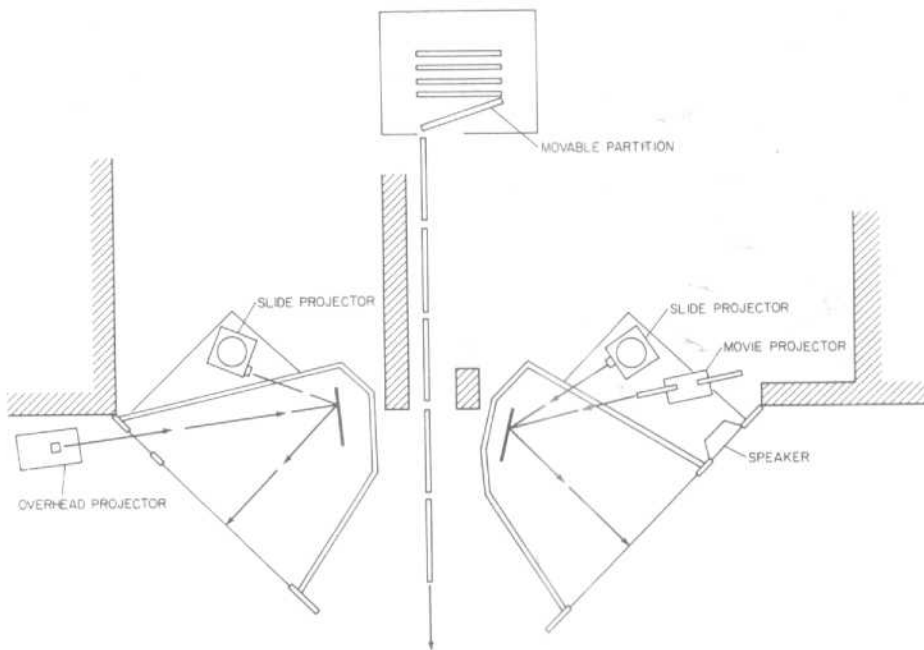
Fig. 13 A front-access equipment cabinet for front projection.

**AUDIO-VISUAL SYSTEMS**

Equipment Arrangement



**Fig. 14** An arrangement of two enclosed rear projection systems serving a single large room.



**Fig. 15** The two enclosed and pivoted rear projection systems positioned to serve the two separate rooms that are created when a hidden dividing partition is extended.

off and then another on. If all these things can be accomplished merely by flipping one clearly marked switch, the presenter is freed from mechanical distractions and can concentrate full attention on the message being delivered. The location and spacing of the various switches on the panel, as well as the use of nomenclature unmistakable to a non-technical person, are important parts of the design of a remote-control system that will aid the presenter in the use of the audiovisual facility.

Other considerations that may affect the design of a remote-control system include:

- The seating configuration
- The room lighting
- The number of control points required
- The use of a lectern incorporating a control module
- The number and type of functions to be controlled
- The degree of automation required to meet system objectives

## SUMMARY

An audiovisual presentation facility is made up of many components and subsystems which are interdependent and must perform as an integrated unit. Regardless of its size or scope, the A-V system must be conceived, designed, and installed to function as a totality – as a single entity that works with optimum efficiency and effectiveness in an unobtrusive manner.

In order to achieve this goal – that of developing a logical and workable solution to any particular communication problem – careful and detailed preliminary investigations must be made. These will determine the functional requirements that make up the design program. From this program, the space needs for the equipment and for the audience can be established early enough in the development of the project to avoid undesirable procrustean solutions later. The selection, adaptation, manufacture, assembly, and installation of equipment and components should be carefully coordinated to ensure their functional integrity and performance.

Ultimately, a successful audiovisual system is one that serves as a logical and natural extension of the human capabilities of the person using it. It should respond easily and unobtrusively to the communicator's needs, and it should reproduce the material being communicated with the highest possible degree of fidelity.

## RECAP

### Front Projection

1. Viewing distance factor is 6. (For example, if image size is 5 feet the alphanumerics

would be clear at a maximum distance of 30 feet to a viewer with a 20/40 vision if characters are  $\frac{3}{16}$  inch on 6- by 9-inch original copy area.)

### 2. Advantages

- a. Good angle of view
- b. Good for checking laboratory quality of all projectuals
- c. Virtually no apparent falloff to the sides

### 3. Disadvantages

- a. High ceilings are required to utilize a square screen to accommodate vertical as well as horizontal images.
- b. Distraction occurs when the presenter or viewers interrupt the light beam.
- c. Any ambient light adversely affects image quality. The room must be relatively dark to achieve the desired picture contrast.
- d. An overhead projector cannot be used most effectively.

### Rear Projection (Rigid or Flexible Material)

1. Viewing distance factor is 7.5. (For example, if image size is 5 feet the maximum viewing distance would be 37.5 feet.)

### 2. Advantages

- a. A 20 percent smaller image than is required by front projection permits minimum standards to be met in low-ceilinged rooms.
- b. Can be used in higher ambient light conditions.
- c. No distracting light beam. (Presenter can more comfortably point at details).
- d. In a brighter room, the presenter easily maintains eye contact.
- e. An overhead projector can be used, so that neither it nor the presenter blocks the image from the viewers.

### 3. Disadvantages

- a. The inherent grain and directional quality of the rear screen eliminate it as a viewing medium to determine laboratory quality of projectuals.
- b. The projection system must be designed to overcome apparent illumination falloff at the sides and improve the angle of view.
- c. Mirrored image is required for proper use.
- d. More space is required than with front projection.
- e. Usually costs more.

### Seating

(Plan should permit several arrangements.)

1. A U- or V-table layout provides for best

viewing and viewer/presenter interaction (lowest audience capacity).

2. Conference table (boat-shape or oval) provides good interaction for conferences but not so good as the U- or V-table layout for audiovisual communication.

3. Random seating style (usually with writing tablets) is frequently selected for high-level visitor presentations. It permits larger capacity and creates a more luxurious atmosphere than the two arrangements above.

4. Classroom style (shallow tables parallel to front wall with chairs behind) is the next best method but less conducive to student interaction.

- a. Stepped, curved seating (lecture hall) provides unobstructed viewing.
- b. When classroom style is contemplated, study and programmed-learning carrels should be considered.

5. Auditorium style provides the largest capacity seating and is generally used for large group-orientation and overview types of presentation.

### Rear Projection System Factors

1. The physical center of all projector lenses must be in perfect alignment with the physical center of the screen to eliminate any "keystone" effect. (For dissolve mode, 2° off center vertically is permitted.)

2. A front-surface mirror should be used to reverse the image so the equipment can be loaded much as it is for front projection; slides in magazines need not be reversed, and special reversed prints are not needed for motion pictures. The use of a mirror can also extend the projection distance appreciably by folding the light path. Remember, the longer the projection distance, the better the viewing angle. Minimum projection distance should be at least 2 times the image size.

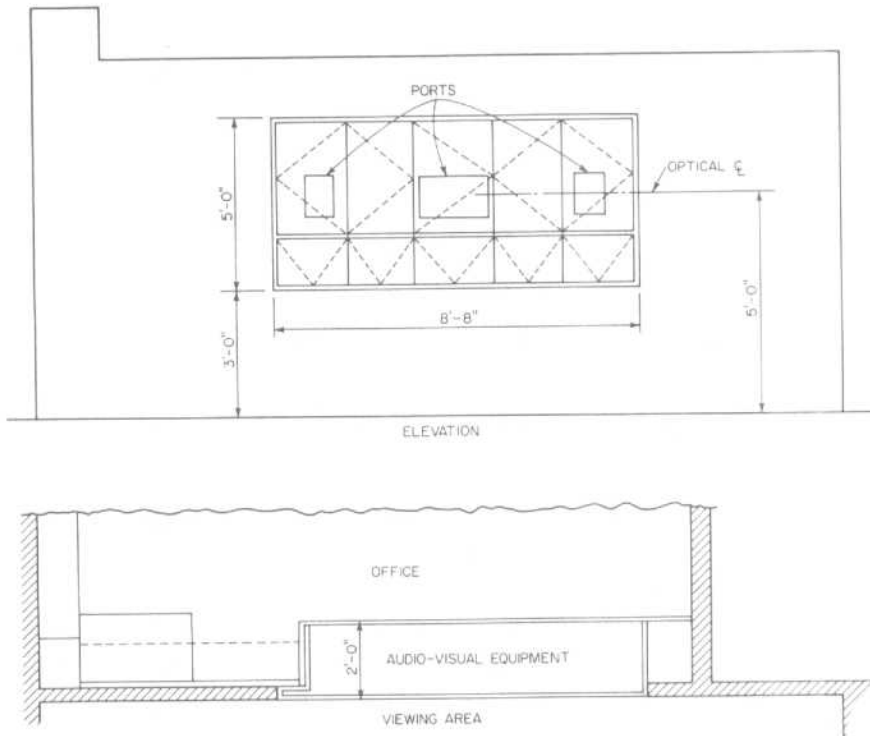
3. The screen-image area should be considered to be square to accommodate vertical and horizontal images unless the system is to be used for a special, limited requirement.

4. Apparent light falloff at the sides can be diminished or eliminated by increasing the projection distance and projector illumination. Another minor contributor is slide density. A dense or underexposed slide reduces the amount of light transmission. This condition increases apparent light falloff.

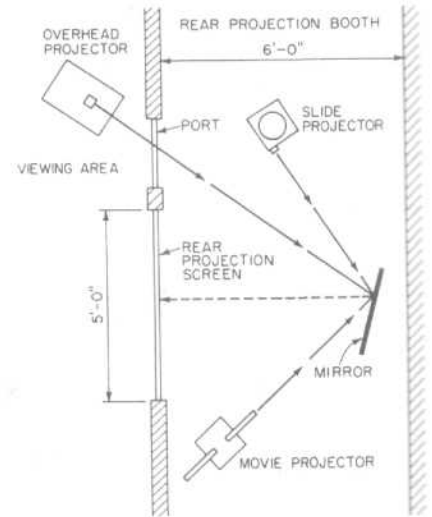


**AUDIO-VISUAL SYSTEMS**

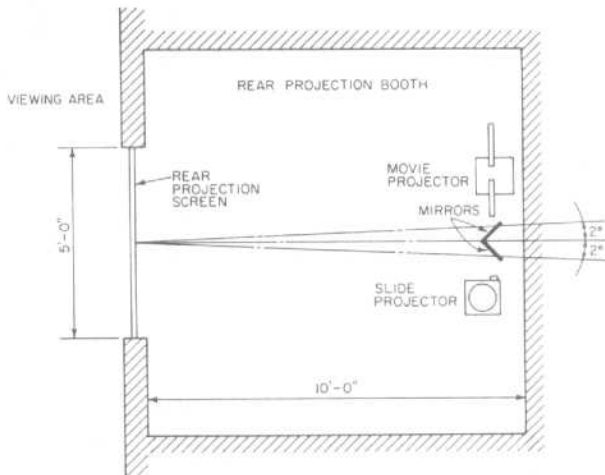
Equipment Arrangement



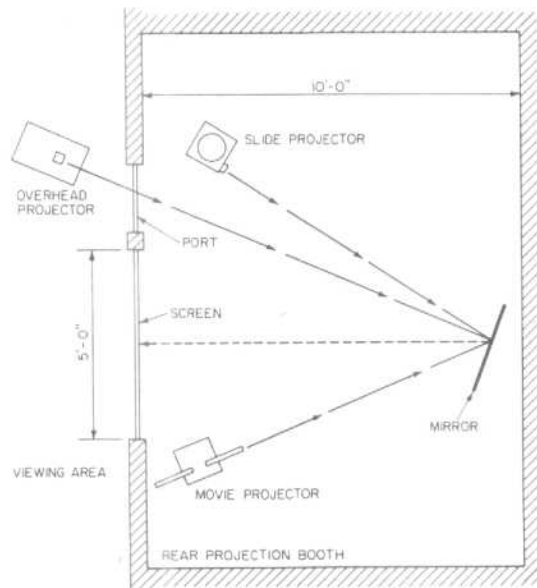
**Fig. 16** A custom-designed recessed front-access equipment cabinet for a multi-image front projection system.



**Fig. 19** An indirect rear projection arrangement using the folded-light-path method and the minimum recommended 2 to 1 ratio of projection distance to image size. This permits a flexible equipment arrangement within tight space limitations.



**Fig. 17** A deep, indirect-method, rear projection arrangement using the minimum recommended ratio of 2 to 1 between projection distance and image size.



**Fig. 18** An indirect rear projection arrangement using the folded-light-path method, resulting in a ratio of 3.5 to 1 within the same depth. This improves the image quality and increases the possible viewing angle as well as allowing rear projection of overhead transparencies with the overhead projector in the presentation room.



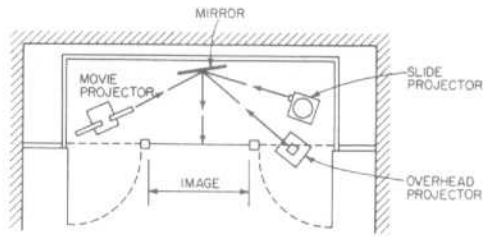


Fig. 20 A front-access rear projection arrangement using the folded-light-path method for single-image presentations.

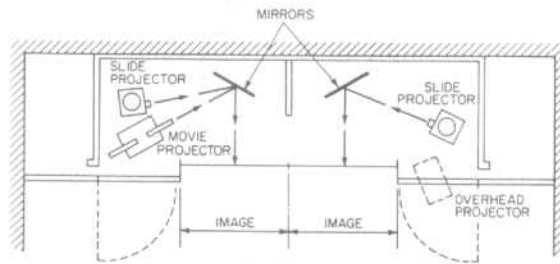


Fig. 21 A front-access rear projection arrangement using the folded-light-path method for dual-image presentations.

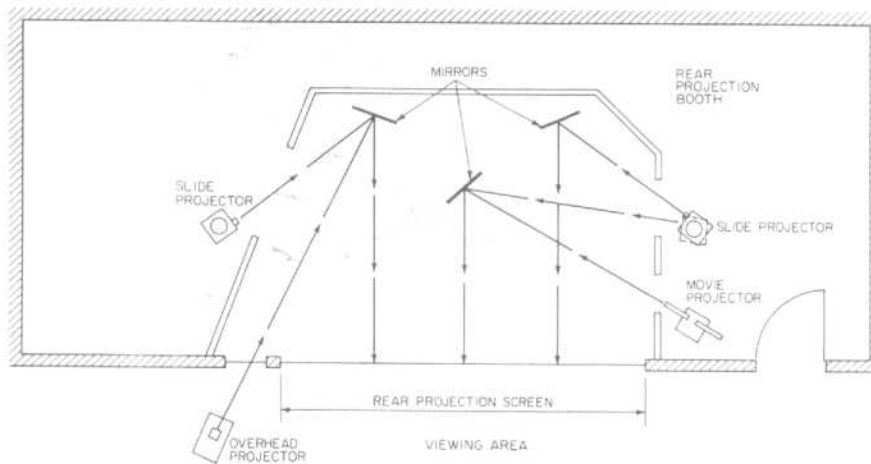


Fig. 22 A rear-access rear projection arrangement using the folded-light-path method for dual-image or single central-image presentations.

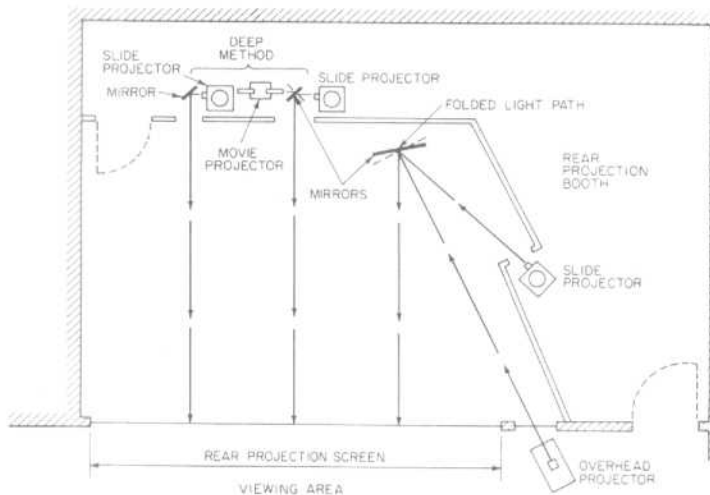
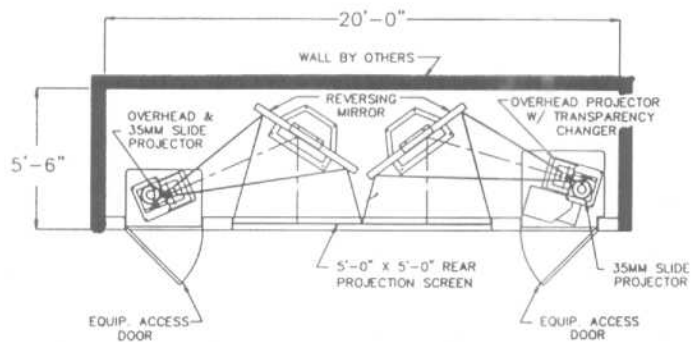
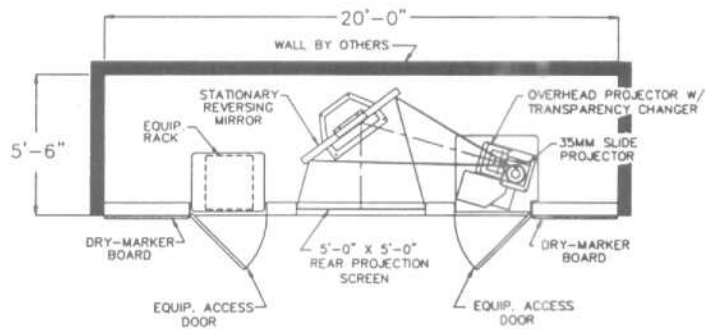
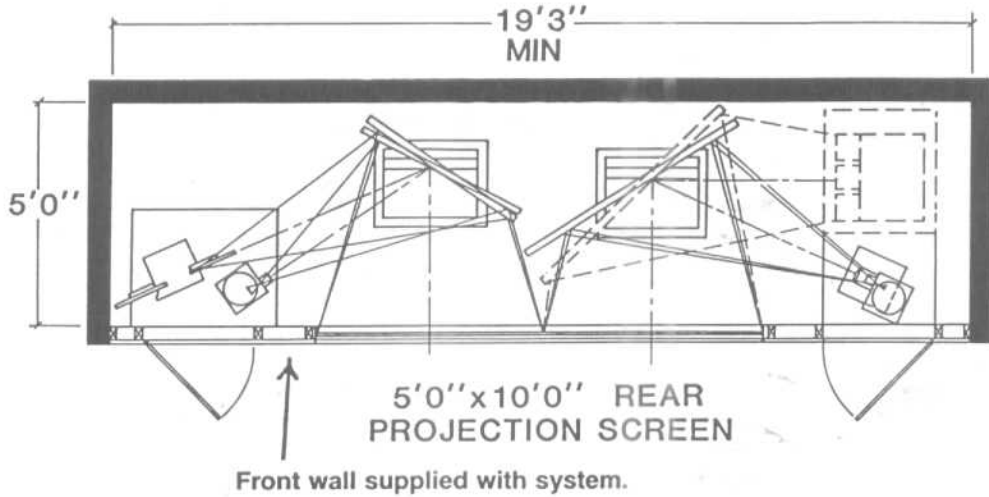
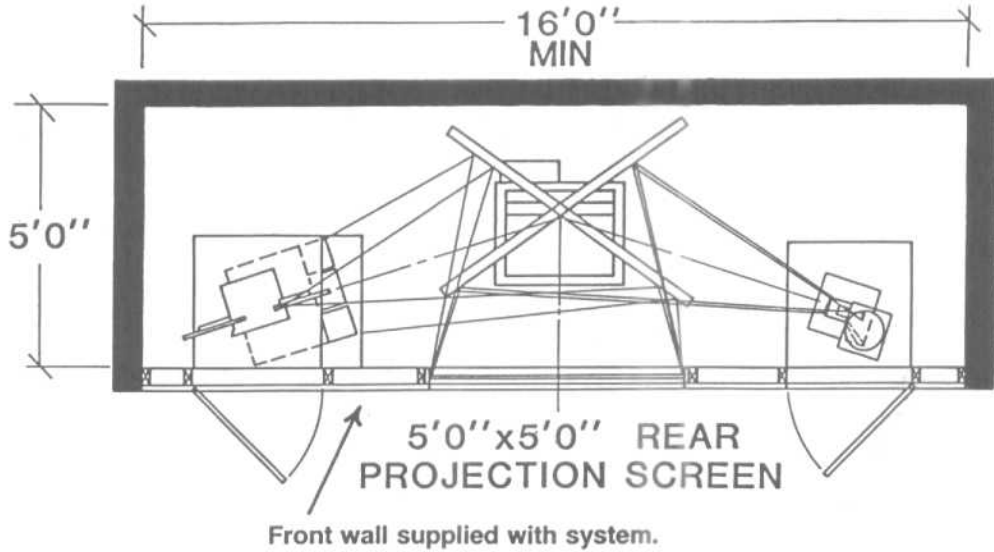
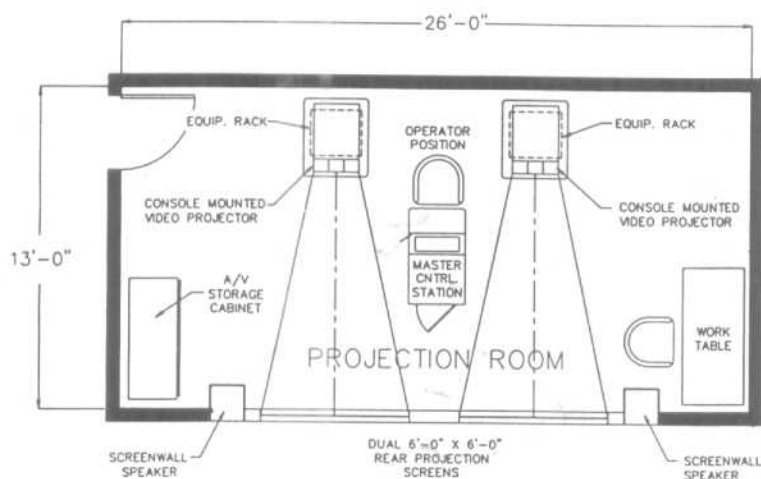
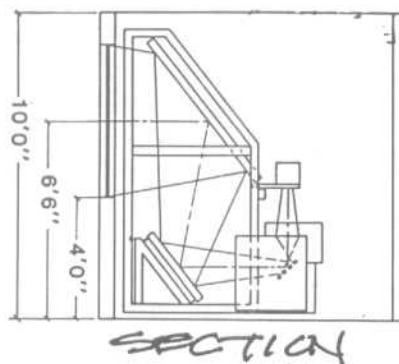
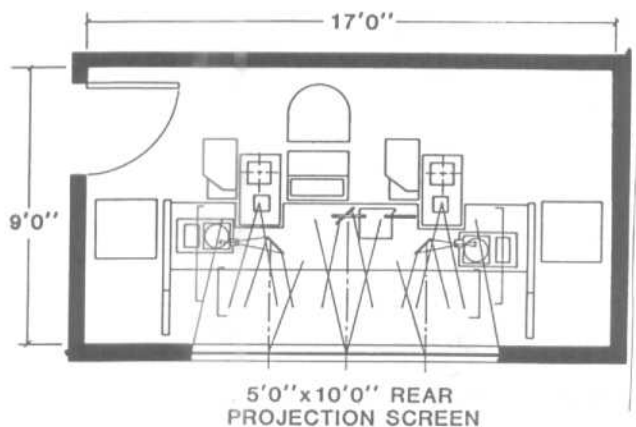


Fig. 23 A rear projection arrangement for dual-image and single central-image presentations utilizing both deep indirect projection and the folded-light-path method.

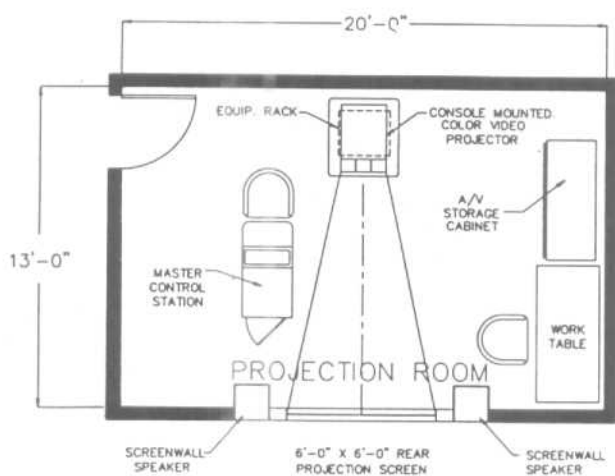
AUDIO-VISUAL SYSTEMS

Typical Projection Room Layout





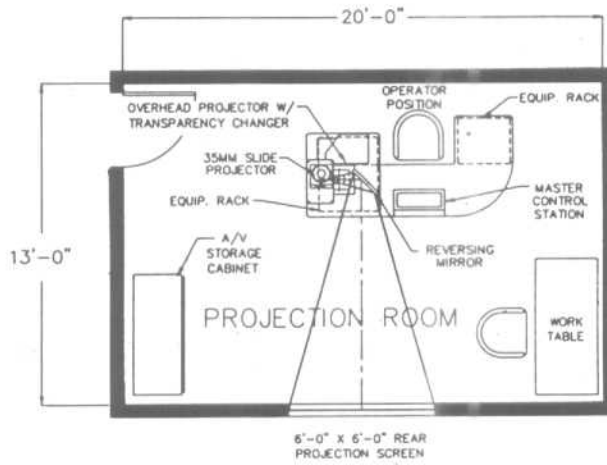
**TYPICAL CONFIGURATION**



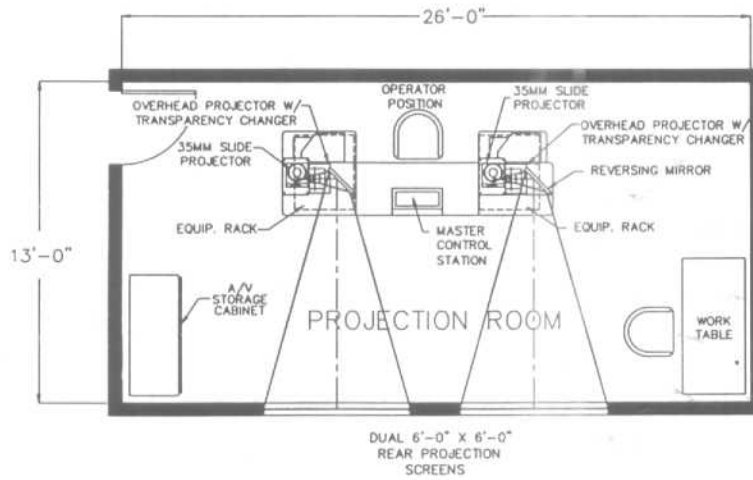
**TYPICAL CONFIGURATION**

AUDIO-VISUAL SYSTEMS

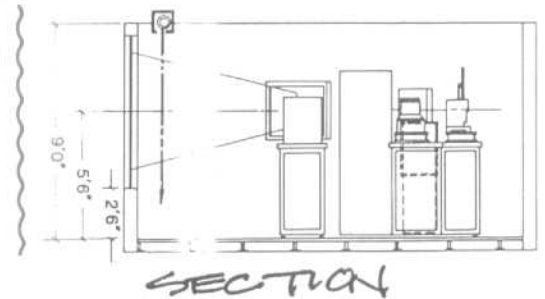
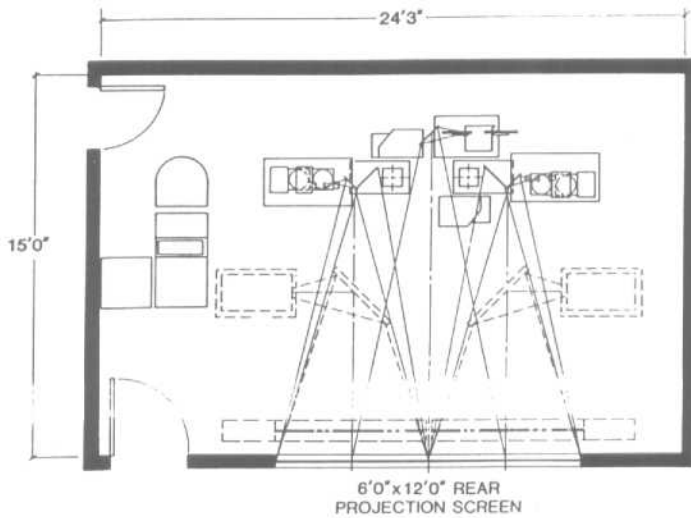
Typical Projection Room Layout



TYPICAL CONFIGURATION



TYPICAL CONFIGURATION



(AUDIENCE AREA)

## AUDITORIUM SEATING

Sightlines; Building Codes

Sight line studies vary depending on the particular event and seating configuration. The following are some basic design elements. (Note: Remember to review and verify slope, riser heights, tread depths, etc., with pertinent national and local code requirements.)

The visibility profile shown in Fig. 1:

**Angle A:** Shifting position to look between heads in row immediately in front of spectator and over all other heads.

**Angle B:** Shifting position to look between heads of two rows immediately in front of spectators and over all other heads.

Generally, the variables considered in determining these angles are:

- 3'8" eye level in the seated position
- 5" minimum eye clearance
- Row spacing and row rise

Angle A is commonly used in determining floor slope for auditorium, performing arts or theater type seating configurations. When angle A profile is used in conjunction with a staggered seating arrangement (chairs staggered or alternated in arrangement of sizes opposite every other row) it allows unobstructed view of spectators to a determined focal point at screen on stage. The final analysis is to have all sight lines to intersect the desired focal point (usually 5'6" elevation either at screen or 12'0" back from front of stage).

Angle B is most commonly used in determining riser or stepped applications for gymnasium, arena, or stadium type seating configurations. When the angle B profile is used (generally associated with an aligned seating arrangement) it allows unobstructed view of spectators to a determined focal point at court line or line of play at generally a 3'0" elevation.

Legal responsibility lies with the owners and users of equipment in acquiring acceptance with local officials. The following are some basic guidelines.

#### Standard Seating

1. Row spacing shall provide a clear space of not less than 12" (30.5 cm) from the back of one chair to the front of the most forward projection of the chair directly behind it when measured with the self-rising seat in the up position.

2. Rows of chairs shall not exceed 14 chairs between aisles and exceed seven chairs from an aisle to a row end.

3. Aisles serving 60 seats or less shall be a minimum of 30" (76 cm) wide. Aisles serving more than 60 seats shall be at least 3' (91 cm) wide when serving seats on one side and at least 3'6" (107 cm) wide when serving seats

on both sides. These minimum widths, measured at the point furthest from an exit, cross aisles, or foyer shall be increased 1½" (3.8 cm) for each 5' (152 cm) in length toward the exit, cross aisle, or foyer. Where egress is possible in either direction, aisles shall be uniform in width. Dead end aisles are not allowed over 20'0" (61.0 m) in length.

4. Cross aisles, foyer or exit widths shall be not less than the sum of the required width of the widest aisle plus 50% of the total required width of the remaining aisles that it serves.

#### Continental Seating

1. Row spacing shall provide a clear space of not less than: 18" (45.7 cm) between rows of 18 chairs or less; 20" (50.8 cm) between rows of 35 chairs or less; 21" (53.3 cm) between rows of 45 chairs or less; 22" (55.9 cm) between rows of 45 chairs or more to a maximum of 100 chairs per row, measured from the back of one chair to the front of the most forward projection of the chair directly behind it with the self-rising seat in the up position.

2. There shall be exits of 66" (168 cm) minimum clear width along each side aisle of the chair rows for each five rows of chairs.

3. Aisles shall not be less than 44" (112 cm) in clear width.

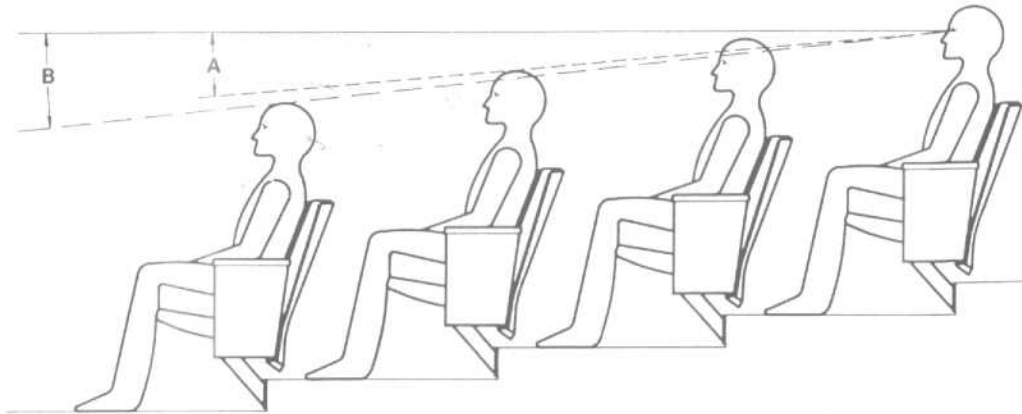
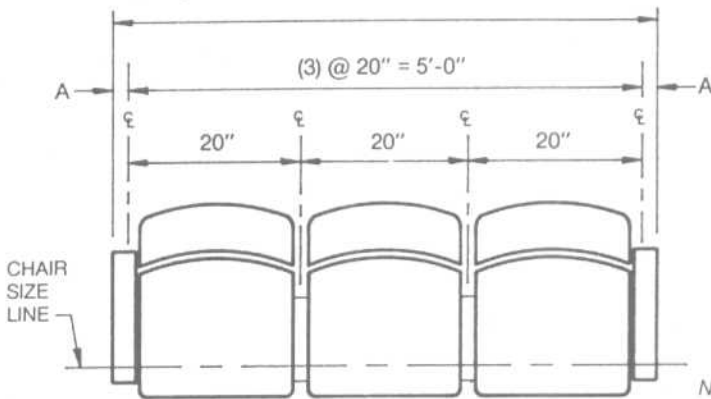


Fig. 1

## AUDITORIUM SEATING

## Row Length

Row length =  $\xi$  to  $\xi + (2A)$  measured at the Chair Size Line



Note: End dim. A varies 2" to 3" for end tablet arm applications.

## EXAMPLE:

(3) 20" chairs = 5'-4" row length.

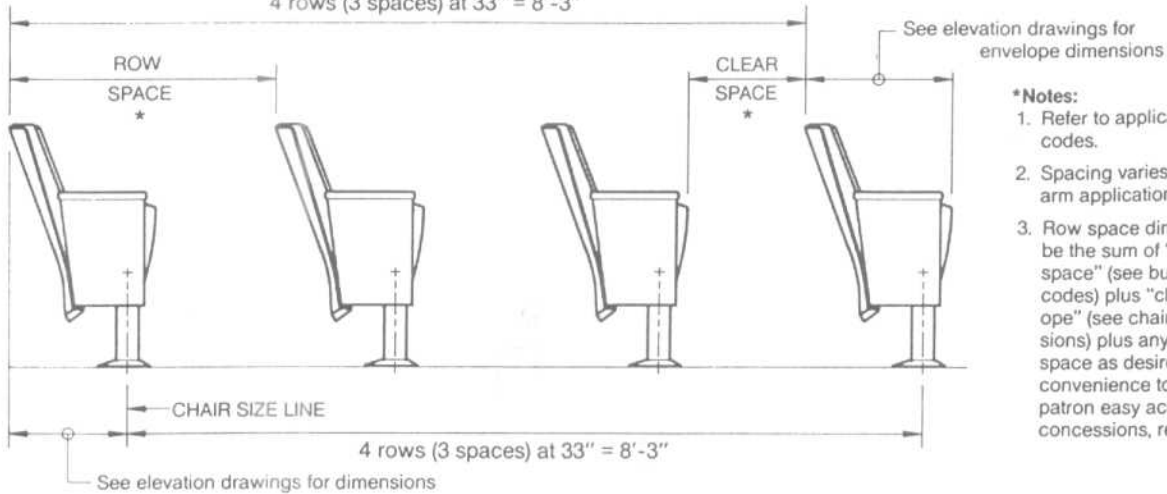
DIMENSIONS: Center line to center line ( $\xi$ to $\xi$ )											
QTY	SIZE					QTY	SIZE				
	18"	19"	20"	21"	22"		18"	19"	20"	21"	22"
2	3'-0"	3'-2"	3'-4"	3'-6"	3'-8"	32	48'-0"	50'-8"	53'-4"	56'-0"	58'-8"
3	4'-6"	4'-9"	5'-0"	5'-3"	5'-6"	33	49'-6"	52'-3"	55'-0"	57'-9"	60'-6"
4	6'-0"	6'-4"	6'-8"	7'-0"	7'-4"	34	51'-0"	53'-10"	56'-8"	59'-6"	62'-4"
5	7'-6"	7'-11"	8'-4"	8'-9"	9'-2"	35	52'-6"	55'-5"	58'-4"	61'-3"	64'-2"
6	9'-0"	9'-6"	10'-0"	10'-6"	11'-0"	36	54'-0"	57'-0"	60'-0"	63'-0"	66'-0"
7	10'-6"	11'-1"	11'-8"	12'-3"	12'-10"	37	55'-6"	58'-7"	61'-8"	64'-9"	67'-10"
8	12'-0"	12'-8"	13'-4"	14'-0"	14'-8"	38	57'-0"	60'-2"	63'-4"	66'-6"	69'-8"
9	13'-6"	14'-3"	15'-0"	15'-9"	16'-6"	39	58'-6"	61'-9"	65'-0"	68'-3"	71'-6"
10	15'-0"	15'-10"	16'-8"	17'-6"	18'-4"	40	60'-0"	63'-4"	66'-8"	70'-0"	73'-4"
11	16'-6"	17'-5"	18'-4"	19'-3"	20'-2"	41	61'-6"	64'-11"	68'-4"	71'-9"	75'-2"
12	18'-0"	19'-0"	20'-0"	21'-0"	22'-0"	42	63'-0"	66'-6"	70'-0"	73'-6"	77'-0"
13	19'-6"	20'-7"	21'-8"	22'-9"	23'-10"	43	64'-6"	68'-1"	71'-8"	75'-3"	78'-10"
14	21'-0"	22'-2"	23'-4"	24'-6"	25'-8"	44	66'-0"	69'-8"	73'-4"	77'-0"	80'-8"
15	22'-6"	23'-9"	25'-0"	26'-3"	27'-6"	45	67'-6"	71'-3"	75'-0"	78'-9"	82'-6"
16	24'-0"	25'-4"	26'-8"	28'-0"	29'-4"	46	69'-0"	72'-10"	76'-8"	80'-6"	84'-4"
17	25'-6"	26'-11"	28'-4"	29'-9"	31'-2"	47	70'-6"	74'-5"	78'-4"	82'-3"	86'-2"
18	27'-0"	28'-6"	30'-0"	31'-6"	33'-0"	48	72'-0"	76'-0"	80'-0"	84'-0"	88'-0"
19	28'-6"	30'-1"	31'-8"	33'-3"	34'-10"	49	73'-6"	77'-7"	81'-8"	85'-9"	89'-10"
20	30'-0"	31'-8"	33'-4"	35'-0"	36'-8"	50	75'-0"	79'-2"	83'-4"	87'-6"	91'-8"
21	31'-6"	33'-3"	35'-0"	36'-9"	38'-6"	51	76'-6"	80'-9"	85'-0"	89'-3"	93'-6"
22	33'-0"	34'-10"	36'-8"	38'-6"	40'-4"	52	78'-0"	82'-4"	86'-8"	91'-0"	95'-4"
23	34'-6"	36'-5"	38'-4"	40'-3"	42'-2"	53	79'-6"	83'-11"	88'-4"	92'-9"	97'-2"
24	36'-0"	38'-0"	40'-0"	42'-0"	44'-0"	54	81'-0"	85'-6"	90'-0"	94'-6"	99'-0"
25	37'-6"	39'-7"	41'-8"	43'-9"	45'-10"	55	82'-6"	87'-1"	91'-8"	96'-3"	100'-10"
26	39'-0"	41'-2"	43'-4"	45'-6"	47'-8"	56	84'-0"	88'-8"	93'-4"	98'-0"	102'-8"
27	40'-6"	42'-9"	45'-0"	47'-3"	48'-6"	57	85'-6"	90'-3"	95'-0"	99'-9"	104'-6"
28	42'-0"	44'-4"	46'-8"	49'-0"	51'-4"	58	87'-0"	91'-10"	96'-8"	101'-6"	106'-4"
29	43'-6"	45'-11"	48'-4"	50'-9"	53'-2"	59	88'-6"	93'-5"	98'-4"	103'-3"	108'-2"
30	45'-0"	47'-6"	50'-0"	52'-6"	55'-0"	60	90'-0"	95'-0"	100'-0"	105'-0"	110'-0"
31	46'-6"	49'-1"	51'-8"	54'-3"	56'-10"	---	---	---	---	---	---

## AUDITORIUM SEATING

## Row Spacing

## EXAMPLE:

4 rows (3 spaces) at 33" = 8'-3"



## \*Notes:

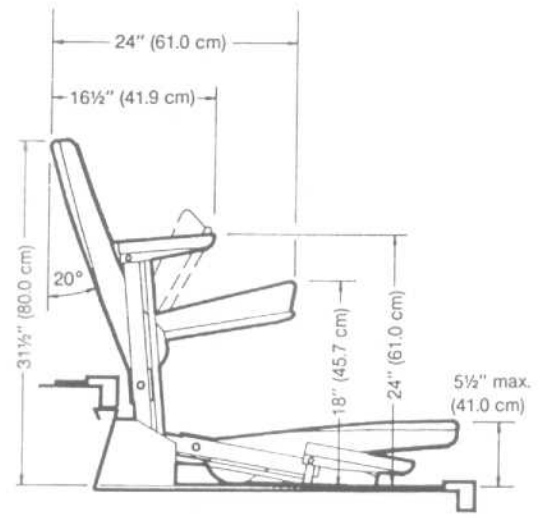
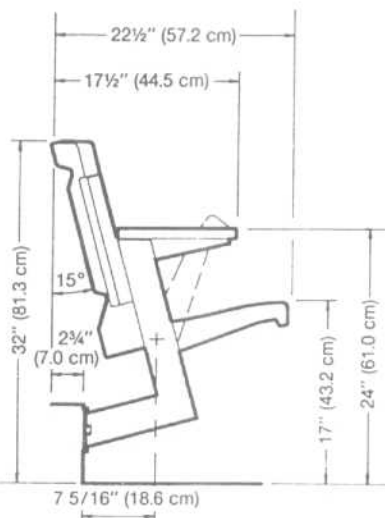
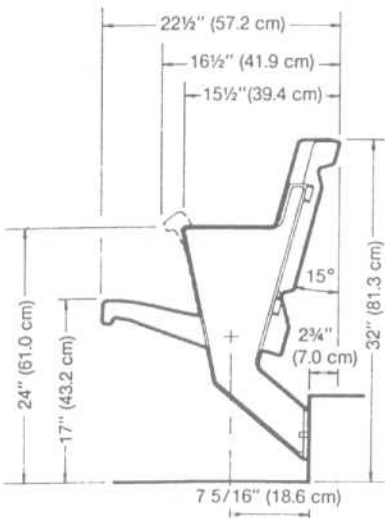
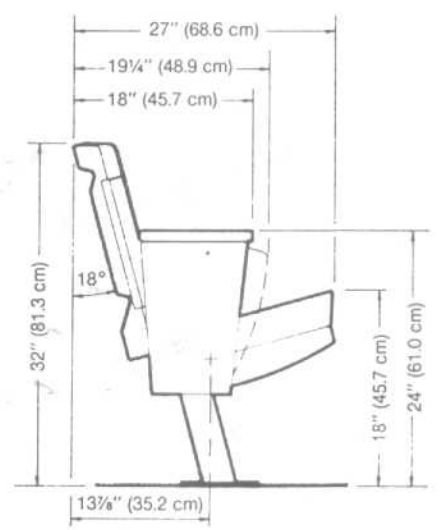
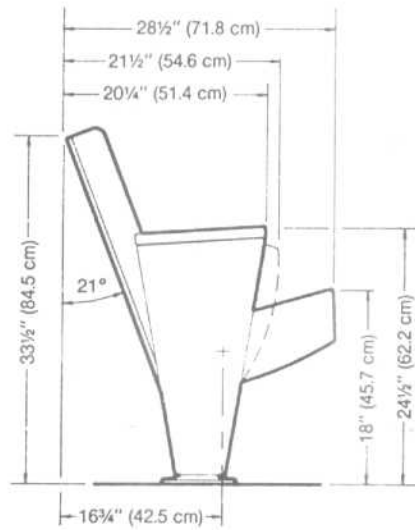
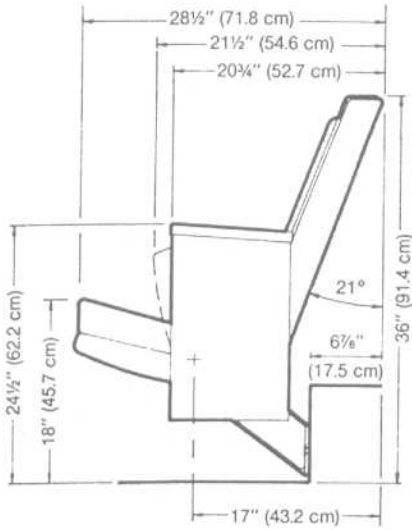
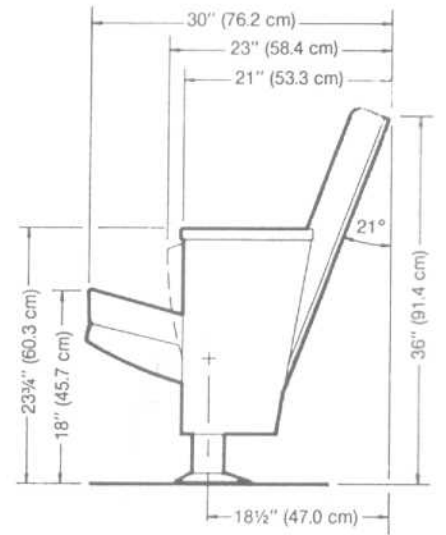
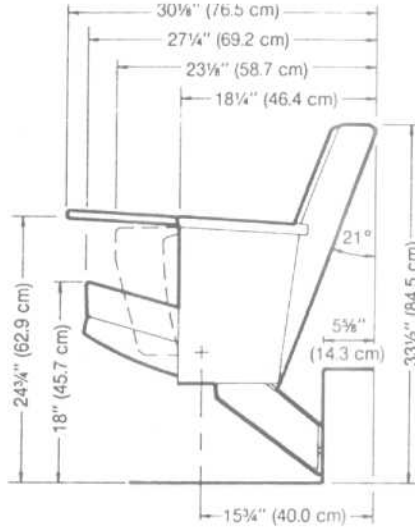
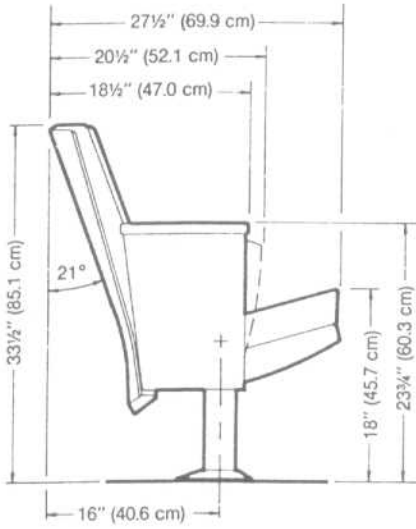
1. Refer to applicable building codes.
2. Spacing varies with tablet arm applications.
3. Row space dimension will be the sum of "clear space" (see building codes) plus "chair envelope" (see chair dimensions) plus any additional space as desired for convenience to permit patron easy access to concessions, restrooms, etc.

## OVERALL SPACING OF CHAIRS (back to back)

Number of seating rows (spaces + 1)	ROW SPACE DIMENSIONS										
	32"	33"	34"	35"	36"	37"	38"	39"	40"	41"	42"
2	2'-8"	2'-9"	2'-10"	2'-11"	3'-0"	3'-1"	3'-2"	3'-3"	3'-4"	3'-5"	3'-6"
3	5'-4"	5'-6"	5'-8"	5'-10"	6'-0"	6'-2"	6'-4"	6'-6"	6'-8"	6'-10"	7'-0"
4	8'-0"	8'-3"	8'-6"	8'-9"	9'-0"	9'-3"	9'-6"	9'-9"	10'-0"	10'-3"	10'-6"
5	10'-8"	11'-0"	11'-4"	11'-8"	12'-0"	12'-4"	12'-8"	13'-0"	13'-4"	13'-8"	14'-0"
6	13'-4"	13'-9"	14'-2"	14'-7"	15'-0"	15'-5"	15'-10"	16'-3"	16'-8"	17'-1"	17'-6"
7	16'-0"	16'-6"	17'-0"	17'-6"	18'-0"	18'-6"	19'-0"	19'-6"	20'-0"	20'-6"	21'-0"
8	18'-8"	19'-3"	19'-10"	20'-5"	21'-0"	21'-7"	22'-2"	22'-9"	23'-4"	23'-11"	24'-6"
9	21'-4"	22'-0"	22'-8"	23'-4"	24'-0"	24'-8"	25'-4"	26'-0"	26'-8"	27'-4"	28'-0"
10	24'-0"	24'-9"	25'-6"	26'-3"	27'-0"	27'-9"	28'-6"	29'-3"	30'-0"	30'-9"	31'-6"
11	26'-8"	27'-6"	28'-4"	29'-2"	30'-0"	30'-10"	31'-8"	32'-6"	33'-4"	34'-2"	35'-0"
12	29'-4"	30'-3"	31'-2"	32'-1"	33'-0"	33'-11"	34'-10"	35'-9"	36'-8"	37'-7"	38'-6"
13	32'-0"	33'-0"	34'-0"	35'-0"	36'-0"	37'-0"	38'-0"	39'-0"	40'-0"	41'-0"	42'-0"
14	34'-8"	35'-9"	36'-10"	37'-11"	39'-0"	40'-1"	41'-2"	42'-3"	43'-4"	44'-5"	45'-6"
15	37'-4"	38'-6"	39'-8"	40'-10"	42'-0"	43'-2"	44'-4"	45'-6"	46'-8"	47'-10"	49'-0"
16	40'-0"	41'-3"	42'-6"	43'-9"	45'-0"	46'-3"	47'-6"	48'-9"	50'-0"	51'-3"	52'-6"
17	42'-8"	44'-0"	45'-4"	46'-8"	48'-0"	49'-4"	50'-8"	52'-0"	53'-4"	54'-8"	56'-0"
18	45'-4"	46'-9"	48'-2"	49'-7"	51'-0"	52'-5"	53'-10"	55'-3"	56'-8"	58'-1"	59'-6"
19	48'-0"	49'-6"	51'-0"	52'-6"	54'-0"	55'-6"	57'-0"	58'-6"	60'-0"	61'-6"	63'-0"
20	50'-8"	52'-3"	53'-10"	55'-5"	57'-0"	58'-7"	60'-2"	61'-9"	63'-4"	64'-11"	66'-6"
21	53'-4"	55'-0"	56'-8"	58'-4"	60'-0"	61'-8"	63'-4"	65'-0"	66'-8"	68'-4"	70'-0"
22	56'-0"	57'-9"	59'-6"	61'-3"	63'-0"	64'-9"	66'-6"	68'-3"	70'-0"	71'-9"	73'-6"
23	68'-8"	60'-6"	62'-4"	64'-2"	66'-0"	67'-10"	69'-8"	71'-6"	73'-4"	75'-2"	77'-0"
24	61'-4"	63'-3"	65'-2"	67'-1"	69'-0"	70'-11"	72'-10"	74'-9"	76'-8"	78'-7"	80'-6"
25	64'-0"	66'-0"	68'-0"	70'-0"	72'-0"	74'-0"	76'-0"	78'-0"	80'-0"	82'-0"	84'-0"
26	66'-8"	68'-9"	70'-10"	72'-11"	75'-0"	77'-1"	79'-2"	81'-3"	83'-4"	85'-5"	87'-6"
27	69'-4"	71'-6"	73'-8"	75'-10"	78'-0"	80'-2"	82'-4"	84'-6"	86'-8"	88'-10"	91'-0"
28	72'-0"	74'-3"	76'-6"	78'-9"	81'-0"	83'-3"	85'-6"	87'-9"	90'-0"	92'-3"	94'-6"
29	74'-8"	77'-0"	79'-4"	81'-8"	84'-0"	86'-4"	88'-8"	91'-0"	93'-4"	95'-8"	98'-0"
30	77'-4"	79'-9"	82'-2"	84'-7"	87'-0"	89'-5"	91'-10"	94'-3"	96'-8"	99'-1"	101'-6"
31	80'-0"	82'-6"	85'-0"	87'-6"	90'-0"	92'-6"	95'-0"	97'-6"	100'-0"	102'-6"	105'-0"

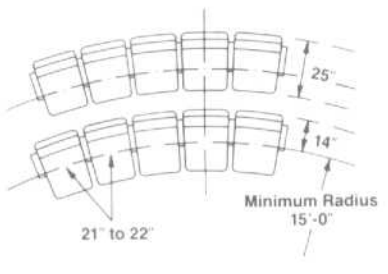
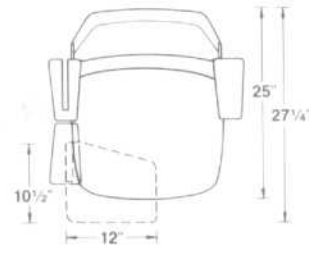
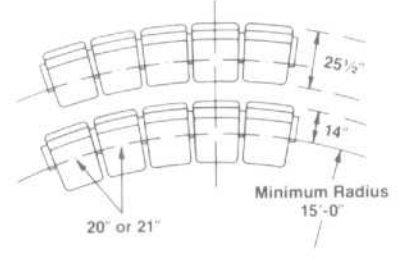
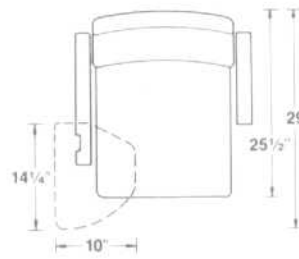
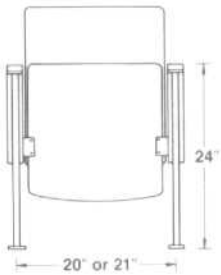
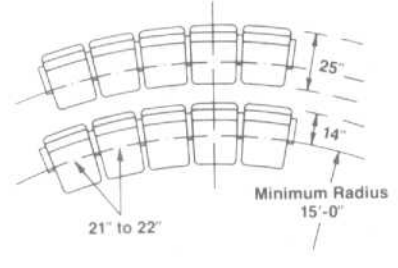
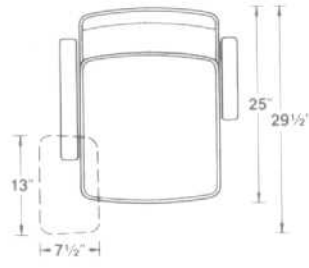
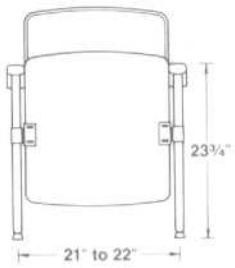
**AUDITORIUM SEATING**

Chair Dimensions



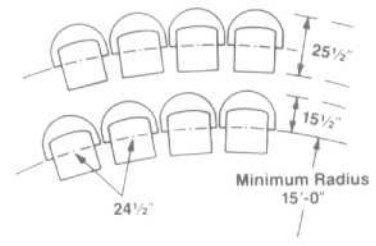
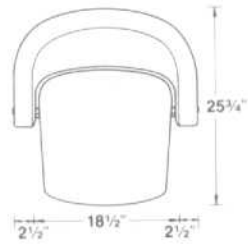
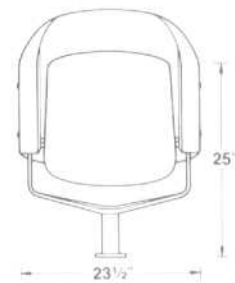


**AUDITORIUM SEATING**  
Chair Dimensions and Row Seating



22"

27"



## AUDITORIUM SEATING

## General Seating Arrangement

Seating arrangements in an assembly space will either be identified as "multiple-aisle" or "continental." These terms are commonly found in design standards manuals, building codes, and similar architectural reference documents. Each is unique with specific guidelines governing row size, row spacing, and exitways.

Basically, a multiple-aisle arrangement (Fig. 2) will have a maximum of 14-16 chairs per row with access to an aisleway at both ends. If an aisle can be reached from one end of a row only, the seat count may then be

limited to 7 or 8. It should be noted here that the maximum quantities will always be established by the governing building code.

In a continental arrangement (Fig. 3) all seats are located in a central section. Here the maximum quantity of chairs per row can greatly exceed the limits established in a multiple-aisle arrangement. In order to compensate for the greater length of rows allowed, building codes will require wider row spacing, wider aisles and strategically located exit doors.

Although more space would appear to be

called for, a continental seating plan is often not any less efficient than a multiple-aisle arrangement. In fact, carefully planned, a continental arrangement can frequently accommodate more seating within the same space. For early planning an average 7.5 sq. ft. per person may be used. This will include both the seating area and space necessary for aislesways.

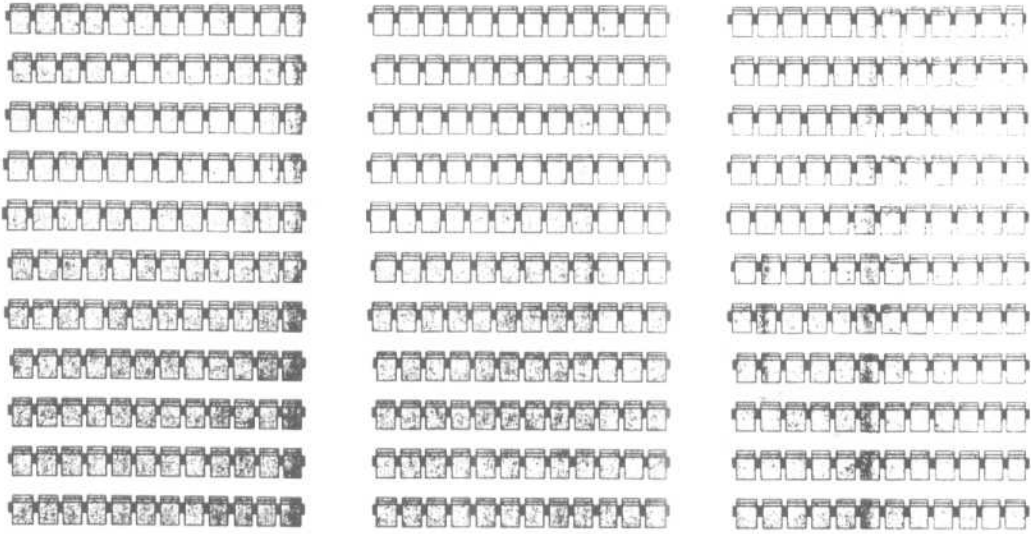


Fig. 2 Multiple-aisle arrangement.

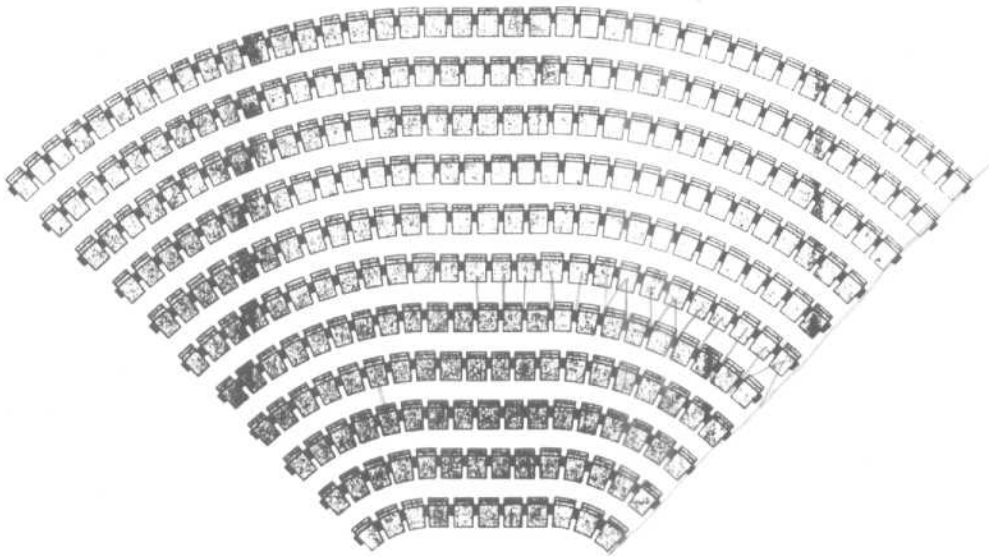
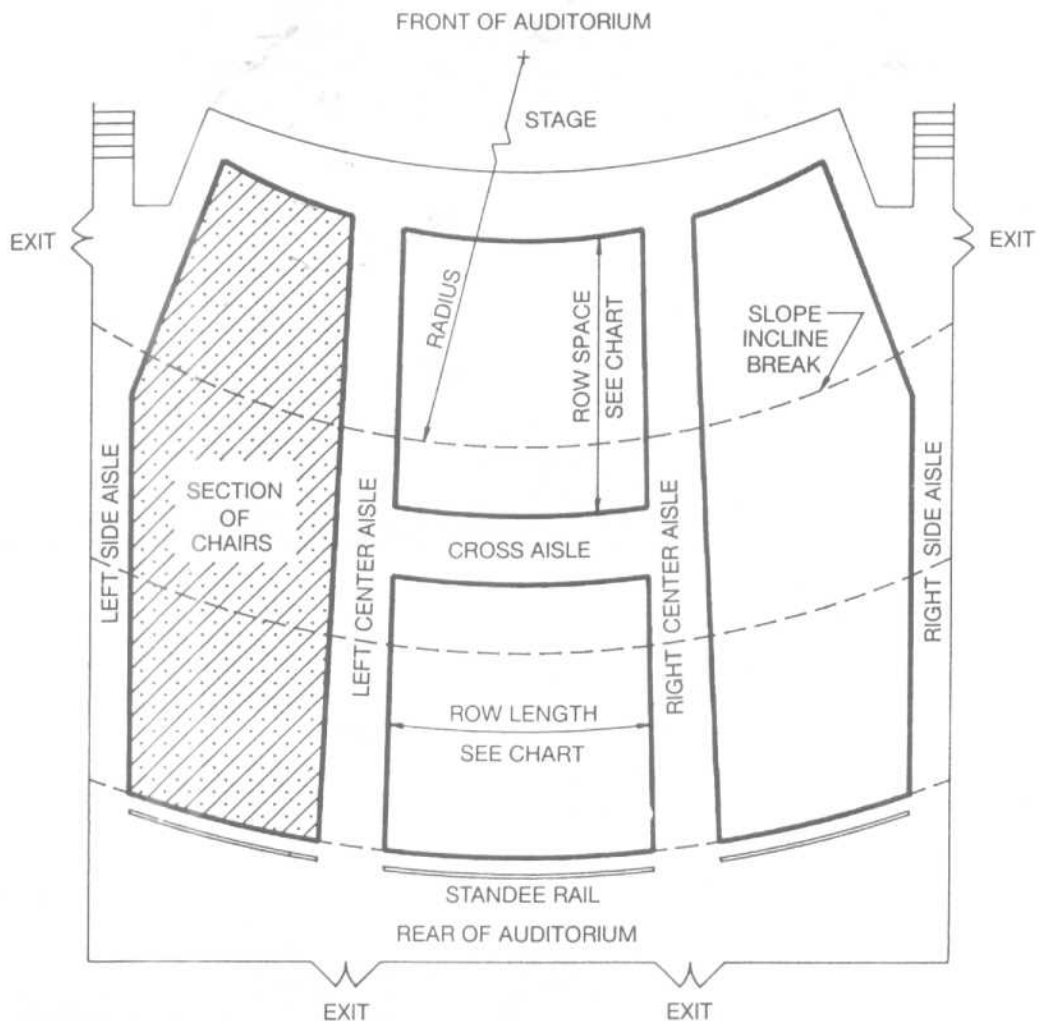


Fig. 3 Continental arrangement.

### Design Considerations

1. Layout per applicable building and life safety codes, regulations, and ordinances.
2. Allow sufficient distance between aisles for desired quantity and size of chairs plus end space.
3. Space rows to allow for proper seat to back clear space.
4. Determine radius or straight rows and locate by the chair size line.
5. Allow 1" minimum clearance from either side or rear of chair to any adjacent side wall, end walls, etc.
6. Provide adequate sightlines for either sloping or stepped (riser) floor configurations.
7. Seating area should be free of obstructions.
8. To allow for sufficient aisle illumination: Aisle lights are generally located in the end panel standards at least every other row. Locate aisle light junction box 6" from the standard.
9. Provide adequate floor or riser materials for sound anchorage.

TYPICAL PLAN OF SEATING AND TERMINOLOGY

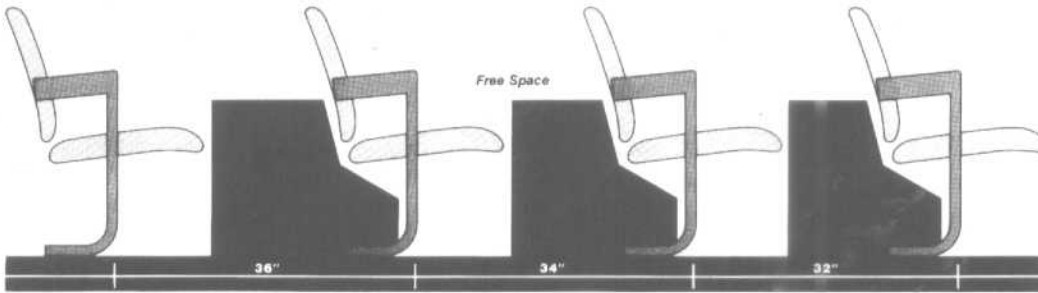
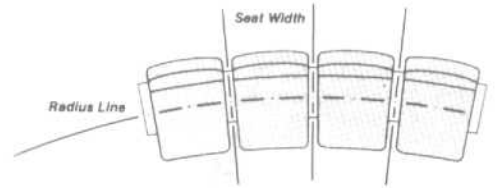


## AUDITORIUM SEATING

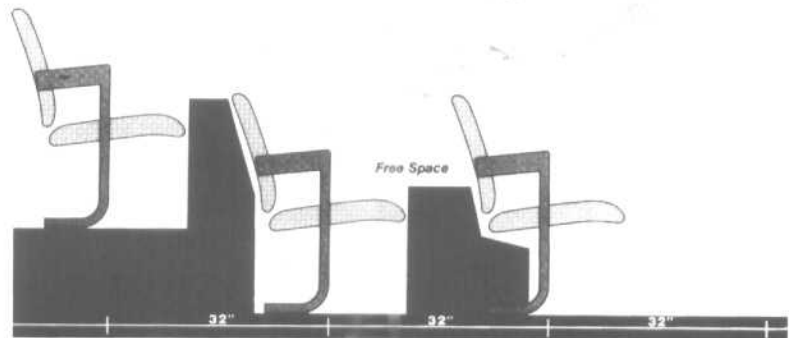
## Row Seating

**Seat Widths** Seating comfort is initially established by individual chair widths. Available sizes range from 18" to 24" however, all may not be produced by a single manufacturer. The most commonly used chair widths are 20", 21", and 22". It should be noted that these dimensions are nominal, being measured from center to center of the support legs. If seating comfort is a high priority, thought must be given to a particular width and the space taken up by chair arms to determine an actual size. Usually, smaller sizes of 18" and 19" have limited application due to the minimum clear width provided. Typically, all manufacturers size their chairs along an imaginary line which may be referred to as a "datum line," "chair radius line," or a similar name. For accurate planning in an assembly area, this line must be identified so as not to over- or underestimate the potential of a row of chairs.

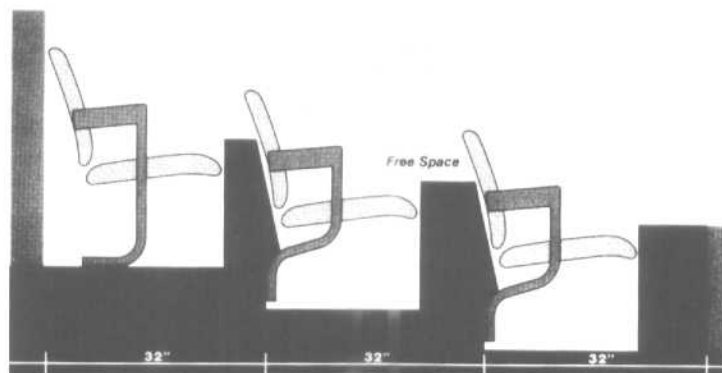
**Row Spacing** Row spacing or "back to back" spacing of seats is also very important in developing a comfortable assembly area. A minimum dimension occasionally used is 2'-8" (32"). This spacing provides marginal clearance between a seated person's knees and the back of the chair in the next forward row. At the same time, however, it will require that a seated person stand to permit the passage of another individual. As the row spacing is increased to 3'-0" (36"), seating comfort is dramatically improved and passage along a row of seated persons is accomplished with less disruption.



**Floor Design** Seating comfort will also be affected by the design of the assembly space floor. Flat or less steeply sloped floors will usually allow a person to extend their knees and legs even under minimum row spacing dimensions. Here an individual can take advantage of the open area under a seat and the free space created by the pitched back of a chair. As the floor slope is increased, this "free" space diminishes. The extreme condition exists where a large elevation change between rows is combined with a minimum row spacing. An example would be a 12" high riser and a 32" wide row spacing. At this point, it becomes necessary to consider increasing the back to back dimension to provide more leg room.



The "free" space under a chair is also lost when a row of seats is located directly behind a low wall. In this case, a recommended minimum clearance would be 11" measured from seat edge in the lowered position to face of wall. The back to back dimension of a row of seats abutting a rear wall should also be carefully studied. Normally, the pitched back of a chair will overlap a riser face, automatically reducing the width of that row unless succeeding rows are similarly positioned. Where a rear wall exists the recommended procedure is to increase the dimension of the last row sufficiently to accommodate any overlap plus a minimal space between the wall and top edge of the chair back.

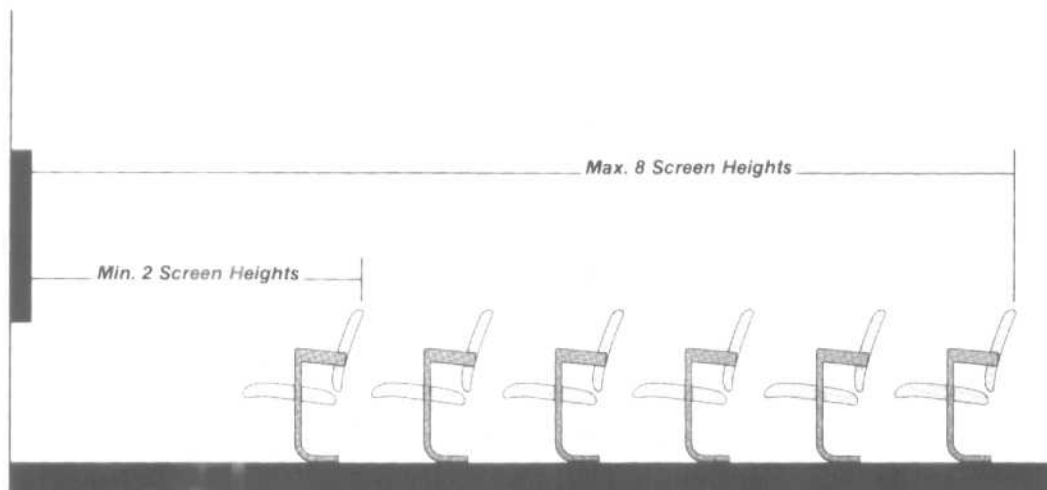
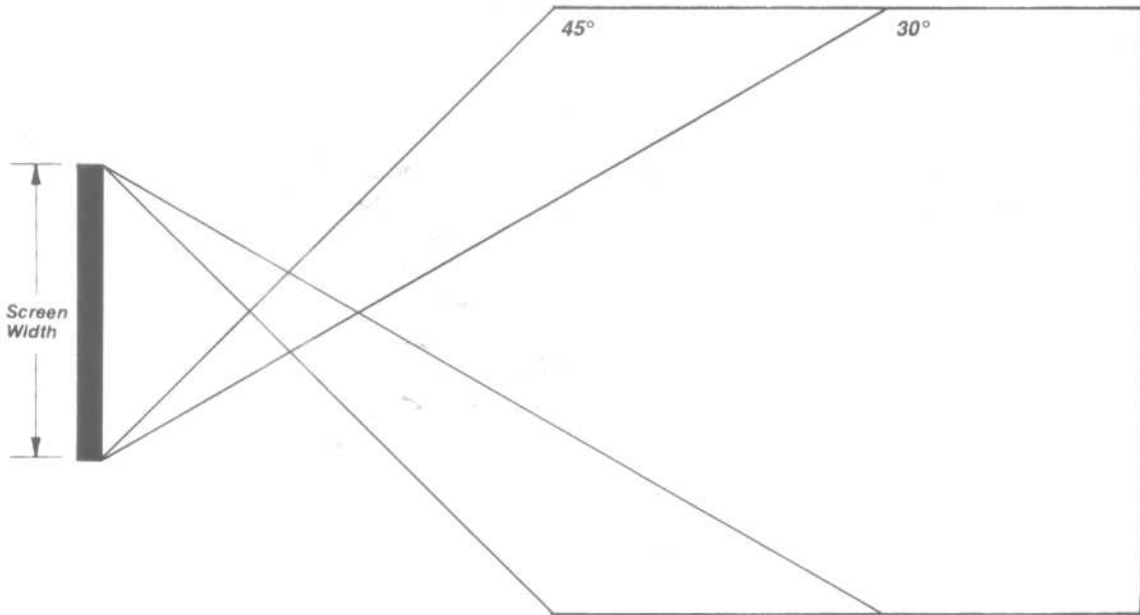


## AUDITORIUM SEATING

## Visibility

Visibility in an assembly space is a function of seat location. As stated earlier, building codes, comfort guidelines, floor design and the overall form of an assembly space will play a part in seating arrangements. This information combined with a basic understanding of sightline analysis and related planning guidelines can result in achieving an acceptable, if not optimum, level of viewing for spectators.

Perhaps film projection requires the most critical sightline analysis, since poor seat location will result in distorted images. For this activity the seating parameters are established by the screen or image size. An angle of  $30^\circ$  up to  $45^\circ$  measured perpendicular to the far and near edges of the screen can establish a side to side seating limit, while the screen or image height may determine the maximum distance. The minimum dimension or closest recommended seat will also be set by the screen height. (It should be noted that these figures are approximate and apply principally to flat screen projection.)

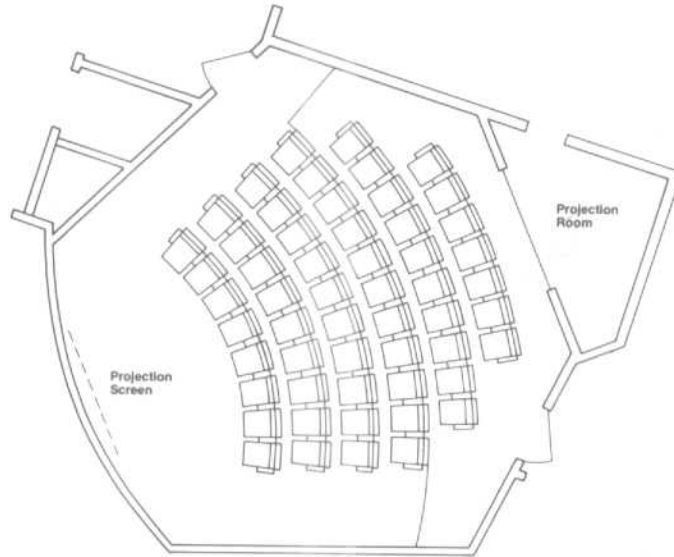


Specialties

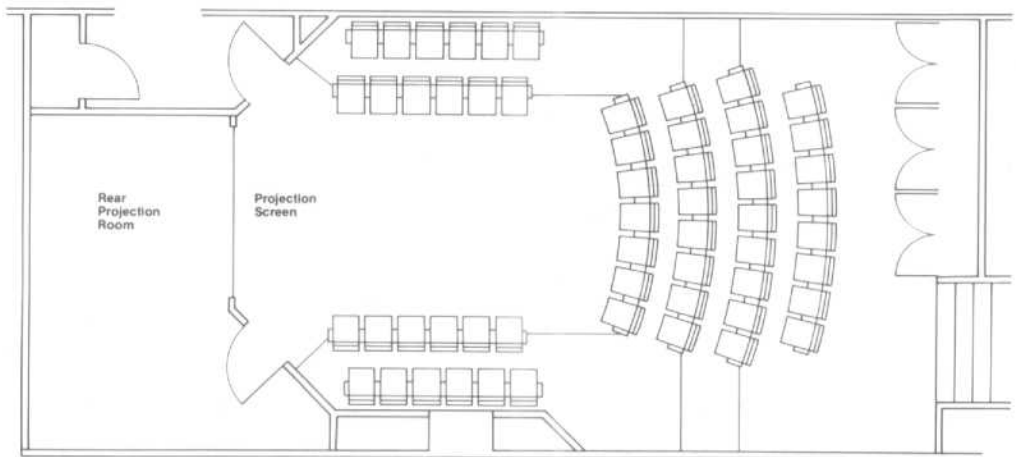
**AUDITORIUM SEATING**

End Stage; ¼ Arena

<b>Basic Theater Form</b>	End Stage
<b>Quantity of Seats</b>	55
<b>Seating Area</b>	450 Sq. Ft.
<b>Space per Seat</b>	8.23 Sq. Ft.
<b>Row Spacing</b>	2'-9"
<b>Most Distant Seat</b>	22'-0"
<b>Stage Elevation</b>	None
<b>Floor Design</b>	Flat/ One Riser 8"



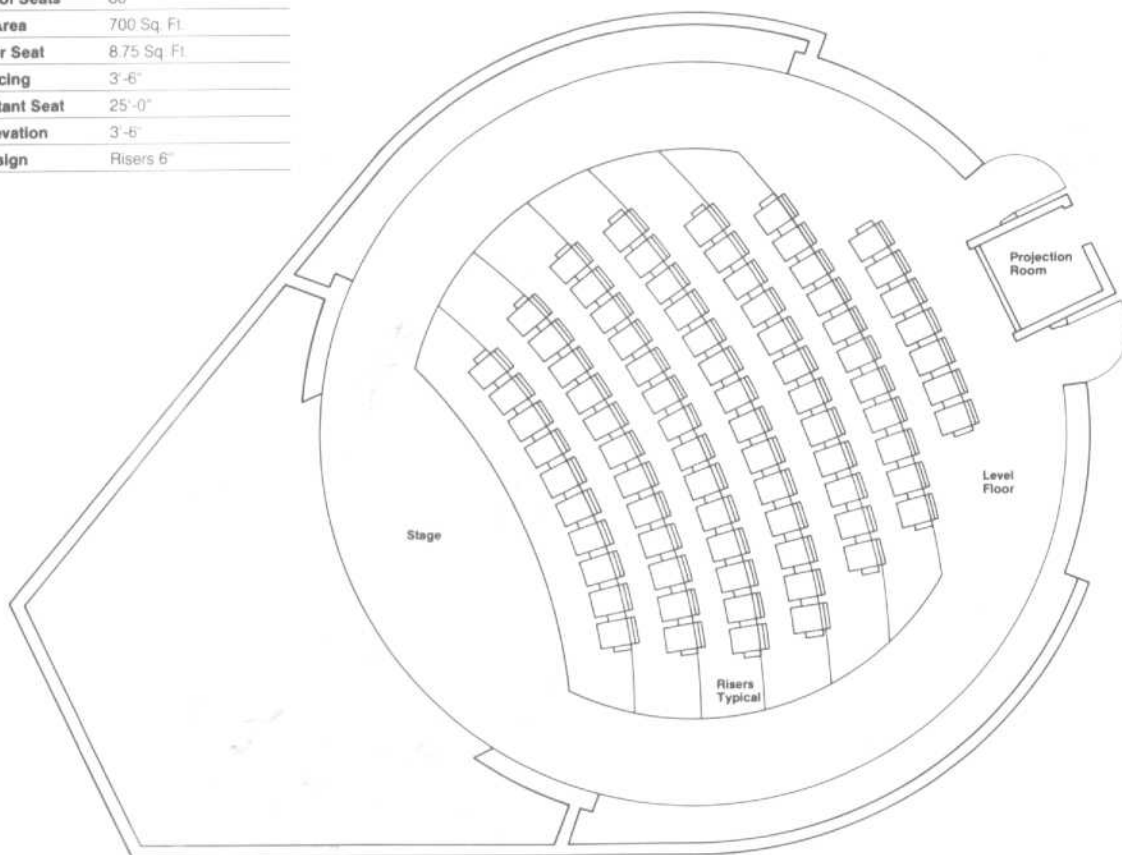
<b>Basic Theater Form</b>	¼ Arena
<b>Quantity of Seats</b>	56
<b>Seating Area</b>	622 Sq. Ft.
<b>Space per Seat</b>	11.1 Sq. Ft.
<b>Row Spacing</b>	3'-3"
<b>Most Distant Seat</b>	32'-0"
<b>Stage Elevation</b>	None
<b>Floor Design</b>	Risers 4"



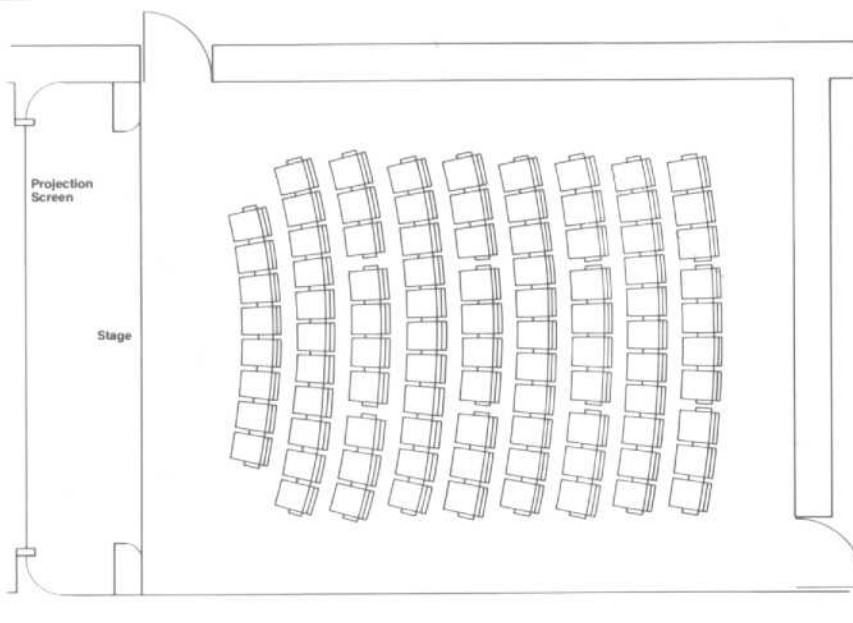
**AUDITORIUM SEATING**

End Stage

<b>Basic Theater Form</b>	End Stage
<b>Quantity of Seats</b>	80
<b>Seating Area</b>	700 Sq. Ft.
<b>Space per Seat</b>	8.75 Sq. Ft.
<b>Row Spacing</b>	3'-6"
<b>Most Distant Seat</b>	25'-0"
<b>Stage Elevation</b>	3'-6"
<b>Floor Design</b>	Risers 6"



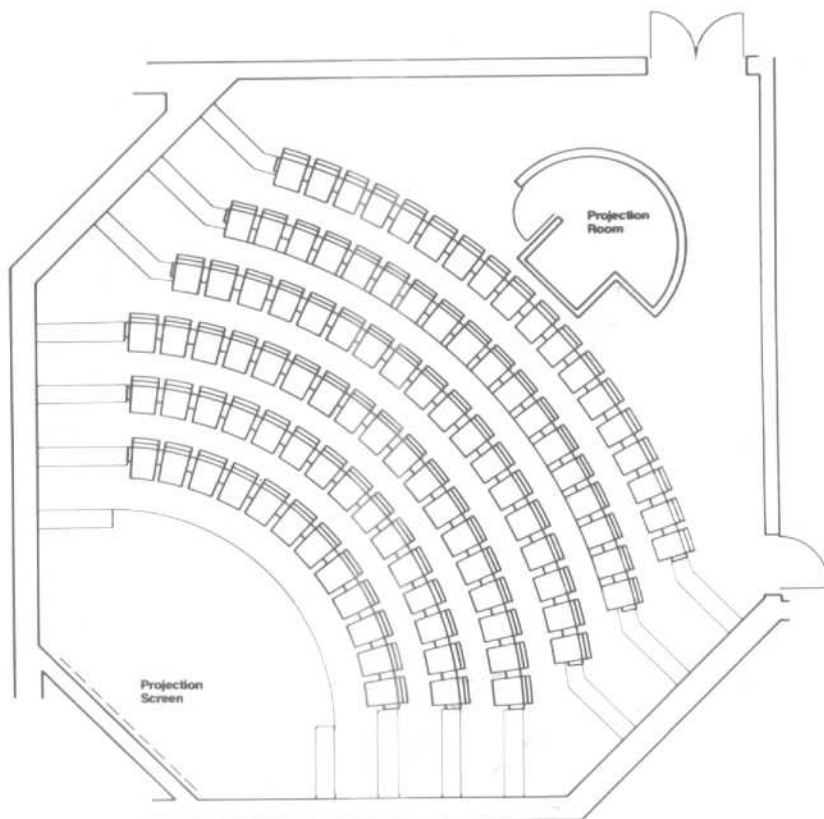
<b>Basic Theater Form</b>	End Stage
<b>Quantity of Seats</b>	92
<b>Seating Area</b>	956 Sq. Ft.
<b>Space per Seat</b>	10.4 Sq. Ft.
<b>Row Spacing</b>	3'-0"
<b>Most Distant Seat</b>	37'-0"
<b>Stage Elevation</b>	12"
<b>Floor Design</b>	Flat



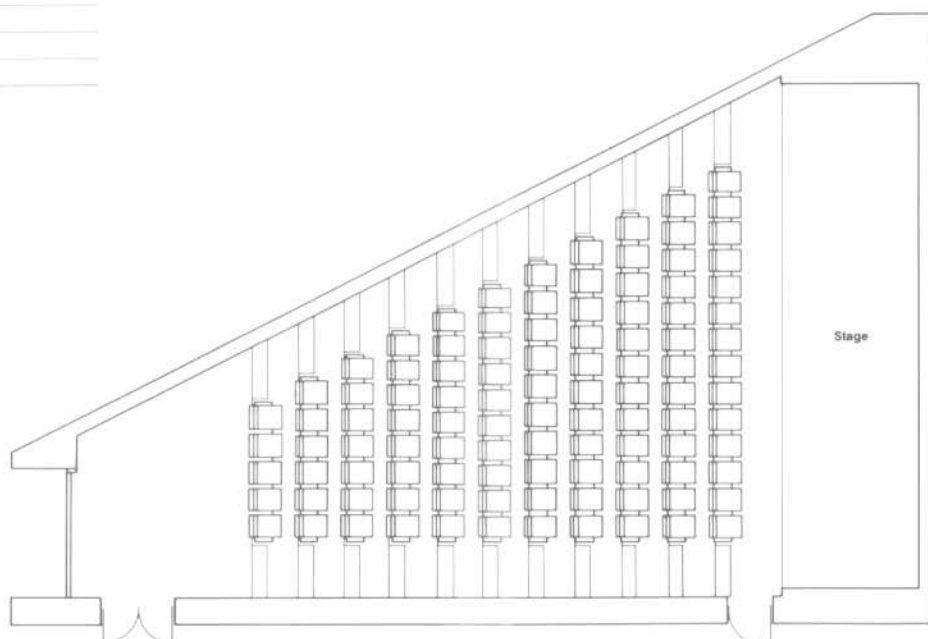
## AUDITORIUM SEATING

## End Stage

<b>Basic Theater Form</b>	End Stage
<b>Quantity of Seats</b>	99
<b>Seating Area</b>	953 Sq. Ft.
<b>Space per Seat</b>	9.62 Sq. Ft.
<b>Row Spacing</b>	3'-5"
<b>Most Distant Seat</b>	32'-0"
<b>Stage Elevation</b>	12"
<b>Floor Design</b>	Risers 12"



<b>Basic Theater Form</b>	End Stage
<b>Quantity of Seats</b>	105
<b>Seating Area</b>	903 Sq. Ft.
<b>Space per Seat</b>	8.6 Sq. Ft.
<b>Row Spacing</b>	3'-0"
<b>Most Distant Seat</b>	35'-0"
<b>Stage Elevation</b>	5"
<b>Floor Design</b>	Risers 12"

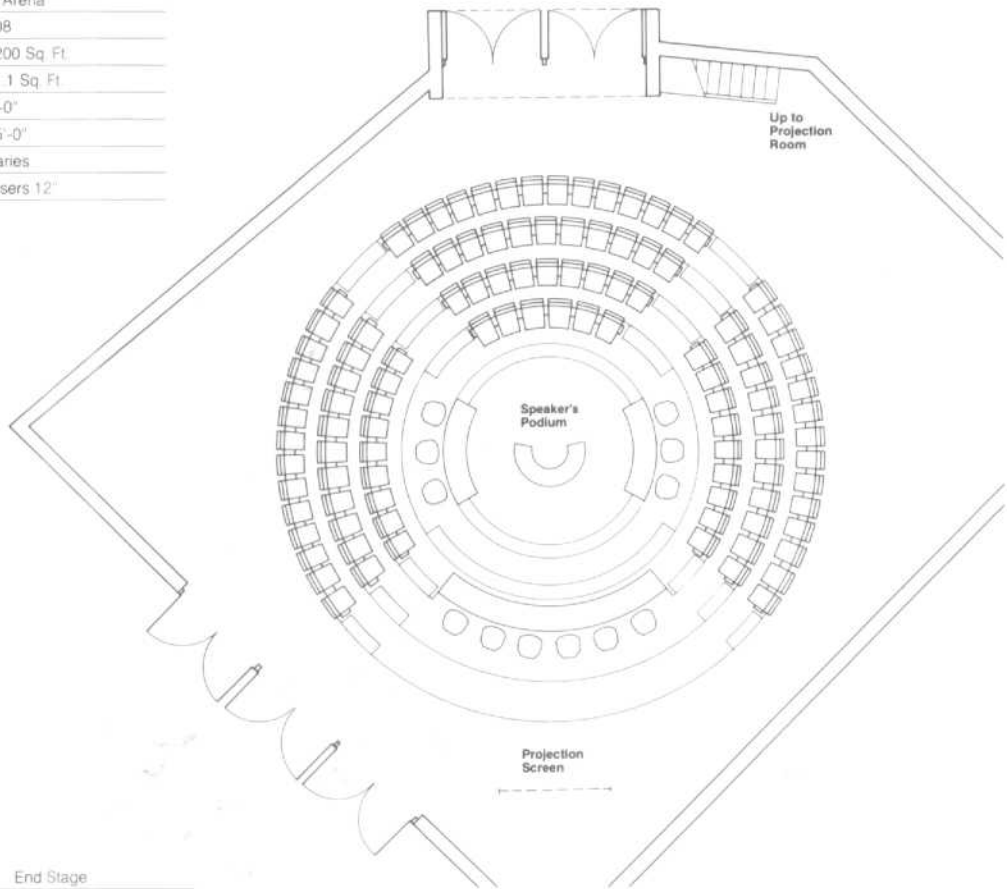




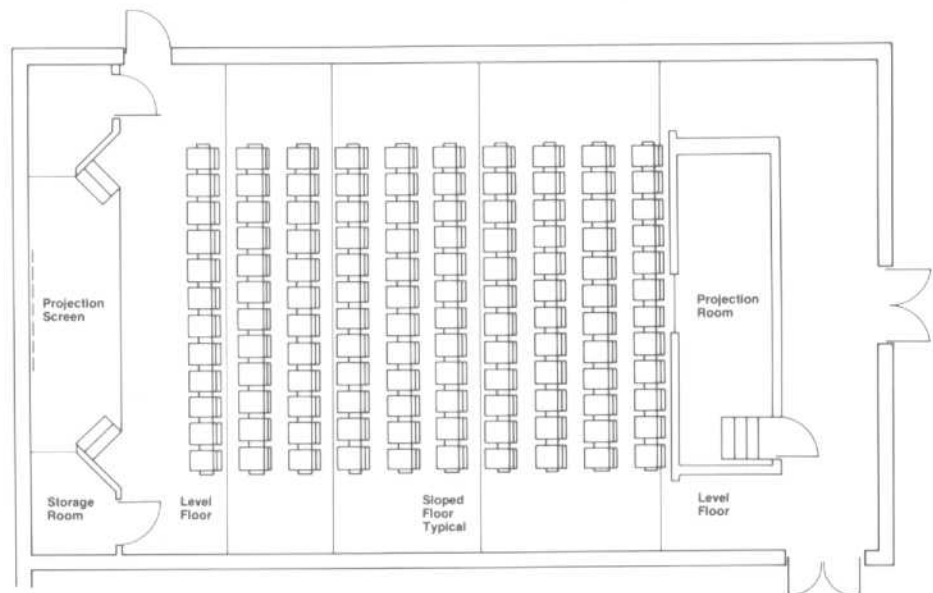
**AUDITORIUM SEATING**

¼ Arena; End Stage

<b>Basic Theater Form</b>	¼ Arena
<b>Quantity of Seats</b>	108
<b>Seating Area</b>	1200 Sq. Ft.
<b>Space per Seat</b>	11.1 Sq. Ft.
<b>Row Spacing</b>	3'-0"
<b>Most Distant Seat</b>	45'-0"
<b>Stage Elevation</b>	Varies
<b>Floor Design</b>	Risers 12"



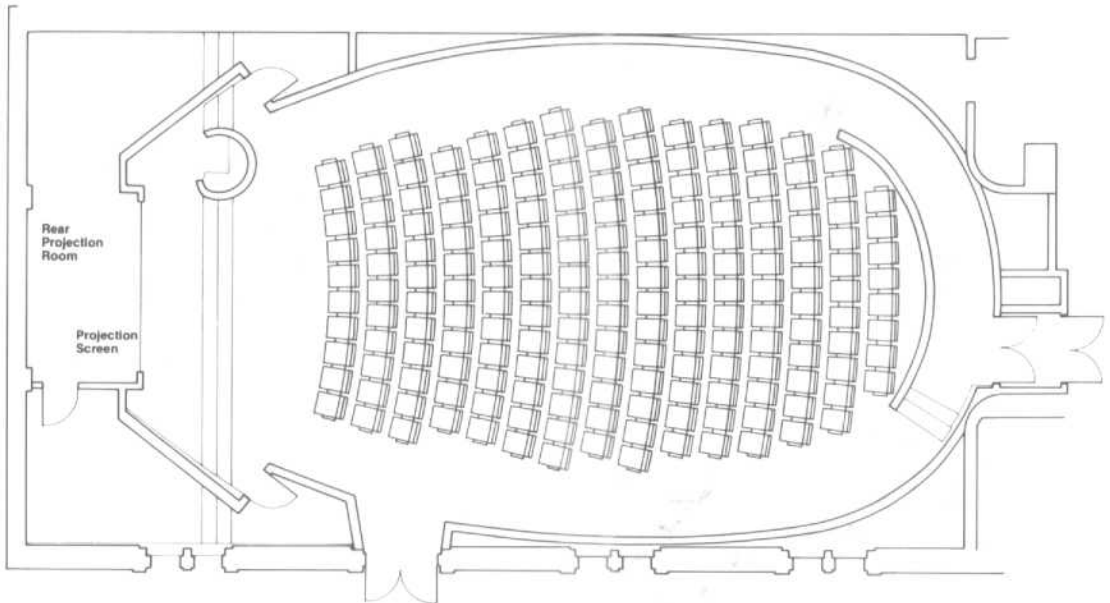
<b>Basic Theater Form</b>	End Stage
<b>Quantity of Seats</b>	120
<b>Seating Area</b>	1088 Sq. Ft.
<b>Space per Seat</b>	9.1 Sq. Ft.
<b>Row Spacing</b>	3'-3"
<b>Most Distant Seat</b>	41'-0"
<b>Stage Elevation</b>	1'-6"
<b>Floor Design</b>	Isosceles Slope 2.4°, 4.7°, 7.1°



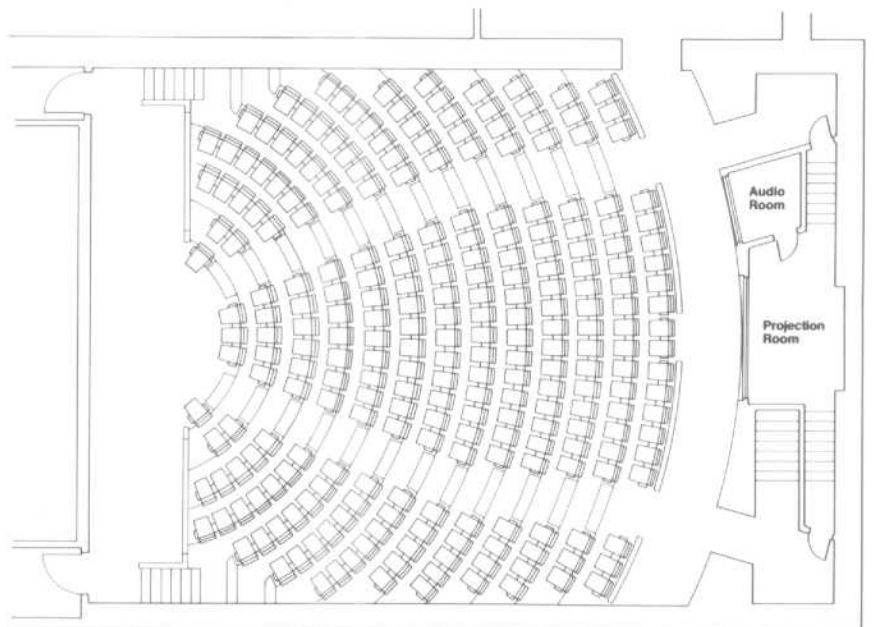
**AUDITORIUM SEATING**

End Stage; Wide Fan

<b>Basic Theater Form</b>	End Stage
<b>Quantity of Seats</b>	180
<b>Seating Area</b>	1218 Sq. Ft.
<b>Space per Seat</b>	6.8 Sq. Ft.
<b>Row Spacing</b>	2'-8"
<b>Most Distant Seat</b>	50'-0"
<b>Stage Elevation</b>	1'-6"
<b>Floor Design</b>	Isidomal Slope -1° to 10°



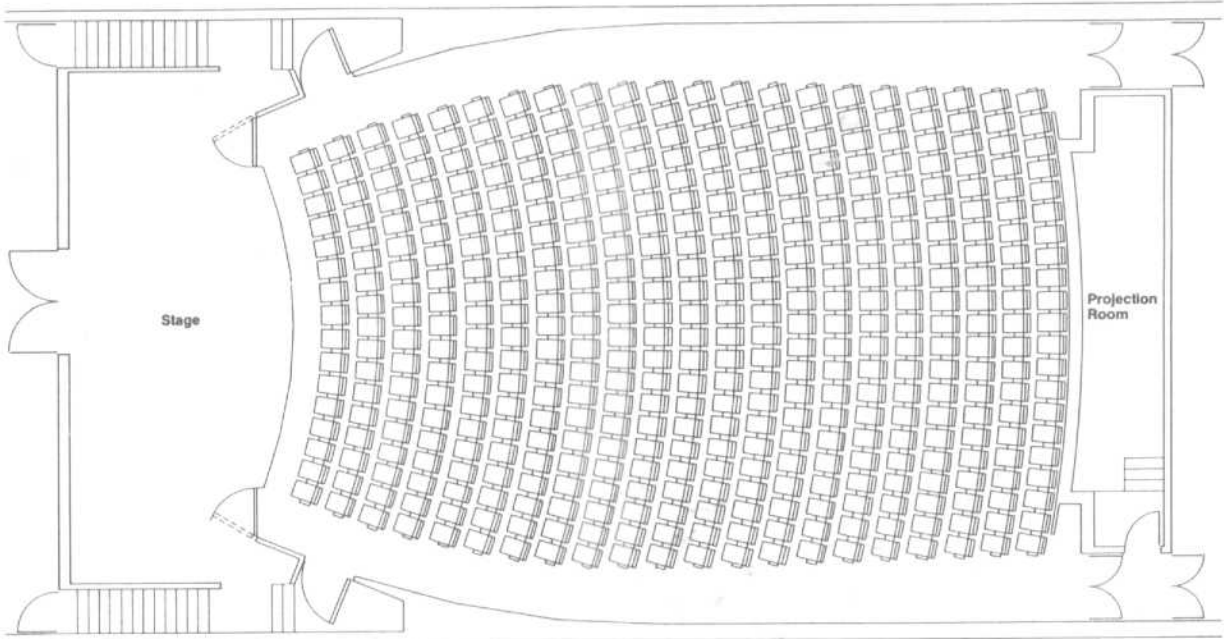
<b>Basic Theater Form</b>	Wide Fan
<b>Quantity of Seats</b>	253
<b>Seating Area</b>	1790 Sq. Ft.
<b>Space per Seat</b>	7.1 Sq. Ft.
<b>Row Spacing</b>	3'-0"
<b>Most Distant Seat</b>	48'-0"
<b>Stage Elevation</b>	None
<b>Floor Design</b>	Risers—Varying Height 10½" to 16"



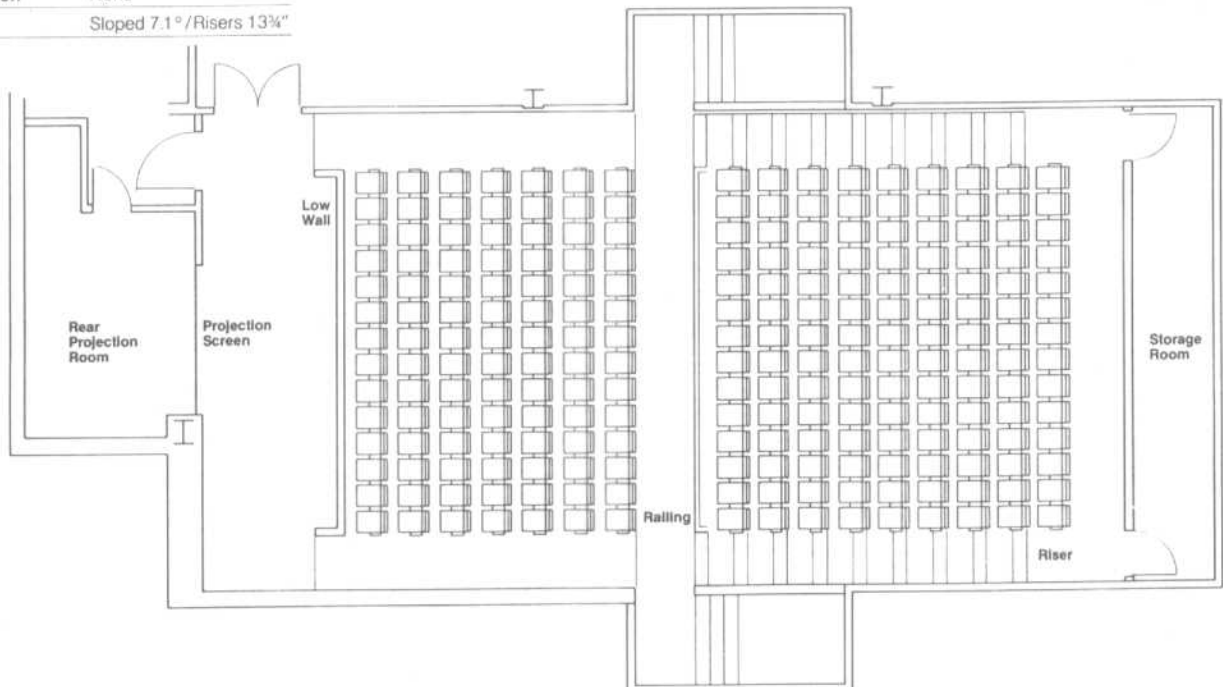
**AUDITORIUM SEATING**

End Stage

<b>Basic Theater Form</b>	End Stage
<b>Quantity of Seats</b>	430
<b>Seating Area</b>	2586 Sq. Ft.
<b>Space per Seat</b>	6.0 Sq. Ft.
<b>Row Spacing</b>	2'-8 $\frac{3}{4}$ "
<b>Most Distant Seat</b>	58'-0"
<b>Stage Elevation</b>	2'-6"
<b>Floor Design</b>	Sloped 7.1°



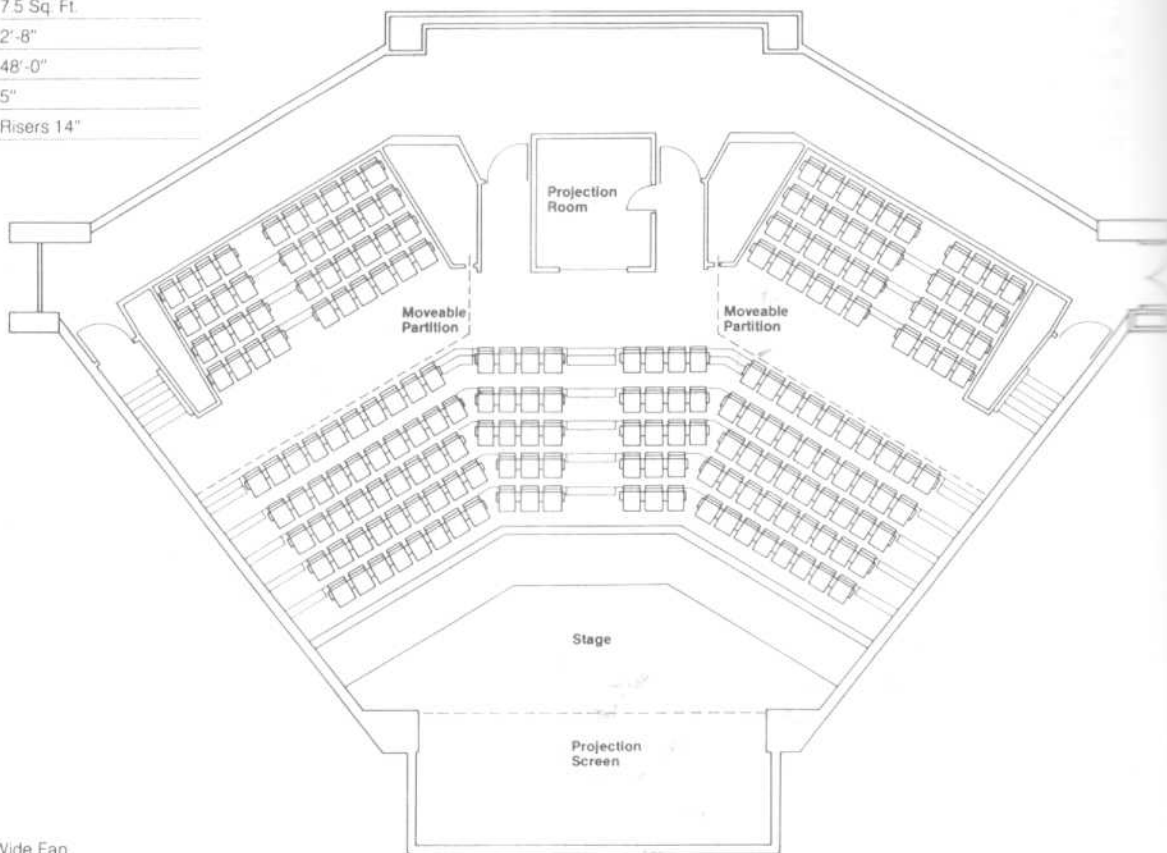
<b>Basic Theater Form</b>	End Stage
<b>Quantity of Seats</b>	224
<b>Seating Area</b>	1660 Sq. Ft.
<b>Space per Seat</b>	7.4 Sq. Ft.
<b>Row Spacing</b>	2'-9"
<b>Most Distant Seat</b>	60'-0"
<b>Stage Elevation</b>	None
<b>Floor Design</b>	Sloped 7.1°/Risers 13 $\frac{3}{4}$ "



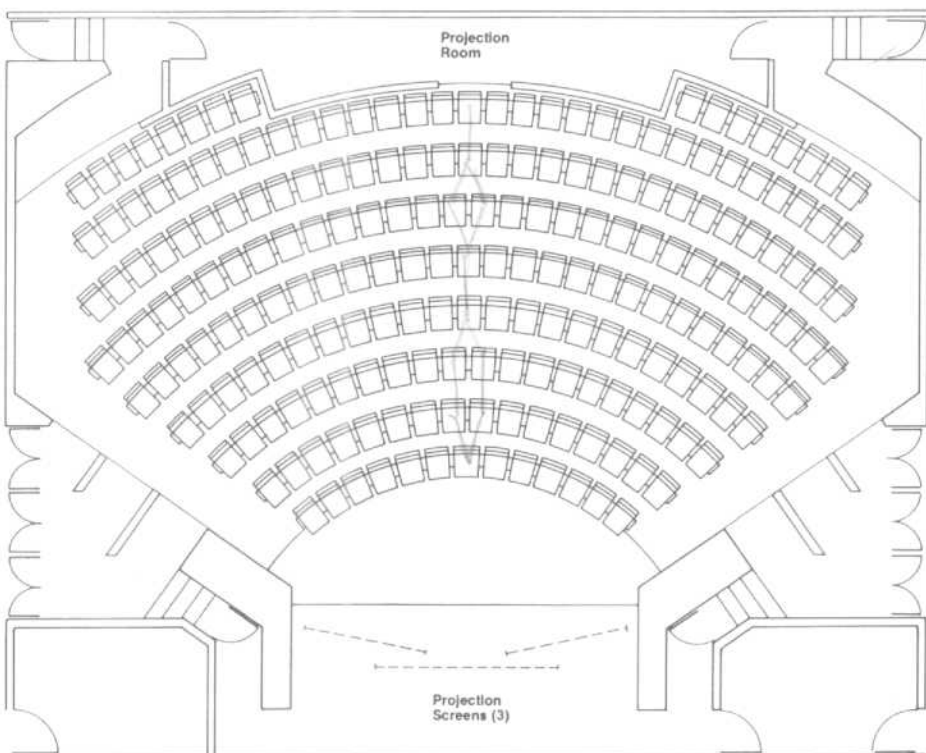
**AUDITORIUM SEATING**

**Wide Fan**

Basic Theater Form	Wide Fan
Quantity of Seats	208
Seating Area	1557 Sq. Ft.
Space per Seat	7.5 Sq. Ft.
Row Spacing	2'-8"
Most Distant Seat	48'-0"
Stage Elevation	5"
Floor Design	Risers 14"



Basic Theater Form	Wide Fan
Quantity of Seats	207
Seating Area	1428 Sq. Ft.
Space per Seat	6.9 Sq. Ft.
Row Spacing	3'-4"
Most Distant Seat	40'-0"
Stage Elevation	2'-3"
Floor Design	Sloped 6.6°



## CONTROL OF GROUNDS

Fencing can be a very effective means of limiting access to secondary exits and to vulnerable ground-level dwellings. Fencing functions as a control by requiring entry through a single, limited, highly visible area. The fencing surrounding most single-family homes does not have locked gates. It is intended primarily to protect children, pets, and gardens, and to define the area immediately around the home as the private outdoor space of that household. Any intrusion into the area within the fence is therefore noticeable. As a security measure, such fencing, used symbolically, is of minimal value against premeditated crime, but it does make criminal intent visible and so is an important deterrent.

A conventional use of fencing in multifamily complexes is to limit access to backyards and windows of a housing cluster. On conventional city blocks, backyards of row housing are accessible only through one of the houses. However, in many superblock designs, such backyards are left open to public access. In this situation, addition of a limited amount of fencing can protect a large group of homes (see Fig. 1). This approach can also subdivide the superblock and so create small, natural clusters.

### The Lobby

Improving visibility is the most important ingredient in providing a naturally secure lobby. It is crucial that a tenant entering a building be able to see what is going on in the lobby from the outside. Hidden nooks and blind curves provide perfect hiding places. Where such features cannot be removed structurally, the use of mirrors, windows, and improved lighting may ease the situation.

Ideally, a person walking down a path to enter a building should be able to see anyone standing in the lobby and elevator waiting area. In fact, it is often advantageous if the arriving person can see into the elevator from across the lobby.

## CONTROL OF INTERIOR PUBLIC SPACES OF MULTIFAMILY DWELLINGS

The most vulnerable locations in multifamily buildings are the interior public spaces: lobbies, elevators, stairwells, and corridors. These are areas open to the public but without the attending surveillance given a public street by passersby and police. The crimes that occur in these interior public spaces are the most fearful types of crimes, involving acts of personal confrontation such as robbery, assault, and rape. Limiting access to these spaces through the use of a doorman or intercom/door lock system can be of substantial benefit.

Lobby visibility discourages a number of different kinds of crime. Crimes of personal confrontation may be deterred primarily because the potential victim can readily perceive and avoid a suspicious person in the lobby. The potential criminal must also fear the possibility that another tenant or the police may be viewing the crime in the well-lit open area.

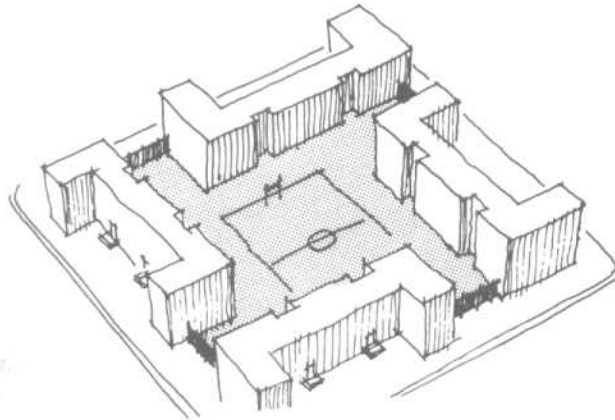


Fig. 1 Use of fencing to define and secure large semiprivate areas.

Mailbox crime — generally the theft of checks — can be deterred when mailboxes are located in a highly protected area of the lobby. This protection can consist of placing the mailboxes behind an intercom or in a locked mailroom. It is essential that the mailboxes be visible from as many different viewpoints as possible. Improved visibility in this context can be a significant deterrent to crime.

Some managers designate an area of the lobby as a legitimate resting place, where chairs and other lounging items are provided. Lounging may aid security, particularly if the building includes a high proportion of elderly. The best locations for such seating are areas with high visibility. Often tenant patrols use this space as a station and provide still another dimension of security.

A bulletin board is an inexpensive device that can improve lobby security by providing a diversion. If, for example, a tenant enters the lobby and sees someone she doesn't recognize waiting for an elevator, she may need a reasonable excuse for not taking the same elevator. The bulletin board provides the tenant with a natural excuse to pause and survey the situation.

The area around the main entry to a multifamily building should be clearly distinguished from the public walkway which leads to it. A person entering through the main door should feel distinctly that he is entering a space controlled by the residents of the building. The main entry should be well lit and clearly visible from outside.

Entry doors should be constructed of a transparent material covering as large an area as possible. In vandalism-prone areas, the main entry doors should be made of unbreakable glass or other similar, very sturdy transparent material. Because of the need for good visibility, replacing glass panels with metal or other material should be avoided. For window walls and doors where the incidence of vandalism is extreme, glass panels less than 2 feet from the ground and higher than 7 feet from the ground may be replaced by solid materials.

### Fire Doors and Fire Stairs

Secondary exit doors are the weakest link in security of buildings. An ideal secondary exit door would be one that allows exit but not entrance. Unfortunately, there is no acceptable emergency exit system that allows egress only.

In the design of any security system there is a continuing clash between the need for security against crime and the need for safety in case of fire. Fire doors are frequently used for entry and exit by criminals. Installation of panic hardware and the absence of exterior hardware sometimes prevent criminal use. These measures will not suffice, however, where tenants do not cooperate in avoiding use of secondary exits and ensuring they are kept closed.

To a large extent, the design and location of secondary fire exits determine tenant attitudes about the exits. For example, a building's main entry may face the street, but the parking lot may be to the rear of the building. If the secondary exit is also at the rear and close to this destination, the temptation to use the fire door as an entry or exit will be difficult to resist. Similarly, security is decreased in buildings where the main entries face the interior of the project while the fire doors face the surrounding streets with their parking and shopping facilities. Where the fire exit does not represent any shortcut or improved convenience to the tenant, it is far more likely to remain closed. A securely designed building is one in which the fire door exits to an area that is less convenient or desirable than the area outside the main door.

In cases of persistent breaks in security of secondary exits, it is possible to modify the building plan at the ground level and open a new doorway in a better location. However, this improvement is costly and can only be done where architecturally possible.

Another architectural modification to improve security involves making a fire exit into a legitimate secondary entry and developing a security system that protects both the main and secondary entries. If a fire door exits to a

## SECURITY

## General Control Guidelines; Doors and Hardware

parking area, for example, this modification may be more successful than efforts to prevent tenants from using that exit. If the main entry is equipped with an intercom system, the secondary entry should be similarly equipped and made easily surveillable through the use of lighting and windows.

Other mechanisms can be used to limit access to and prevent circulation through the emergency exit system. A fire exit passageway, for example, can be modified by installing a second door inside the building a short distance from the existing exterior door. Both doors should be equipped with hardware so that they can be opened only from the inside. The point of this system is that it is unlikely that both doors will be propped or jammed open at the same time. A tenant entering an open exterior fire door which leads only to the locked second door will have to exit and use another door. A few experiences of this kind will convince most tenants that it is probably more convenient to go directly through the main entrance. This double-door system generally does not conflict with fire codes.

An extension of this concept is to have the fire door on each floor above ground level openable from the corridor only. Thus, once someone has gone into a stairwell he can only exit at the ground level. This system may be somewhat inconvenient to tenants accustomed to moving easily between floors, but it does create roadblocks for anyone attempting to enter the building from the ground-level exit door.

The improvements outlined above are generally applicable to all dwellings. In buildings which have such security personnel, additional measures are possible.

A doorman or security guard can only be effective if he controls all access to the building, including access through fire doors. In a well-designed building, the doorman can see the fire doors from his position at the main entry. Where this is not possible, an inexpensive and effective solution is to install panic hardware with an alarm, and make sure the doorman can hear and respond to the alarm. Where the doorman or guard has access to closed-circuit TV, this may be used to monitor the fire doors. If the doorman can also be given a device for controlling the secondary door, it becomes very difficult for a criminal to use the fire entry.

## Elevators

There are virtually no structural modifications that can improve security within elevators. The only possible improvements are use of mirrors, communication devices, emergency buttons, or an electronic surveillance system.

Security modifications to other areas of a building improve security within the elevator. If the elevator waiting area and the elevator cab are a visible extension of the lobby, the residents are afforded some protection. Similarly, if the fire door and fire stairs are secure, there is less chance of a criminal entering the elevator on an upper floor. In this sense, the safety of the elevator is dependent upon the general security of the building.

## SECURING THE DWELLING

Illegal entry into dwelling units is traditionally prevented by use of hardware. However, there are building design features which in themselves limit access, improve surveillance, and promote neighbor recognition.

## Windows

Ground-level windows are generally most vulnerable to illegal entry and breakage. (All windows whose lower ledges are less than 7 feet off the ground should be considered ground level.) There are three ways to discourage criminal entry through ground-floor windows: design ground-floor areas which need few windows; house activities on the ground floor which hold no interest to the burglar; and assign the grounds immediately adjacent to the building for the use of the neighboring resident and fence off the grounds for his protection.

Elaborate architectural details — protruding ledges, for example — often increase the vulnerability of lower windows. Fences, garbage containers, and parked cars, when located near windows, are used as stepping stones to an otherwise inaccessible window. Care should be taken to prevent this type of situation.

Most windows above the ground floor are relatively inaccessible, with very important exceptions. Fire escapes make windows accessible. Little can be done to modify fire escapes, except in terms of hardware, because of fire safety and fire codes. One solution is to ensure that the ladder from the lowest fire escape is at least 12 feet above the ground. The ground area under the fire escape should be highly visible.

Another point of entry to the fire escape is the roof, which can be secured with panic hardware and possibly patrolled. The roof also provides possible entry to windows or balconies on the top floor. Therefore, security of the roof is quite essential, particularly to top-floor residents. Other accessible windows are those located diagonally across from a stairwell window. The criminal can open a stairwell window and cross from the stairwell into the units. It is not advisable to board up stairwell windows, as they provide the security of visibility to the stairwell and may have a fire safety function.

Accessible windows are also those located above or near door canopies. Criminals can reach the canopy by climbing onto it from the ground or from a stair or hall window.

## Doors

Security of doors, beyond the hardware aspect, depends upon surveillance and neighbor recognition. An experienced burglar needs just a few seconds to enter a locked apartment door equipped with minimal hardware. Within this interval, the crucial factors are: Will the intruder be seen or heard by tenants, will the viewer perceive that the potential criminal is in fact an intruder, and will the viewer respond by calling authorities or in some way challenge the criminal?

Physical design can directly influence the opportunity for surveillance of doors. Cor-

ridors that are open to view, either single loaded or with windows, are more easily surveillable by residents and police. Thus the opportunity for the criminal to attempt entry undetected is reduced.

In most single-family homes (detached or row) where the entrance door is on the street, the only means of improving surveillance is to avoid placing trees and shrubs where they hide the doors and windows, and to locate lighting to improve visibility around these openings.

In multiple-family dwellings, the apartment doors, located on interior corridors, are generally difficult to keep under surveillance. Any windows, mirrors, or lighting that allow someone inside an apartment or outside the building to view the hallway and doors can be helpful.

## HARDWARE

This section describes hardware devices that secure the individual residential dwelling and the multifamily dwelling. Much of this material is intended to prevent burglary. However, some of the measures, particularly those directed at multifamily dwellings, will also deter forcible entry, robbery, and vandalism.

## THE RESIDENTIAL DWELLING

## Door Materials

The major security tests of door material are its ability to withstand efforts to force entry by brute strength and its ability to retain securely the locking devices attached. Materials most commonly used for doors are wood, aluminum, steel, and glass, often in combination with hardboard, fiberboard, asbestos, and plastic. The two most common door designs are panel and flush. Panel doors consist of vertical and horizontal members framing rectangular areas in which opaque panels, panes of glass, or louvers are located. Flush doors consist of flat panels running the full height and width of the door. (See Fig. 2.)

Solid-steel flush doors, although most secure, are rarely used except in very high-security areas such as banks and prisons. Steel-clad doors, which are flush doors constructed of 24-gauge sheetmetal facing bonded to a nonresinous, kiln-dried wood interior, provide an optimum weight-strength situation for ordinary residential use. Hollow steel doors (1¾-inch flush type) are satisfactory in multiple-dwelling buildings. Aluminum doors can provide sufficient protection but may be comparatively expensive.

While less strong than steel-clad doors, wood doors can be secure. All exterior wooden doors should be of solid-core construction with a minimum thickness of 1¾ inches. Although flush doors provide better security, if panel doors are desired for aesthetic reasons, the panels should have a minimum ½-inch thickness (see Fig. 3). Both hollow-core wood doors and thin-wood panel doors are unacceptable where security is a factor.



### Door Frames

The sides and top of a doorway are provided with a door frame which holds the door in position. The side members of the door frame are called jambs; the top member is called the head (see Fig. 4). The strike is the portion of the jamb which is cut out or drilled out to allow installation of a metal plate, which accepts the latch or bolt from the door lock (see Fig. 5).

Wooden frames provide an unacceptable

level of security unless they are at least 2 inches thick. Metal-covered wood frames provide an optimum cost-security investment when used in combination with metal-covered wood doors. If a hollow steel frame is used, the residual air space behind the frame should be filled with a crush-resistant material such as cement grout, especially in the area of the strike (see Fig. 6). This will prevent an intruder from wedging a crowbar between the door and frame and crushing

the frame to free the lock.

For doors swinging in, rabbeted jambs should be used. These are jambs containing a metal extension that protrudes beyond the edges of the closed door, thus preventing tampering in the area of the strike (see Fig. 7).

For doors without rabbeted jambs, an L-shaped piece of angle-iron at least 2 feet long, mounted in the area of the strike, gives extra protection (see Fig. 8). The iron acts as a lip which protects the strike from attack.

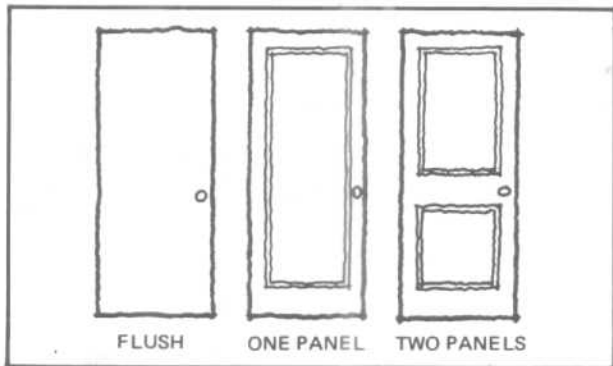


Fig. 2 Door types.

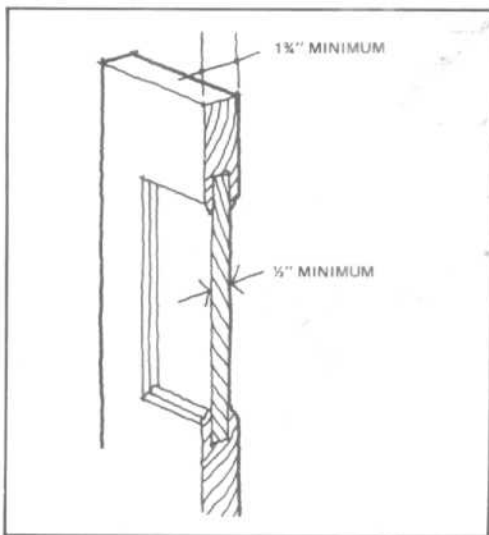


Fig. 3 Panel door.

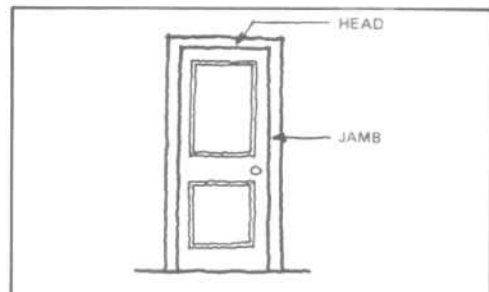


Fig. 4 Door frame.

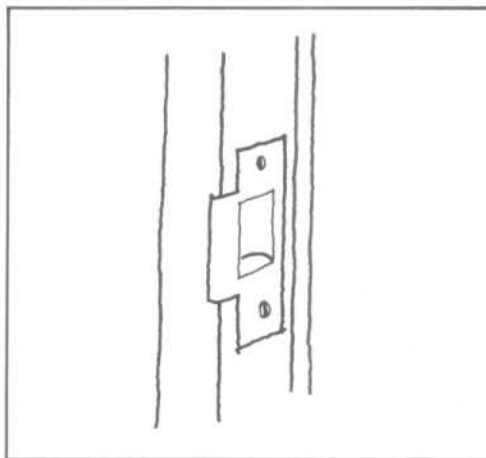


Fig. 5 Door strike.

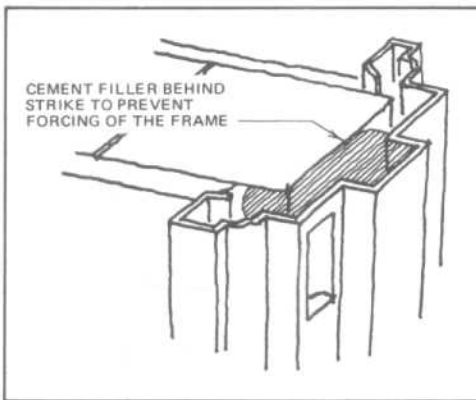


Fig. 6 Hollow metal door frame.

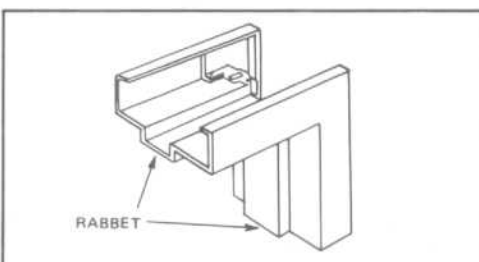


Fig. 7 Rabbeted jamb.

## SECURITY

## Doors and Hardware

For doors opening out, a flat metal plate, called an escutcheon plate, can be mounted to the face of the door in the area of the lock. This plate, which extends beyond the edge of the door and fits flush with the jamb when the door is closed, will protect the lock from attack in the area of the strike (see Fig. 9).

All plates located on the outsides of doors should be attached with tamper-resistant connectors such as round-headed carriage bolts or one-way screws.

**Door Hinges and Closers**

Spring hinges close the door automatically by using spring force. A spring hinge prevents a

criminal from slipping in behind a resident who has neglected to close the door immediately upon entering. Also, spring hinges prevent the resident from leaving the door open when he exits. Door closers (see Fig. 10) serve the same purpose. These are for more heavy duty and are commonly used in lobbies and commercial facilities.

Hinges should be mounted on the inside of the door so that burglars cannot remove the door from the hinges to enter. If hinges must be placed on the outside, they should have nonremovable pins. Pins can be made nonremovable by peening the straight end or by drilling and tapping a machine screw into the

middle portion of each pin from the inside of the open hinge (see Fig. 11). Doors with outside hinge pins can also be protected by screwing two screws halfway into the jamb edge of the door. One screw is placed near each hinge, and a receiving hole is drilled into the jamb for each screw. These protruding screws hold the door when it is closed, even if the hinge pins are removed.

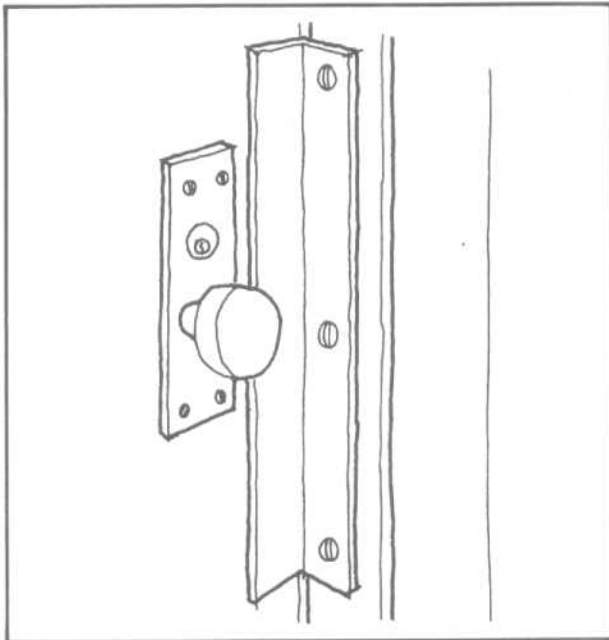


Fig. 8 Protective angle-iron for doors opening in.

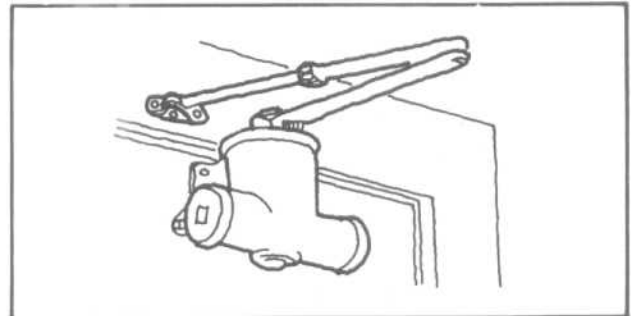


Fig. 10 Door closer.

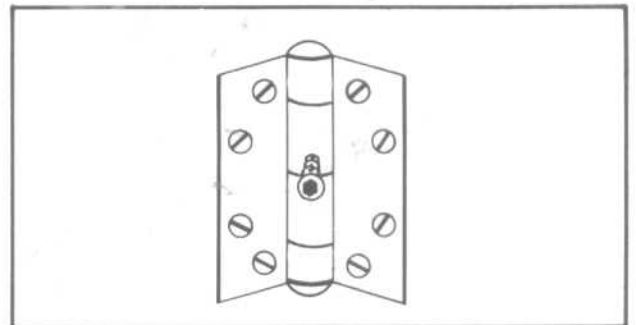


Fig. 11 Nonremovable hinge pin.

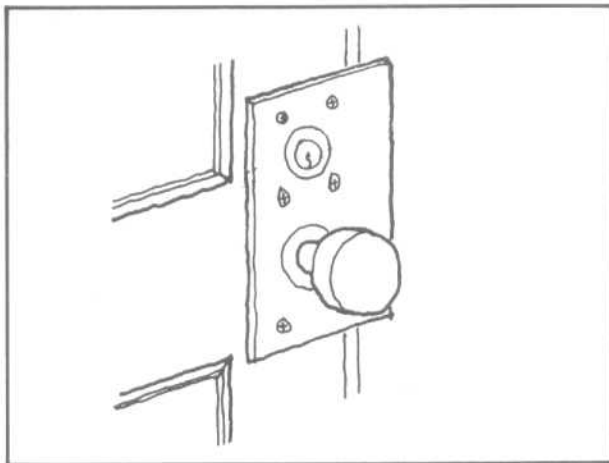


Fig. 9 Escutcheon plate for doors opening out.



## Door Locks

Locks must withstand or seriously delay not only a simple forced entry but also sophisticated criminal attack. Locks may also guard against window entry-door exit crimes.

Parts of the a lock are defined as follows:

**Cylinder:** A cylinder is that part of the lock into which the key is inserted. If the proper key is used, the cylinder will allow the key to turn, thus moving a bolt or latch.

**Deadbolt:** A deadbolt (or bolt lock) is a heavy metal bar which moves horizontally into the strike of the door jamb, thus locking the two together. It is called a deadbolt because it cannot be pushed back unless the knob is turned by the correct key.

**Latch:** A latch (or spring lock) is the part of the lock that keeps the door in a closed position by extending into the strike automatically when the door is closed. The latch is most often operated by the doorknob. Most latches can be pushed back by external pressure without having to turn the doorknob.

**Deadlatch:** In a deadlatch, the latch is positively held in the projected position by an automatic mechanism which is depressed against the strike plate (see Fig. 12).

**Strike:** The strike is the portion of the jamb where a metal plate has been placed to receive the deadbolt and/or the latch (see Fig. 5).

**Stopworks:** Stopworks consist of two buttons located under the latch. Pressing the top button in allows the doorknob to turn freely and operate the latch, from both inside and out. Pressing the lower button in allows the inside doorknob to operate the latch, but "freezes" the outside doorknob.

**Throw:** The throw of a lock is the length (in inches) that the deadbolt extends beyond the face of the lock.

**Primary locks** Primary locks operate in conjunction with the latch. There are two major types: mortise locks and cylindrical or bore-in tubular locks (commonly called key-in-the-knob locks).

Mortise locks (see Fig. 13) are more common than key-in-the-knob locks and will provide good security. All mortise locks with latches should contain a deadbolt with at least a 1-inch throw constructed of case-hardened steel, brass or zinc alloy, or bronze. Federal FF-H 106a heavy-duty series 86 mortise locks or 185 latch and 190K modified deadbolts are recommended. The deadbolt and latch should be key-operated from the exterior and operated from the inside by a device not requiring a key.

Mortise locks with latches used in residences should not contain an automatic spring latch with stopworks. Although stopworks prevent the outside knob from being turned, they leave the premises open to easy entry because they do not prevent the latch from being pushed back. An intruder need only insert a credit card into the strike area, push back the spring latch, and open the door (called "loiding" or "shimming" the lock). In locks without stopworks, the deadbolt (which cannot be loided) must be thrown by the key of the resident. Eliminating the stopworks prevents the resident from relying on the stopwork and latch mechanism alone.

Key-in-the-knob locks (see Fig. 14) are less secure than mortise locks. Although inex-

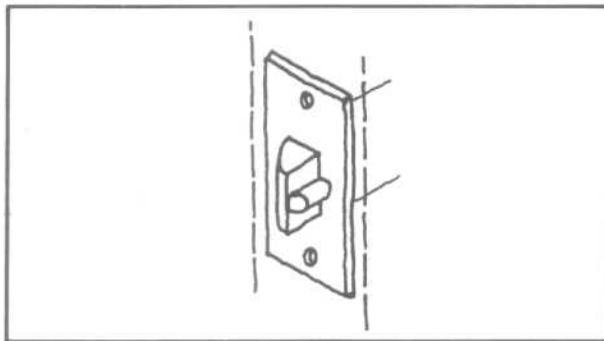


Fig. 12 Deadlatch.

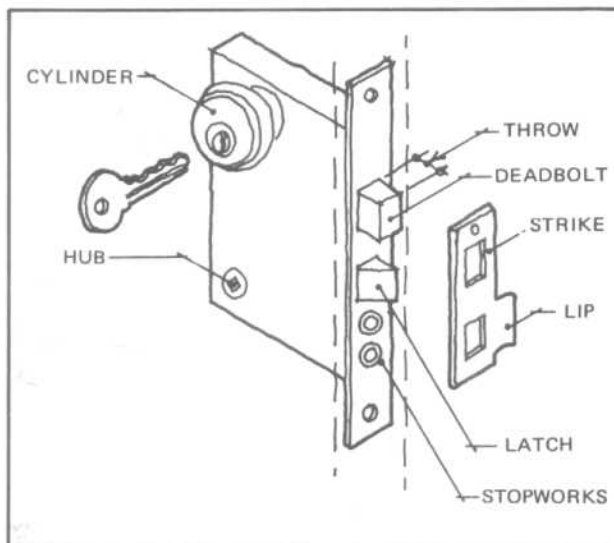


Fig. 13 Mortise lock.

pensive due to easy installation, key-in-the-knob locks can be easily gripped by a tool and twisted until they break. A key-in-the-knob lock can include a deadbolt, at a comparable to slightly higher price than a mortise lock.

**Secondary locks** A secondary lock (rim lock) operates independently of the latch. "Secondary" is perhaps a poor name, since this type of lock is essential for good security. Secondary locks are usually mounted above the primary lock at shoulder level. They are operated by a key from the outside, and by a turnbolt from the inside. Both mortise and secondary locks may require keys to open them from inside and outside—useful where access to premises may be gained through a small opening other than the door (window transom), since this will prevent the thief from using the door to remove large objects or to escape.

There are three major types of secondary locks: spring bolt, horizontal deadbolt, and vertical deadbolt. The spring bolt lock operates much the same as the primary door latch. Because the bolt must be spring loaded and bevelled to allow automatic latching, the bolt can be easily opened. A button (slide stop) may be set to deadlock the bolt. However, the button must be set from the

inside and can only be used when another means of egress is available. The spring bolt is not recommended as a secondary lock (see Fig. 15).

Horizontal bolt rim locks operate much the same as deadbolts on primary locks. While horizontal deadbolts afford much better protection than spring bolts, they still can be easily overcome. By inserting a crowbar between the door and the jamb, the intruder can pry them apart to release the bolt from the strike. For this reason, the longer the throw of the deadbolt, the greater protection it affords. However, throws of over 1½ inches may have excessive cantilever. The recommended minimum throw is 1 inch (see Fig. 16).

Vertical bolt deadlocks should be used as secondary locks wherever possible. These utilize two deadbolts that fit vertically into eyeholes or sockets attached to the jamb. This creates a firm bond between the door and the jamb. The vertical bolt deadlock made by Segal is highly recommended, both for its pressed-steel construction and for its ability to hold up under heavy use (see Fig. 17). For additional security, a pick-resistant cylinder should be installed in a good vertical deadbolt body. This combination provides excellent security.

SECURITY

Doors and Hardware

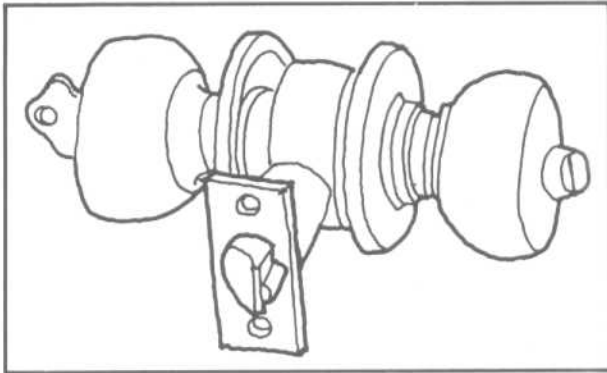


Fig. 14. Key-in-knob lock.

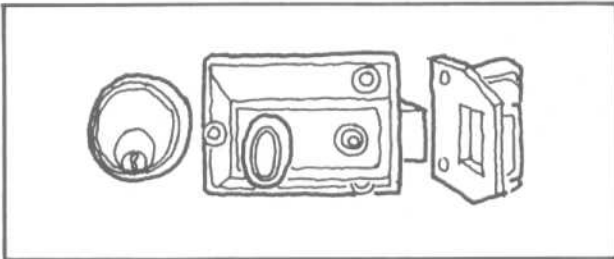


Fig. 15 Spring bolt.

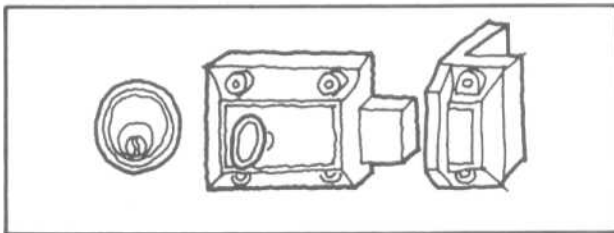


Fig. 16 Horizontal bolt.

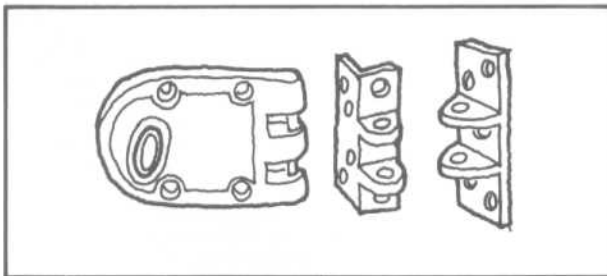


Fig. 17 Vertical bolt.

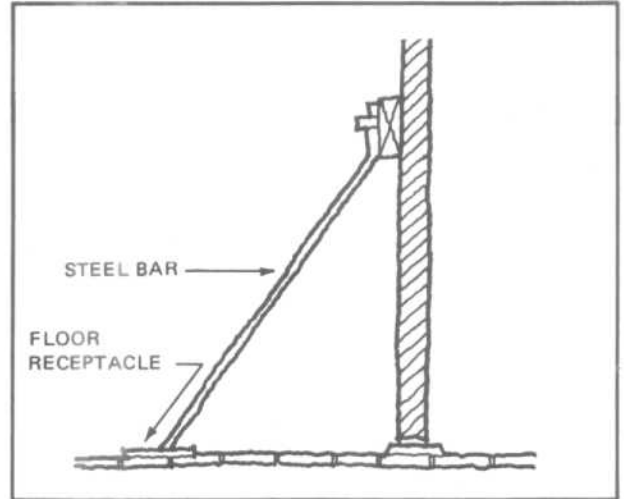


Fig. 18 Buttress door lock.

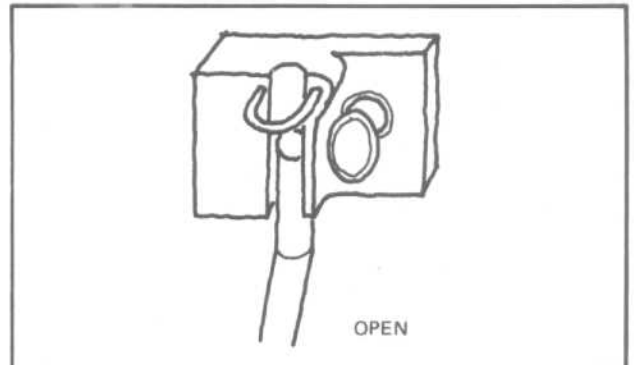


Fig. 19 "Magic Eye" lock with thumb turn.

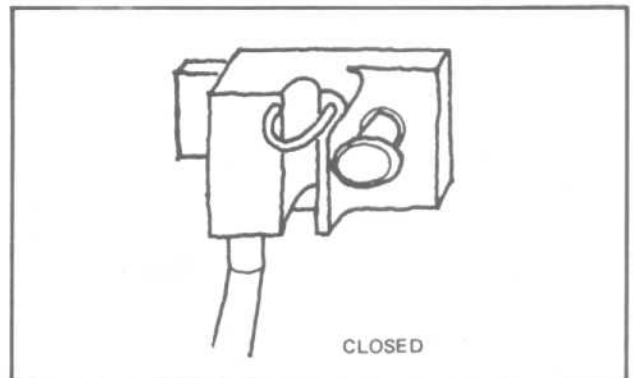


Fig. 20 Buttress door lock with deadbolt.

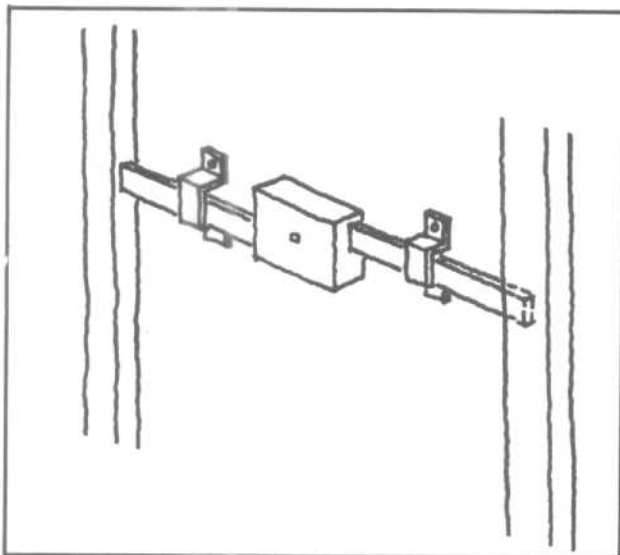


Fig. 21 Double-bar lock.

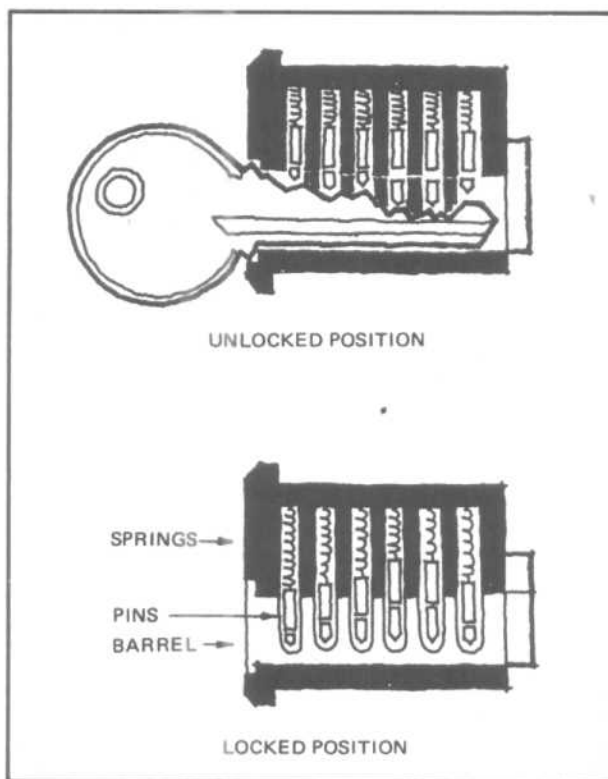


Fig. 22 Cylinders.

The locks discussed so far rely on the rigidity of an existing door frame to resist attacks on the lock. Since older buildings may contain weak door frames, a buttress-type door lock is advisable. Locks of this type include a bar set against a plate on the door and into a receptacle in the floor, thus forming a triangular buttress (see Fig. 18). Most of these locks can be operated only by a key from the outside. The Magic Eye Company buttress lock can be operated from the outside by a key and from the inside by a turnbolt to prevent accidental locking (see Fig. 19). One model contains a heavy-duty deadbolt as well as the buttress bar, and affords still further protection (see Fig. 20).

The double-bar lock may also be used to increase the strength of a door, by means of two steel bars that extend up to 2½ inches into each side of the jamb (see Fig. 21). The cylinder is protected on the outside by an escutcheon plate to prevent forcible removal. A pick-resistant cylinder can be installed for added protection. The Fox Police Lock and the Fichet Locking Bar are examples of high-quality double-bar locks.

**Cylinders** Regardless of the type of lock purchased, the cylinder is critical in providing protection. It must withstand efforts by sophisticated criminals such as lock pick experts.

The cylinder is the part of the lock into which the key is inserted. The most common type of cylinder is the pin tumbler which operates as follows: As the key is inserted, spring-loaded pins are raised to the proper position to allow the barrel and the key to turn; the turning causes the bolt or latch (or both) to move. If the wrong key is used, the pins will line up incorrectly and prevent the barrel from turning (see Fig. 22).

Recently, cylinders have become available which utilize special keyways and keys to make the cylinder pick proof or pick resistant (see Fig. 23). Medeco, Illinois Duo, Sargent, Keso, Eagle Three Star, Mela, Fichet, and Miracle Magnetic are highly pick resistant. Such cylinders provide improved security, but may require registered keys that can be duplicated only at the factory upon receipt of a signed request. A compromise is the use of a key type whose blank is not available normally, but for which spare blanks are kept for replacements.

Of all cylinders on the market, Medeco has proven most difficult to overcome. Medeco utilizes twisting tumblers operated by a key with angular or criss-cross cuts. Only if the proper key is inserted will the pins twist the exact amount needed to allow the barrel to turn.

If special keyway cylinders are deemed unnecessarily secure or costly (Medeco cylinders cost about two times the next adequate), the cylinder used should be of solid-bar-stock bronze and machined for a tight fit.

The cylinders of a master-key system of locks are constructed so that individual keys fit only one lock, but a single master key can open all locks in the system. Use of a master-key system makes maintenance and other authorized access simpler, but the dangers of improper use of a lost or stolen master key far outweigh the benefits.

From a security standpoint, a cylinder should have at least six pins. This often results in the cylinder being longer than the

## SECURITY

## Doors and Hardware

thickness of the door. In mortise locks (which are recessed into doors), a six-pin cylinder often extends slightly beyond the surface of the door, thus making it susceptible to forcible removal by use of a gripping tool. To prevent use of such a tool, protruding cylinders should be protected by one of the following:

**Spinner ring:** A hardened steel ring that forms a collar around the cylinder and which spins freely around the cylinder when gripped (see Fig. 24).

**Bevelled-ring cylinder guard:** A case-hardened steel ring that prevents the cylinder from being gripped by a tool because of its bevelled shape (see Fig. 25). Scotsman makes a flat, very secure, cylinder guard ring.

**Escutcheon plate:** A metal plate mounted to the door, which covers all of the cylinder except the core (the part where the key is inserted), thus protecting the cylinder from attack. The escutcheon plate should be constructed of malleable cast iron and attached to the door with one-way screws. Machine bolts should not be used to mount escutcheon plates on mortise locks, as the increased pressure can have an adverse effect on the mechanism (see Fig. 26).

## Sliding Doors

Sliding doors opening onto a ground-level patio or accessible balcony (on the first floor or top floor, or adjacent to other balconies) should be constructed so the movable section of the door slides on the inside of the fixed portion. Sliding doors should be break resistant (plate glass) and equipped with a vertical-bolt Segal lock (see Fig. 27), which uses a hook-type bolt to grip door and frame together, or a Loxem Sli-door lock that hoods at top and bottom (see Fig. 28).

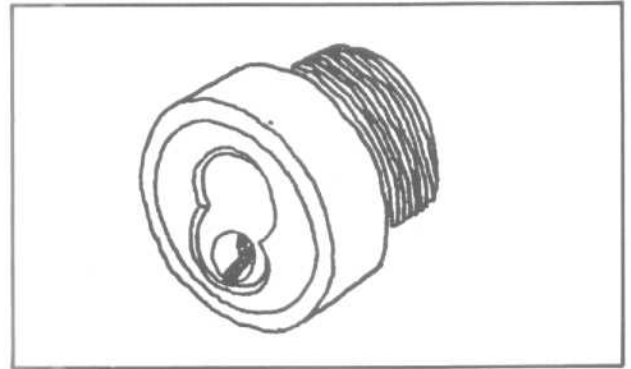


Fig. 24 Spinner ring.

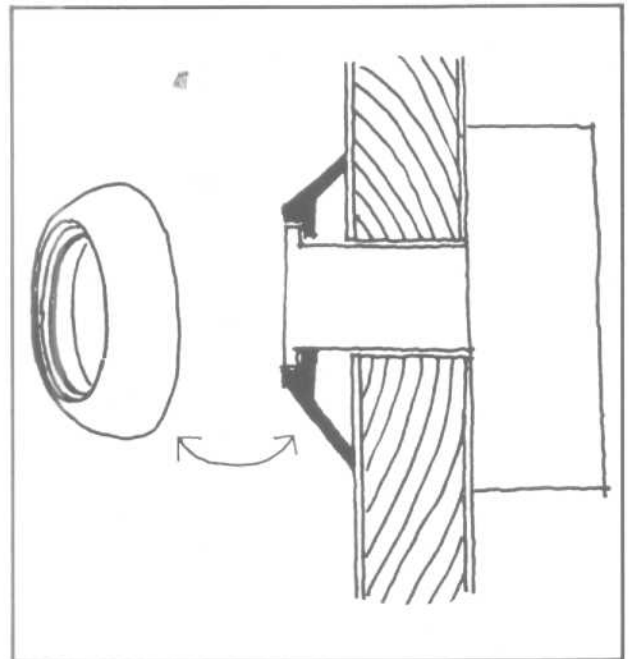
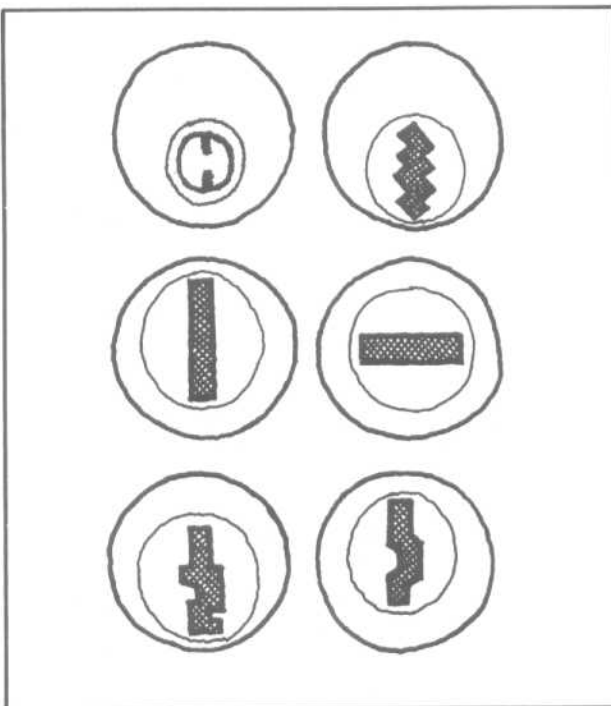


Fig. 25 Bevelled ring.



984 Fig. 23 Keyways.

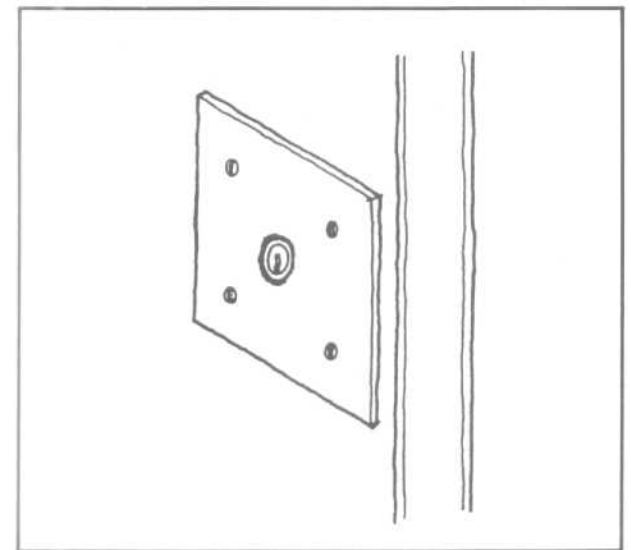


Fig. 26 Escutcheon plate covering cylinder mortise lock.

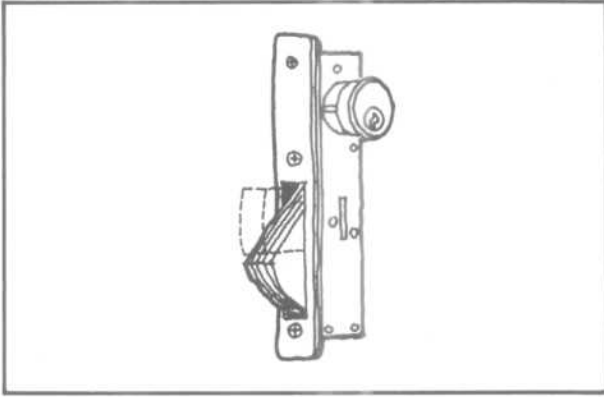


Fig. 27 Segal lock.

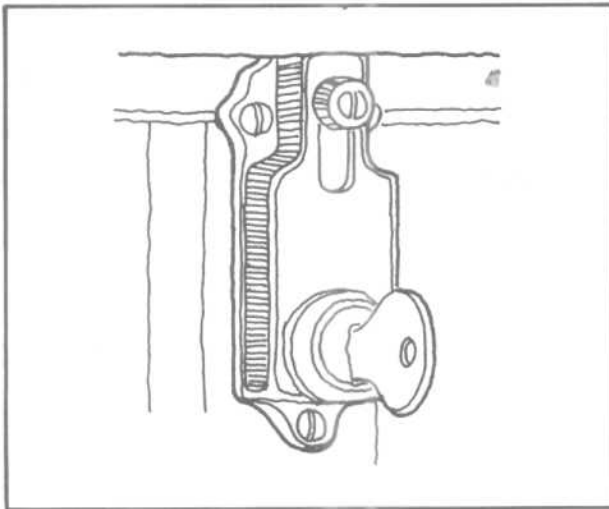


Fig. 28 Loxem Sli-door lock.

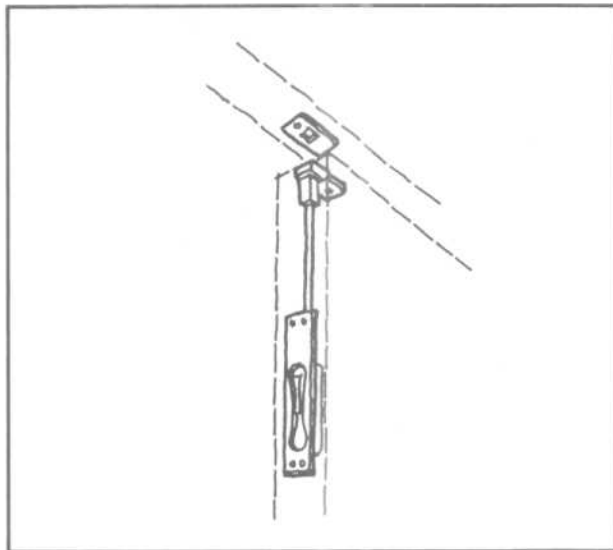


Fig. 29 Flush bolt on double door.

### Doors with Large Glass Panels

Exterior doors containing panes of glass are not recommended for security. French doors that open out should have hinges with nonremovable pins. The vertical stile incorporating the lock should withstand a concentrated horizontal load of 300 pounds. The doors should contain a mortise-type lock that is key operated from the inside and outside. The lock should contain a pin-tumbler cylinder with at least six pins (a pick-resistant cylinder can be used for extra protection).

Even when fitted with key-operated locks inside and outside, doors with large panes of glass are a security problem. Use of break-resistant glass substitutes is one modification. Bars or metal grilles, while providing good security, may be aesthetically unacceptable. Alarms may also be used on these vulnerable doors.

### Double Doors

On double doors, the active leaf should be equipped with a mortise-type lock. The inactive leaf should be equipped with flush bolts with at least a  $\frac{3}{4}$ -inch throw at head and foot (see Fig. 24).

### Private Garage Doors

Many rolling overhead doors operated by electric motors offer adequate security because the motors are controlled by a key switch inside the garage or by a low-power radio transmitter. Manually operated doors should be provided with slide bolts on the bottom bar (see Fig. 30). Chair-operated doors should be provided with a cast-iron keeper and pin for securing the hardened-steel chain.

### Door Interviewers

Interviewers are devices installed on an opaque door to allow residents to see and hear who is outside the door without opening it.

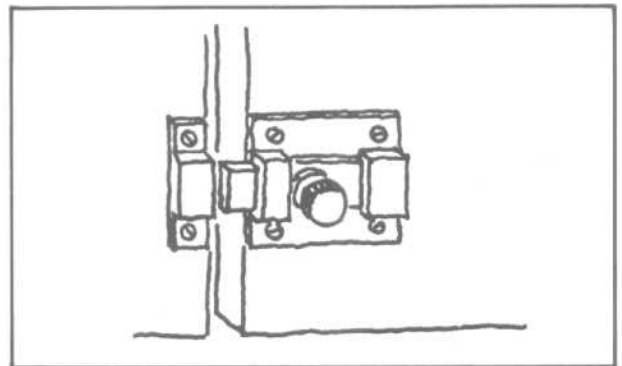


Fig. 30 Slide bolt on garage door.

## SECURITY

## Doors and Hardware; Windows and Hardware

An optical interviewer (peephole) should be installed on each door that provides entry into private dwellings. Many types of interviewers are available, ranging in diameter from two-tenths of an inch to 3 inches. Optics of the interviewer include one-way glass, plastic, and wide-angle glass.

Interviewers with openings of over one-quarter of an inch are not recommended. Larger interviewers can easily be punched out to allow insertion of tools to open the door from the inside. Someone also may stick a knife, wire, or gun through the hole while the person is looking through it. Interviewers are located approximately 4 feet 9 inches from the floor (see Fig. 31). The best interviewers contain a double glass for safety. Wide-angle glass allows maximum visibility. Although a wide-angle lens does produce a curved, "fisheye" image, clarity of the image is not impaired. If wide-angle glass is not used, the person outside cannot be seen unless he is standing in a direct line with the interviewer (see Fig. 32).

Instead of an optical interviewer, a case-hardened steel chain which fits into a horizontally mounted slide track on one end of the door jamb may be installed (see Fig. 33). The chain allows the door to open slightly (preferably not more than 2 inches) to permit easy conversation without fully unlocking the door. These chains should be used for interviewing only, not to protect a locked door. The swing of the door, even if only 2 inches, allows the criminal to exert strong force with momentum, which breaks most chain devices. The interviewing space also allows insertion and use of tools. Some slide chains have a locking mechanism which prevents use of a thumb tack (or piece of tape) and rubber band to pull back the slide mechanism and remove the chain from the track. Even when equipped with a locking mechanism, steel chains and slides are readily overcome by simple tools and brute force.

**Window Materials**

Because windows contain large sections of glass, they naturally impose a security problem. Windows most vulnerable are those on the first floor (or otherwise accessible from the ground) and those leading to fire escapes. Less vulnerable, but still easily reached, are windows over a canopy (as above a main entrance), windows adjacent to stairwell windows, and windows on the top floor.

**Window Locks**

Among the common window locks are the crescent sash lock, often standard on residential windows; various friction or pressure devices, such as the thumb-screw latch; pin-type latches, such as the simple steel pin-in-the-hole device; and the slide-bolt latch. All of these devices can easily be overcome, especially if an intruder is willing to risk the noise of breaking a small section of the glass. (See Figs. 34, 35, 36, and 37.)

Normal windowpane glass is approximately one-eighth of an inch thick, extremely brittle, and breaks easily. Plate glass is usually one-quarter of an inch thick and tempered to withstand an accidental knock. Plate glass is used for larger areas because of its greater strength and because the initial cost is worth the extra protection. Tempered

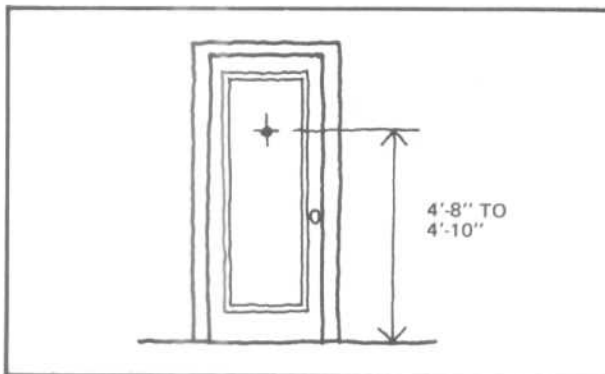


Fig. 31 Interviewer location.

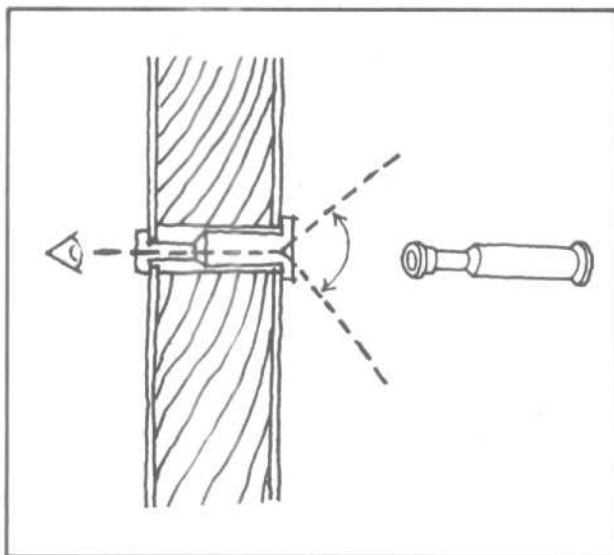


Fig. 32 Interviewer angles.

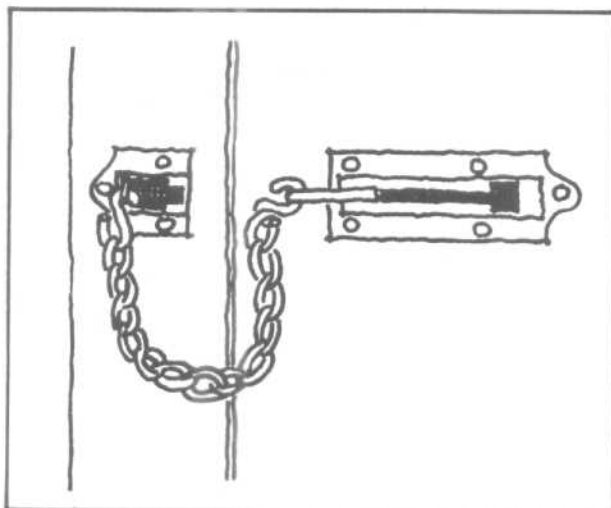


Fig. 33 Chain lock.

glass has a thin, hardening coating and, while no stronger than plate glass, will not cut someone who breaks it.

Several companies have developed unbreakable, transparent polycarbonate materials which look like glass but are very difficult to break. GE's Lexan, for example, is guaranteed unbreakable. It costs two to three times as much as glass and has low resistance to scratching. An improved material, Lexan MR-4000, is slightly more expensive but is much less easily scratched. These polycarbonate materials have not yet been extensively used for private dwellings.

Another type of durable "glass" is fabri-

cated much like the safety glass used in automobiles: two layers of high-quality glass are bonded together with a layer of tough vinyl between. This is sold by one company as Secur-lite. While Secur-lite can eventually be broken, the noise and trouble required to do so are considerable deterrents.

Oversized glazed areas should be avoided. Anything beyond standard size (6 feet by 8 feet for glass, for example) is expensive and may be difficult to obtain.

The only reliable devices are those with a key-operated locking mechanism. Yale and Ideal Security manufacture a window lock which is a modification of the pin-type lock. It

can be locked in either of two positions, one of which allows the window to be open slightly at the bottom for ventilation (see Fig. 38). Fox makes a window lock combining a pin-type lock and a hasp and padlock. Although somewhat unsightly, it provides excellent protection. Ideal Security manufactures a modification of the crescent sash lock which requires a key to operate.

All of these devices provide adequate security for normal residential use. A set of keys should be convenient to the window for use in emergencies but far enough away so that a burglar cannot reach them.

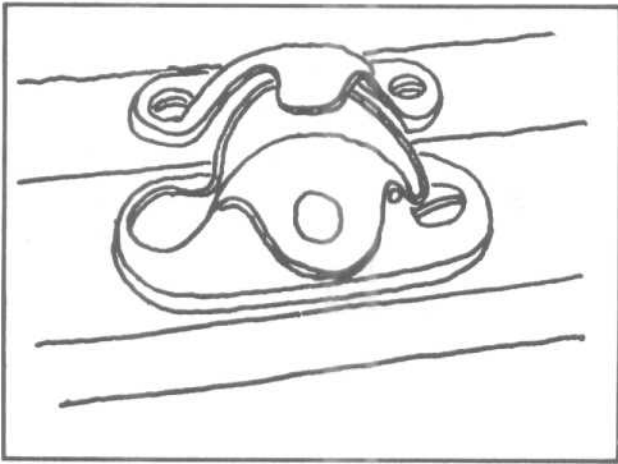


Fig. 34 Crescent sash lock.

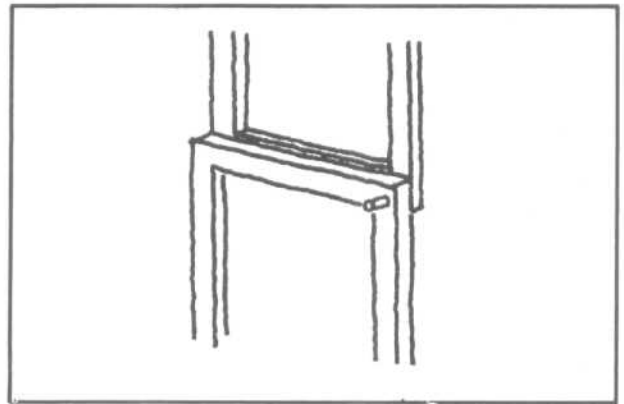


Fig. 36 Pin latch.

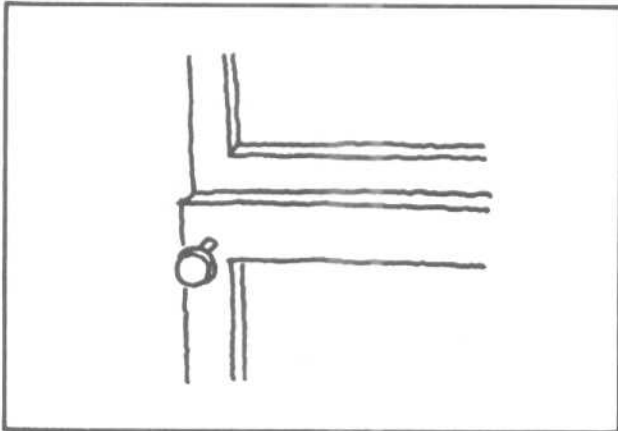


Fig. 35 Thumb screw lock

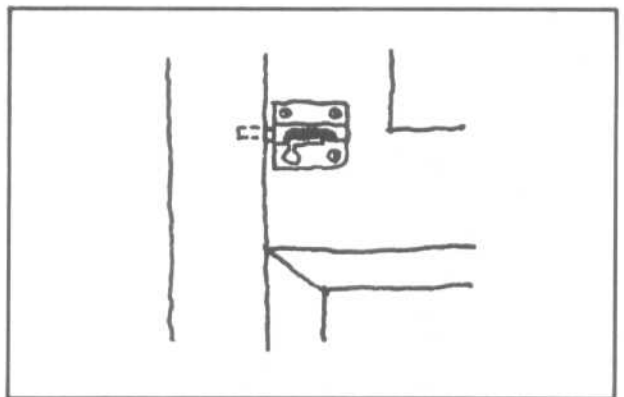


Fig. 37 Slide bolt.



## SECURITY

## Windows and Hardware

**Window Bars, Grilles, and Gates**

Where tighter security is desired, metal bars, grilles, and gates have proven most reliable. If a wire mesh grille is used, the metal should be at least one-eighth of an inch in diameter and the openings should not exceed 2 inches (see Figs. 39 and 40). The grille should be attached to the window frame with machine or roundhead bolts which cannot be removed from the outside.

If bars are used, they should be placed not more than 5 inches apart. The bars should have a diameter of at least three-quarters of an inch and be set at least 3 inches into the masonry.

Sliding gates afford excellent protection and can be pushed aside or opened for emergency exit. The gates should be set in tracks on the top and bottom to prevent them from being pulled or pried away from the window (see Fig. 41). Protect-A-Guard gates are highly recommended for residential and commercial use.

All of these devices should be installed inside the window for maximum security.

**Skylights**

The best protection for skylights is installation of metal bars, grilles, or mesh. Bars should be made of steel not less than three quarters of an inch in diameter and should be placed not more than 5 inches apart (see Fig. 42). If mesh is used, it should be at least one-eighth of an inch thick and the spaces should not be greater than 2 inches. Mesh should be secured firmly by machine or roundhead bolts that cannot be removed from the outside.

If metal is undesirable, a securely fastened hasp and padlock will discourage entry and exit through the roof, if the glass is not removed.

Both hook-in-eye and sliding-bolt devices are unacceptable security measures for skylights.



Fig. 38 Keyed window lock.

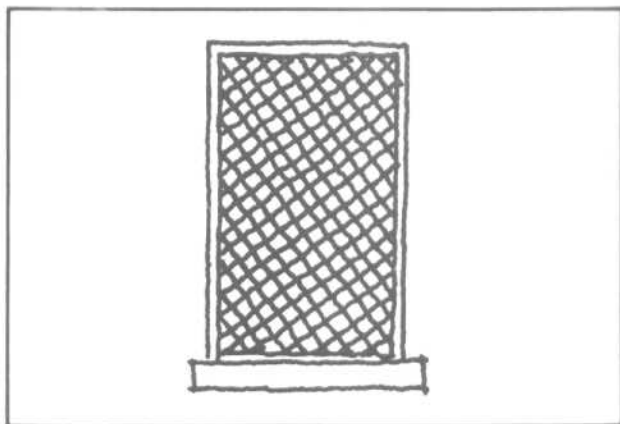


Fig. 39 Mesh window grille.

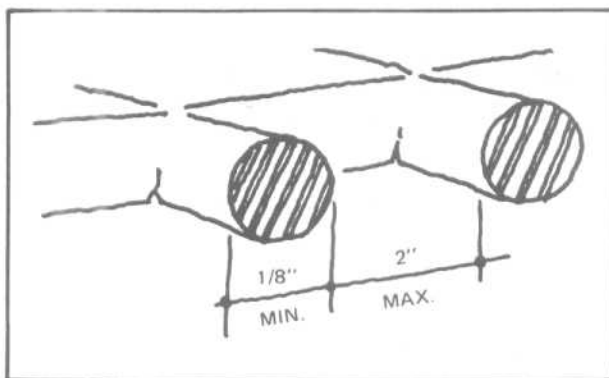


Fig. 40 Wire mesh dimensions.

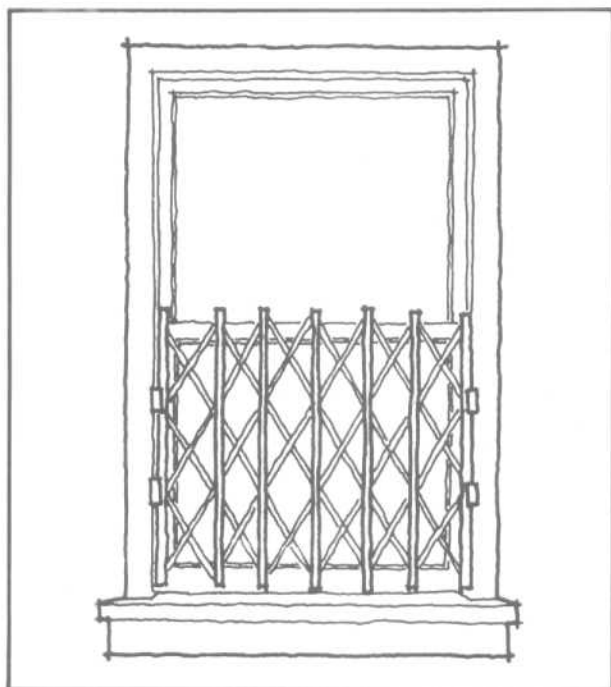


Fig. 41 Window guard.



## MULTIFAMILY DWELLINGS

### Lobby Doors and Walls

All lobby entrance doors should provide maximum visibility of the lobby. This often requires large glass areas in the lobby doors. Where there is a high degree of vandalism and crime, use of Lexan is recommended. In all cases, oversized glass sheet should be avoided. Glazed areas should be divided so that sheets larger than 6 by 8 feet are not needed. The doorframe should be constructed of rugged, heavy-duty metal. The vertical jamb incorporating the lock should withstand a concentrated load of 500 pounds and be a minimum of 5 inches thick so that it can receive heavy-duty mortise lock sets.

The main outer lobby door should have a key-operated lock with a pin-tumbler cylinder containing at least six pins. The key for this lock should not open any other door (such as an apartment door) as this makes the lobby-door cylinder susceptible to picking. An anti-friction latch (see Fig. 43) and a sturdy door closer should be used in conjunction with the lock.

Lobby doors, especially if locked or equipped with intercoms, should open out for fire safety and to reduce vandalism (tenants who have misplaced their keys can kick an in-swinging door hard enough to break the locking mechanism).

### Secondary Exits

In multifamily dwellings, exit doors leading to fire stairwells on each landing should have self-locking deadlatches to allow free egress while prohibiting entry. The stairside surface of the door should be free of hardware to prevent access to one floor from another via the stairwell. Hardware should limit access to the roof or ground-floor exits via the stairwell.

Panic hardware, if required, should be in the form of vertical-bolt latches on the top and bottom of the door. This hardware makes the door more sturdy and makes entry from the outside difficult (see Fig. 44).

Doors leading into the buildings from garage areas should have self-locking deadlatches with a minimum throw of one-half inch that allow free egress but require a key for entry into the building. The door should be protected in the area of the strike. All exit doors should be equipped with a self-closing apparatus that can be adjusted to the desired tension.

Since fire doors are required by law to be operable from the inside, they are often a means of escape. Exit alarms (see Fig. 45) bring immediate attention to fire doors that are opened when there is no apparent fire. A panic bar or other device simultaneously opens the door and sounds a local alarm. However, effectiveness of the alarm as a security measure depends upon the speed and consistence of response to the signal.

Exit alarms on fire exits leading to roofs keep burglars from using the roof for escape or for access to top-floor apartments. However, the alarm may prove more a nuisance than a good security measure if teenage vandalism is prevalent. Teenagers often set off the alarm to harass the local official, who must respond to the signal and reset the alarm.

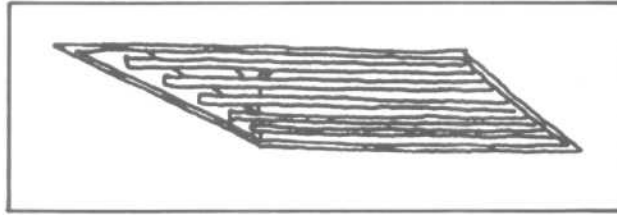


Fig. 42 Skylight protection.

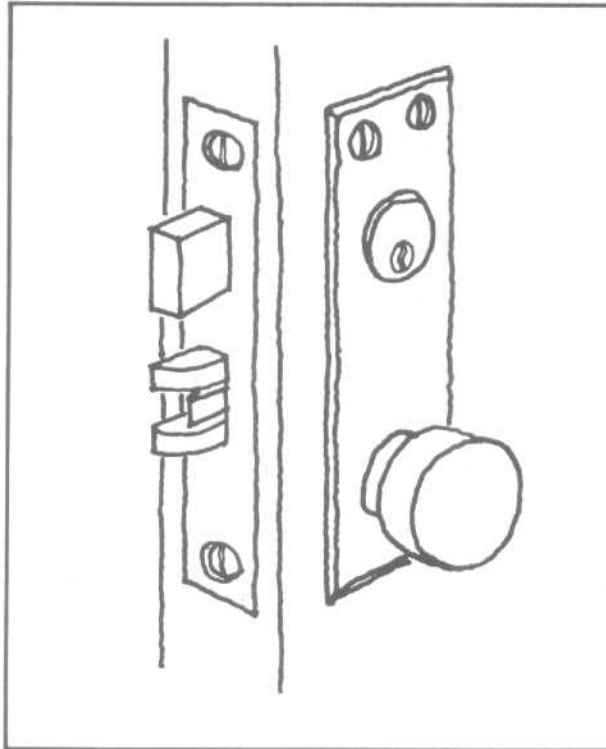


Fig. 43 Antifriction latch bolt.

## Elevators

In most middle-income multifamily dwellings, vandalism of elevators is relatively rare. However, in many high-crime areas and low-income housing developments, this vandalism is reaching a critical level. In New York City Housing Authority projects, vandalism to elevators and elevator equipment is responsible for almost 60 percent of elevator outages. Parts of the elevator most commonly vandalized are the hall buttons, indicator lights, hatch door glass, hatch door interlock, and buttons located inside the cab, especially the emergency and light switches.

Hall buttons are most commonly vandalized because of their accessibility. Impatient tenants push the buttons excessively and often kick or smash them in frustration. To prevent damage to the button and the electrical contacts inside, a stainless steel mushroom-type button should be used (see Fig. 46). The shape of the button prevents the contacts from being damaged by the button's being pushed too heavily against them. Another stainless steel button has been devel-

oped on the same principle, except that the stopper is inside the mechanism so that the button has the more familiar stunted-cone appearance.

Use of indicator lights for the lobby, the cab, and the other floors should be decided by the management. In some projects, indicator lights are so vandalized that it is easier to eliminate them. In other developments, indicator lights dampen user impatience and the result is less wear and tear on the buttons. If indicator lights are used, they should be protected by a heavy-duty plastic shield.

There are two types of elevator doors: swing and slide. This nomenclature refers to the doors on each floor; the cab door is always a slide door. Slide doors, which are automatic, are becoming increasingly popular despite higher initial cost, because they increase protection against vandalism. Swing doors are inconvenient and more subject to vandalism (short-circuiting of door interlocks, jamming of closing mechanisms, and joyriding on top of cabs).

## SECURITY

## Elevators

In many older elevators (especially the swing-door type), the hatch and cab door contain small glass windows which allow people to see inside before entering and allow passengers to see what floor they're passing. In high-crime areas, this glass has proven more dangerous than helpful. Vandals smash the glass readily, even if wire glass is used. The opening left when the glass is broken presents a very dangerous situation. Hatch door glass should be eliminated by welding or bolting a piece of metal over the opening. Where this is prohibited by a strict building code, a variance is often granted in a high-crime area. A less desirable modification is to install a heavy steel grille over the opening and replace the glass with Lexan.

Interlocks are more commonly vandalized on swing-door elevators. Causes of damage are excessive pulling on the elevator door while the cab is at another floor and short circuiting due to water or urine damage. The latter problem can be solved by installing interlocks with hydrophilic (non-water-absorbing) contacts. When damaged, this type of interlock requires replacement of only the contact plates rather than the entire mechanism. Damage caused by excessive pulling may be alleviated by signs cautioning tenants against such pulling. Closing mechanisms (keepers) can be made to fit more securely when the bolt is in place to prevent too much play in the door.

The emergency stop button presents a

problem because it is often misused. The button may be activated to stop the elevator between floors to commit crimes such as mugging, rape, and drug abuse. Because every elevator has several automatic safety mechanisms that prevent it from falling freely down the shaft, the stop button is primarily a psychological comfort to passengers. Wherever possible, the stop button should be eliminated. The building code requirement for stop buttons is being challenged in New York and several other cities. If code change is unlikely, a variance should be applied for where elevator crime is common. A constant-pressure alarm switch is also somewhat better than the conventional toggle switch.

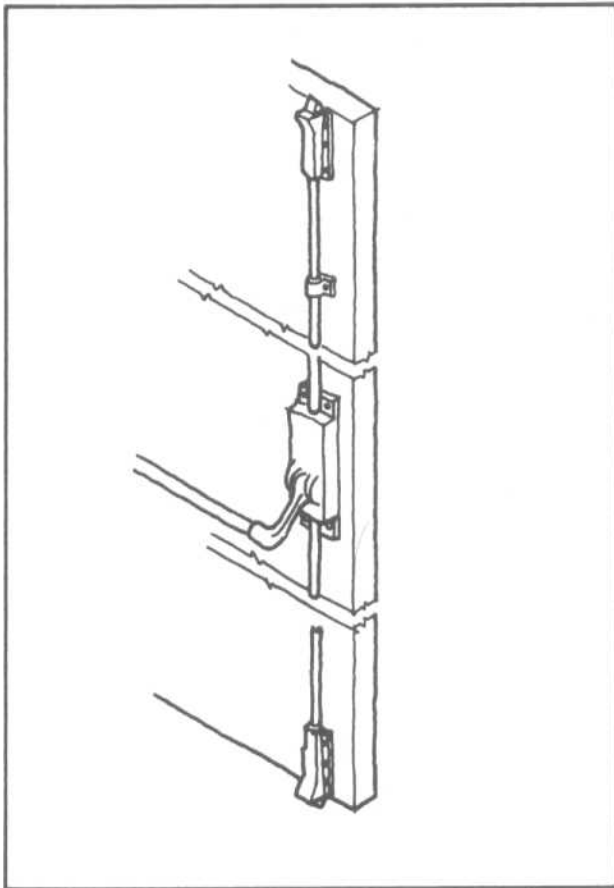


Fig. 44 Vertical bolt on exit door.

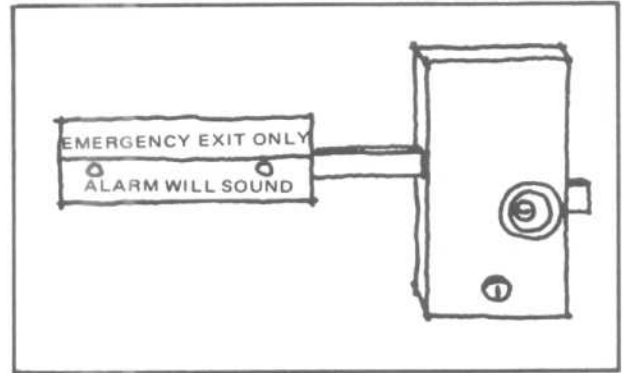


Fig. 45 Exit alarm.

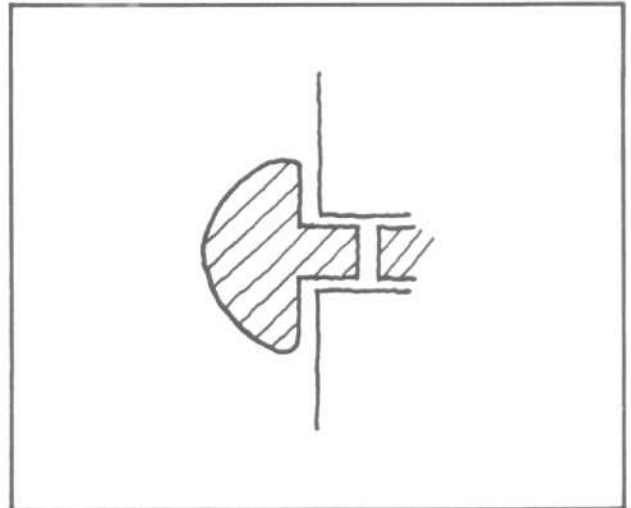


Fig. 46 Mushroom button.

Secer Light and Kendall are among the manufacturers of elevator dome lights that are highly vandal resistant (see Fig. 47). They are constructed of durable steel and contain a shatterproof plastic plate to protect the bulb. Where use of these lights is economically prohibitive, Lexan or an equivalent should be used to protect the light bulb.

Aside from vandalism, joyriding on top of elevator cabs is becoming prevalent in high-crime areas. Injury occurs most often when children are struck by the counterweight when the cab and counterweight pass each other. In other cases, children are crushed between cabs, struck by dividing beams, or squashed under a cab in the pit.

There are numerous means of access to elevator roofs and shafts: door interlocks are jammed by using simple household tools;

emergency stop switches are abused; and roof escape hatch doors are forced. Once on top, children often abuse passengers inside the cabs and interfere with normal elevator operation.

It is difficult to prevent crime by modifying elevator equipment. Restricted access to the building through the use of a buzzer-reply system, tenant patrol groups, or doormen is more likely to be effective. Closed-circuit television and audio-intercom systems mounted on elevators are other possible crime control devices.

A common device used to increase visibility in an elevator is a convex mirror placed in the upper back corner of the elevator. This allows a person to see if anyone is waiting inside the elevator *before* he walks into a possible assault situation (see Fig. 48).

An elevator modification that may deter crime is the up-discharge, down-collect system. When controlled in this way, an elevator will only stop for a person who has selected "up" (discharge) at the ground-floor level. Passengers on the upper floor can only enter the elevator on its way down (collect). The advantage is that a person entering the elevator on the first floor can be assured that the elevator will not stop at another floor to allow a suspicious person to enter. Such a system may be inconvenient for residents—a person wishing to go from the fifth to the seventh floor would have to travel down to the ground floor and then up again. The system is far from foolproof, as criminals can operate in other ways; but the modification is inexpensive and may deter crime in buildings without security personnel.

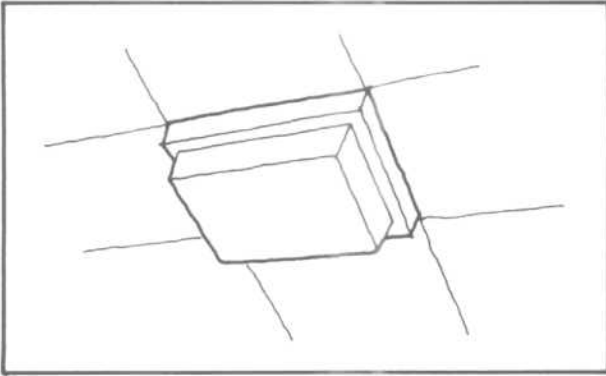


Fig. 47 Unbreakable light fixture.

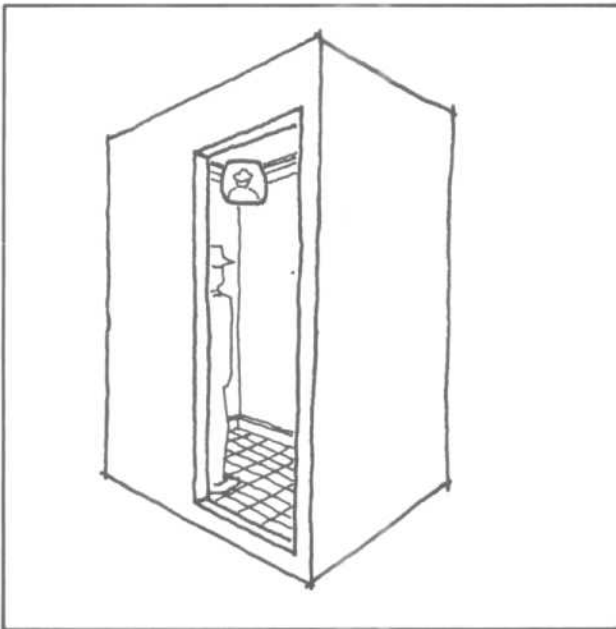


Fig. 48 Elevator mirror.

**SECURITY****Garages, Secondary Entries, and Mailbox Rooms****Garage Doors and Secondary Entries**

Doors to interior garages provide a means of entry that circumvents many security precautions. If access to the building is to be limited, entry through the garage door must be carefully controlled.

The most practical solution is to have a locked door which tenants can open but which automatically closes behind them, usually within 15 seconds. A large number of manufacturers provide such self-closing doors. The major variation is the means for opening the garage door. Radio-controlled devices, requiring each auto to have a transistor, are expensive and far from foolproof. If a device is stolen from one car, all the devices should be replaced (an expensive procedure). A convenient and less elaborate system has a key-operated switch mounted on the driver's side of the garage, allowing the driver to use a key without leaving his car.

Despite these controls, the garage door should be monitored by tenants, security personnel, or electronic equipment if a build-

ing is to retain a high level of security.

A door leading directly from a parking area to the building interior must be treated the same as a main entry. Such a door will be used continually, and requires equivalent security measures.

The secondary lock recommended for storage rooms containing valuables is the Fox double-bar lock.

**Mailboxes and Mailbox Rooms**

Mailboxes are a major target for criminals within multifamily dwellings, particularly in low-income communities. The mail includes welfare, social security, and veterans' checks as well as others. These checks are particularly vulnerable because they arrive on set days of the month.

The bank of mailboxes should be located in the most secure and easily surveyed space available. Some brands of mailboxes do provide security, but any mailbox can be opened in the 10 minutes required to force open the door. If there is any control of

access to the building (intercom or doorman), mailboxes should be located inside the protected area.

Mailboxes may be located in a locked room. Such a room must contain a large window to make it visible from the lobby, and be lighted 24 hours a day to reduce its potential as a location for muggings and other crimes. The door to a mailbox room should have sturdy self-locking hardware. Where back-loading mailboxes (generally secure) are used, a separate mail-loading room is often provided (see Fig. 49).

The better mailboxes are constructed of 16-gauge metal. The doors are tightly fitted and without holes to prevent prying them open and to prevent matches from being dropped in. The metal may be corrugated for additional strength. Cylinder locks with at least five pins should be used. Door size should be kept to a minimum to further limit the possibility of prying doors open (see Fig. 50). American and Gorth manufacture such mailboxes.

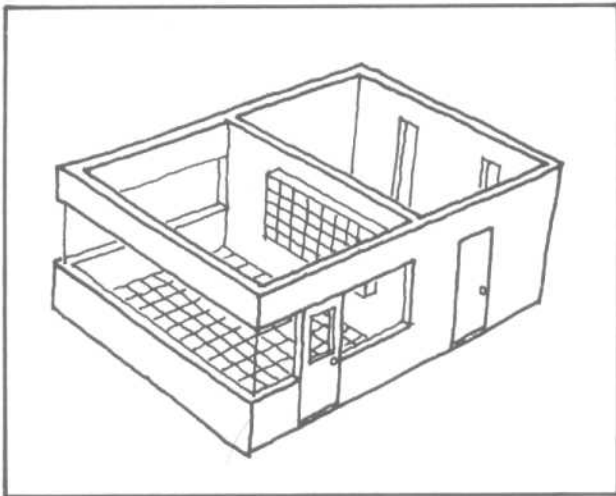


Fig. 49 Mailroom and loading room.

## LIGHTING

Good lighting in a residential development permits adequate visibility and surveillance. Generally, the higher the lighting level, the better the security. An appropriate level of lighting should be provided in each area; the light should be without excessive glare and generate no heavy shadows; and lighting should be resistant to vandalism and easy to maintain.

Fluorescent lamps are tubular glass lights that require special current-control devices called ballasts. Operating costs of fluorescent lamps are significantly lower than for incandescent bulbs: fluorescent tubes typically produce 3 to 4 times as much light per watt and operate 7 to 10 times longer than incandescent bulbs (due in part to lower operating temperatures).

### Interior Lighting

Lobbies, elevators, stairwells, and corridors must be well lit. Interior lighting normally requires only conventional incandescent bulbs, but low-glare or "frosted" incandescent or fluorescent luminaries are preferable. Low wattages of 25 to 200 watts generally suffice. It is usually desirable to install low-wattage fixtures at close intervals to minimize shadows and glare.

The most common problem of interior

lighting is vandalism. Naked bulbs provide maximum illumination at minimal installation cost, but they are so often and so easily broken that maintenance costs are very high, and crime is encouraged by lack of lights. Recessed lighting suffers less from accidental breakage and vandalism. Transparent bulb protectors allow nearly total passage of light, but since the bulb can be seen, a vandal will likely try to break it. Translucent bulb covers are therefore preferable, even though some of the light is blocked by the cover.

Secer and Kendall have developed fixtures that are vandal resistant. They are made of plastic and come in a variety of shapes and sizes.

### Exterior Lighting

All heavily used spaces such as paths, entries, and parking areas should be lit by 5- to 10-foot candles. Higher fixture locations have a variety of advantages. As a general rule, the useful ground coverage of an elevated light fixture is roughly twice the height of the fixture. Thus, a 150-watt incandescent lamp mounted 8 feet above the ground can provide adequate light for 16 feet along a walk. Higher luminaries are safer from vandalism. However, lighting fixtures mounted higher than the second floor may create a feeling of being in a "compound."

A variety of specialized, high-intensity light sources can illuminate large outdoor areas such as recreation facilities and parking lots. Mercury-vapor and sodium-vapor lamps are available in sizes up to 1500 watts; the eerie bluish light of early mercury-vapor lamps may be avoided by selecting one of the newer "color-corrected" models. Once again, the point is to provide an appropriate level of light without creating glare or shadows.

Lamp and fixture breakage can be controlled in part by installing fixtures of tough, break-resistant plastic. The spherical, white glass fixtures so common today are less vulnerable, though not as tough as the more expensive plastic models.

A final comment on lighting is specifically relevant to a building or residential development inhabited primarily by the elderly. The pupil in the human eye gradually decreases in size due to advancing age. As a result, about twice as much actual brightness is required to create the same degree of brightness on the retina of a 60-year-old as on the retina of a 20-year-old (the ratio reaches 3 by age 75). Therefore, lighting levels in residences for the elderly should be well in excess of conventional standards and much higher than what seems adequate to a (younger) management staff.

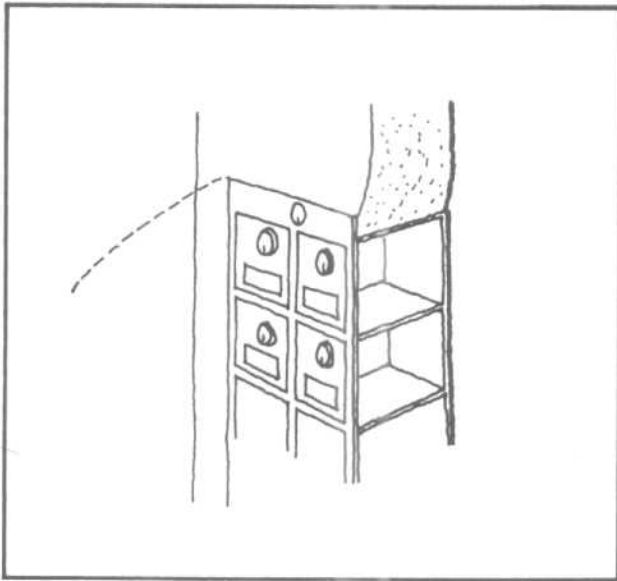


Fig. 50 Mailboxes.

## SECURITY

## Electronic Systems

Electronic security equipment includes alarms designed to detect unauthorized entrance; closed-circuit television systems, apartment-to-lobby intercom locks, and various audio equipment. While the initial cost of many of these systems is high, each could reasonably be installed in moderate-income residential complexes and could prevent future need for more costly measures.

## ALARMS

An alarm performs two functions: it detects the presence of an intruder, and it reports the intrusion. The quality of an alarm mechanism is measured by its ability to perform these two functions.

A wide range of devices detect intrusion of a criminal into a building. These fall roughly into two categories: contact devices and motion-detection devices.

## Contact Devices

Contact devices are mechanical switches that detect movement or perhaps the breakage of glass. A common type consists of a contact on the door (or window) and a contact on the frame. When the door is closed, the two contacts form part of an electrical circuit. When the door is opened, the contact is broken, the circuit is opened, and the alarm circuit is activated (see Fig. 51). A similar device, called a string-pull alarm, employs a slight variation in that the opening of the door pulls a string, which closes a switch that trips the alarm. Many contact devices are purely mechanical (as just described), while others include magnetic and mercury switches.

Usefulness of a contact depends upon its sensitivity (how much the device can be jarred without being activated) and its reliability. Most situations call for a device sufficiently sensitive that a skilled burglar cannot enter without setting off the alarm, but not so delicate that an innocent jostling will disturb it.

Foil strips are a related mechanism used primarily to detect breakage of glass in windows and doors. A delicate strip of metal foil is glued or taped to the glass. The foil strip acts as one long, continuous electrical circuit. If the glass is broken, the foil is broken, which interrupts the circuit and activates the alarm. Foil can be circumvented if it is possible to break the glass or release a lock without breaking the foil. Primarily because of their unattractiveness, foil strips are seldom installed in residences.

Contact devices can be made part of a lock mechanism (see Fig. 52). This type of alarm is set off whenever an attempt is made to force or pick the lock.

Contact devices themselves are very inexpensive; a simple magnetic contact pair costs about \$2. But each contact device can protect only one opening; therefore, even a single-family house requires several devices to protect all points of entry. In addition, it is often expensive to install the alarms and connect them to an alarm-reporting device.

Contacts may be hidden so criminals cannot locate and dismantle them easily. Hiding an alarm system lessens its value as a deterrent, but increases the criminal's chances of being apprehended while com-

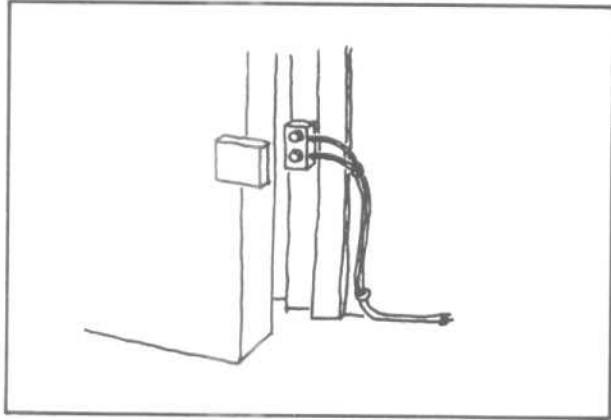


Fig. 51 Contact switch on door.

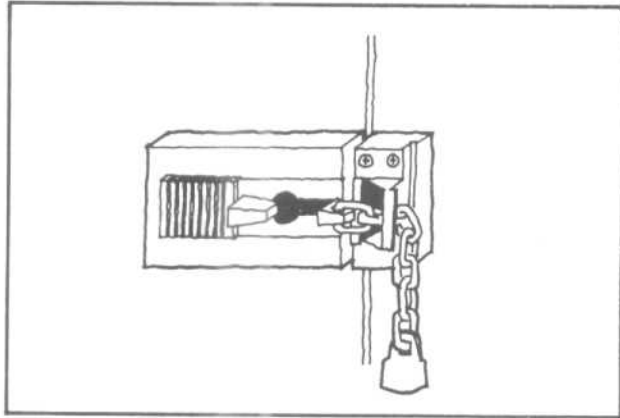


Fig. 52 Lock alarm.

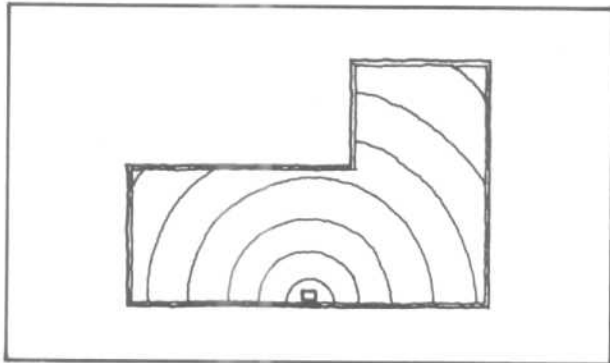


Fig. 53 Ultrasonic detector.



mitting a crime. Since deterrence is the primary goal of residential security efforts, it is quite common to advertise the existence of an alarm without revealing the location of the mechanisms. This advertising is sometimes done where no alarm system exists. Considering the minimal expense involved in such a ruse, it may be worth the cost, but even very unsophisticated criminals can pick out such fake systems.

Heat-sensitive devices are sometimes combined with contact switches to provide an inexpensive fire-security alarm system.

### Motion-Detection Devices

These devices detect the motion of an intruder as he moves about the protected space. This detection can be accomplished in a variety of ways. Seismographic devices are turned on by vibrations or weight upon the floor (these devices have been perfected so they are not triggered by a passing truck). Photoelectric cells ("seeing-eye" mechanisms) use a beam of light to detect any motion across a protected span. Ultrasonic devices send inaudible sound waves through a room (see Fig. 53). Movement by an intruder changes the pattern of reflected sound waves and thus triggers an alarm. Increased sensitivity improves the effectiveness of each of these systems, but also raises their costs.

Motion detectors are far more expensive than contact devices, but one motion device can protect an entire area, regardless of the number of points of entry. Installation costs are often minimal, as the detection device need not be connected to any part of the structure. Motion detectors are most useful in spaces not used during scheduled periods of time, such as in commercial establishments which are totally empty at night and in homes left empty during vacation. More expensive motion-detection devices can protect limited areas, such as a single door or window.

### Alarm Reporting Systems

The term "alarm-reporting system" describes the mechanism that receives the message of an intrusion and reacts. Essentially, there are only two kinds of alarm-reporting systems: Intrusion is reported either by a loud alarm on the premises (called a local alarm) or via wires to a security force which is prepared to react when notified (called a central alarm or silent alarm).

A local alarm has a bell or buzzer connected to the intrusion device which produces a loud audio signal on the premises when the alarm is activated. This is the simplest type of alarm and can be installed readily. The deterrent effect is dependent upon the burglar's being intimidated and driven off immediately by the noise. Noise of the local alarm can also stop a crime in progress and aid in apprehension if someone responds to the alarm. Local alarms are often operated by batteries (see Fig. 54). Instead of an alarm being sounded, lights in the building can be turned on by an alarm system, or lights and alarm can both be activated.

This local system also protects people sleeping in a house by alerting them that a break-in is being attempted. Generally, keys are required to shut off local alarms.

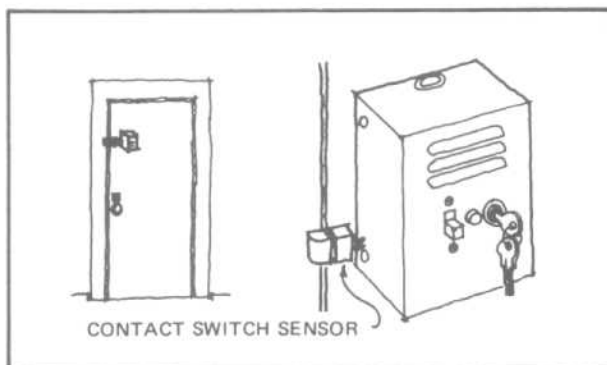


Fig. 54 Local alarm.

A central alarm-reporting system sounds an alarm at a remote point usually connected to the detection device by wires (telephone lines are used in many cases). The remote point is sometimes the residence of the owner of a protected business establishment and sometimes the local police station; but generally, it is the headquarters of a private protective agency. These agencies have guards stationed at this headquarters who will respond to the alarm signal. Usefulness of the alarm system is dependent upon the speed and reliability of the response.

A local alarm signal is often activated at the same time as a central alarm, thus simultaneously frightening the criminal and alerting the authorities. If only a central alarm-reporting system is activated, the criminal is not warned that an alarm has been sent. This system (called a "silent" alarm) increases the possibility of apprehension while eliminating the possibility of driving the intruder off with noise.

A variation on this central-alarm arrangement is to utilize regular city police to respond to the central alarm. In high-income, low-density, high-burglary-risk communities, the city police allow alarms to be hooked up to the police headquarters, where the dispatcher serves as monitor. Another arrangement is for the detection device to trigger a tape-recorded message that is automatically telephoned to the police, telling them the location of a burglary in progress.

The single major problem of all alarm systems is the possibility of false alarms. They can be caused by defects in the intrusion-detection device or the reporting system. False alarms diminish the credibility of the entire system.

If neighbors experience repeated false alarms, if security guards are called out unnecessarily, or if police are accidentally telephoned a tape-recorded message, response by all of these persons slows dramatically and will eventually cease. Thus, the intrusion device must be designed so that it is not accidentally activated by noncriminal occurrences.

Related to the false alarm issue is the question of how the alarm is turned off. The most common method is for the alarm to operate after a 20-second delay; that is, the alarm will not sound for 20 seconds after a contact is broken or motion detected, allow-

ing the resident a brief period in which to switch off the entire system. The switch can be simply a button located in a hidden place. A key-operated switch is more secure, but the possibility of false alarms increases because residents often forget or cannot locate their keys. However, the turnoff mechanism should not be so simple or accessible that the criminal can activate it.

### Selecting Alarm Systems

The security alarm business is large and complex. It is therefore impossible to specify manufacturers or even types of alarm systems for general use. The quality of installation and the maintenance program that backs up the system are crucial elements that should outweigh initial price in the selection of equipment. The best advice is to deal with firms that have a verifiable history of quality installation, a reliable guarantee/warranty record, and an established repair and maintenance program.

The concept of a consistent "level of security" avoids excessive expenditures for one piece of equipment while other means of entry are unprotected. Equipment characteristics should fit specific installation situations. It is often difficult to install contact switches in older houses because window frames often have warped or buckled. String-pull devices have to be set from the inside and therefore cannot be used for a normal exit door.

Selection of alarm equipment should be based on specific system characteristics desired: Is deterrence of crime or apprehension of criminals the primary goal? Should the system be visible to deter attempted burglary, or should it be hidden to increase the likelihood of apprehending a burglar?

### CLOSED-CIRCUIT TELEVISION

When used in residential settings, closed-circuit television (CCTV) is intended to provide "electronic windows"; that is, a visual surveillance where physical design has obviated unaided surveillance. The purpose is to create an environment in which residents know that normal restraints of surveillance by citizens and their authorized agents exist, albeit aided by electronics. While initially costly, CCTV often reduces security personnel requirements or obviates the need for expensive redesign of existing structures.

## SECURITY

## Electronic Systems

Electronically aided surveillance is not equal to personal surveillance. A corrective response to a detected crime is obviously a step further away if the viewer sees the crime on a TV receiver rather than on the spot. The deterrent of having a policeman or other person on hand is lost. There is also the possibility of equipment malfunction. But CCTV has a quality of its own: being watched while unable to ascertain who, if anyone, is doing the watching is somehow unnerving, and definitely is a deterrent. A remotely controlled surveillance camera can be fitted with an automatic panning device so that the camera swings from side to side continuously, even when no one is monitoring the system.

## CCTV System Requirements

In general, a CCTV system should perform at approximately the same level as commercial broadcast receivers. Specific equipment and the quality of image needed are determined by characteristics of the area under surveillance, schedules of operation, makeup of the monitoring staff and their expected responses to emergencies, and use of special equipment.

American and foreign manufacturers have TV cameras suitable for security work. All equipment should meet the standards of the Electronic Industries Association for CCTV. Service and maintenance are generally more difficult and expensive than installation; therefore, the capability and reputation of a local supplier is crucial. City police or traffic departments often have had experience with manufacturers, suppliers, and maintenance operations. To encourage reliance on the system by users, and to prevent criminals from taking advantage of a lapse, the CCTV system should break down as infrequently as possible and be repaired quickly in the event of a breakdown.

Picture resolution depends primarily on camera quality and lighting levels: Higher lighting levels permit the use of less sensitive, less expensive cameras.

The entire system should operate unattended. This requires electronically stable equipment, meaning, for example, that no one should be required to constantly adjust the lens of the camera.

It is difficult to project costs of CCTV systems because of the variety of system sizes and configurations and the range of equipment costs. Camera prices start as low as \$200, but more sophisticated models, such as those sensitive to very low light levels, cost up to \$10,000 each. Complicated accessories including zoom lenses, remote pan (side-to-side movement) and tilt (up-and-down movement) mechanisms, and low-light equipment can increase installation and maintenance costs tremendously. The cost of monitoring equipment can be as low as the cost of a conventional television receiver, but more specialized and sensitive equipment is far more expensive.

## Camera Locations

Locations of a CCTV camera and the light level at that point are key cost-effectiveness factors. A camera's location defines the area to be observed by the camera, and the nature of the location greatly influences the camera's vulnerability to theft and vandalism.

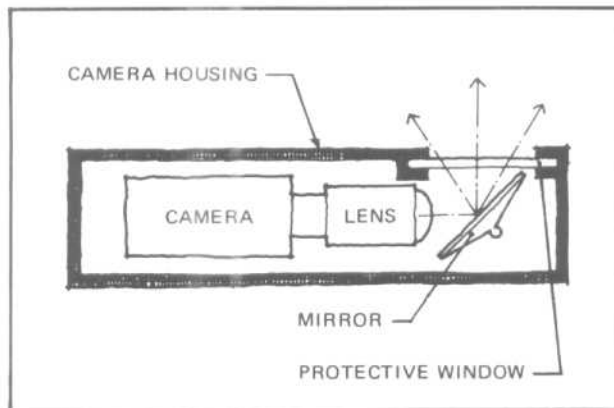


Fig. 55 Recessed camera.

Available lighting dictates the type of camera needed to produce a final image of adequate quality. Of course, supplemental lighting may be provided at additional cost.

The camera must be able to view an area that is significant in terms of crime control. Wide-angle or other special lenses should be avoided by choosing a different camera location. Most importantly, the camera itself must be protected from theft and vandalism. This means that the body and lens of the camera should be in an inaccessible place. A mirror is often used to reflect the image into the lens, so that the expensive lens will not be broken by pointed instruments, thrown objects, or bullets (see Fig. 55). All interior cameras should be placed inside sturdy housings which are installed with tamper-proof connectors. Cameras must be accessible for maintenance and repair, however.

A number of locations meet all of these requirements. An elevator in a high-rise building is often protected by CCTV. The camera is generally mounted on the outside of the elevator cab wall so that the image passes via a mirror in a corner of the elevator to the protected lens. In case of camera failure, the elevator must be stopped so that the camera maintenance man can step onto the top of the cab and reach over the side to repair the units. This is not overly inconvenient for repairmen, but it does make access to the camera more difficult for a potential thief.

Building lobbies are another common location of interior cameras. Lobby cameras are commonly hung from the ceiling or recessed into the ceiling. The elevated locations require that the repairmen use a ladder. Use of a ladder, however, would make a thief very conspicuous.

Outdoor locations usually depend upon inaccessibility to protect equipment from theft and vandalism. Cameras are located atop steel poles or on poles extending from roofs or walls. An alternative is to place the camera in a wall or window of an accessible apartment.

## Lighting for CCTV Systems

Lighting plays a key role in the cost and effectiveness of a CCTV system. For camera locations inside buildings, it is almost always less expensive to raise the light level than to use low-light-level equipment. The required

lighting level is only slightly higher than normal for building interiors, can be achieved without glare, and has an intrinsic value as a crime deterrent.

Exterior lighting can be very expensive. Cameras used outdoors are almost always more flexible and sensitive, being capable of adapting to full sun, cloudiness, and dusk. But as indicated earlier, camera costs rise dramatically for low-light-level equipment. While increasing of lighting levels is also expensive, well-designed extra lighting again has an intrinsic value as a crime deterrent.

## Monitoring of CCTV Systems

Effectiveness of CCTV depends on the nature and quality of monitoring. Many people may be used as monitors: city police, project security personnel, members of organized tenant patrols, tenants acting as individuals, and various combinations of these groups. The choice depends principally upon availability of personnel and their monitoring costs.

City police will monitor CCTV systems only if they believe it is the most efficient use of manpower. Thus an area being surveyed must suffer large numbers of crimes to warrant hiring a policeman or civilian whose function is simply sitting, watching, and adjusting. Crime reduction or criminal apprehension through CCTV monitoring would have to be substantial to justify continued use of such manpower. Police use of CCTV systems is generally limited to shopping districts and city-center areas. Police normally monitor large systems that include several cameras (each equipped with pan, tilt, and zoom capability) and a monitoring console, so that the viewer can watch activity in several places at once and adjust his equipment to concentrate on a particular place, incident, or individual.

Commercial and industrial facilities often hire private security personnel to monitor CCTV systems. Guards are used less frequently in residential complexes. The major advantage of use of guards is that a single guard can control several entrances to a building or complex of buildings. Usually the guard can see all entrance doors, the lobby, and the elevator interiors on the monitor screens. He can be given audio contact with the lobby area. With the use of an intercom



system, he can also control garage and front door entrances. He can also be given the ability to stop the elevator in midflight. Thus the security guard can see and hear every person entering the premises; he can prevent them from entering; and he can even exert some control after they enter.

It is also possible to staff a monitoring panel with members of tenant patrols. Use of volunteer personnel eliminates payment of guard salaries. Because they are personally acquainted with the project residents, tenant monitors can easily pick out strangers and perhaps distinguish a minor argument among friends from an impending fight.

But, there are serious drawbacks in using tenant monitors. It is difficult to guarantee the performance of unpaid people. The novelty of working with TV monitors will wear off quickly, and declining interest increases the likelihood of patrol members simply not showing up. Additionally, tenant patrol members are not equipped or empowered to take much action. The tenant monitoring the CCTV has no real authority over police or security personnel. Finally, there is the problem of tenant patrol members using their position to harass or intimidate other tenants.

An alternative is in-apartment tenant monitoring. Tenants of a building or housing project can monitor CCTV on their home TV screens. By connecting CCTV equipment to a master antenna within a building, tenants can have the option of tuning into unused TV channels to monitor lobby, elevator, playground, or parking lot activity. Tenants may watch CCTV when they are expecting someone to arrive, or when a child is playing within viewing range of a camera in a playground area. Older people may watch for less specific reasons. Obviously, this does not assure continuous monitoring, but if one or more of 200 tenants is watching, it would be risky for intruders to take chances.

An in-apartment tenant monitoring system requires that a cable TV or master antenna system be in operation in the building. CCTV is clearly most suited to large, high-rise dwellings. Picture quality of the CCTV systems should be comparable to that of commercial broadcasting to promote tenant usage. While some picture disintegration may be acceptable in a conventionally

monitored CCTV system, there should be no distortion in a system designed for in-apartment monitoring. It is desirable (and generally not expensive) to install a microphone system so that sound accompanies the TV picture, which makes the system more interesting and enjoyable.

It is possible to organize a voluntary in-apartment monitoring program to improve coverage. A tenant organization could arrange for persons to watch CCTV in their homes during specified hours. Such a scheduled system would promote better coverage and facilitate participation because there would be no requirement that residents leave their apartments.

Also, CCTV monitors should be placed where responsible individuals, such as management staff and patrolling guards, are at work or pass by continually.

### INTERCOM SYSTEMS

Most urban multifamily dwellings are equipped with buzzer-reply systems to limit access to the building to tenants and to people who have been interviewed by tenants on an intercom system. A typical buzzer-reply intercom system in an apartment building functions as follows: A panel located outside the lobby entrance door lists the names and apartment numbers of all tenants in the building. Next to each tenant's name is a call button that when pressed rings a bell or buzzer within that tenant's apartment. The tenant responds to the call by walking to a panel mounted on the wall of his apartment and speaking via an intercom system to the person outside the door. When identification is satisfactorily established, the tenant pushes a button on the panel which momentarily allows the entrance door to be opened without a key. Because the costs involved in installing wiring for such a system in an existing building are very high, buzzer-reply systems should be installed in all new buildings during the construction phase.

A modified version of the traditional buzzer-reply system has recently come into use. Local telephone companies install and service front-door intercom systems that use existing telephone wires instead of a separately wired system. The panel mounted

outside the lobby door differs from a conventional panel in that it is supplied with a telephone receiver, and the list of residents has a three-digit number next to each name. A person wishing to enter the building dials the appropriate three-digit number, which makes the phone of the tenant buzz (not ring). The tenant then speaks with the person over the phone. If recognition is established, the tenant dials "4" to open the front door. If a tenant is speaking on the phone when the buzzer sounds, he can depress the receiver once, speak to the person in the lobby, buzz him in by dialing "4," and then depress the receiver again to return to his initial telephone conversation. For tenants without telephones, a special unit that can be used only for the intercom can be installed. Fees for installation and service are billed by the phone company and added to the tenants' monthly rent.

### ELEVATOR AUDIO SYSTEMS

Use of audio systems in elevators is rapidly increasing. An elevator audio system is an uncomplicated sound-transmission installation consisting of a microphone and speaker located in the elevator cab and connected to similar devices near the elevator doors on each floor. The system allows someone inside the elevator to speak to anyone standing in the elevator waiting area, and vice versa. In office buildings or high-income residential buildings, an additional connection is made so that a doorman, guard, or maintenance man can respond to persons inside the elevator. In low-income housing, the equipment in the cab is simply connected to the elevator on each floor.

Some systems are designed to remain on at all times, but most require the person in the cab to push a button before he can talk to the outside location. A continuous voice relay system reassures the elevator rider that he can communicate with the outside if any trouble arises, whereas the need to push a button limits the usefulness of a noncontinuous audio system in crime situations. Any elevator audio device is useful when breakdowns occur and someone is trapped inside the cab.

## COLOR THEORY

**Primary colors** The longest extended slices on the color wheel (Fig. 1) show the three primary colors — red, yellow, and blue. They're called primary because all the other colors come from combinations of these three colors.

**Secondary colors** Mix any two primary colors and you get the secondary colors:

- Orange (red and yellow)
- Violet (red and blue)
- Green (blue and yellow)

**Tertiary colors** All of the other six colors on the wheel are called tertiary, or intermediate, colors. They are a mixture of the primary colors plus an adjacent secondary color. Thus:

- Yellow orange (yellow and orange)
- Yellow green (yellow and green)
- Blue green (blue and green)
- Blue violet (blue and violet)
- Red violet (red and violet)
- Red orange (red and orange)

Color has three dimensions: the *hue*, distinguishing one color from another — such as red, green, blue, etc.; the *value*, denoting lightness or darkness; and the *tone* or *intensity*, which is the brightness or dullness.

These hues, values, and intensities can appear to change when different ones are used together. Two or more light values combined afford little contrast; nor will darker values in combination provide much interest. But, when a light value is used with a dark, the light appears lighter while the dark appears darker. White is the lightest of all colors, and values range from it through varying gradations of gray to black. Colors that are nearer white in value are called *tints* and colors that are closer to black in value are called *shades*.

Intensities or tones also have similar effects. A brightly upholstered chair will appear brighter and will stand out when used with a carpet of dull color, as it will produce a spot of interest. In contrast, a few dull-colored pieces of furniture will sink into the background if the room contains brighter-colored rugs, draperies, and other furnishings.

Contrasting or opposite hues will emphasize one another. Red with green will make the red look redder and the green appear more orange, while the red-purple will take on a bluish tone.

There are many ways of combining colors for interest. Related color schemes such as reds, purples, and blues together can produce very pleasing effects. Contrasting hues, such as blues with oranges, can also be combined to give more vibrant results.

Some people enjoy excitement. Warm colors such as yellow, orange, and red are exciting because they are associated with things like sunshine, fire, heat, and even blood. Warm colors tend to "advance," and a predominantly warm-colored wall will seem to come forward. They are especially effective

in rooms that are on the east or north side of a house, because light entering from those directions seems to be a cool light. The warm colors and cool light complement each other and make the room seem cozier and warmer.

Cool colors are those associated with water, verdure, and the sky — blues, greens, and violets. These tend to "recede," and under most conditions, light, cool-colored walls will create an illusion of greater space. They are good choices for rooms on the south and west side of the house, since these areas receive a lot of sunlight all year around. Theirs is a cooling effect in the warm-light areas, another complementary association.

Black, white, gray, and brown — and the tones of the latter two, known as grays and beige — are not considered to be colors so much as *neutrals*. In practice, they are the "no-color" colors, which are used with other colors to modify them or to contrast with them. But they are far from being negative. As you work with color, you will find that all colors are influenced by the company they keep. This is particularly true of the tints, shades, and so-called neutral colors. A juxtaposition of two muted colors, such as a gray and a tan, will bring out latent greens, lavenders, and pinks you did not see before. Colors also have visual weights. Dark and bright appear heavy, while light or dull seem to weigh less. Remember that a dominant color is the one that "controls" a room, while the others are accents.

#### Basic Color-Scheme Planning

Successful decorating often depends on how well the total effect is anticipated. Here are four types of schemes that professional decorators have in mind when they start to plan a job. They are no guarantee of perfect results, but they do make an unwieldy subject easier to handle.

**Monochromatic** This scheme is built around one color, using it somewhere in its full intensity, and then varying it with a number of shades, and tints of the same color. For example, in a monochromatic scheme of yellow, the range could be from dark shades of gold, through clear yellow, to light, pale-yellow tints. A monochromatic color scheme can be restful, create a feeling of spaciousness, and provides a good background for art objects, collections or similar decorations. But generally, when employing a monochromatic color scheme, the interest of the room comes through by using a variety of textures and patterns.

**Analogous or related** Because it's the easiest color scheme to work with, an analogous scheme is the one that enjoys the greatest popularity at the present time. It is based on two or three colors, such as yellow, yellow orange, and red orange, that lie close to each

other on the color wheel, with "relief" provided by tints and shades of the same that have been tinged with adjacent greens or vermilion. The analogous color scheme is restful and refreshing also, and the colors are more interesting because of their variations in intensity and value. It is the kind of color scheme that is easily changed; a slight shift of emphasis here and there is all that is necessary to completely change the character of the room.

**Complementary or contrasting** This scheme, which is rapidly coming into favor, uses colors that are opposite each other on the color wheel — blue and orange, red and green, yellow and violet. One color is usually a primary color and the other a secondary color. Using such contrasting colors will give a lively and vibrant room, but it is a color scheme that must be used with caution. One color should always dominate, with the others being primarily dramatic accents. The "shock" impact of a complementary color scheme can be softened by selecting unexpected shades and tints of the two colors. That is, a vivid color and its complement can be quieted, if you prefer, by graying them, or reducing their values. Employing a pair of opposites in this manner means that there will be both cool and warm colors in a room, which makes a mutually complementary association. A complementary color scheme tends to make a room seem smaller.

**Accented** This is a combination of adjacent, related, or analogous colors — call them what you will — accented by a bold touch of color from the opposite side of the wheel. An example would be a scheme ranging through a number of strong, soft, and grayed yellows, spiked with purple or violet.

There are also other color schemes, such as *triad* and *split-complementary* that you can adapt from the color wheel, but the four suggested above are the easiest to visualize and to carry out.

In whatever basic scheme you use do not forget the neutrals: black, white, the grays, and browns — to which you might add metallic gold and silver. Since they will appear of themselves, in the wood and metal of your furnishings, they must at all times be considered for the part they play in the total effect. If you wish, the neutrals can constitute a fifth, and very sophisticated, color scheme of their own! But usually they must be more or less just "accepted," and played up or played down by the colors you combine them with. Incidentally, some black and white is an asset to almost any color scheme, but too many and indefinite neutrals, used with stronger colors, tend to compromise a color scheme and make it look confused or merely drab. It is best to think of any neutral as a distinctive note of color, whether it is the fieldstone of a fireplace or a hardwood floor.

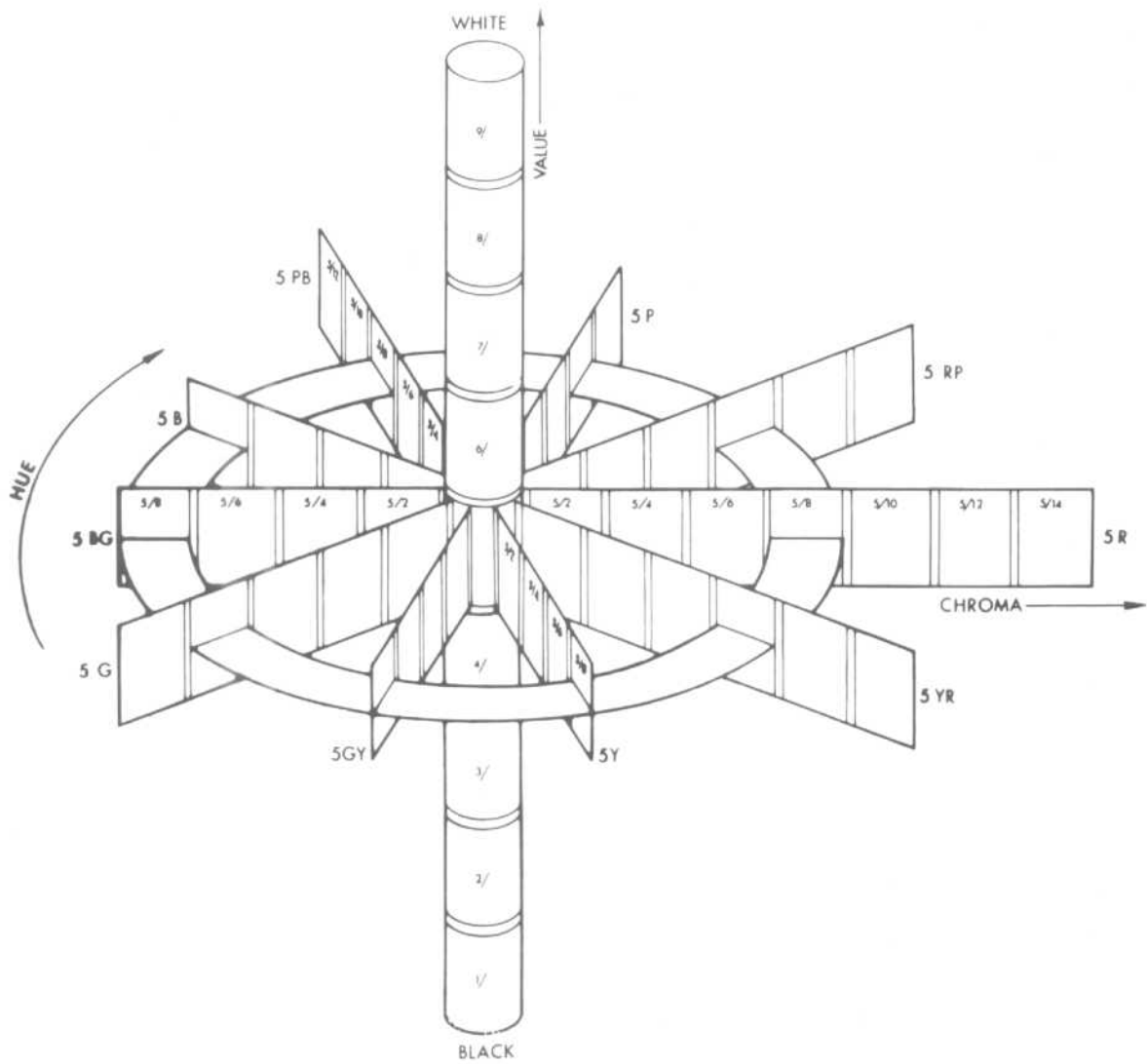
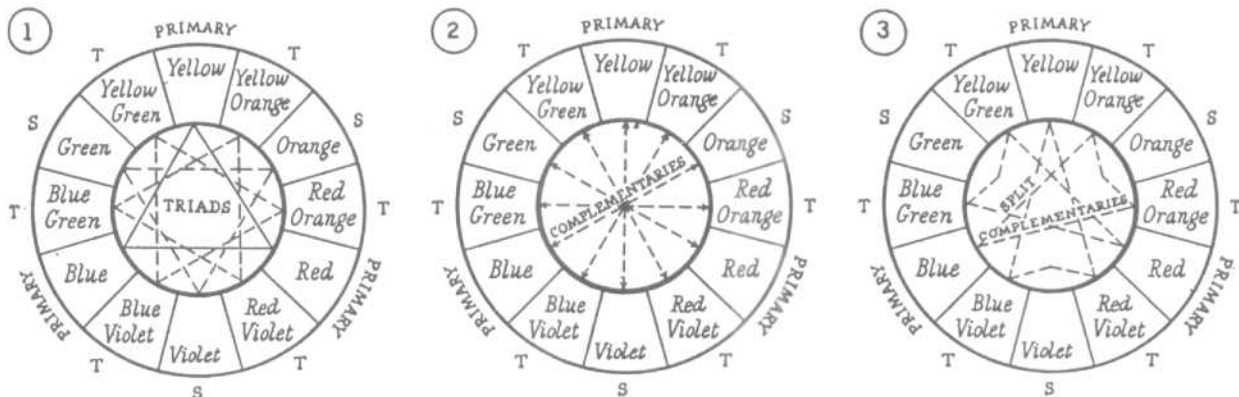


Fig. 1 The basic wheel with a three-dimensional projection of the attributes of color — hue, value, and intensity — as shown in their relation to one another. The circular band represents the hues: G, green; B, blue; P, purple; R, red; and Y, yellow. The upright center axis is the scale of value. Paths leading from the center indicate color intensity.

## COLOR THEORY

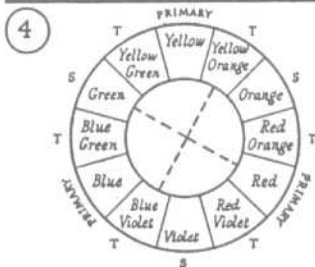
## Color Schemes and Combinations



WARM COLORS { Red Orange Yellow } and tones which they dominate.

COOL COLORS { Blue Green Violet } and tones which they dominate.

NEUTRAL COLORS { White Black } and tones dominated by grey or brown.



EXAMPLES OF ANALOGOUS (RELATED) COLOR SCHEMES

## DIRECTIONS FOR USING COLOR COMBINATION CHARTS

COLOR WHEEL NUMBER 1 illustrates color combinations in which the three primaries are used together, or the three secondary colors, or three tertiary colors. The three points of each triangle link the colors used in this TRIAD COLOR SCHEME. The rule for success is to use only one of them in a strong, bright tone, in small areas, with the other two in softened (or grayed) tones.

COLOR WHEEL NUMBER 2 illustrates the color pairs which are effective together through contrast. This is called the COMPLEMENTARY COLOR SCHEME. As the arrows indicate, the pairs are exactly opposite each other on the wheel. One should be used in a bright tone for smaller areas, the other in grayed tones and larger areas.

COLOR WHEEL NUMBER 3 illustrates the use of a color with the two which are next to its opposite on the wheel, one on each side. This SPLIT COMPLEMENTARY COLOR SCHEME follows the rule for complementaries, and may include the direct contrast color also, if desired. For example, yellow may be used with blue-violet, and red-violet, with or without the true violet shade which comes between them.

To avoid confusion, not all of the triangles are indicated. Cut a piece of paper the size of the triangle and lay it with the top point at any color you choose. The other points will rest on the correct colors.

COLOR WHEEL NUMBER 4 illustrates how an ANALOGOUS COLOR SCHEME is developed by using colors which are related because they are side by side on the wheel. Any group can be used, all around the wheel, as indicated by the dotted lines. For an accent color you can use a contrast color opposite any one of your group. For instance, in the yellow-orange to red group, complementary blue could be used for accent (shown on color wheel 2).

Black, white, gray and other definitely neutral tones can be used with any combination of colors.

## BASIC PRINCIPLES FOR WORKING OUT A COLOR SCHEME

## 1. DOMINANT OR CONTROLLING COLOR

Decide on your dominant or controlling color, which may dominate by covering a large area or by strength of color in a smaller area. Decide whether your foundation or background color is to be the dominant or a secondary color. Plan to use a large amount of quiet background color, a small amount of bold, strong color. All large foundation areas should be in light or grayed tones.

## 2. GRAYING

Clear colors are gay, more cheerful, but grayed tones are more restful, their harmonies more subtle. Mixing gray with bright colors brings them into relation with other colors in the room. As . . . red and yellow in bright tones seem to clash. Mixed with gray, they become rose and tan and go very well together. Use this principle also in buying materials. Avoid too much graying. It gives muddy tones, dirty grays, flat greens. A little gray goes far.

## 3. RELIEF AND CONTRAST COLORS

Decide on relief and contrast colors and bring them into all parts of the room composition. Remember the order in the amount of space allowed each one—foundation, then relief, then contrast. All colors—including background colors—should be keyed to the dominant color. Soften strong contrast colors

with white. Contrast is less in lighter tints. Soften darker contrasts with gray.

## 4. ACCENT COLORS

Use pure bright intense colors only in accessories, etc. Distribute them so they will not be spotty. The smaller the area the brighter the color may be. The larger the area the softer the tone should be. Don't use large amounts of pure bright color.

## 5. KEYING

This is another means of creating harmony. A key color is the one about which the color scheme is built—the dominant, or controlling color. All other colors in the room must be "keyed" with it—harmonized. Two colors in which any part of a third color is present will be linked together. Example: To key red and yellow to each other, mix them both with a little of the third primary hue—blue. Violet and green will result, and these are harmonious to use with your strong tones. Remember this principle in buying as well as mixing colors. A lovely print or art object will have these tones keyed for you, and you can use them for your own composition. The safe rule is to avoid too many colors and too strong tones except in accents, etc. Most colors will "go together" if you soften them.

## WHAT DECORATORS MEAN WHEN THEY USE THESE COLOR TERMS

**HUE:** Each section in the color wheel is called a hue. To change a hue, another color (not black, white or pure gray) must be added to it. Every hue has a different wave length from every other hue. Mixed with its complement equally it produces gray.

**PRIMARY COLORS:** Also called "normal," also "fundamental." Primaries are the three pigment colors which cannot be produced by any mixture of other pigments. These are red like that of a geranium flower, yellow like that of ripe lemons, blue like the deep clear hue of a sunny southern sky.

**SECONDARY COLORS:** Secondaries are the three colors which are produced by mixing two of the three primaries in equal amounts. Red + yellow = orange; red + blue = purple (or violet); yellow + blue = green.

**TERTIARY COLORS:** Tertiaries are the colors produced by mixing a primary with a secondary, the exact shade depending upon the proportion. Red + orange produces shades such as russet, burnt orange, coral, etc. Red + purple—mulberry, amethyst, orchid, etc. Blue + purple—heliotrope, periwinkle, lavender, etc. Blue + green—turquoise, aquamarine, bottle green, etc. Yellow + orange—maize, primrose, flame, etc. Yellow + green—jade, Nile, olive, chartreuse, etc. Mixtures of complementaries not included because these produce shades of gray—a neutral. Some authorities consider, also, the shades produced by mixing two secondaries as tertiaries, such as slate, citron, buff, sage, etc.

**COMPLEX COLORS:** All colors which are made up of more complicated mixtures than those producing secondary and tertiary colors are called complex.

**NEUTRAL COLORS:** Black and white are considered neutral. Also all those tints and shades in which tones of gray or brown predominate.

**TINTS:** The light tones resulting when white is mixed with a color. Much white makes a color cold.

**SHADES:** The dark tones resulting when black is mixed with a color. Much black deadens the color.

**TOPE:** Each hue has many tones. By tone—or tonal value—we mean the relative strength of the hue as it approaches black or white at the opposite ends of the value scale. Mixed with white, a color is "pale" in tone; mixed with black, it is "dark" in tone. The upper and lower extremes of any color would be white (or very pale gray), and black.

**CHROMA:** This term is used interchangeably with value, tonal value, and intensity. The chroma of a color such as yellow is "light"; the chroma of a color such as Navy blue is "dark." When a color fades, it loses chroma.

**LUMINOSITY:** This term is used to describe a quality of warm clear colors in light-reflecting tones and finishes, such as light golden-yellow. Clear white is also luminous. Literally "luminous" are only metals in gold, silver, platinum, or clear plastics.

## COLOR SUGGESTED COLOR GROUPS TO USE WITH IT

COLOR	SUGGESTED COLOR GROUPS TO USE WITH IT
RED	Green, gray, blue (for accent)
SCARLET	Light blue, ecru (or Navy and teal)
CRIMSON	Pearl gray, mauve
GARNET	Sapphire blue, mauve, pearl gray
CARDINAL	Marine blue, turquoise, gray
WINE	Black, old blue, beige
ROSE	Flesh, light blue, green
OLD ROSE	Blue in various shades
CEDAR ROSE	Blue, cream
PINK	Green, orchid, blue for accent
ORANGE	Violet, light blue, indigo for accent
BURNT ORANGE	Electric blue, light brown
SALMON	Turquoise, lavender
HENNA	Peacock green, royal blue, gray
PEACH	Rust, blue, tan
MAIZE	Powder blue, pink
YELLOW	Violet, blue, green
PRIMROSE	Lavender, dusty rose, soft green
SOFT YELLOW	Brown, French blue
GOLD	Soft gray-green, deep red
DARK GREEN	Brown, beige (or sage green and gold)
MYRTLE	Heliotrope, yellow
SOFT GREEN	Rosewood, deep violet
TARRAGON	Heliotrope, pearl gray
CHINESE JADE	Rose, ivory
NILE	Cornflower, orange
LIGHT GREEN	Rose, dark green, mauve
BLUE	Yellow, sand, orange for accent
COPENHAGEN BLUE	Burgundy, gray
FLEMISH BLUE	Olive-green, cardinal
LIGHT BLUE	Orchid, champagne
DEEP PURPLE	Orange, gray
VIOLET	Green, light and dark shades
LAVENDER	Green, mauve, gray
HELIOTROPE	Light blue, cream
HYDRANGEA	Old rose, primrose yellow
MAUVE	Emerald green, dark red, brown
BROWN	Orange, tan, cardinal for accent
GRAY	Violet, crimson, lavender.

## COLOR AREAS AND SAMPLES

WALLS  
MEDIUM  
TO  
LIGHT

### PROPORTIONATE SAMPLE SIZES

1. WALLS	24" x 24"
2. FLOOR	18" x 18"
3. DRAPERIES	16" x 16"
4. CEILING	14" x 14"
5. COUCH, ETC.	12" x 14"
6. WOODWORK	10" x 14"
7. LARGE CHAIR	8" x 8"
8. LARGE CHAIR	6" x 8"
9. SMALL CHAIR	6" x 7"
10. ACCESSORIES	6" x 7"
11. ACCENTS	5" x 6"
12. TRIMMINGS	5" x 6"

FLOORS  
DARK  
TO  
MEDIUM

VARIED as used here means choice of light, dark, or medium tones, clear or grayed colors.

DRAPERY  
VARIED

CEILING  
LIGHT

LARGE  
COUCH  
BED  
SOFA  
VARIED

WOOD-  
WORK  
VARIED

VARIED  
LARGE  
CHAIR

LARGE  
CHAIR

BRIGHT  
SMALL  
CHAIR

ACCESS-  
ORIES

BRIGHT  
ACCENTS

TRIMMINGS

### POINTS TO REMEMBER IN MATCHING SAMPLES FOR COLOR

- Use larger samples if possible, especially in patterned materials, but keep approximate proportions of chart. Sizes are determined according to area and interest. Ceiling and floor areas, for example, are equal—but floor interest is greater, hence the larger sample. If several items are the same color add them to make one sample.
- Make allowance for texture. Soft rough surface in paint, paper, or fabric makes colors appear darker. Hard glossy surfaces appear lighter.
- Make allowance for distance. Colors look brighter when they are close; farther away they seem softer, grayed by atmosphere. Colors which match exactly 1 ft. away may seem quite different at 15 ft. This is important in a large high-ceilinged room.
- Make allowance for proximity. When side by side: Complementary colors brighten each other; related colors, when both light or both dark, deaden each other; neutral colors brighten clear colors, but pure strong primary colors deaden neutrals such as grays, browns, etc.; light and dark tones brighten each other, especially white for dark colors and black for light tones; one color may seem to change another's hue as when a strong clear color gives a tinge of its complementary to a neutral—red, for example, may give a greenish cast to gray unless a little red has been mixed with the gray.
- Make allowance for proportion. The larger the area the darker the color will appear. Choose a wall color slightly lighter than you really want it. Don't decide exact shade of a painted wall until all other materials have been chosen. It is easier to match paint to fabric and paper than the other way around.

## COLOR COMBINATION CHARTS

S = SECONDARY . . . . . T = TERTIARY



## COLOR THEORY

## Munsell System of Color

One of the best-known and widely respected systems of color standardization used in the United States today is that developed by Albert H. Munsell. He became greatly interested in the practical application of color and was disturbed by the fact that the popular names for colors did not describe them adequately for professional purposes. They are named after flowers or plants, such as violet, indigo, old rose, primrose; after fruits, such as peach, pomegranate, grape, avocado, plum; after places such as french blue, naples yellow, or prussian blue; or after persons, such as Davy's gray or Hooker's green.

Essentially the system consists of an orderly arrangement of colors in the shape of a three-dimensional color solid. The system is based on a color circle of ten major hues made up of five principal hues, red, yellow, green, blue, and purple, and five intermediate hues, yellow-red, green-yellow, blue-green, purple-blue, and red-purple. Each hue is indicated by a symbol as follows:

Red: R  
 Yellow: Y  
 Green: G  
 Blue: B  
 Purple: P  
 Yellow-red: YR  
 Green-yellow: GY  
 Blue-green: BG

Purple-blue: PB  
 Red-purple: RP

Each of the above major hues has been given a value of 5 in the inner scale around the hue circle (see Fig. 2, hue symbols), i.e., 5 R, 5 YR, 5 Y, 5 GY, 5 G, 5 BG, 5 B, 5 PB, 5 P, and 5 RP. Between each of the major hues are values of 2.5, 10, and 7.5 for rough indication of hue. The outer scale of the hue circuit is divided into 100 segments to provide greater accuracy for indicating hue where needed.

In the Munsell color tree each hue (H) is allotted ten segments of the hue circle, making 100 hues, and these hues form the horizontal center, or equator, of the color solid. The center segment of each color is considered the true color, and the remaining segments in each hue section vary according to their proximity to adjoining colors; for example, as red gets closer to yellow it contains more yellow, and this is indicated by the numerical designation.

The value (V) notation denotes the lightness or darkness of a hue, which is determined by a neutral core at the center of the hue circle. The core contains ten gradations from a supposedly perfect white (one having 100 percent reflectance) at the top to 0, a perfect black (having 0 percent reflectance) at the bottom.

The chroma (C) notation indicates the

saturation of the hue, or the strength of the color. The chroma scale extends outward from the central core or axis, and the increments vary from 0 at a neutral gray to as high as 16, according to the amount of saturation produced by a given hue at a given value level. Since colors vary in chroma, or saturation, some colors extend farther from the neutral axis than others, and the solid is therefore not symmetrical. Pure red, with a chroma of 14, for instance, extends farther than blue-green, with a chroma of only 6 (see Fig. 1).

A Munsell notation indicating hue, value, and chroma (H V/C) might be given as follows:

Vermilion: 5R 5/14

Rose: 5R 5/4

With this information it is possible to describe exactly any given hue and to locate its place in the color solid. Furthermore, as Munsell stated, one can "select one familiar color, and study what others will combine with it to please the eye," by the use of three typical paths: one vertical, with rapid change of value; another lateral, with rapid change of hue; and a third, inward, through the neutral center, to seek out the opposite color field. All other paths are combined by two or three of these typical directions in the color solid.

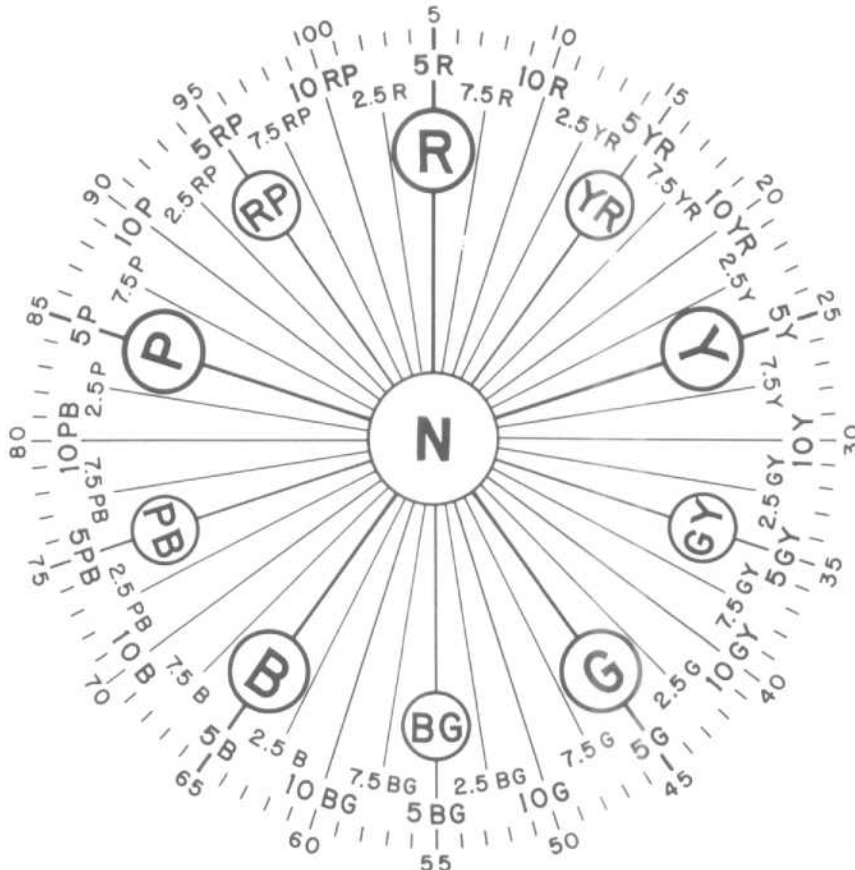


Fig. 2 Munsell hue symbols and their relation to one another.

## THE RED FAMILY

REPRESENTATIVE MEMBERS OF THE RED FAMILY . . . FLESH . . . DUSTY-PINK . . . SHELL-PINK . . . ROSE . . . DUSTY ROSE . . . OLD ROSE . . . CARDINAL OR CRIMSON . . . RASPBERRY . . . RED-BURGUNDY OR WINE RED . . . MAROON . . . ETC.

CHARACTERISTICS . . . Warm, advancing . . . Cheerful, hospitable, active . . . In strong tones, stimulating, bold, vital, dramatic, exciting.

WHAT THEY CAN DO . . . Make objects seem closer, larger . . . Make room seem smaller by bringing background closer . . . Focus attention on wall or object . . . Bring life, brightness, warmth, to drab, dark or too-cool rooms.

CORRECT USES . . . In light tints, charming background for fairly light, large rooms . . . In bright tones, highly decorative when used for comparatively small areas, as in accessories, accents, etc. . . . In darker shades, rich and warm for draperies, carpets, upholstery, especially in large rooms with heavy furniture.

CAUTION . . . Do not use too much red—especially in clear, bright tones, and in light rooms . . . Safer to soften a little by "graying," except when used for accent . . . Do not use the Red Family for background of a room that is small or crowded . . . Do not use bright red for large objects, unless you want to call attention to them . . . Do not forget when using the Red Family to include cool colors in your color schemes . . . It takes two cool colors, or a large area of one cool color, to balance red.

## SUGGESTED COLOR SCHEMES IN WHICH MEMBERS OF RED FAMILY PLAY A DOMINANT ROLE

DOMINANT COLOR	MAJOR WALL COLOR	MAJOR FLOOR COLOR	DRAPERIES AND UPHOLSTERY	ACCENT COLORS	REMARKS
SHELL-PINK	Shell-pink	Light Blue	Off-white background, powder-blue and shell-pink in pattern	Italian Red	Charming for bedroom. In slightly darker tones of same colors, could be adapted to living rooms. Feminine feeling
MELON PINK (like Pompeian terra cotta)	Melon Pink	Brown	Light tan background, melon-pink with green olive in design	Green Olive	Good for living or dining room with mahogany or walnut furniture
VENETIAN PINK	Venetian Pink	Patterned rug, soft tones, green, mauve, red	Draperies, yellow and white stripes Upholstery, green and dull pink stripes	Red	Good for living room with 18th Century furniture
DUSTY PINK	Dusty Pink Woodwork, cocoa brown	Deep Brown	Draperies, pale aquamarine (dusty pink curtains) Chair and bed covers, cocoa and pink stripes with cocoa brown trimming	\ White	Interesting for modern bedroom with furniture in cocoa tones
BOIS DE ROSE	Bois de Rose	Sage Green	Draperies, pearl gray, trimmed with bois de rose Upholstery, pale gray with sulphur yellow	Green and Sulphur yellow	Living room color scheme with feminine feeling
DAWN ROSE	Dawn Rose	Dark Green	Neutral background, dawn rose and leaf-green in pattern	Wet Leaf-green	Attractive for bedroom
LIGHT ROSE	Light Rose	Deep Blue-green	Draperies, dusty rose background, blue-green and foliage tones in design Upholstery, blue, blue-green and green, plain, pattern and stripes	Blue	Suitable for fairly large room with average light
ROSE (1)	Warm Gray	Rose Taupe	Draperies, rose Upholstery, rose and cream stripes	Blue or Green	Appropriate for almost any living or bedroom
ROSE (2)	Oyster White	Rose Red	Draperies, oyster white Upholstery, oyster white with reds, blues and soft green	Red	Charming for bedroom or women's living room
ASHES OF ROSES	Ashes of Roses	Cafe au lait	White	Strong Blue	Adaptable to bedroom or living room
DUSTY ROSE (1)	Deep dusty Rose	Brown	Lighter dusty rose, white and brown	Silver	Good color scheme for living room or dining room
DUSTY ROSE (2)	Pickled wood	Pinkish Beige	Draperies, dusty rose Upholstery, foam green and natural	Pale Green	Adaptable to living room, traditional or modern
OLD ROSE (1)	Old Rose	Warm Gray	Blue and pale yellow, with touch of old rose	Jade Green	This color scheme is charming and delicate, suitable for bedrooms and dressing rooms
OLD ROSE (2)	Paper, Old Rose, cream and gray	Mulberry	Old rose and gray	Blue and Silver	With woodwork painted warm gray, this scheme would be attractive for bedroom or dressing room
OLD ROSE (3)	Paper, Blue and rose pattern	Ivory	Draperies, ivory background, rose, blue and green in pattern Upholstery, old rose, and drapery fabric	Green	Attractive for formal living room
RED (1)	Soft grayed Green	Patterned rug with red background	Draperies, pale gray background, red in pattern Upholstery, plain green, red and green stripes	Blue and Orange	Suitable living room or dining room

## COLOR THEORY

Color Families: Red

RED (2)	Paper, granite flecked with red	Patterned rug, red predomi- nating	Chintz, red predominating in pattern	Green and Pewter	Good for Early American room, with pine or maple
RED (3)	Paper, red toile designs; woodwork, white	Hooked rugs Floors, painted blue	Draperies, textured beige Upholstery, textured beige trimmed with red	Blue (chairs painted blue)	Colonial type living room or library
RED (4)	Old white Woodwork, dark green	Red rug	Red and white brocade	Green	Living room in period feeling with walnut furniture
RED (5)	Paper, light background, red with green and brown in pat- tern	Dark blue	Red	Blue	Early American dining room, with pine and maple
SOFT RED (1)	Neutral	Soft Red	Draperies, blue-green background, deep red in design Upholstery, blue-green	Yellow	Nice for living room
SOFT RED (2)	White	Rug, blue, red and white pattern	Draperies, linen color with red in pattern Upholstery, chair seats, blue	Silver	18th Century dining room
CRIMSON (1)	Bone white	Crimson	White background, floral design in red and soft green	White	Mahogany furniture of very nice design would be lovely with white walls
CRIMSON (2)	Soft Gray	Crimson	Draperies, white, gray and crimson Upholstery, white, trimmed with crimson	Black	A smart sophisticated color scheme
CRIMSON (3)	Slate Gray	Soft Crimson	Draperies, bluish white, trimmed with soft crimson Upholstery, bluish white	Gold	Adaptable to modern styles
CHINESE RED	Grayed soft Green	Chinese Red	Draperies, grayed soft green Upholstery, deep beige	Light Beige	Good for living room or dining room
LACQUER RED (1)	Gray	Brown	Gray and lacquer red	Green	Colorful living room with some red lacquer furniture
LACQUER RED (2)	Paneling, Red Lacquer, silver trim	Black	Silver gray, with red and black in design	Silver	Modern library
ITALIAN RED	Yellow	Floor, stained dark Patterned rug in old reds and dark blues, red predomi- nating	Draperies, Italian red damask. Upholstery, red damask, yellow, glazed chintz with white ground and red in design	Gold	Living room English in feeling, also good for Federal American
CRANBERRY RED	Paper with light ground and cranberry pattern Paneled fireplace and painted blue	Deep soft red	Draperies, rose Upholstery, blue, and chintz-like wallpaper pattern	Green	Cheerful living room color scheme
WINE RED (1)	Green	Wine Red	Draperies, wine red Upholstery, grayed green and off white	Crystal	Attractive for living room with cool North or East light
WINE RED (2)	Soft grayed Blue	Deep Gray	Draperies, wine red Upholstery, wine red, grayed white and blue	Silver	For fairly formal living room, average size
WINE RED (3)	Paper in yellow, pale gray and white	Dark Wine Red	Draperies, Ruby taffeta Upholstery, glazed maroon chintz with yellow flowers Chair seats, bright yellow leather	Gold	Specially appropriate for Victorian dining room
AMERICAN BEAUTY	Linen color	Fawn	Draperies, fawn and American beauty Upholstery, American beauty, fawn, blue and gray	Blue	Dramatic color scheme for fairly large living room
RED DAHLIA	Gray	Red Dahlia	Draperies, light neutral background with dahlia and melon green in pattern Upholstery, melon green	Larkspur Blue	Adaptable to various types of living rooms
OLD RED	Soft light shade Old Red	Deep Old Red	Draperies, old red, beige and white stripes Upholstery, light tan	Copper	Warm, colorful plan for a room inclined to be cold
BURGUNDY (1)	Pale clear yellow	Burgundy	Draperies, white, valance and trimming Upholstery, burgundy and white	Gold	Rich color scheme for formal room
BURGUNDY (2)	Burgundy	Darker Burgundy	Burgundy and natural	Chartrouse	For large room, living room or library
BURGUNDY (3)	Warm Gray with pinkish cast	Burgundy	Draperies, primrose yellow Upholstery, pale grayed blue and white	White	Good for any room not too small or too sunny
BURGUNDY (4)	Beige with pinkish cast	Burgundy	Draperies, beige background, shell pink and burgundy in pattern Upholstery, shell pink	Grayed White	Same as above



## THE ORANGE FAMILY

REPRESENTATIVE MEMBERS OF THE ORANGE FAMILY . . . IVORY . . . PEACH . . . CORAL . . . BEIGE . . .  
 . . . RUST . . . TERRA COTTA . . . WARM BROWN.  
 CHARACTERISTICS . . . Always warm, advancing . . . Cheerful, welcoming, gay, vibrant, glowing . . . In  
 strong tones, akin to red . . . In softer tones, a good mixer.  
 WHAT THEY CAN DO . . . In slightly less degree, Orange repeats the activities of the Red Family . . . Effect-  
 tive for "ionizing" up a room in too dull or quiet colors, or warming a cold room.  
 CORRECT USES . . . Best in off shades, except for accent . . . In softened tones, excellent background color  
 for dark or cold rooms . . . Wonderful accent color in proper combinations.  
 CAUTION . . . Do not use too much of the clear color . . . In large areas it has the disturbing quality of  
 red . . . Do not use for background of small room unless you want it to be very "cozy."

## SUGGESTED COLOR SCHEMES IN WHICH MEMBERS OF ORANGE FAMILY PLAY A DOMINANT ROLE

DOMINANT COLOR	MAJOR WALL COLOR	MAJOR FLOOR COLOR	DRAPERIES AND UPHOLSTERY	ACCENT COLORS	REMARKS
IVORY	Ivory Woodwork, Ivory	Floor, painted Ivory Rug, Jade Green	Ivory background, rose and blue green in pattern	Rose and Jade Green	Charming for bedroom or lady's sitting room with ivory painted furniture
PEACH (1)	Peach	Peach	Apple green	Blistergreen	Attractive for bedroom, modern or traditional
PEACH (2)	Peach	Old Green	Draperies and upholstery, peach, with old blue	Old Blue	For a room that needs warming up, with cool touches
PEACH (3)	Peach	Warm Brown	Draperies, brown and coral stripes Upholstery, brown background, with coral, beige and tan	Copper	Modern color scheme appropriate for living room or library
PEACH (4)	Paper, shades of yellow, through peach to brown	Brown	Draperies, brown Upholstery, light and dark peach	Yellow	Good modern living room color scheme
PEACH (5)	Floor pattern paper, white ground, peach and green	Rust	Draperies, peach Upholstery (chair seats), green	Green	Very good for late Colonial dining room with Duncan Phyfe style furniture
PEACH (6)	Yellowish Pink	Eggplant	Draperies, peach background, blue in design Upholstery, peach and blue	Coral and yellow	Good color scheme to lighten dark bedroom
APRICOT	Apricot	Rose and Cream	Draperies, old rose Bed and furniture coverings, apricot, trimmed with black	Orchid	Charming for young girl's room
CORAL (1)	Paper, silver ground, coral-rose design; Woodwork, coral	Aquamarine	Aquamarine	Aquamarine and Silver	Charming for woman's bedroom
CORAL (2)	Coral Woodwork, soft Blue	Gray Blue	Draperies, off-white background rose and green in design, Coral valance, Bed and furniture covering, copper rose and some chintz used for hangings	Off-white	Attractive for bedroom with furniture painted blue
WARM BEIGE (1)	Warm Beige	Warm Beige	Brown and Copper	Bright Green	Modern living room or library
WARM BEIGE (2)	Pink and Beige wallpaper	Warm Beige	Draperies, old white and beige Upholstery, dusty pink and pale olive green	Terra Cotta	Restful living room color scheme
WARM BEIGE (3)	Warm Beige	Warm Beige	Draperies, burgundy background, white and beige in design; Upholstery, burgundy and natural	White	Good for living room, library, or man's bedroom
WARM BEIGE (4)	Warm Beige	Dark Taupe	Draperies, russet (beige glass curtains) Upholstery, brown with tan cushions	Tan	Restful, chromatic color scheme
WARM BEIGE (5)	Beige with pink cast	Light warm beige	Brown, beige and white stripes or checks	Sky Blue	Appropriate for informal living room or boy's room
HENNA (1)	Grass cloth, tan and gold	Henna and black	Henna, green and gray	Gold	Living room or man's bedroom
HENNA (2)	Mint Green Woodwork, Cream	Henna	Draperies, henna with valance of bedspread material Bedspread, henna, light and dark green and tan stripes Upholstery, same combination in patterned material	White	Man's bedroom
TERRA COTTA	Pink Terra Cotta	Eggplant	Draperies, pinkish yellow, trimmed with terra cotta Upholstery, bois de rose	Pale Green	Charming for dining room in Dijonaise feeling with furniture painted yellow and gold
COPPER (1)	Fine paneled	Floor, Pine Rugs (hooked) in tones of orange, yellow, green	Draperies, copper toned background with orange, yellow and green in pattern	Blue and copper	Appropriate for living room in Early American feeling with Early American style furniture
COPPER (2)	Rough plaster with oak paneling	Oak plank floor Patterned rug, tones of brown, green, copper	Draperies, copper colored, coarsely woven material Upholstery, neutral green, trimmed with brown and copper	Green	Good color scheme for large, formal, English-style living room, with furniture in natural oak and walnut
BURNT ORANGE	Neutral Woodwork, walnut	Rug, greenish background, with burnt orange and henna	Burnt orange and henna	Blue	Good for dining room with walnut furniture
WARM BROWN (1)	Tobacco Brown	Warm Beige	Chintz in clear yellow, beige and warm brown in design	White	Modern living room or library
WARM BROWN (2)	Tan	Warm Brown	Draperies, copper and topaz; Upholstery, warm browns	Orange, French Blue	Appropriate for boy's room
WARM BROWN (3)	Yellow Brown	Orange Brown	Burnt orange and apple green	Greenish Blue	Restful, cheerful color scheme for library
WARM BROWN (4)	Pale Yellow	Orange Brown	Shades of warm browns and orange	Silver	Attractive for modern living room or dining room

## COLOR THEORY

Color Families: Yellow

## THE YELLOW FAMILY

REPRESENTATIVE MEMBERS OF THE YELLOW FAMILY . . . CREAM . . . STRAW . . . CANARY . . . GOLD . . . TAN . . . BROWN.  
 CHARACTERISTICS . . . Warm, somewhat advancing . . . The sunlight color—gay, happy, bright, cheerful . . . In light tones, luminous, radiant.  
 WHAT THEY CAN DO . . . Diffuse and increase light by reflection, making dark rooms seem lighter and brighter . . . In pale tints, yellow lights up a small room without making it seem smaller because reflective radiance

of yellow balances its advancing quality as a warm color.  
 CORRECT USES . . . Excellent background for all average rooms . . . In light tints, best well-background for poorly lighted rooms . . . In clear, bright tones, safe accent color almost everywhere.  
 CAUTION . . . Do not use yellow without testing under artificial light, and providing lamp shades to offset color changes . . . Don't use in wide expanses in a very sunny room . . . Don't use bright tones without restful combination color.

## SUGGESTED COLOR SCHEMES IN WHICH MEMBERS OF YELLOW FAMILY PLAY A DOMINANT ROLE

DOMINANT COLOR	MAJOR WALL COLOR	MAJOR FLOOR COLOR	DRAPERIES AND UPHOLSTERY	ACCENT COLORS	REMARKS
CREAM	Cream Woodwork, cream	Patterned rug, mulberry, green and cream	Draperies, green, cream trimming Upholstery, green and green yellow	Mulberry	Appropriate for bedroom, especially in Directoire feeling with cream and gold furniture
BUFF	Buff	Buff	Copenhagen blue and burgundy	Orange, Tete de Negre	Glowing color scheme for living room or man's bedroom
PALE YELLOW (1)	Pale Yellow	Soft Beige	Draperies, light yellow background, soft reds, greens and blue in pattern Upholstery, soft blue, hints of draperies	Green and Red	Good color scheme for medium-sized dark room
PALE YELLOW (2)	Pale Yellow	Pale Yellow	Turquoise	Coral	Colorful for bedroom or small sitting room
BRIGHT LEMON (1)	Bright Lemon	Beige	Draperies, beige background, yellow green and lavender Seat covers, wet leaf green	Wet Leaf Green	This color scheme will brighten up a dark dining room
PALE LEMON (2)	Pale Lemon Yellow Woodwork, white	Tobacco Brown	Draperies, white with yellow trimming Upholstery, emerald green; some pieces white, yellow, dull orange	Orange	Suitable for living room with north light
JONGUIL YELLOW (1)	Jonguil Yellow	Gray	Draperies, white, trimmed with Chinese red Upholstery, warm gray and white	Chinese Red	Charming for living room, modern or traditional
JONGUIL YELLOW (2)	Jonguil Yellow	Soft Blue-Green	Draperies, white and yellow Upholstery, soft blue, green and white	White	Good for any room without too much light
YELLOW (1)	Yellow	Brown	Blue and apple green	Black	Good for room with cold light
YELLOW (2)	Yellow	Brown	Dutch blue and white	Bright Red	Attractive for informal living room
YELLOW (3)	Marbled yellow paper Woodwork, deep green	Deep Green	Draperies, green, yellow trimming Chair seat upholstery, yellow	Blue	Charming for dining room, especially in Directoire feeling
YELLOW (4)	Paper in Yellow and Ivory stripes, divided by narrow plum lines	Yellow Tan	Draperies, gray background, yellow, plum and rose in pattern Upholstery, blue and light tan	Old Gold	Good combination for dark maple woodwork
GRAYED YELLOW	Grayed Yellow	Brown	Draperies, brown and beige stripes Upholstery, yellow, beige, moss green	White	Pleasant for living room or man's bedroom
SOFT YELLOW	Soft Yellow	Deep Brown	Draperies, yellow Upholstery, cinnamon brown	Chartruse	Attractive and restful for library or living room
EMPIRE YELLOW	Slate Gray	Lime Green	Draperies, Empire yellow Upholstery, Strong clear yellow	Silver	Suitable for living room or dining room
CITRON YELLOW	Citron Yellow	Citron Yellow	Coral	Silver	Modern or traditional living room
LEMON YELLOW	Lemon Yellow	Tete de Negre	Brown and henna	Orange	Distinctive for modern living room
SULPHUR YELLOW	Sulphur Yellow	Olive Green	Shades of green and sulphur	Coral	Colorful modern living room

**COLOR THEORY**  
 Color Families: Yellow

DEEP YELLOW	Deep Yellow	Red	Draperies, gold damask Upholstery, plum, wine red, gold with red, blue, lavender in pattern	Gold	Suitable for period room with Queen Anne, Sheraton, and other Georgian style furniture
MUTED GOLD	Caramel	Bleached wood, rubbed with gold and waxed	Draperies, soft caramel taffeta, trimmed with brown Upholstery, brown and yellow	Ebony	Unusual modern living room scheme where there is plenty of light
GOLD (1)	Yellow, flat finish Woodwork, Olive Green	Old gold carpet	Draperies, old gold, trimmed with green Upholstery, olive green and paprika	Light Green	Charming for modern living room with blond wood
GOLD (2)	Gray and pale Yellow paper	Harvest Gold and Gray	Draperies, oyster white, trimmed with multi-color fringe Upholstery, rust-shot silk	Brass	Traditional or modern dining room
TAN (1)	Neutral Tan	Dark Tan	Draperies, burnt orange Upholstery, brown and burnt orange	Rich Chocolate	Good with natural wood tones
TAN (2)	Tan linen color	Light and dark Tan	Draperies, tan and rose stripes Upholstery, linen color with rose, tan, gray and blue in pattern	Rose	Attractive for living room or library with walnut woodwork and furniture
TAN (3)	Tan	Brown Taupe	Dark green and vermilion	Brown	Rich, warm color scheme for living room or library, especially with walnut furniture and paintings
TAN (4)	Brownish Tan	Floor, Oak Multi-colored scatter rugs	Draperies, brown with red, yellow and blue pattern Upholstery, old red and yellow chintz	Blue	Suitable for bedroom with oak furniture in Early English feeling
BROWN (1)	Brown paneled	Deep Brown	Beige background with brilliant gold, scarlet and orange tones of fall foliage	Blue	Attractive for living room with plenty of light
BROWN (2)	Pine paneled	Pine	Old chintz in blue and brown	Silver and Pewter	Dining room in French Provincial style
BROWN (3)	Warm Beige with brown cast	Brown	Draperies, brown, beige and dusty pink Upholstery, brown and off-white	White	Appropriate for modern living room
BROWN (4)	Pine paneled	Hooked Rugs	Yellow, copper and blue chintz	Green	Suitable Early American living room with maple furniture
BROWN (5)	Chalk White	Brown	Turquoise	Peach	Charming bedroom color scheme
SABLE BROWN (1)	Sable Brown	Off-white	Draperies, off-white with turquoise Upholstery, shell pink and off-white	Turquoise	Distinctive modern living room
SABLE BROWN (2)	Sable Brown	Deep warm Beige	Draperies, bright yellow Upholstery, plain charrreuse with white pattern	Earth Brown	Same as above
CHESTNUT BROWN	Fawn	Chestnut Brown	Champagne background, beaver, turquoise and apricot in pattern and trimming	Turquoise	Appropriate for living or dining room
TAWNY BROWN	Tawny Brown Pine	Light beige and taupe	Blue on light ground	Yellow	Good for dining room in French period feeling
GOLDEN BROWN	Knotty Pine	Golden Brown Navajo rug	Draperies, colorful hunting print Upholstery, red leather	Blue and Green	Library or Den
NUT BROWN	Nut Brown Pine	Moss Green	Draperies, dark linen Upholstery, green, brown and white	Yellow	Restful living room color scheme
TOBACCO BROWN	Tobacco Brown	Beige	Clear yellow chintz with beige and dark brown in design	White	Suitable modern dining room with much sunlight
CHOCOLATE BROWN	Chocolate Brown	Eggshell	Draperies, white Upholstery, charrreuse, brown and eggshell	Charrreuse	Interesting modern color scheme for living room or dining room
DARK BROWN (1)	Deep Beige	Dark Brown	Draperies, pale, clear blue Upholstery, cinnamon brown	Pale Clear Blue	Good for dining room or living room
DARK BROWN (2)	Light Charrreuse	Dark Brown	Light tan and brown	White	Good for modern living room
BROWNS	Light Brown	Deep Brown	Draperies, off-white Upholstery, Wedgwood green and off-white	Gold	Suitable for living or dining room

## COLOR THEORY

Color Families: Green

## THE GREEN FAMILY

REPRESENTATIVE MEMBERS OF THE GREEN FAMILY . . . NILE . . . LETTUCE . . . PEA . . . GRASS . . .  
 SEA . . . OLIVE . . . BOTTLE . . . ETC.  
 CHARACTERISTICS . . . Cool, receding—except when mixed with a warm color . . . Most restful color . . .  
 Friendly with all other colors, refreshing, versatile . . . Endless variety of tones and combinations.  
 WHAT THEY CAN DO . . . In light, soft tints, makes rooms seem larger because the wall seems farther  
 away . . . Makes objects seem farther away, therefore smaller . . . Brings atmosphere of rest and relaxa-  
 tion to room.  
 CORRECT USES . . . One of best background colors for average rooms, especially where restfulness is impor-  
 tant . . . Great corrective value for rooms too small or too warm . . . Suitable in proper tones for  
 background in any part of room—floor, walls, ceiling.  
 CAUTION . . . Do not use in quantity in cold, dark or overlarge rooms—choose warm, advancing colors for  
 background, keeping green for smaller areas.

## SUGGESTED COLOR SCHEMES IN WHICH MEMBERS OF GREEN FAMILY PLAY A DOMINANT ROLE

DOMINANT COLOR	MAJOR WALL COLOR	MAJOR FLOOR COLOR	DRAPERIES AND UPHOLSTERY	ACCENT COLORS	REMARKS
PALE GREEN (1)	Pale Green	Dark Green	Draperies, off-white background, with pale blues, greens, and mauve in pattern Upholstery, darker blue	Mauve and Violet	Appropriate for average living room and bedroom
PALE GREEN (2)	Pale Green	Plum	Draperies, natural linen color, with flowered plum and green in design Upholstery, plum, gold, green	Gold	Especially good for traditional living room
LIGHT GREEN (1)	White	Light Green	Draperies, white with dark green pattern Upholstery, dark green and white	Yellow	Pleasant color scheme for modern room
LIGHT GREEN (2)	Pickled Pine	Light Green	Draperies, off-white and light green Upholstery, light green	Brown	Attractive for living room or library
LIGHT GREEN (3)	Off-white	Soft Light Green	Shell-pink, green and off-white	Crystal	Charming and cool for small living room or sitting room
APPLE GREEN (1)	Apple Green	Plum	Draperies, apple green Upholstery, gold, yellow and ivory	Gold	Good for small living room
APPLE GREEN (2)	Apple Green	Yellow Green	Gray, blue, and touches of light yellow	Light Yellow	This combination makes cool room
APPLE GREEN (3)	Pale Apple Green	Floor, brown walnut Rug, blue and tan	Draperies, royal blue background, with rose and green leaves in pattern Upholstery, some drapery chintz, also rose, antique salmon, apple green and cream stripes	Black, gold, white and ruby	Early American living room with maple or cherry furniture
SOFT GREEN (1)	Soft Green	Deeper Green	Draperies, plum background with beige and green in pattern Upholstery, plum, beige and green	Orange	Restful Color Scheme
SOFT GREEN (2)	Soft Grayed Green	Deeper Green	Draperies, corn yellow Upholstery, grayed green and off-white	Pine Green	Adaptable to living room, dining room or bedroom
SOFT GREEN (3)	Pale Soft Grayed Green	Ivy Green	Draperies, soft grayed green Upholstery, golden yellow and white	Lacquer Red	Excellent to add feeling of space to small room
FOAM GREEN	Slate Gray	Foam Green	Draperies, lemon yellow and white Upholstery, lemon yellow and gray	Gold	Good modern color scheme
IVY GREEN	Clear Beige	Ivy Green	Draperies, beige with light and dark green floral design Upholstery, same chintz and some clear beige	Black	Appropriate for living room
DEEP LIME	Deep Lime	Deep Lime	White, green and melon pink	White	Dramatic modern scheme, especially good with blond wood

## COLOR THEORY

Color Families: Green

	Nile Green	Green	Glazed chintz with green background and white in design, red lining and trimming	Crystal	Cool, airy bedroom
<b>NILE GREEN</b>					
<b>MINT GREEN</b>	Pure White Woodwork, white	Painted Mint Green, spatter-dashed with turquoise and yellow	Turquoise, yellow and mint green	White	Adaptable for informal living room, dining room or bedroom
<b>JADE GREEN</b>	Pale Jade	Dark Blue	Draperies, blue Upholstery, blue and jade green	Silver	Attractive for modern living room
<b>SAGE</b>	Slate Gray	Soft Deep Sage	Gray and blue with green touches	Silver	Excellent color to make small sunny room seem larger and cooler
<b>BOTTLE GREEN</b>	Pale Apricot	Bottle Green	Green, apricot and topaz	Topaz	Good for living room or dining room
<b>CHARTREUSE GREEN</b>	Chartreuse Green	Shades of Tete de Negre	Draperies, chartreuse green Upholstery, shades of heliotrope	Silver	Modern bedroom. Good with furniture painted chartreuse
<b>CHARTREUSE GREEN</b>	Gray	Chartreuse	Chartreuse and bright blue	Silver	Adaptable to any modern room
<b>TURQUOISE</b>	Light Turquoise	Patterned rug, Green with Moss Rose	Draperies, turquoise, green and rose stripes Upholstery, turquoise	Rose	Attractive for bedroom with mahogany furniture
<b>BLUE GREEN (1)</b>	Deep Cream	Blue Green	Apple green, greenish blue, touch of burnt orange	Burnt Orange	Versatile color scheme for average room
<b>BLUE GREEN (2)</b>	Blue Green	Blue Green	Draperies, light grayish tan background, turquoise, rose and green in pattern Upholstery, some print and some soft rose	Green	Very restful for living room or bedroom
<b>BLUE GREEN (3)</b>	Dull Blue Green	Rug, light field, red violet and green leaves in pattern	Draperies, white Upholstery, red violet	Dark Green	Dining room in period feeling with walnut furniture
<b>WET LEAF GREEN</b>	Deep Lime	Bronze	White background, wet leaf green, down rose and bright lemon in pattern	Rose	Sophisticated modern color scheme
<b>DEEP GREEN (1)</b>	Deep Green	Gray	Draperies, sky blue chintz with rose and green pattern Upholstery, emerald green and gray	Gold and Rose	Suitable for living room or man's bedroom
<b>DEEP GREEN (2)</b>	Gray and White paper, Black pattern	Deep Green	Draperies, yellow Upholstery, yellow flowers and pale green leaves on gray background	White and Green	Modern living room or dining room
<b>DEEP GREEN (3)</b>	Green, lighter than carpet	Deep Soft Green	Draperies, off-white Upholstery, off-white and Wedgwood green	Yellow	Very cool and fresh
<b>DEEP GREEN (4)</b>	Greenish Gray	Deep Green	Draperies, apple green Upholstery, grayed greens and white	Salmon	Good combination to make small room seem larger
<b>DEEP GREEN (5)</b>	Deep Soft Green	Light Brown	Golden yellow and white	White	Modern or traditional setting
<b>GEORGIAN GREEN</b>	Deep Georgian Green	Deep Green	Draperies, soft golden yellow Upholstery, golden yellow and deep green	Gold	Very cool and restful for period living room or library
<b>DARK GREEN (1)</b>	Ivory Green	Dark Green	Draperies, white with dark green pattern Upholstery, off-red, off-white and dark green	Black	Subtle color combination. Good for living room or dining room
<b>DARK GREEN (2)</b>	Warm Gray	Dark Green	Draperies, dark green or gray background Upholstery, light green	Yellow	Cool and restful for living room
<b>DARK GREEN (3)</b>	Dark Green	Tan	Draperies, chintz in blue-green and soft red Upholstery, same chintz, also some soft red	Copper	Charming for sunny living room
<b>GREEN OLIVE</b>	Green Olive	Red-Coral	Lime green, red-coral, antique white	Coral and White	Daring modern color scheme. Good with traditional or modern furniture in light finish

## COLOR THEORY

Color Families: Blue

## THE BLUE FAMILY

REPRESENTATIVE MEMBERS OF THE BLUE FAMILY . . . PALE . . . BABY . . . SKY . . . POWDER . . .  
 NAVY . . . MIDNIGHT . . . ETC.  
 CHARACTERISTICS . . . Coldest, most receding, unless mixed with warm colors . . . Serene, quiet, "spacious"  
 WHAT THEY CAN DO . . . Make room seem larger, cooler, more airy and spacious . . . Make objects look

smaller because they seem more distant . . . In dark tones, make lighter contrast colors more luminous.  
 CORRECT USES . . . In light tones, excellent background for small, dark, warm rooms . . . Good combining  
 color, especially in soft tones . . . Effective background for many other colors.  
 CAUTION . . . Do not use in quantity in cold or dark or over-large rooms . . . Do not use too much in dull  
 shades . . . Do not use without some warm bright accent color.

## SUGGESTED COLOR SCHEMES IN WHICH MEMBERS OF BLUE FAMILY PLAY A DOMINANT ROLE

DOMINANT COLOR	MAJOR WALL COLOR	MAJOR FLOOR COLOR	DRAPERIES AND UPHOLSTERY	ACCENT COLORS	REMARKS
PALE BLUE (1)	Pale Blue	Dark Blue	Tan draperies and upholstery	Silver	Modern color scheme for bedroom with furniture in lemon color
SKY BLUE	Garden Sky Blue	Champagne	Champagne, sky blue and orchid	Orchid	Modern color scheme, good with light natural finish woods
POWDER BLUE (1)	Powder Blue	Delft Blue	Draperies, canary yellow Upholstery, yellow and powder blue	Off-white	Cool and fresh for bedroom
POWDER BLUE (2)	Powder Blue	Powder Blue	White draperies and upholstery	Peach	Dainty feminine bedroom
LARKSPUR BLUE (1)	Larkspur Blue	Pale Gray	Draperies, wine, trimmed with white Upholstery, deep blue and white	Deep Blue and Wine	Good modern living room combination
LARKSPUR BLUE (2)	Larkspur Blue	Blue	Neutral background, blue and pink in pattern	Red Dahlia	Any period room with enough light
BLUE (1)	Pale Blue, deep Rose and Ivory paper	Blue	Blue, gold and rose with touches of black—in stripes or plain	Black	Attractive for traditional living room
BLUE (2)	Faded Blue (middle value)	Floor, dark Brown Carpet, Gray and Yellow	Draperies, old yellow Upholstery, yellow, old yellow, and touch of Venetian red, also some blue	Blue	Bedroom with Directoire feeling and walnut furniture
BLUE (3)	Striped wallpaper in tones of light and medium blue and White	Dark Blue	Draperies, blue with white in pattern and trimming Upholstery, lemon yellow	Dark Blue	Good for small, low-ceilinged but light room
HYDRANGEA BLUE (1)	Pale Hydrangea Blue	Eggplant	Draperies, peach background with white, copper, gold and hydrangea blue in design Upholstery, some chintz, also old blue	Old Blue	Good for room with strong light, especially with 18th Century furniture
HYDRANGEA BLUE (2)	Hydrangea Blue	Deeper Blue	Draperies, salmon pink Chair seats, black and gold	Gold	Dining room with Directoire feeling
COPENHAGEN BLUE	Copenhagen Blue	Burgundy	Gray with blue and burgundy	Rose and Silver	Attractive for traditional living room
PENCIL BLUE	Lemon Yellow	Pencil Blue	Blue background with yellow in pattern and trim	Silver	Setting for dining room with modern furniture



MEDIUM BLUE (1)	Blue	Mulberry ground	Draperies, cherry red Upholstery, chintz in blue, rose and mauve, some pieces in cherry red and gold	Gold	Good for living room, especially in 18th Century French feeling
MEDIUM BLUE (2)	Blue	Mole	Lavender, gray, and some rose	Rose	Adaptable for lady's bedroom in lighter blues, also to living room in darker shades of delft blue
MEDIUM BLUE (3)	Cream	Blue	French Blue	Jade Green	Good for south living room or bedroom
DUSTY BLUE	Dusty Blue	Dark Burgundy	Draperies, gray, trimmed with soft blue Upholstery, soft blue and gray	Crystal	Restful for living room or dining room
SOFT DULL BLUE	Ivory	Soft Dull Blue	Ivory background with blue, rose and green in design, some pieces in old rose	Green	Bedroom or informal living room
OLD BLUE	Old Blue	Deeper Blue	Faded Pink, or chintz with blue, green and pink	Green	Charming for living room or bedroom
GRAYED BLUE	Gray Blue	Deeper grayed Blue	Yellow, white, and gold	Red	Dining room in Directoire feeling with mahogany
TURQUOISE BLUE	Pale Turquoise Blue	Turquoise	Draperies, golden yellow Upholstery, golden yellow and white	White	Any room not too large or too dark
TURQUOISE BLUE	Grayed Turquoise	Grayed Turquoise	Wine and Ivory	Polished Brass	Dignified but friendly living room
GREEN BLUE	Green Blue	Plum rug; flowered pattern	Draperies, peach Upholstery, green-blue with some plum	Peach	Simple living room in French Provincial feeling
ROYAL BLUE (1)	Walls, Silver Woodwork, Royal Blue	Floor, painted Gray Rug, Blue	Draperies, blue, trimmed with silver Upholstery (chairs), silver and blue leather	Silver and Black	Distinctive modern dining room
ROYAL BLUE (2)	Old White	Royal Blue	Clear yellow	Silver	Modern living or dining room
ROYAL BLUE (3)	Dull White	Rug, Deep Blue ground with honey-yellow in pattern	Draperies, royal blue Chair Seats, royal blue Morocco	Silver	Attractive for modern dining room, especially with lemon wood furniture
DEEP BLUE (1)	Pale Amethyst	Deep Blue	Deep blue, trimmed with gold	Amethyst and Gold	Cool and charming for living room not too dark
DEEP BLUE (2)	Deep Blue Woodwork, Ivory	Dark Blue rug with Tan and Rose in pattern	Draperies, dull ivory Upholstery (chairs), ivory or rosy red leather	Red	Colorful for dining room with plenty of light
DEEP BLUE (3)	Deep Blue	Deep Blue	Draperies, deep sea blue Upholstery, canary yellow	White	Modern living room or dining room
DEEP BLUE (4)	Pale Yellow	Natural	Draperies, deep sea blue (gold gauze glass curtains) Upholstery, deep blue	White	Good when blue is dominant color in a dark room
DEEP BLUE (5)	Creamy White	Blue	Draperies, deep blue Upholstery, yellow with dash of white	Gold, Rose-Pink and Blue	Good for bedroom, furniture painted blue with flower decorations, and some smaller oyster white pieces
GARDEN POOL BLUE	Ivory	Garden Pool Blue	Draperies, garden pool blue Chair Seats, red leather	White and Silver	Dramatic modern living room with furniture in rich mahogany or walnut tones
DARK BLUE	Cream and beige paper	Dark Blue rug with rose and tan in pattern	Draperies, linen color with blues, greens and rosy reds in pattern Chair Seats, dark blue	Blue and Silver	Good for dining room where light is needed

## COLOR THEORY

Color Families: Violet/Purple

## THE VIOLET (OR PURPLE) FAMILY

REPRESENTATIVE MEMBERS OF THE VIOLET FAMILY . . . ORCHID . . . LAVENDER . . . MAUVE . . .  
 VIOLET . . . PLUM . . . PURPLE.  
 CHARACTERISTICS . . . Cool when mixed with blue, warm when mixed with red . . . In pure form, cold and formal . . . In purple tones, rich and dignified but not friendly . . . May be depressing.  
 WHAT THEY CAN DO . . . Add to impression of room size and coolness, especially when mixed with blue

. . . Create restful, quiet atmosphere when used in soft tones.  
 CORRECT USES . . . In light, soft tints, excellent wall and ceiling background for an average room . . .  
 Strong shades good for accent . . . In deep, soft tones, attractive for carpets, upholstery, draperies.  
 CAUTION . . . Do not use blue tones of violet in cold, dark, over-large rooms . . . Be careful when using strong shades for dominant color . . . Do not use without some warm contrast.

## SUGGESTED COLOR SCHEMES IN WHICH MEMBERS OF VIOLET FAMILY PLAY A DOMINANT ROLE

DOMINANT COLOR	MAJOR WALL COLOR	MAJOR FLOOR COLOR	DRAPERIES AND UPHOLSTERY	ACCENT COLORS	REMARKS
ORCHID (1)	Orchid	Blue	Champagne, orchid and blue	Black and Silver	Attractive for living room
ORCHID (2)	Paneled paper in Orchid and Pale Yellow	Mulberry	Green, yellow and orchid chintz	Green	Cool, airy bedroom
LAVENDER (1)	Lavender	Lavender with mauve border	Gray, light blue and touches of jade green	Jade Green	Good for sunny room
LAVENDER (2)	Lavender, Blue and White paper	Plum	Lavender	Rose	Feminine bedroom
LAVENDER (3)	Pale Lavender	Rose	Pink, lavender and white	Lavender	Bedroom with warm light
HELIOTROPE (1)	Gray	Beige	Heliotrope draperies and upholstery	Violet and Silver	Lovely color scheme for woman with gray hair
MAUVE (1)	Gray	Mauve	Light blue, Nile green, some rose	Rose	Good for sunny bedroom
MAUVE (2)	Paneled wall painted Pale Mauve	Deep Violet	Mauve and yellow	Crystal and Sepia	Especially attractive for Louis XVI style bedroom with walnut furniture
HELIOTROPE (2)	Pearl Gray	Heliotrope	Draperies, heliotrope trimmed with silver Upholstery, taragon green, gray and heliotrope	Green	Cool and restful living room
VIOLET	Dove Gray	Black and White	Draperies, violet Upholstery, coral and old gold	Silver and Black	Attractive with silver gray painted woodwork and violet lines, also white and gold furniture
MULBERRY (1)	Dusty Mulberry	Mahogany	Draperies, clear blue chintz with mulberry and brown in pattern Upholstery, clear blue	White	Very good for traditional living room or dining room
MULBERRY (2)	Dusty Mulberry	Ebony	Draperies, creamy peach chintz with gray, old rose and ebony design Upholstery, creamy peach	Black	Good for sunny living room or dining room
MULBERRY (3)	Scenic paper Woodwork, walnut	Deep Mulberry	Mulberry	Orange	Traditional dining room
PURPLE	Paper in Gray and soft Purple stripes	Gray	Purple, with blue, green and gray	Burnt Orange	Hall or living room



## COLOR THEORY

Reflective Values; Safety Color Guides

TABLE 1 Reflective Values

Color	Approx. percent of reflection
White, dull or flat	75–85
White, gloss	85–90
Light tints	
Cream or eggshell	79
Ivory	75
Pale pink and pale yellow	75–80
Light green, light blue, light orchid	70–75
Soft pink, light peach	69
Light beige, pale grey	70
Medium tones	
Apricot	56–62
Pink	64
Tan, yellow gold	55
Light greys	35–50
Medium turquoise	44
Medium light blue	42
Yellow green	45
Old gold, pumpkin	34
Rose	29
Deep tones	
Cocoa brown, mauve	24
Medium green, medium blue	21
	20
Unsuitable dark colors	
Dark brown, dark grey	10–15
Olive green	12
Dark blue, blue green	5–10
Forest green	7
Natural wood tones	
Birch and beech	35–50
Light maple	25–35
Light oak	25–35
Dark oak, cherry	10–15
Redwood	10–15
Black walnut, mahogany	5–15

Recommended ceiling values should be in the range of 60–90%. Floor reflection values should be in the range of 15–35%. Overall reflection values of a room should be in the 35–60% range.

## Safety Color Guides

Physical hazards:

*Red:* Fire protection equipment and apparatus; danger; stop

*Orange:* Dangerous parts of moving machinery

*Yellow:* Physical hazards that might cause stumbling, falling, etc.

*Green:* Safety – first-aid dispensary or kits, stretchers, safety deluge showers, etc.

*Blue:* Caution against movement or use of equipment being worked on such as elevators, scaffolding, etc.

*Black and White:* Traffic direction; sanitation

Equipment in industrial plants:

*Red:* Fire protection systems and equipment

*Orange:* Dangerous materials, nonflammable, such as acids, alkalis, toxic materials, gases, oxygen

*Yellow:* Dangerous materials, flammable, such as fuel oil, gasoline, kerosene, alcohol, propane, butane, acetylene, hydrogen, and solvent

*Green:* Safe materials, such as drinking water, service water, brine

*Blue:* Protective materials

*Violet:* Valuable materials

*Black:* Electrical conduit

## COLOR THEORY

## Color Effect

TABLE 2

Color Effects of White Fluorescent Lamps							
	Cool* White	Deluxe* Cool White	Warm† White	Deluxe† Warm White	Daylight	White	Soft White— Natural
Lamp appearance; effect on neutral surfaces	White	White	Yellowish white	Yellowish white	Bluish white	Pale yellowish white	Pinkish white
Effect on "atmosphere"	Neutral to moderately cool	Neutral to moderately cool	Warm	Warm	Very cool	Moderately warm	Warm, pinkish
Colors strengthened	Orange, yellow, blue	All nearly equal	Orange, yellow	Red, orange, yellow, green	Green, blue	Orange, yellow	Red, orange
Colors grayed	Red	None appre- ciably	Red, green, blue	Blue	Red, orange	Red, green, blue	Green, blue
Remarks	Blends with natural daylight	Best over- all color rendition; simulates natural daylight	Blends with incan- descent light	Excellent color ren- dition; simulates incandescent light	Usually replacable with CW	Usually re- placable with CV or WW	Usually re- placable with CWX or WWX
Color Effects of Mercury and Filament Lamps							
	Mercury	White Mercury	Color- Improved Mercury	Deluxe White Mercury	Filament		
Lamp appearance; effect on neutral surfaces	Greenish blue white	Greenish white	Yellowish white	White	Yellowish white		
Effect on "atmosphere"	Very cool, greenish	Moderately cool, greenish	Warm, yellowish	Moderately cool	Warm		
Colors strengthened	Yellow, green, blue	Yellow, green, blue	Yellow, green	Orange, yellow, blue	Red, orange, yellow		
Colors grayed	Red, orange	Red, orange	Blue	Green	Blue		
Remarks	Poor overall color rendering		Color render- ing often acceptable, but not equal to any white fluorescent	Color render- ing good; compares favorably with CWX fluorescent	Excellent color rendering		

\* Greater preference at higher levels.

† Greater preference at lower levels.

## WINDOW TREATMENTS

## Window Types

Windows are available in many types, each having advantages. The principal types are double-hung, casement, stationary, awning, and horizontal sliding. They may be made of wood or metal. Heat loss through metal frames and sash is much greater than through similar wood units. Glass blocks are sometimes used for admitting light in places where transparency or ventilation is not required.

Insulated glass, used both for stationary and moveable sash, consists of two or more sheets of spaced glass with hermetically-sealed edges. This type has more resistance to heat loss than a single thickness and is often used without a storm sash.

Wood sash and door and window frames should be made from a clear grade of all-heartwood stock of a decay resistant wood species or from wood which is given a preservative treatment. Species commonly used include ponderosa and other pines, the cedars, cypress, redwood, and the spruces.

### Double-Hung Windows

The double-hung window is perhaps the most familiar window type. It consists of an upper and lower sash that slide vertically in separate grooves in the side jambs or in full-width metal weatherstripping. This type of window provides a maximum face opening for ventilation of one-half the total window area. Each sash is provided with springs, balances, or *compression weatherstripping* to hold it in place in any location. Compression weatherstripping, for example, prevents air infiltration, provides tension, and acts as a counterbalance; several types allow the sash to be removed for easy painting or repair.

The *jambs* (sides and top of the frames) are made of nominal 1-inch lumber; the width provides for use with dry-wall or plastered interior finish. Sills are made from nominal

2-inch lumber and sloped at about 3 in 12 for good drainage. Sash are normally 1 $\frac{3}{8}$  inches thick and wood combination storm and screen windows are usually 1 $\frac{1}{2}$  inches thick.

Sash may be divided into a number of lights by small wood members called *muntins*. A ranch-type house may provide the best appearance with top and bottom sash divided into two horizontal lights. A colonial or Cape Code house usually has each sash divided into six or eight lights. Some manufacturers provided preassembled dividers which snap in place over a single light, dividing it into six or eight lights. This simplifies painting and other maintenance.

Assembled frames are placed in the rough opening over strips of building paper put around the perimeter to minimize air infiltration. The frame is plumbed and nailed to side studs and header through the casings or the blind at the sides. Where nails are exposed, such as on the casing, use the corrosion-resistant type.

Hardware for double-hung windows includes the sash lifts that are fastened to the bottom rail, although they are sometimes eliminated by providing a finger groove in the rail. Other hardware consists of sash locks or fasteners located at the meeting rail. They not only lock the window, but draw the sash together to provide a "windtight" fit.

Double-hung windows can be arranged in a number of ways — as a single unit, doubled (or mullion) type, or in groups of three or more. One or two double-hung windows on each side of a large stationary insulated window are often used to effect a window wall. Such large openings must be framed with headers large enough to carry roofloads.

### Casement Windows

*Casement windows* consist of side-hinged sash, usually designed to swing outward

because this type can be made more weathertight than the inswinging style. Screens are located inside these outswinging windows and winter protection is obtained with a storm sash or by using insulated glass in the sash. One advantage of the casement window over the double-hung type is that the entire window area can be opened for ventilation.

Weatherstripping is also provided for this type of window, and units are usually received from the factory entirely assembled with hardware in place. Closing hardware consists of a rotary operator and sash lock. As in the double-hung units, casement sash can be used in a number of ways — as a pair or in combinations of two or more pairs. Style variations are achieved by divided lights. Snap-in muntins provided a small, multiple-pane appearance for traditional styling.

Metal sash are sometimes used but, because of low insulating value, should be installed carefully to prevent condensation and frosting on the interior surfaces during cold weather. A full storm-window unit is sometimes necessary to eliminate this problem in cold climates.

### Stationary Windows

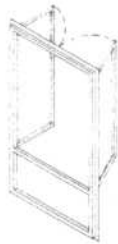
Stationary windows used alone or in combination with double-hung or casement windows usually consist of a wood sash with a large single light of insulated glass. They are designed to provide light, as well as for attractive appearance, and are fastened permanently into the frame. Because of their size (sometimes 6 to 8 feet wide), 1 $\frac{3}{4}$ -inch-thick sash is used to provide strength. The thickness is usually required because of the thickness of the insulating glass.

## WINDOW TREATMENTS

## Window Types

## OPERATION

Double-hung window: upper and lower sections slide vertically to open; spring balance; lock at meeting rail



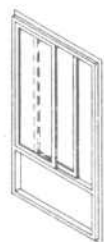
Casement window: with fixed glass section at bottom, two swing-out sections at top; crank-operated

Projected window: with fixed upper section of glass, vent (hopper type) at bottom opening in; crank-operated



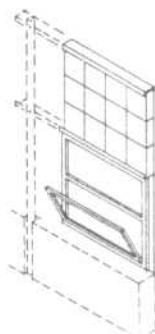
Projected window: with sections opening out at top, in at bottom; crank-operated

Awning window: four horizontal sections project out; crank-operated



Sliding window with lower fixed section

Combination window: upper section is of glass block, supported on angle and channel girts attached to columns; lower section is half fixed glass, and half hopper (crank-operated)



## VENTILATION

Substantial airflow, but not directed well; drafty without a shield

Substantial airflow, but not directed well; drafts are difficult to avoid

Adequate airflow in most climates; well directed, not drafty

Very good airflow, both in quantity and quality (not drafty)

Large quantities of airflow are easily controlled, with fairly good draft control

Substantial airflow, but hard to control, drafty

Adequate, well directed air flow for most climates

## REMARKS

No parts project even when open; sometimes difficult to open if schoolroom has usual shelving at sill level; usually a glass deflector is installed to prevent drafts

Easily operated; shades can be drawn without obstruction when window is open (but they will billow in breeze); these windows must be placed carefully—there is danger of children running into them outdoors if open; rarely used in schools

Easily operated, can be used with shades or blinds closed over most of its area; view is unobstructed, even when window is closed

Easily operated; does provide some ventilation even when partially shaded; view through this type is almost unhindered with few obstructions at eye level

Can be opened quite wide even during rainstorms; is easily operated; shades can be drawn without obstruction; framing does obstruct outdoor view somewhat whether window is open or closed

No parts project either inward or outward when open, but window is sometimes difficult to slide with the usual schoolroom shelf at sill level

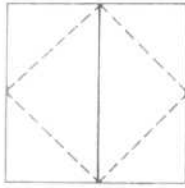
Some types of glass block refract light to ceiling, providing good light distribution across classroom and eliminating need for shades or blinds; however, designer must take care to use properly; this type does not always meet brightness tests for good schoolroom lighting

## TYPE

## DESCRIPTION

## SIDE HINGED

## CASEMENT



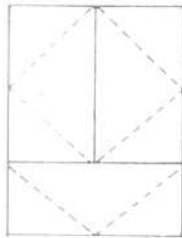
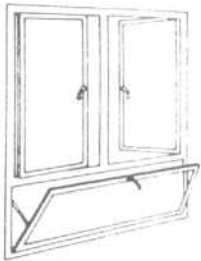
- materials** • wood, steel, aluminum
- use** • common in residences and apartments
- operation** • rotary crank or lever operators hold the vent open to desired position, up to 180°, but usually 90°
- note** • available also as a single vent
- generally allow exterior of glazing to be cleaned from inside when outswinging.
- provide 100 percent opening in the ventilation area
- will be subject to wind pressures when opened.

## CASEMENT-HOPPER



- materials** • wood, aluminum
- use** • especially appropriate for high-rise, life safety installations
- operation** • sophisticated hardware
- note** • no protection from rain when open
- available to limited extent as "tilt and turn" type which acts as a bottom hung window in normal use, but which can be converted by use of secondary hinges into a side-hung, inswinging type, allowing for easy cleaning.

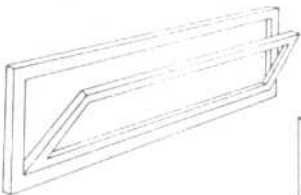
## CASEMENT-COMBINATION



- materials** • wood, aluminum, steel in varied quality grades
- use** • commonly known as the "classroom window"
- operation** • combination of in-swinging hopper and out-swinging casement vents offer flexibility for ventilation control

## BOTTOM HINGED

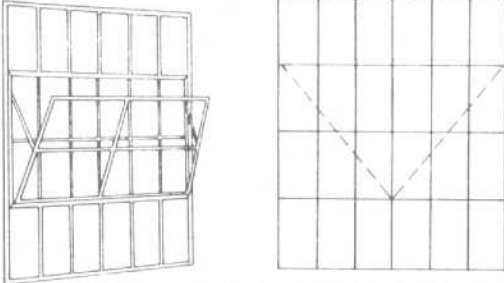
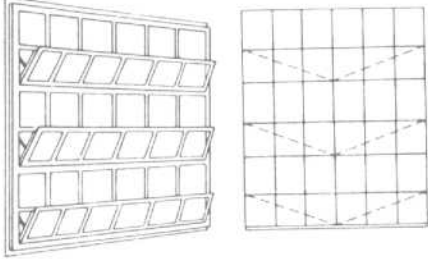
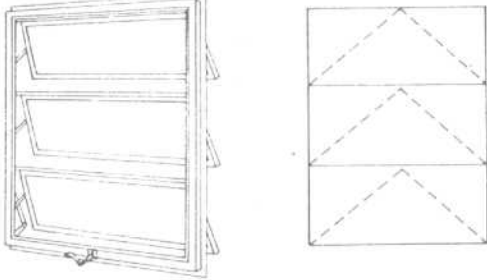
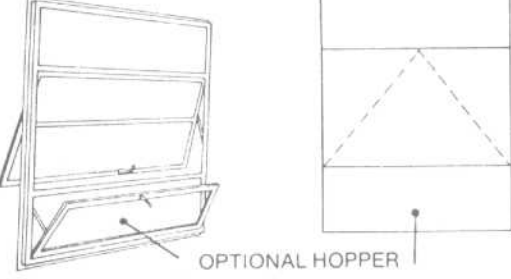
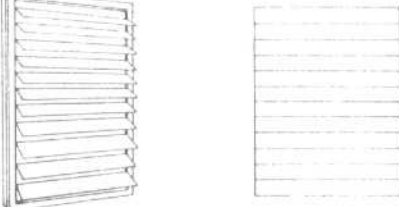
## HOPPER



- materials** • wood, aluminum and steel
- use** • where vent will not interfere with interior conditions
- lower cost utility quality is commonly used for residential basements
- note** • no protection from rain when open

## WINDOW TREATMENTS

## Window Types

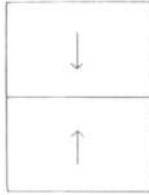
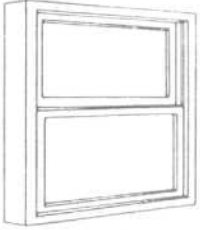
TYPE	DESCRIPTION	
<b>BOTTOM HINGED, continued</b>		
<b>HOPPER-SPECIAL</b>		<p><b>materials</b> • steel, stainless steel</p> <p><b>use</b> • in commercial and industrial buildings where appearance is not of major importance and resistance to forced entry is to prevent forcible exit; sometimes called "guard" windows</p> <p><b>operation</b> • combined with fixed lights or with projecting vents above, which offer high and low openings that are best for natural-air circulation (due to principles of stratification)</p> <ul style="list-style-type: none"> <li>• separate vent frames usually swing in as hoppers</li> <li>• jalousie-like vents also available</li> </ul> <p><b>notes</b> • frames often reinforced with steel rods</p> <ul style="list-style-type: none"> <li>• vents limited in size</li> <li>• muntins usually separate openings of 88 inches square</li> </ul>
<b>HOPPER-MULTIPLE</b>		<p><b>materials</b> • steel</p> <p><b>use</b> • in housing for mental patients, to provide protection against exit while minimizing appearance of restraint</p> <p><b>note</b> • vents have a maximum clear opening of about 6 inches</p>
<b>TOP HINGED</b>		
<b>AWNING</b>		<p><b>materials</b> • wood, steel, aluminum</p> <p><b>use</b> • multiple assemblies are used mostly in steel for industrial buildings</p> <ul style="list-style-type: none"> <li>• separate units are commonly combined with fixed lights, or with hoppers for maximum stratification ventilation (These are available also in wood and aluminum.)</li> </ul> <p><b>operation</b> • are out-swinging projected windows that create a "canopy" against rain penetration</p> <ul style="list-style-type: none"> <li>• when in multiple, vertical stacks, the mechanical operation will allow for the bottom vent to open before the other vents, which will then open in unison</li> </ul>
<b>PROJECTED</b>		<p><b>materials</b> • steel or aluminum</p> <p><b>use</b> • medium quality grade is called "intermediate" and is commonly used in commercial, institutional and industrial type buildings</p> <ul style="list-style-type: none"> <li>• architectural windows are frequently used for schools, hospitals, office buildings, etc.</li> </ul> <p><b>operation</b> • similar to awning windows but with optional fixed glass lights and/or hoppers.</p>
<b>JALOUSIE</b>		<p><b>materials</b> • wood, steel, aluminum</p> <p><b>use</b> • primarily for sunrooms, porches, and the like where protection from the weather is desired with maximum fresh air</p> <p><b>operation</b> • multiple vents combine unobstructed vision with controlled ventilation</p> <ul style="list-style-type: none"> <li>• the louvers are fully adjustable and can be set in any position</li> </ul> <p><b>note</b> • can be fitted with storm sash on the inside to provide more weather tightness</p> <ul style="list-style-type: none"> <li>• screens, interchangeable with storm sash, are furnished</li> <li>• various types of glass, including obscure and colored, often are used for privacy or decoration</li> </ul>

## TYPES

## DESCRIPTION

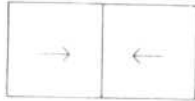
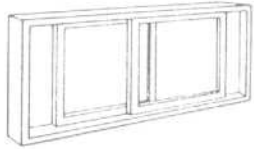
## GLIDING

## DOUBLE-HUNG



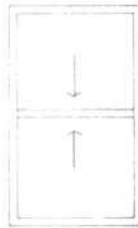
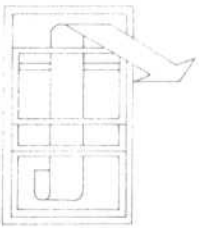
- materials**
- wood, aluminum, steel in different designs and weights to meet various service requirements for all types of buildings
- use**
- with combination of fixed windows for maximum window openings
  - use in buildings other than residential and light commercial has been declining
- operation**
- top and bottom openings optimize natural stratification ventilation
- note**
- also available in single-hung (only one sash operating) and triple hung (three operable sash)

## SLIDING



- materials**
- wood, aluminum (with various coatings and claddings)
- use**
- mostly in residential buildings
- operation**
- provide only one half of opening for ventilation;
  - sash height to width ratio should not exceed 1 to 2 for good operation
- note**
- sash usually removable for cleaning and may be very large

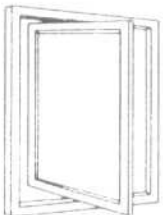
## DUAL-VENT



- materials**
- aluminum
- use**
- mostly in hospitals
- operation**
- essentially two sets of double-hung sash—air circulates through the bottom outer sash and then through the top inner sash
- note**
- provides ventilation while protecting from rain and drafts
  - check cost

## PIVOT

## VERTICAL PIVOT



- materials**
- wood, aluminum and steel
- use**
- mostly in air conditioned buildings
- operation**
- consists of large vent, usually pivoted in the center of the head and sill of the main frame, which rotates 180° or 360° around its vertical axis for cleaning
- note**
- not primarily designed for ventilation, although may be held open up to 4" with special hardware (unless unlocked by maintenance personnel)

## WINDOW TREATMENTS

## Window Types

TYPES	DESCRIPTION	
<b>PIVOT, continued</b>		
<b>HORIZONTAL PIVOT</b>		<b>operation</b> • similar to vertically pivoted but rotates around a horizontal axis
<b>INDUSTRIAL PIVOT</b>		<b>materials</b> • steel, aluminum <b>use</b> • often used horizontally and vertically to form entire walls • lower cost for use in industrial and utilitarian buildings <b>note</b> • mechanical operators are available
<b>SPECIAL</b>		
<b>CONTINUOUS</b>		<b>materials</b> • steel <b>use</b> • for top lighting and ventilation in monitor and sawtooth roof construction <b>operation</b> • hinged at the top to the structural-steel framing members of the building and swing outward at the bottom • two-floor lengths are connected end to end on the job <b>note</b> • mechanical operators may be either manual or motor-powered
<b>AUSTRAL</b>		<b>materials</b> • wood and steel <b>use</b> • schools, hospitals and other institutional buildings • upper and lower sash counterbalanced on arms pivoted to frame • upper and lower sash operate simultaneously <b>note</b> • difficult to screen, shade or curtain
<b>REVERSIBLE</b>		<b>materials</b> • wood and steel <b>use</b> • residential and industrial buildings <b>operation</b> • similar to double-hung in appearance, but may be tilted for better control of ventilation, or reversed for cleaning <b>note</b> • not universally available
<b>CUSTOM TYPES VARIOUS CONFIGURATIONS</b>	<b>materials</b> • aluminum, steel, stainless steel <b>use</b> • special types for windows in houses of worship, mausoleums, and memorial buildings <b>operation</b> • various arrangements available	

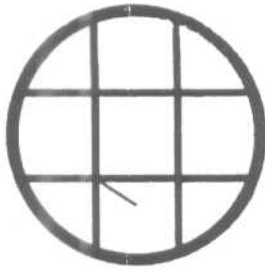


WINDOW TREATMENTS

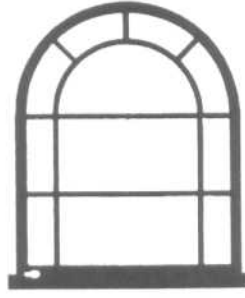
Window Types



1. Round Top over casements



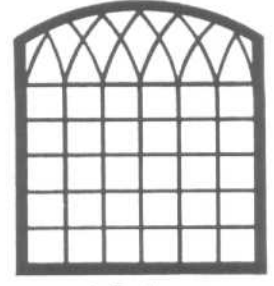
2. Full Round with operating center



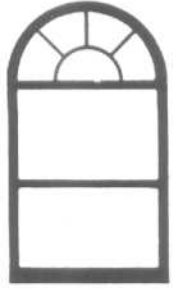
3. Round Top with authentic divided lites



4. Separated Round Top



5. Eyebrow with Gothic divided lites



6. Round Top over double-hung



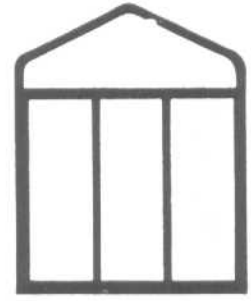
7. Simulated Round Top



8. Round Top with quarter panes



9. Transom Round Top.



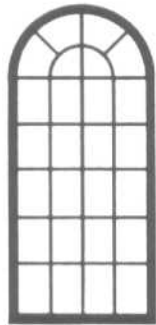
10. 3 point Round Top



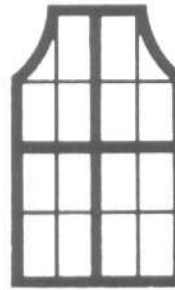
11. Quarter Rounds



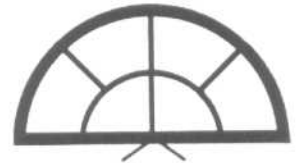
12. Round Top over picture window



13. 12 foot Round Top with decorative divided lites



14. Inverted corners



15. 12 foot wide Round Top with operating center



16. Ovals



17. Spider Web



18. Gothic head



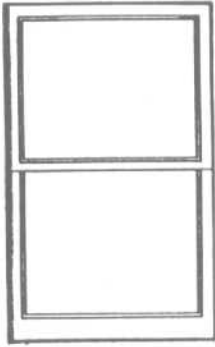
19. Rounded casements



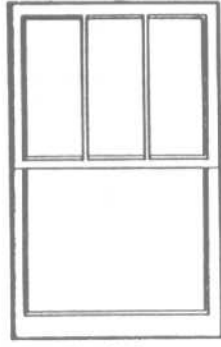
20. Rounded double hung with Gothic lite pattern.

WINDOW TREATMENTS

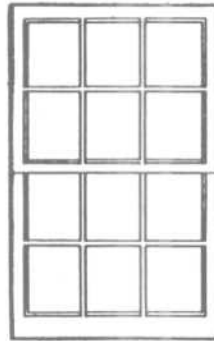
Window Types



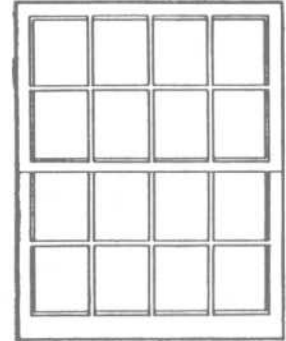
Two-light window, the all-purpose window



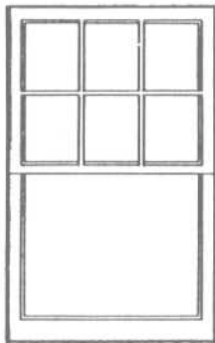
Two-light window, three lights over one light



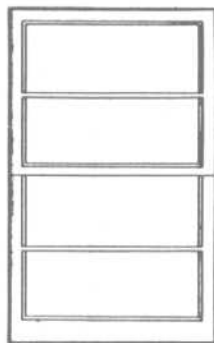
Two-light window, divided twelve lights



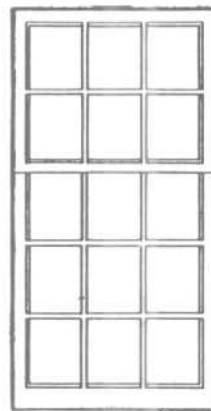
Two-light window, divided sixteen lights



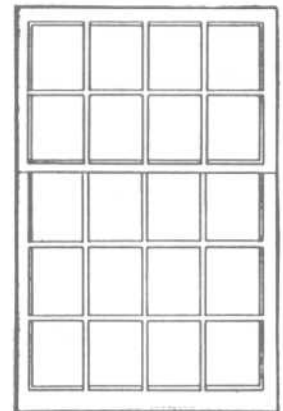
Two-light window, six lights over one light



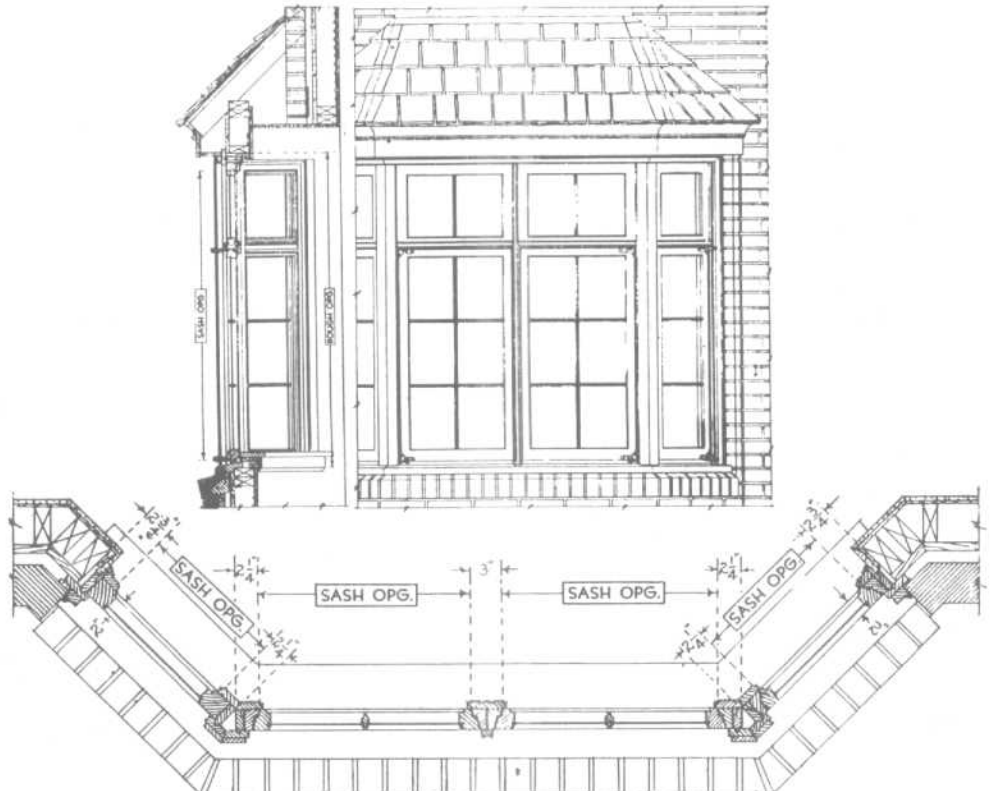
Two-light window, four horizontal lights high



Two-light window, six lights over nine



Two-light window, eight lights over twelve



Typical styles of windows

**WINDOW TREATMENTS**

Window Types: Projected and Stationary

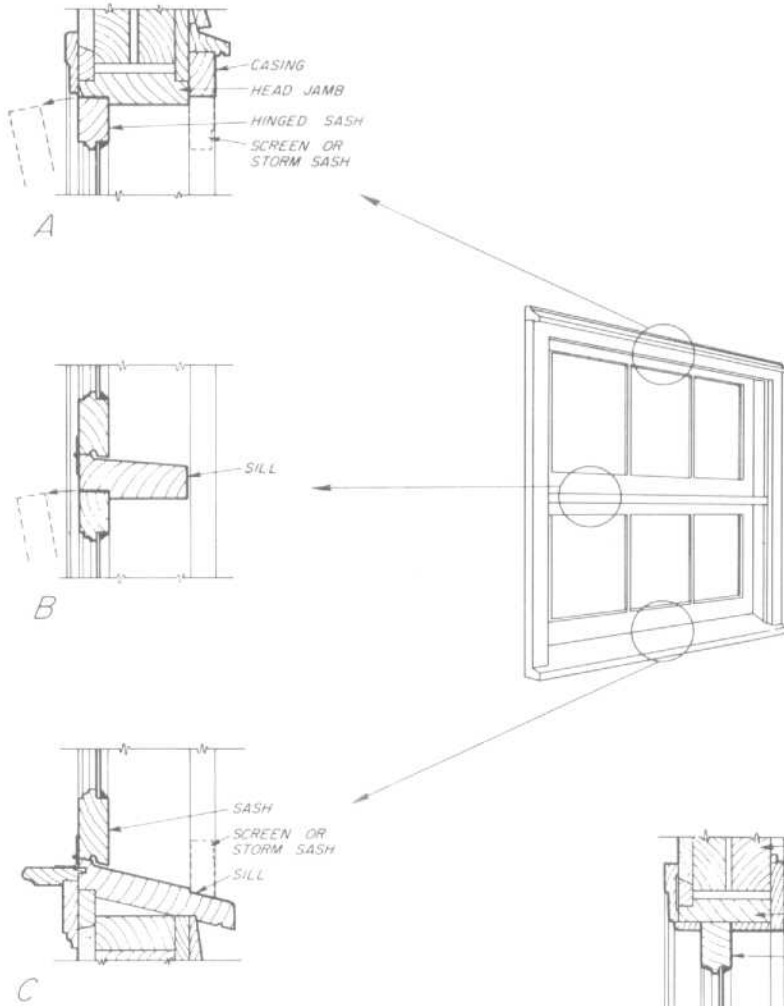


Fig. 1 Projected window. Cross sections: A, head jamb; B, horizontal mullion; C, sill.

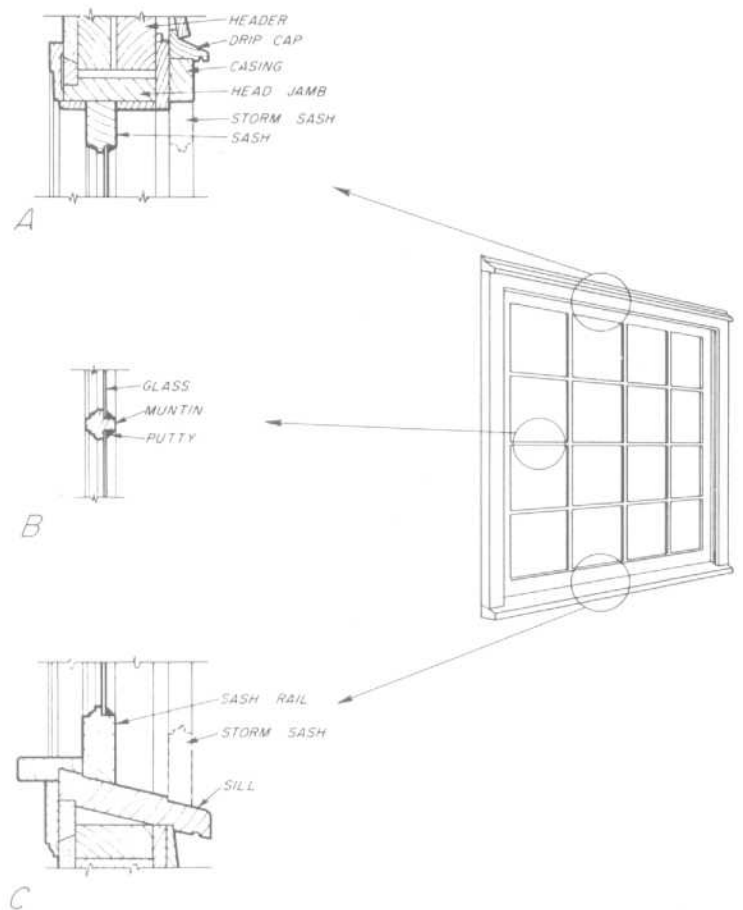


Fig. 2 Stationary window. Cross sections: A, head jamb; B, muntin; C, sill.

## WINDOW TREATMENTS

### Window Types: Double-Hung and Casement

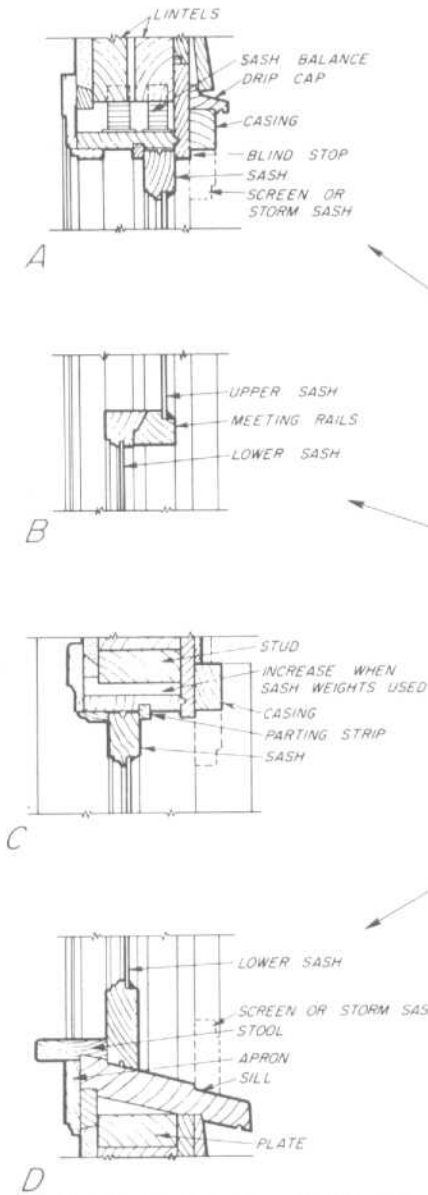


Fig. 3 Double-hung windows. Cross sections: A, head jamb; B, meeting rails; C, side jamb; D, sill.

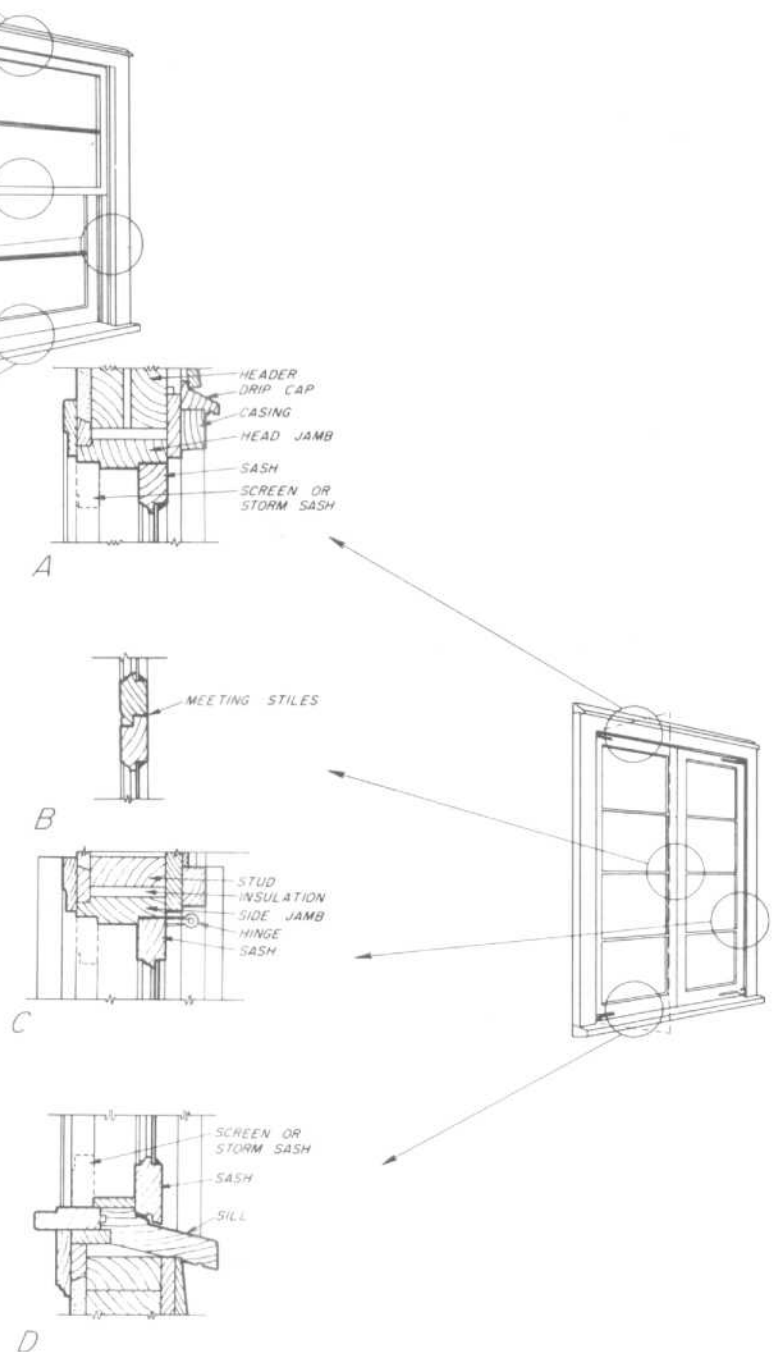


Fig. 4 Outswinging casement sash. Cross sections: A, head jamb; B, meeting stiles; C, side jamb; D, sill.

WINDOW TREATMENTS

Window Types: Double-Hung and Casement

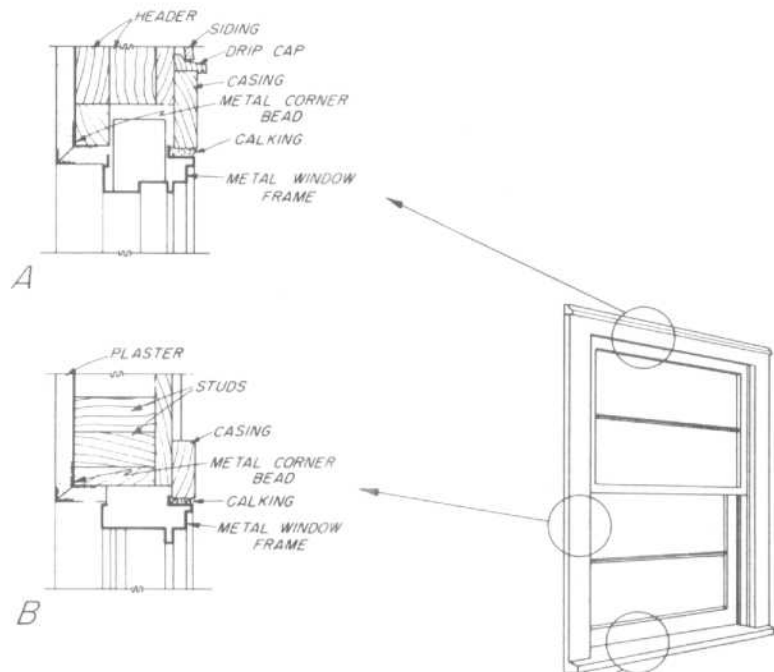


Fig. 5 Double-hung metal windows. Cross sections: A, head; B, side jamb; C, sill.

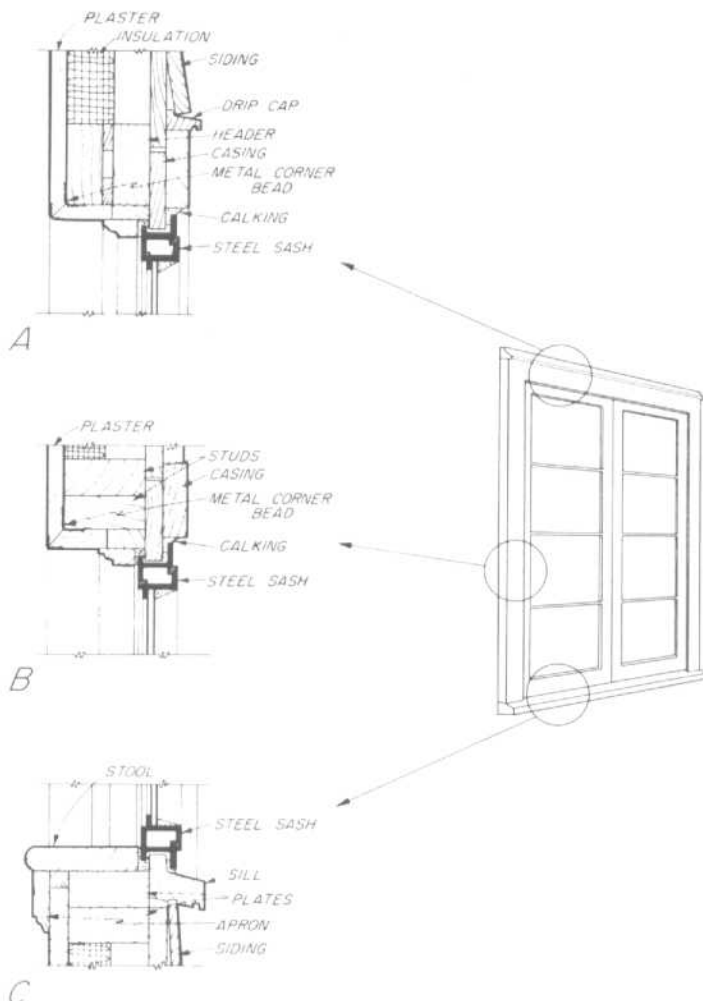


Fig. 6 Solid-section steel outswinging casement sash. Cross sections: A, head jamb; B, side jamb; C, sill.

## WINDOW TREATMENTS

## Window Types

## Wood Trim

The casing around the window frames on the interior of the house should be the same pattern as that used around the interior door frames. Other trim which is used for a double-hung window frame includes the sash stops, stool, and apron (Fig. 7A). Another method of using trim around windows has the entire opening enclosed with casing (Fig. 7B). The stool is then a filler member between the bottom sash rail and the bottom casing.

The *stool* is the horizontal trim member that laps the window sill and extends beyond the casing at the sides, with each end notched against the plastered wall. The *apron* serves as a finish member below the stool. The window stool is the first piece of window trim to be installed and is notched and fitted against the edge of the jamb and the plaster line, with the outside edge being flush against the bottom rail of the window sash (Fig. 7A). The stool is blind-nailed at the ends so that the casing and the stop will cover the nailheads. Predrilling is usually necessary to prevent splitting. The stool should also be nailed at midpoint to the sill and to the apron with finishing nails. Face-nailing to the sill is sometimes substituted or supplemented with toenailing of the outer edge to the sill (Fig. 7A).

The casing is applied and nailed as described for doorframes, except that the inner edge is flush with the inner face of the jambs so that the stop will cover the joint between the jamb and casing. The window stops are then nailed to the jambs so that the window sash slides smoothly. Channel-type weather stripping often includes full-width metal sub-jambs into which the upper and lower sash slide, replacing the parting strip. Stops are located against these instead of the sash to provide a small amount of pressure. The apron is cut to a length equal to the outer width of the casing line (Fig. 7A). It is nailed to the window sill and to the 2- by 4-inch framing sill below.

When casing is used to finish the bottom of the window frame as well as the sides and top, the narrow stool butts against the side window jamb. Casing is then mitered at the bottom corners (Fig. 7B) and nailed as previously described.

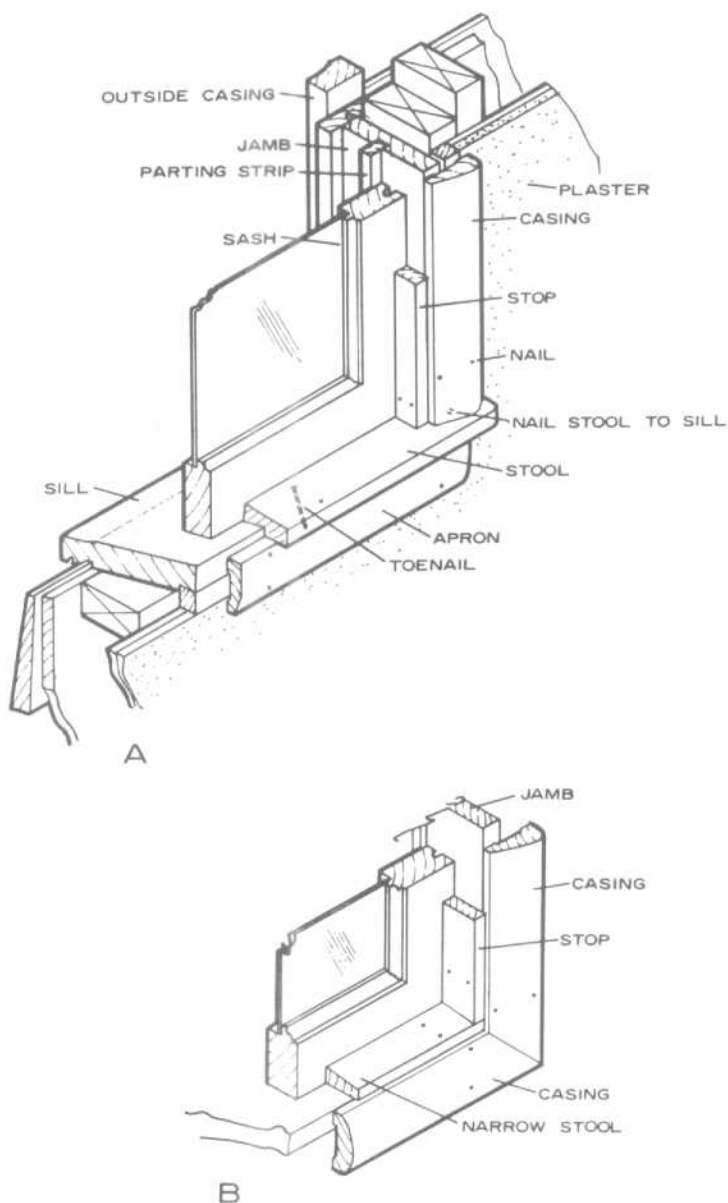


Fig. 7 Installation of window trim: A, with stool and apron; B, enclosed with casing.

## WINDOW TREATMENTS

## Curtains/Draperies

## CURTAINS

Curtains are soft window coverings that generally are shirred (gathered onto a rod) or have headings attached to solid-wood rods, round or oval metal rods, or café rods rather than cord-operated traverse rods. Curtains may be either stationary fabric panels or slid open and closed by hand. They are flexible in that they can be short or long, layered or tiered, or used alone or in combination with other soft, or with hard treatments. *Curtain* is traditionally a term for informal treatments, such as café curtains. However, curtains also may be quite formal, as are shirred and elegant tied-back fabric treatments.

Even though curtains are generally thought to be shirred treatments, other headings might be included in this category. Indeed, there is a crossover of terminology between draperies and curtains. Generally draperies are installed on cord-operated traverse rods, although they may be stationary pleated panels. Curtains may be installed on traverse rods (as in a pleated café curtain, for

example), and headings such as the pencil pleat; drawstring pencil pleat; shirred, spaced pencil pleat; alternate pencil pleat; ruffled shirring tape heading; and smocked heading may be called either curtain or drapery treatments.

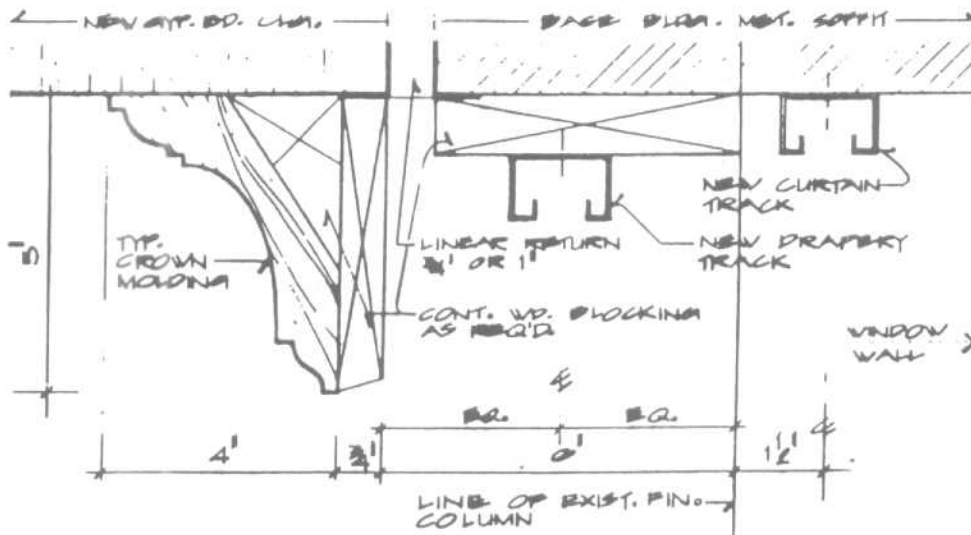
## DRAPERIES

Draperies are made with pleats. They are hung with drapery hoods onto carriers of conventional, architectural, or decorative traverse rods or into the rings of wood rods or café curtain rods; or they may thread onto spring-system traverse rods. Generally draperies are either hung straight to the floor or tied back. Thus they operate, or "draw," by opening and closing with a cord or a wand or by hand. The exception is tied-back draperies, which sometimes are let down at night. However, tied-back draperies are trained to tie back at an angle and therefore should not be handled to any extent. Draperies draw in a pair and meet in the center

(center-meet) or draw one way from left to right or from right to left. One-way draw draperies require one-way traverse rods.

Draperies that hang at a doorway rather than at a window are called portières. They may be pleated in any fashion or shirred. They may be placed on a traverse rod, but historically (and they were used extensively in the Victorian era), they were tied-back stationary panels made of a heavy fabric that were let down when privacy or insulation was needed.

Draperies can be made of any fabric. The selection will depend on the style, use, and needs. Sheer fabrics do best as diffusers of glare and as providers of daytime privacy. Medium- to heavyweight fabrics are excellent choices for overdraperies and plain tieback draperies. Lining fabrics are the right weight for privacy liners or underdraperies. If a drapery is given a ruffled edge or a banding, that trim should be a lightweight, semi-crisp, flexible fabric, not a heavy, stiff fabric or a sheer, slippery fabric.



CROWN MOLDING @ CURTAIN POCKET

## WINDOW TREATMENTS

## Curtains/Draperies

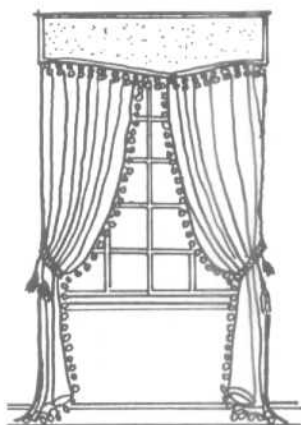
TABLE 1 Draperies

Period style	Fabric	Colors	Design	Upholstery fabrics
Early English Tudor Jacobean Charles II	Crewel, embroideries, hand-blocked linen, silk and worsted damask, velvet, brocade	Full-bodied crimson, green, and yellow	Large bold patterns: tree branch, fruits, flowers, oak leaf, animals, heraldic designs	Tapestry, leather, needlework, velvet, brocade
Anglo-Dutch William & Mary Queen Anne	Crewel, embroideries, hand-blocked linen, silk and worsted damask, velvet, brocade, India print	Full-bodied crimson, green, and yellow	Large bold patterns: tree branch, fruits, flowers, oak leaf, animals, heraldic designs	Tapestry, leather, needlework, velvet, brocade
Early Georgian Chippendale	Crewel, embroideries, hand-blocked linen, silk and worsted damask, velvet, brocade, Indian print	Full-bodied crimson, green, and yellow	Jacobean motifs, classic medallions and garlands	Tapestry, leather, needlepoint, velvet, brocade
Late Georgian Adam Hepplewhite Sheraton Empire Federal	Brocade, damask, chintz, taffeta, satin, toile de jouty	Delicate subdued hues of rose, yellow, mauve, green, and gray	Classic designs, small in scale: garlands, urns, floral, animals, etc.	Damask, brocade, velour, satin, petit point, leather in libraries
Louis XIV Louis XV Louis XVI	Silk, satin, damask, taffeta, muslin, brocade, toile de jouty	Delicate powder blue, oyster white, pearl, rose, pale greens, mauve, yellow	Stripes sprinkled with ribbons, flowers, medallions, lyres, and other classic motifs	Petit point, satin, moire, velour, chintz, damask, brocade, tapestry
Spanish renaissance	Velvet, damask, crewel, India print, printed and embroidered linen	Rich vigorous colors, red, green, and gold	Bold patterns in classic and heraldic designs; also arabesques	Leather, tapestry, velvet, linen, brocatelle
Early colonial	Crewel, embroideries, hand-blocked linen, silk and worsted damask, velvet, brocade	Full-bodied crimson, green, and yellow	Large bold patterns: tree branch, fruits, flowers, oak leaf, animals, heraldic designs	Tapestry, leather, needlepoint, velvet, brocade
Early American	Toile de jouty, damask, chintz, organdy, cretonne	All colors, but more subdued than in early period	Scenic, birds, animals, floral	Haircloth, mohair, linen, chintz, velours
Modern	Textured and novelty weaves, all fabrics	All colors, bright to pastel	Solid colors, modern designs, stripes	All fabrics, novelty weaves, plastics
French provincial	Chintz, cretonne, hand-blocked linen, velvet	Subdued colors, pastel shades	Screen prints, block prints	Solid colors, textured weaves, tapestry
Victorian	Velvet, brocade, damask	Turkey red, other rich colors	Solid colors, formal patterns	Haircloth, needlework

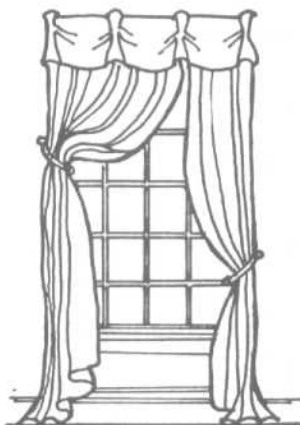


### WINDOW TREATMENTS

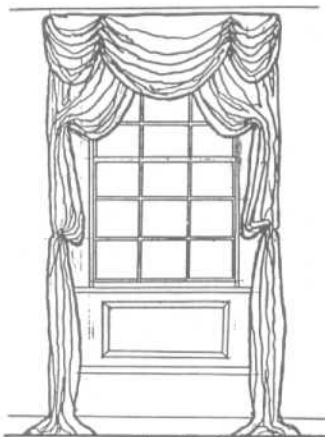
Curtains/Draperies of Colonial and Federal Periods



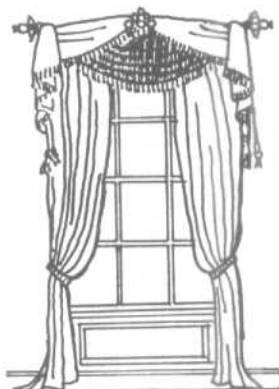
18th-century colonial: tieback damask drapery with balled fringe



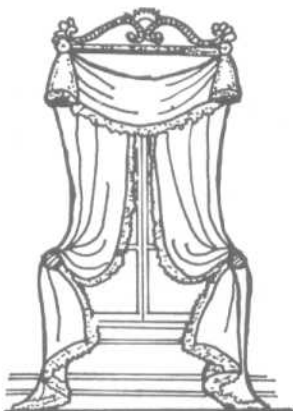
18th-century colonial: staggered tieback with plain edge asymmetric panels



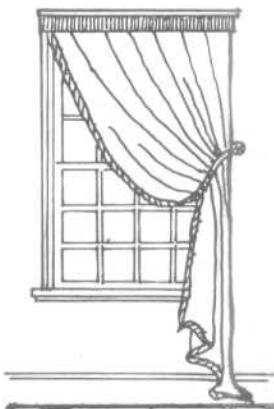
18th-century colonial: swagged valance over bishop sleeve draperies over holdback



Federal: tieback panels with fringed raised valance of contrasting color



Federal: waterfall over holdback with draped valance



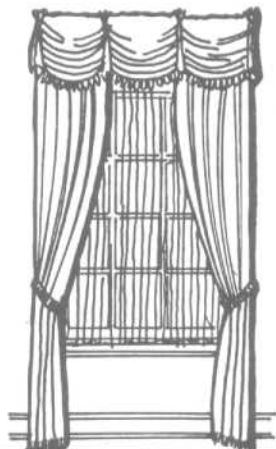
Federal: asymmetric tieback with fringed valance



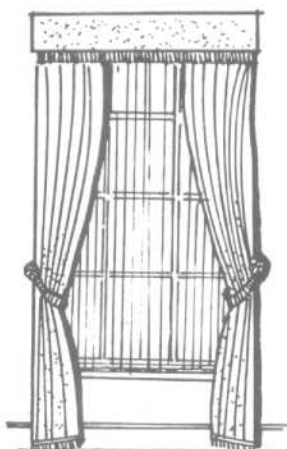
Federal: heavy valance over straight draperies

## WINDOW TREATMENTS

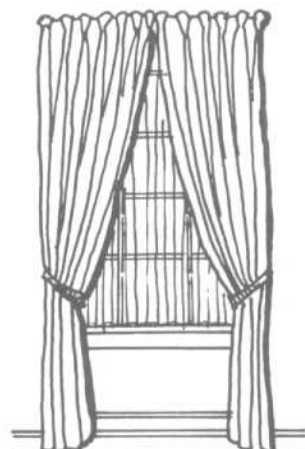
Curtains/Draperies of Georgian and Directoire Periods



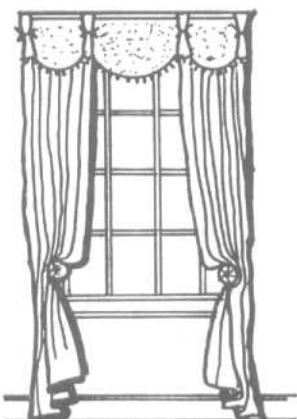
Georgian: tieback drapery with Austrian valance with fringes



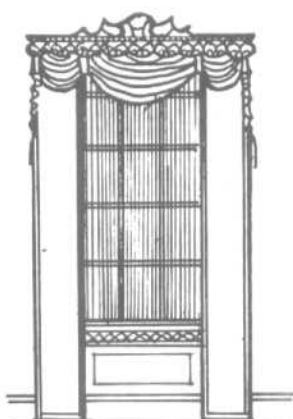
Georgian: tieback heavy woven drapery with fabric-covered heading — sheer curtains behind



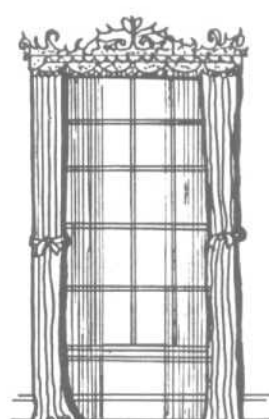
Georgian: tieback drapery with tapered French pleat heading



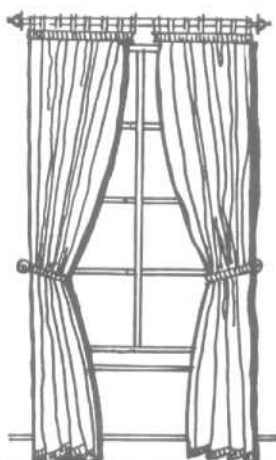
Late Georgian: curved fabric cartridge valance over holdback draperies



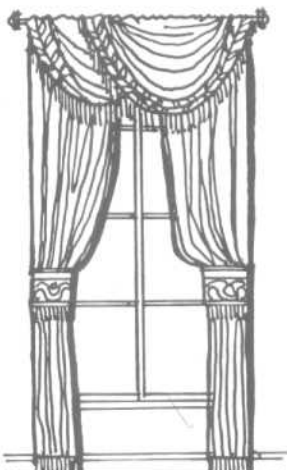
Late Georgian: gilt wood cornice over fixed lambrequins and sheer curtains



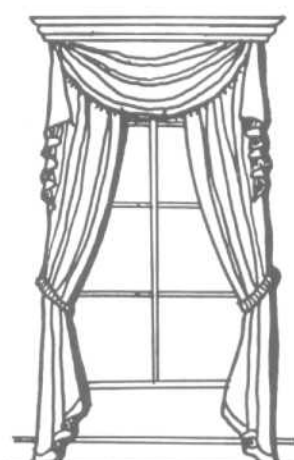
Late Georgian: gilt metal cornice over fixed tieback draperies and sheer curtains



Directoire: tieback draperies with contrasting edging on decorative brass rod



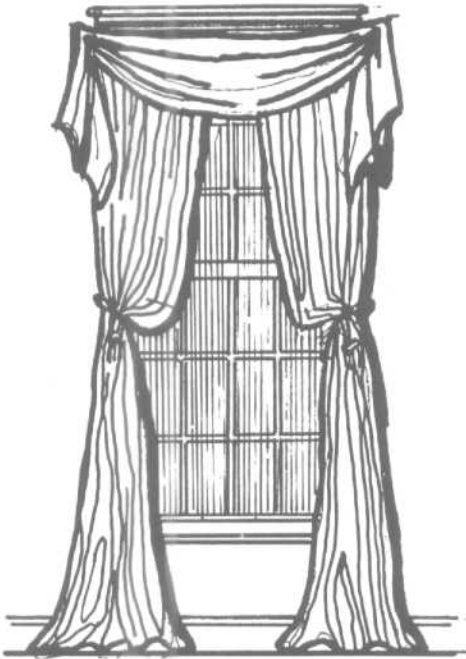
Directoire: fringed overdrapery valance on fringed sleeved tiebacks and fringed drapery



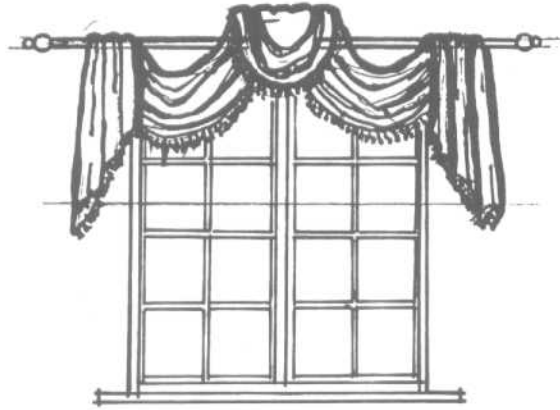
Directoire: painted stepped wood cornice over swag with twin cascades and tieback draperies

**WINDOW TREATMENTS**

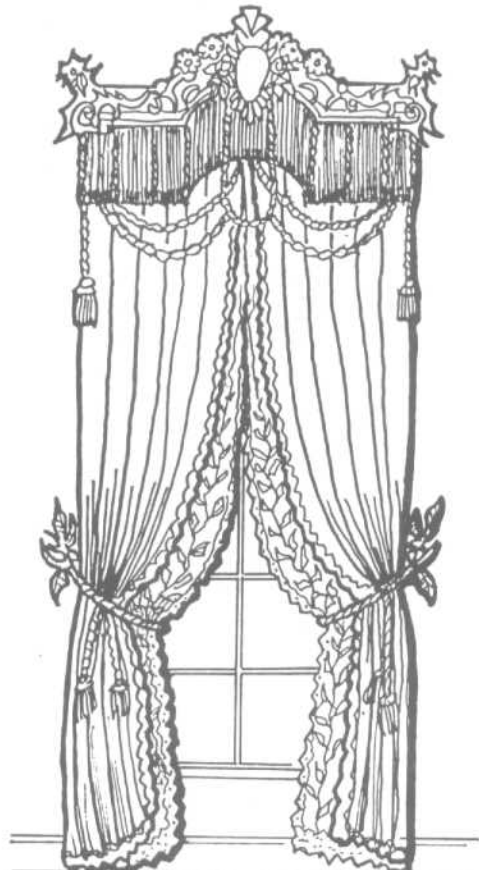
Curtains/Draperies of Victorian Period



Mid-19th-century Victorian: central swag with twin cascades over heavy draperies with braided tieback over sheer undercurtain



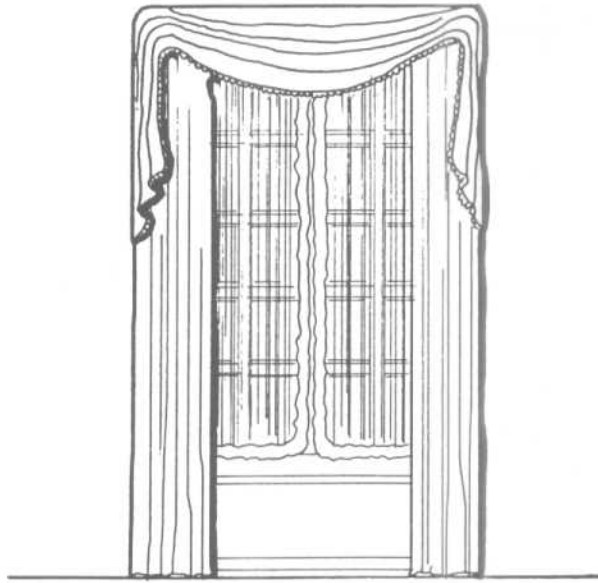
Late-19th-century Victorian: looped festoon over decorative brass rod



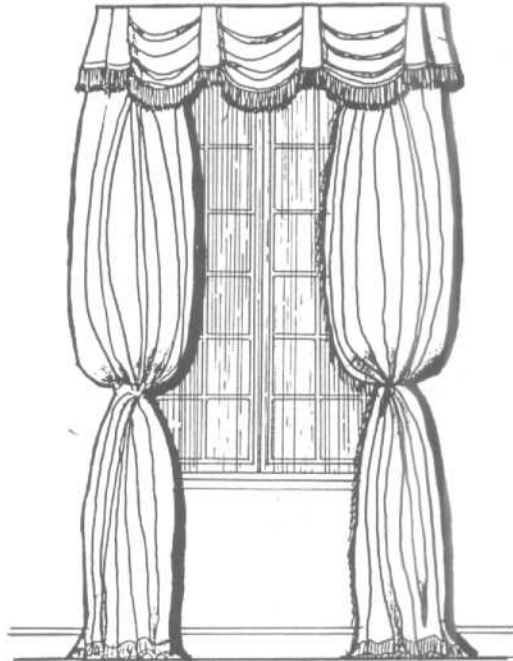
Late-19th-century Victorian: neo-Greek-style cornice with fringed valance over tieback fringed fabric with lace undercurtains

**WINDOW TREATMENTS**

Curtains/Draperies of 1940s



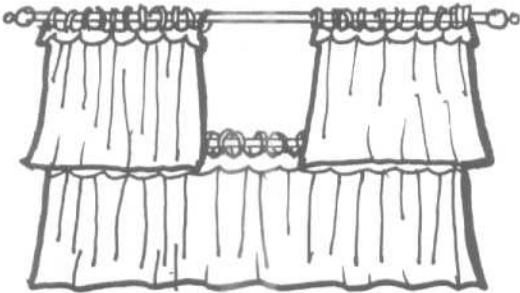
Fringed finger festoon over brackets  
over straight line draperies with sheer  
undercurtains



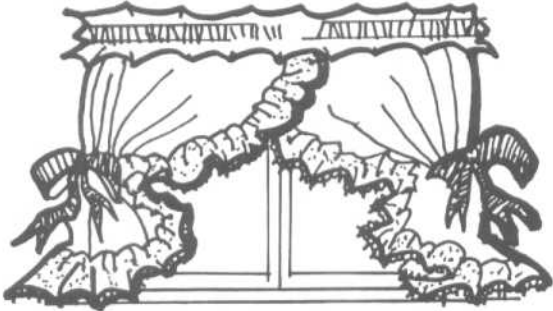
Fringed fabric valance with cascades over  
bishop sleeve draperies

WINDOW TREATMENTS

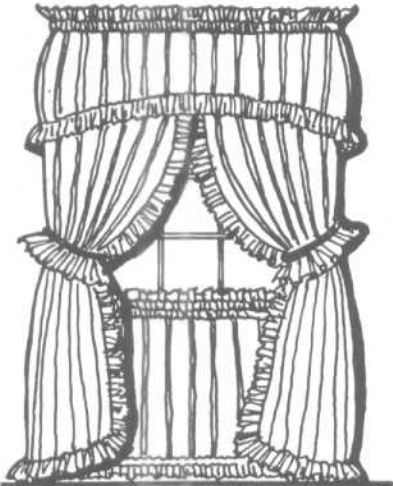
Curtains/Draperies



Cafe curtains



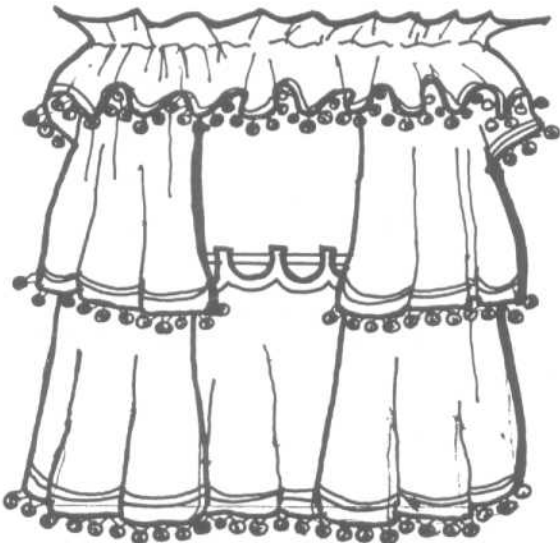
Ruffled tieback curtains



Fringed segmented valance with ruffled trim  
– tieback draperies over café curtains



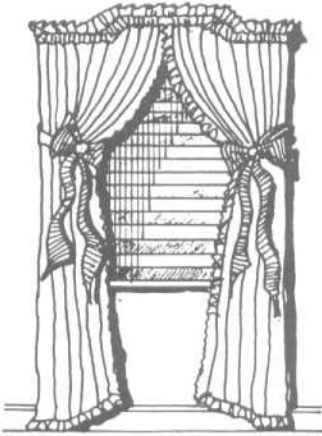
Fabric-wrapped-pole draped valance



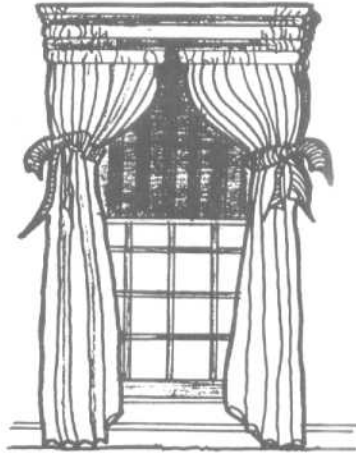
Café curtains with gathered valance and ball fringe trim

WINDOW TREATMENTS

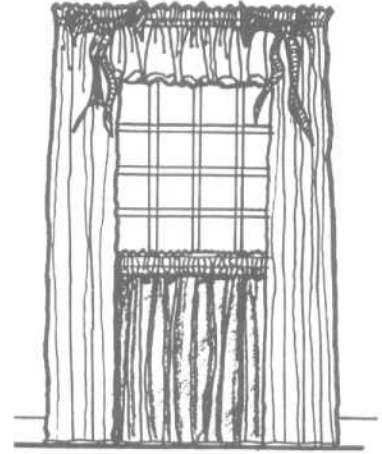
Curtains/Draperies



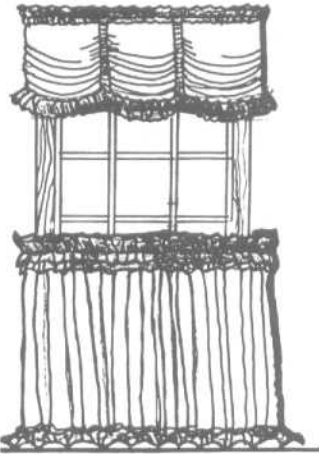
Tieback draperies with ruffles on center arch rod — pleated shade beneath



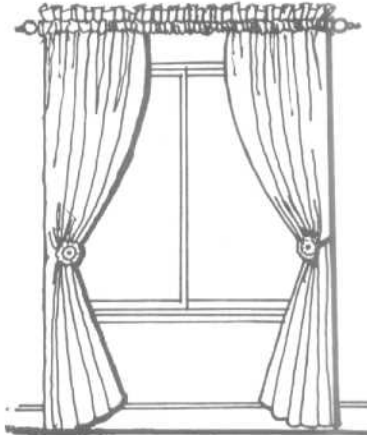
High tieback draperies with ruffled multirow valance — woven shade beneath



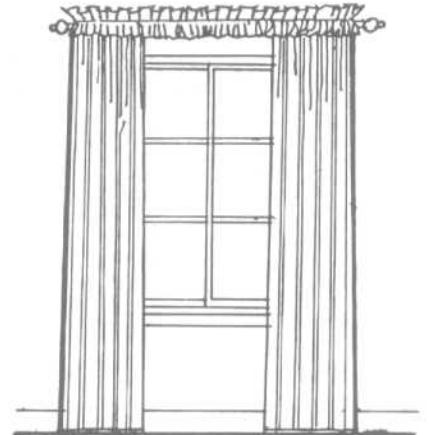
Full-length straight draperies with ruffled valance — decorative bows



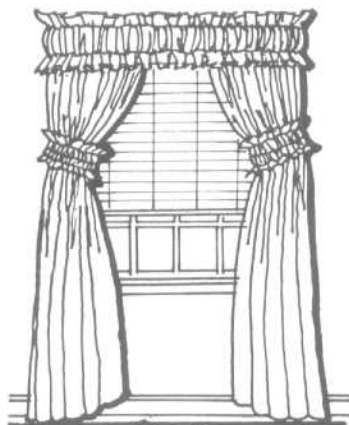
Shirred, ruffled balloon valance over ruffled, shirred heading on narrow rod



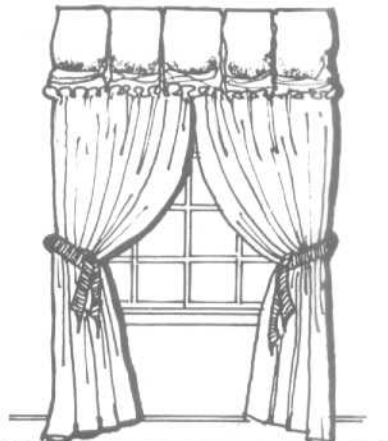
Shirred heading on brass pole — fixed draperies with rosette tieback



Shirred heading on brass pole — fixed panel draperies



Shirred balance with shirred tieback draperies over blinds



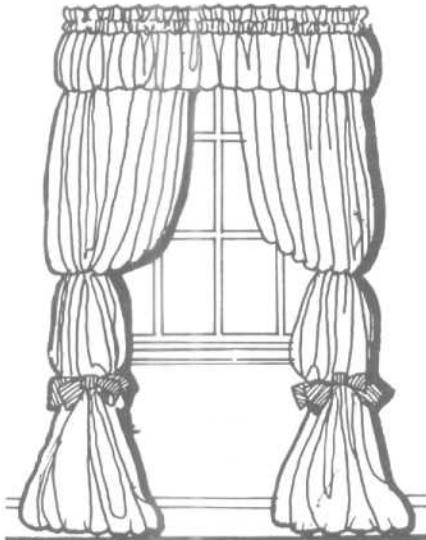
Penta balloon valance over ribbon tieback draperies



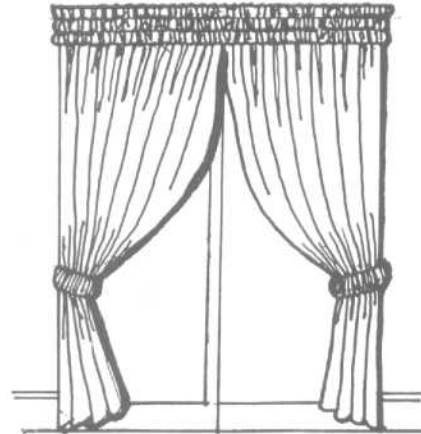
Shirred valance with horizontal accent banding — tieback draperies with matching edge banding

WINDOW TREATMENTS

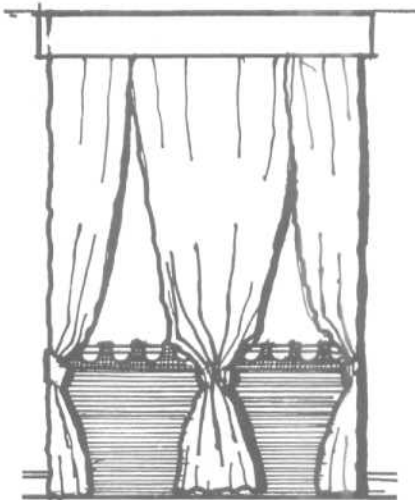
Curtains/Draperies



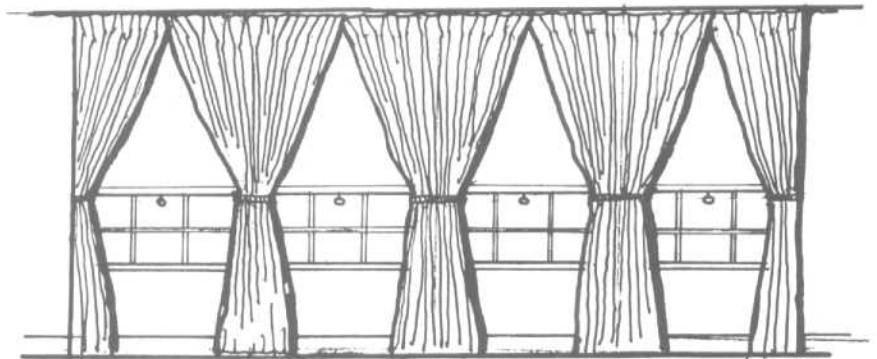
Bishop sleeve fringed-tip valance with ribbon tieback draperies



Triple-row fringed heading with shirred tieback draperies



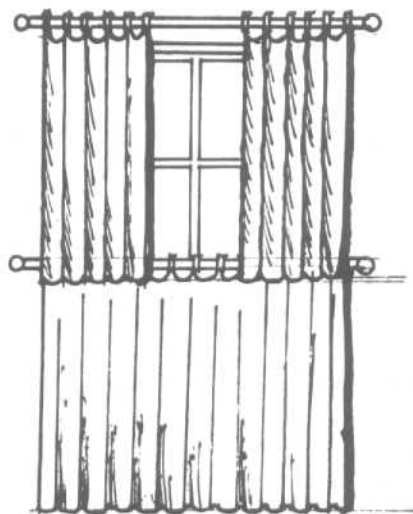
Fabric-covered straight cornice over paired tieback draperies and scalloped curtain on brass rod



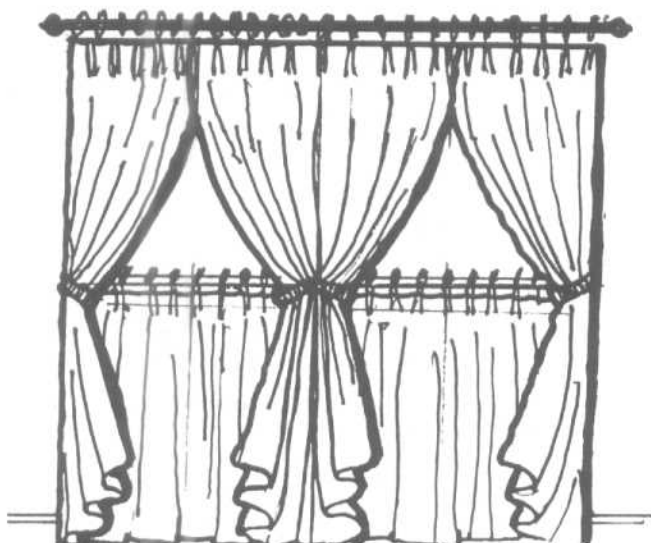
Pinch pleated draperies with horizontal tiebacks over standard roller shades

WINDOW TREATMENTS

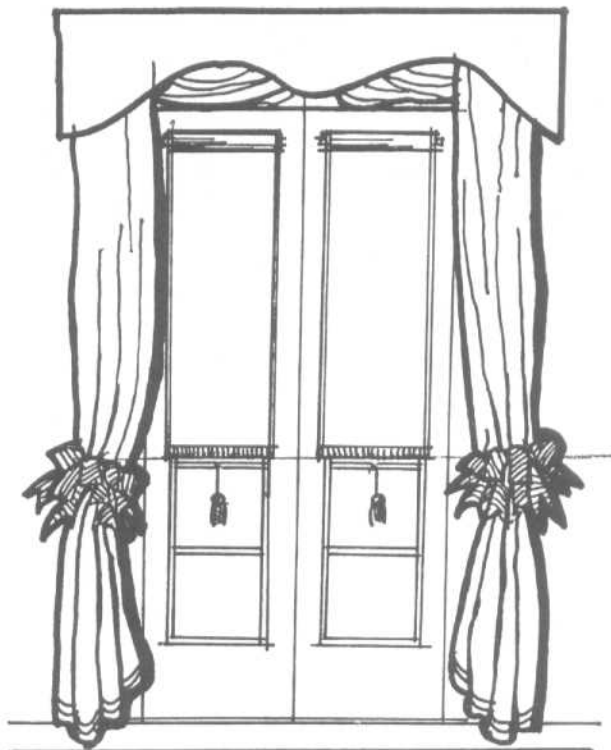
Curtains/Draperies



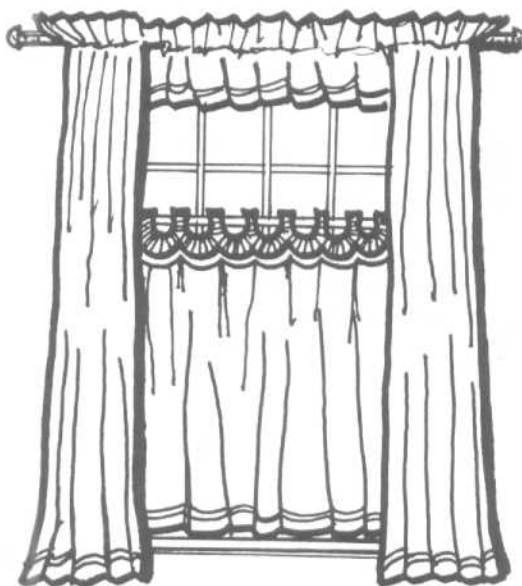
Café curtains with scalloped edges on brass rods



Single pleated draperies over paired double hung windows with tab headed café curtains on rod



Fabric-covered cornice board valance — ribbon tiebacks on drapery

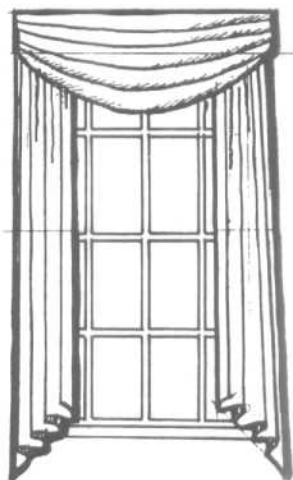


Ruffled valance heading over brass rod with straight draperies over scalloped café curtain



WINDOW TREATMENTS

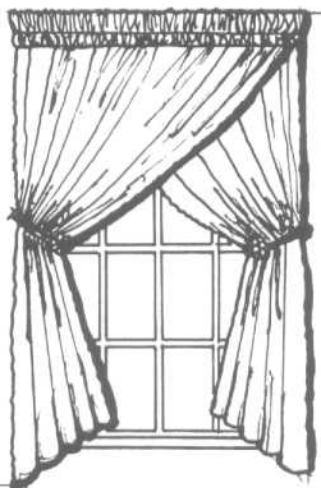
Curtains/Draperies



---

---

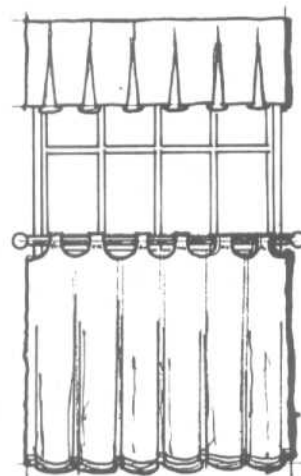
Simple traditional swag with cascade draperies



---

---

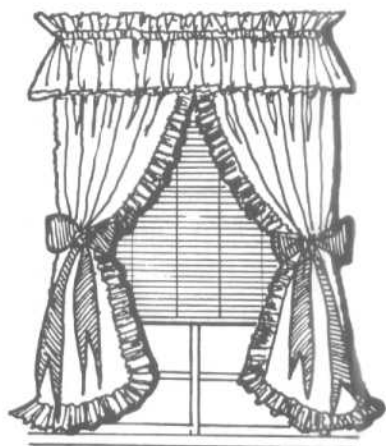
Rosette tieback priscilla curtains with continental heading



---

---

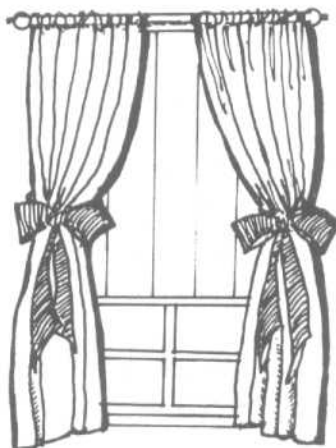
Scalloped café curtains on brass rod with pleated valance



---

---

Bow tieback curtains with fringed trim and gathered valance



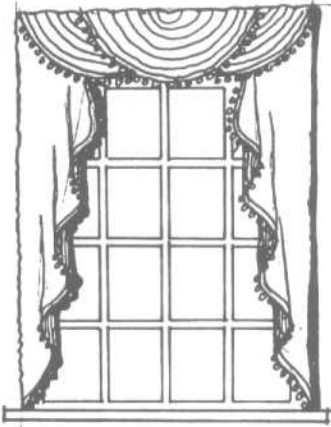
---

---

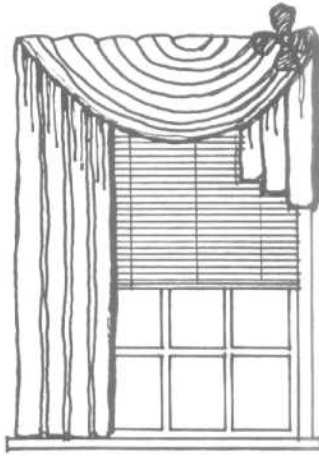
Bow tieback gathered curtains on brass rod

WINDOW TREATMENTS

Curtains/Draperies



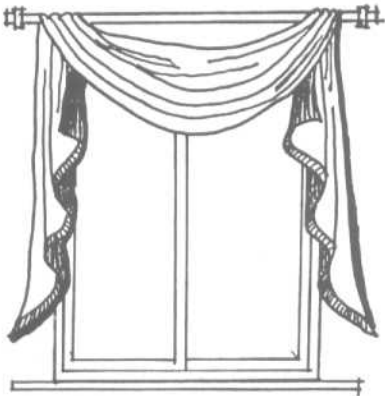
Overlapping swag on rod with ball-fringed cascades



Swag with bow and asymmetric cascades



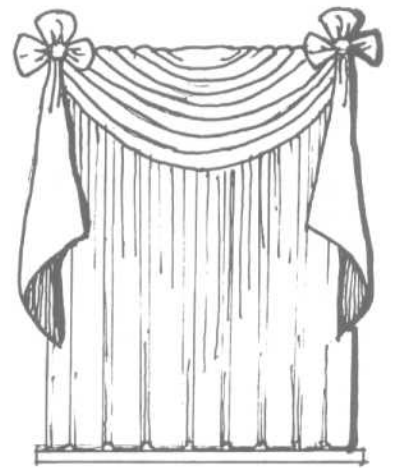
Symmetrical swags and cascades with center rosette



Symmetrical draped swag over brass rod



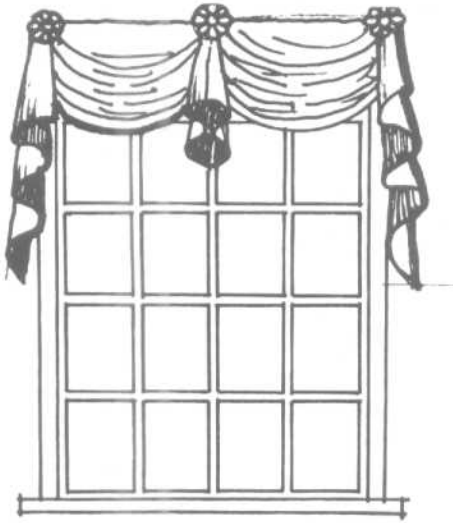
Asymmetrical swag drapery over brass rod with sheer curtain



Symmetrical draped swag on rod with ties at end over sheer or solid curtain

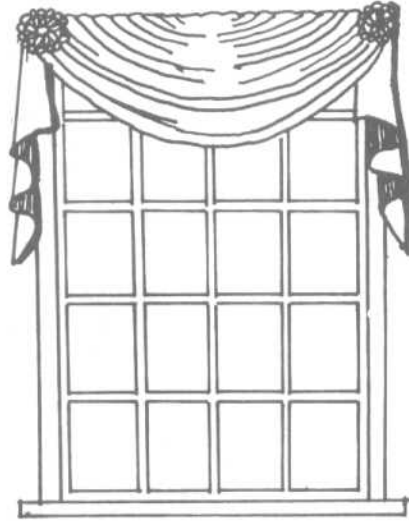
WINDOW TREATMENTS

Curtains/Draperies



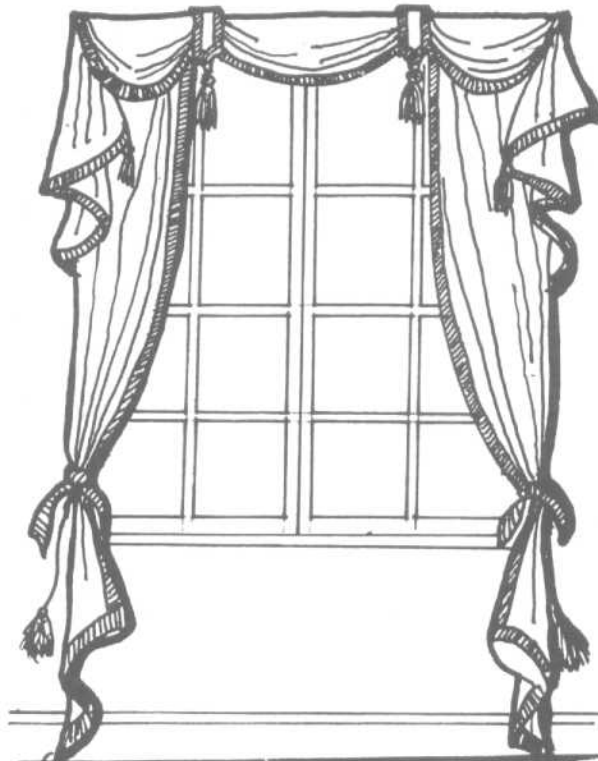
---

Triple-tail cascades with dual swags and rosette holds



---

Swag over rod with rosette holds

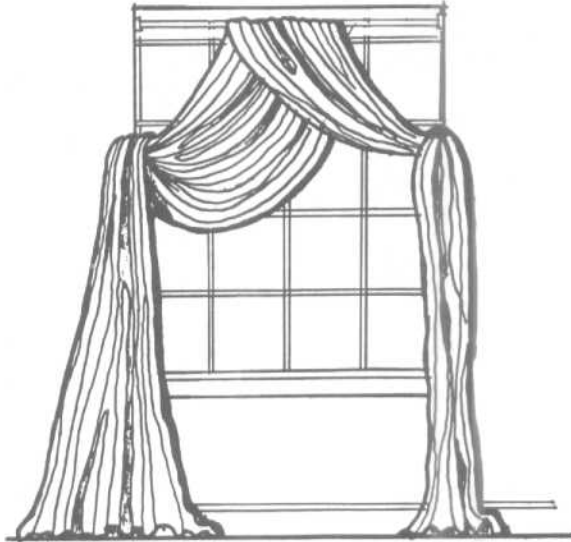


---

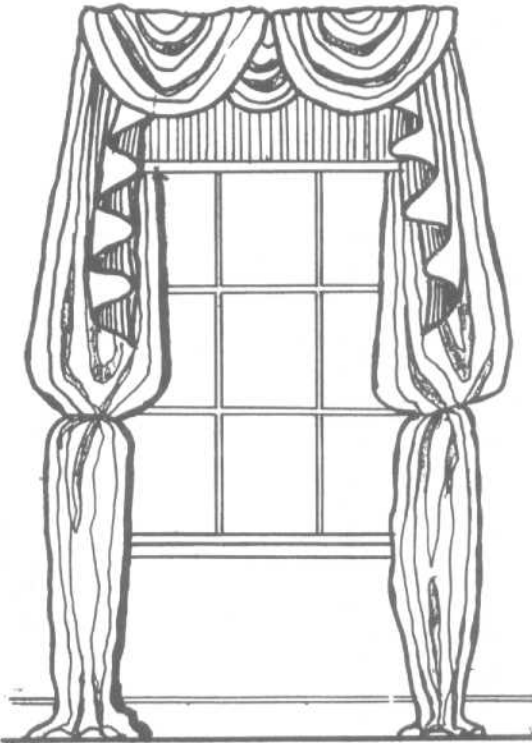
Swag, draped valance, cascading ends

WINDOW TREATMENTS

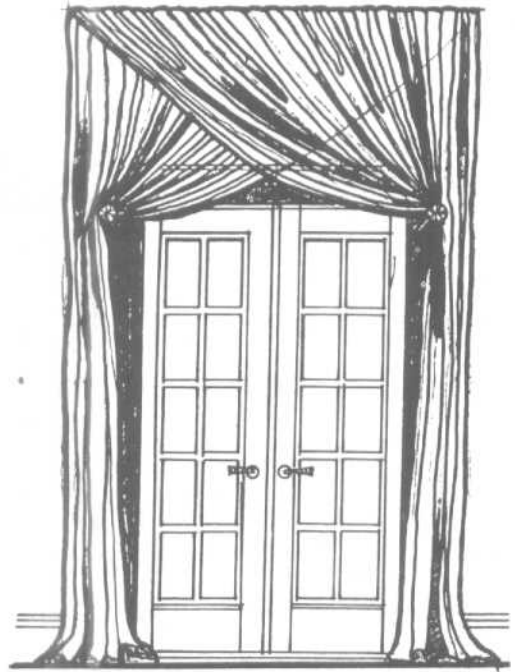
Curtains/Draperies



Asymmetrical double-rod-supported swags and draperies — contemporary



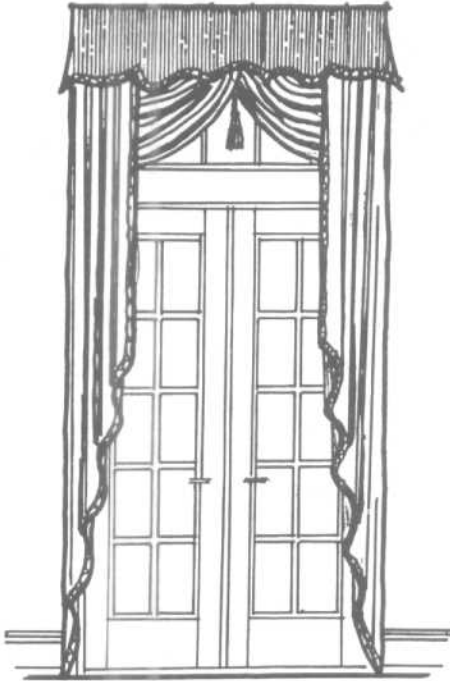
Symmetrical long cascades and swags with center swag and bishop sleeve draperies



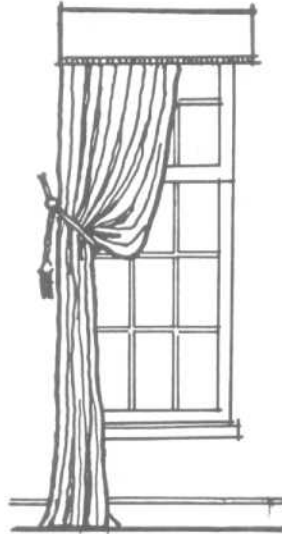
Overlapped double swag thrown over door-high holdbacks, with draperies billowed at floor

WINDOW TREATMENTS

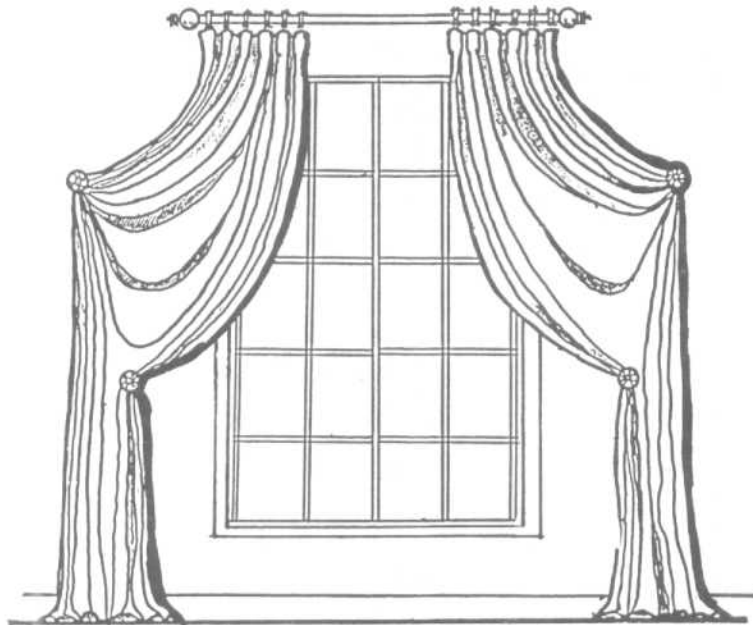
Curtains/Draperies



Flared cornice box with geometric trimmed scallops over reverse swags and asymmetric floor-tip cascades



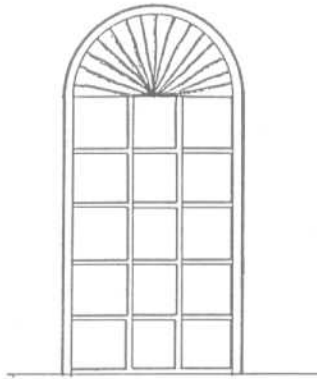
Trimmed cornice box over asymmetric tieback drapery



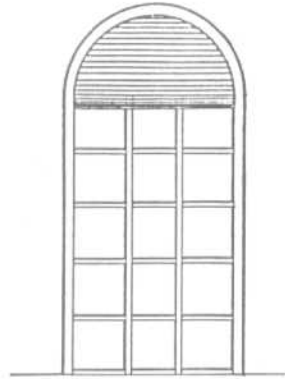
Symmetrical box-pleated draperies on brass rod with double-tiered rosette holdbacks

WINDOW TREATMENTS

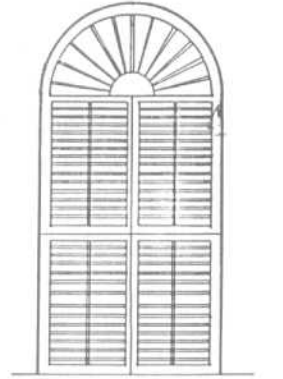
Curtains/Draperies



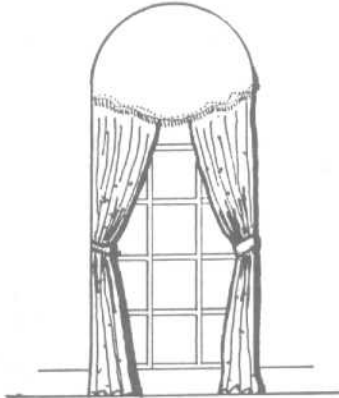
Pleated shade



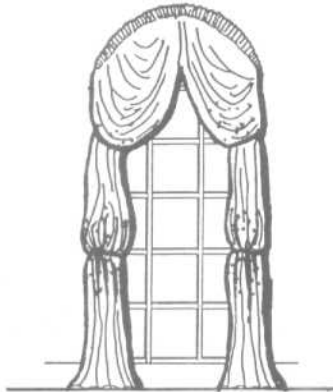
Miniblind – custom fitted



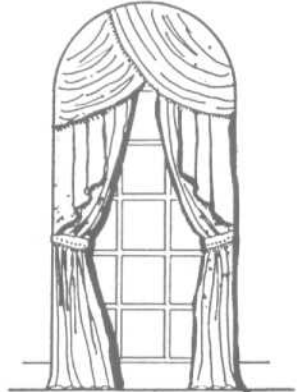
Wooden shutters



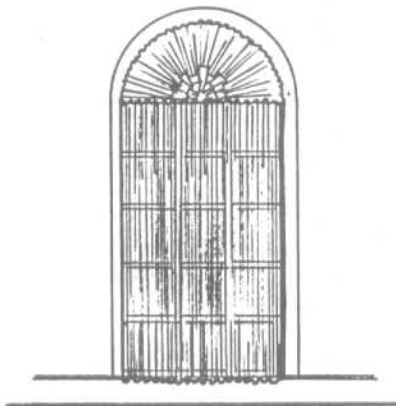
Rounded valance with drapery



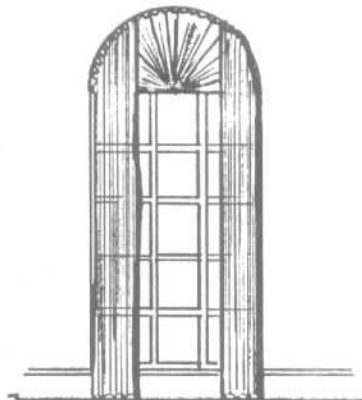
Double swags with balloon drapery



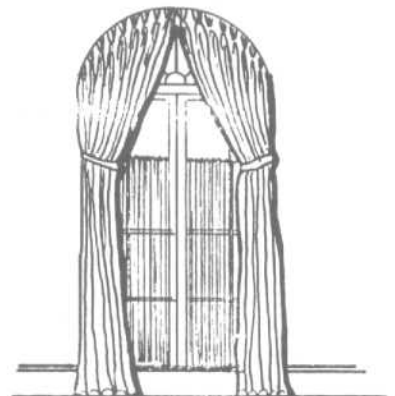
Double swags with cascades and drapery



Shirred curtain with sunburst



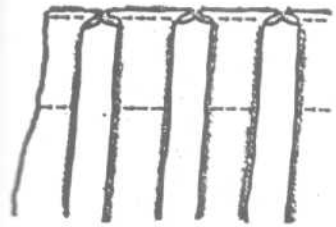
Pleated shade with shirred curtain



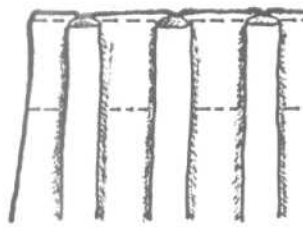
French pleats with shaped top under curtain

WINDOW TREATMENTS

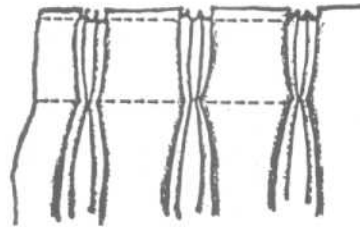
Headings



Semiformal box pleats, evenly spaced



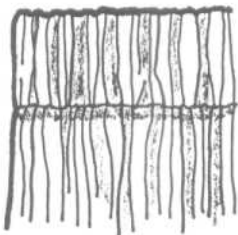
Cartridge pleat, evenly spaced



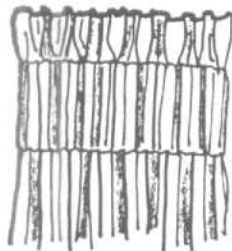
Triple pleat heading, evenly spaced



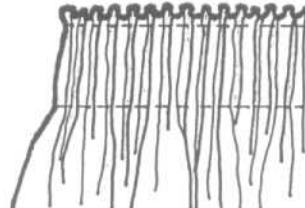
Shirred heading on a narrow rod



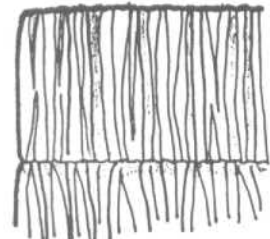
Shirred heading gathering on a wide rod



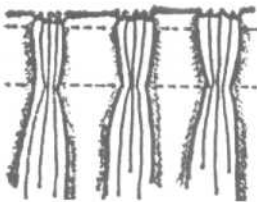
Ruffled shirred heading on an extra-wide rod



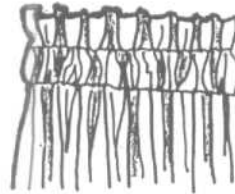
Pencil heading on a wide rod



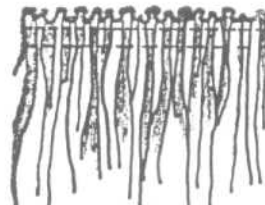
Shirred heading gathered on an extra-wide rod



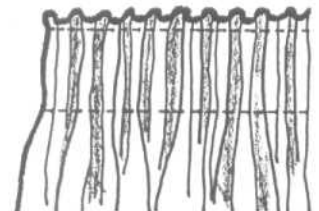
Cluster heading, spaced evenly



Ruffled shirred heading on a narrow rod



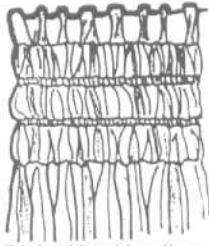
Standard heading on a narrow rod



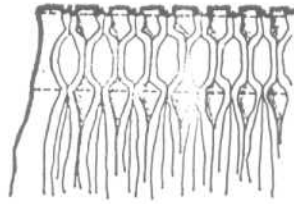
Spaced pencil pleats heading on a wide rod

WINDOW TREATMENTS

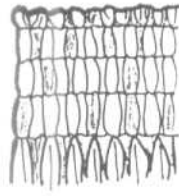
Headings



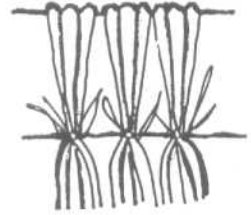
Triple shirred heading with ruffle gathered on 3 narrow rods



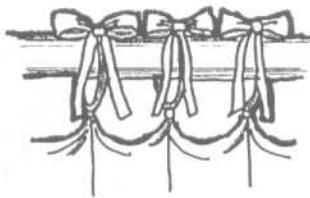
Decorative heading on a wide rod



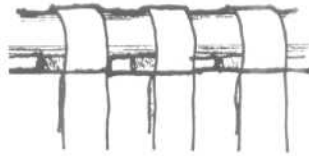
Triple shirred heading gathered on 3 narrow rods



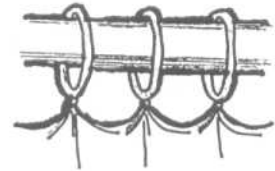
Grouped French pleats



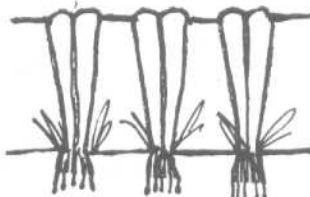
Scalloped heading with rings and bows



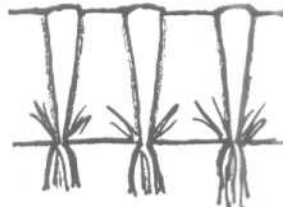
Tab heading spaced evenly on rod



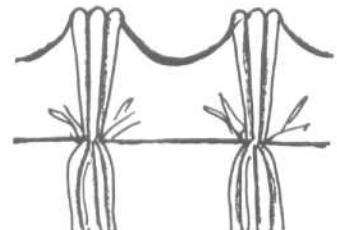
Scalloped heading with rings



Double butterfly pleat heading



Single butterfly pleat heading

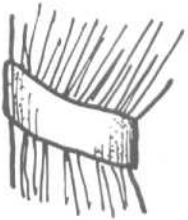


French pleats with scalloped heading



WINDOW TREATMENTS

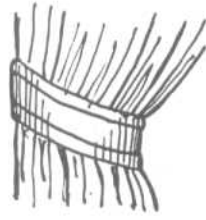
Tiebacks and Holdbacks



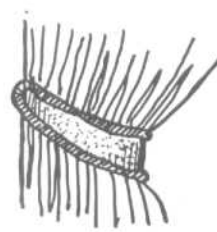
Straight



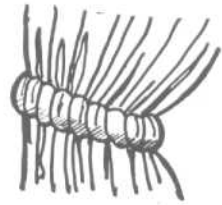
Tapered



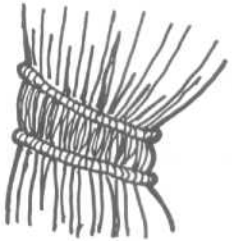
Banded



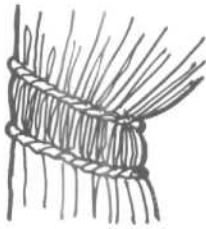
Tapered with welting



Oversized welting



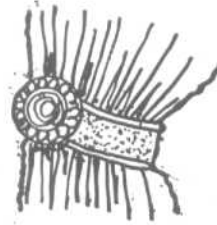
Shirred with welting



Shirred with braided trim



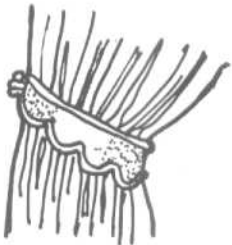
Braided



Rosette



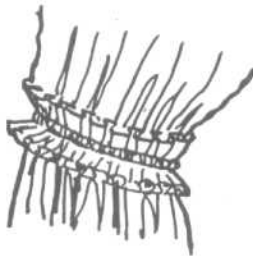
Fringed with welting



Scalloped



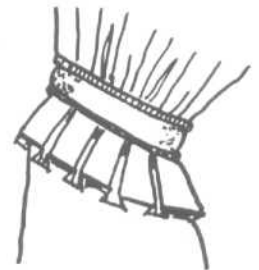
Frilled



Twin ruffles



Straight with scallops



Twin welting with box pleating



Rosette with cascade



Ruffles



Bow/ribbon



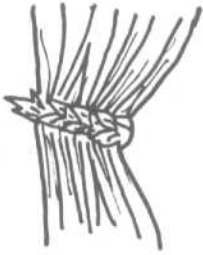
Bow with welting and tassel



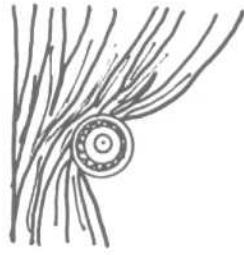
Tapered with welting, rosette, and tassels

WINDOW TREATMENTS

Tiebacks and Holdbacks



Leaf motif



Decorative holdback



Scalloped with welting



Layered with pleats



Decorative with tassel



Decorative bow and ribbon



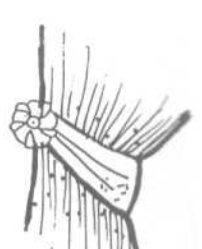
Square holdback with insert



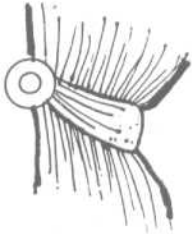
Decorative knob with 2 inserts



Decorative knob holdback with tassel



Stylized rosette



Decorative knob with inserts



Decorative knob holdback with two tassels



Decorative bow holdback



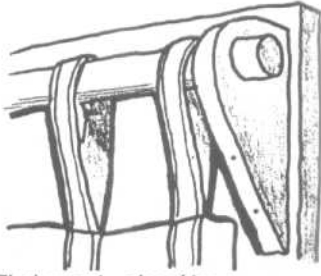
Standard knob with cascade



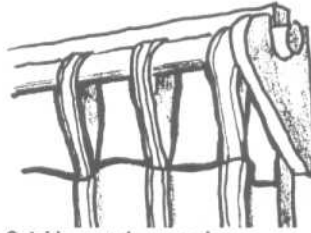
Decorative knob with circular insert and cascade

**WINDOW TREATMENTS**  
Mounts, Brackets, and Couplers

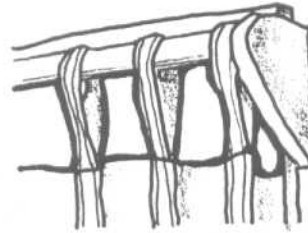
**MOUNTS**



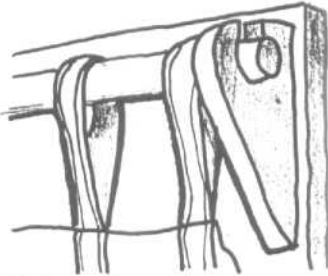
Flush mount — closed top



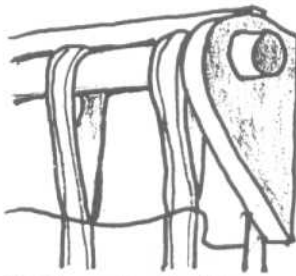
Outside mount — open top



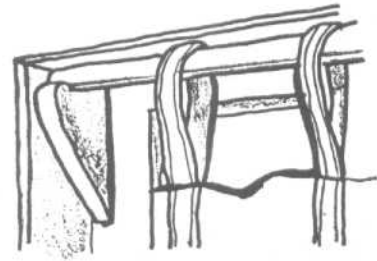
Outside mount — closed side



Flush mount — open top

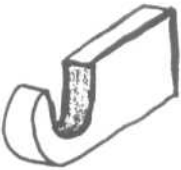


Outside mount — closed top

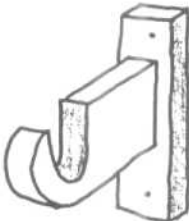


Inside mount bracket

**BRACKETS**



Flush extra-projection bracket



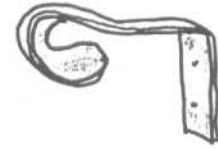
Base-mounted extra-projection bracket



Curved bracket



Support bracket

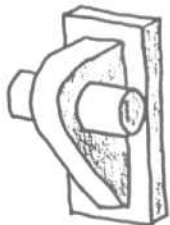


Curved support bracket

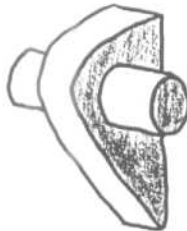


Double rod bracket

**COUPLERS**



Extra-projection base-mounted coupler

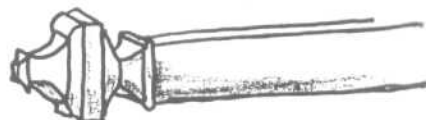
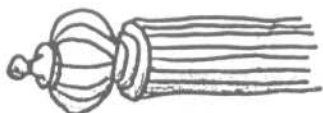
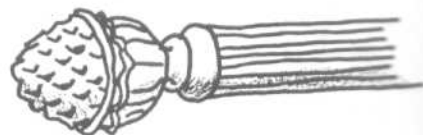
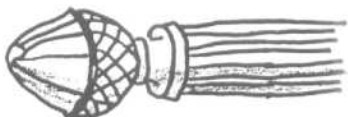
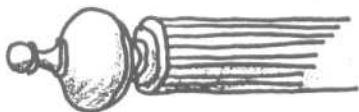
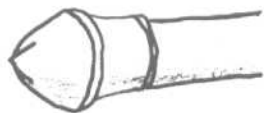


Base-mounted coupler

WINDOW TREATMENTS

Finials, Rings, and Hooks

FINIALS



RINGS



Plain ring



Round eyelet ring



Oval eyelet ring



Square eyelet ring



Round clip-on ring



Oval clip-on ring

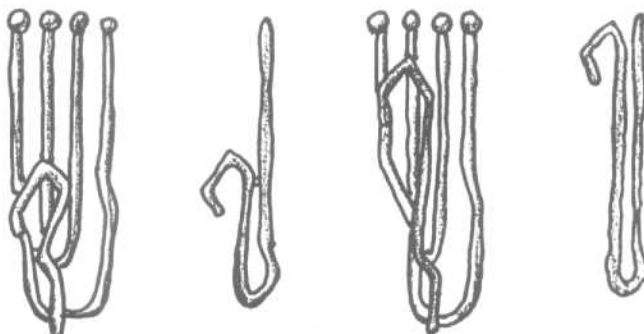


Rounded-end clip-on ring

HOOKS



Metal and plastic hooks for standard tapes



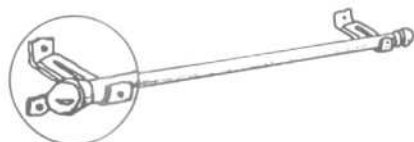
Metal hooks for decorative tapes



Flat curtain rod



Double flat curtain rod



Cafe curtain rod



Fluted wood rod



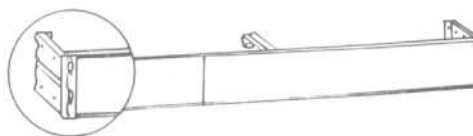
Tension rod with adjustable screw



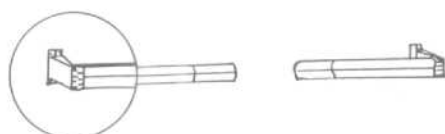
Sash rods



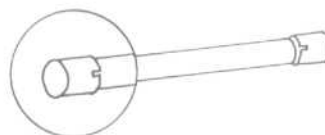
Separated curtain rod



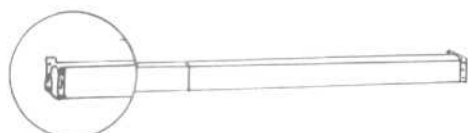
Extra wide telescoping projection rod



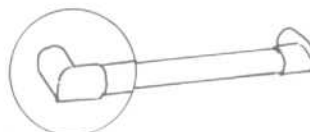
Swinging arm separated rod



Polyvinyl chloride (PVC) with end caps curtain rod



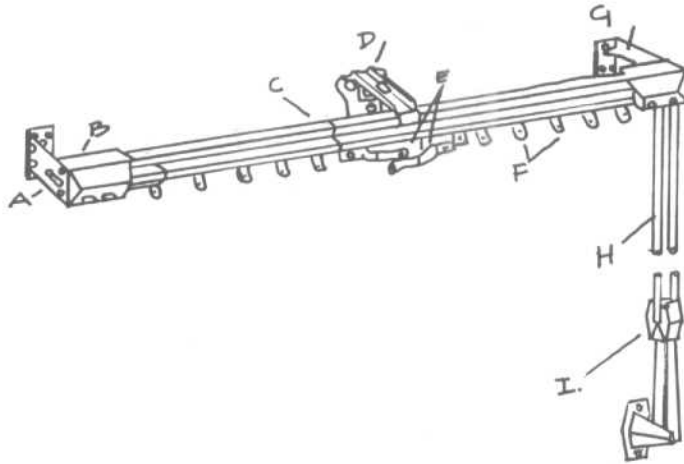
Wide telescoping curtain rod



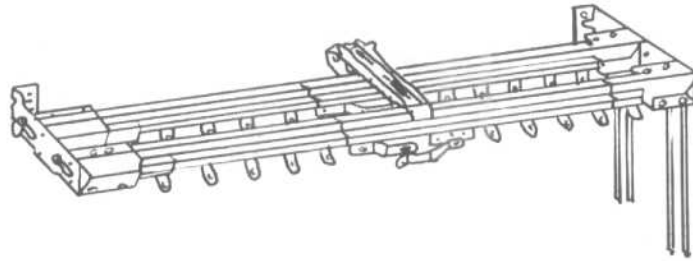
PVC pipe with elbows for projection

WINDOW TREATMENTS

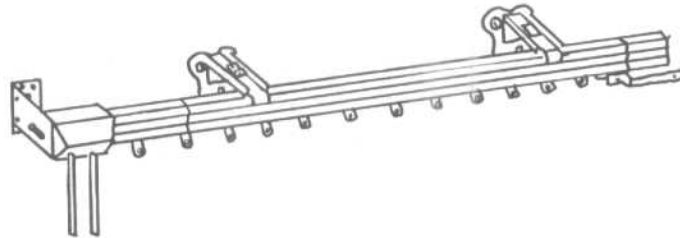
Traverse Rods



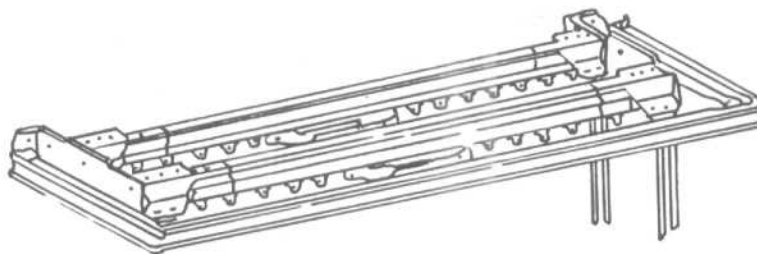
Conventional single hung traverse rod — A, projecting end brackets; B, end housing; C, telescoping rod; D, center support; E, master carriers; F, carriers; G, end bracket; H, cord; I, tension pulley



Double traverse rod



One-way traverse rod with two center supports



Double traverse rod with valence

## WINDOW TREATMENTS

Guidelines for Fabric Panel Widths and Rod Lengths

TABLE 2 Fabric Panel Widths and Pleating Guidelines

Desired pleated panel coverage	Flat fabric without hems	Hemmed flat fabric	Number of 4" flat spaces between pleats	Number of pleats	Width of fabric in each pleat
16"	43"	39"	4	5	3 $\frac{1}{8}$ "
20"	51"	47"	5	6	3 $\frac{1}{4}$ "
24"	59"	55"	6	7	3 $\frac{3}{8}$ "
28"	67"	63"	7	8	3 $\frac{1}{2}$ "
32"	75"	71"	8	9	3 $\frac{1}{2}$ "
36"	83"	79"	9	10	3 $\frac{5}{8}$ "
40"	91"	87"	10	11	3 $\frac{5}{8}$ "
44"	99"	95"	11	12	3 $\frac{5}{8}$ "
48"	107"	103"	12	13	3 $\frac{5}{8}$ "
52"	115"	111"	13	14	3 $\frac{5}{8}$ "
56"	123"	119"	14	15	3 $\frac{3}{4}$ "
60"	131"	127"	15	16	3 $\frac{3}{4}$ "
64"	139"	135"	16	17	3 $\frac{3}{4}$ "
68"	147"	143"	17	18	3 $\frac{3}{4}$ "
72"	155"	151"	18	19	3 $\frac{3}{4}$ "
76"	163"	159"	19	20	3 $\frac{3}{4}$ "
80"	171"	167"	20	21	3 $\frac{3}{4}$ "
84"	179"	175"	21	22	3 $\frac{3}{4}$ "
88"	187"	183"	22	23	3 $\frac{3}{4}$ "
92"	195"	191"	23	24	3 $\frac{3}{4}$ "
96"	203"	199"	24	25	3 $\frac{3}{4}$ "
100"	211"	207"	25	26	3 $\frac{3}{4}$ "
104"	219"	215"	26	27	3 $\frac{3}{4}$ "
108"	227"	223"	27	28	3 $\frac{3}{4}$ "
112"	235"	231"	28	29	3 $\frac{3}{4}$ "
116"	243"	239"	29	30	3 $\frac{3}{4}$ "
120"	251"	247"	30	31	3 $\frac{3}{8}$ "
124"	259"	254"	31	32	3 $\frac{3}{8}$ "
128"	267"	263"	32	33	3 $\frac{3}{8}$ "

TABLE 3 Rod Lengths Needed for Various Widths of Windows and Stackback Spaces

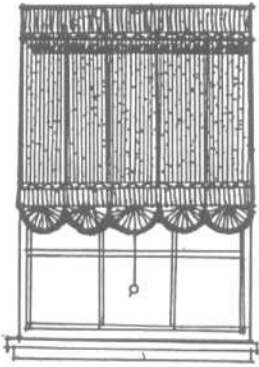
If the glass is	The stackback* should be	Your rod length and drapery coverage should be (add for overlaps and returns)
38"	26"	64"
44"	28"	72"
50"	30"	80"
56"	32"	88"
62"	34"	96"
68"	36"	104"
75"	37"	112"
81"	39"	120"
87"	41"	128"
94"	42"	136"
100"	44"	144"
106"	46"	152"
112"	48"	160"
119"	49"	168"
125"	51"	176"
131"	53"	184"
137"	55"	192"
144"	56"	200"
150"	58"	208"
156"	60"	216"
162"	62"	224"
169"	63"	232"
175"	65"	240"
181"	67"	248"
187"	69"	256"

\*For one-way draws, deduct 7" from stackback.

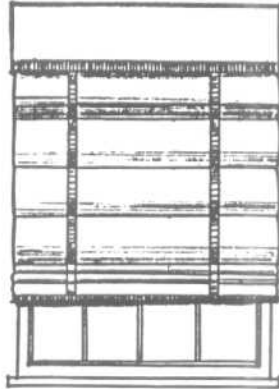
Note: Figures are based on average pleating and medium-weight fabric. For extra bulky fabrics, add to stackback to compensate for the additional space they require.

WINDOW TREATMENTS

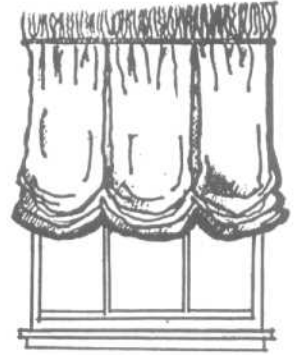
Shades



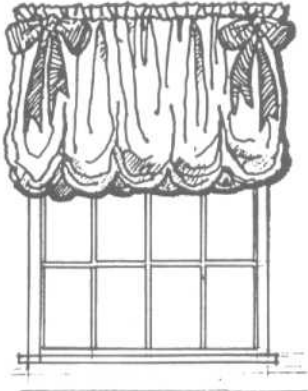
Overlapping trimmed valance over scalloped shade



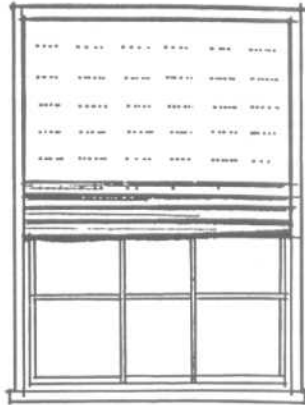
Banded valance over Roman shade



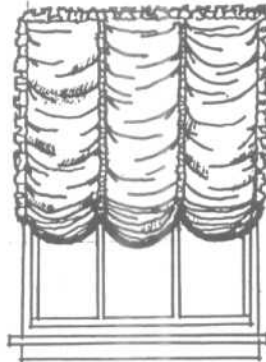
Shirred cornice box over tri-part balloon shade



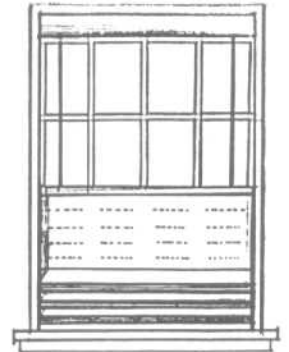
Twin bow cloud shade with gathered heading



Inset flush Roman shade with horizontal folds



Tri-part Austrian shade with ruffled trim

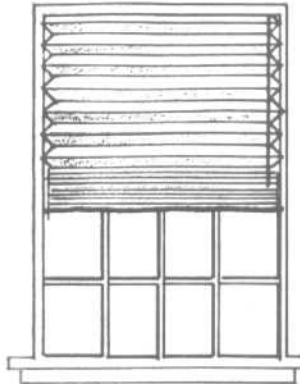


Inset flush bottom pull Roman shade with horizontal folds

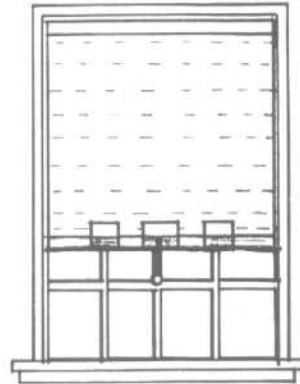


WINDOW TREATMENTS

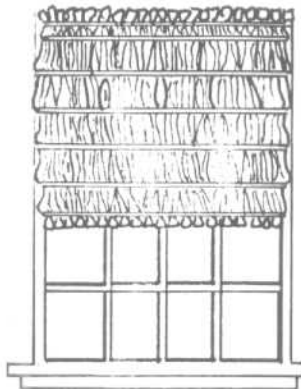
Shades



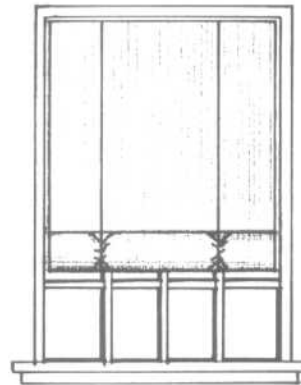
Pleated shade



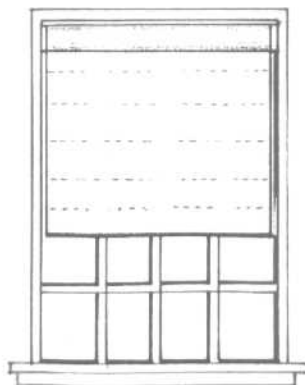
Crenellated edge



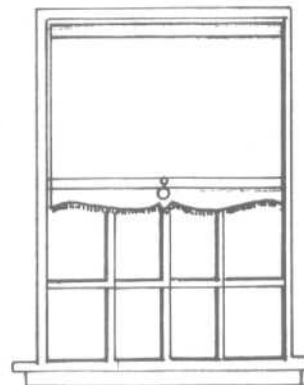
Shirred shade



Rolldown shade



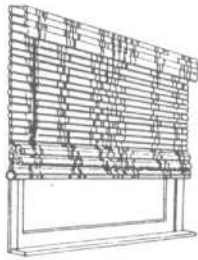
Rolldown shade



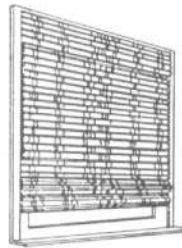
Pulldown shade

## WINDOW TREATMENTS

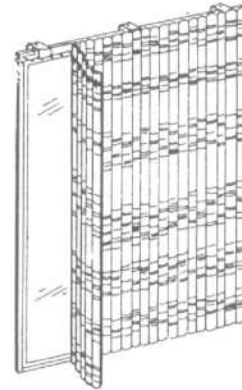
## Shades



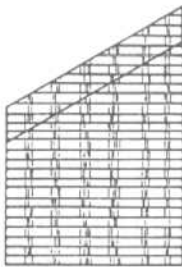
Outside mount



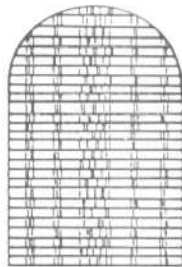
Inside mount



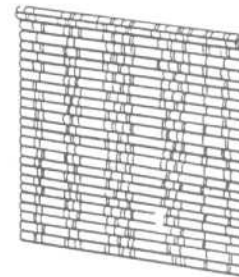
Drapery style



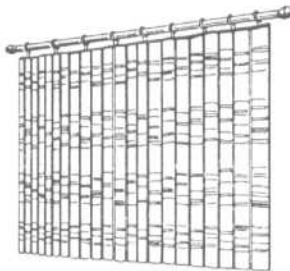
Angle top



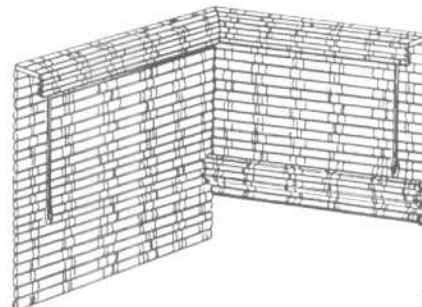
Cathedral canopy



Spring roller shade



Café curtain



Corner installation

Fig. 8 Woven wood blinds. These blinds have horizontal or vertical reeds — long slats of wood from  $\frac{1}{4}$  to 1 inch width — that are held together by decorative vertical yarns. They range in designs from those that are made mostly from exposed wood to those that are mainly yarns of several colors creating various interesting effects. Woven wood blinds can be used with many window treatments including draperies and café curtains, and such shade types as Roman-fold, spring-rolls, cord and pulley, and duo-fold. Top treatments include canopies, valances, and arches, while scallops, fringes, and trims are suitable for the bottom. Because woven wood blinds add color and texture to a window, they are particularly adaptable to the "natural" look in decorating.

## WINDOW TREATMENTS

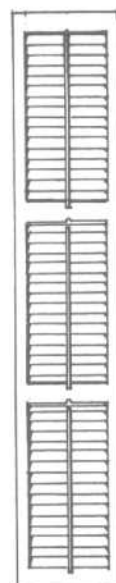
Shutters



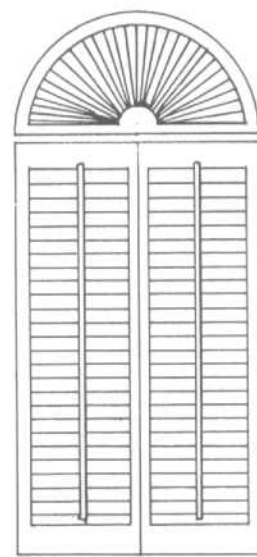
Louvers: 1/8",  
2 1/2", 3 1/2", 4 1/2";  
thickness: 1/4";  
width of stile: 2";  
width: 8" to 36" in  
1/4" increments



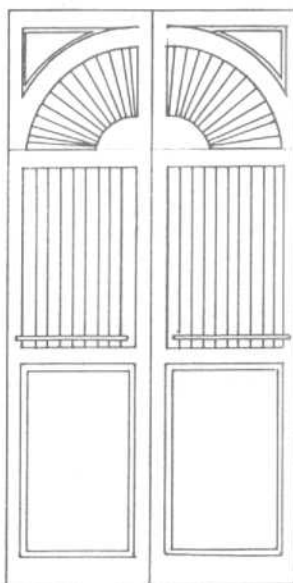
Louvers: 1/8",  
2 1/2", 3 1/2", 4 1/2";  
thickness: 1/4";  
width of stile: 2";  
width: 8" to 36" in  
1/4" increments.



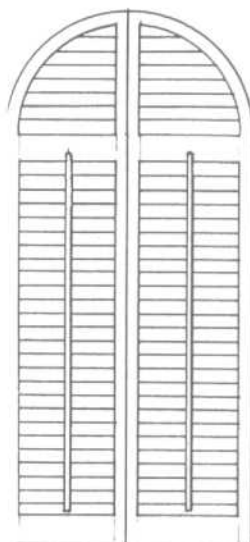
Louvers:  
2 1/2".



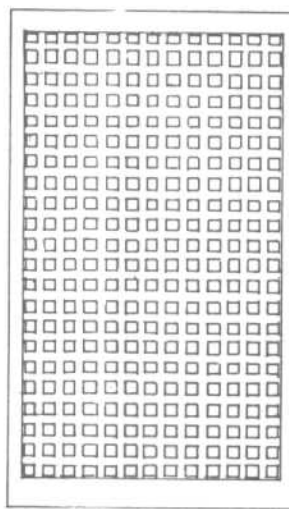
Fan top (nonadjustable  
louvers); louvers: 2 1/2";  
thickness: 1/4".



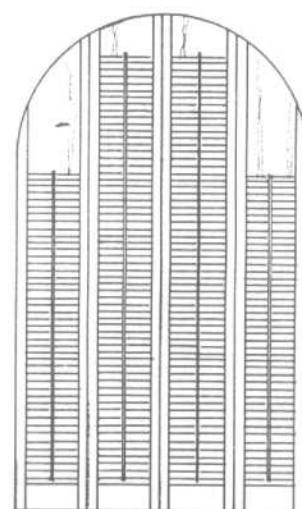
Louvers: 2 1/2"; thickness: 1/4".



Louvers: 2 1/2"; thickness:  
1/4".



Louver grid. Standard:  
4' x 8" unframed; standard  
framing: 1/16" wide x 2/4"  
thick.

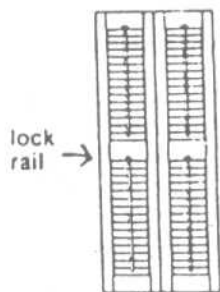
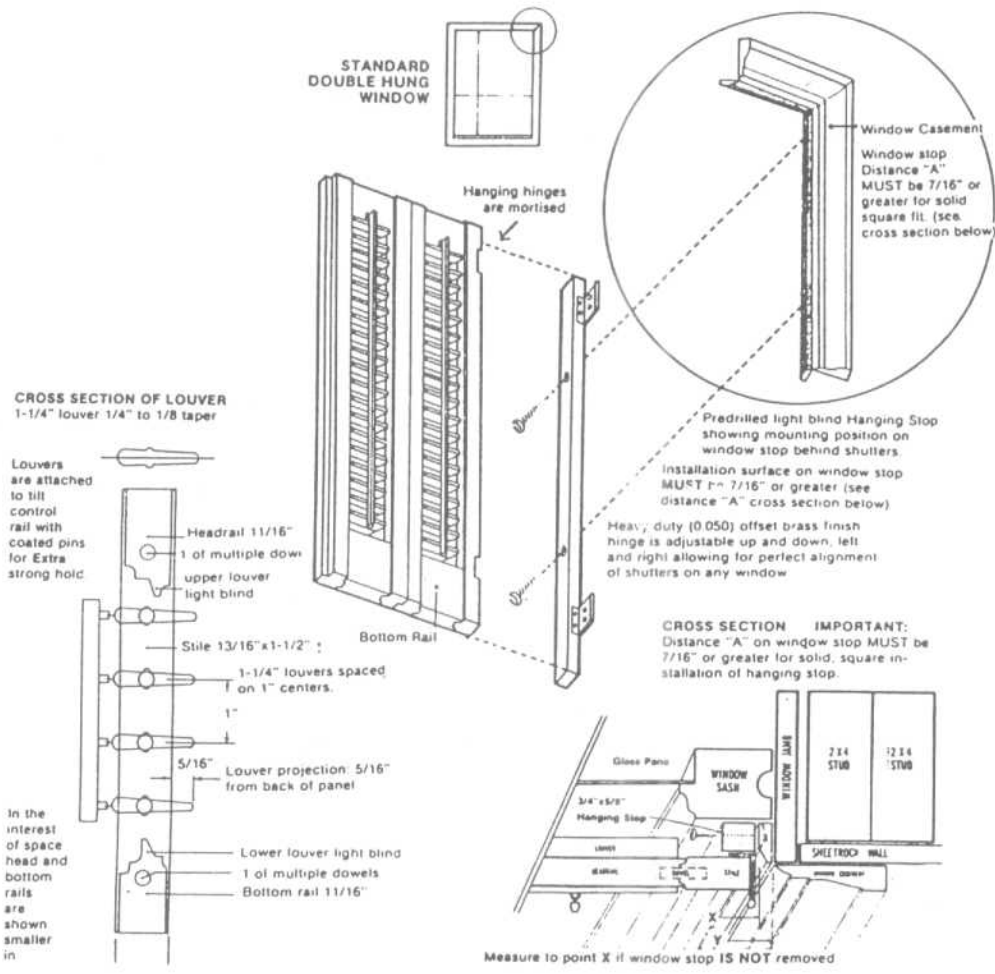


Traditional/Dixie panel;  
louvers: 1/4"; thickness: 1/8".

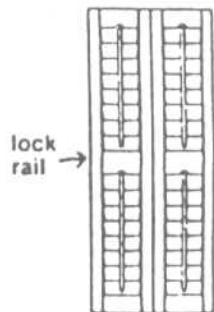
Fig. 9 Inside shutters can be used next to windows in place of curtains. Some are put under curtains or draperies; others are used café style either above or beneath café curtains. Shutters may be made from wood or metal. Natural wood tones are often used to enhance the beauty of the shutters. The inside section may be made from any of the following materials: fabric mesh, cane, grill cloth, or screening.

WINDOW TREATMENTS

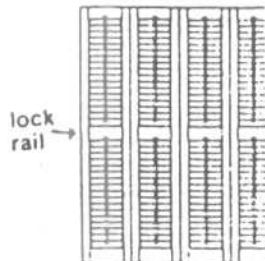
Shutters



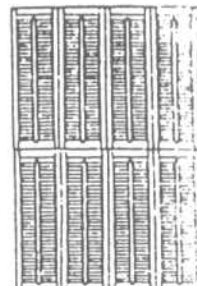
2-panel single hung



2-panel single hung



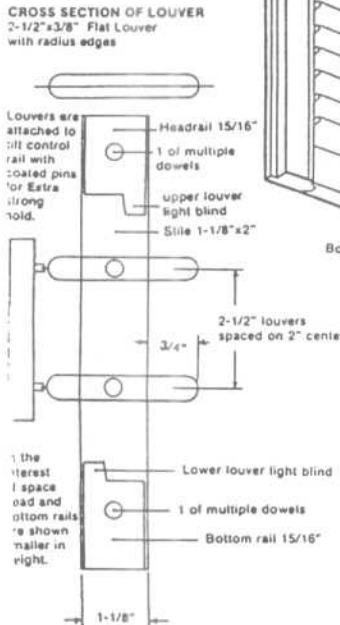
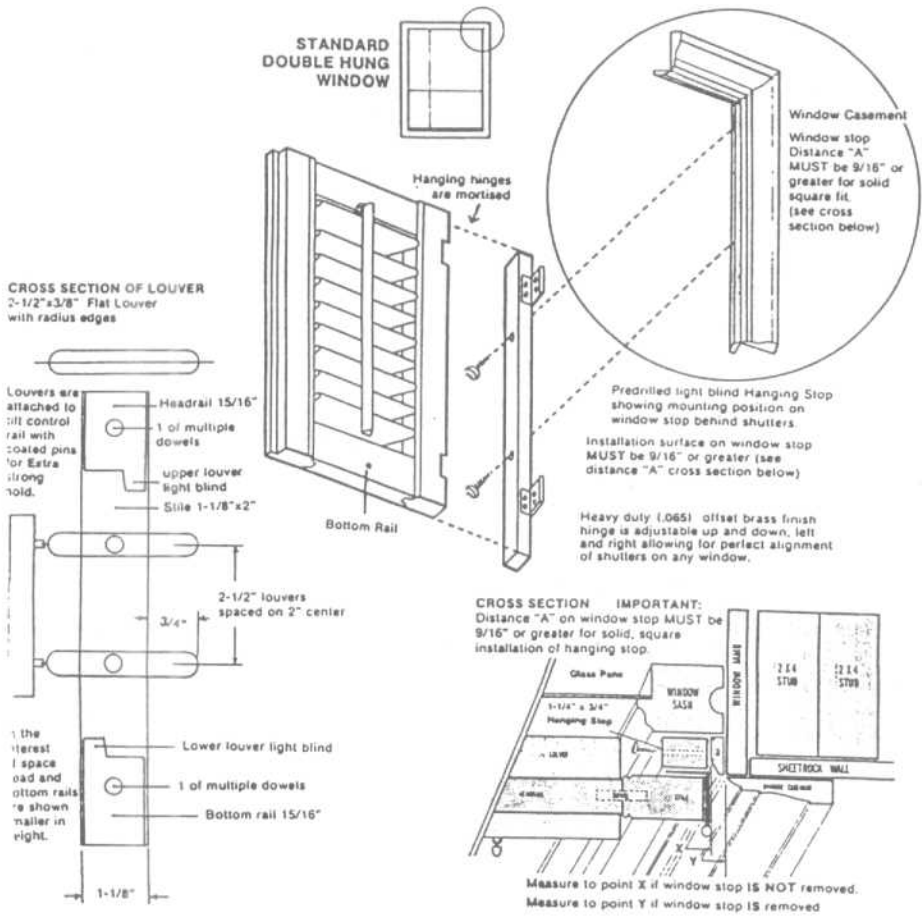
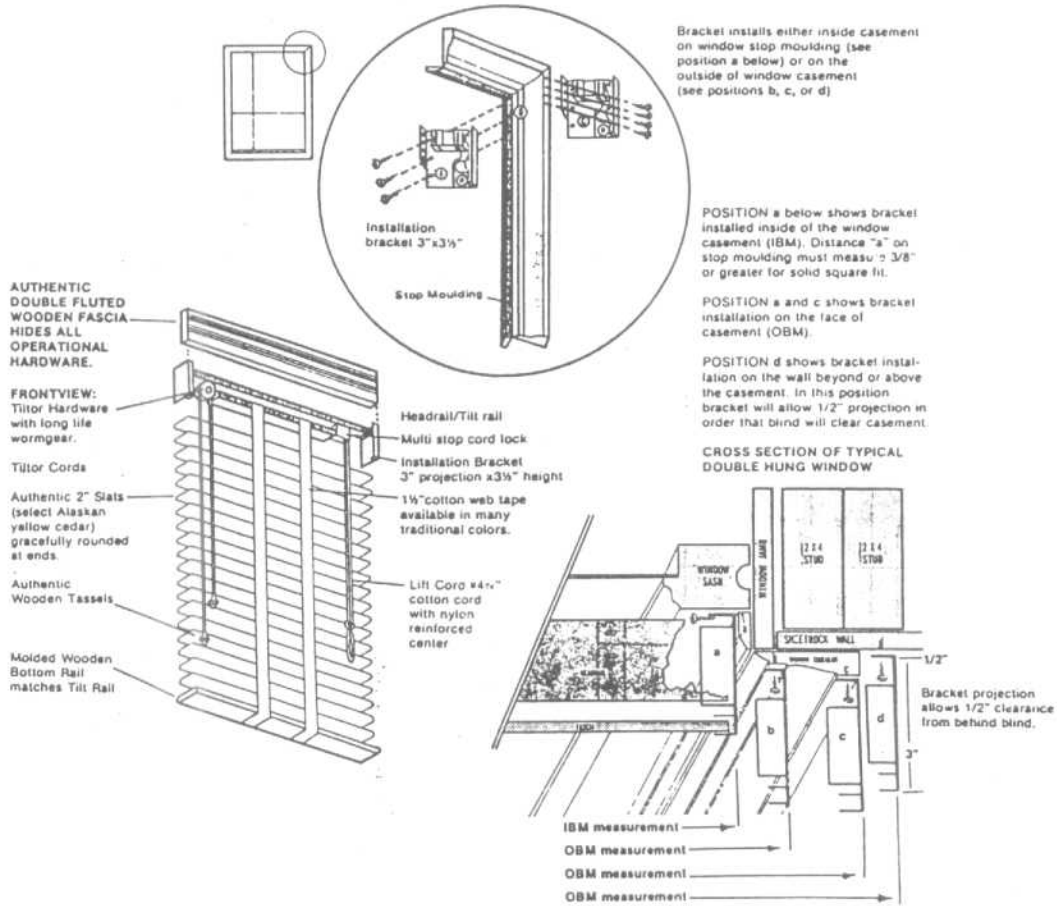
Bi-fold single hung



Bi-fold double hung

WINDOW TREATMENTS

Shutters and Venetian Blinds

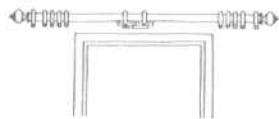


## WINDOW TREATMENTS

## Guidelines

## DECORATIVE RODS

## Measuring for Most Windows

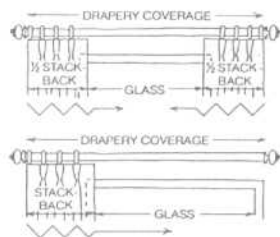


**Outside mount** Decorative rods should be mounted on the wall. Measure width of glass; if total glass exposure is desired, add for stackback (see Table 4). Rods should be hung so that drapery headings (pleated tops of panels) are at least 4" above the glass, so they can't be seen from the outside.

## Figuring Stackback

Stackback is the amount of wall space needed if open panels are to clear the glass completely. This dimension, added to the window opening, gives you the proper rod length.

Begin by measuring the window opening, then consult Table 4. Find your opening measurement and read across for the right rod length.



**TABLE 4** Stackback: Average Pleating and Medium Weight Fabric

Window opening	Stackback*	Rod length
24"	21"	45"
30"	23"	53"
36"	25"	61"
42"	26"	68"
48"	29"	77"
54"	30"	84"
60"	31"	91"
66"	32"	98"
72"	34"	106"
78"	36"	114"
84"	37"	121"
90"	38"	128"
96"	39"	135"
102"	42"	144"
108"	44"	152"
114"	45"	159"
120"	48"	168"

\*Deduct 7" for one-way draw.

## Measuring for Special Windows

**Sliding doors** Measure as for outside mounted rod. Convert rod from two to one-way draw.

**Corner and bay windows** Decorative rods may be used at these windows. However, it is best to consult your dealer or designer about the measuring.

## Layered Treatments

Decorative traverse rods are often used for overtreatments. If the undertreatment is inside mounted or is an outside mounted mini-blind, pleated shade, Romanette woven wood or a cafe curtain, set the brackets for maximum clearance. Drapery returns will be 4½".

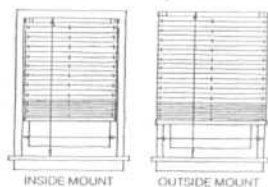
If you are using an undercurtain, you will want a utility curtain rod. It comes with its own bracket-supports.

If you are using underdraperies, double brackets are available. They hold both rods and automatically align the headings. Overdrapery returns will be 6" to 7".

If using a decorative rod over an outside mounted vertical blind or a woven wood shade other than Romanette, special brackets are available. Overdrapery returns will be 6" to 7".

## PLEATED SHADES

## Measuring for Most Windows



**Inside mount** Measure width at top, center and bottom. Use narrowest measurement. Shades will be made narrower to slip inside easily. Measure length from inside top of opening to sill. A 1⅝" deep recess is needed for flush mounting. 2¼" for Duette in ¾.

**Outside mount** Measure width of opening. Add at least 1½" on each side for overlap. Measure from top of frame to sill or 1½" below opening if there is no sill. (If brackets are to go above window frame, add an extra 1½" for bracket bases.)

**Ceiling mount** Measure desired width and length of blind. Overlap window openings by at least 1½" on each side.

## Measuring for Special Windows

**Multiple shades** At very wide or sectioned windows and at sliding doors, it's wise to use two shades hung from one headrail. Make a drawing of the window; include measurements of glass, woodwork and overall size. Your dealer will do the rest.

**Corner windows** Inside-mounted shades need no special measuring instructions. If outside or ceiling-mounted shades are used, they can be overlapped. Make a drawing of the windows; include measurements of glass, woodwork and overall size. Your dealer will do the rest.

**Other special windows** Bays and other unusual windows can frequently be fitted for pleated shades. Make a drawing of the window; include measurements of glass, woodwork and overall size. Or ask your dealer to do the measuring for you.

## Layered Treatments

Pleated shades are most often used with an undertreatment. If inside mounted, no extra projection is needed for the overtreatment. If outside mounted, the overtreatment must have a clearance of 2½" to clear the headrail. A cornice used over pleated shades should have a 4½" return.



**TABLE 5** Stack Chart

Shade length	Stack
24"	1¾"
36"	1⅞"
48"	2"
60"	2⅛"
72"	2¼"
84"	2⅝"
96"	2½"

Measurements are from top of headrail to bottom of bottom rail.

## CONVENTIONAL TRAVERSE RODS

## Measuring for Most Windows

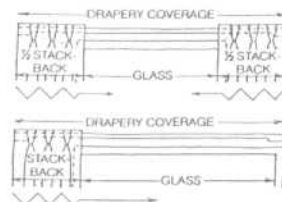


**Outside or ceiling mount** Conventional rods may be mounted on the wall or ceiling. Measure the width of glass; if total glass exposure is desired, add for stackback (see Table 4). Rods should be hung so that drapery headings (pleated tops of panels) are at least 4" above the glass, so they can't be seen from the outside.

## Figuring Stackback

Stackback is the amount of wall space needed if open panels are to clear the glass completely. This dimension, added to the window opening, gives you the proper rod length.

Begin by measuring the window opening, then consult Table 4. Find your opening measurement and read across the right rod length.



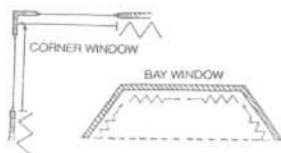
## Measuring for Special Windows

**Sliding doors** Measure as for outside mounted rod. Use a one-way draw rod.

## WINDOW TREATMENTS

Guidelines

**Corner and bay windows** Measure each window as if it were set flat into the wall. At corners, run one rod into the corner and butt the other into it. At bays, butt all rods. Use either one or two-way draw rods for corners. For bays, use three two-way rods or two one-ways with a two-way in the center.

**Layered Treatments**

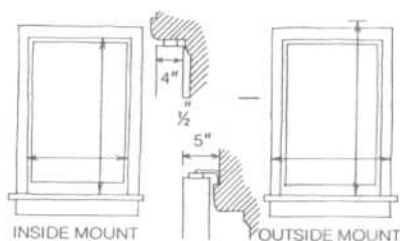
Conventional traverse rods come in sets specifically for layered treatments. If you are using an undercurtain, you will want a traverse and plain rod set; both rods are on one set of brackets. Overdrapery returns will be 4½" to 5½".

If you are using underdraperies, use a double traverse rod set. Again, one set of brackets holds both rods. Overdrapery returns will be 5½" to 6½".

If the undertreatment is inside mounted or is an outside mounted mini-blind, pleated shade, Romanette woven wood or a cafe curtain, use a single rod and set the brackets for maximum clearance. Drapery returns will be 4½".

If the undertreatment is an outside-mounted vertical blind or a woven wood shade other than Romanette, special extender plates for brackets and supports are available. Overdrapery returns will be 5½" to 6½".

Remember, whenever you change the clearance of the brackets, you also change the drapery return.

**VERTICAL BLINDS****Measuring for Most Windows**

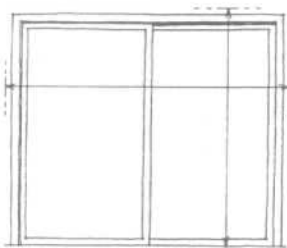
**Inside mount** Measure width at top, center and bottom. Use narrowest measurement. Verticals will be made slightly narrower to slip inside easily. Measure length from inside top of opening to sill. A minimum 3¼" recess is required for track; 4½" if open vanes are to be flush with front of opening.

**Outside mount** Measure width of opening. Add for stackback (see Tables 6 and 7). Measure from a point 2½" above top of frame to sill or floor; deduct ¾" for clearance.

Minimum projection of front of vane from wall is 5"; maximum is 6½". Minimum clearance of back of vane from wall is 1"; maximum is 2½".

**Ceiling mount** Measure desired width and length of verticals; deduct at least ¾" for floor clearance.

**Cirmosa 2000** Ask your designer, decorator, or store to measure for you.

**Measuring for Special Windows**

**Sliding doors** Use a one-way draw. Measure width from trim to trim. Add to this measurement desired extra width for overlap beyond door. If total glass exposure is desired, also add for stackback (see Tables 6 and 7). Measure from a point 2½" above door trim to floor; deduct ¾" for clearance.

**Layered Treatments**

When layered, verticals are most often used as an undertreatment. If inside mounted, no extra clearance is needed for the overtreatment. If outside mounted, the overtreatment must have a clearance of 6" to clear the open vanes. A cornice used over verticals should have a 6" return.

**Figuring Stackback**

Stackback is the amount of wall space needed if open verticals are to clear the glass completely. This dimension, added to the window opening, gives you the proper track length.

Begin by measuring the window opening, then consult Table 6 or 7 for the type of treatment you desire — one- or two-way draw. Find your opening measurement and read across for the right track. (Note: Stackback figure for two-way draw is total stack; one-half of this is on each side of the window.)

If your window opening is somewhere in between the measurements in the tables, go to the next smallest opening. Add the stackback listed there to your opening dimension.

**TABLE 6 Two-Way Draw Stackback**

Window opening	Stackback	Track
24"	9"	33"
30"	10"	40"
36"	11"	47"
42"	12"	54"
48"	14"	62"
54"	15"	69"
60"	16"	76"
66"	17"	83"
72"	19"	91"
78"	20"	98"
84"	21"	105"
90"	22"	112"
96"	23"	119"
102"	25"	127"
108"	26"	134"
114"	27"	141"
120"	29"	149"

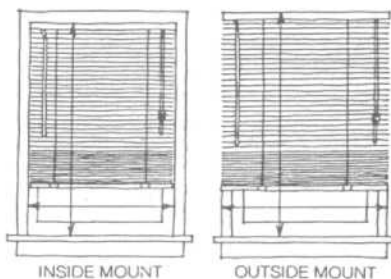
**TABLE 7 One-Way Draw Stackback**

Window opening	Stackback	Track
24"	7"	31"
30"	8"	38"
36"	9"	45"
42"	11"	53"
48"	12"	60"
54"	13"	67"
60"	14"	74"
66"	15"	81"
72"	17"	89"
78"	18"	96"
84"	19"	103"
90"	20"	110"
96"	21"	117"
102"	22"	124"
108"	23"	131"
114"	25"	139"
120"	26"	146"

**MINI BLINDS****Measuring for Most Windows**

**Inside mount** Measure width at top, center and bottom. Use narrowest measurement. Blinds will be made slightly narrower to slip inside easily. Measure length from inside top of open to sill. A 1½" deep recess is needed for flush mounting of Mono-Rail minis; however, a difference of ¼" is not objectionable.

**Outside mount** Measure height and width of area to be covered. It is recommended that blinds overlap window opening by at least 1½" on each side. Measure from top of frame to sill or 1½" below opening if there is no sill.



**Ceiling mount** Measure desired width and length of blind. Overlap window openings by at least 1½" on each side.

**TABLE 8 Stack Chart**

Blind length	Mini stack	Micro stack
36"	3"	3¼"
48"	3½"	3¾"
60"	4"	4¼"
72"	4½"	4¾"
84"	4¾"	5¼"
96"	5¼"	5¾"
108"	5½"	6¼"

Measurements are from top of headrail to bottom of bottomrail.



## ELEVATORS

## Elevator Types and Planning

## ELEVATOR TYPES

**Hydraulic:** For low-rise buildings — speeds up to 200 ft/min. Ideal where design limitations preclude overhead supports and machine rooms. Economical to install and maintain; no penthouse or load-bearing walls required.

**Gearless traction:** For low- to medium-rise buildings — speeds up to 400 ft/min. Recommended for all types of buildings where higher speeds are not essential.

**Gearless traction:** Recommended for high-rise applications requiring the ultimate in service — speeds of 500 ft/min and up.

## ELEVATOR PLANNING

## Starting Point Recommendations for All Types of Buildings

When preparing schematics for a particular type of building, select the quantity, capacity, and speed from one of Tables 1 to 4 and keep in mind that generally speaking:

- Passenger elevators should be wide and shallow with center-opening or single slide doors.

- Service elevators should be narrow and deep with two-speed doors.

- Combination passenger/service elevators should be almost square with either center-opening or two-speed center-opening doors.

- Freight elevator size and shape should be determined by the dimensions of goods to be carried and by the loading/unloading methods used. Doors should be of the vertical bi-parting type.

The data contained in Tables 1 to 4 are based upon the following criteria.

**Office buildings** 100 square feet per person; an interval of 30 sec.; net rentable area = 80% of gross area; 5 minute carrying capacity of 12% of building population; typical floor heights were estimated at 12' and the main floor at 18'. When the building exceeds 250,000 square feet total, it is suggested that consideration be given to the use of separate freight elevators which are not included in Table 1.

**Hospitals** 5 minute vehicular demand =  $.04 \times$  the number of beds; interval of 35–50 seconds for vehicular traffic; visitor and staff population =  $3 \times$  number of beds; 5 minute carrying capacity equal to 12% of building population.

**Hotels** Registration during conventions =  $1.5 \times$  the total number of rooms; maximum 1 hour peak is  $1.15 \times$  total registrations; 5 minute carrying capacity = 10% of total 1 hour peak load.

**Apartments** Population est. @ 2 persons per bedroom; 5 minute carrying capacity of 7%; maximum waiting interval of 60–90 seconds; average of 9'0" floor height. Further, Table 4 applies only for average or middle income apartments. For applications beyond the scope of the table such as local-express arrangements, luxury apartment buildings and other considerations, please consult your local elevator company representative.

Note: If a restaurant or general assembly area is located in your building (on any but the main floor) and is not served by a separate elevator, the information contained in Tables 1 to 4 may not apply.

TABLE 1 Office Buildings — Passenger Elevators Only

Number of Floors, Including Main	GROSS SQUARE FOOTAGE/FLOOR			
	5000 Sq. Ft.	8000 Sq. Ft.	12000 Sq. Ft.	16000 Sq. Ft.
5 floors	2 Elev. 2500# @ 250 fpm	2 Elev. 2500# @ 250 fpm	3 Elev. 2500# @ 250 fpm	3 Elev. 2500# @ 300 fpm
6 to 8 floors	3 Elev. 2500# @ 350 fpm	3 Elev. 2500# @ 350 fpm	3 Elev. 2500# @ 400 fpm	4 Elev. 2500# @ 400 fpm
9 to 12 floors	4 Elev. 2500# @ 400-500 fpm	4 Elev. 2500# @ 400-500 fpm	4 Elev. 3000# @ 500 fpm	5 Elev. 3500# @ 600 fpm
13 to 15 floors	4 Elev. 2500# @ 600 fpm	4 Elev. 2500# @ 600 fpm	5 Elev. 3000# @ 700 fpm	6 Elev. 3500# @ 700 fpm
16 to 19 floors	5 Elev. 2500# @ 700 fpm	6 Elev. 2500# @ 700 fpm	*	*
20 to 22 floors	5 Elev. 2500# @ 800 fpm	6 Elev. 3000# @ 800 fpm	*	*

\* Because of the complexities such as local and express arrangements and service requirements inherent in taller and larger buildings, we suggest you contact your Armor representative when the limitations of this chart are exceeded.

TABLE 2 Hospitals

Number of Floors	BEDS/FLOOR			
	Up to 20 Beds	21 to 30 Beds	31 to 40 Beds	41 to 50 Beds
Up to 6 Floors	3 Elev. 4500# @ 200 fpm	4 Elev. 2-3000# @ 300 fpm 2-4500# @ 300 fpm	5 Elev. 2-3000# @ 350 fpm 3-4500# @ 350 fpm	5 Elev. 2-3000# @ 350 fpm 3-4500# @ 350 fpm
7 to 9 floors	6 Elev. 3-3000# @ 500 fpm 3-4500# @ 500 fpm	7 Elev. 3-3000# @ 500 fpm 4-4500# @ 500 fpm	8 Elev. 4-3000# @ 500 fpm 4-4500# @ 500 fpm	9 Elev. 4-3000# @ 500 fpm 5-4500# @ 500 fpm
10 to 12 floors	7 Elev. 3-3000# @ 500 fpm 4-4500# @ 500 fpm	8 Elev. 4-3000# @ 500 fpm 4-4500# @ 500 fpm	9 Elev. 4-3000# @ 500 fpm 5-4500# @ 500 fpm	10 Elev. 4-3000# @ 500 fpm 6-4500# @ 500 fpm

NOTE: The number of elevators listed above will most likely be reduced if automatic cart and/or container handling equipment for food, laundry, surgical instrument and central supply distribution is used.

TABLE 3 Hotel Buildings — Passenger Elevators Only

Number of Floors	UNITS/FLOOR			
	Up to 14 Units	15 to 20 Units	21 to 28 Units	29 to 32 Units
4 to 5 floors	2 Elev. 3000# @ 150 fpm	2 Elev. 3000# @ 175 fpm	2 Elev. 3000# @ 200 fpm	2 Elev. 3000# @ 200 fpm
6 to 9 floors	2 Elev. 3000# @ 300 fpm	2 Elev. 3000# @ 350 fpm	2 Elev. 3000# @ 400 fpm	3 Elev. 3000# @ 300 fpm
10 to 12 floors	3 Elev. 3000# @ 300 fpm	3 Elev. 3000# @ 350 fpm	4 Elev. 3000# @ 350 fpm	4 Elev. 3000# @ 350 fpm
13 to 15 floors	4 Elev. 3000# @ 350 fpm	4 Elev. 3000# @ 350 fpm	4 Elev. 3000# @ 350 fpm	4 Elev. 3000# @ 350 fpm
16 to 20 floors	4 Elev. 3000# @ 350 fpm	4 Elev. 3000# @ 400 fpm	4 Elev. 3000# @ 400 fpm +1 Service 3500# @ 400 fpm	4 Elev. 3000# @ 400 fpm +2 Service 3500# @ 400 fpm

NOTE: Because of the complexities such as local and express and service requirements inherent in taller and larger hotels, we suggest that you contact your Armor representatives when the limitations of this chart are exceeded.

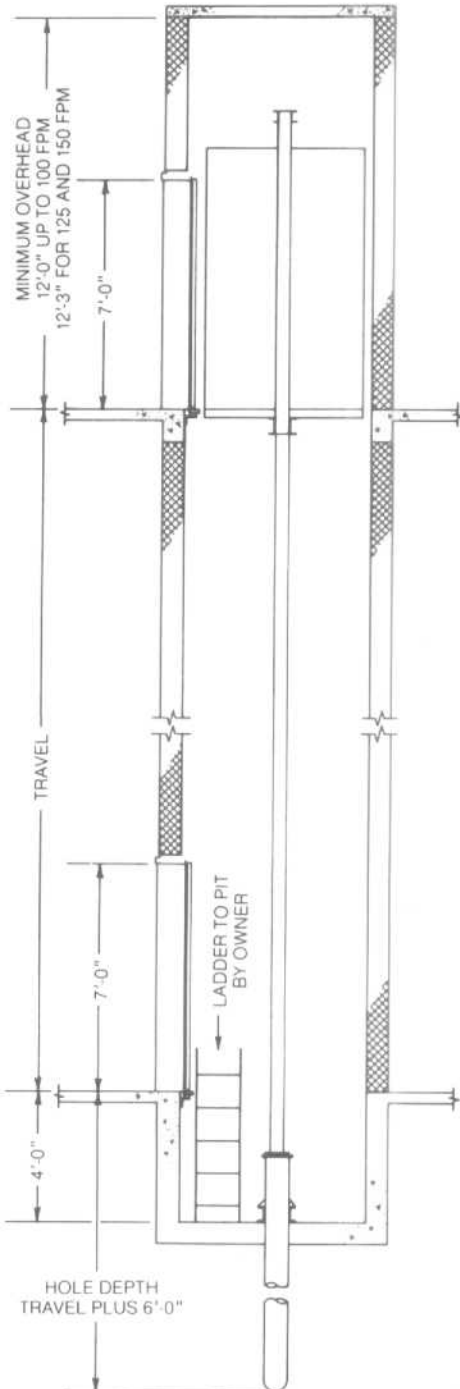
TABLE 4 Apartment Buildings — Passenger Elevators Only

Number of Floors Including Main	BEDROOMS/FLOOR			
	10 Bedrooms	16 Bedrooms	22 Bedrooms	30 Bedrooms
6 floors	1 Elev. 2000# @ 150 fpm	1 Elev. 2000# @ 150 fpm	2 Elev. 2000# @ 150 fpm	2 Elev. 2000# @ 150 fpm
12 floors	2 Elev. 2000# @ 200 fpm	2 Elev. 2000# @ 200 fpm	2 Elev. 2500# @ 250 fpm	3 Elev. 2500# @ 250 fpm
18 floors	3 Elev. 2000# @ 350 fpm	3 Elev. 2000# @ 350 fpm	3 Elev. 2500# @ 350 fpm	4 Elev. 2500# @ 350 fpm
25 floors	3 Elev. 2500# @ 400 fpm	3 Elev. 2500# @ 400 fpm	4 Elev. 2500# @ 400 fpm	*
32 floors	3 Elev. 2500# @ 500 fpm	4 Elev. 2500# @ 500 fpm	*	*
40 floors	4 Elev. 2500# @ 700 fpm	*	*	*

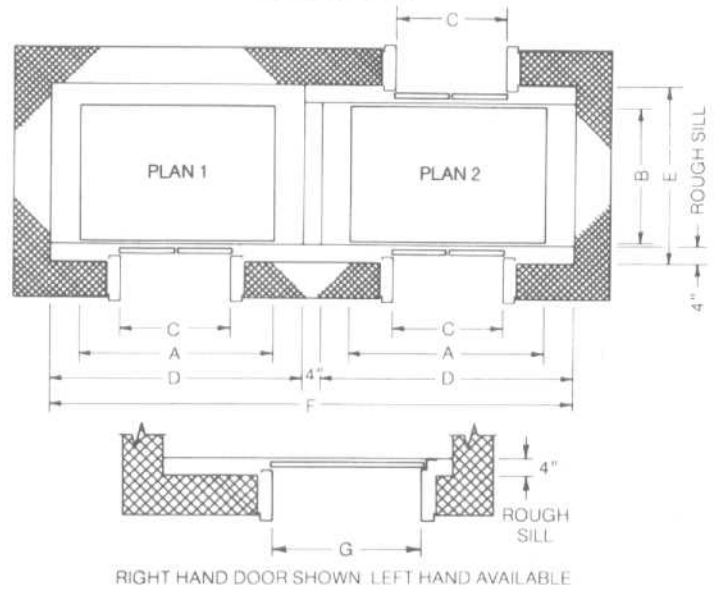


## HYDRAULIC ELEVATORS

Ideal for use in buildings up to six floors. Supported and raised by a powerful hydraulic plunger, the Oildraulic is renowned for smooth performance, quiet operation, and accurate floor leveling. And since it's supported from below, no vertical load is placed on the building. That means hoistways can be of lighter construction and no penthouse is needed. The machine room can be located nearly anywhere to let you maintain a flat roof line and save money on construction.



## HOISTWAY PLAN



## RECOMMENDED SIZES AND CAPACITIES

TYPE BUILDING	APARTMENT		AVERAGE OFFICE/HOTEL		LARGE OFFICE/STORE	
	FLEET-WOOD 21-H	PLAN 1 MARQUIS-25	PLAN 2 MARQUIS-25	SEVILLE-30	SEVILLE-35	
MODEL						
CAPACITY (IN POUNDS)						
DIMENSIONS	2100 &	2500 &	2500 &	3000 &	3500 &	
A <sup>1</sup>	5'-8"	6'-8"	6'-8"	6'-8"	6'-8"	
B <sup>1</sup>	4'-3"	4'-3"	4'-3 1/2"	4'-9"	5'-5"	
C	—	3'-6"	3'-6"	3'-6"	3'-6"	
D <sup>2</sup>	7'-4"	8'-4"	8'-4"	8'-4"	8'-4"	
E	5'-9"	5'-9"	6'-8 3/4"	6'-3"	6'-11"	
F	15'-0"	17'-0"	17'-0"	17'-0"	17'-0"	
G	3'-0"	3'-6"	3'-6"	3'-6"	3'-6"	

<sup>1</sup> Inside dimensions.

<sup>2</sup> Single car dimensions.

& These models meet minimum size for handicapped use.

Hoistway dimensions are based on no provisions for seismic conditions and 8'-0"

O.A. nominal cab height.

Standard speeds available: 75, 100, 125, 150 FPM.

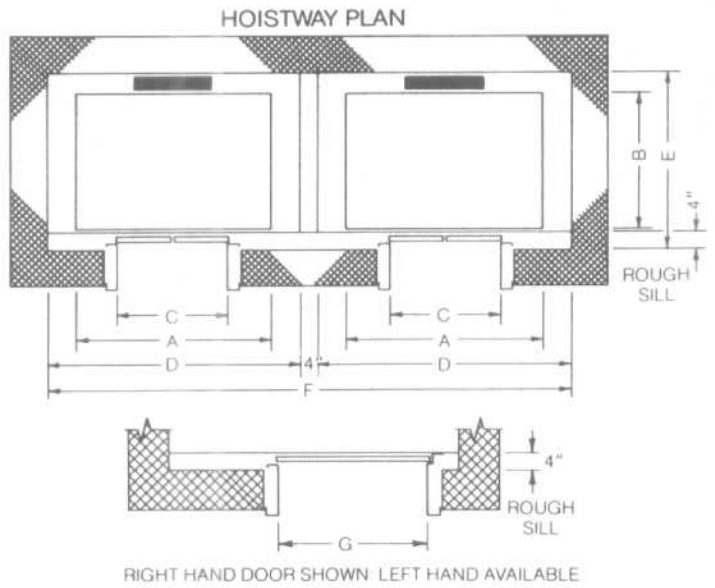
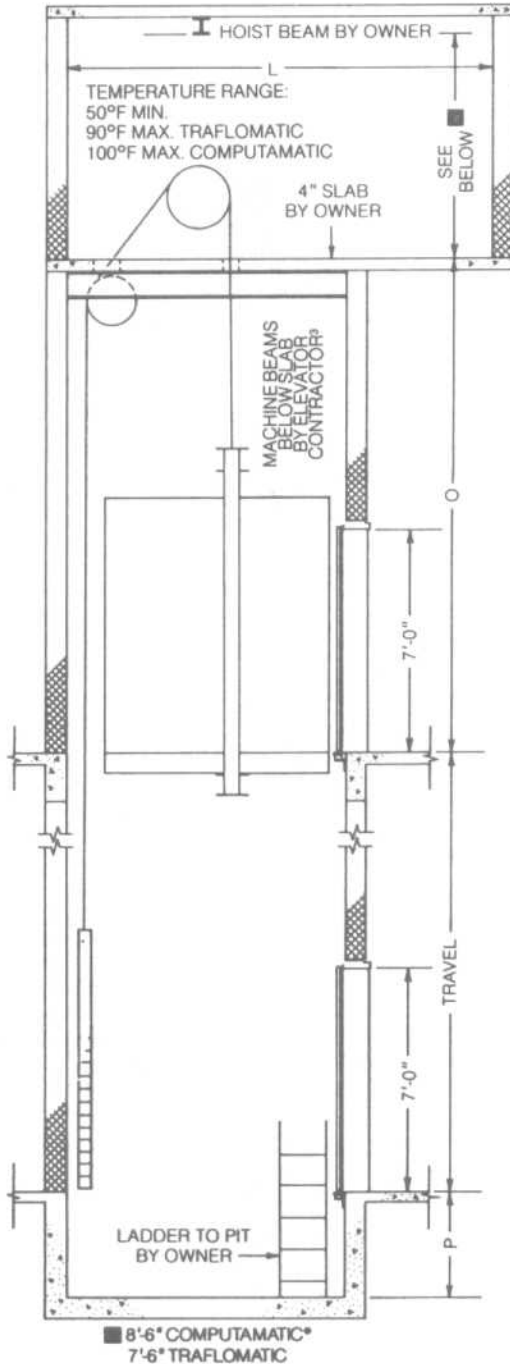
**POWER UNIT (MACHINE) LOCATION:** The most desirable machine room location is on the lowest floor, adjacent to the elevator hoistway. It may, however, be located remote from hoistway if necessary. Typical size for one-car installation: 7'-10" x 5'-6" x 8'-0" high; for two cars: 10'-9" x 6'-6" x 8'-0" high. Enclosure to meet local code requirements must be provided. A sound-isolated machine room is recommended for quietest operation. Adequate heating and ventilation of machine spaces must be provided.

**ELEVATORS**

High-Rise Elevators

**TRACTION ELEVATORS**

For use in buildings over six floors. They can serve up to 27 landings and can be used in office buildings, apartment complexes, dormitories, hotels, and other structures. These elevators can travel up to 1000 ft/min and are ideal for high-rise buildings of all kinds.



**RECOMMENDED SIZES AND CAPACITIES**

TYPE BUILDING	SMALL OFFICE/ APARTMENT	AVERAGE OFFICE/HOTEL	LARGE OFFICE/STORE	
MODEL	SPF21-H & b	SPF25 & b	SPF30 & b, SPF35 & b	
CAPACITY (IN POUNDS)				
DIMENSIONS	2100	2500	3000	3500
A <sup>1</sup>	5'-8"	6'-8"	6'-8"	6'-8"
B <sup>1</sup>	4'-3"	4'-3"	4'-9"	5'-5"
C	—	3'-6"	3'-6"	3'-6"
D <sup>2</sup>	7'-4"	8'-4"	8'-4"	8'-4"
E	6'-8"	6'-8"	7'-2"	7'-10"
F	15'-0"	17'-0"	17'-0"	17'-0"
G	3'-0"	3'-6"	3'-6"	3'-6"

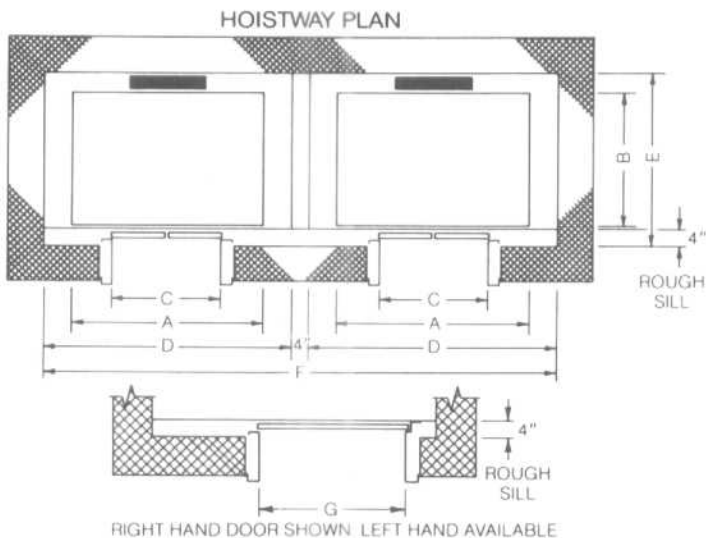
<sup>1</sup> Inside dimensions  
<sup>2</sup> Single car dimensions  
 & b These models meet minimum size for handicapped use.

Hoistway dimensions are based on 1" out of plumb, no provisions for seismic conditions, and no occupied space below hoistway. If these conditions cannot be met, then consideration must be given for additional required space.

**MINIMUM PIT, OVERHEAD, MACHINE ROOM DIMENSIONS**

CAPACITY (IN LBS.)	DIMENSIONS	SPEED (FEET PER MINUTE)		
		200	350	450
2100	L	16'-0"	16'-0"	—
	O	15'-4"	15'-4"	—
	P <sup>4</sup>	5'-0"	5'-0"	—
2500	L	16'-0"	16'-0"	16'-0"
	O	15'-4"	15'-4"	16'-4"
	P <sup>4</sup>	5'-0"	5'-0"	6'-6"
3000	L	16'-0"	16'-0"	16'-0"
	O	15'-4"	16'-0"	16'-4"
	P <sup>4</sup>	5'-0"	5'-0"	6'-6"
3500	L	16'-0"	16'-0"	16'-0"
	O	15'-4"	16'-0"	17'-6"
	P <sup>4</sup>	5'-0"	5'-0"	6'-6"

Overhead "O" based on 8'-0" O.A. nominal cab height.  
<sup>3</sup> Machine beams designed per ANSI/ASME code A17.1 and does not include floor weight and loads on floor.  
<sup>4</sup> 6'-0" min. "P" travel above 250'-0" SPF21 SPF25  
 travel above 225'-0" SPF30  
 travel above 200'-0" SPF35 } for speeds up to 350 F/M



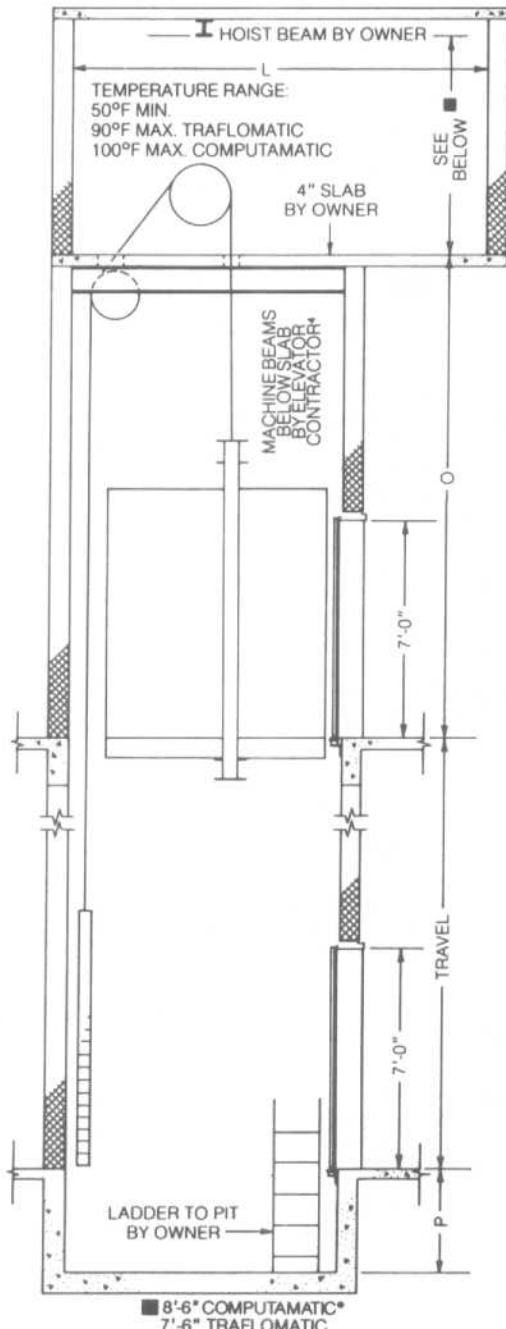
RECOMMENDED SIZES AND CAPACITIES						
TYPE BUILDING	SMALL OFFICE/APARTMENT	AVERAGE OFFICE/HOTEL			LARGE OFFICE/STORE	
	CAPACITY (IN POUNDS)					
DIMENSIONS	2000 <sup>b</sup>	2100 <sup>b</sup>	2500 <sup>b</sup>	3000 <sup>b</sup>	3500 <sup>b</sup>	4000 <sup>b</sup>
A <sup>1</sup>	6'-0"	5'-8"	6'-8"	6'-8"	6'-8"	7'-8"
B <sup>1</sup>	3'-7"	4'-3"	4'-3"	4'-9"	5'-5"	5'-5"
C	3'-0"	—	3'-6"	3'-6"	3'-6"	4'-0"
D <sup>2</sup>	7'-8"	7'-4"	8'-4"	8'-4"	8'-4"	9'-4"
E <sup>3</sup>	6'-0"	6'-8"	6'-8"	7'-2"	7'-10"	7'-10"
F	15'-8"	15'-0"	17'-0"	17'-0"	17'-0"	19'-0"
G	—	3'-0"	3'-6"	3'-6"	3'-6"	4'-0"

<sup>1</sup> Inside dimensions    <sup>2</sup> Single car dimensions    <sup>3</sup> Add 3" when speed = 500 FPM or above  
 ▲ Add 2" when speed = 1000 FPM    ● Add 4" when speed = 1000 FPM

Hoistway dimensions are based on 1" out of plumb, no provisions for seismic conditions, and no occupied space below hoistway. If these conditions cannot be met then consideration must be given for additional required space.

MINIMUM PIT, OVERHEAD, MACHINE ROOM DIMENSIONS								
CAPACITY (IN LBS.)	DIMENSIONS	SPEED (FEET PER MINUTE)						
		200	350	450	500	700	800	1000
2000	L	16'-0"	16'-0"	16'-0"				
	O	15'-4"	15'-4"	16'-4"				
	P <sup>5</sup>	5'-0"	5'-0"	6'-6"				
2100	O	16'-0"	16'-0"	16'-0"				
	O	15'-4"	15'-4"	16'-4"				
	P <sup>5</sup>	5'-0"	5'-0"	6'-6"				
2500	L	16'-0"	16'-0"	16'-0"	16'-6"	16'-6"		
	O	15'-4"	15'-4"	16'-4"	18'-6"	20'-6"		
	P <sup>5</sup>	5'-0"	5'-0"	6'-6"	10'-1"	11'-5"		
3000	L	16'-0"	16'-0"	16'-0"	17'-0"	17'-0"	18'-0"	18'-0"
	O	15'-4"	16'-0"	16'-4"	18'-6"	20'-6"	20'-0"	20'-0"
	P <sup>5</sup>	5'-0"	5'-0"	6'-6"	10'-1"	11'-5"	11'-6"	11'-6"
3500 4000	L	16'-0"	16'-0"	16'-0"	17'-0"	17'-0"	18'-0"	18'-0"
	O	15'-4"	16'-0"	17'-6"	18'-6"	20'-6"	20'-6"	20'-6"
	P <sup>5</sup>	5'-0"	5'-0"	6'-6"	10'-1"	11'-5"	11'-6"	11'-6"

NOTE: These dimensions are for general application to custom designed elevators.  
 Overhead "O" based on 8'-0" O.A. nominal cab height.  
<sup>5</sup> Machine beams designed per ANSI/ASME code A17.1 and does not include floor weight and loads on floor.

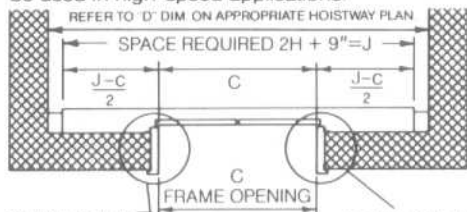


ELEVATORS

Passenger Elevator Door/Entrance Details

CENTER-OPENING DOORS

These permit quickest entry and exit, thus speeding elevator service, and provide an attractive balanced appearance both in the hallway and inside the elevator car. They should always be used in high-speed applications.

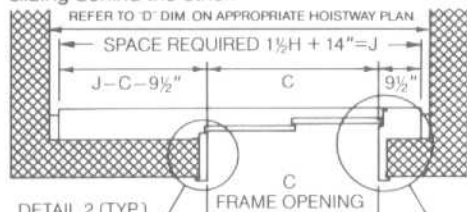


DETAIL 2 (TYP.) FRAME OPENING DETAIL 2 (TYP.)

NOTE: H=opening in 2" increments only (use next higher even dimension for odd size door). C=actual frame opening

TWO-SPEED SLIDING DOORS

Doors of this type provide the widest possible opening width for small cars but do not afford the entry and exit speed of center-opening doors. The two doors move in the same direction, one sliding behind the other.

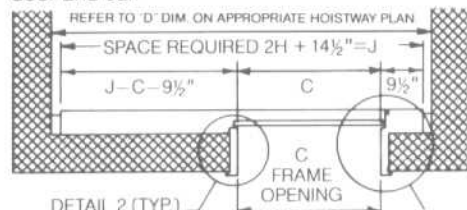


DETAIL 2 (TYP.) FRAME OPENING DETAIL 3 (TYP.)

Right hand entrance shown. Left hand available where required. NOTE: H=opening in 2" increments only (use next higher even dimension for odd size door). C=actual frame opening

SINGLE SLIDING DOORS

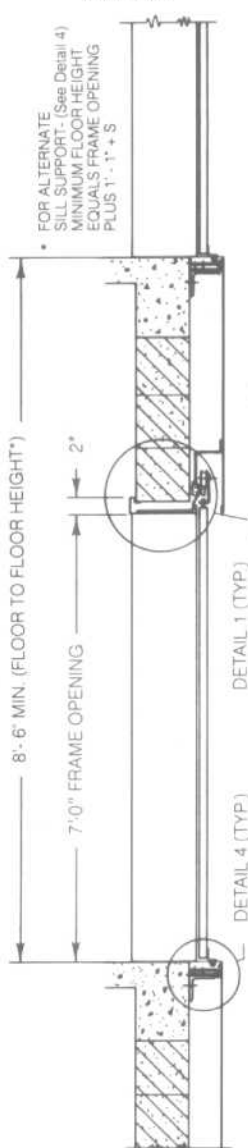
This is the most economical type of elevator door, and also the slowest. The single door moves either to right or left from one side of the elevator car, the opening being limited by the width of the door and car.



DETAIL 2 (TYP.) FRAME OPENING DETAIL 3 (TYP.)

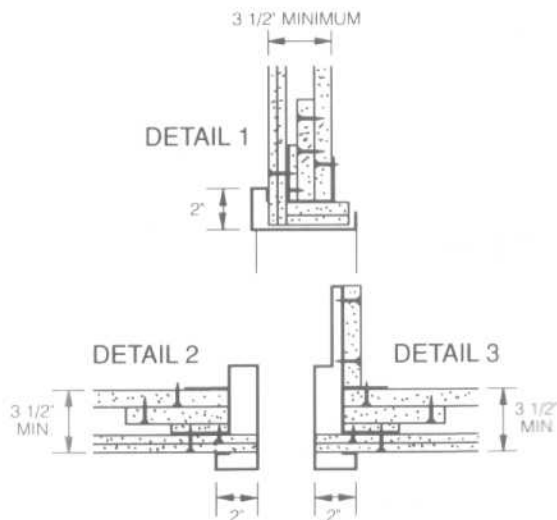
Right hand entrance shown. Left hand available where required. NOTE: H=opening in 2" increments only (use next higher even dimension for odd size door). C=actual frame opening

VERTICAL SECTION (TYPICAL)



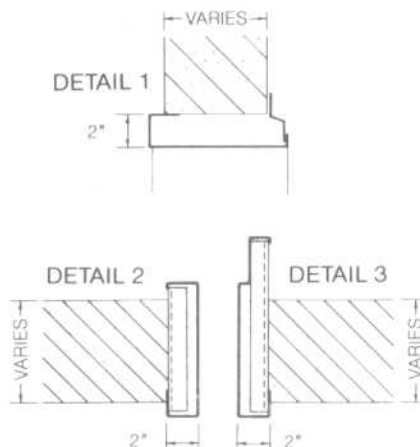
FOR ALTERNATE SILL SUPPORT - (See Detail 4) MINIMUM FLOOR HEIGHT EQUALS FRAME OPENING PLUS 1'-1" + S

DRYWALL CONSTRUCTION

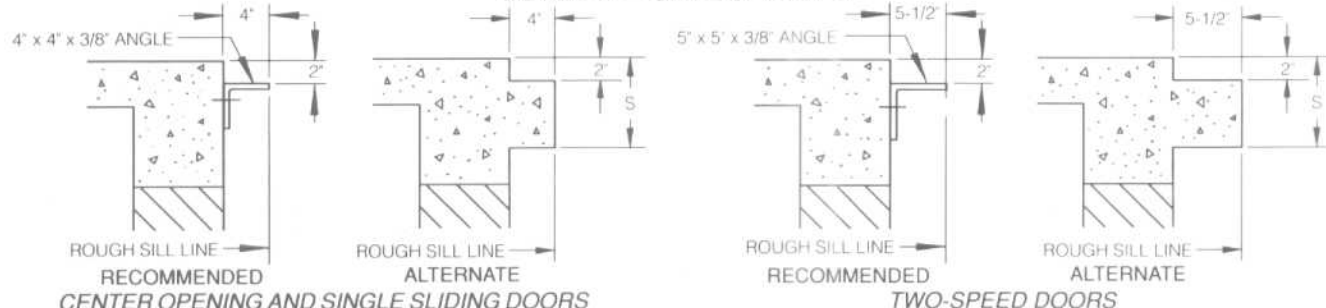


NOTE: These diagrams show minimum wall thickness and construction detail required in order to supply UL Label on entrances with no cutouts.

MASONRY CONSTRUCTION



DETAIL 4 — SILL SUPPORTS



RECOMMENDED ALTERNATE CENTER OPENING AND SINGLE SLIDING DOORS

RECOMMENDED ALTERNATE TWO-SPEED DOORS

**Floor plan of elevator cars** The floor area of elevator cars shall provide space for wheelchair users to enter the car, maneuver within reach of controls, and exit from the car. Acceptable door opening and inside dimensions shall be as shown in Fig. 1. The clearance between the car platform sill and the edge of any hoistway landing shall be no greater than 1/4 in (32 mm).

**Illumination levels** The level of illumination at the car controls, platform, and car threshold and landing sill shall be at least 5 footcandles (53.8 lux).

**Car controls** Elevator control panels shall have the following features:

1. Buttons. All control buttons shall be at least 3/4 in (19 mm) in their smallest dimension. They may be *raised* or flush.

2. Tactile and visual control indicators. All control buttons shall be designated by *raised* standard alphabet characters for letters, arabic characters for numerals, or standard symbols as shown in Fig. 3(a), and as required in ANSI A17.1-1978 and A17.1a-1979. The call button for the main entry floor shall be designated by a *raised* star at the left of the floor designation [see Fig. 3(a)]. All *raised*

designations for control buttons shall be placed immediately to the left of the button to which they apply. Applied plates, permanently attached, are an acceptable means to provide *raised* control designations. Floor buttons shall be provided with visual indicators to show when each call is registered. The visual indicators shall be extinguished when each call is answered.

3. Height. All floor buttons shall be no higher than 48 in (1220 mm), unless there is a substantial increase in cost, in which case the maximum mounting height may be increased to 54 in (1370 mm), above the floor. Emergency controls, including the emergency alarm and emergency stop, shall be grouped at the bottom of the panel and shall have their centerlines no less than 35 in (890 mm) above the floor [see Fig. 3(a) and (b)].

4. Location. Controls shall be located on a front wall if cars have center opening doors, and at the side wall or at the front wall next to the door if cars have side opening doors [see Fig. 3(c) and (d)].

**Car position indicators** In elevator cars, a visual car position indicator shall be provided above the car control panel or over the door

to show the position of the elevator in the hoistway. As the car passes or stops at a floor served by the elevators, the corresponding numerals shall illuminate, and an audible signal shall sound. Numerals shall be a minimum of 1/2 in (13 mm) high. The audible signal shall be no less than 20 decibels with a frequency no higher than 1500 Hz. An automatic verbal announcement of the floor number at which a car stops or which a car passes may be substituted for the audible signal.

**Emergency communications** If provided, emergency two-way communication systems between the elevator and a point outside the hoistway shall comply with ANSI A17.1-1978 and A17.1a-1979. The highest operable part of a two-way communication system shall be a maximum of 48 in (1220 mm) from the floor of the car. It shall be identified by a raised or recessed symbol and located adjacent to the device. If the system uses a handset, then the length of the cord from the panel to the handset shall be at least 29 in (735 mm). The emergency intercommunication system shall not require voice communication.

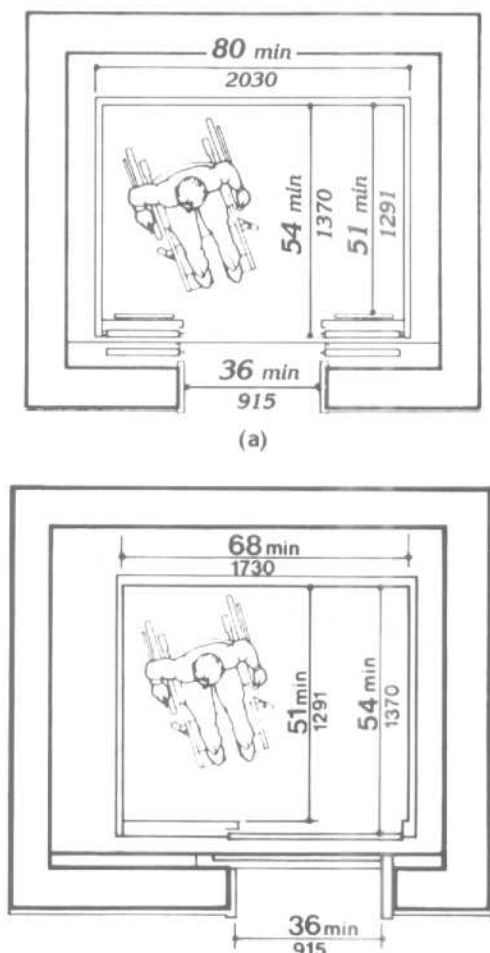
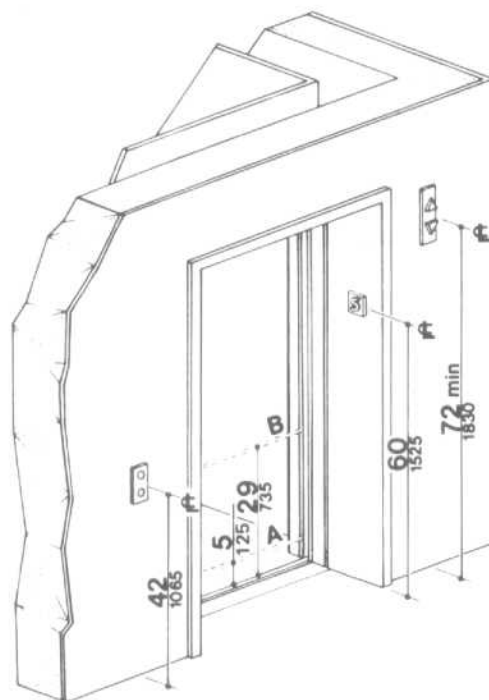


Fig. 1 Minimum dimensions of elevator cars.



NOTE: The automatic door reopening device is activated if an object passes through either line A or line B. Line A and line B represent the vertical locations of the door reopening device not requiring contact.

Fig. 2 Hoistway and elevator entrances.

ELEVATORS

Barrier-Free Considerations

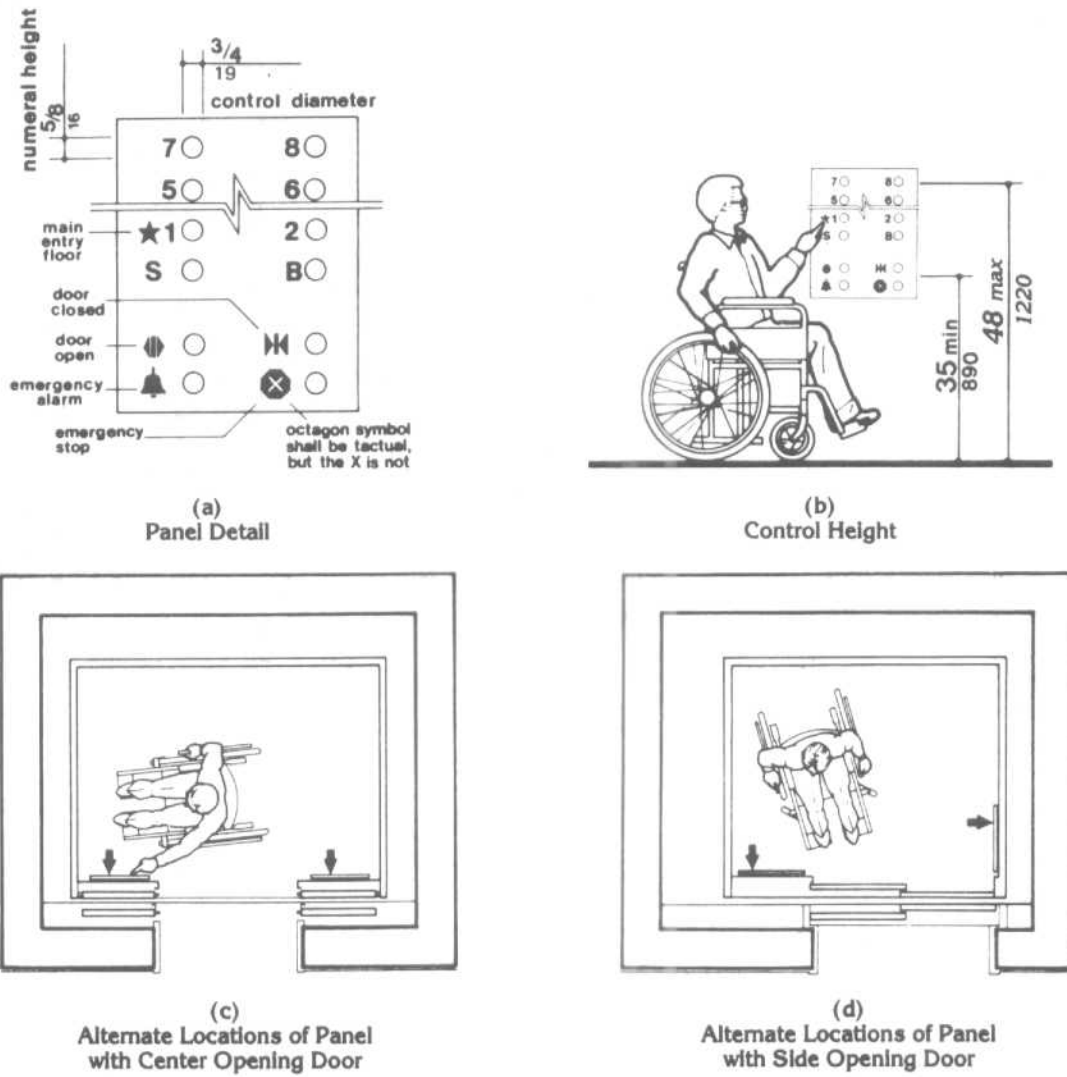
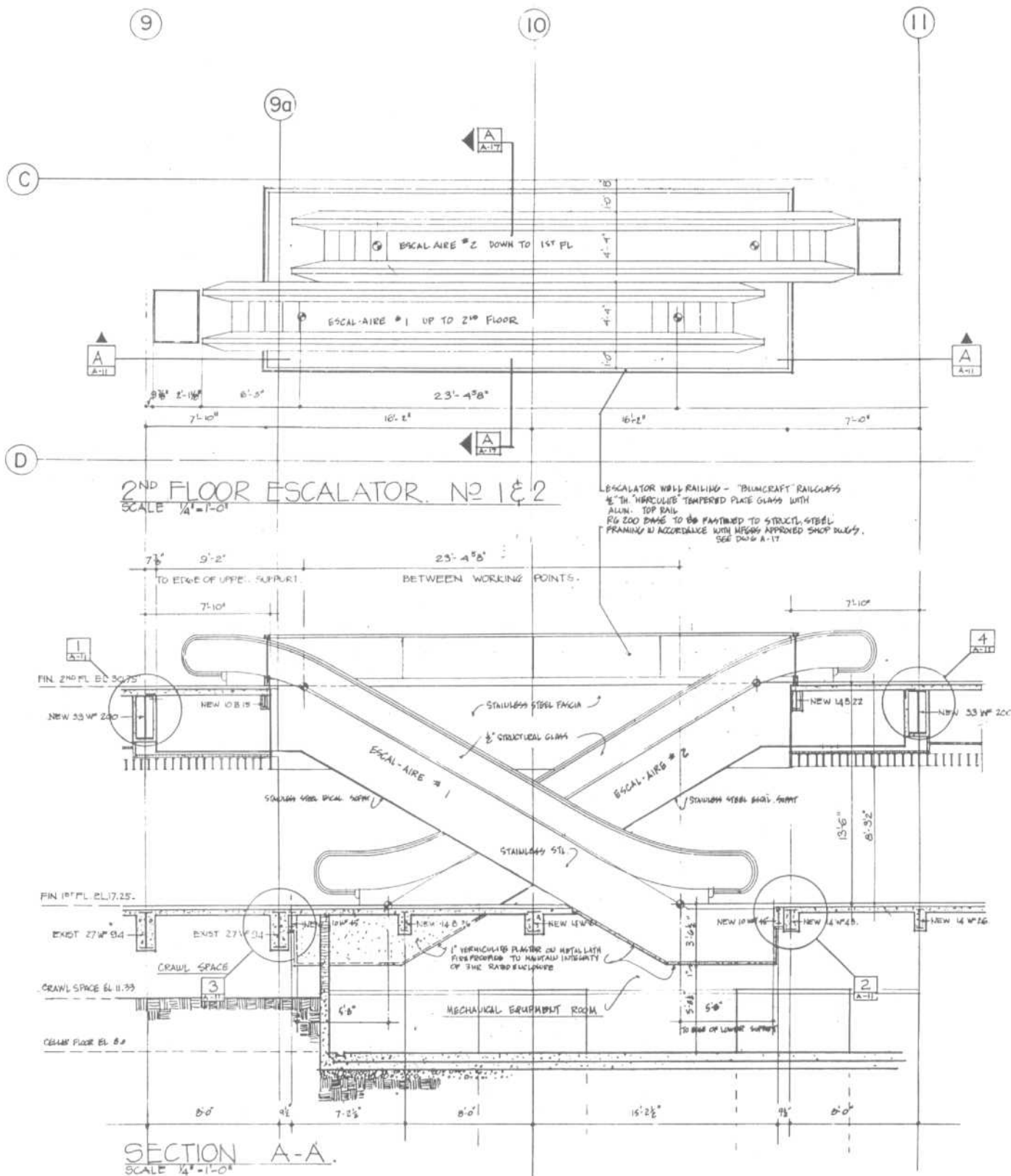


Fig. 3 Car controls.



ELEVATORS

Wheelchair Lifts

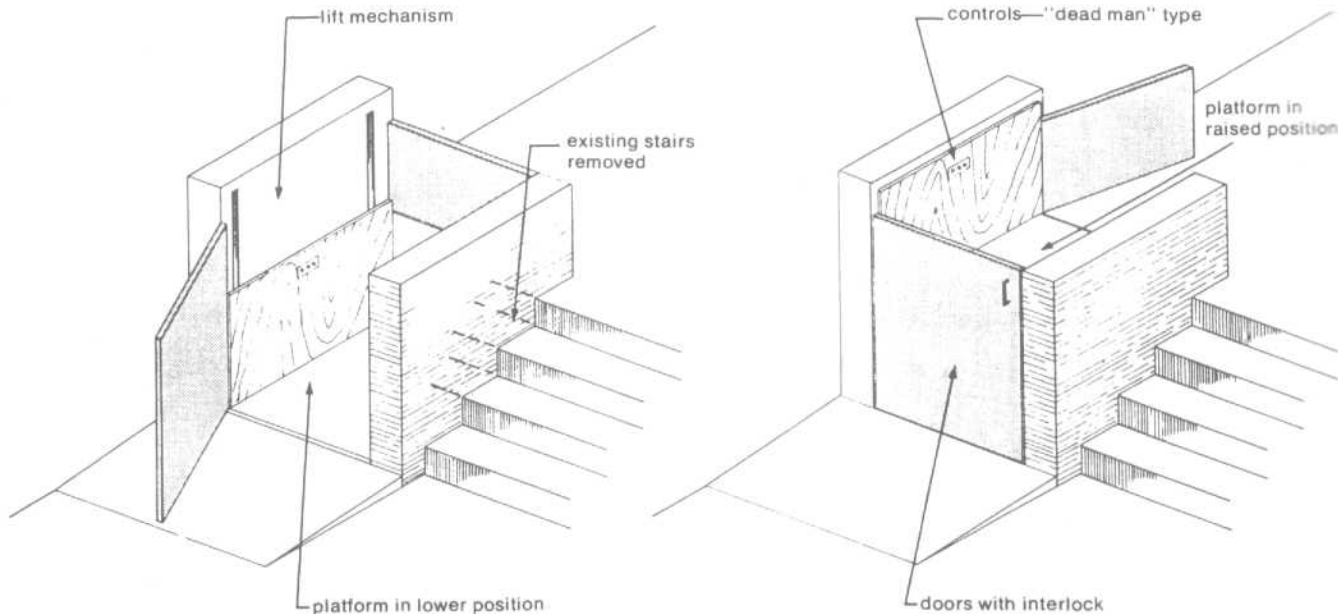
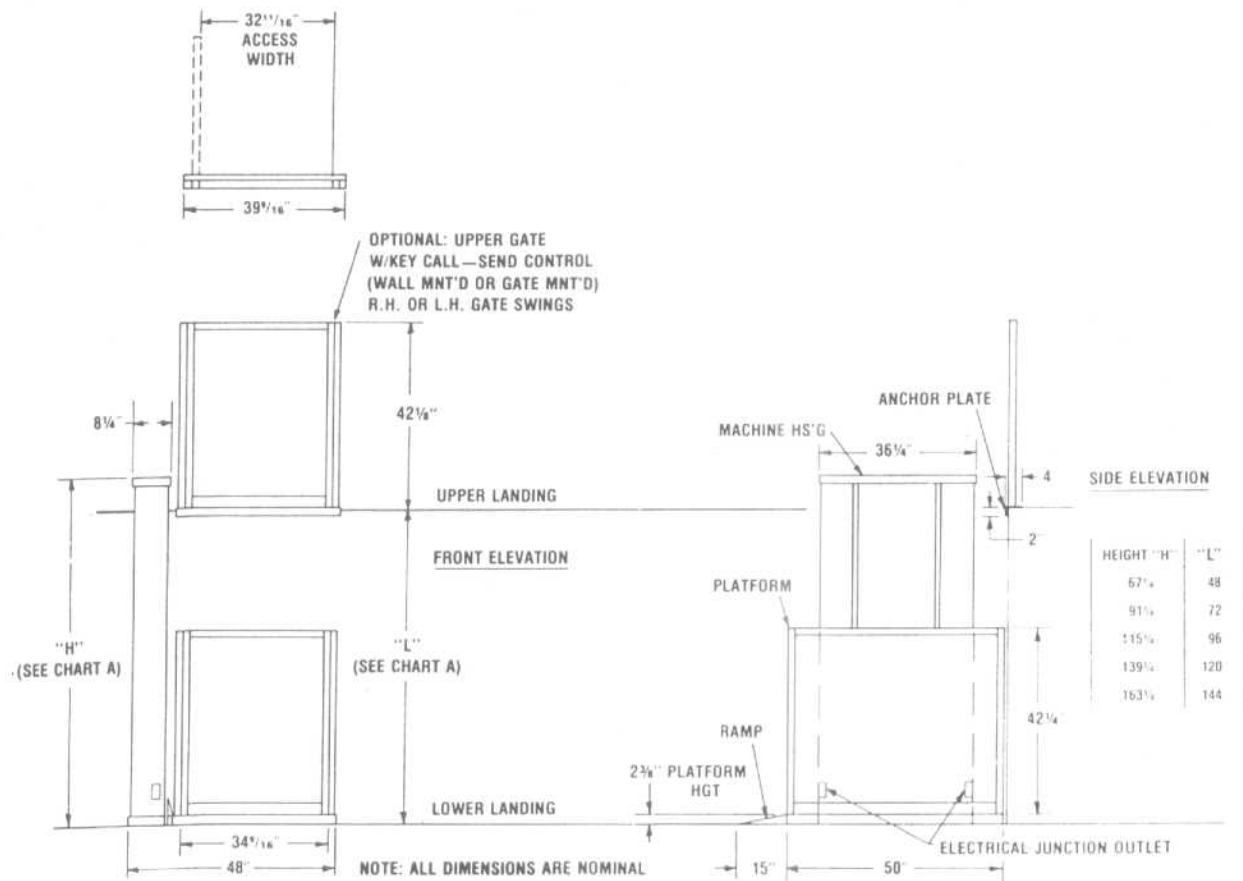


Fig. 4 Wheelchair lift. In certain installations where ramps may be impossible due to space limitations, small mechanical wheelchair lifts can be installed to overcome level changes. Manufactured lifts have a lift range from two to several feet and are either electro-mechanical, hydraulic, or pneumatically operated. Lifts can be semi-enclosed and equipped with entrance interlocks for safety, and either key-operated for limited use or button-type. "Dead-man" controls are recommended for safety.





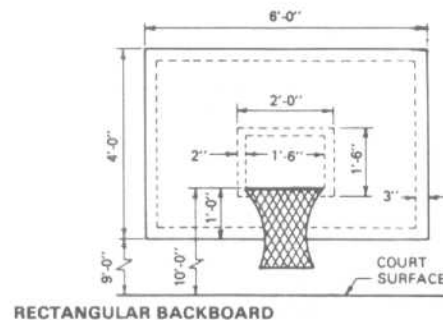
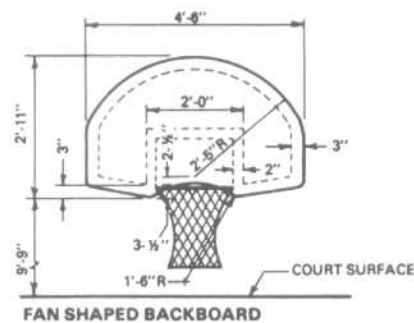
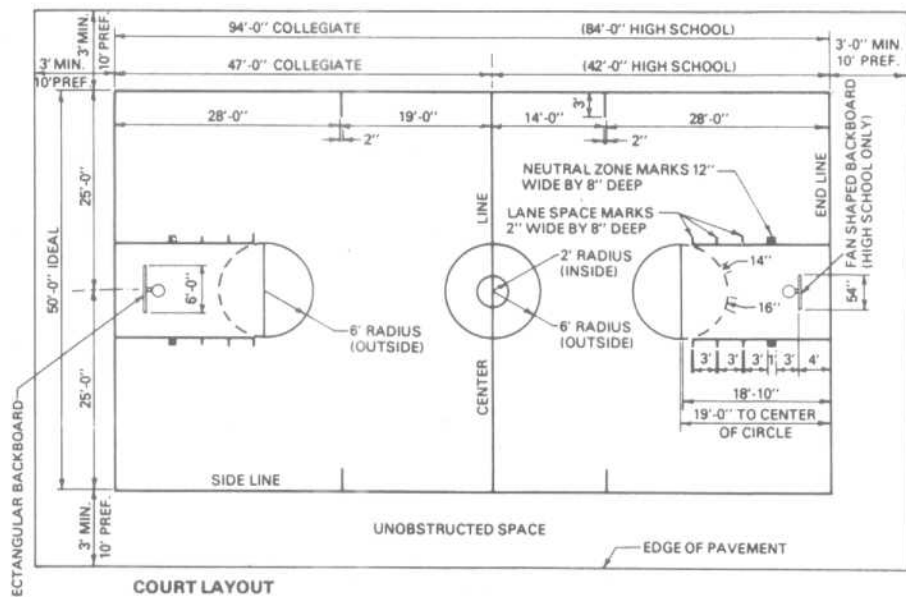


Fig. 1 NCAA basketball. The color of the lane space marks and neutral zone marks shall contrast with the color of the bounding lines. The midcourt marks shall be the same color as the bounding lines. All lines shall be 2 in wide (neutral zone excluded). All dimensions are to inside edge of lines except as noted. Backboard shall be of any rigid weather-resistant material. The front surface shall be flat and painted white unless it is transparent. If the backboard is transparent, it shall be marked with a 3-in wide white line around the border and an 18 x 24-in target area bounded with a 2-in wide white line. [High school recommended court is 84 x 50 ft with a 10-ft unobstructed space on all sides (3 ft minimum). Collegiate recommended court is 94 x 50 ft with a 10-ft unobstructed space on all sides (3 ft minimum).]

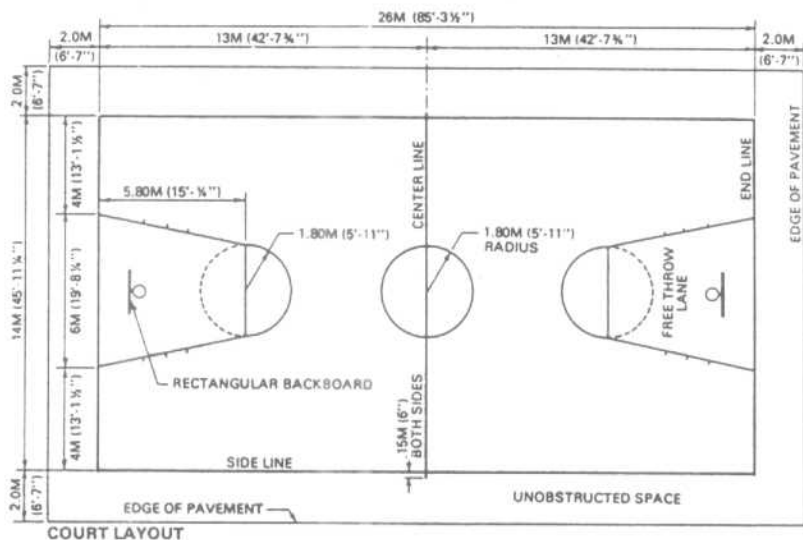
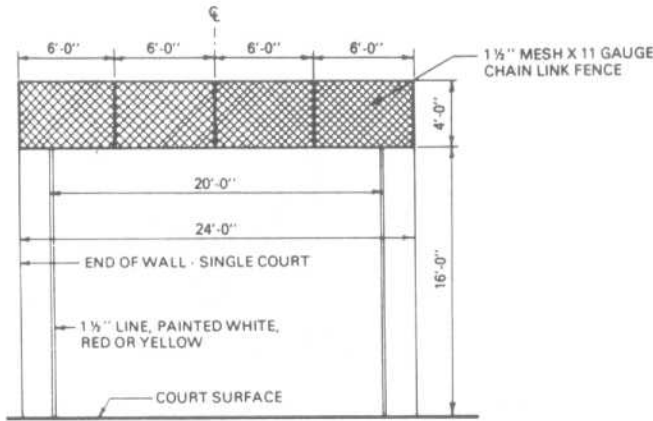


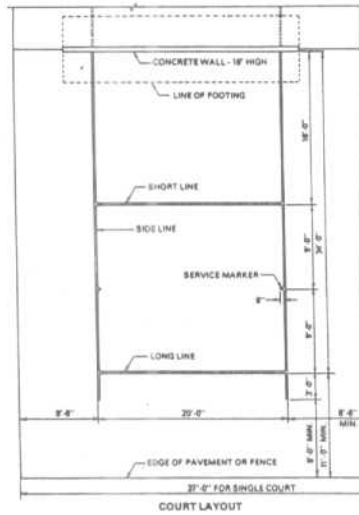
Fig. 2 AAU basketball court. All dimensions are to inside edge of lines except as noted. All lines to be .05 m (2") wide. Backboard shall be of any rigid weather-resistant material. The front shall be flat and painted white unless it is transparent. If the backboard is transparent, it shall be marked with a .05-m-wide white line around the border and a .45 x .59-m target area bounded with a .05-m-wide white line.

INDOOR RECREATION

One-, Three-, and Four-Wall Handball



ELEVATION



COURT LAYOUT

Fig. 3 One-wall handball. Playing court is 20'0" wide by 34'0" long plus a required 11'0" minimum width of surfaced area to the rear and a recommended 8'6" minimum width on each side. Courts in battery are to be a minimum of 6'0" between courts. Court markings: 1/2-in-wide lines painted white, red, or yellow.

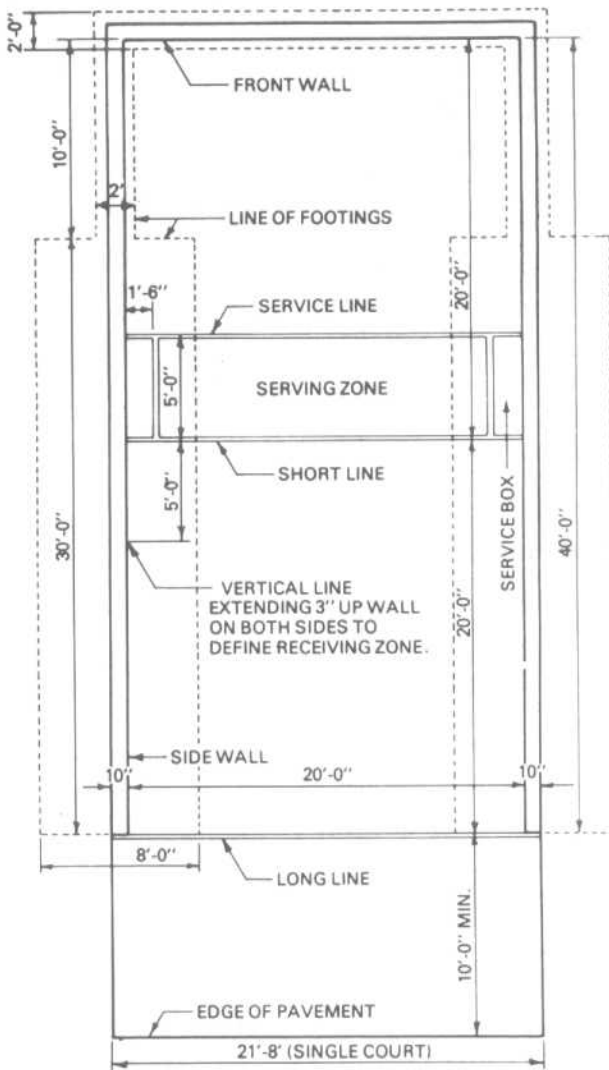


Fig. 4 Handball court layout - four-wall. All court markings to be 1/2 in wide and painted white, red, or yellow.

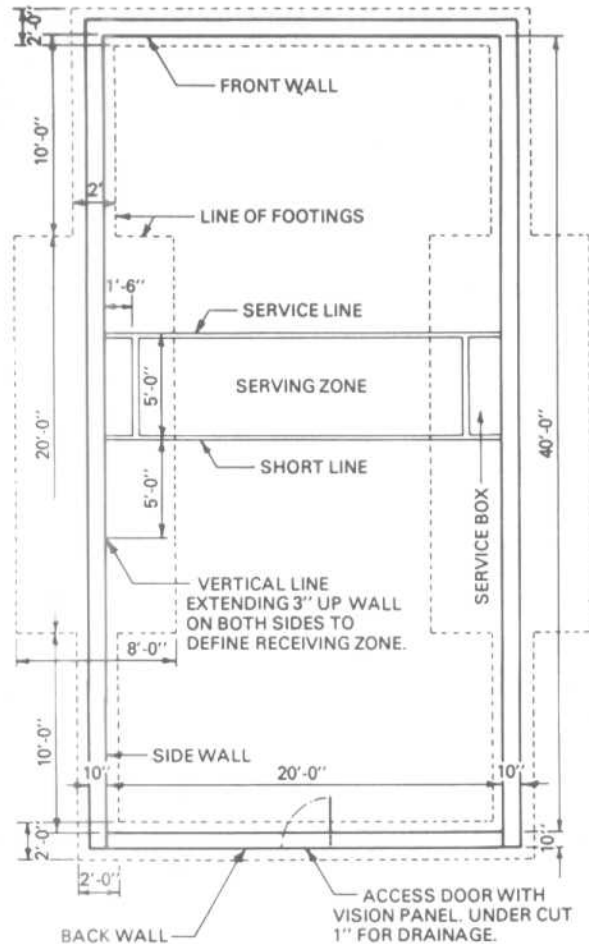


Fig. 5 Handball court layout - three-wall. All court markings to be 1/2 in wide and painted white, red, or yellow. Playing court is 20'0" wide by 40'0" long plus a minimum 10'0" to the rear of the three-wall court. Overhead clearance required is 20'0" minimum.

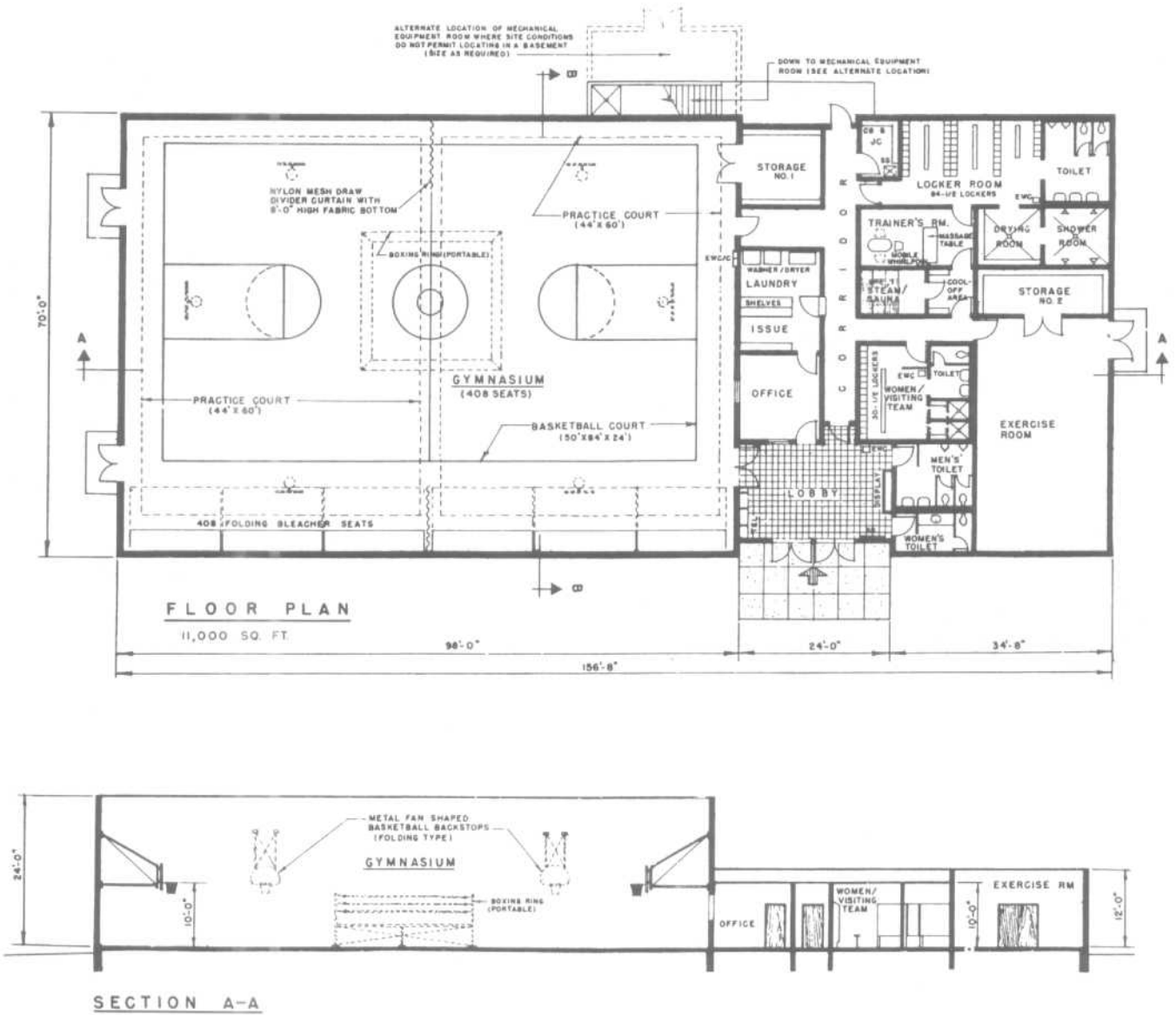


Fig. 6 Gymnasium plan and section.

INDOOR RECREATION

Tennis and Paddle Tennis

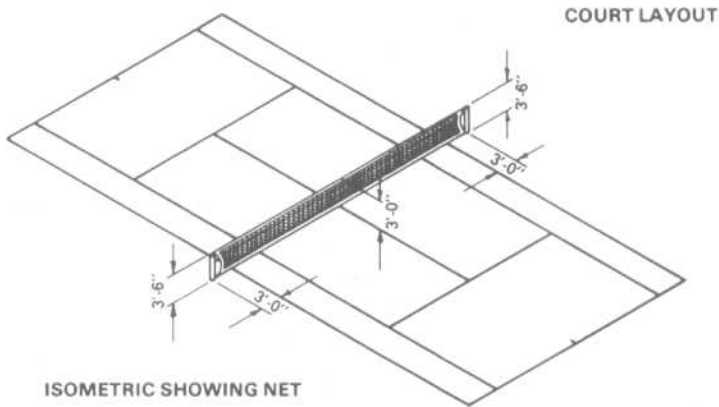


Fig. 7 Tennis court. All measurements for court markings are to the outside of lines except for those involving the center service line which is equally divided between the right and left service courts. All court markings to be 2 in wide.

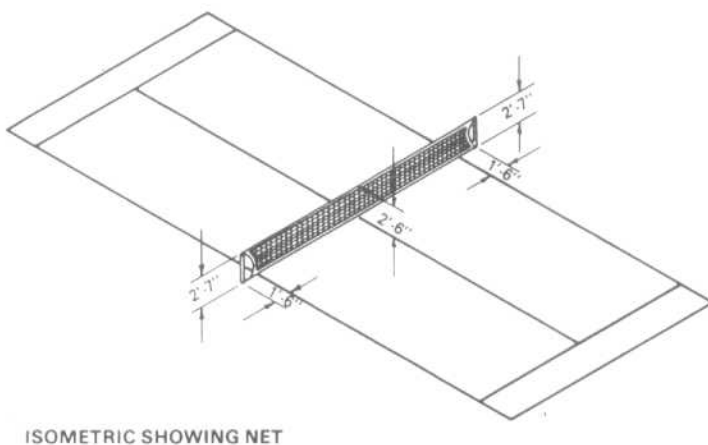
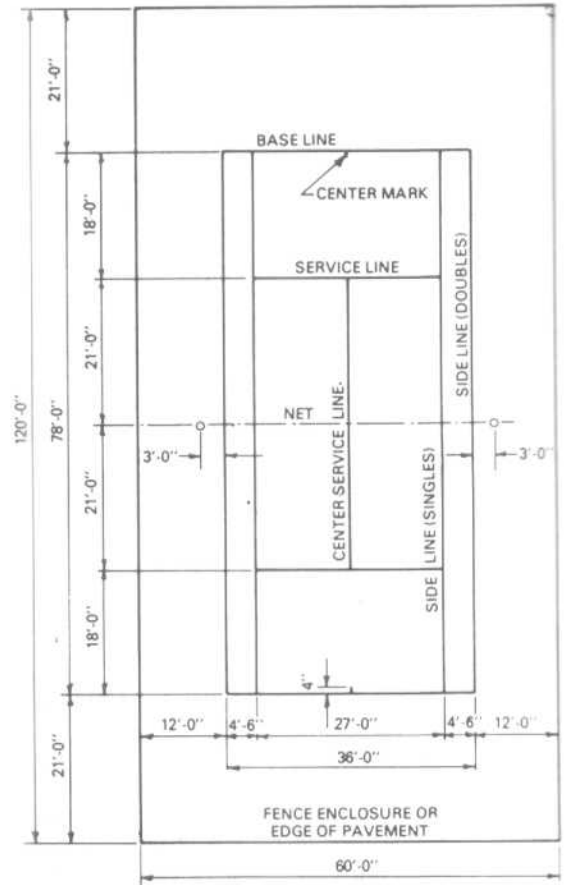
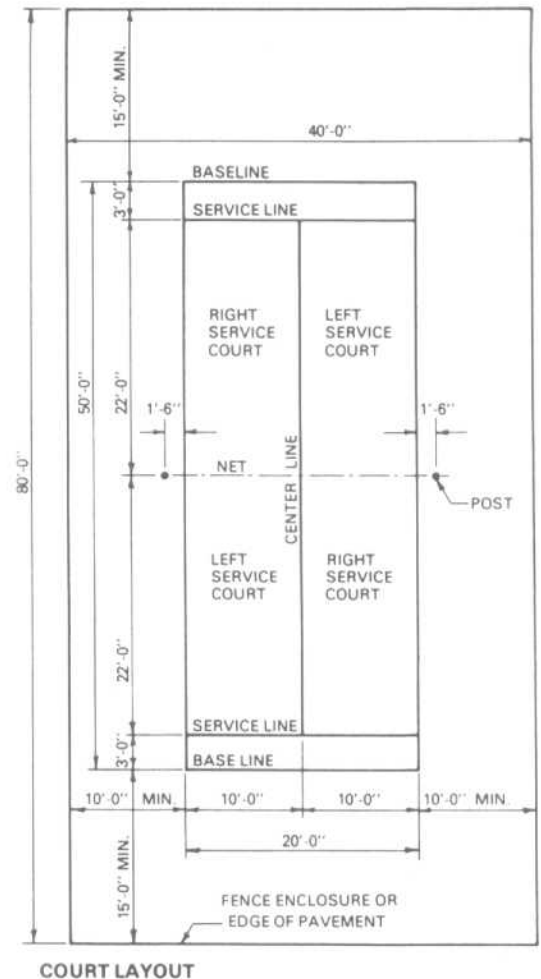
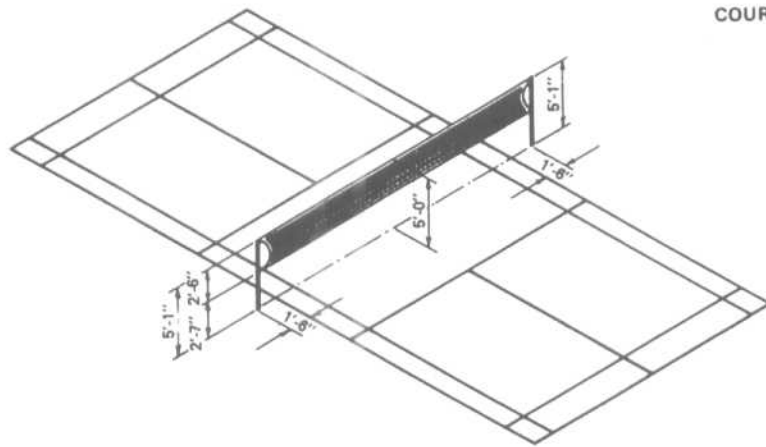


Fig. 8 Paddle tennis court. All measurements for court markings are to the outside of lines except for those involving the center service line, which is equally divided between right and left service court. All court markings to be 1½ in wide.



INDOOR RECREATION

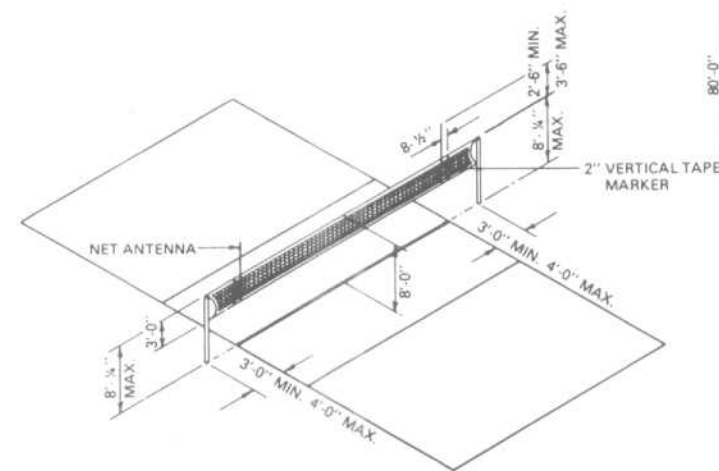
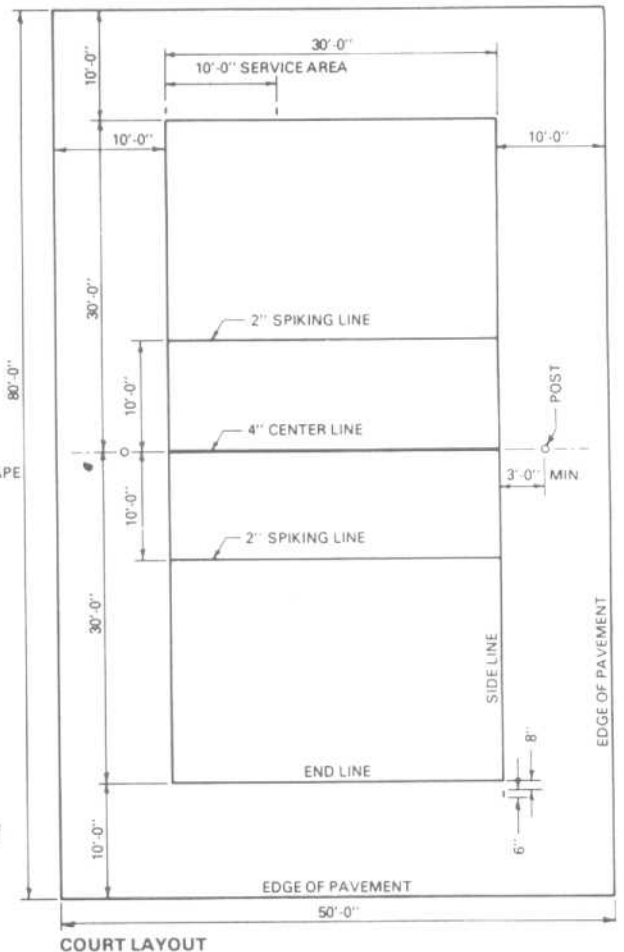
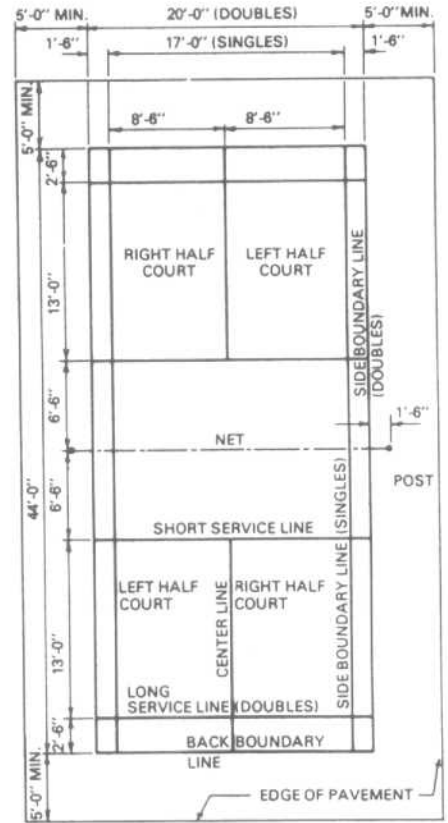
Badminton and Volleyball



ISOMETRIC SHOWING NET

Fig. 9 Badminton court. All measurements for court markings are to the outside of lines except for those involving the center service line which is equally divided between right and left service courts. All court markings to be 1½" wide and preferably white or in color. Minimum distance between sides of parallel courts to be 5' 0".

COURT LAYOUT



ISOMETRIC SHOWING NET

Fig. 10 Volleyball court. All measurements for court markings are to the outside of lines except for the centerline. All court markings to be 2 in wide except as noted.

INDOOR RECREATION

Shuffleboard

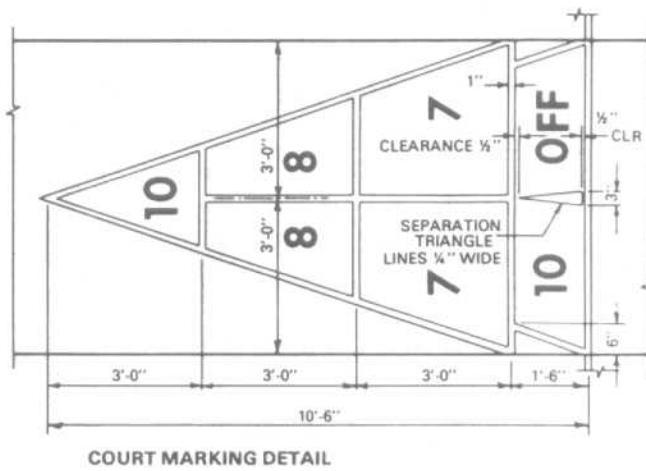
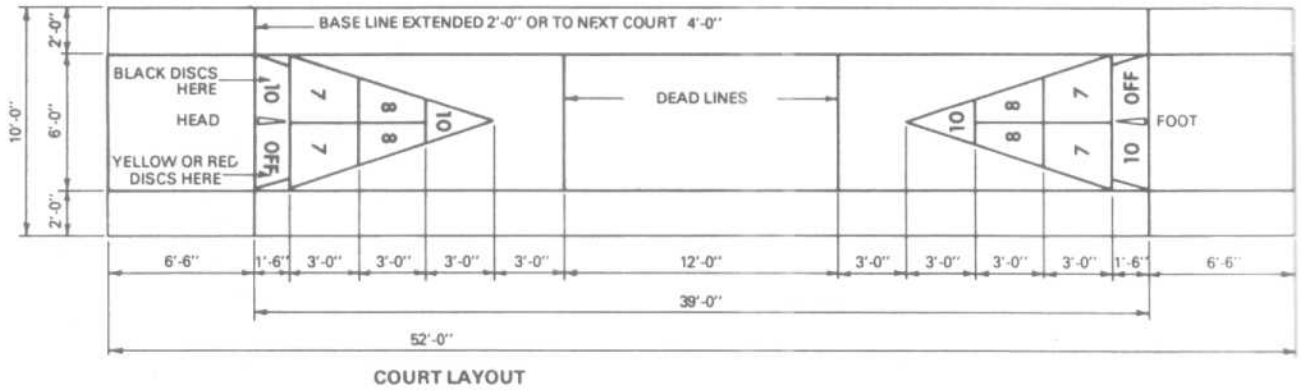
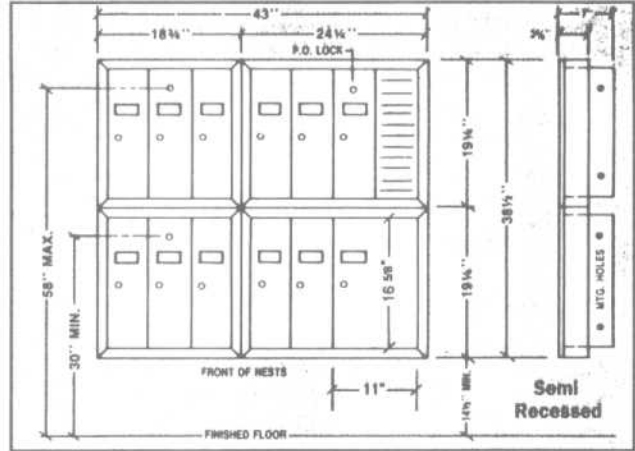
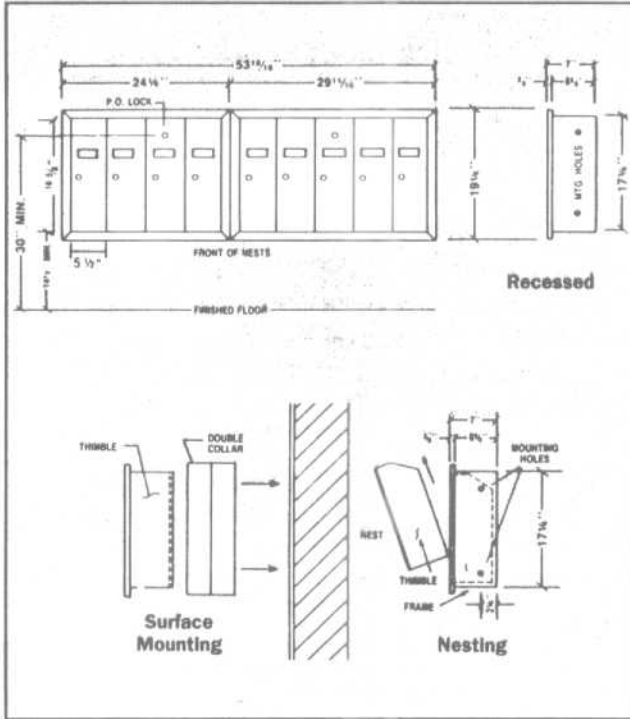


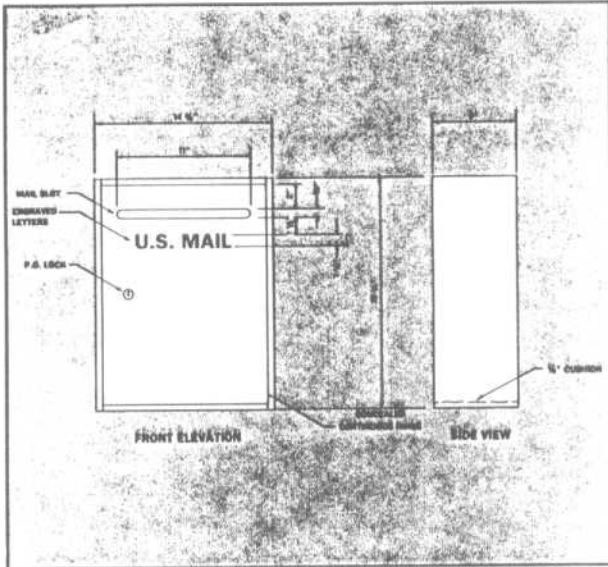
Fig. 11 Shuffleboard court. All dimensions are to centers of lines and to edge of court. Maximum line width 1½ in, minimum ¼ in. Playing court is 6'0" x 52'0" plus a recommended minimum of 2'0" on each side or 4'0" between courts in battery.



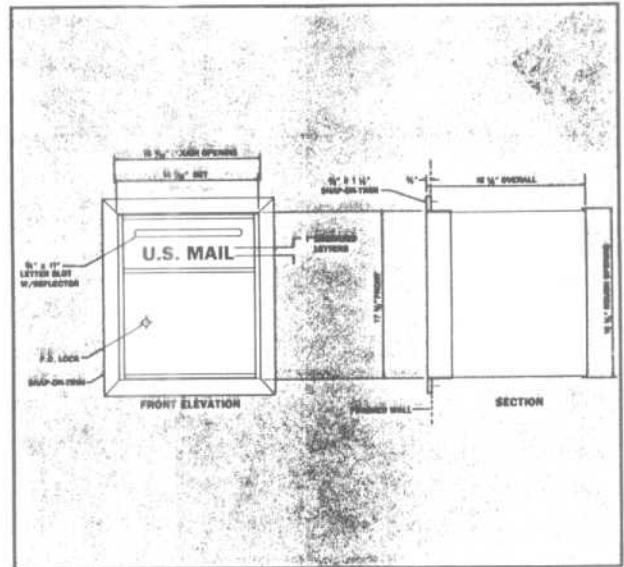
NO. OF OPENINGS		FOR 3-4 & 5 WIDE NESTS		All dimensions in inches.		
SINGLE	DOUBLE	SUGGESTED ARRANGEMENT	ROUGH OPENING	CABINET	NET OVERALL WIDTH	
3	6	3	17 3/4	16 3/4	18 3/4	
4	8	4	23 1/4	22 1/4	24 1/4	
5	10	5	28 1 1/8	27 1 1/8	29 1 1/8	
6	12	3-3	36 1/2	35 1/2	37 1/2	
7	14	3-4	42	41	43	
8	16	4-4	47 1/2	46 1/2	48 1/2	
9	18	4-5	52 1 5/16	51 1 5/16	53 1 5/16	
10	20	5-5	58 3/8	57 3/8	59 3/8	
11	22	4-3-4	66 1/4	65 1/4	67 1/4	
12	24	4-4-4	71 3/4	70 3/4	72 3/4	
13	26	4-5-4	77 3/8	76 3/8	78 3/8	
14	28	5-4-5	82 3/8	81 3/8	83 3/8	
15	30	5-5-5	88 1 1/8	87 1 1/8	89 1 1/8	
16	32	4-4-4-4	96	95	97	
17	34	5-4-4-4	101 1 1/8	100 1 1/8	102 1 1/8	
18	36	5-4-4-5	106 7/8	105 7/8	107 7/8	
19	38	5-4-5-5	112 5/16	111 5/16	113 5/16	
20	40	5-5-5-5	117 3/4	116 3/4	118 3/4	
21	42	4-4-5-4-4	125 1 1/8	124 1 1/8	126 1 1/8	
22	44	5-4-4-4-5	131 1/2	130 1/2	132 1/2	
23	46	5-5-3-5-5	138 1/2	135 1/2	137 1/2	
24	48	5-5-4-5-5	142	141	143	
25	50	5-5-5-5-5	147 1 1/8	146 1 1/8	148 1 1/8	
26	52	5-4-4-4-5	155 3/8	154 3/8	156 3/8	
27	54	5-4-5-4-5-4	160 3 1/8	159 3 1/8	161 3 1/8	
28	56	5-5-4-4-5-5	166 1/4	165 1/4	167 1/4	
29	58	5-5-4-5-5-5	171 1 1/8	170 1 1/8	172 1 1/8	
30	60	5-5-5-5-5-5	177 1/2	176 1/2	178 1/2	
31	62	5-4-5-4-4-5	185 1 1/8	184 1 1/8	186 1 1/8	
32	64	5-5-4-4-4-5-5	190 1/2	189 1/2	191 1/2	
33	66	5-5-4-5-4-5-5	195 1 5/16	194 1 5/16	196 1 5/16	
34	68	5-5-5-4-5-5-5	201 3/8	200 3/8	202 3/8	
35	70	5-5-5-5-5-5-5	206 1 3/16	205 1 3/16	207 1 3/16	
36	72	5-5-4-4-4-4-5-5	214 3/4	213 3/4	215 3/4	
37	74	5-5-5-4-4-4-5-5	220 3 1/8	219 3 1/8	221 3 1/8	
38	76	5-5-5-4-4-5-5-5	225 3/8	224 3/8	226 3/8	
39	78	5-5-5-5-4-5-5-5	231 1 1/8	230 1 1/8	232 1 1/8	
40	80	5-5-5-5-5-5-5-5	236 1/2	235 1/2	237 1/2	
41	82	4-4-5-5-5-5-4-4	244 1 1/8	243 1 1/8	245 1 1/8	
42	84	5-5-5-4-4-4-5-5-5	249 3/8	248 3/8	250 3/8	
43	86	5-5-5-5-3-5-5-5-5	255 1/4	254 1/4	256 1/4	
44	88	5-5-5-5-4-5-5-5-5	260 3/4	259 3/4	261 3/4	
45	90	5-5-5-5-5-5-5-5-5	266 1 1/8	265 1 1/8	267 1 1/8	

ACCESSORIES

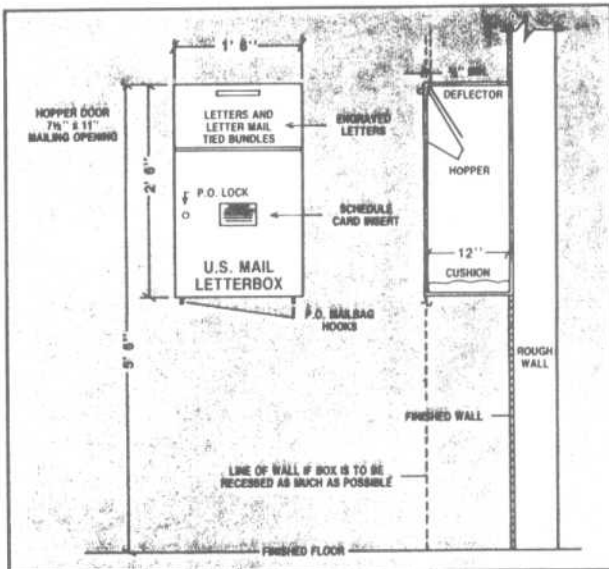
Mail Collection Boxes



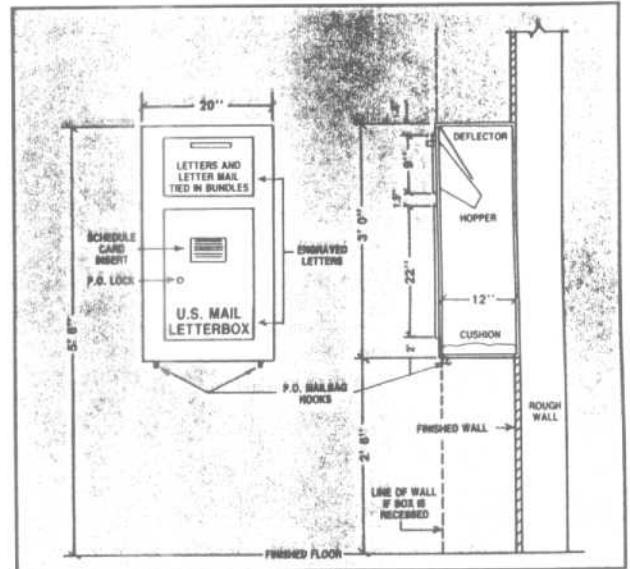
19 1/4" H x 14 3/8" W x 6" D



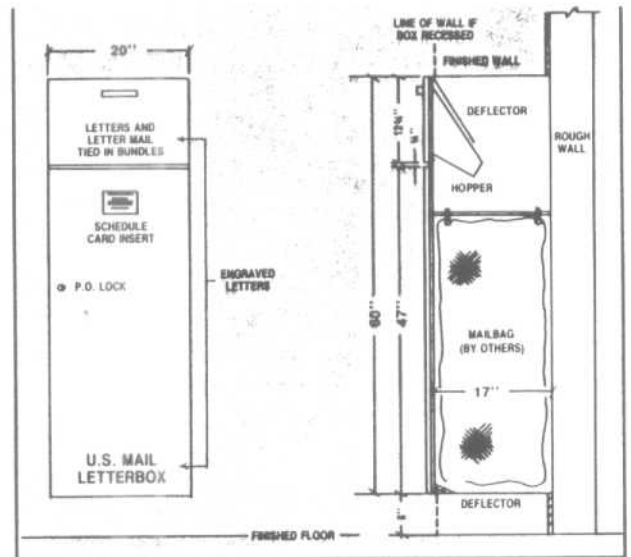
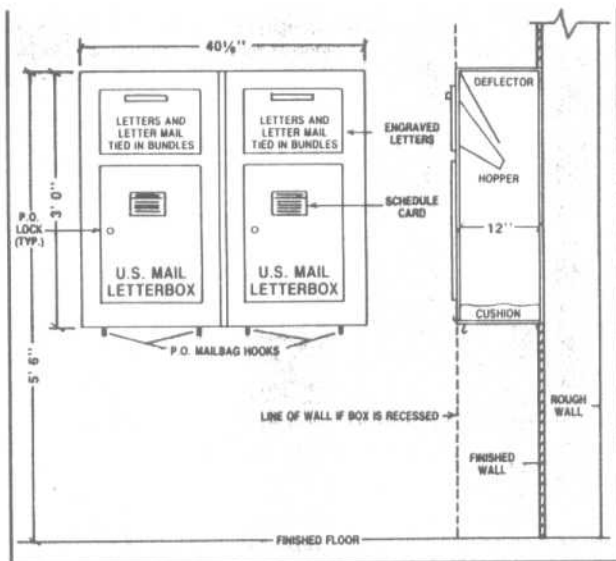
17 1/8" H x 14 1/16" W x 16 1/8" D



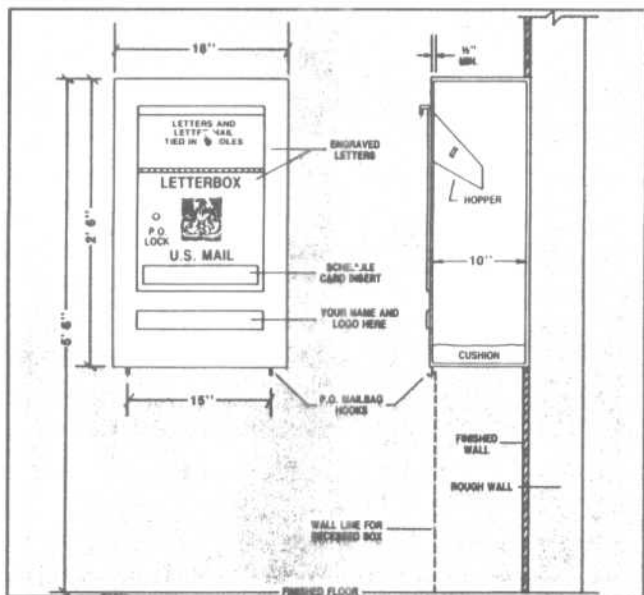
30" H x 18" W x 12" D



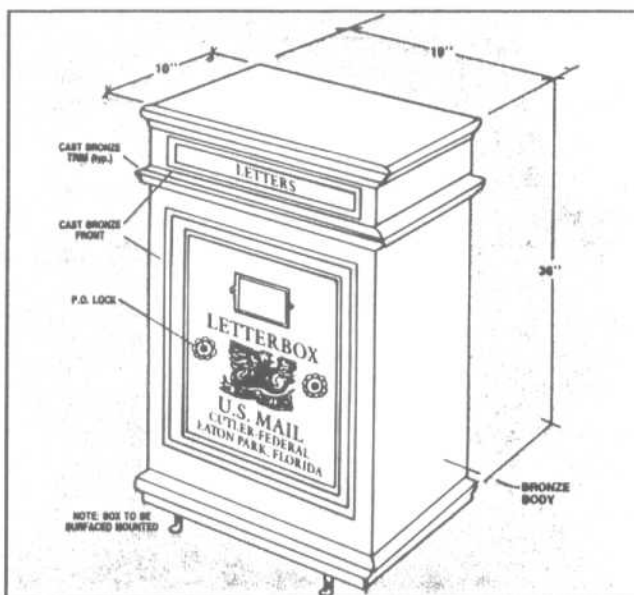
36" H x 20" W x 12" D



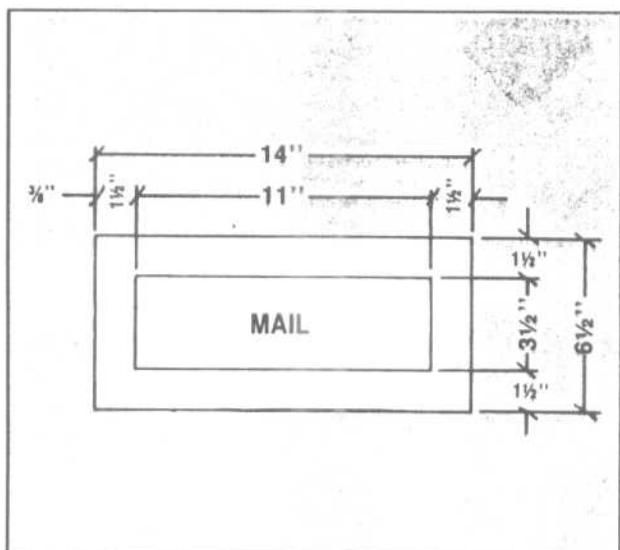




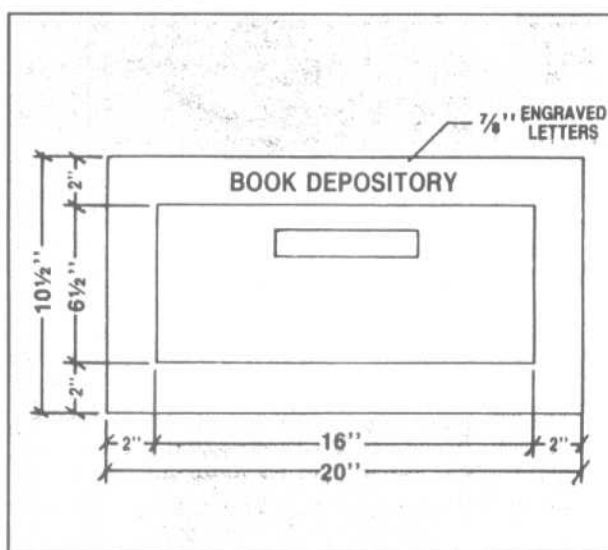
**Contemporary**  
30" H x 18" W x 10" D



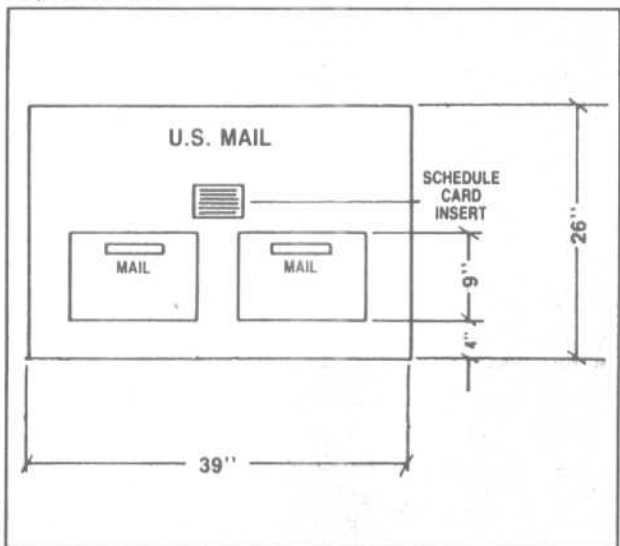
**Classic Bronze**  
36" H x 19" W x 10" D



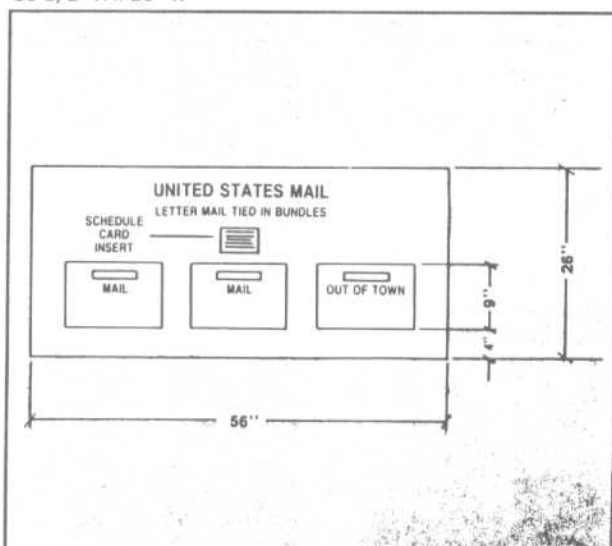
**Letterslot**  
6 1/2" H x 14" W



**Book Depository**  
10 1/2" H x 20" W



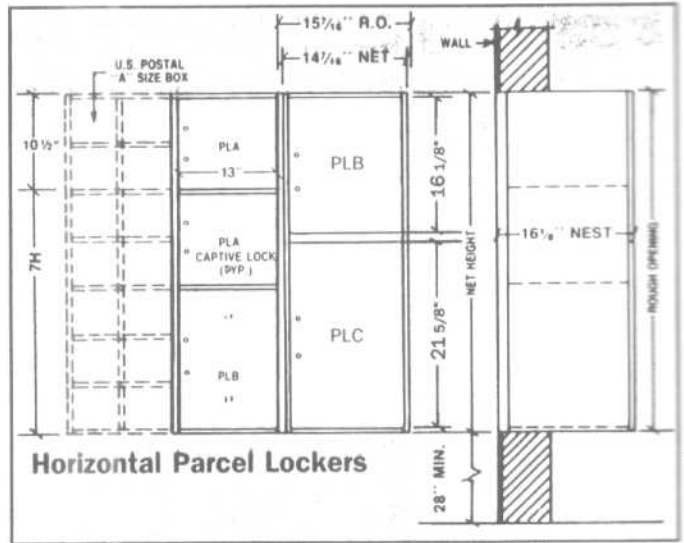
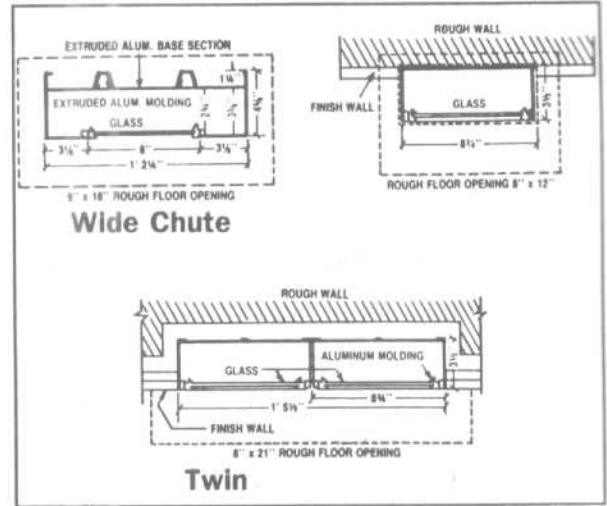
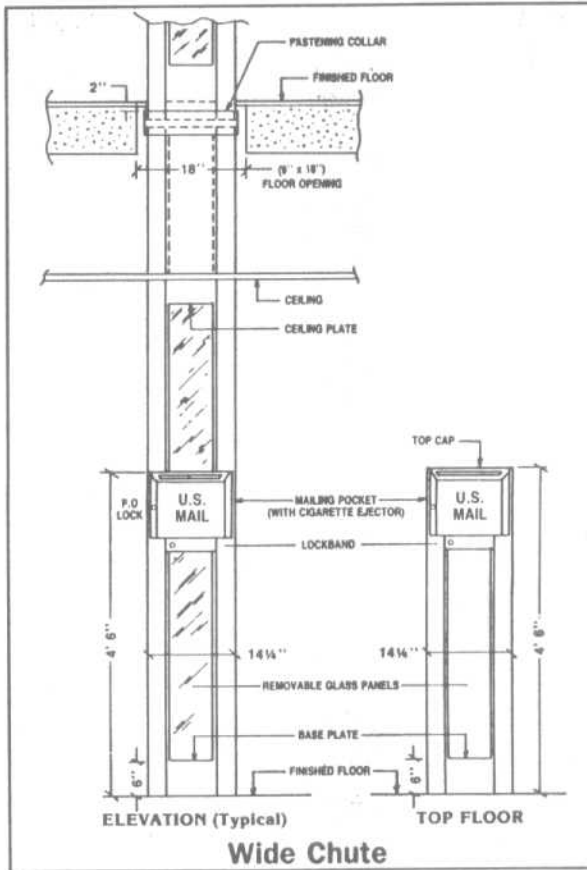
**Plate Front**  
26" H x 39" W



**Plate Front**  
26" H x 56" W

ACCESSORIES

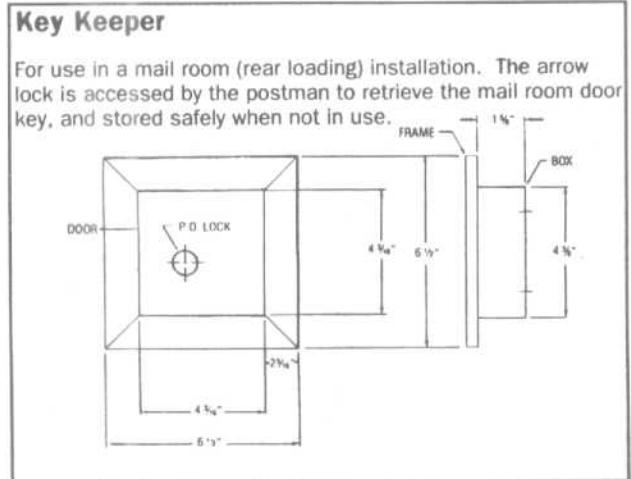
Mail Chutes, Parcel Lockers, and Key Cabinets

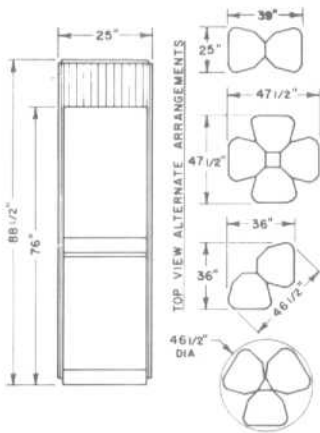


### Key Storage Cabinet

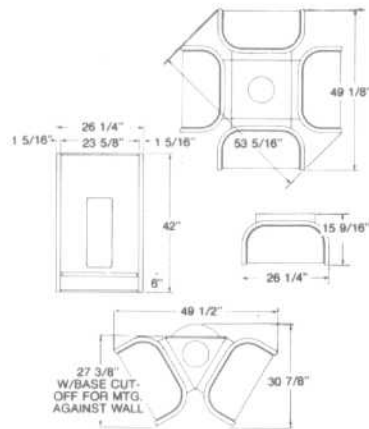
The safest way to keep keys stored in one central secure location. Available in four different sizes, holding from 32 to 128 keys.

- 235  
415 ← Holds 32 Keys  
9 1/4" H x 13 5/8" W
- Holds 64 Keys  
16 5/16" H x 13 5/8" W
- Holds 96 Keys  
23 1/4" H x 13 5/8" W  
590 X 345
- Holds 128 Keys  
30 1/4" H x 13 5/8" W  
760 X 345

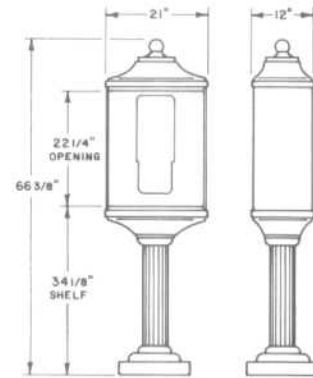




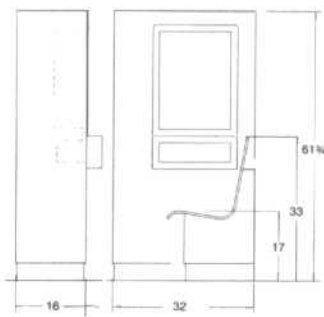
**Cluster**



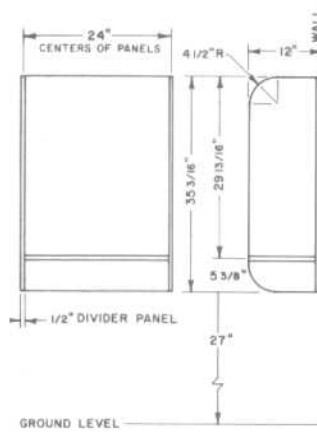
**Cluster**



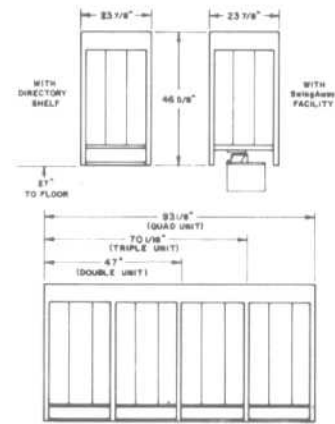
**Free-standing**



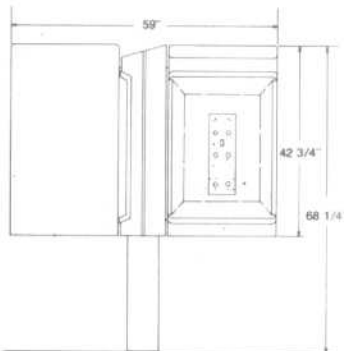
**Free-standing**



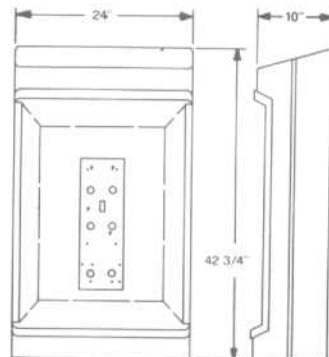
**Wall-mounted**



**Wall-mounted**



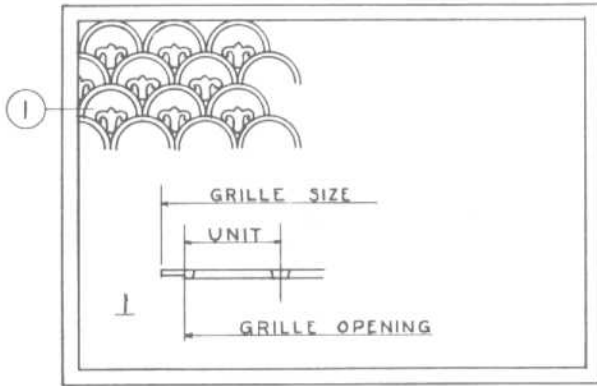
**Free-standing**



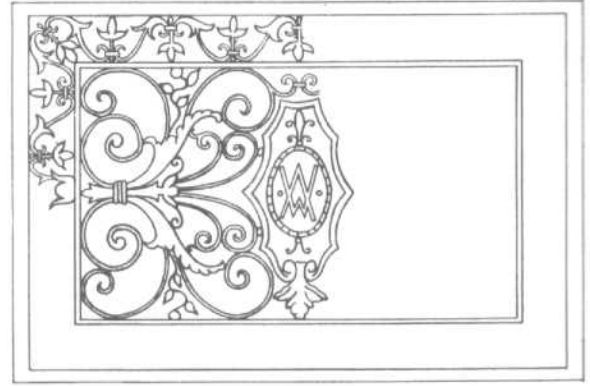
**Wall-mounted**

ACCESSORIES

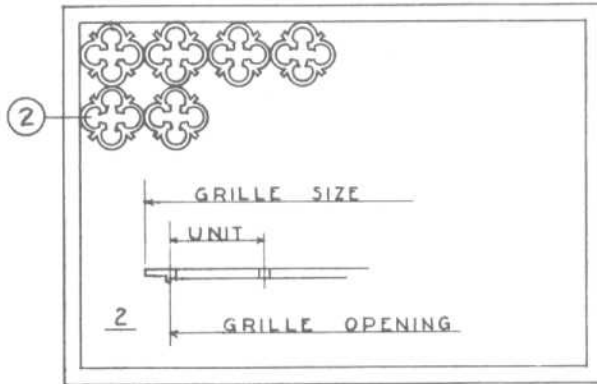
Types of Grilles



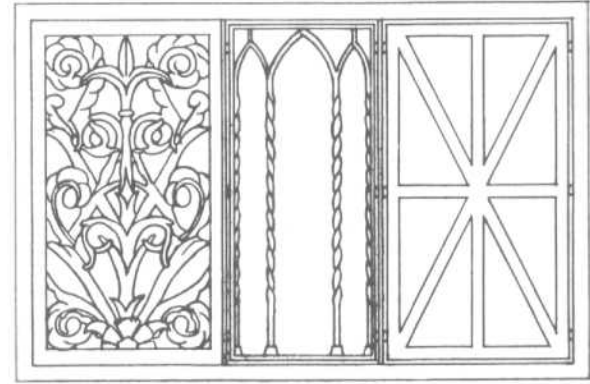
Cast metal grille of unit design, cast in one piece. Grille size is governed by unit sizes plus width of border.



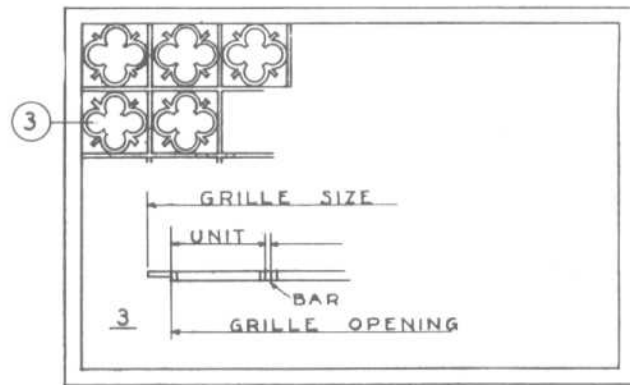
Cast metal grille of Renaissance design, ferrous or non-ferrous metal.



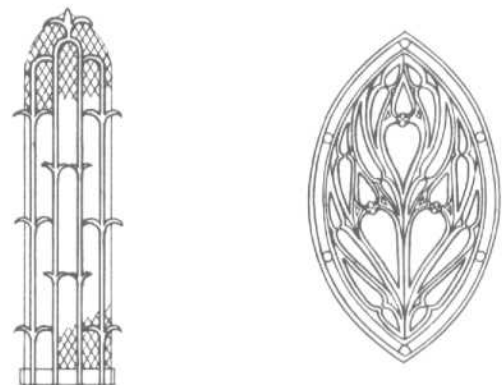
Cast metal grille of unit design, units cast separately and built into frame. Grille size is governed by unit sizes plus width of border.



Cast metal grille panels of various sizes cast in units and fitted into cast or wrought metal frame.



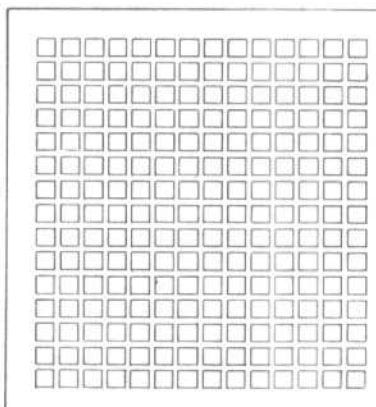
Cast metal grille of unit design. Units cast separately and built into grille spaces. Grille size must conform to unit sizes plus widths of bars and borders.



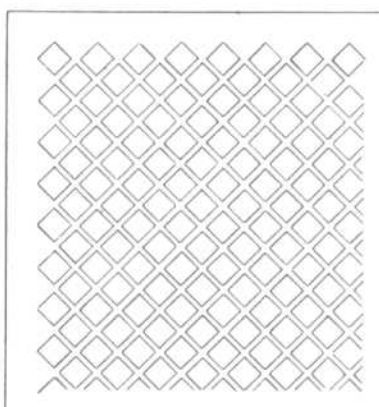
Cast metal grille for ventilator opening; may be fitted with metal screen and may be formed to curved wall or cove.

Cast metal grille for ventilator opening of special architectural form.

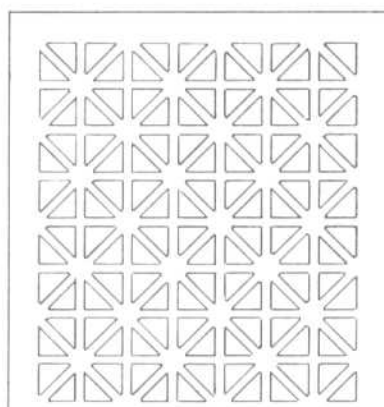
Fig. 1 Cast metal grilles may be designed and built in various combinations. They may be made in small units cast separately or as one complete piece.



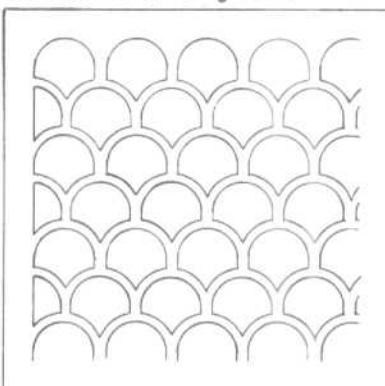
Stamped metal grille, square holes. Holes may be from 1/4" to 1 1/2" or larger, in 1/8" steps, with bars or frets from 1/8" to 3/8" or greater.



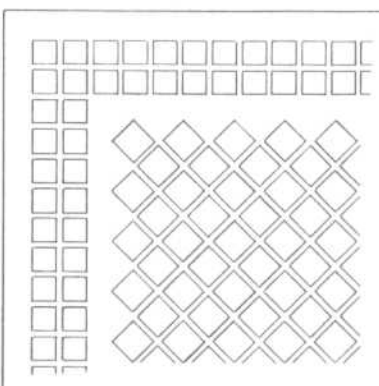
Stamped metal grille, square holes diagonally arranged.



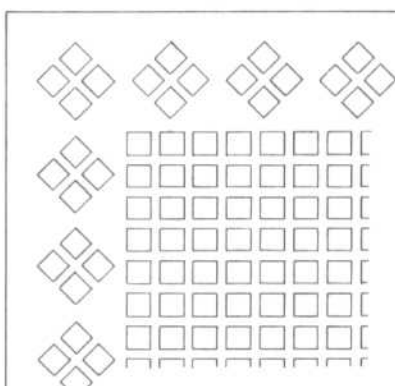
Stamped metal grille, Grecian or Union Jack design, made in a number of unit sizes and variations.



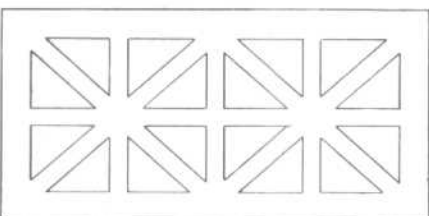
Stamped metal grille, shell or fish scale design, made in several unit sizes and variations.



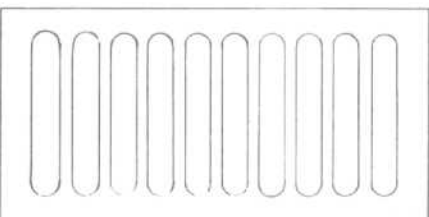
Stamped metal grille, square holes arranged to form plain border with diagonal center.



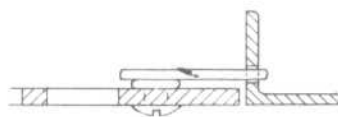
Stamped metal grille, square holes arranged to form diagonal border, with plain center.



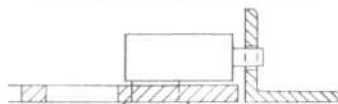
Foundation or Bulkhead Grille



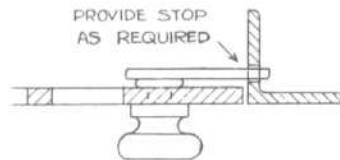
Foundation or Bulkhead Grille



Screwdriver Operated Catch



Lock and Dead Bolt



Thumb Latch

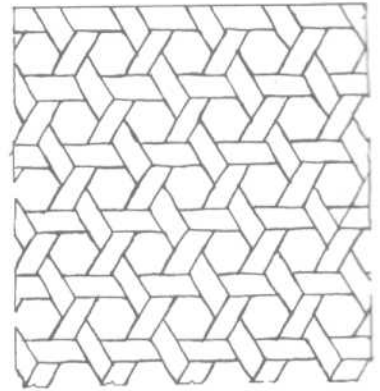
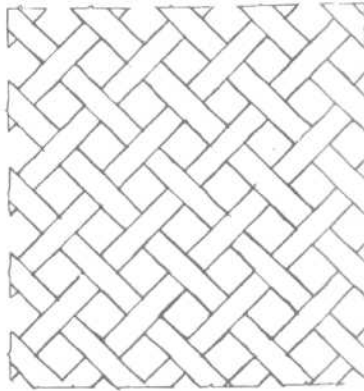
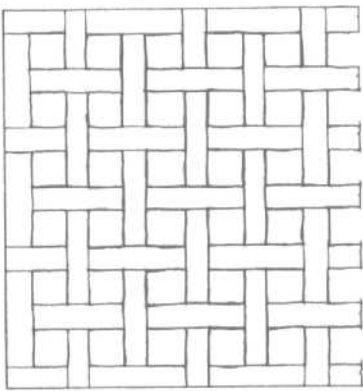
**SPECIFY:**  
 Sizes of holes or unit stampings  
 Thickness  
 Metal and finish  
 Approximate width of margins  
 Method of fastening  
 Hinges and locks where required  
 Invisible hand hole doors.

SCALE 1/2" = 1'-0" AND 1/2" = 1"

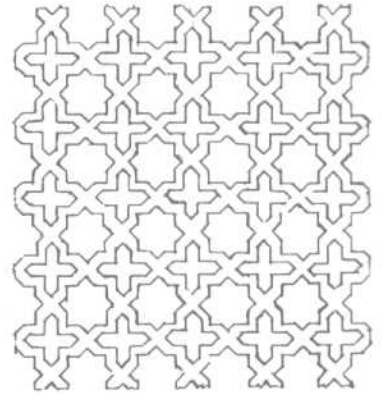
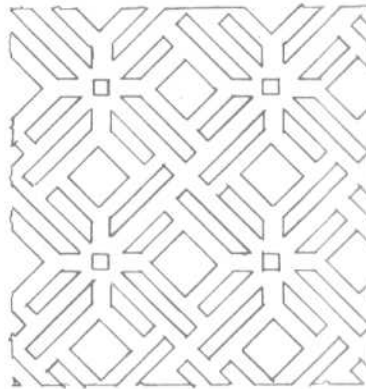
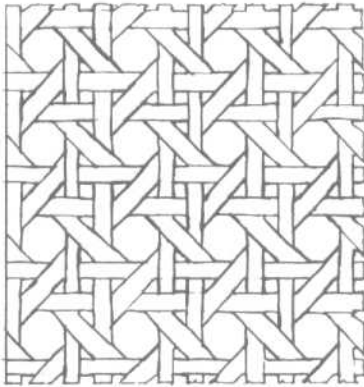
Fig. 2 Stamped metal grilles are produced in a great variety of designs, metals, thicknesses, and sizes. Percentage of free area of stamped grilles may vary from about 25% to over 70%, with a great many designs in the 55% to 65% range. Margin widths can be made to accord with requirements of particular installations, consideration being given to duct openings and overall dimensions. Metal may be steel, painted or otherwise finished, bronze, aluminum, monel metal, or other nonferrous metals, in thicknesses from 16 gauge to 1/4".

ACCESSORIES

Types of Grilles



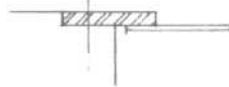
Perforated Metal Grilles



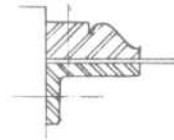
Perforated Metal Grilles



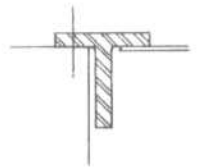
GRILLE 3 PANELS



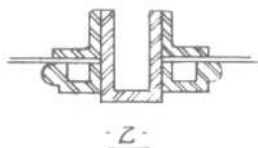
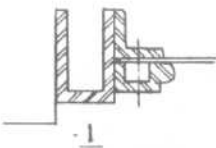
Flat Band Frame



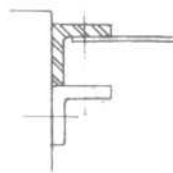
Moulding and Angle Frame



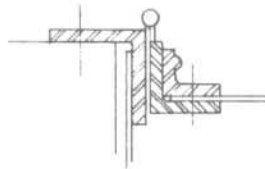
Tee Bar Frame



Grille of perforated sheets set into frame of channel, angle, and mouldings.



Reversed Angle Frame

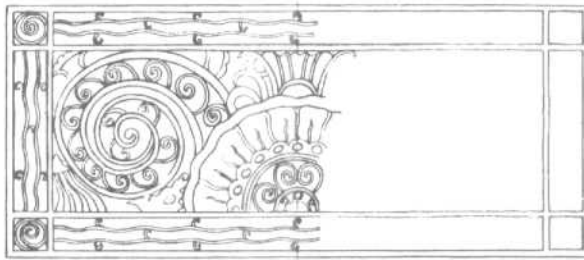


Moulding and angle frame to swing in fixed frame.

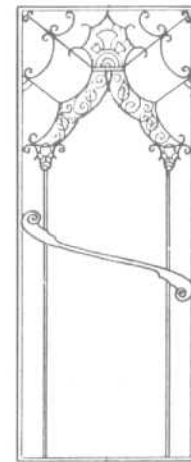
SCALE  $\frac{1}{2}'' = 1$

**SPECIFY:**  
 Pattern of perforations  
 Metal  
 Finish  
 Gauge or thickness  
 Give frame details

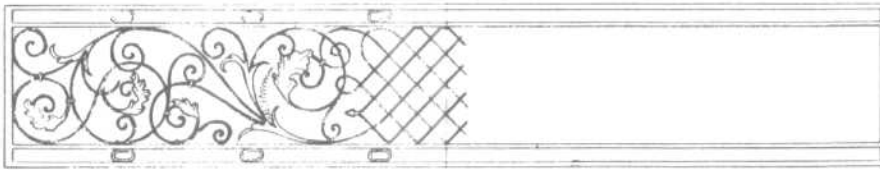
Fig. 3 Perforated metal grilles may be obtained in several designs and are produced of 19 gauge steel in sheets of standard sizes. Sheets may be cut to any size and placed in frames of metal or other material. Perforated metal grilles are used for vent openings, panels, covers, shelves, partitions, cabinets, metal furniture, boxes, machinery guards, enclosures and many other purposes. They are also available in many other patterns in any ferrous or nonferrous metal that can be perforated, and in thicknesses from about 24 gauge in the smaller perforations to  $\frac{1}{4}''$  or  $\frac{3}{8}''$  in the larger perforations.



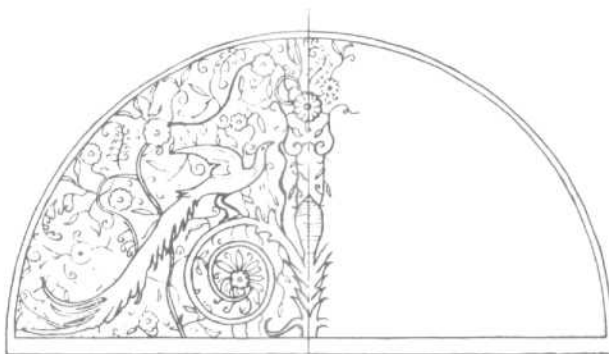
Wrought metal grille of heavy close construction, for radiator or ventilator openings.



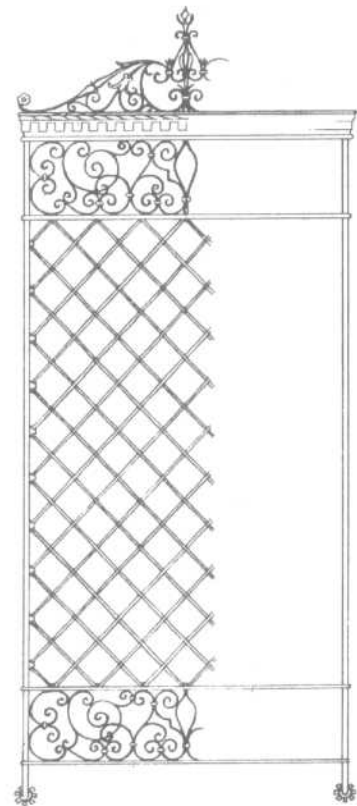
Wrought metal grille for glass door.



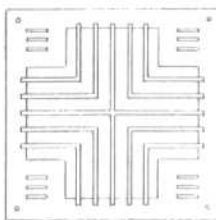
Wrought metal grille for railing or ornamental construction.



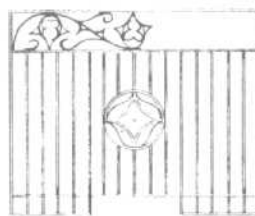
Wrought metal grille of light construction, with silhouette work, leaves, flowers, and husks, for arch decoration.



Wrought metal grille for large window or opening.



Wrought metal grille of sheet and flat bars, for ventilating opening.

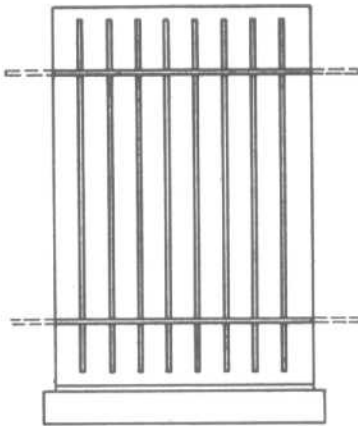


Wrought metal grille for counter.

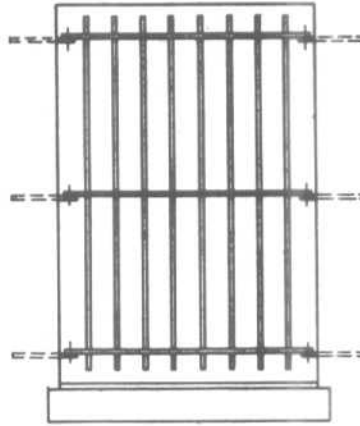
Fig. 4 Design of wrought metal grilles includes the use of other metal forms, such as sheets, extruded mouldings, castings, and stampings. Thus, in addition to plain bar sections and forged items, use is made of the unlimited number of extruded mouldings in non-ferrous metals; stamped leaves, rosettes, and ornaments of many kinds; cast iron, bronze, nickel silver, and aluminum items of every character; and rolled or drawn sections of many shapes.

ACCESSORIES

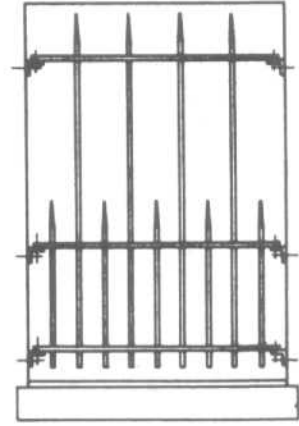
Types of Grilles



Grille of round or square vertical bars welded to horizontal bars set in masonry.



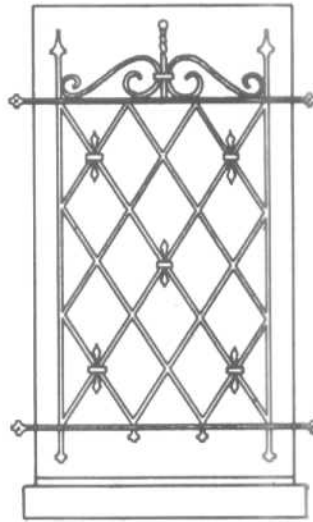
Grille with anchors set in masonry and grille bolted or riveted to anchors.



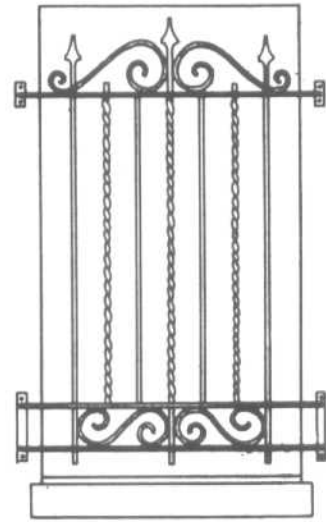
Grille with short alternate vertical bars, angle clips fastened to opening jambs.



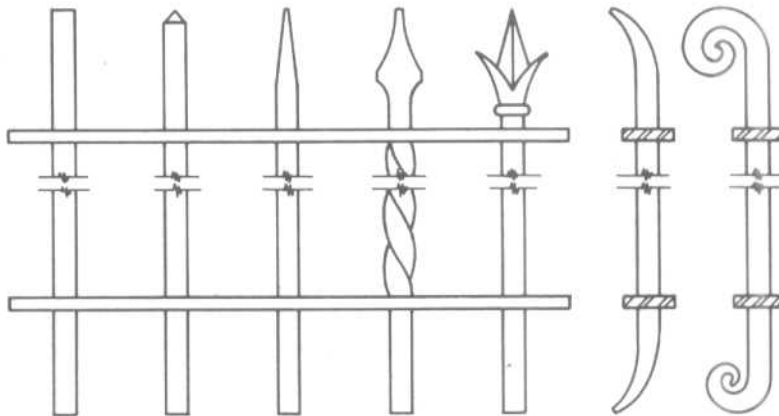
Grille, with ornament between bars, set in masonry opening.



Grille of welded construction set on face of wall.



Grille of welded construction set on face of wall.

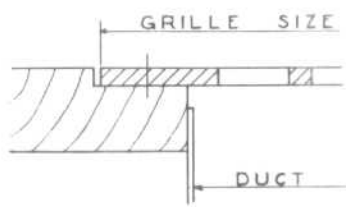


A B C D E F G

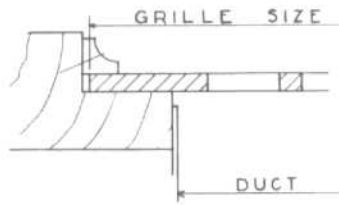
Methods of forming vertical bars.

Fig. 5 Window grilles are of plain construction when used for protection only, and when used for ornamental effect, may be designed with many unique and interesting ideas. Window grilles may be set in the masonry openings or on the face of the wall, with either plain or ornamental brackets or supports. They may also be attached to window frames, or may be arranged to swing, with hinges and locks. Material sizes in window grilles may vary according to the degree of protection required, and in proportion to the size of the grille.

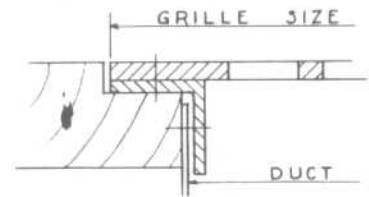




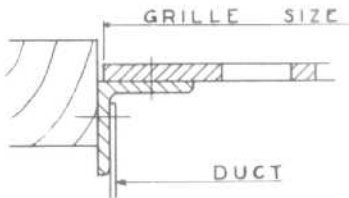
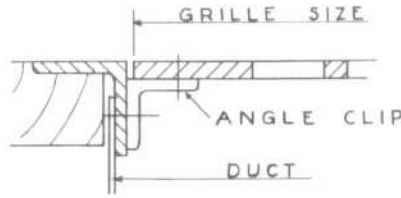
Set in Rabbet



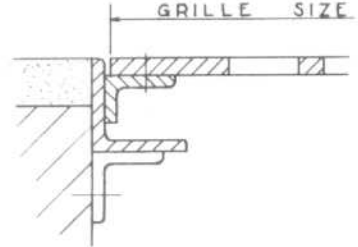
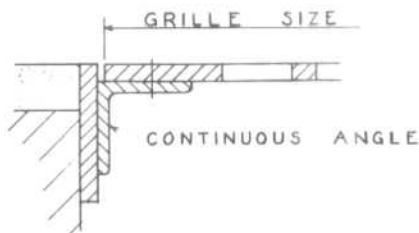
Secured by Moulding



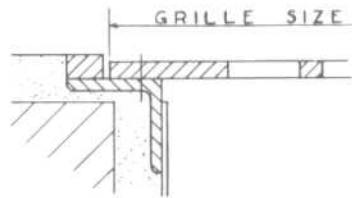
Angle Frame on Back

Reversed Angle Frame  
on Back

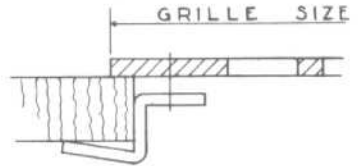
Angle Frame Exposed

Reversed Angle Frame  
Exposed

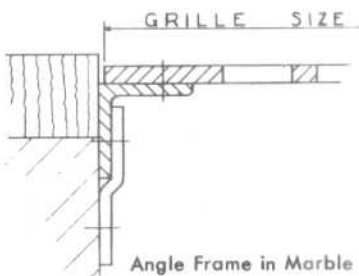
Band and Angle Frame



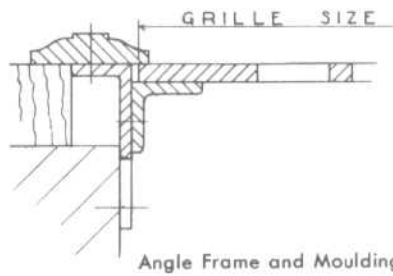
Angle and Plaster Ground



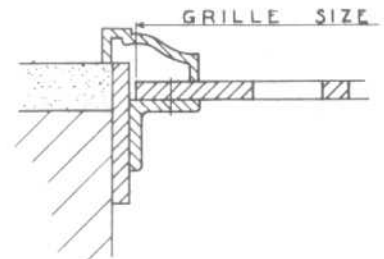
Lugs for Marble



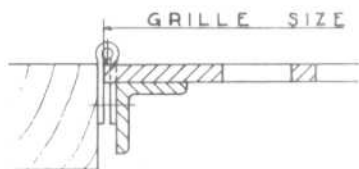
Angle Frame in Marble



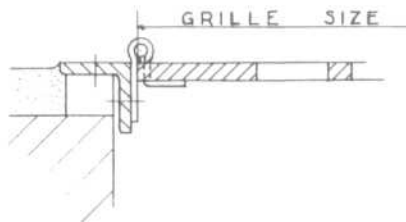
Angle Frame and Moulding



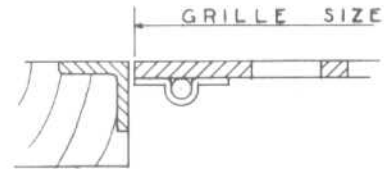
Band Frame and Moulding



Hinged to Woodwork



Hinged to Angle Frame



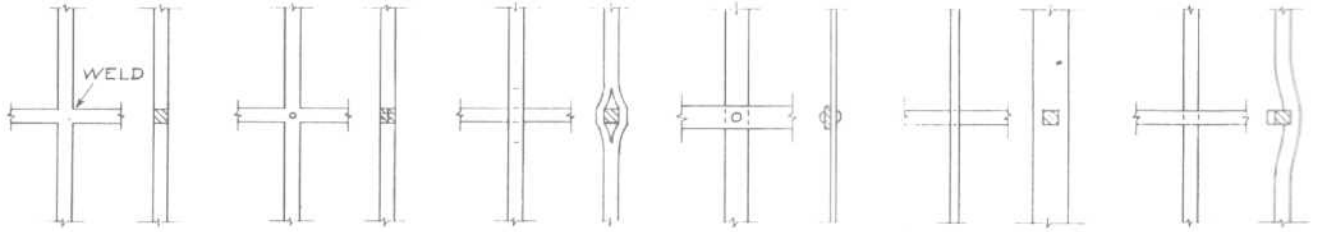
Round Rod Hinge

SCALE  $\frac{1}{2}'' = 1''$ 

Fig. 6 Methods of fastening grilles. Cast and stamped metal grilles may be fastened by screws or hinges and locks to walls of wood, plaster, marble, or other material in a variety of ways, depending upon the type of the grille, the type of framing to be used around the grille, and the appearance or effect desired. These methods show a number of ways in which cast and stamped grilles may be fastened. In selecting the method desired, consideration should be given to whether or not the grille will require frequent removal. The size and weight of the grille will have a bearing upon the size of frames, screws, and hinges.

ACCESSORIES

Grille Fastening Methods



Two members crossed, one member cut and welded to the other.

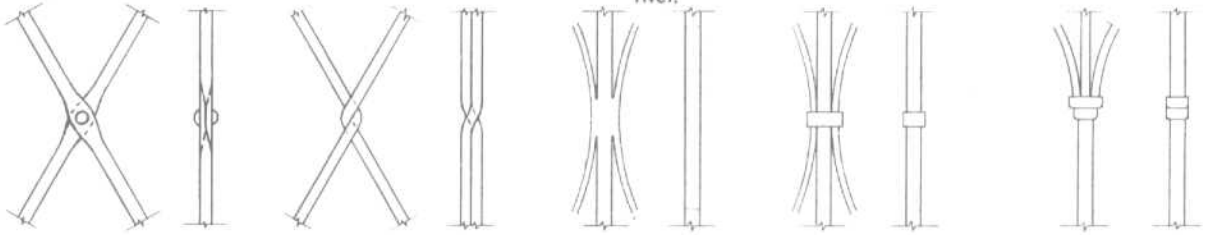
Two members crossed, each member halved. Pin may be countersunk or peined.

Two members crossed, one member split permitting other to pass through.

Two members crossed, one member laid upon the other, with round-head or countersunk rivet.

Two members crossed, one member punched permitting other to pass through.

Two members crossed, each member crimped.



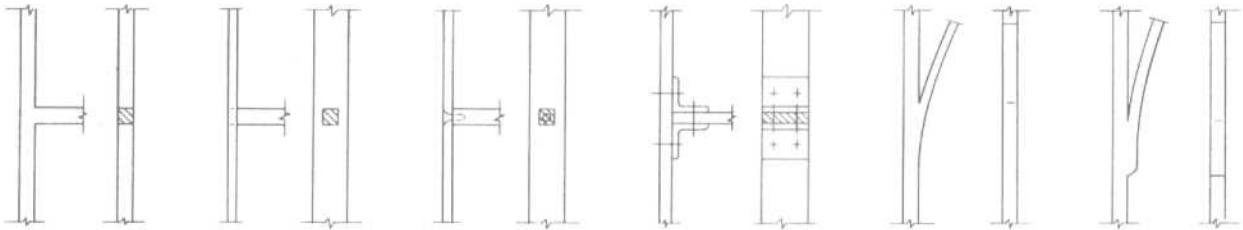
Two members crossed, each member flattened, with round head rivet.

Two members linked.

Formed members welded to sides of straight member.

Formed members banded to sides of straight member.

Formed members terminated and banded to sides of straight member.



One member cut and welded to side of other.

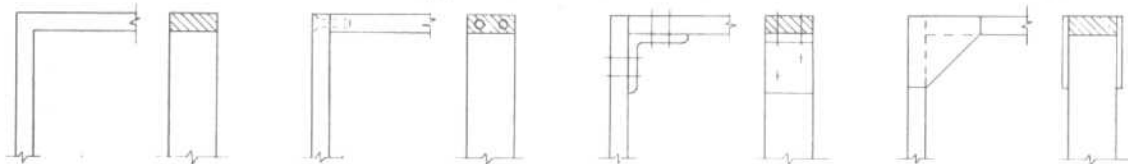
One member set into punched hole in other member and welded.

One member set against other member and attached by flat head tapped screw.

One member attached to side of other member by angle clips bolted or riveted.

Formed member with knife edge, welded to side of straight member.

Formed member with blunt end welded to side of straight member.

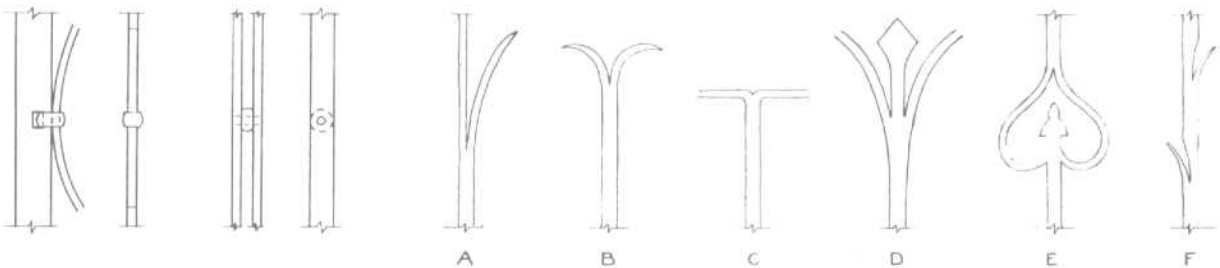


Corner members welded.

Corner members fitted, with two flat head tapped screws.

Corner members bolted through angle clips.

Corner members with welded gusset plates.



Formed member attached to the other member by band in slot.

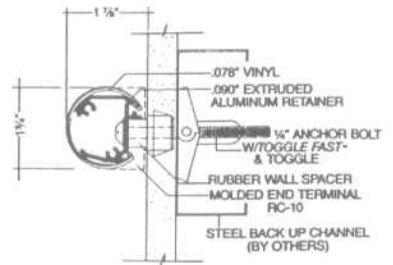
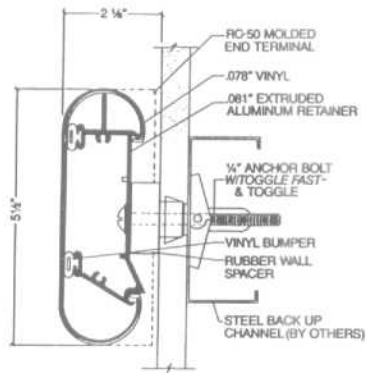
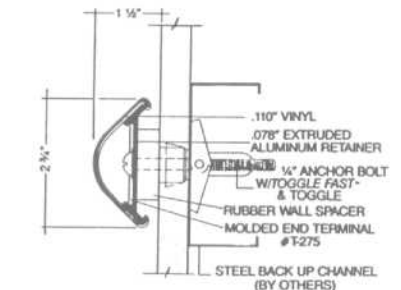
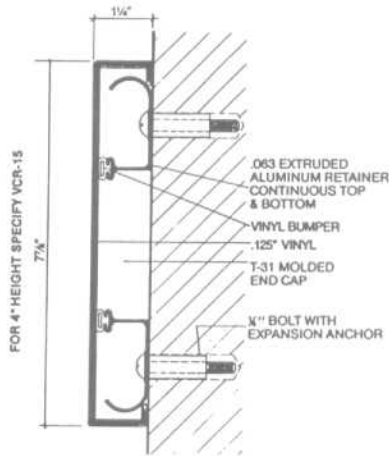
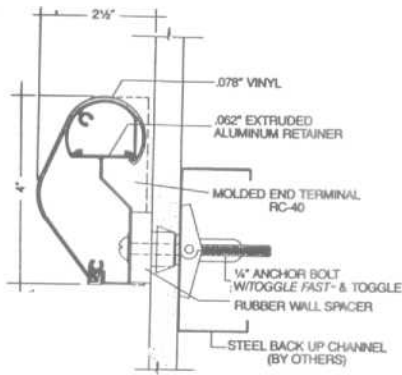
Two parallel members attached by spool and pin.

Methods of splitting members and forming into scrolls, ends, ornaments, or structural elements.

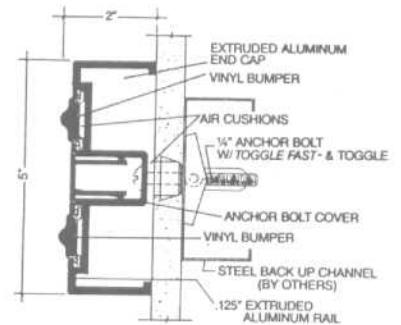
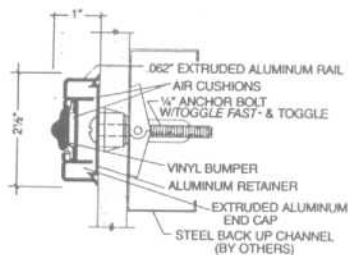
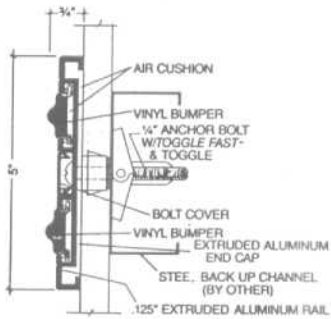
SCALE 1/2" = 1'-0"

Fig. 7 Wrought metal grilles are fabricated by the use of a great many different methods of crossing and joining members. Some of the more widely employed of these methods are shown here.

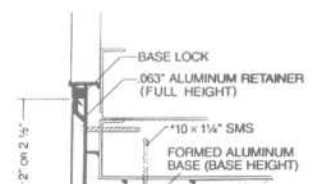
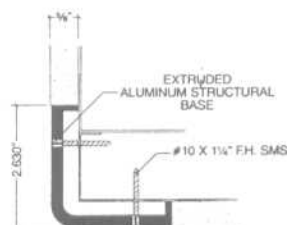
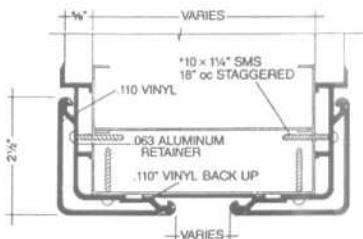
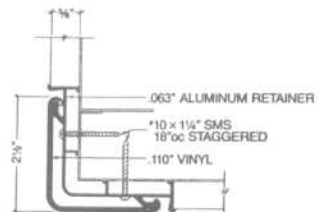
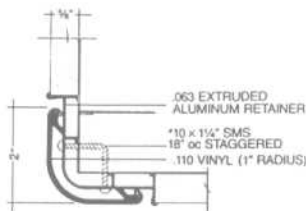
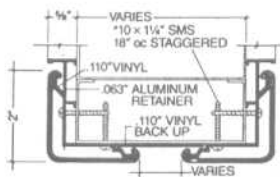
VINYL WALL PROTECTION GUARDS



ALUMINUM WALL PROTECTION GUARDS

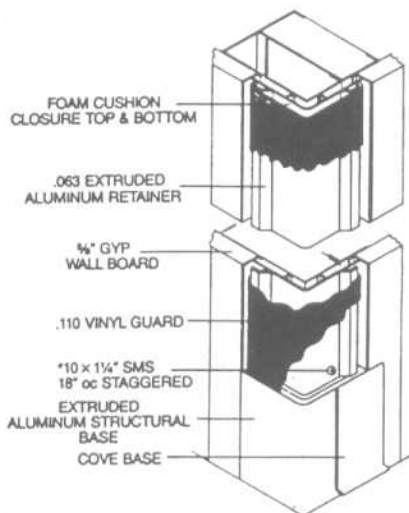
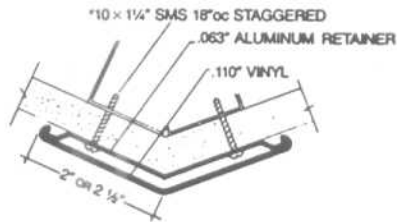
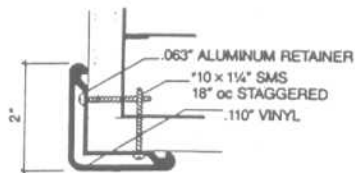
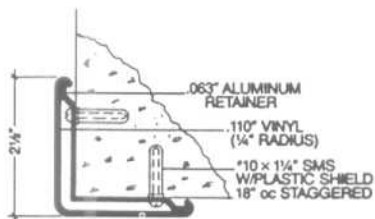
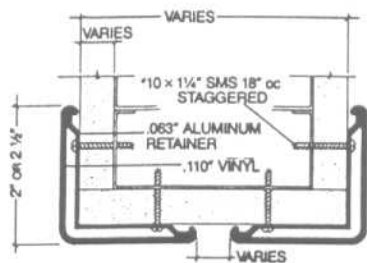


FLUSH-MOUNTED CORNER PROTECTION GUARDS

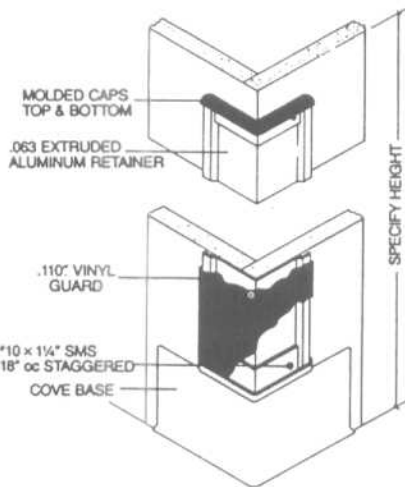


ACCESSORIES

Vinyl Wall Protection Guards

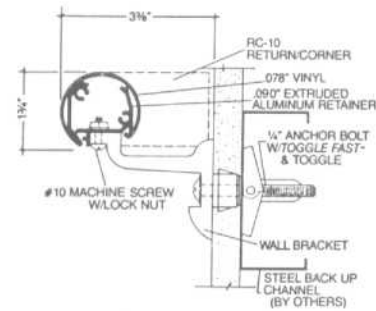
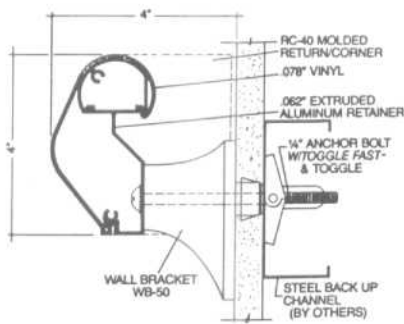
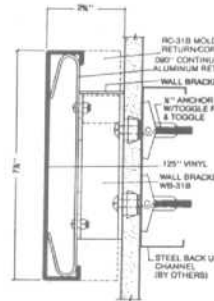
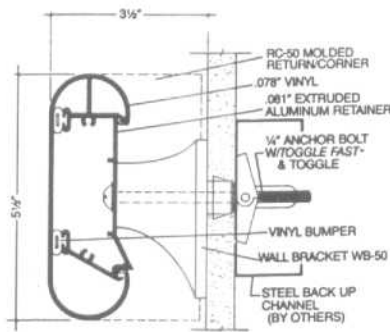
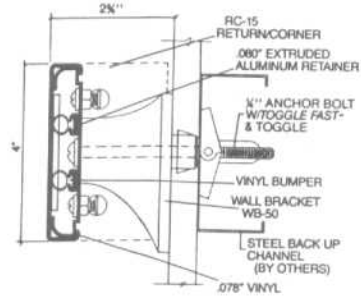
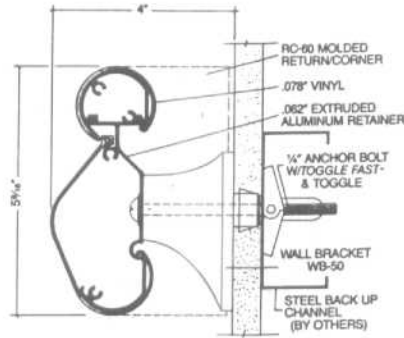


Ceiling height – flush mount

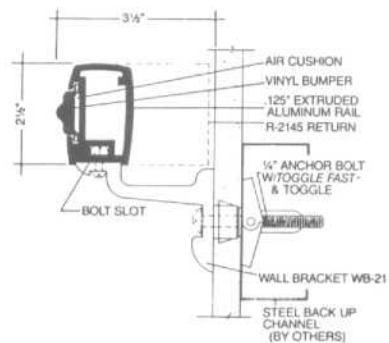
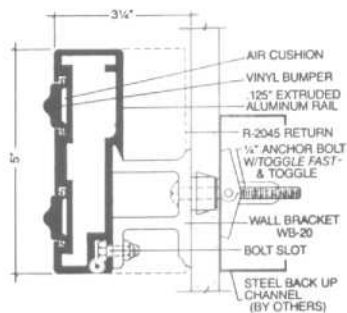


Wainscot installation – surface mount

VINYL HANDRAILS

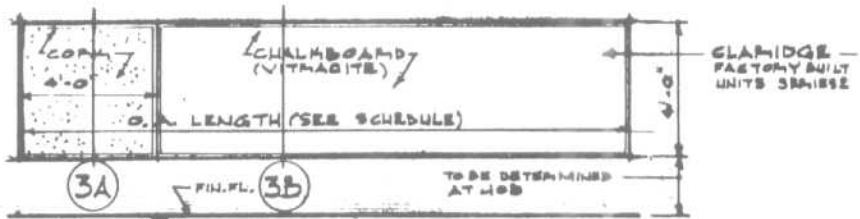


ALUMINUM HANDRAILS

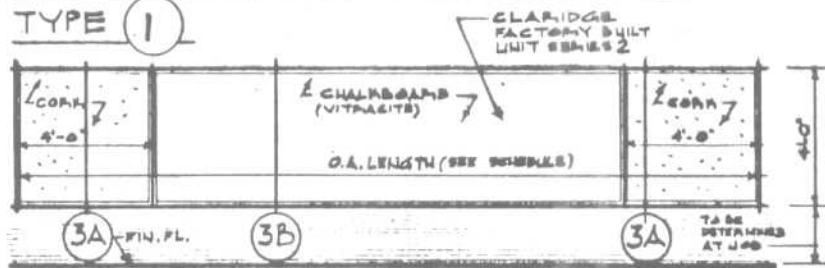


ACCESSORIES

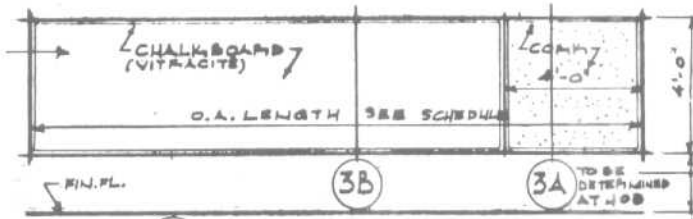
Chalkboard Details



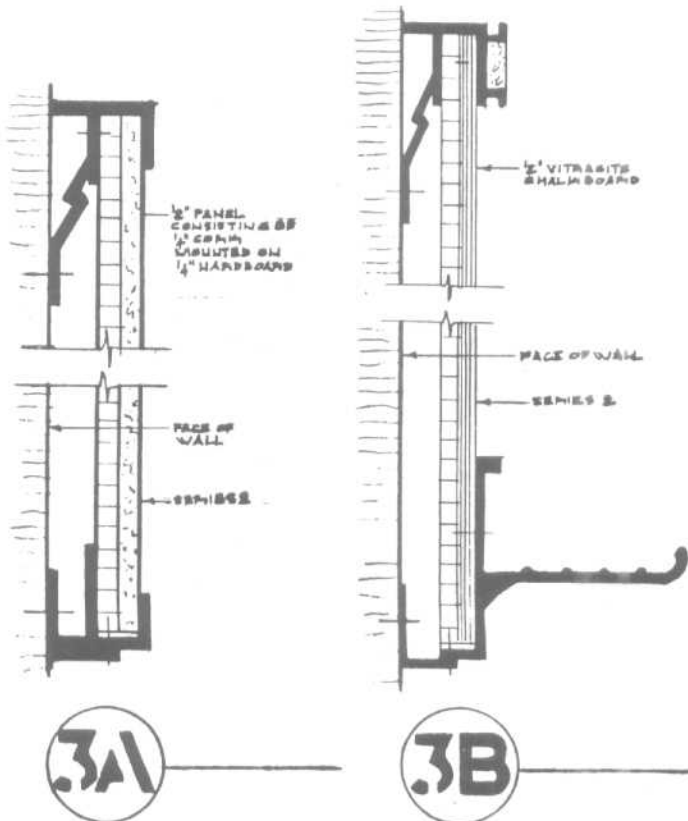
TYPE 1



TYPE 3



TYPE 2

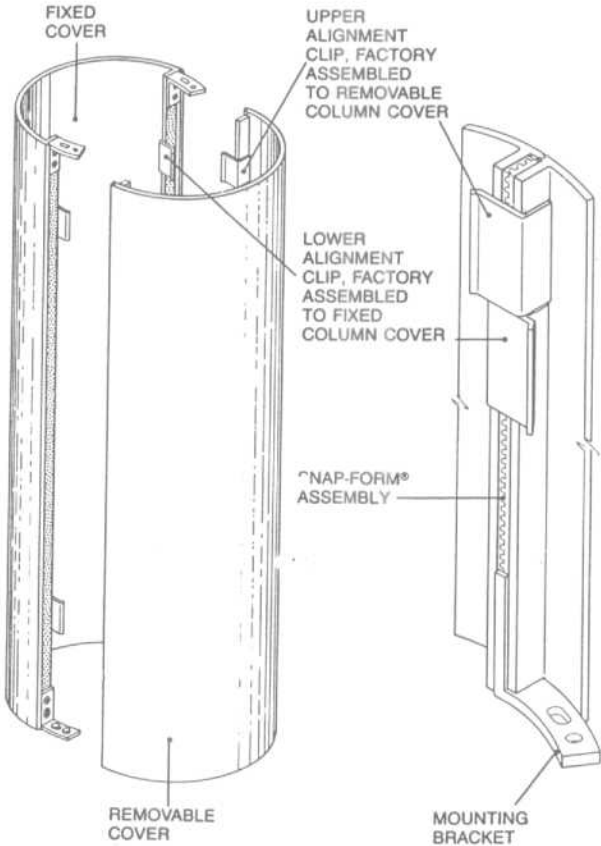


3A

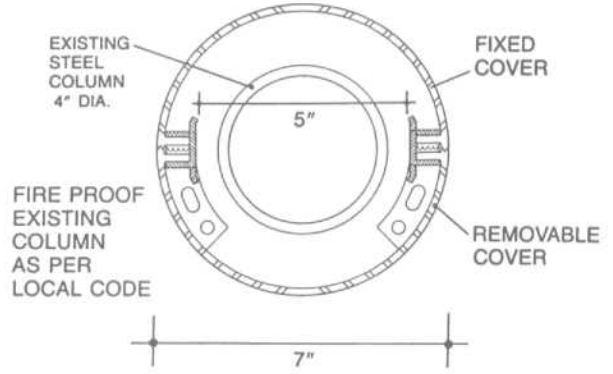
3B

ACCESSORIES

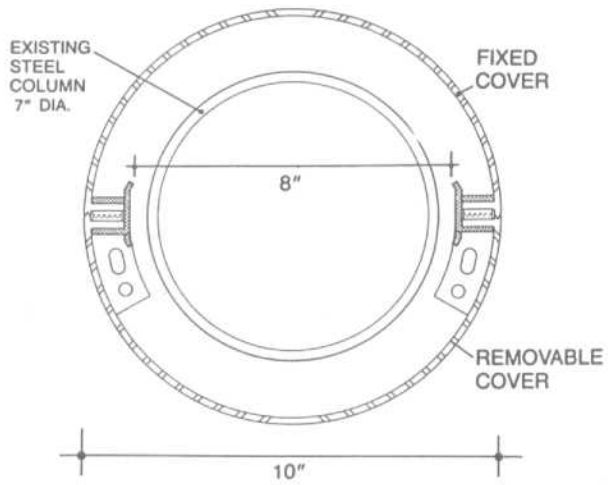
Column Covers



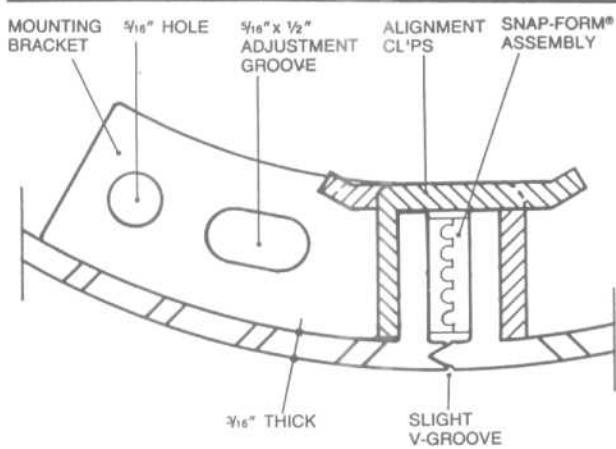
COLUMN ASSEMBLY  
PERSPECTIVE



COLUMN COVER  
7" DIAMETER



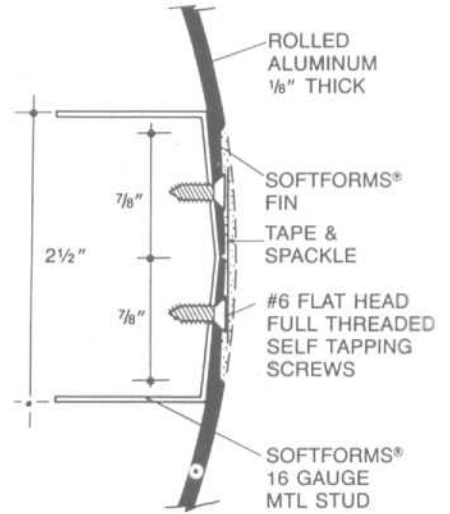
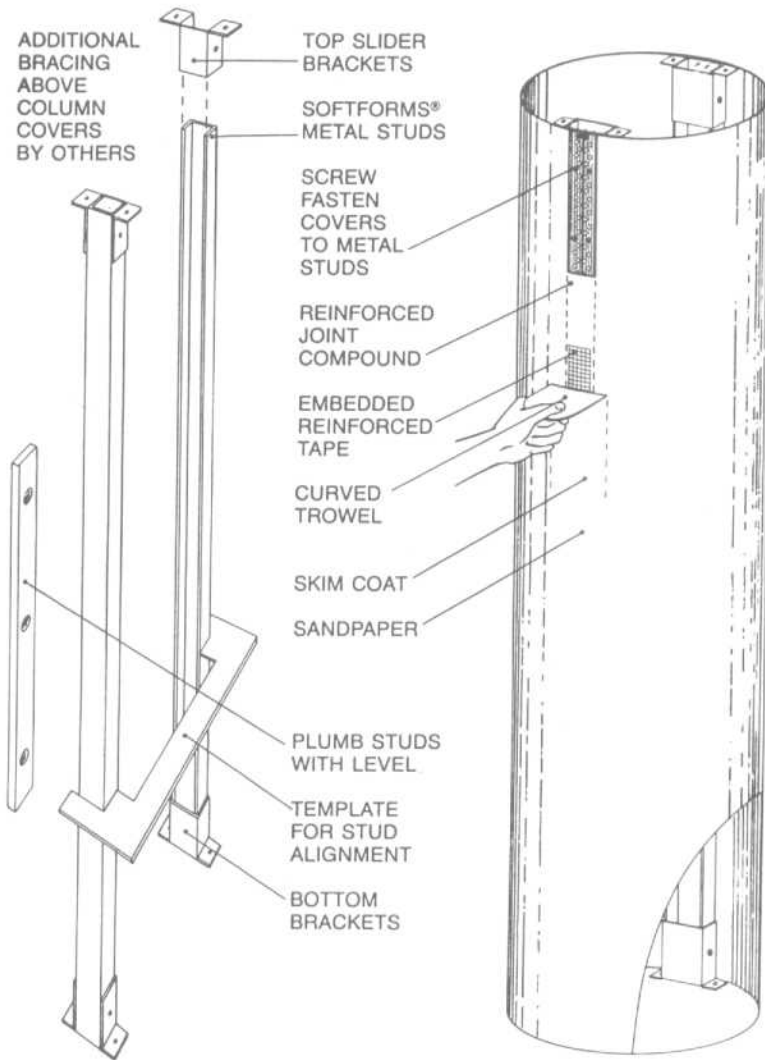
COLUMN COVER  
10" DIAMETER



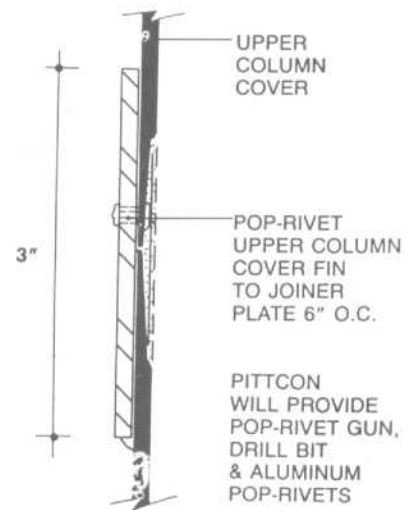
JOINT DETAIL  
PLAN

ACCESSORIES

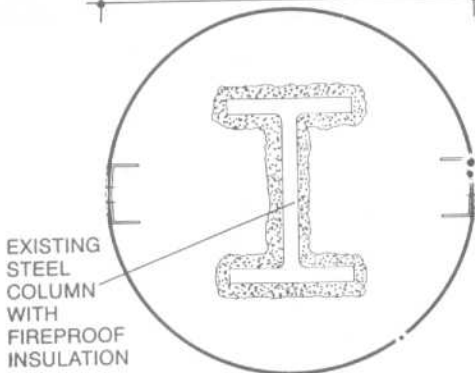
Column Covers



SERIES 100K TYPICAL JOINT DETAIL  
NO SCALE SECTION



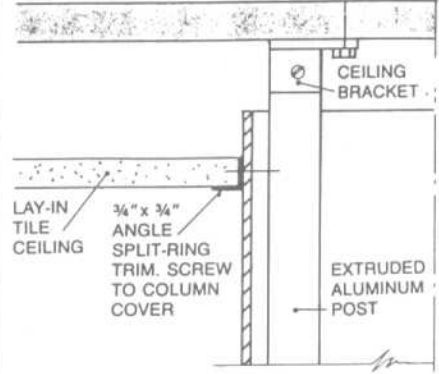
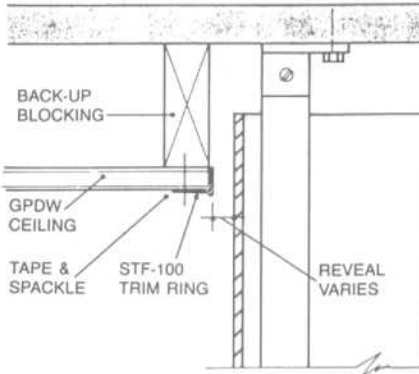
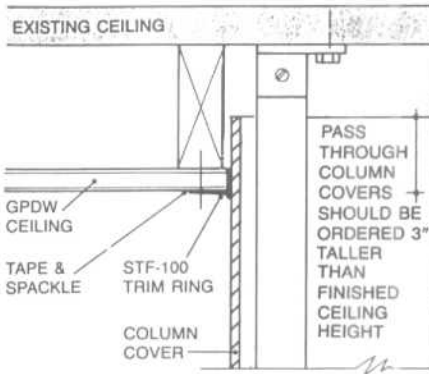
SPECIFY OUTSIDE DIAMETER — MINIMUM 14"



SOFTFORMS® COLUMN COVERS  
SECTION



CONDITION 1 — COLUMN PASSES THROUGH CEILING; REQUIRES INSTALLATION PRIOR TO FINISHING CEILING.

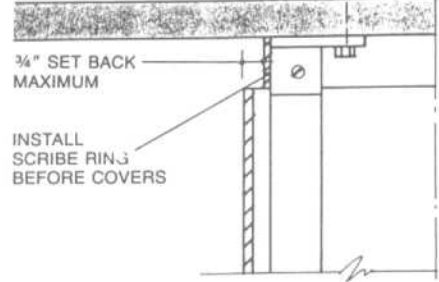
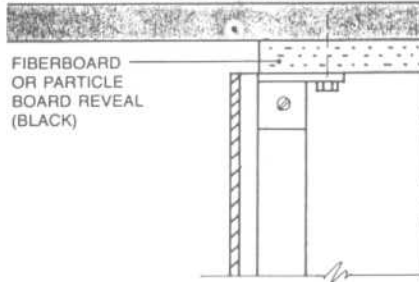
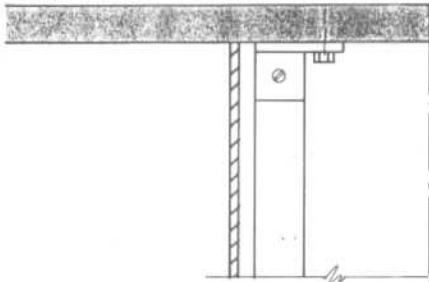


**A** PASSES THROUGH GPDW CEILING WITHOUT REVEAL

**B** PASSES THROUGH GPDW CEILING WITH REVEAL

**C** PASSES THROUGH LAY-IN TILE CEILING WITHOUT REVEAL

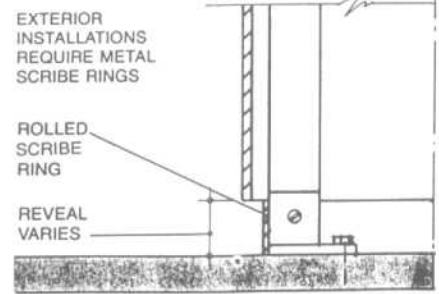
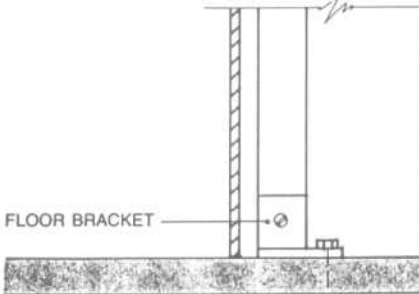
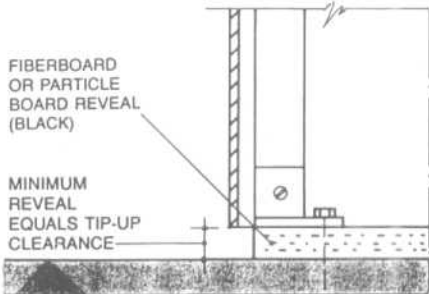
CONDITION 2 — COLUMN INSTALLED BETWEEN FIXED CEILING AND FLOOR



**D** FLUSH TO CEILING

**E** REVEAL BOARD AT CEILING

**F** SCRIBE RING AT CEILING



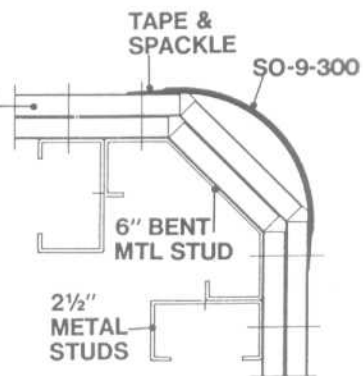
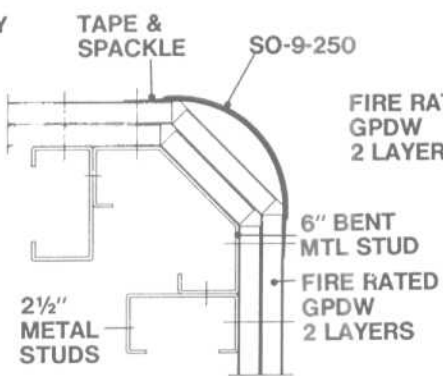
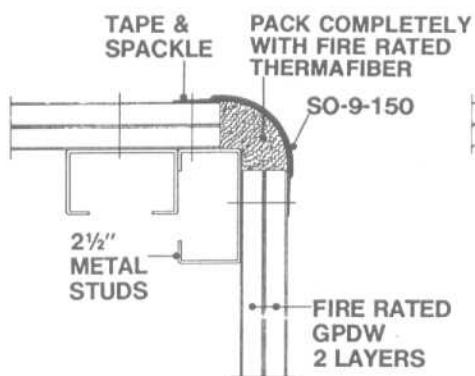
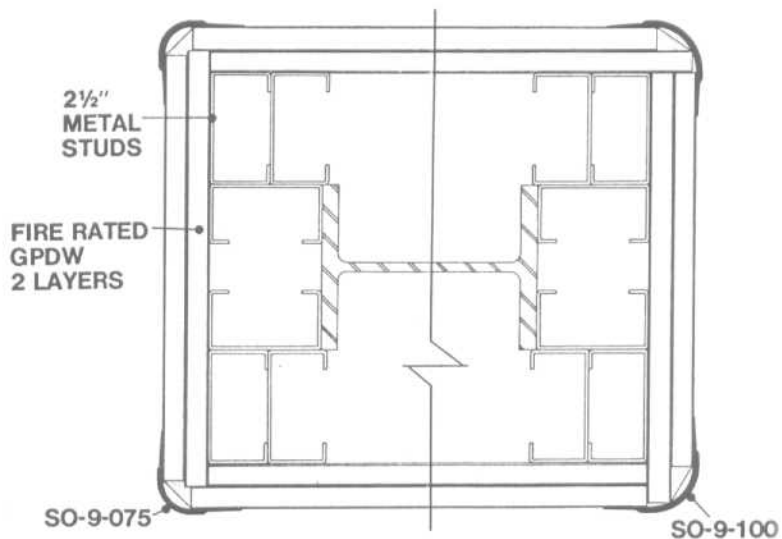
**G** REVEAL BOARD AT FLOOR

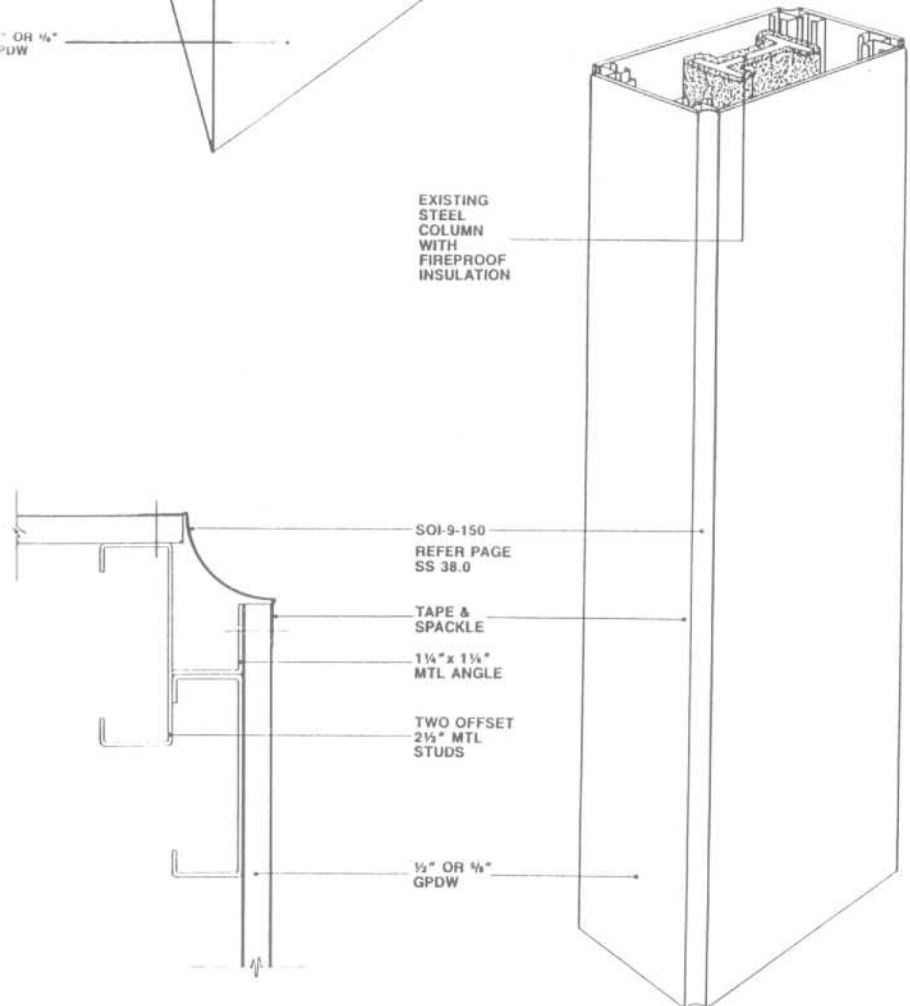
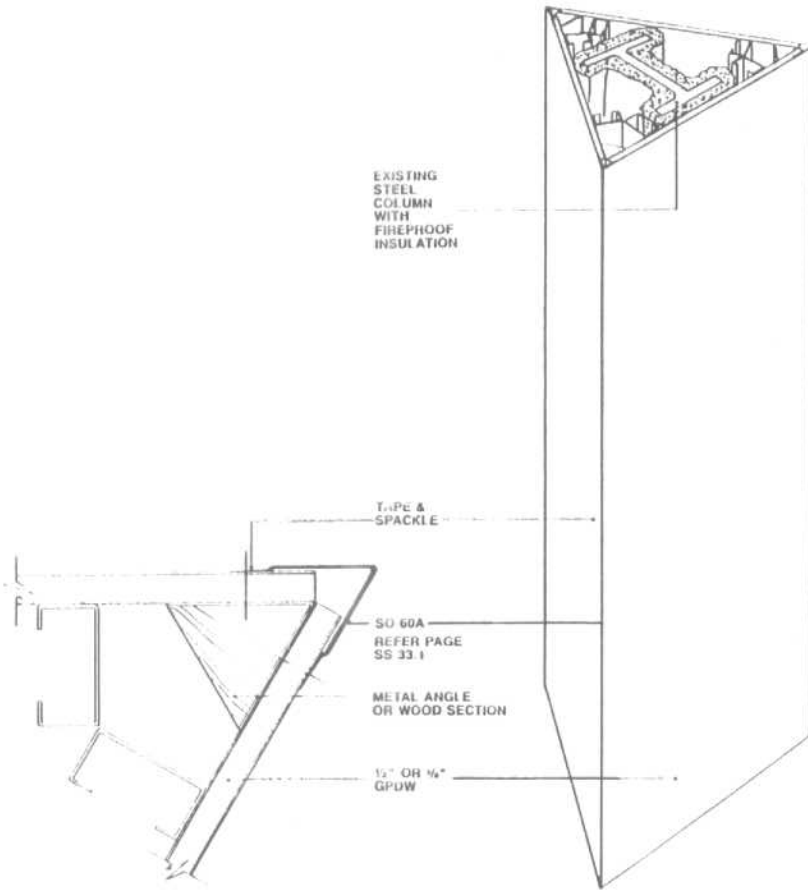
**H** FLUSH TO FLOOR

**I** SCRIBE RING AT FLOOR

ACCESSORIES

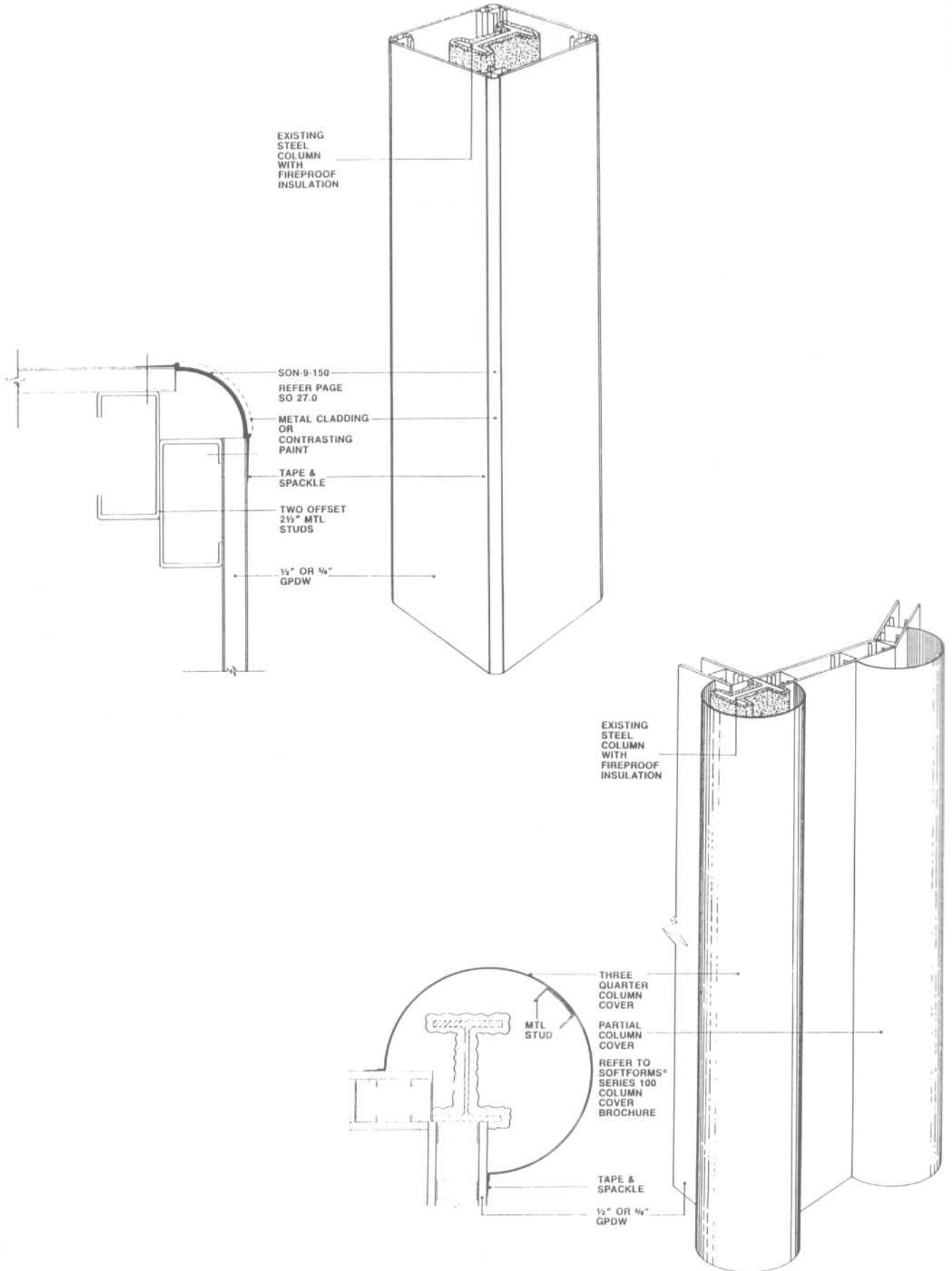
Column Covers



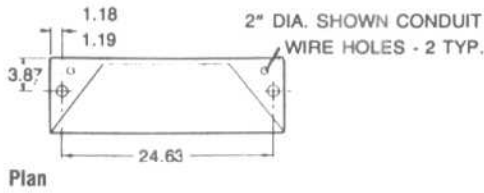


ACCESSORIES

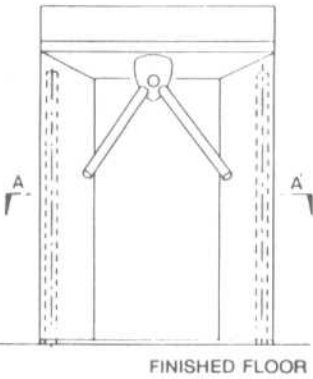
Column Covers



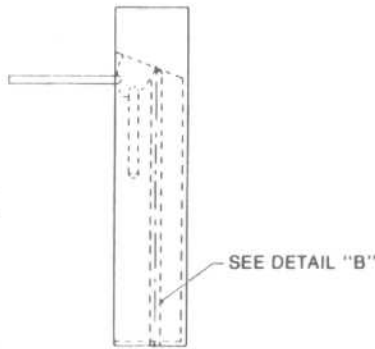
**3-ARM HIGH-TRAFFIC MANUAL AND ELECTRIC TURNSTILES**



Plan

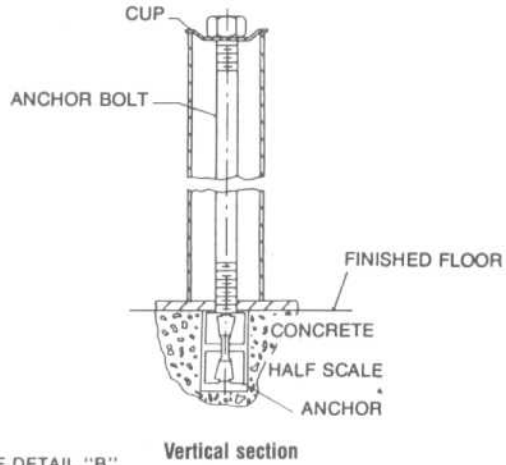


Side elevation

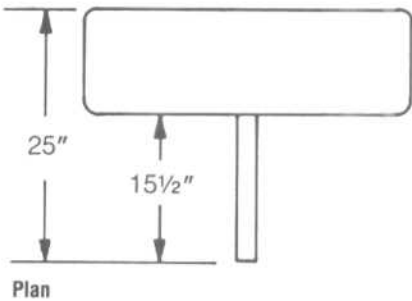


Front elevation

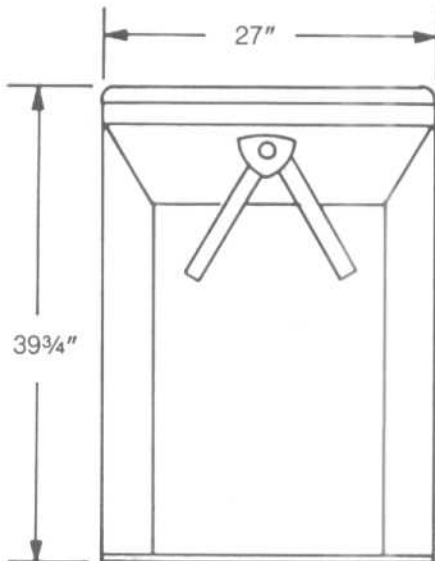
**DETAIL "B"**



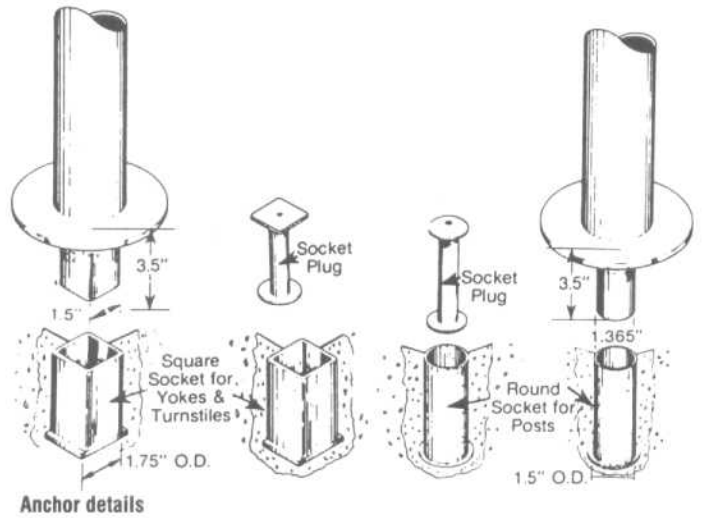
Vertical section



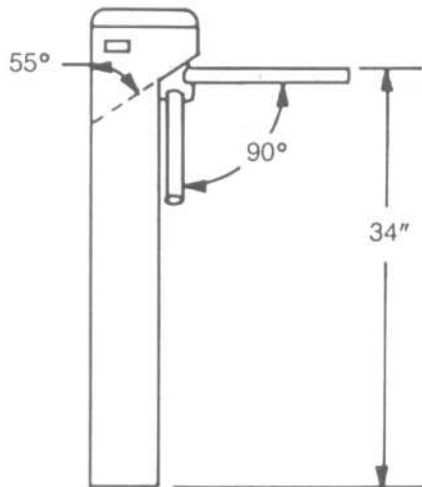
Plan



Side elevation



Anchor details

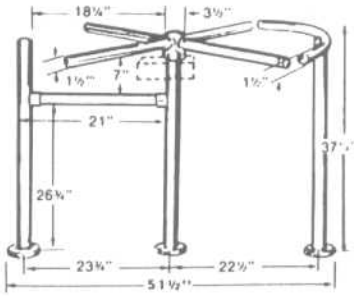


Front elevation

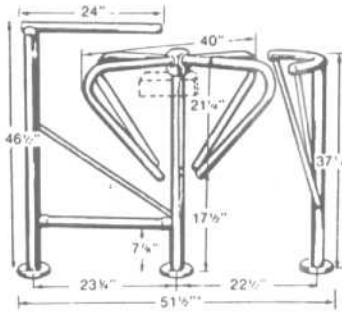
ACCESSORIES

Turnstiles

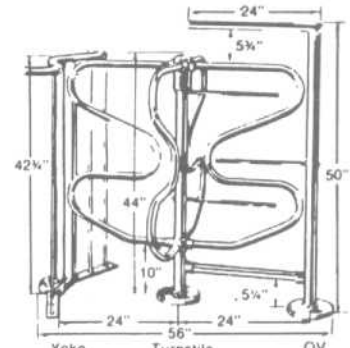
4-ARM MANUAL AND ELECTRIC TURNSTILES



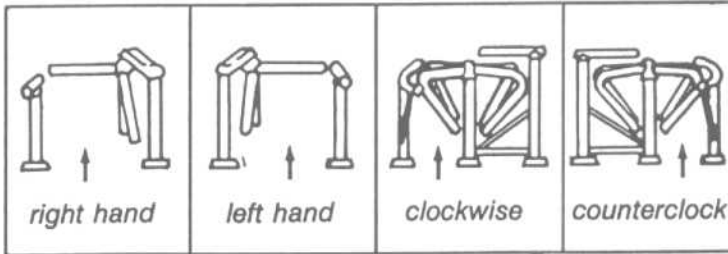
Basic customer security



Enhanced security

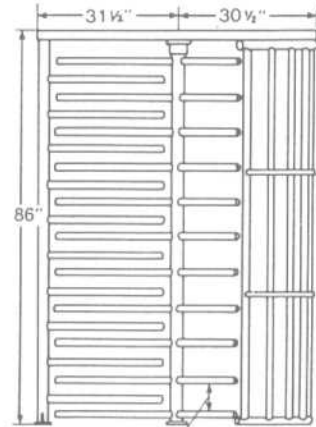


Maximum security



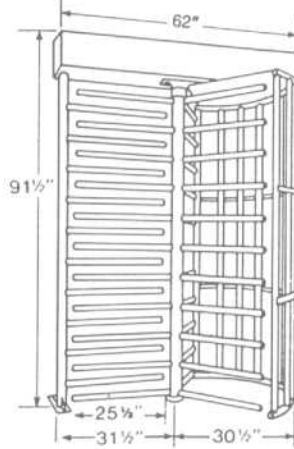
Rotation guide

HIGH-SECURITY TURNSTILES

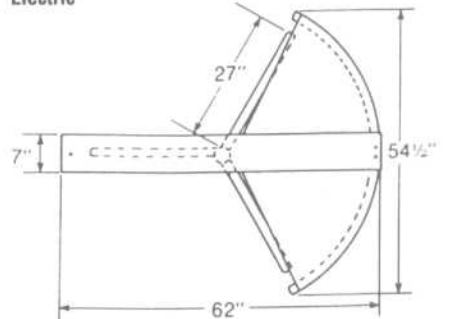


4 3/4" TYP.

Manual

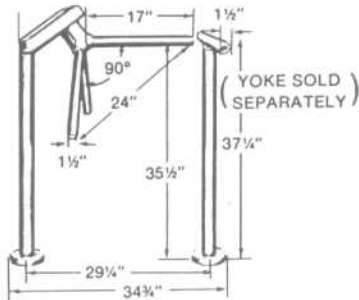


Electric

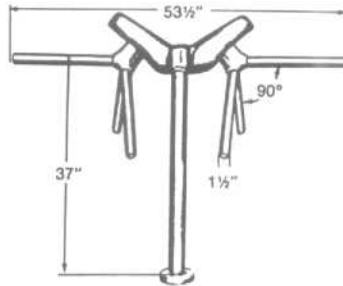


Plan of electric type configuration

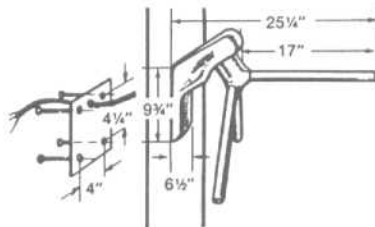
3-ARM MANUAL AND ELECTRIC TURNSTILES



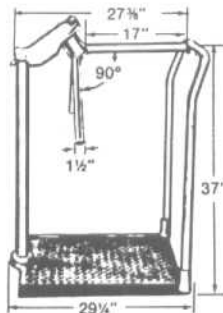
Post-mounted



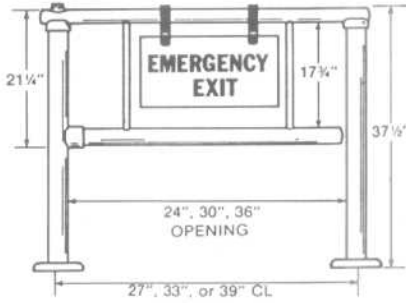
Tandem (post-mounted)



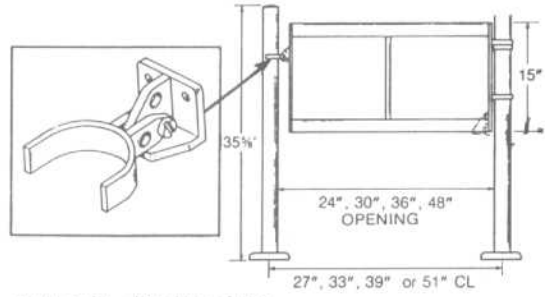
Wall-mounted



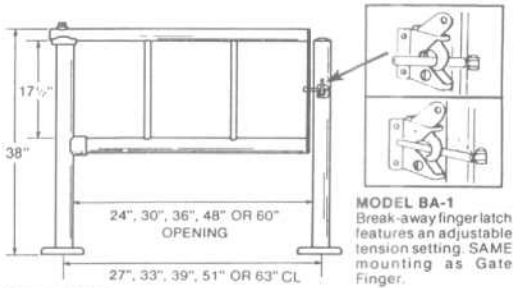
Portable



Emergency — quick release

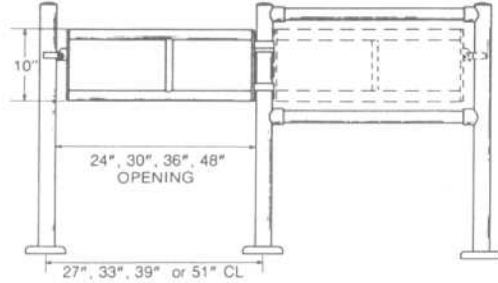


Double rail — flip sleeve latch

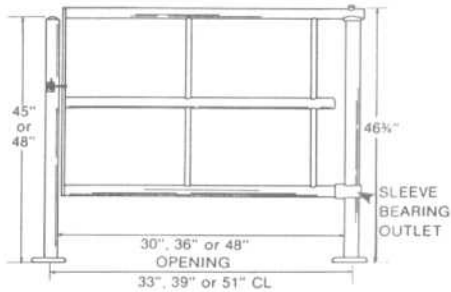


Finger latch

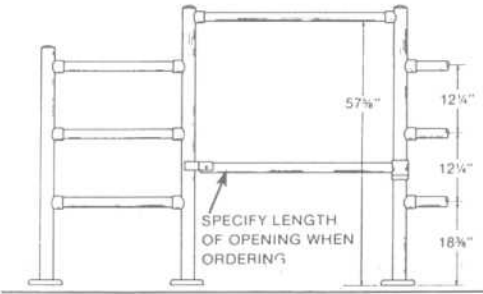
**MODEL BA-1**  
Break-away finger latch features an adjustable tension setting. SAME mounting as Gate Finger.



Double rail — aisle closure with flip sleeve latch



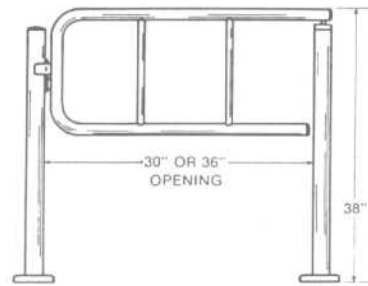
Triple rail — finger latch



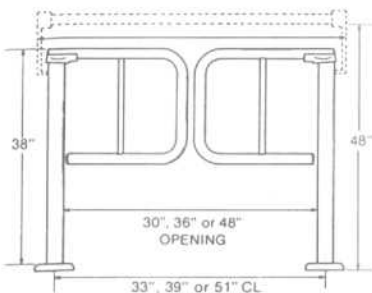
Single rail — cart security with flip sleeve latch



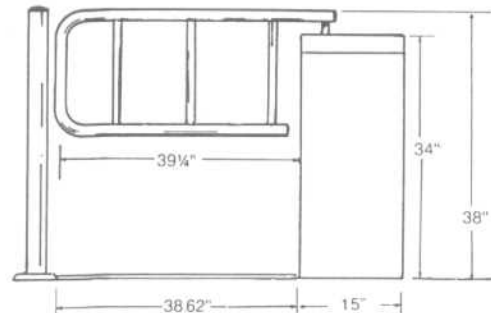
Triple rail — alarm system



Single section welded rail — electrically controlled gate latch, wheelchair access



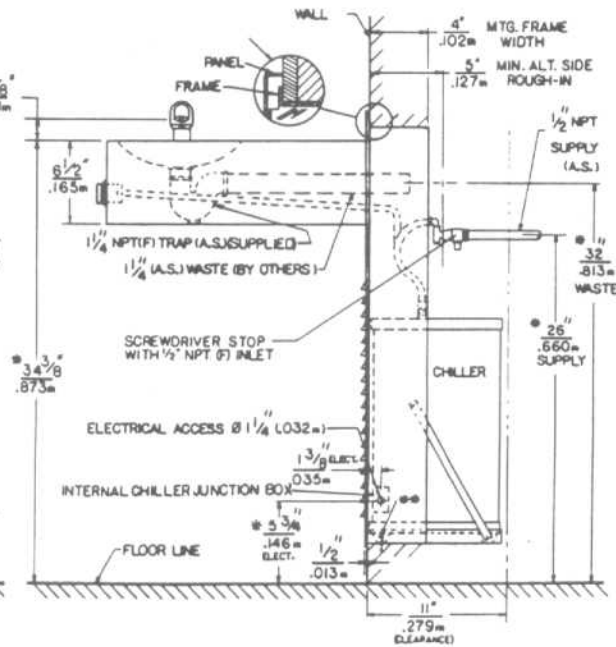
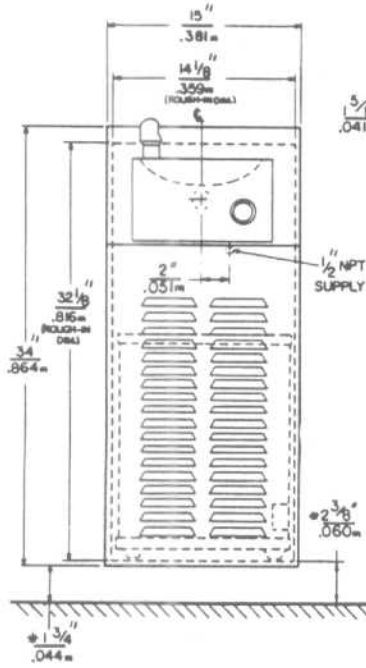
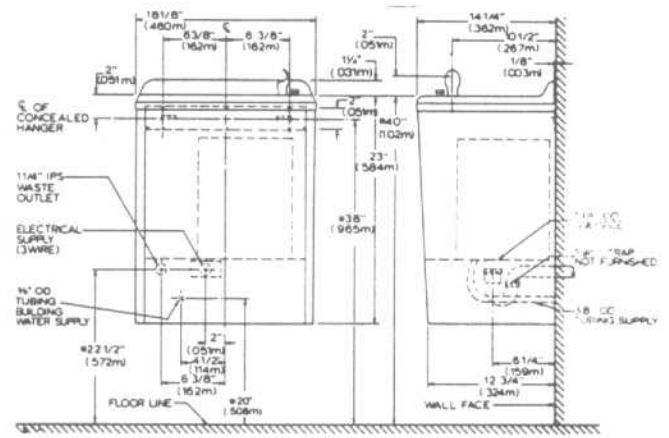
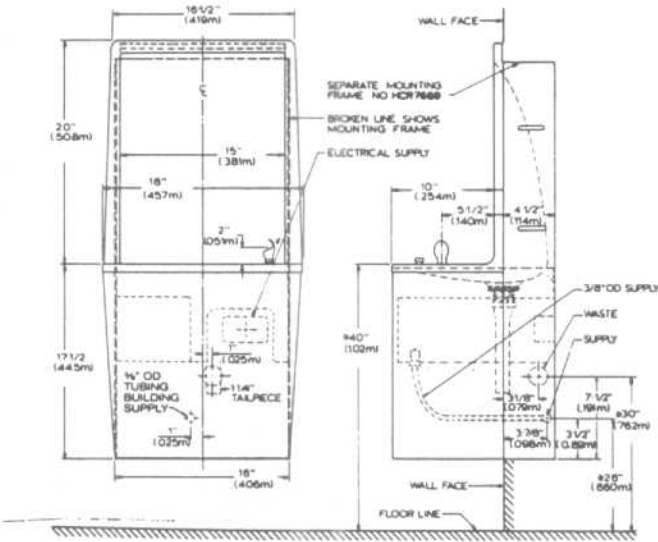
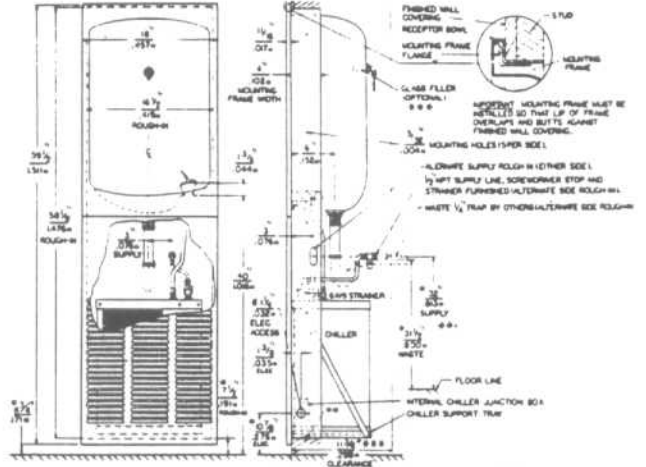
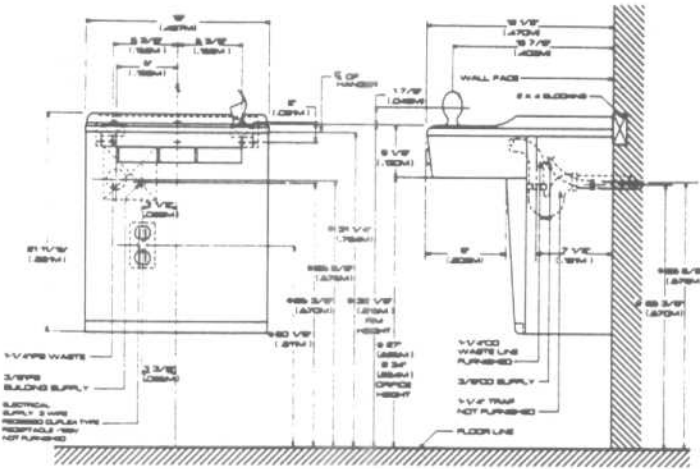
Double rail



Single section welded rail — self-closing or self-opening

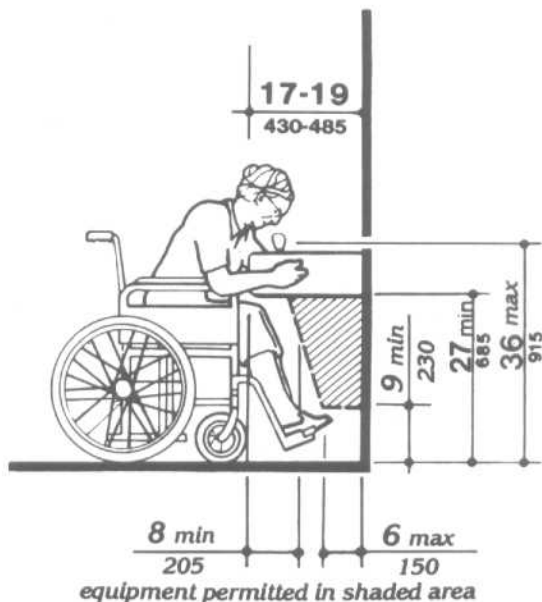




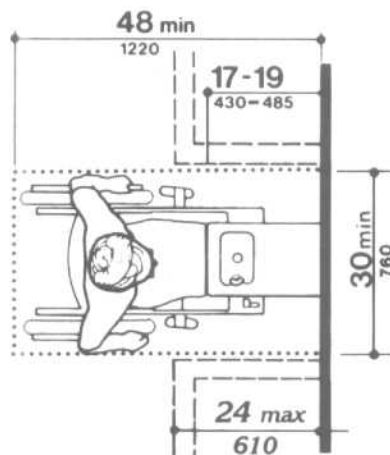


ACCESSORIES

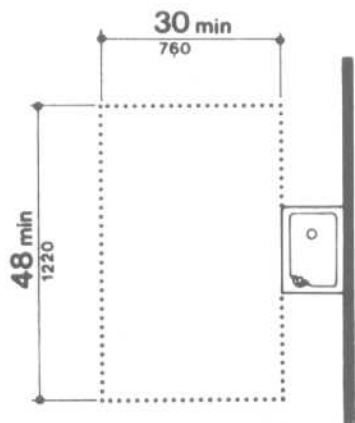
Accessible Drinking Fountains



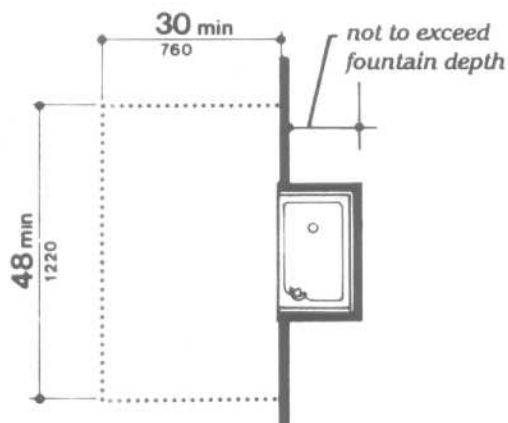
equipment permitted in shaded area  
 (a)  
 Spout Height and  
 Knee Clearance



(b)  
 Clear Floor Space



(c)  
 Free-Standing  
 Fountain or Cooler



(d)  
 Built-In  
 Fountain or Cooler

Drinking Fountains and Water Coolers

# 5

## General Reference Data

Space planning	1106
Human factors	1110
Floor and wall covering	1122
Fabric	1130
Electrical	1132
Columns, capitals, and entablatures	1135
Nails, screws, and bolts	1136
Mathematical data and formulas	1139



This section provides a variety of time-saving reference material in the form of tables, charts, formulas, and planning guidelines. Included are area requirements for the preliminary space planning of various building types and human factors data related to anthropometrics, space, and acoustics. Also included are a number of tables for determining carpet and wall covering yardage quantities. In addition, a series of tables dealing with electrical data provides typical amperage ratings for office and electronic equipment and for residential appliances. Still other tables and charts contain mathematical data relative to functions of numbers, metric system conversions, and areas of plane figures.

**SPACE PLANNING**

Area Requirements By Use

The first portion of Table 1 shows some of the planning guidelines for several types of office use. Of course, usable areas per employee vary greatly depending on the type of work performed and types of support space and common areas required, such as file rooms, data processing, conference rooms, and so forth.

**Rules of Thumb**

*Office use:* 125 to 150 net sq. ft. area per person.

*Retail space:* 30 net sq. ft. per person on ground floor; 50 net sq. ft. per person on upper floors.

*Classrooms:* 20 net sq. ft. per pupil.

**TABLE 1 Space Planning By Building Type**

Building/Use Type	Sq. Ft. per Unit		Area Basis	
Office buildings, all types	100-250	net	usable	
Work station, minimum clerical	40	person	usable	
Work station, clerical with VDT	55	person	usable	
Work station, with visitor space	65	person	usable	
Work station, supervisor	100	person	usable	
Manager, private office	150-225	person	usable	
Law firm	450	attorney	total usable	
Law firm library	25-30	attorney	usable	
Law firm conference	25-30	attorney	usable	
Insurance company, branch	100 average	work station	usable	
Insurance company, branch	155-165	employee	total usable	
Total, includes common areas and circulation				
Energy company	255	employee	total usable	
Conference and dining rooms	15	person	net	
<b>Restaurants</b>				
Dining areas (includes dining room but not waiting, coat room, etc.)				
Banquet	10-15	seat	net	
Cafeteria, college	12-15	seat	net	
Cafeteria, commercial	16-18	seat	net	
Counter service	18-20	seat	net	
Table service, hotel or restaurant	15-18	seat	net	
Table service, minimum	11-14	seat	net	
<b>Kitchens</b>				
<i>Meals per Hour</i>				
Type	< 200	200-400	400-800	800-1300
Cafeterias	7.5-5.0	5.0-4.0	4.0-3.5	3.5-3.0
Hotels	18.0-4.0	7.5-3.0	6.0-3.0	4.0-3.0
Restaurants	7.0-4.0	5.0-3.6	5.0-3.6	5.0-3.0
Serving and service areas				
Cafeterias		6	person	net
Restaurants		5	person	net
Add to totals space for food storage, administration, waiting.				

TABLE 1 Space Planning By Building Type (Continued)

Building/Use Type	Sq. Ft. per Unit		Area Basis
Night clubs	25	person	net
Bars	18	person	net
Hotel			
1.5 persons per room without extensive conferencing facilities	550-600	room	gross
	<b>Retail</b>		
Large stores	30-50	person	net
	<b>Cultural</b>		
Public library			
Stack space	0.08	bound vols.	net
Reading rooms	20-35	user	net
Staff space	100	staff person	net
Overall	50	person	net
Museums, exhibition areas	15	person	net
Theater and assembly areas			
Seating area, fixed seats	7.5	seat	net
Seating, movable seating	15	seat	net
Theaters, fixed seating (Does not include stage, lobby, etc.)	8-12	seat	net
Stage/backstage	100%	seating area	
Performing arts theater			
Lobbies	3	person	net
Lobbies	30%	seating area	
<b>Educational</b>			
Elementary			
The following figures are based on the number of students in the particular space listed.			
Small classrooms	20-30	student	net
Library	40	student	net
Art room	40	student	net
Secondary			
The following figures are based on the number of students in the particular space listed.			
Cafeteria	12-15	student	1/3 of total
Small classrooms	20-25	student	net
Large classrooms	15	student	net
Art classrooms	50-60	student	net
Home economics	50-60	student	net
Laboratory classrooms	55-70	student	net
Library	40	student	20% of total
Music rooms	30-35	student	net
Physical education	125	student	net
Shops/vocational rooms			
small	50	student	net
Shops/vocational rooms wood, metal, etc.	120-140	student	net
University			
Classrooms, small	20	student	net
Classrooms, large	12-15	student	net

## SPACE PLANNING

## Area Requirements By Use

TABLE 1 Space Planning By Building Type (Continued)

Building/Use Type		Sq. Ft. per Unit	Area Basis
Lecture halls	9-12	seat	net
Dormitory, no dining	160	student	net
Dormitory, no dining	210-240	student	gross
Dormitory, dining	235-260	student	gross
Food service, table service	18-26	seat	net, all areas
Food service, cafeteria	14-19	seat	net, all areas
Laboratories	34-45	student	net
Laboratory storage	6-10	student	net
<b>Library</b>			
Book stacks, less than 300,000 volumes	0.10	volume	net
Book stacks, 300,000- 1,000,000 volumes	0.7-0.8	volume	net
Book stacks, over 1,000,000 volumes	0.5	volume	net
Reading, study (provide stations equal to 25% to 40% of student population):	25-35	station	net
	6.25-10	student	net
Total service space	25%	of reading	net
<b>Residential</b>			
Apartments	250	Occupant	net
<b>Senior citizen housing</b>			
Living units	300-380	1-person unit	net
Living units	350-425	2-person unit	net
Living units	400-600	unit	gross
Dining, lounge, lobby, administration, etc.	33%-45% of living unit space, gross area		
<b>Health Care Facilities</b>			
General hospital	1000	bed	gross
Medical center	1100	bed	gross

The above figures are based on *usable* square footage, which in the language of leasing includes the area within the boundaries of the leased space. Most building owners lease space based on the *rentable* area, which includes a tenant's prorated share of common areas such as toilet rooms, elevator lobby, public corridors, and so on. The multiplying figure can be obtained from the building owner, or a figure of 1.1 to 1.15 can be used as an estimated multiplying factor.

TABLE 2 Gross to Net Ratios for Common Building Types

Building Type	Multiplying Factor	Building Type	Multiplying Factor
Office	1.25-1.35	Library reading space	1.5
Retail	1.35	Museum	1.2
Bank	1.4	Theater	1.3-1.7
Restaurant, table service	1.4-1.5	School, classroom	1.5-1.65
Restaurant, cafeteria	1.5	School, dormitory	1.5-1.8
Bars, nightclubs	1.3-1.4	School, laboratory	1.7
Hotel	1.4-1.6	School, gymnasium	1.4-1.45
Public library	1.25-1.3	Apartment	1.25-1.5
Library stack space	1.1-1.3	Hospital	1.5-1.85



**LIBRARY PLANNING**

Libraries represent a unique building type in that a majority of space is devoted to housing books and not people. The number of volumes to be housed becomes the primary planning parameter, rather than numbers of people. For a detailed layout of book stacks, you can use the figures given in Table 3. For preliminary planning, the following general guidelines are useful.

**Rules of Thumb**

*Public library:* 12–18½ volumes per sq. ft.

*Law library:* 5–7 volumes per sq. ft.

To stack space, add a "configuration loss" of from 6% to 20%, to account for inefficiencies in stack layout.

*Minimum aisle between open stacks:* 3 ft. 0 in.

*Staff spaces:* 100 net sq. ft. per person.

*Reading room seating:* 15–35 sq. ft. per person plus 6% configuration loss.

*Net/gross multiplier:* 1.25.

Maximum of 15,000–20,000 sq. ft. per floor.

**Example** A 100,000 volume public library is planned. How much space should be devoted to open stacks?

Plan about 15 volumes per sq. ft. ( $100,000 \div 15 = 6667$  sq. ft.). Add a configuration loss of 10%, to give a total area of  $6667 + 667$ , or 7333 sq. ft. of stack space.

**TABLE 3 Library Shelving — Volumes per Linear Foot of Shelf Based on Subject**

(Standard stack section 3 ft wide x 7½ ft high with 7 shelves)

Subject	Volumes per foot of shelf	Volumes per single face section
Art (excluding oversize)	7	147
Circulating, nonfiction	8	168
Economics	8	168
Fiction	8	168
General literature	7	147
History	7	147
Law	4	84
Medical	5	105
Periodicals, bound	5	105
Public documents	5	105
Technical and scientific	6	126
Average for overall estimating		125

These figures should be reduced by at least 10% to avoid overcrowding and to allow for expansion.

**HUMAN FACTORS**

**Anthropometrics**

**APPROPRIATENESS**

It is essential, due to the many variables involved, that the data selected be appropriate to the user of the space or furniture to be designed. It becomes necessary, therefore, for the intended user population to be properly defined in terms of such factors as age, sex, occupation, and ethnicity. If the user is an individual, or constitutes a very small group, it may, in certain situations, be feasible to develop your own primary anthropometric data by actually having individual body measurements taken. Surely, if one is prepared to take the time to be fitted for a dress or a suit, one should be willing to spend the time to be fitted for an interior environment or components of that environment, particularly since, in most cases, the latter will reflect a far greater financial investment. The measurements, in the event individual data are generated, should, however, be taken with proper instruments by a trained observer. In situations where specific body dimensions or other data for a particular user population are unavailable, and both time and funds prevent undertaking sophisticated studies, an engineering anthropometrist can be consulted to discuss the statistical methods of obtaining the necessary information.

**"AVERAGE MAN" FALLACY**

As suggested previously, a very serious error in the application of data is to assume that the 50th percentile dimensions represent the measurements of an "average man" and to create a design to accommodate 50th percentile data. The fallacy in such an assumption is that by prior definition 50 percent of the group may suffer. There simply is no "average man." Depending on the nature of the design problem, the design should usually be conceived to accommodate the 5th or the 95th percentile, so that the greatest portion of the population is served.

Dr. H.T.E. Hertzberg, one of the country's most distinguished research physical anthropologists, in discussing the so-called average man, indicated, "there is really no such thing as an 'average' man or woman. There are men who are average in weight, or in stature, or in sitting height, but the men who are average in two dimensions constitute only about 7 percent of the population; those in three, only about 3 percent; those in four, less than 2 percent. There are no men average in as few as 10 dimensions. Therefore, the concept of the 'average' man is fundamentally incorrect, because no such creature exists. Work places to be efficient should be designed according to the measured range of body size."

**REACH, CLEARANCE, AND ADJUSTABILITY**

The selection of appropriate anthropometric data is based on the nature of the particular design problem under consideration. If the design requires the user to reach from a seated or standing position, the 5th percentile data should be utilized. Such data for arm reach indicates that 5 percent of the population would have an arm reach of short (or shorter) dimension, while 95 percent of the population, the overwhelming majority, would have longer arm reaches. If the design

in a reach situation can accommodate the user with the shortest arm reach, obviously it will function for the users with longer reaches as well; it is equally obvious that the opposite is not true, as shown in Fig. 1(a).

In designs where clearance is the primary consideration, the larger or 95th percentile data should be used. The logic is simple. If the design will allow adequate clearance for the users with the largest body size, it would also allow clearance for those users with smaller body size. Here, too, it can be seen from Fig. 1(b) that the opposite is not true.

In other situations it may be desirable to

provide the design with a built-in adjustment capability. Certain chair types, adjustable shelves, etc., are examples of such. The range of adjustment should be based on the anthropometrics of the user, the nature of the task, and the physical or mechanical limitations involved. The range should allow the design to accommodate at least 90 percent of the user population involved, or more.

It should be noted that all the foregoing examples were used primarily to illustrate the basic logic underlying the selection of the body dimensions involved and the particular percentiles to be accommodated. Wherever possible, however, it is naturally more desir-

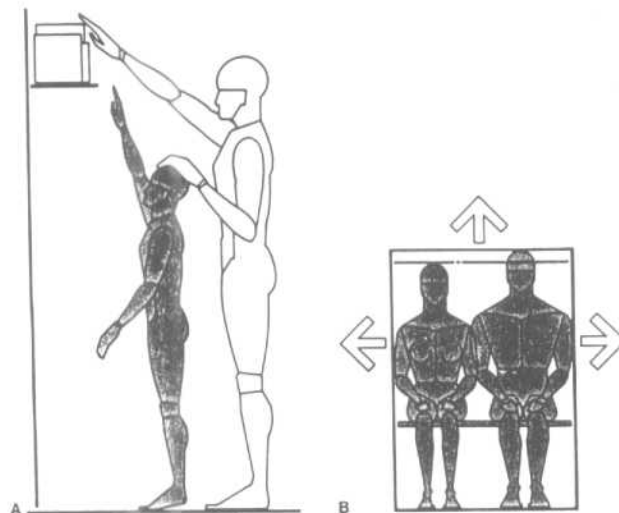


Fig. 1 (a) People of smaller body dimensions and, correspondingly, the lower-range percentile data should be used to establish dimensions where reach is the determining factor. (b) Larger-size people and, correspondingly, the high percentile range data should be used in establishing clearance dimensions.

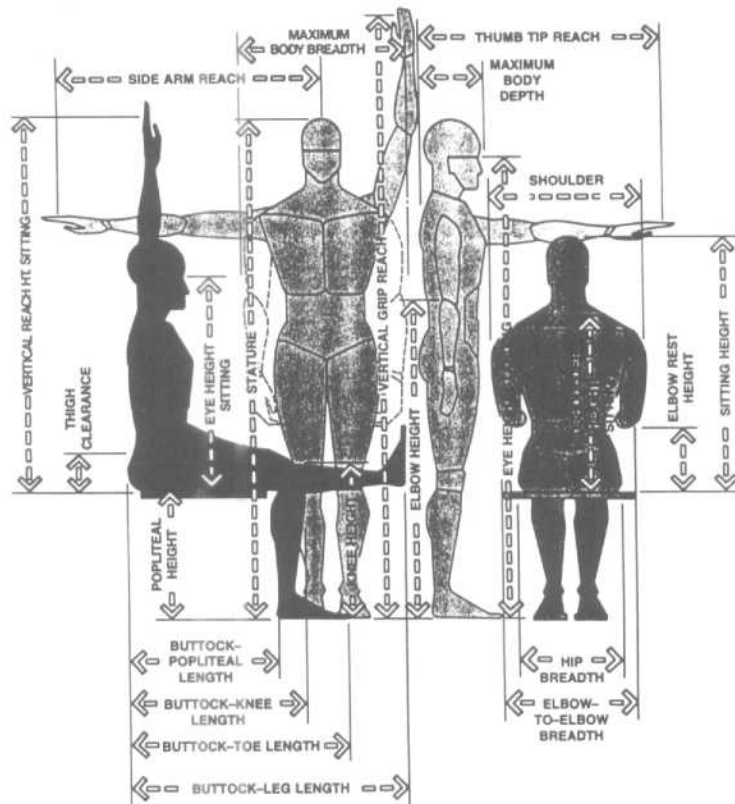
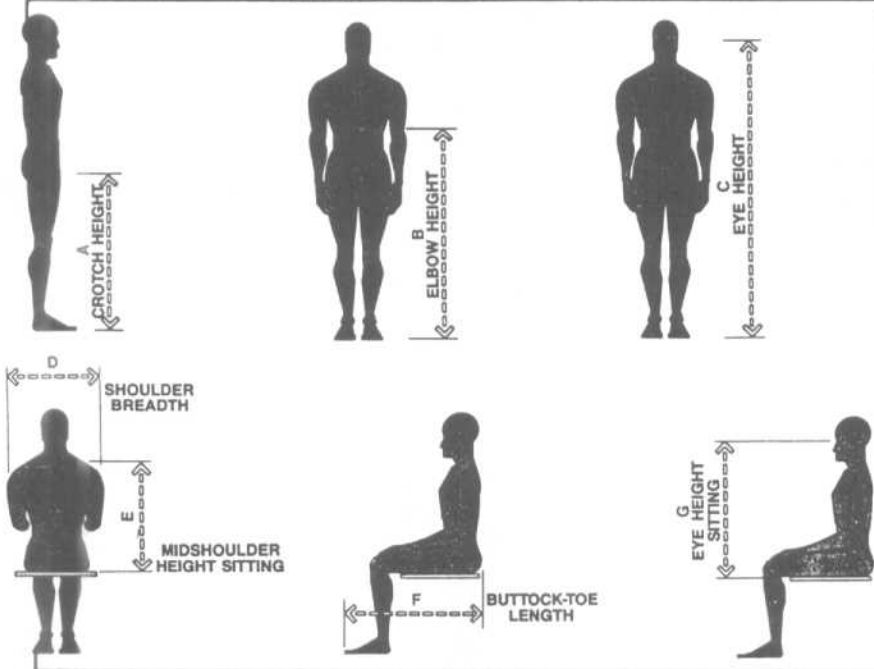


Fig. 2 Body measurements of most use to the designer of interior spaces.

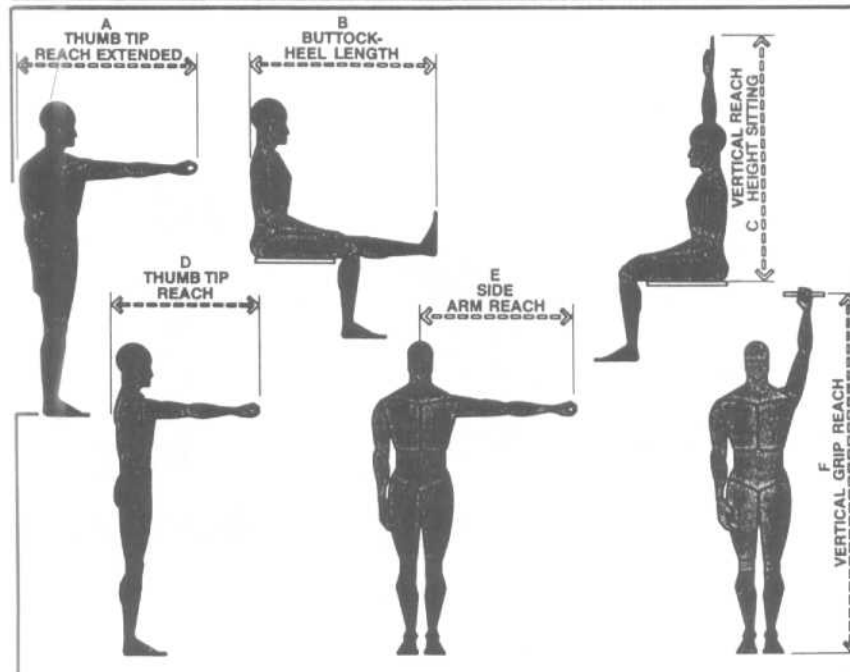
Adult Male and Female Miscellaneous Structural Body Dimensions in Inches and Centimeters by Age and Selected Percentiles

		A	B	C	D	E	F	G
		in cm	in cm	in cm	in cm	in cm	in cm	in cm
95	MEN	36.2 91.9	47.3 120.1	68.6 174.2	20.7 52.6	27.3 69.3	37.0 94.0	33.9 86.1
	WOMEN	32.0 81.3	43.6 110.7	64.1 162.8	17.0 43.2	24.6 62.5	37.0 94.0	31.7 80.5
5	MEN	30.8 78.2	41.3 104.9	60.8 154.4	17.4 44.2	23.7 60.2	32.0 81.3	30.0 76.2
	WOMEN	26.6 68.1	36.6 96.0	56.3 143.0	14.9 37.8	21.2 53.8	27.0 68.6	28.1 71.4



Adult Male and Female Functional Body Dimensions in Inches and Centimeters by Age, Sex, and Selected Percentiles

		A	B	C	D	E	F
		in cm	in cm	in cm	in cm	in cm	in cm
95	MEN	36.3 97.3	46.1 117.1	51.6 131.1	35.0 88.9	39.0 86.4	88.5 224.8
	WOMEN	36.3 92.2	49.0 124.5	49.1 124.7	31.7 80.5	38.0 96.5	84.0 213.4
5	MEN	32.4 82.3	39.4 100.1	59.0 149.9	29.7 75.4	29.0 73.7	76.6 195.1
	WOMEN	29.9 75.9	34.0 86.4	55.2 140.2	26.6 67.6	27.0 68.6	72.9 185.2



**HUMAN FACTORS**

**Anthropometrics**

able to accommodate the greatest percentage of the user population. In this regard, there is no substitute for common sense. If a shelf can just as easily be placed an inch or two lower, without significantly impacting on other design or cost factors, thereby accommodating 98 or 99 percent of the user population, obviously that is the correct design decision.

The clearances shown in Fig. 3 are intended to introduce general guidelines for barrier-free design. While we have utilized the wheelchair as our design subject, it does not represent the largest number of disabled. However, it is usually the most demanding for which to design. To provide practical limits for this design, we have chosen to plot the range of reach for the short female to the tall male. The overlapping areas of ability for the handicapped and the non-handicapped demonstrate the field of good design practice common to both.

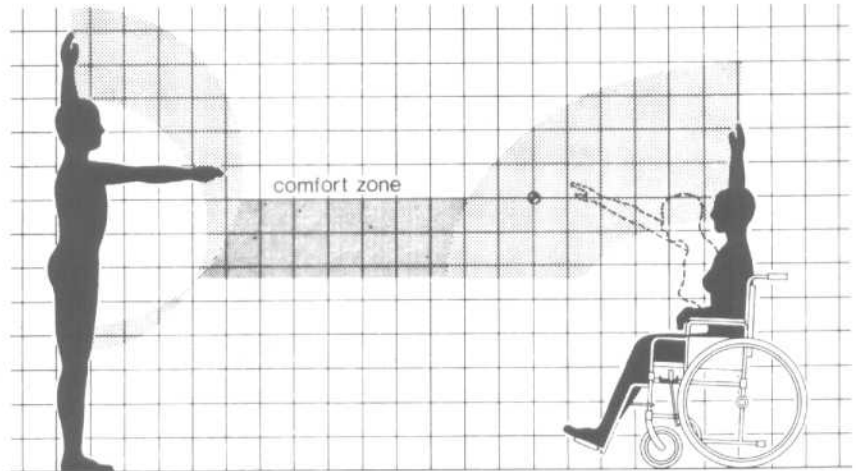
When planning for accessibility, it is important to consider the attitude at which the wheelchair approaches the object desired. Reach limits differ for frontal and side reach. Because of this, range of reach is plotted for each. The elevation targets represent the maximum height at which controls requiring manual dexterity should be located.

Wheelchairs vary in size. They are fitted to their users in much the same manner as clothing is. A range of sizes is given, with the dimensions for the "typical" collapsible, manual chair indicated. Electrically powered wheelchairs require more space. Further, the wheelchair must be considered in its "occupied" state, as the user imparts additional space requirements with arms and feet as well as basic maneuvering space.

We consider the basic space requirement for an occupied wheelchair to function to be 3 ft wide by 4 ft deep. This same space will accommodate most people who use canes, crutches, and walkers. Blind people using the cane technique for perceiving obstacles can also be accommodated in this space. For a person in a wheelchair to make a complete turn, an area of approximately 5 ft by 5 ft is required. As the elevations of surrounding surfaces change, so do the space requirements. The length of time that one is confronted by close quarters also affects the required clearance. An opening through a wall may be 2 ft 8 in clear as it represents only a short time involvement. As travel distance and traffic increase, passage width must also.

The complexity of space also affects minimum clearance. To make a simple 90° turn, adjoining passages 3 ft wide are required (and 3 ft 6 in preferred if a normal walking is to be maintained). A 180° turn around a fixed partition requires more space.

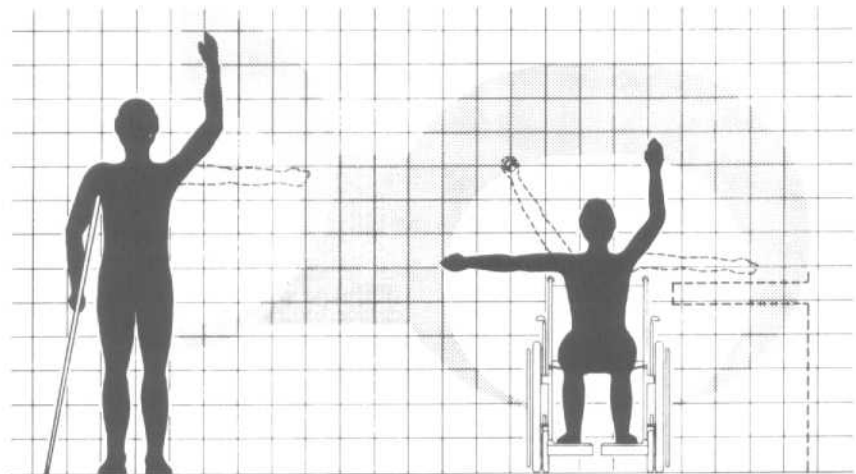
As clearances relate to general circulation requirements, space needs again increase with traffic speed and volume. Narrow corridors (4 ft) should be restricted to basically short, one-directional traffic patterns. Generally, maintain at least 5 ft clearances or more as determined by code.



**range of reach**

scale: 3/8" = 1'-0"

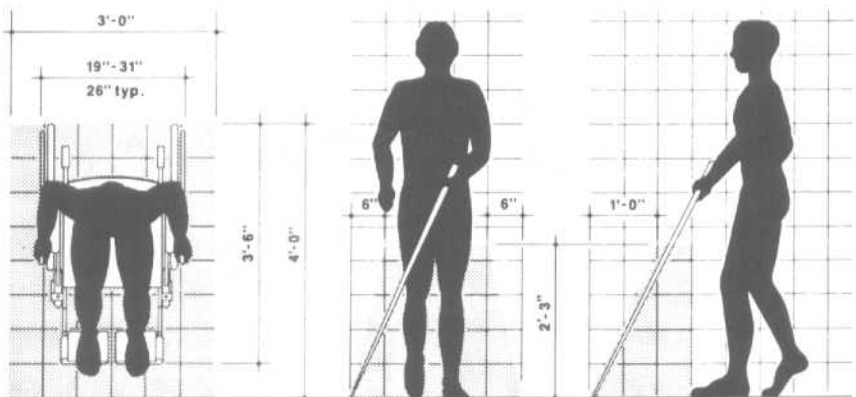
a  
1



**range of reach**

scale: 3/8" = 1'-0"

b  
1



**wheelchair**

scale: 3/8" = 1'-0"

c  
1

**cane technique**

scale: 3/8" = 1'-0"

d  
1

Fig. 3

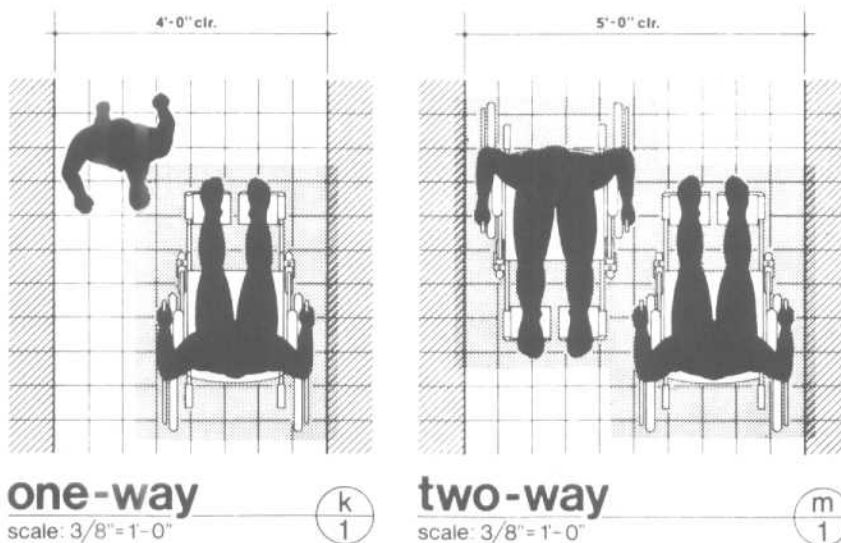
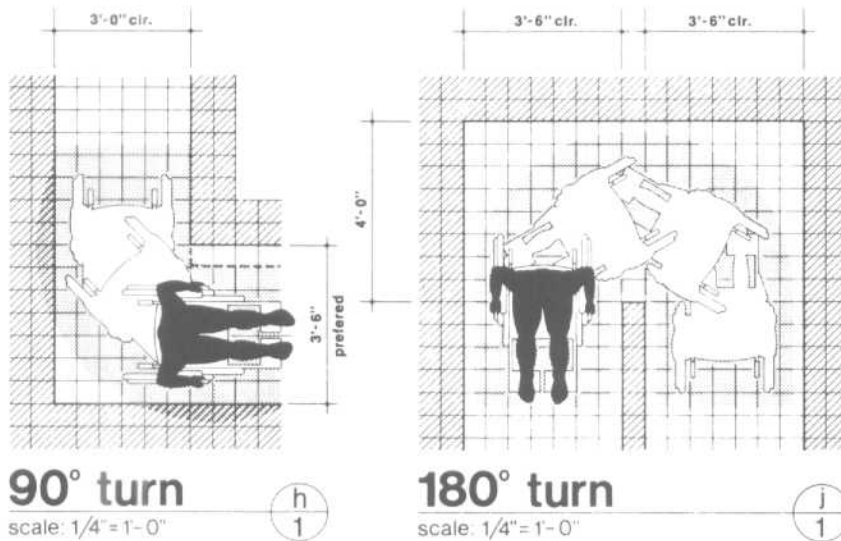
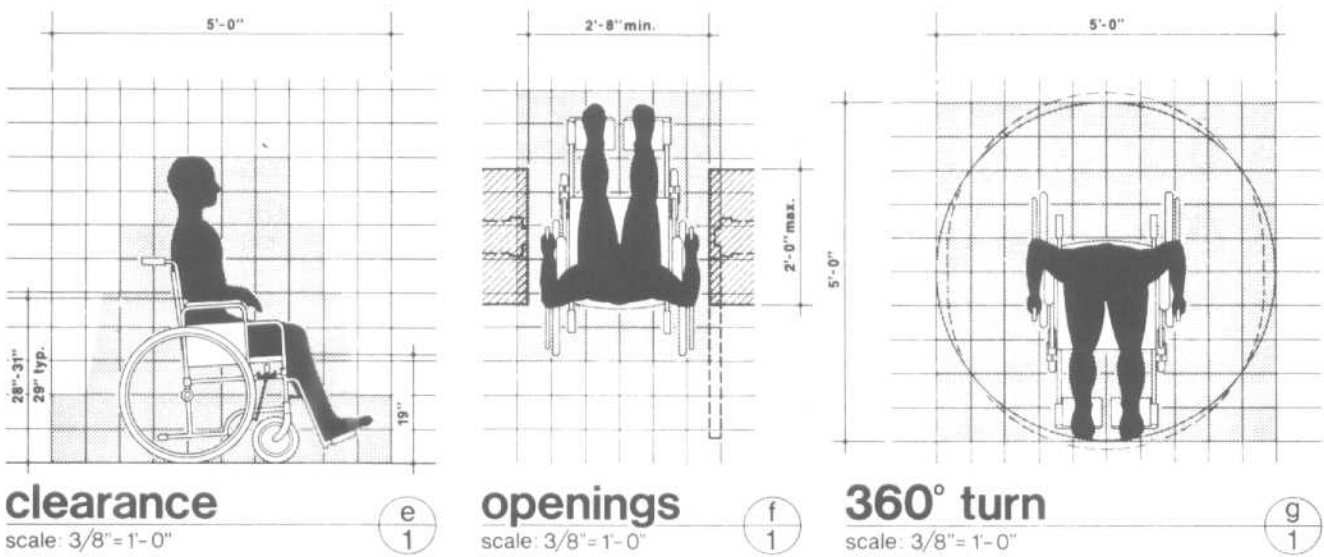


Fig. 3 (Continued)

**HUMAN FACTORS**

**Wheelchair Dimensions**

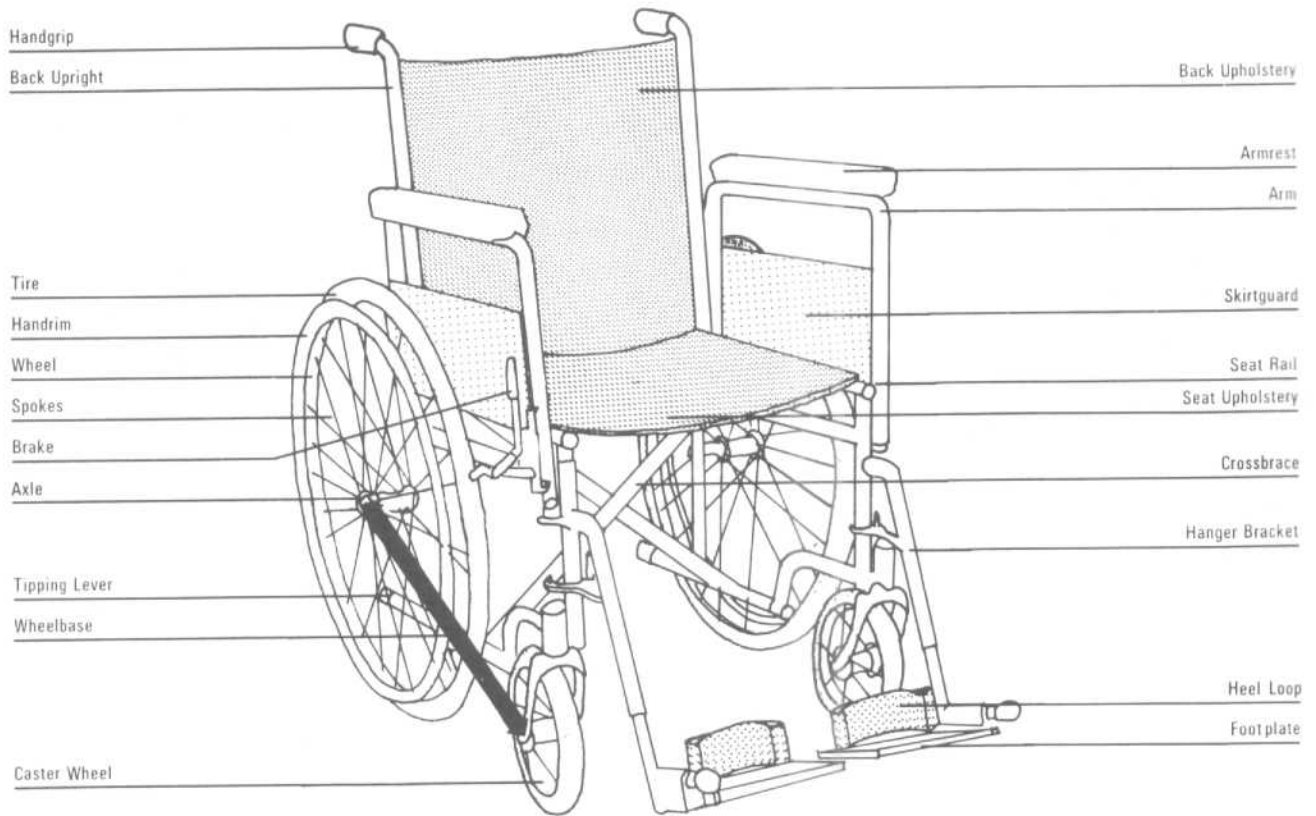
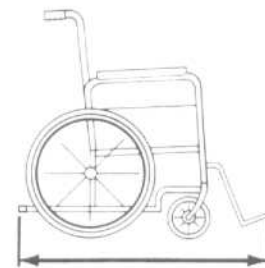
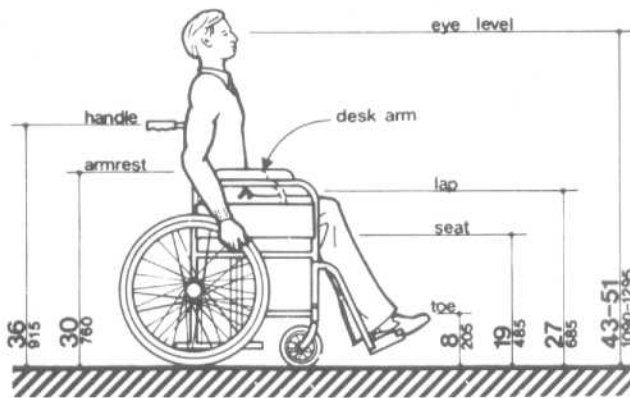
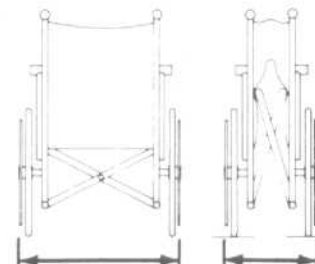
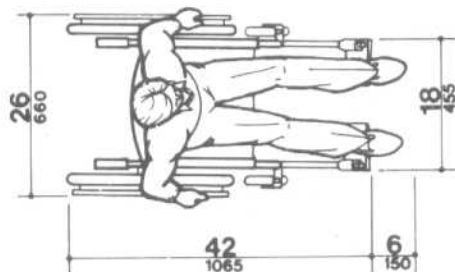


Fig. 4



Overall length: 40" to 50"



Width: open, 24" to 25"; closed, 10"

NOTE: Footrests may extend further for very large people.

Fig. 5 Dimensions of adult-sized wheelchairs.

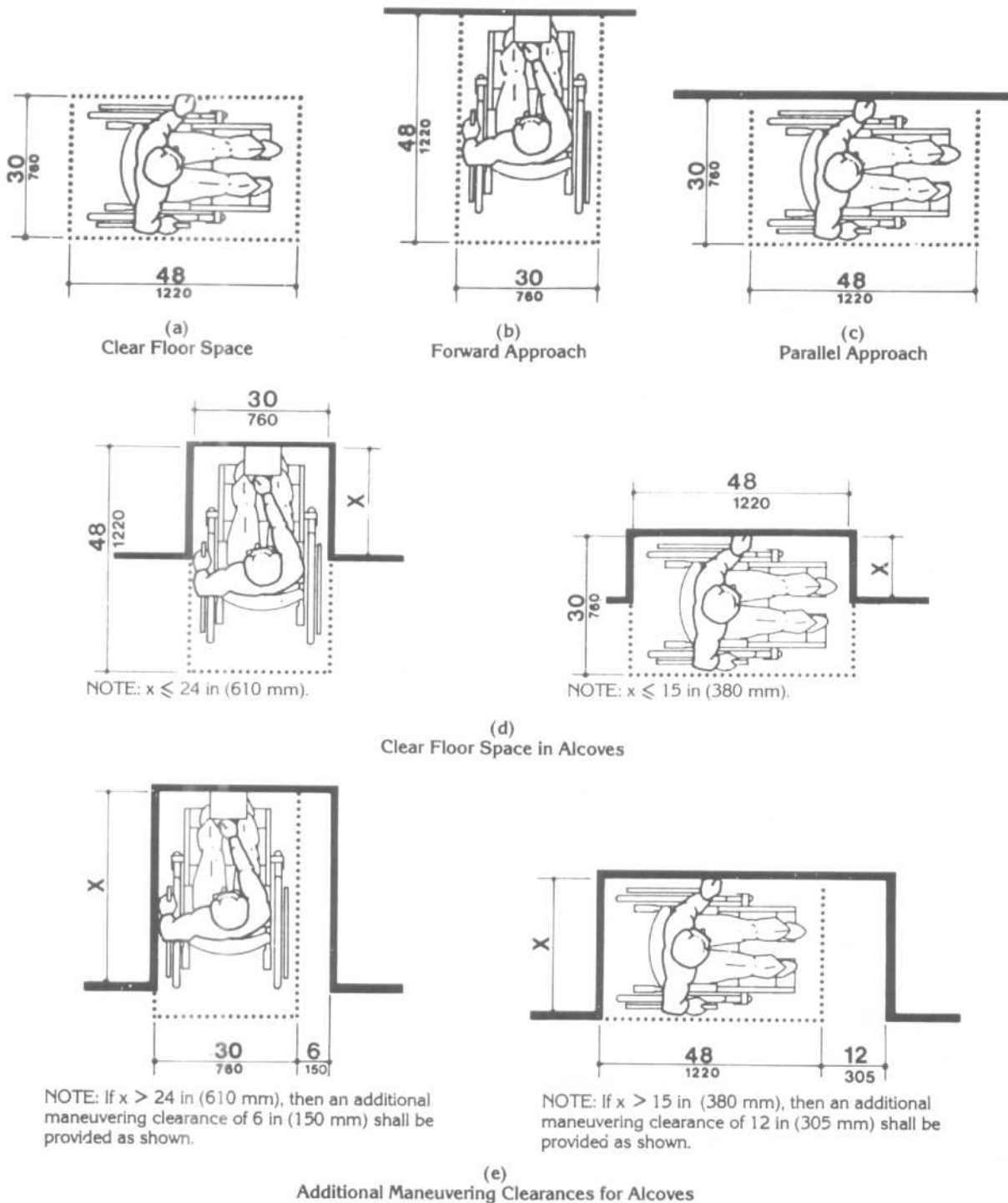
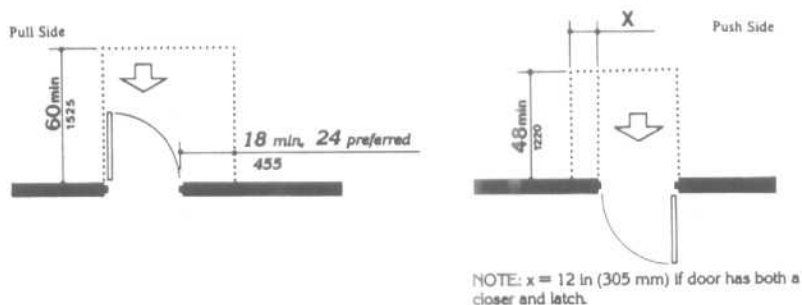


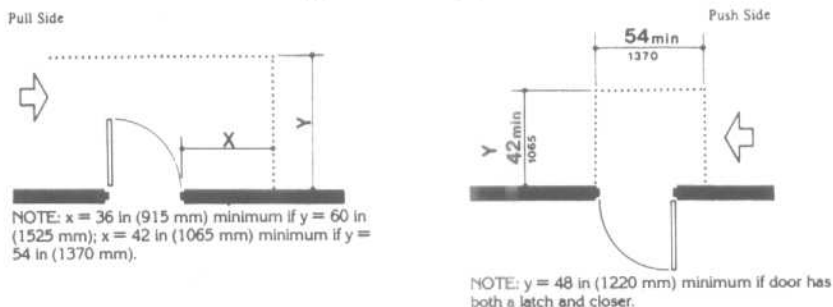
Fig. 6 Minimum clear floor space for wheelchairs.

HUMAN FACTORS

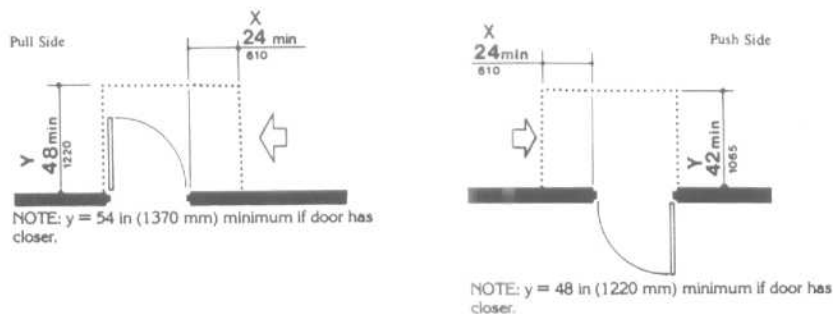
Wheelchair Clearances at Doors



(a) Front Approaches — Swinging Doors



(b) Hinge Side Approaches — Swinging Doors



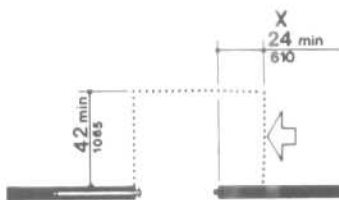
(c) Latch Side Approaches — Swinging Doors

NOTE: All doors in alcoves shall comply with the clearances for front approaches.



(d) Front Approach — Sliding Doors and Folding Doors

(e) Slide Side Approach — Sliding Doors and Folding Doors



(f) Latch Side Approach — Sliding Doors and Folding Doors

NOTE: All doors in alcoves shall comply with the clearances for front approaches.

Fig. 7 Maneuvering clearances at doors.



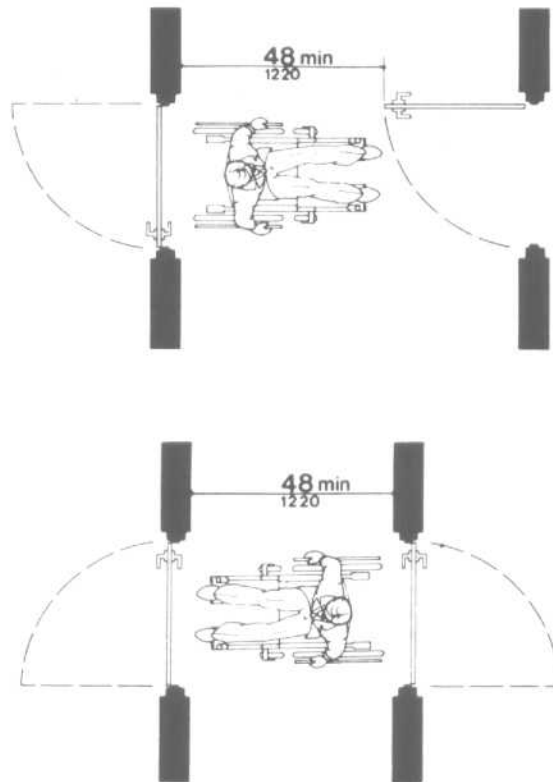


Fig. 8 Two hinged doors in series.

**HUMAN FACTORS**

Telephone Mounting Heights; Control Reach

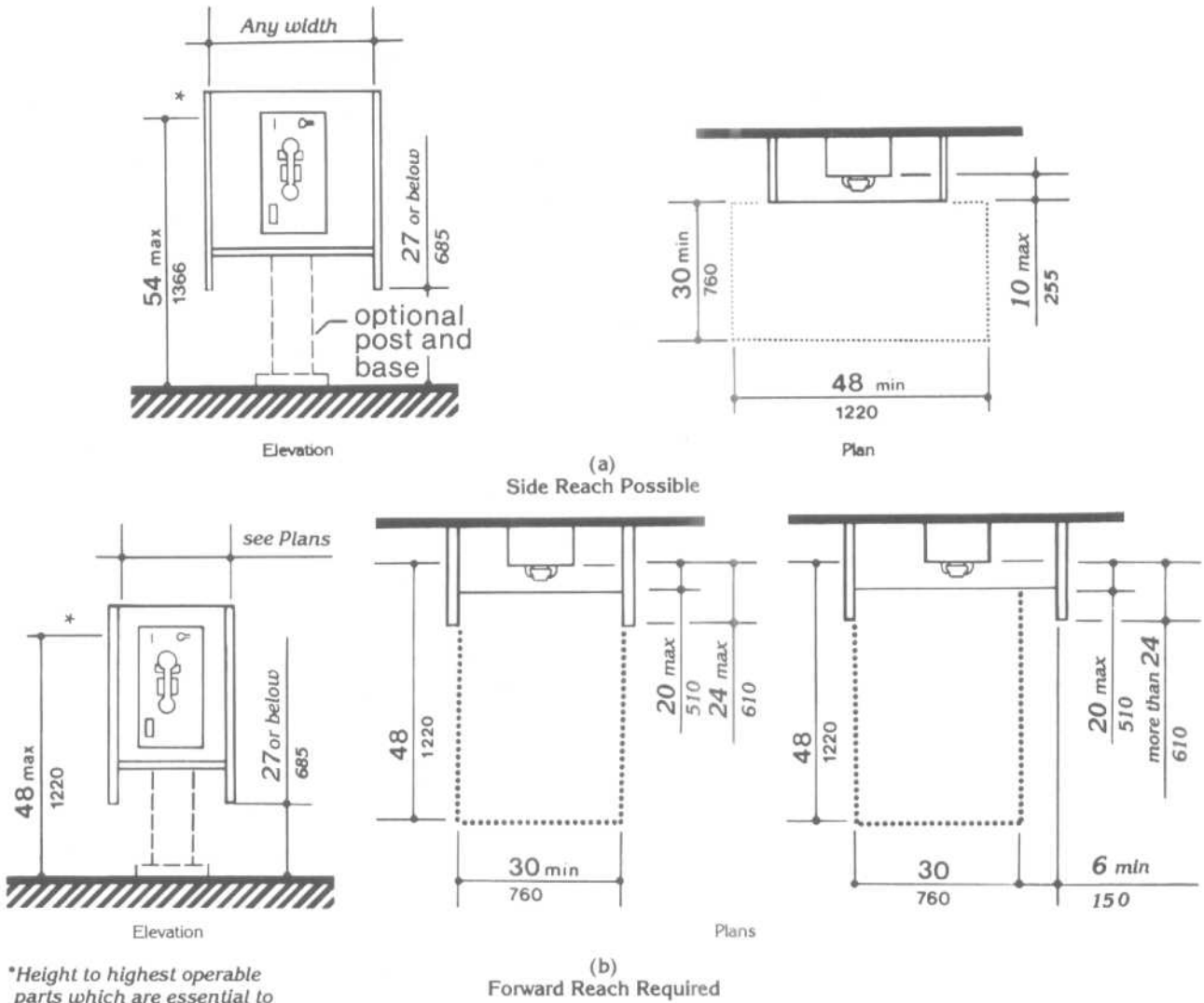


Fig. 9 Mounting heights and clearances for telephones.

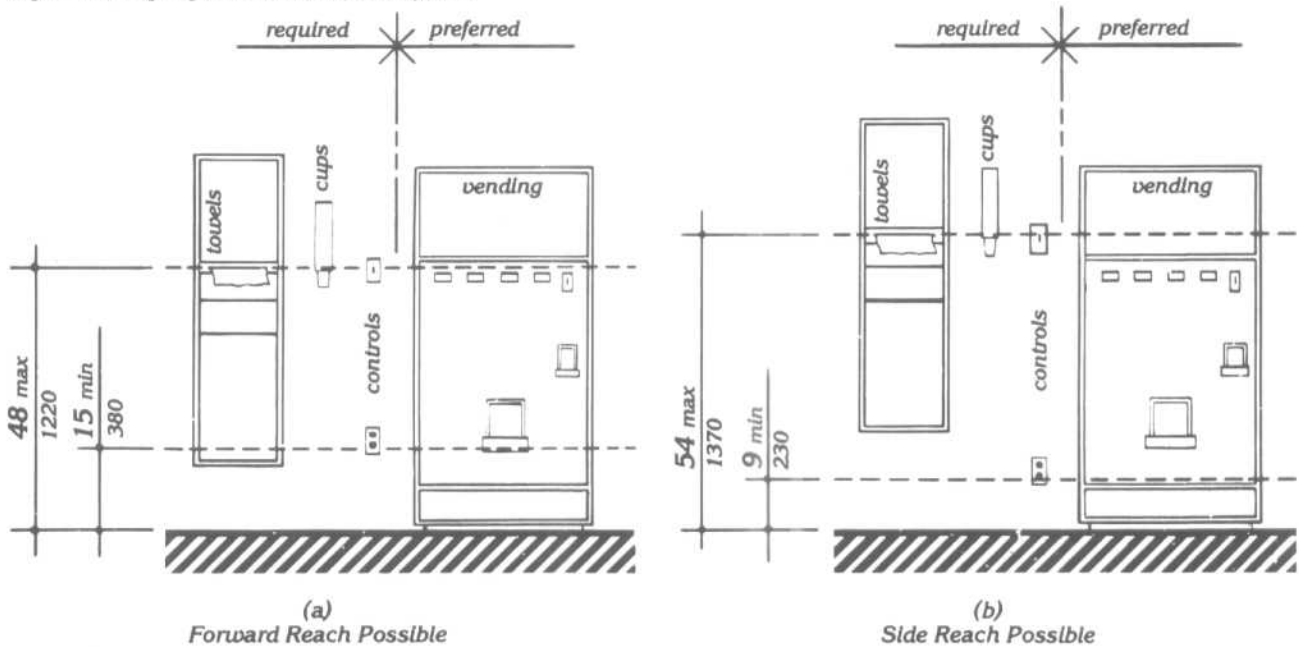


Fig. 10 Control reach limitations.

**TYPES OF SPACE**

Besides needing enough space in order to move about and perform various tasks, people react to space in a variety of ways. Several researchers have defined the space surrounding the individual in terms of the limits within which people categorically respond (see Figs. 11 and 12). *Intimate space* is that area in which a person tends not to allow anyone to intrude unless intimate relationships are expected. *Personal space* is that area within which a person allows only selected friends or fellow workers with whom personal discussion is mandatory. *Social space* is that area within which the individual expects to make purely social contacts on a temporary basis. And, finally, *public space* is that area within which the individual does not expect to have direct contact with others. Obviously, the more intimate the spatial relationship becomes, the more people resist intrusion by others. Personal space factors are important in establishing the privacy requirements for architectural design.

**Distance Relationships Among People (Hall)**

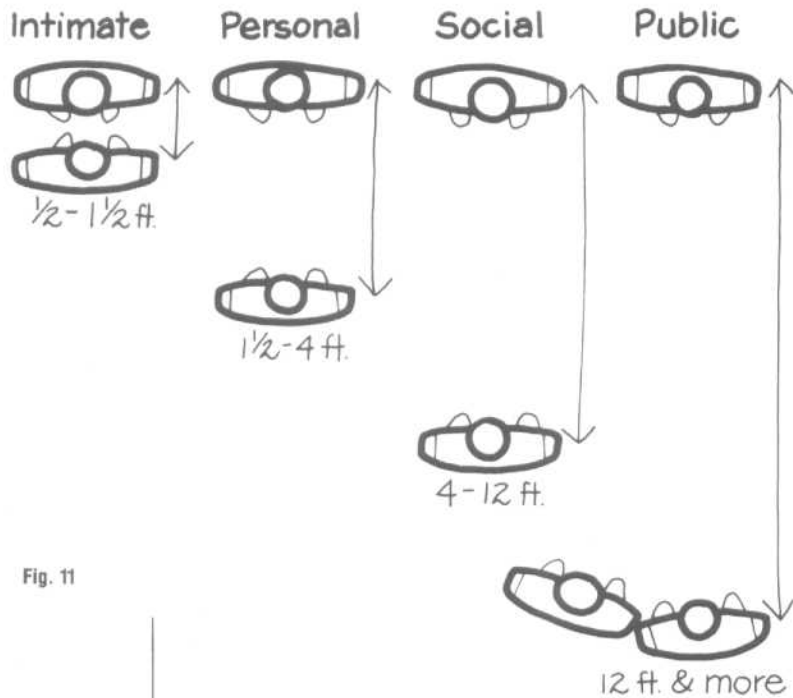


Fig. 11

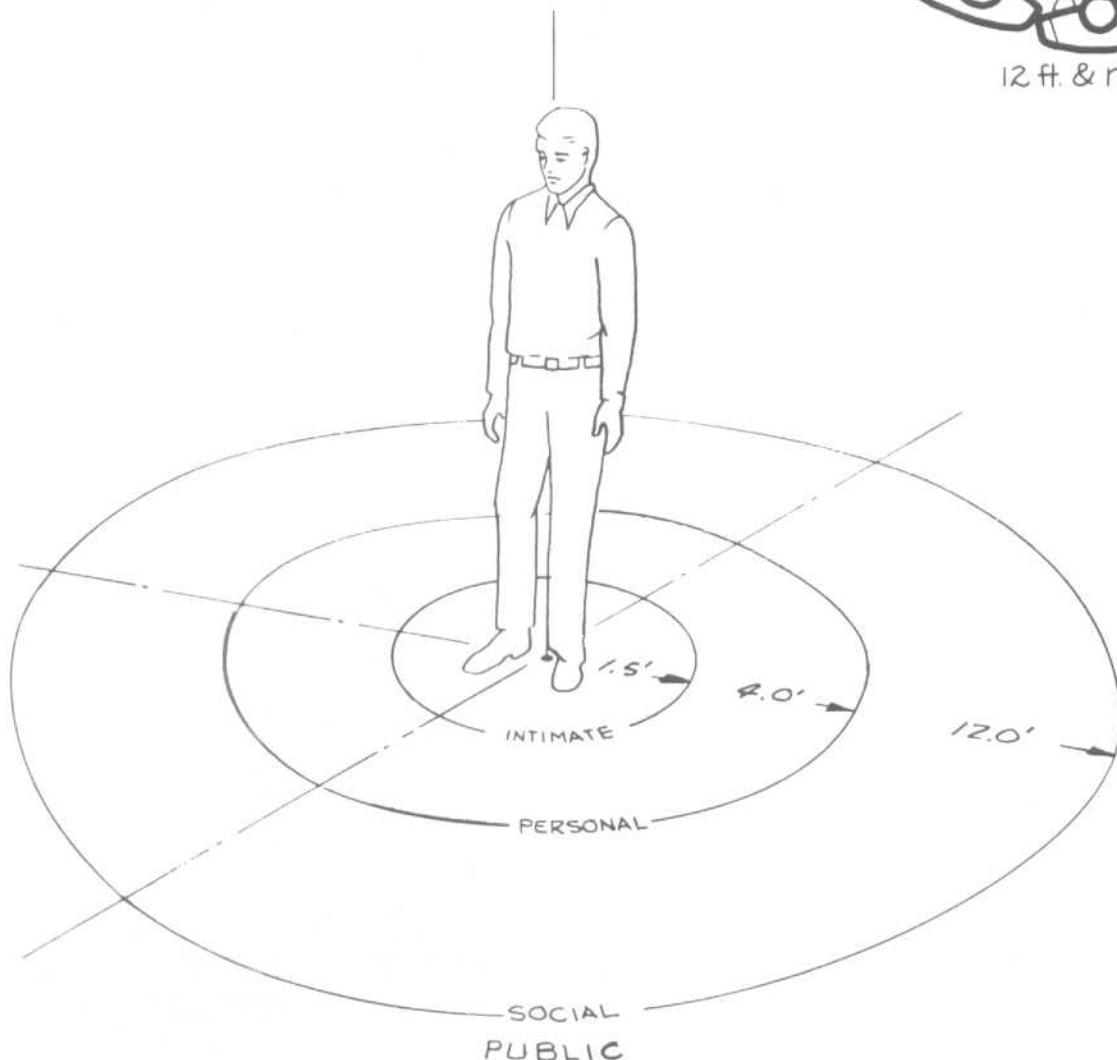


Fig. 12

## HUMAN FACTORS

## Space

TYPICAL SUBJECTIVE RESPONSES  
TO SELECTED SPATIAL FEATURES

Although few research data have been generated with regard to how people respond to specific spatial factors (at least in terms of being able to prescribe precise, quantitative guidelines), it is important for the designer to reflect on potentially negative reactions that often result when a given space is not made compatible with what the user expects in terms of the size, shape, organization, color, and illumination of a particular space. The considerations listed in Table 4 are suggested as a checklist for the designer.

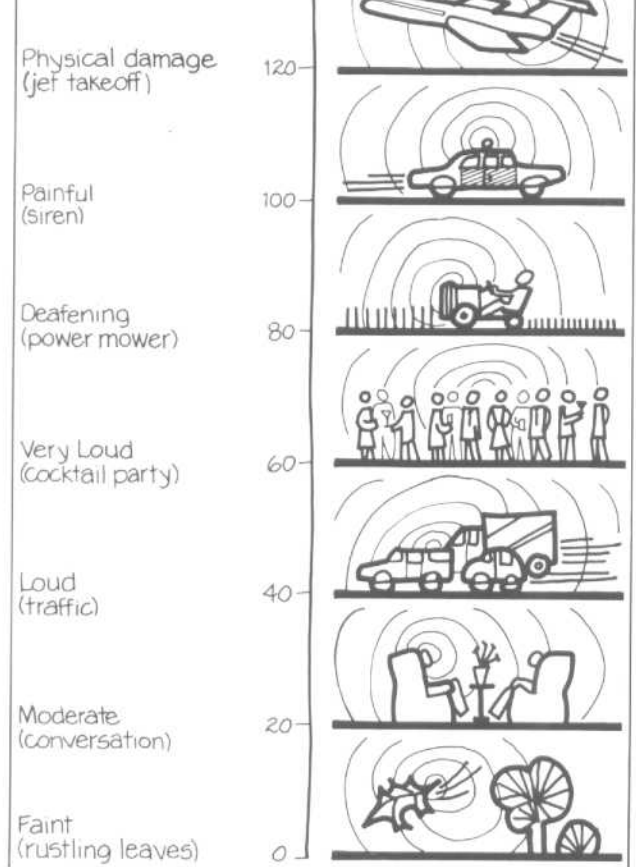
TABLE 4

Space Characteristic	Probable Response
Size (generally volume)	If the space is too small for the number of people, furnishings, equipment, or other objects that occupy it, people will consider it to be crowded. Although they may accept a crowded condition on a temporary basis, they will object to living or working in such a space for extended periods of time. If the space is too large for the people, furnishings, equipment, or other objects that occupy it, people will consider it "unfriendly," inconvenient, and/or overly demanding in terms of communicating, travel distance, maintenance, etc. Although they may accept the "barnlike" atmosphere for temporary periods, they will object to living or working in such a space for extended periods of time.
Shape (generally proportion)	If the space is out of proportion (too narrow, wide, long, high, etc.) for the intended use, people will consider it awkward and often distracting or oppressive. Although they may accept proportional distortion on a short-term basis (i.e., as they pass through briefly), they will object to living or working in such a space for extended periods of time. If the space contains such distortions as all curved surfaces, acute wall junctures, and too many projections or surface changes, people will consider it confusing and difficult to maneuver in and/or furnish. Although they may accept such distortions (or even consider them interesting) on a temporary or one-time basis, they will object to living or working in such a space for extended periods of time. It should also be noted that blind people depend on the constant proportions of right-angle corners to aid them in negotiating a space; such individuals are easily confused by curved surfaces, walls that are not at right angles, and periodic projections that imply they may have reached a turning point. When a ceiling is extremely high relative to the lateral dimension of a space, people feel as though they are working in a pit and that the walls are closing in on them. When a ceiling is extremely low and the space in front of the observer is very long, people feel as though the room is "endless" or as if they will hit their heads unless they duck.
Color and illumination	If a space is dark (unless this is required for a particular operation, such as a motion picture presentation), people tend to become lethargic and less active, or they may feel anxious. As a rule, the less bright a room is, the less cheerful it seems. A small space will seem even smaller. If a space is too bright, people will feel overly exposed, or they will complain of glare or thermal discomfort (even though actual glare in terms of accepted light levels or inappropriate thermal conditions for comfort are not present). If there are too many different colors, too large expanses of very saturated color, or too many and too "busy" patterns of color within a space, most people become irritated after more than a brief exposure to the space. If there is too little color, no visual pattern, or no other decorative "break" in the visual environment, people will find the space monotonous, boring, and eventually irritating to the point of wanting to escape. Although isolated points of highly reflective surface provide interest, all-metallic and highly reflective surface treatments create both subjective and directly objective interference for most people who have to work in the space.
Windows	Generally, most people do not like to live and work in a space that is devoid of windows. First and foremost, people seem to need visual contact with the outside world. Too many windows, on the other hand, can cause the following possible negative reactions: too much glare, too much exposure (fishbowl effect), lack of protection from outside elements, true anxiety (caused by floor-to-ceiling glass at high elevations).
Space organization	The internal components within a space and the traffic corridors and entrance and exit locations will seem either well organized or badly organized. The furnishings, partitions, decorative objects, etc., will appear as being either organized or disorganized, depending on the observer's ability to comprehend what things are and where they are with respect to his or her vantage point. Key behavioral response issues are: apparent capability to find one's way to specific locations, apparent ease for interacting and communicating with others with whom the individual must associate, apparent privacy provisions necessary to perform individual tasks. Although these are sometimes conflicting needs, the people who use a space will perform on the basis of how well each of these factors has been executed for them, not for the designer or the boss. The organization of internal space components obviously interacts with all the other space characteristics; i.e., the individual perceives and reacts to the combined effects of size, shape, color and illumination, windows, and organization simultaneously. A significant behavioral response will be an individual's interpretation of whether sufficient options are available for local modification of his or her own portion of the space. Even though people may never require a modification, they react to their own space in terms of permanently established restrictions that eventually elicit the feeling that the space is too small, the wrong shape, too dark, or isolated from the rest of the world, for example.
Furnishings	As a general rule, people are sensitive to improperly proportioned furniture, i.e., furniture that is too large, too small, or the wrong shape for the space in which it is placed. Although the designer normally tries to select furnishings that are properly proportioned for the space he or she has created, this may ultimately restrict the efficiency of the individual (e.g., a desk or storage cabinet may be too small). Thus, although the general visual proportions of furniture in relation to space must be taken into account to avoid negative observational responses, shortchanging the individual in terms of specific furniture and use requirements soon stimulates an even stronger negative response.

**TABLE 5 Comparison of Sound Pressure Levels and Loudness Sensations**

Sound Pressure Level (decibels—A scale)	Source	Sensation
130	Jet Aircraft at 100' Bass Drum at 3' Auto Horn at 3'	Physical Pain
110	Thunder, Artillery, Nearby Riveter	Deafening
100	Elevated Train Discotheque	
90	Loud Street Noise Noisy Factory	Very Loud
80	Truck Unmuffled Police Whistle	
70	Cocktail Party Noisy Office Average Street Noise	Loud
60	Average Radio Average Factory	
50	Noisy Home Inside General Office	Moderate
40	Face to Face Conversation Quiet Radio	
30	Quiet Home Private Office	Faint
20	Empty Auditorium Quiet Conversation	
10	Rustle of Leaves Whisper Soundproof Room	Very Faint
0	Threshold of Audibility	

**Decibel Scale for Sounds**



**Fig. 13**

**TABLE 6 Speech-Interference Levels that Barely Permit Reliable Conversation**

Distance between talker and listener, ft	Speech-interference level, dB			
	Normal	Raised	Very loud	Shouting
0.5	71	77	83	89
1.0	65	71	77	83
2.0	59	65	71	77
3.0	55	61	67	73
4.0	53	59	65	71
5.0	51	57	63	69
6.0	49	55	61	67
12.0	43	49	55	61

**TABLE 7 Speech Interference Levels (SIL) and Noise Criteria (NC) Recommended for Rooms**

Type of room	Maximum permissible level (measured in vacant rooms)	
	SIL	NC
Secretarial offices, typing	60	50-55
Coliseum for sports only (amplification)	55	50
Small private office	45	30-35
Conference room for 20	35	30
Movie theater	35	30
Conference room for 50	30	20-30
Theaters for drama, 500 seats (no amplification)	30	20-25
Homes, sleeping areas	30	20-25
Assembly halls (no amplification)	30	
Schoolrooms	30	25
Concert halls (no amplification)	25	15-20

**FLOOR AND WALL COVERING**

Length and Width of Carpet Roll Converted to Area

**TABLE 8 Length and Width of Carpet Roll Converted to Area**

Length, ft	Width of carpet roll									Width of carpet roll									
	9 ft			12 ft			15 ft			9 ft			12 ft			15 ft			
	ft <sup>2</sup>	yd <sup>2</sup>	m <sup>2</sup>	ft <sup>2</sup>	yd <sup>2</sup>	m <sup>2</sup>	ft <sup>2</sup>	yd <sup>2</sup>	m <sup>2</sup>	ft <sup>2</sup>	yd <sup>2</sup>	m <sup>2</sup>	ft <sup>2</sup>	yd <sup>2</sup>	m <sup>2</sup>	ft <sup>2</sup>	yd <sup>2</sup>	m <sup>2</sup>	
2	18	2	1.67	24	2.67	2.23	30	3.33	2.79	51	459	51	42.64	612	68	56.86	765	85	71.07
3	27	3	2.51	36	4	3.34	45	5	4.18	52	468	52	43.48	624	69.33	57.97	780	86.67	72.46
4	36	4	3.34	48	5.33	4.46	60	6.67	5.57	53	477	53	44.31	636	70.67	59.09	795	88.33	73.86
5	45	5	4.18	60	6.67	5.57	75	8.33	6.97	54	486	54	45.15	648	72	60.20	810	90	75.25
6	54	6	5.02	72	8	6.69	90	10	8.36	55	495	55	45.99	660	73.33	61.32	825	91.67	76.64
7	63	7	5.85	84	9.33	7.80	105	11.67	9.76	56	504	56	46.82	672	74.67	62.43	840	93.33	78.04
8	72	8	6.69	96	10.67	8.92	120	13.33	11.15	57	513	57	47.66	684	76	63.55	855	95	79.43
9	81	9	7.52	108	12	10.03	135	15	12.54	58	522	58	48.49	696	77.33	64.66	870	96.67	80.83
10	90	10	8.36	120	13.33	11.15	150	16.67	13.94	59	531	59	49.33	708	78.67	65.77	885	98.33	82.22
11	99	11	9.20	132	14.67	12.26	165	18.33	15.33	60	540	60	50.17	720	80	66.89	900	100	83.61
12	108	12	10.03	144	16	13.38	180	20	16.72	61	549	61	51	732	81.33	68	915	101.67	85.01
13	117	13	10.87	156	17.33	14.47	195	21.67	18.12	62	558	62	51.84	744	82.67	69.12	930	103.33	86.40
14	126	14	11.71	168	18.67	15.61	210	23.33	19.51	63	567	63	52.68	756	84	70.23	945	105	87.79
15	135	15	12.54	180	20	16.72	225	25	20.90	64	576	64	53.51	768	85.33	71.35	960	106.67	89.19
16	144	16	13.38	192	21.33	17.84	240	26.67	22.30	65	585	65	54.35	780	86.67	72.46	975	108.33	90.58
17	153	17	14.21	204	22.67	18.95	255	28.33	23.69	66	594	66	55.18	792	88	73.58	990	110	91.97
18	162	18	15.05	216	24	20.07	270	30	25.08	67	603	67	56.02	804	89.33	74.69	1005	111.67	93.37
19	171	19	15.89	228	25.33	21.18	285	31.67	26.48	68	612	68	56.86	816	90.67	75.81	1020	113.33	94.76
20	180	20	16.72	240	26.67	22.30	300	33.33	27.87	69	621	69	57.69	828	92	76.92	1035	115	96.15
21	189	21	17.55	252	28	23.41	315	35	29.26	70	630	70	58.53	840	93.33	78.04	1050	116.67	97.55
22	198	22	18.39	264	29.33	24.53	330	36.67	30.66	71	639	71	59.36	852	94.67	79.15	1065	118.33	98.94
23	207	23	19.23	276	30.67	25.64	345	38.33	32.05	72	648	72	60.20	864	96	80.27	1080	120	100.33
24	216	24	20.07	288	32	26.76	360	40	33.44	73	657	73	61.04	876	97.33	81.38	1095	121.67	101.73
25	225	25	20.90	300	33.33	27.87	375	41.67	34.84	74	666	74	61.87	888	98.67	82.50	1110	123.33	103.12
26	234	26	21.74	312	34.67	28.99	390	43.33	36.23	75	675	75	62.71	900	100	83.61	1125	125	104.52
27	243	27	22.57	324	36	30.10	405	45	37.63	76	684	76	63.55	912	101.33	84.73	1140	126.67	105.91
28	252	28	23.41	336	37.33	31.21	420	46.67	39.02	77	693	77	64.30	924	102.67	85.84	1155	128.33	107.30
29	261	29	24.25	348	38.67	32.33	435	48.33	40.41	78	702	78	65.22	936	104	86.96	1170	130	108.70
30	270	30	25.08	360	40	33.44	450	50	41.81	79	711	79	66.05	948	105.33	88.07	1185	131.67	110.09
31	279	31	25.92	372	41.33	34.56	465	51.67	43.20	80	720	80	66.89	960	106.67	89.19	1200	133.33	111.48
32	288	32	26.76	384	42.67	35.68	480	53.33	44.59	81	729	81	67.73	972	108	90.30	1215	135	112.88
33	297	33	27.59	396	44	36.79	495	55	45.99	82	738	82	68.56	984	109.33	91.42	1230	136.67	114.27
34	306	34	28.43	408	45.33	37.90	510	56.67	47.38	83	747	83	69.40	996	110.67	92.53	1245	138.33	115.66
35	315	35	29.26	420	46.67	39.02	525	58.33	48.77	84	756	84	70.23	1008	112	93.65	1260	140	117.06
36	324	36	30.10	432	48	40.13	540	60	50.17	85	765	85	71.07	1020	113.33	94.76	1275	141.67	118.45
37	333	37	30.94	444	49.33	41.25	555	61.67	51.56	86	774	86	71.91	1032	114.67	95.88	1290	143.33	119.84
38	342	38	31.77	456	50.67	42.36	570	63.33	52.95	87	783	87	72.74	1044	116	96.99	1305	145	121.24
39	351	39	32.61	468	52	43.48	585	65	54.35	88	792	88	73.58	1056	117.33	98.11	1320	146.67	122.63
40	360	40	33.44	480	53.33	44.59	600	66.67	55.74	89	801	89	74.41	1068	118.67	99.22	1335	148.33	124.03
41	369	41	34.28	492	54.67	45.71	615	68.33	57.13	90	810	90	75.25	1080	120	100.33	1350	150	125.42
42	378	42	35.12	504	56	46.82	630	70	58.53	91	819	91	76.09	1092	121.33	101.45	1365	151.67	126.81
43	387	43	35.95	516	57.33	47.94	645	71.67	59.92	92	828	92	76.92	1104	122.67	102.56	1380	153.33	128.21
44	396	44	36.79	528	58.67	49.05	660	73.33	61.32	93	837	93	77.76	1116	124	103.68	1395	155	129.60
45	405	45	37.63	540	60	50.17	675	75	62.71	94	846	94	78.6	1128	125.33	104.79	1410	156.67	130.99
46	414	46	38.46	552	61.33	51.28	690	76.67	64.10	95	855	95	79.43	1140	126.67	105.91	1425	158.33	132.39
47	423	47	39.30	564	62.67	52.40	705	78.33	65.50	96	864	96	80.27	1152	128	107.02	1440	160	133.78
48	432	48	40.13	576	64	53.51	720	80	66.89	97	873	97	81.10	1164	129.33	108.14	1455	161.67	135.17
49	441	49	40.97	588	65.33	54.63	735	81.67	68.28	98	882	98	81.94	1176	130.67	109.25	1470	163.33	136.57
50	450	50	41.81	600	66.67	55.74	750	83.33	69.68	99	891	99	82.78	1188	132	110.37	1485	165	137.96
										100	900	100	83.61	1200	133.33	111.48	1500	166.67	139.36

## FLOOR AND WALL COVERING

Covering Capacity of Wallpaper, Paint, and Tile

**TABLE 9 Paperhanging Walls and Ceilings**

Size of room, ft	Height of ceiling			Yards of border	Rolls of ceiling
	8 ft	9 ft	10 ft		
	Single rolls for walls				
4 × 8	6	7	8	9	2
4 × 10	7	8	9	11	2
4 × 12	8	9	10	12	2
6 × 10	8	9	10	12	2
6 × 12	9	10	11	13	3
8 × 12	10	11	13	15	4
8 × 14	11	12	14	16	4
10 × 14	12	14	15	18	5
10 × 16	13	15	16	19	6
12 × 16	14	16	17	20	7
12 × 18	15	17	19	22	8
14 × 18	16	18	20	23	8
14 × 22	18	20	22	26	10
15 × 16	15	17	19	23	8
15 × 18	16	18	20	24	9
15 × 20	17	20	22	25	10
15 × 23	19	21	23	28	11
16 × 18	17	19	21	25	10
16 × 20	18	20	22	26	10
16 × 22	19	21	23	28	11
16 × 24	20	22	25	29	12
16 × 26	21	23	26	31	13
17 × 22	19	22	24	28	12
17 × 25	21	23	26	31	13
17 × 28	22	25	28	32	15
17 × 32	24	27	30	35	17
17 × 35	26	29	32	37	18
18 × 22	20	22	25	29	12
18 × 25	21	24	27	31	14
18 × 28	23	26	28	33	16
20 × 26	23	28	28	33	17
20 × 28	24	27	30	34	18
30 × 34	27	30	33	39	21

Allowance for waste is included in all figures.  
 Deduct one roll for every 36 sq ft of openings.  
 Deduct one roll for every 2 doors.  
 Deduct for windows as area of each opening.  
 One roll of wallpaper equals 36 sq ft (24 ft by 18 in.).

**TABLE 10 Covering Capacity**

Material	Surface or use	Coverage per gallon, sq ft
Exterior Painting		
Priming paint	Wood	450
	Metal	500
Flat house paint	Over primer	500
	Repainting 1 coat	400
Oil paint	Masonry	300
	Concrete	250
	Stucco (smooth)	200
	Stucco (rough)	150
Stain	Wood shingle siding, first coat	150
	Wood shingle siding, second coat	200
Interior Painting		
Priming paint	Wood	500
Metal primer	Metal	600
Undercoat (enamel)	Over primer	400
Flat	Finish coat	500
Semigloss enamel	Finish coat	450
Satin-gloss enamel	Finish coat	450
Gloss enamel	Finish coat	400
Floor enamel	Floors	500
Aluminum paint	Aluminum, first coat	600
	Aluminum, second coat	700
Spar varnish	Finishing woodwork	600
Clear gloss varnish	Finishing woodwork	600
Lacquer	Over stain	450
Interior stain	Woodwork, first coat	500
	Woodwork, second coat	600
	Woodwork, third coat	700
Miscellaneous		
Barn red oil paint	Repaint barn	450
Rust inhibitor (zinc paint)	Metal	650
Furniture sealer and stain	Unpainted furniture	600

**TABLE 11 Flooring Tile**

(Net covering capacity per 100 sq ft)

Tile size, in.	No. of pieces per 100 sq ft	No. of pieces per sq ft
6 × 6	400	4.00
6 × 12	200	2.00
9 × 9	178	1.78
12 × 12	100	1.00
12 × 24	50	0.50
18 × 18	45	0.45
18 × 24	34	0.33
18 × 36	23	0.23
36 × 36	11	0.11

FLOOR AND WALL COVERING

Wall Areas of Rooms

TABLE 12 Wall Area of Rooms (8-ft ceiling), ft<sup>2</sup>

Feet	Feet								
	3	4	5	6	7	8	9	10	11
3	96	112	128	144	160	176	192	208	224
4	112	128	144	160	176	192	208	224	240
5	128	144	160	176	192	208	224	240	256
6	144	160	176	192	208	224	240	256	272
7	160	176	192	208	224	240	256	272	288
8	176	192	208	224	240	256	272	288	304
9	192	208	224	240	256	272	288	304	320
10	208	224	240	256	272	288	304	320	336
11	224	240	256	272	288	304	320	336	352
12	240	256	272	288	304	320	336	352	368
13	256	272	288	304	320	336	352	368	384
14	272	288	304	320	336	352	368	384	400
15	288	304	320	336	352	368	384	400	416
16	304	320	336	352	368	384	400	416	432
17	320	336	352	368	384	400	416	432	448
18	336	352	368	384	400	416	432	448	464
19	352	368	384	400	416	432	448	464	480
20	368	384	400	416	432	448	464	480	496
21	384	400	416	432	448	464	480	496	512
22	400	416	432	448	464	480	496	512	528
23	416	432	448	464	480	496	512	528	544
24	432	448	464	480	496	512	528	544	560
25	448	464	480	496	512	528	544	560	576

Feet	Feet								
	12	13	14	15	16	17	18	19	20
3	240	256	272	288	304	320	336	352	368
4	256	272	288	304	320	336	352	368	384
5	272	288	304	320	336	352	368	384	400
6	288	304	320	336	352	368	384	400	416
7	304	320	336	352	368	384	400	416	432
8	320	336	352	368	384	400	416	432	448
9	336	352	368	384	400	416	432	448	464
10	352	368	384	400	416	432	448	464	480
11	368	384	400	416	432	448	464	480	496
12	384	400	416	432	448	464	480	496	512
13	400	416	432	448	464	480	496	512	528
14	416	432	448	464	480	496	512	528	544
15	432	448	464	480	496	512	528	544	560
16	448	464	480	496	512	528	544	560	576
17	464	480	496	512	528	544	560	576	592
18	480	496	512	528	544	560	576	592	608
19	496	512	528	544	560	576	592	608	624
20	512	528	544	560	576	592	608	624	640
21	528	544	560	576	592	608	624	640	656
22	544	560	576	592	608	624	640	656	672
23	560	576	592	608	624	640	656	672	688
24	576	592	608	624	640	656	672	688	704
25	592	608	624	640	656	672	688	704	720

TABLE 13 Wall Area of Rooms (9-ft Ceiling), ft<sup>2</sup>

Feet	Feet								
	3	4	5	6	7	8	9	10	11
3	108	126	144	162	180	198	216	234	252
4	126	144	162	180	198	216	234	252	270
5	144	162	180	198	216	234	252	270	288
6	162	180	198	216	234	252	270	288	306
7	180	198	216	234	252	270	288	306	324
8	198	216	234	252	270	288	306	324	342
9	216	234	252	270	288	306	324	342	360
10	234	252	270	288	306	324	342	360	378
11	252	270	288	306	324	342	360	378	396
12	270	288	306	324	342	360	378	396	414
13	288	306	324	342	360	378	396	414	432
14	306	324	342	360	378	396	414	432	450
15	324	342	360	378	396	414	432	450	468
16	342	360	378	396	414	432	450	468	486
17	360	378	396	414	432	450	468	486	504
18	378	396	414	432	450	468	486	504	522
19	396	414	432	450	468	486	504	522	540
20	414	432	450	468	486	504	522	540	558
21	432	450	468	486	504	522	540	558	576
22	450	468	486	504	522	540	558	576	594
23	468	486	504	522	540	558	576	594	612
24	486	504	522	540	558	576	594	612	630
25	504	522	540	558	576	594	612	630	648

Feet	Feet								
	12	13	14	15	16	17	18	19	20
3	270	288	306	324	342	360	378	396	414
4	288	306	324	342	360	378	396	414	432
5	306	324	342	360	378	396	414	432	450
6	324	342	360	378	396	414	432	450	468
7	342	360	378	396	414	432	450	468	486
8	360	378	396	414	432	450	468	486	504
9	378	396	414	432	450	468	486	504	522
10	396	414	432	450	468	486	504	522	540
11	414	432	450	468	486	504	522	540	558
12	432	450	468	486	504	522	540	558	576
13	450	468	486	504	522	540	558	576	594
14	468	486	504	522	540	558	576	594	612
15	486	504	522	540	558	576	594	612	630
16	504	522	540	558	576	594	612	630	648
17	522	540	558	576	594	612	630	648	666
18	540	558	576	594	612	630	648	666	684
19	558	576	594	612	630	648	666	684	702
20	576	594	612	630	648	666	684	702	720
21	594	612	630	648	666	684	702	720	738
22	612	630	648	666	684	702	720	738	756
23	630	648	666	684	702	720	738	756	774
24	648	666	684	702	720	738	756	774	792
25	666	684	702	720	738	756	774	792	810



**FLOOR AND WALL COVERING**

Wall Areas of Rooms

**TABLE 14 Wall Area of Rooms (10-ft Ceiling), ft<sup>2</sup>**

Feet	Feet										Feet	Feet									
	3	4	5	6	7	8	9	10	11	12		13	14	15	16	17	18	19	20		
3	120	140	160	180	200	220	240	260	280	300	320	340	360	380	400	420	440	460	480		
4	140	160	180	200	220	240	260	280	300	320	340	360	380	400	420	440	460	480	500		
5	160	180	200	220	240	260	280	300	320	340	360	380	400	420	440	460	480	500	520		
6	180	200	220	240	260	280	300	320	340	360	380	400	420	440	460	480	500	520	540		
7	200	220	240	260	280	300	320	340	360	380	400	420	440	460	480	500	520	540	560		
8	220	240	260	280	300	320	340	360	380	400	420	440	460	480	500	520	540	560	580		
9	240	260	280	300	320	340	360	380	400	420	440	460	480	500	520	540	560	580	600		
10	260	280	300	320	340	360	380	400	420	440	460	480	500	520	540	560	580	600	620		
11	280	300	320	340	360	380	400	420	440	460	480	500	520	540	560	580	600	620	640		
12	300	320	340	360	380	400	420	440	460	480	500	520	540	560	580	600	620	640	660		
13	320	340	360	380	400	420	440	460	480	500	520	540	560	580	600	620	640	660	680		
14	340	360	380	400	420	440	460	480	500	520	540	560	580	600	620	640	660	680	700		
15	360	380	400	420	440	460	480	500	520	540	560	580	600	620	640	660	680	700	720		
16	380	400	420	440	460	480	500	520	540	560	580	600	620	640	660	680	700	720	740		
17	400	420	440	460	480	500	520	540	560	580	600	620	640	660	680	700	720	740	760		
18	420	440	460	480	500	520	540	560	580	600	620	640	660	680	700	720	740	760	780		
19	440	460	480	500	520	540	560	580	600	620	640	660	680	700	720	740	760	780	800		
20	460	480	500	520	540	560	580	600	620	640	660	680	700	720	740	760	780	800	820		
21	480	500	520	540	560	580	600	620	640	660	680	700	720	740	760	780	800	820	840		
22	500	520	540	560	580	600	620	640	660	680	700	720	740	760	780	800	820	840	860		
23	520	540	560	580	600	620	640	660	680	700	720	740	760	780	800	820	840	860	880		
24	540	560	580	600	620	640	660	680	700	720	740	760	780	800	820	840	860	880	900		
25	560	580	600	620	640	660	680	700	720	740	760	780	800	820	840	860	880	900	920		

General Reference Data

FLOOR AND WALL COVERING

Panel Conversion Chart

**TABLE 15 Standard Modular Panel Conversion Chart**

(For plywood, architectural woodwork, sheathing, plastic laminate, gypsum board, and other modular wall components)

No. of units	Size (areas in square feet)				No. of units	Size (areas in square feet)			
	4' x 8'	4' x 10'	4' x 12'	4' x 14'		4' x 8'	4' x 10'	4' x 12'	4' x 14'
10	320	400	480	560					
11	352	440	528	616	36	1152	1440	1728	2016
12	384	480	576	672	37	1184	1480	1776	2072
13	416	520	624	728	38	1216	1520	1824	2128
14	448	560	672	784	39	1248	1560	1872	2184
15	480	600	720	840	40	1280	1600	1920	2240
16	512	640	768	896	41	1312	1640	1968	2296
17	544	680	816	952	42	1344	1680	2016	2352
18	576	720	864	1008	43	1376	1720	2064	2408
19	608	760	912	1064	44	1408	1760	2112	2464
20	640	800	960	1120	45	1440	1800	2160	2520
21	672	840	1008	1176	46	1472	1840	2208	2576
22	704	880	1056	1232	47	1504	1880	2256	2632
23	736	920	1104	1288	48	1536	1920	2304	2688
24	768	960	1152	1344	49	1568	1960	2352	2744
25	800	1000	1200	1400	50	1600	2000	2400	2800
26	832	1040	1248	1456	51	1632	2040	2448	2856
27	864	1080	1296	1512	52	1664	2080	2496	2912
28	896	1120	1344	1568	53	1696	2120	2544	2968
29	928	1160	1392	1624	54	1728	2160	2592	3024
30	960	1200	1440	1680	55	1760	2200	2640	3080
31	992	1240	1488	1736	56	1792	2240	2688	3136
32	1024	1280	1536	1792	57	1824	2280	2736	3192
33	1056	1320	1584	1848	58	1856	2320	2784	3248
34	1088	1360	1632	1904	59	1888	2360	2832	3304
35	1120	1400	1680	1960	60	1920	2400	2880	3360

## FLOOR AND WALL COVERING

ESTIMATING THE AMOUNT OF HARDWOOD STRIP FLOORING REQUIRED

An allowance for side-matching, plus 5% for end-matching and normal waste are incorporated in these percentages.

Take the Square Footage and ADD the percentage below opposite the size strip flooring to be used.

When using	3/4x1-1/2" Strip	ADD	55%
	3/4x2"		42-1/2%
	3/4x2-1/4"		38-1/3%
	3/4x3-1/4"		29%
	3/8x1-1/2"		38-1/3%
	3/8x2"		30%
	1/2x2-1/2"		38-1/3%
	1/2x2"		30%

Above percentages are for laying flooring straight across the room. Additional flooring should be estimated for diagonal applications and bay windows or other projections.

-----

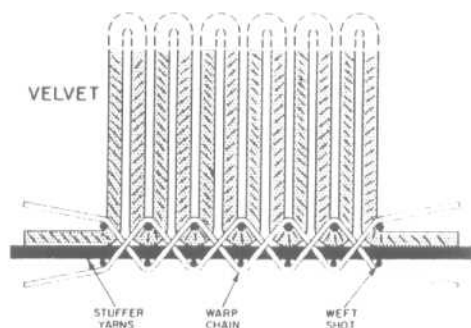
CONVERTING SQUARE FEET OF FLOOR SPACE

To Board Feet of Strip Flooring Required.

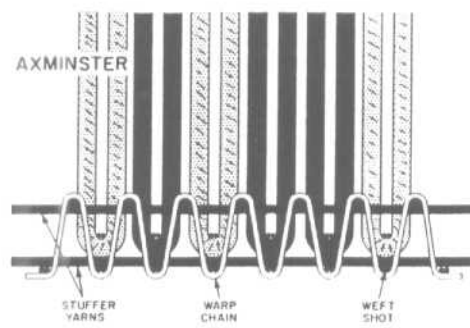
<u>FLOOR SPACE</u> Square Feet	<u>BOARD FEET REQUIRED (5% Cutting Waste Included)</u>				
	<u>3/4x2½"</u>	<u>3/4x1½"</u>	<u>3/4x3½"</u>	<u>1/2x2"</u>	<u>3/8x1½"</u>
5	7	8	6	7	7
10	14	16	13	13	14
20	28	31	26	26	28
30	42	47	39	39	42
40	55	62	52	52	55
50	69	78	65	65	69
60	83	93	77	78	83
70	97	109	90	91	97
80	111	124	103	104	111
90	125	140	116	117	125
100	138	155	129	130	138
200	277	310	258	260	277
300	415	465	387	390	415
400	553	620	516	520	553
500	692	775	645	650	692
600	830	930	774	780	830
700	968	1085	903	910	968
800	1107	1240	1032	1040	1107
900	1245	1395	1161	1170	1245
1000	1383	1550	1290	1300	1383

## FLOOR AND WALL COVERING

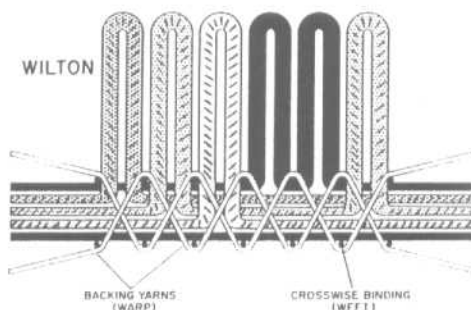
## Carpet Construction



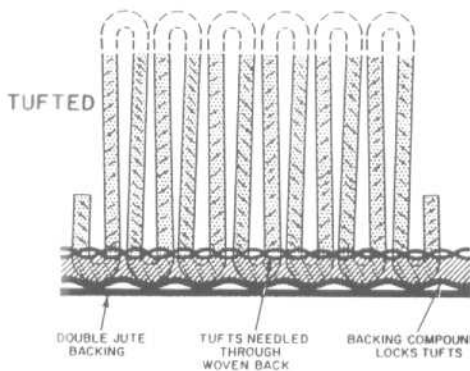
(a) Velvet weave



(c) Axminster weave



(b) Wilton weave



(d) Tufted process

Fig. 14

Carpets are manufactured in three different ways: woven, knitted, or tufted.

**Woven carpet** The surface pile and backing of woven carpet are interwoven at the same time, creating a single fabric. Due to the interweaving, which locks all of the yarns together in the single woven fabric, the pile yarns cannot be pulled out. Some carpet weaves presently available are velvet, wilton, and axminster. Velvet is best suited for solid-color carpet; however, tweeds, stripes, and salt-and-pepper effects can be produced on velvet looms. The usual velvet is a solid-color carpet with smooth surface and even pile. Sometimes the pile is cut to produce a plushlike surface [see Fig. 14(a)]. It may also be had in loop pile, or twist.

Wilton weave comes in almost unlimited numbers of textures and sculptured effects,

as well as patterns. The pile is sometimes cut, sometimes left uncut; a combination of cut and uncut may also be obtained. In multicolor wiltons, one color may be seen on the surface pile, while other colors are hidden in the body of the carpet. Embossed and sculptured effects are also made by the wilton looms, and cut and uncut pile can be combined with cut pile for the top level, with loops at other levels. Another variation is to have some pile yarn straight and others twisted [see Fig. 14(b)].

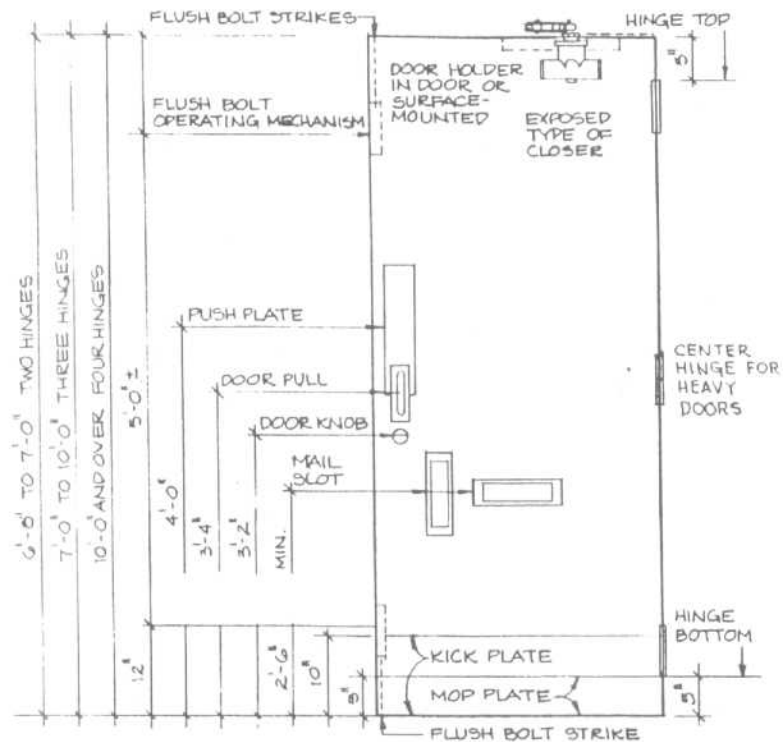
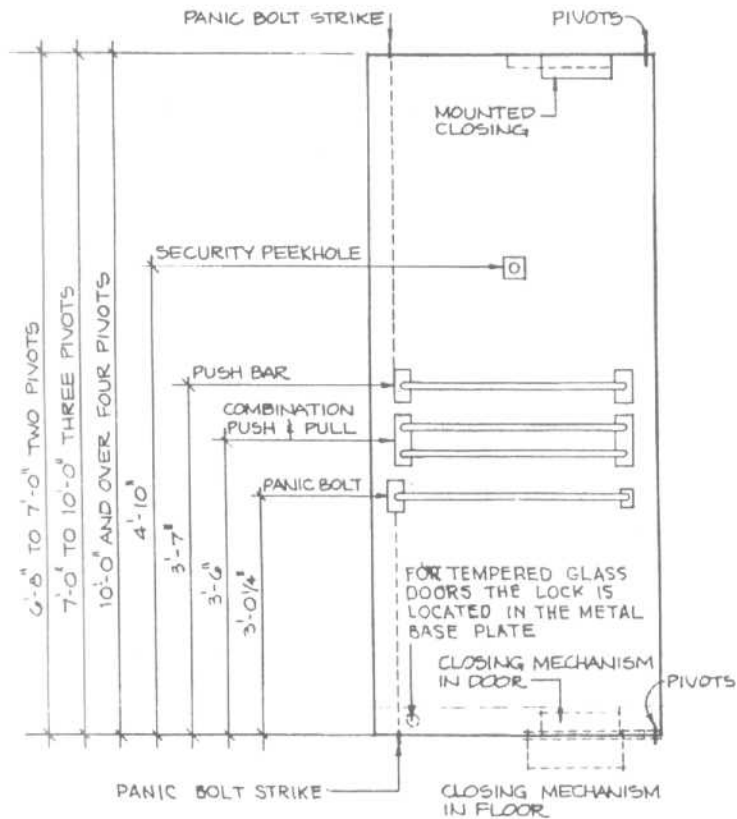
In the axminster weave, which is similar in appearance to handweaving, we find a complete flexibility in the use of color. In this method each tuft is inserted separately and while solid-color carpets can be made by this method, it is nearly always used for multicolored pattern carpet such as orientals, or

modern and geometric designs [see Fig. 14(c)].

**Tufted carpet** In the tufted process, which was only recently perfected, the tufts are attached to a previously made backing, as compared with the methods described above in which the backing and pile are integral. The tufts are held in place by a heavy coating of latex applied to the backing, which is usually cotton, jute, or kraft cord. By the use of this method, a wide variety of textures is possible. For example, the tufted pile can be made in several levels; it can be cut or uncut; and carved or striated effects can be obtained. The pile can be looped or plush. Tufted carpets are made in multicolor patterns with an increasing number of textural effects and refinements [see Fig. 14(d)].

FLOOR AND WALL COVERING

Location of Door Hardware



FINISH HARDWARE LOCATION FOR ALL TYPES OF DOORS

## FABRIC

## Characteristics and Suitability

## HOME-DECORATING FABRIC CHART

In the chart below are listed the fabrics usually classified as primarily decorating materials. In addition to these, practically all dress materials may be used, and are often woven in extra widths for this purpose. Among these are: light weight cottons such as cambric, challis, chambray, gingham, muslin, percale, poplin, seersucker, silklike oil used for informal draperies, bed coverings, dressing tables, etc.; stiff fabrics such as buckram and crinoline for interlining curtain tops, valances, etc.; cottons such as Canton flannel used for interlinings, and sateen for linings; heavy utility cottons such as crash, denim, drill, gabardine, pique, all suited to

certain types of draperies, couch covers, etc.; sheer cottons such as cheesecloth, dimity, plain and dotted Swiss, lace, lawn, organdy, voile, all used for glass curtains, bed coverings, etc.; pile fabrics such as corduroy, panne velvet, velour, velvet, velveteen, all excellent for upholstery, draperies, etc.; silk fabrics such as faille, moire (watered silk), pongee and shantung, satin, taffeta, all used for draperies, bed coverings, slipcovers, sometimes upholstery; sheer silks such as chiffon for glass curtains, lamp shades, etc.

FABRIC	DESCRIPTION	SUITABLE FOR
ARMURE	Ribbed silk, cotton, rayon (sometimes wool), fabric with small design on the surface.	Draperies. Medium-weight upholstery.
ARTIFICIAL LEATHER	Available under many trade names. A woven cotton fabric, coated with nitrocellulose preparation and stamped surface to simulate different kinds of leather.	Medium-weight upholstery. Panels. Other decorative uses.
BATIK	Javanese process of coloring fabrics by blocking out various parts of the pattern with wax before dyeing.	Curtains and panels. Other decorative effects.
BOBBINET	Net with hexagonal openings. Originally handmade with a bobbin.	Glass curtains. Dressing table skirts, etc.
BROCADE	Rich, colorful fabric with embroidery effects on taffeta, twill, satin or damask weave background. Gold or silver metal threads sometimes introduced in the figures. Brocade is also the name designating a certain type of Jacquard weave.	Draperies. Medium-weight upholstery. Especially good for rooms of Queen Anne, Chippendale, Hepplewhite or Sheraton furnishings of 18th Century.
BROCATELLE	A heavy fabric with general characteristics of damask, but figures more raised and velvety in quality giving embossed effect.	Draperies on very large studio-size windows. Heavy-weight upholstery.
BROCHE	Brocade with small floral pattern.	Lined or unlined draperies. Medium-weight upholstery.
BURLAP	Coarse, plain-weave fabric made of jute or hemp. Comes in variety of colors and widths. Inexpensive.	Drapery or upholstery purposes.
CALICO	Light-weight cotton fabric in plain weave. May be printed, plain or patterned, in deep colors. Designs usually small. (Also for dresses.)	Curtains, draperies, bedspreads, comfortables. Excellent with Early American or French Provincial furnishings.
CANDLEWICK	Cotton yarn used for hand tufting on muslin sheeting. Yarn may be white or in color and design simple or elaborate.	Bedspreads, draperies, and other decorative purposes.
CANVAS	A coarse, firm cotton or linen material, rough finish, plain weave. May be bleached, unbleached, starched, dyed, or printed.	Awnings, couch covers, etc.; also used for stiff interlining as at top of draperies.
CASEMENT CLOTH	Light, plain, and usually neutral in color. Made in cotton, linen, mohair, silk, wool or rayon. Sometimes comes in small figures.	Fine for draw-curtains; also glass curtains in sheer textures.
CELLOPHANE	Glossy, transparent synthetic product woven on warp threads of cotton. Often woven in with other materials and used for many novelty effects.	Draperies in modern interiors. Trimmings, etc.
CHENILLE	Various types of fabrics woven with chenille yarn of silk, wool, mercerized cotton, or rayon.	Draperies. Yarn used for tufting, fringes, etc.
CHEVRON CLOTH	Fabric with broken twill weave forming chevron pattern.	Draperies, etc.
CHINTZ	A firm plain weave cotton fabric usually printed in gay pattern, but may be had in plain colors. May be semi-gleazed or fully glazed. Some chintz has special finish so that it will retain glaze after washing. Glazed chintz is more resistant to dirt, while its shiny surface and stiff texture adds to its charm. There are many grades of chintz, and many have soil-resistant special finish.	May be formal or informal in pattern. Suitable to any room according to pattern, quality and treatment. Used for draperies, upholstery, slip covers, lamp shades, etc.
CRETONNE	Cotton or linen fabric named for French town of Creton, with plain, rep or damask weave background printed in large designs. Does not muss easily and can be washed often.	Draperies, upholstery, slip covers, bed covers, etc. Often more formal than chintz.
CREWEL EMBROIDERY	A type of wool embroidery worked on unbleached cotton or linen ground in large floral, bird, or tree designs.	Draperies and upholstery. Used extensively during Jacobean period.
DAMASK	The name originated with the beautiful silks woven in Damascus during the 12th Century. Damasks are now made of linen, cotton, wool, or any of the synthetic fibers, or combinations of the two. In taffeta weave on satin ground, this fabric in flat woven pattern is usually reversible. Damask is also the name given to a kind of Jacquard weave.	In silk or cotton it is used for draperies and upholstery. Appropriate for Queen Anne, Chippendale, Hepplewhite or Sheraton furnishings of 18th Century.
DRUID'S CLOTH	A fabric of loosely twisted cotton yarn, or cotton mixed with jute, in basket weave. Something like monk's cloth but not as rough in texture.	Draperies. Couch covers.
DUCK	Heavy plain weave cotton fabric.	Outdoor cushions, etc.
FELT	A material made by matting together, under heat or pressure, woolen fibers, mohair, cowhair, or mixed fibers.	Upholstery and couch covers. Rugs.

## HOME-DECORATING FABRIC CHART CONTINUED

FABRIC	DESCRIPTION	SUITABLE FOR
FILET NET	Cotton or linen net with square mesh. Hand netted filet has a knot at each corner of square mesh.	Curtains, tablecloths, scarves, etc.
FORTUNY PRINTS	Fabrics produced in Venice by a secret printing process which gives cotton cloth the effect of antique brocades and damasks. Comes in beautiful color combinations.	Draperies. Wall hangings, screens, etc.
FRIAR'S CLOTH	Like druid's cloth but with finer basket weave.	Same as druid's cloth.
FRISE	Uncut pile fabric of wool, mohair, cotton or linen. Patterns may be printed or produced by using yarns of different colors, or by cutting some of the loops to give sculptured effect. Very durable.	Upholstery.
GAUZE	Thin, sheer transparent fabric of plain weave, sometimes printed. May be all silk, or cotton, linen, wool, mohair, synthetic fibers, or combinations.	Glass curtains.
HAIR CLOTH	A fabric with warp of cotton, worsted, or linen, and horsehair weft, woven plain, striped or patterned. May now be obtained in colors and variety of woven designs.	Upholstery. Used extensively in England and America during middle of 19th Century.
HOMESPUN	Coarse hand-woven woolen, cotton or linen fabrics. Also trade name given to imitations made on power looms.	Curtains and upholstery in informal rooms. Bedspreads in cotton.
INDIA PRINTS	Printed cotton cloth with clear colors and characteristic designs of India or Persia. Handprinted with many colors on white or natural background.	Draperies. Wall hangings. Bed coverings, etc.
JASPE	Fabrics having warp threads of different colors giving material streaked or mottled effect, resembling jasper.	Draperies and other decorative effects.
LAME	A fabric with silk and metal threads in plain weave or with a woven pattern.	Drapery. Panels.
LAMPAS	A fabric similar to damask in appearance and brocattelle in weave. Generally all silk with multi-colored pattern on plain background, often classic in design.	Used as damask is used.
MARQUINETTE	Sheer cloth in gauze weave of cotton, silk, rayon, often with woven figure. It comes in wide range of colors, and may be dyed or printed.	Excellent for glass curtains. Fluffy, dainty, tailored spreads.
METALASSE	Fabric with brocaded pattern in raised, padded or blistered effect.	Draperies.
MOHAIR	Various types of fabrics made from the fleece of the Angora goat. Most durable of all textiles. Now woven in combination with cotton, linen, silk or wool into many types of plain, twill or pile fabrics.	Very durable and widely used for upholstery.
MONK'S CLOTH	Heavy cotton fabric of coarse basket weave.	Drapery material.
MOQUETTE	Pile fabric resembling frise, woven on Jacquard loom with small set pattern in different colors.	Used for upholstery in mohair, wool, or heavy cotton.
NINON	A semi-transparent fabric of silk or rayon.	Glass curtains.
PLUSH	High pile fabric resembling fur, made of silk, wool, cotton or any synthetic fiber. Pile may be cut or uncut.	Upholstery.
REP	Plain weave fabric of heavy rib made of silk, cotton or wool, or synthetic fibers. Unpatterned and reversible.	Draperies. Upholstery.
SAIL CLOTH	Stout, firm, plain weave cotton material similar to canvas in construction but lighter. Has a stiff, hard texture and is printed in gay, bright colors.	Draperies. Slip covers. Bedspreads, etc.
SLIPPER SATIN	Sleek, smooth very heavy satin in rayon or silk; may be slightly stiff because of thickness.	Drapery and upholstery, bed coverings, etc. Suitable in formal and period rooms for draperies.
SCRIM	Fabric of coarse two-ply yarns in plain, open weave. Often mercerized.	Curtains, bedspreads, etc.
STRIE	Term used to designate fabric with uneven streaked effect. This process gives two-toned appearance to taffeta, satin, etc.	According to fabric.
TERRY CLOTH	Light cotton fabric similar to bath towel. Woven with uncut loops. May be dyed or printed, in designs of one or two colors. Rich texture and reversible.	Draperies. Draw-curtains.
THEATRICAL GAUZE	Loosely woven, transparent plain-weave fabric of cotton or linen. Obtainable in brilliant as well as soft colors. Inexpensive.	Glass curtains.
TOILES DE JOUY	Printed cotton material with repeat designs showing landscapes, or historical scenes. Reproductions of famous printed fabric woven at Jouy, near Paris, France. Designs and figure groups usually in colors on white or cream background.	Draperies, wall hangings, upholstery, bed coverings. Excellent for French, English and American period rooms of late 18th Century and early 19th Century; also French Provincial.
TWEED WEAVES	Term applied to a large group of woolen goods made from worsted yarns, woven in plain, twill, or herringbone twill weaves in homespun type.	Draperies and upholstery. Very good for modern or masculine rooms.
VELOUR	Really a French word for velvet. Through common usage, a short-pile velvet.	Same as velvet.

General Reference Data

**ELECTRICAL**

Office and Electronic Equipment

**TABLE 16 Typical Amperage Ratings**

Equipment	Amperage	Equipment	Amperage
Electronic Equipment <sup>1</sup>		Electronic Equipment	
Video Display Terminals (Detached Keyboards)		Memory Storage Devices (Desk Top)	
Normal maximum	2.50	Wang/5503 Disk	4.00
Burroughs/MT 983 TP110	.08	Xerox/8000 NS	12.00
Digital/VT 278 Decmate	1.25	Digital Equipment/RX02	3.00
Form-Phase Systems/8115-2	.48	Hewlett-Packard/8290 ZM	1.00
Harris/8680A	1.00	Hewlett-Packard/9895A	1.60
Hewlett-Packard/2382A	.75	Sperry-Univac/8406	1.50
IBM/3101	1.20	Texas Instruments/WD-500	3.00
IBM/3278 or 3276	1.33	Bell/Western Electric/Dataphone 300/1200	.08
IBM/3279	2.50		
IBM/5251 Model 11	2.10	Office Equipment*	
IBM/6580	4.80	General	
ITT Courier/2790-2A	1.50	Typewriter	1.50
Perkin/Elmer/1251	1.30	Transcriber	.15
Prime/PT-45	1.00	Microfiche	.85
Raytheon/PTS100	.80	Manuscript holder	.75
Sperry-Univac/UTS20 (313)	.50	Calculator	.25
Texas Instruments/940/200	2.00	A.C. adapter	.05
Texas Instruments/DS990	2.20	Electric eraser	.25
Wang/5503	3.00	Pencil sharpener	.25
Xerox/8000 Series	.50	Fan	1.00
Video Display Terminals (Integrated Keyboard)		Space heater (1,000 watts)	8.50
Normal maximum	3.00	Space heater (1,250 watts)	10.50
Hewlett-Packard/HP-9845A	4.50	Space heater (1,500 watts)	12.50
Lear Siegler/ADM31	.50	Coffee pots	10.00
NCR/7900-01	.60	Copy machine	15.00
Perkin-Elmer/550B	.80	Clock	.03
Tektronics/4112	3.00	CRT (average)	1.50
Wang/5536	2.00	Printer (average)	3.50
Printers (Stand Alone)		Lighting	
Digital Equipment/LA-120AA	3.00	Adjustable task light	.80
Wang/5503	4.00	2" task light (20 watt)	.27
Xerox/8000 Print Server	11.00	2" task light (30 watt)	.40
Printers (Desk Top)		2" task light (40 watt)	.48
Normal maximum	3.50	2" task light (35 watt, energy-saving ballast)	.38
Centronics/7030	1.50	Indirect ambient light	
Digital Equipment/Decwriter IV	1.30	(30 watt/2 lamp)	.68
Form-Phase Systems/8125	1.60	(30 watt/3 lamp)	1.08
Hewlett-Packard/7221B	1.00	(40 watt/2 lamp)	.80
Hewlett-Packard/HP7240A	2.50	(40 watt/3 lamp)	1.28
IBM/3287	2.36	(35 watt/2 lamp)	.63
IBM/5256	4.70	(35 watt/3 lamp with energy-saving ballast)	1.01
Epson/FX 185	.70	HID light (400 watt)	4.00
NEC/3510	2.50	(250 watt)	2.50
ITT Courier/8700	1.60	(175 watt)	1.80
Lear Siegler/300 Series	1.60	PLP light (20 watt)	.65
Perkin-Elmer/650	1.50	(40 watt)	.80
Raytheon/PTS 1200 3472	1.50		
Sperry-Univac/0786	4.00		
Tektronix/4612	3.30		
Texas Instruments/Omni-800 810R0	5.00		
Wang/5531-2 w/floor mount	1.70		
Wang/5577 (DW-20 Series)	1.20		

Note: These figures are for quick reference only. For specific information consult the manufacturer.

\*Some appliances — such as large copiers, coffee makers, or space heaters — require most of the current available on a 20-amp circuit. It is recommended that such devices be supplied with their own receptacle, directly from the building. This leaves the capacity of Series 9000 circuits available for the more dynamic requirements of the office occupants.



**ELECTRICAL**

Locations of Receptacles in Dwelling Units

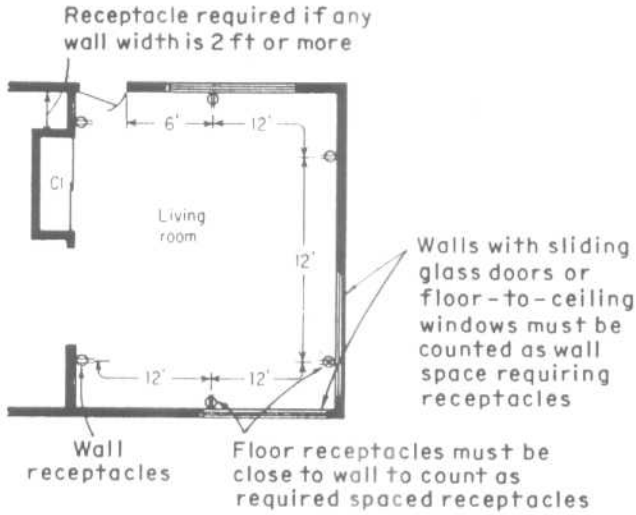


Fig. 15 From any point along wall, at floor line, a receptacle must be not more than 6 ft away.

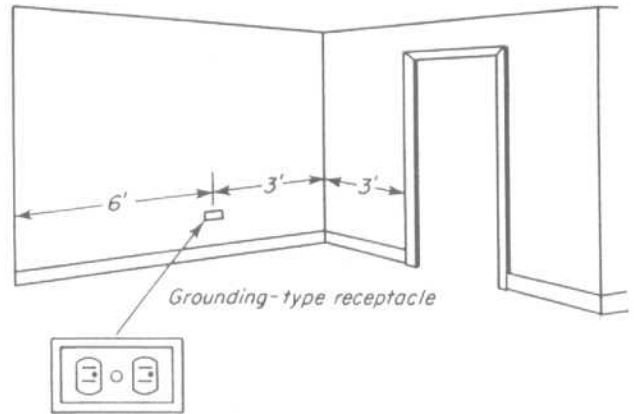
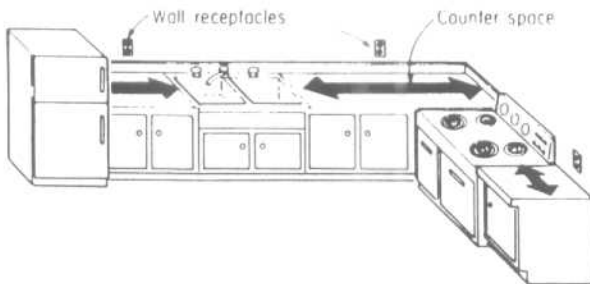


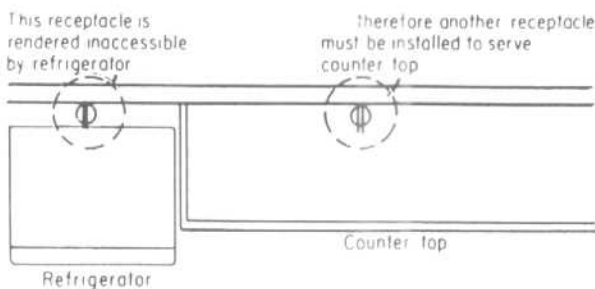
Fig. 16 Location of the receptacle as shown will permit the plugging in of a lamp or appliance located 6 ft on either side of the receptacle.

**Receptacle required at each counter space wider than 12 in.**



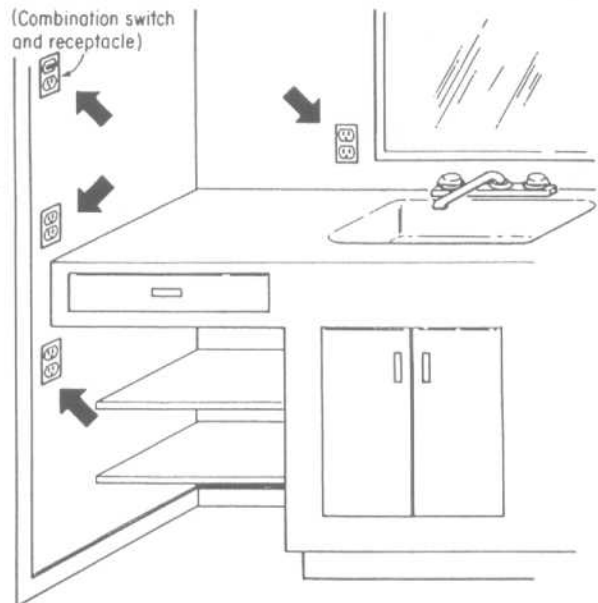
COUNTER SPACES in kitchen and dining rooms such as shown by arrows (above) must be supplied with receptacles if they are over 12 in. wide. Appliances are frequently used even on narrow counter widths, this requirement is designed to remove the dangerous practice of stretching cords across sinks, behind ranges, etc. to feed such appliances

**Inaccessible receptacles.**



RECEPTACLE LOCATED behind an appliance, making the receptacle inaccessible, does not count as one of the required "counter-top" receptacles. (Neither does it count as one of the appliance-circuit receptacles required to be located every 12 ft.)

Fig. 17 Countertop receptacles are needed and must be accessible.



LOCATION of receptacle will vary, depending upon available wall space. Arrows show several possibilities. A receptacle in a medicine cabinet or in the bathroom lighting fixture does not satisfy this rule.

Fig. 18 Receptacle required adjacent to wash basin in residence.

**ELECTRICAL**

**Appliance Loads and House Circuits**

**TABLE 17 Residential Appliance, Load, and Circuit Chart\***

Appliance	Typical wattage	Voltage needed	Amps load	Wires and size†	Size fuse or breaker‡	Type of circuit and comments
Range	12,000	115/230	52	3 #6	50A	Separate circuit—grounded
Countertop range	6,000	115/230	26	3 #10	30A	Separate circuit—grounded
Oven built-in	5,000	115/230	22	3 #10	30A	Separate circuit—grounded
Dishwasher	1,200	115	10	2 #12 w/grd§	20A	These two can be connected on one circuit, must be grounded.
Waste disposal	500	115	5	2 #12 w/grd	20A	
Broiler	1,500	115	13	2 #12	20A	Two or more 20-amp circuits needed for these appliances depending on number used at once. A 115/230 V "splitwired" circuit provides capacity of two ordinary circuits at any outlet. Ask your wiring inspector about this.
Fryer	1,300	115	11	2 #12	20A	
Coffeemaker	800	115	7	2 #12	20A	
Refrigerator	400	115	4	2 #12	20A	
Toaster	1,100	115	10	2 #12	20A	
Frypan	1,200	115	10	2 #12	20A	
Roaster	1,500	115	13	2 #12	20A	
Clothes dryer	5,000 to 9,000	115/230	25	3 #10 to 3 #6	30A to 45A	Separate circuit—grounded.
Washer	500	115	9	2 #12 w/grd	20A	Grounded—advise fused outlet for motor protection.
Hand iron	1,000	115	9	2 #12 w/grd	20A	A 20-A circuit will carry only one of these in addition to washer.
Hot plate	1,500	115	13	2 #12 w/grd	20A	
Ironer	1,650	115	15	2 #12 w/grd	20A	
Workshop	—	115	—	2 #12	20A	Separate circuit grounded.
Portable heater	1,500	115	13	2 #12	20A	Use on general-use circuits.
Television	300	115	3	2 #14	15A	
Portable lights—(up to)	300	115	3	2 #14	15A	
Lighting, general (each)	100	115	1 1/4	2 #14	15A	(Not over 9 per circuit, including convenience outlets.)
Air conditioner (window unit)	1,500	115 or 230	13	2 #12 w/grd or 7	20A	Requires separate circuit; 230 volt operation preferred.
Air conditioner (central unit)	3,400	115/230	20	3 #10	—	Check manufacturer's recommendations; should be grounded.
Water system	500	115	5	2 #12 w/grd	20A	Separate circuit—grounded. Provide motor protection (230V. for 1/2 hp. or larger).
Heating plant	600	115	6	2 #12 w/grd	20A	Separate circuit—grounded. Provide motor protection.
Electric heaters (built-in)	750 to 4,500	230	—	—	—	Wiring should be planned with heating. Provide separate circuits for heating.
Water heater	1,500 to 4,500	230	7 to 20	2 #12 w/grd to 2 #10 w/grd	20A to 30A	Separate circuit—grounded.

† Wire sizes are for copper wire. For aluminum, use next larger size.

‡ Fuses advised in place of ordinary fuses up to 30 amp as they do not blow on harmless short-time overloads and cannot be replaced by a larger size.

§ W/grd means with groundwire. This is usually a bare wire run inside the same cable but can be installed separately. Portable equipment is grounded through the third prong on the plug. Permanent equipment is grounded by direct connection of the third wire to the frame of the appliance.

\* Courtesy Agricultural Extension Service, South Dakota State University.

**TABLE 18 Typical Office Amperage Loads**

CAD station*	10.00–20.00
Calculator	.25
Coffee pot*	8.50–15.00
Clock	.03
Radio	.03
Stereo	.33
Tape recorder	.67
Laser printer*	6.00–10.00
Desktop copier*	10.00–15.00
Electric eraser	.25
Fan	1.10
Freestanding copier*	15.00–20.00
Pencil sharpener	1.00
Task light (4')	.67
Adding machine	.36
Letter opener	1.90
Dictaphone	.25
Telecopier	.50
Word processor	1.50– 3.00
Postage meter	2.80
Tape dispenser	1.80
Personal computer	3.50– 8.00
Desktop printer	1.50– 5.00
CRT	1.00– 3.00
Space heater*	12.50
Typewriter	1.50
Microfiche reader	.85
Transcriber	.15
A.C. adapter	.05
100-W lamp	.80

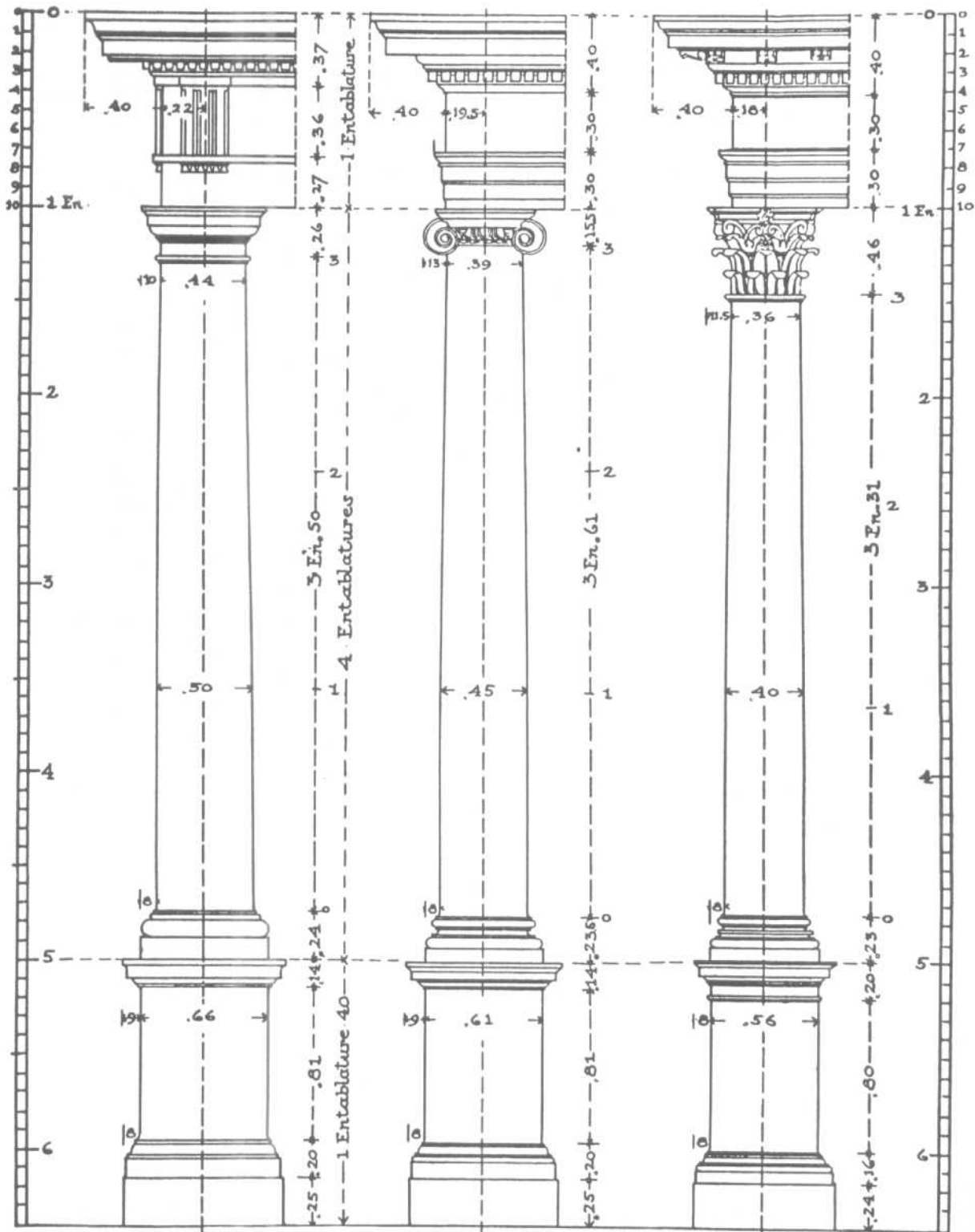
\* Some appliances such as coffee pots, copiers, printers, and heaters consume most of the amperage available on a circuit. It is recommended that these devices be connected directly to the building power supply, leaving flexibility for other circuit planning.

**TABLE 19 Common House Circuits**

Type	Wire size	Ampere rating of fuse or circuit breaker	Volts	Load capacity in watts	Use of circuit	Types of outlets
General purpose	minimum #14 recommended #12	15 20	115–120	1725–1800	Installed lighting, outlets for lamps and low wattage appliances all over the house	Those for attached light fixtures, ordinary convenience outlets
Appliance	minimum #12 recommended #10	20 25	115–120	2300–2400 2875–3000	Portable appliances in kitchen, dining room, work room, laundry	Ordinary or grounded convenience outlets
Individual appliance	#12	20	115–120	2300–2400	Automatic washer, refrigerator, freezer	Ordinary or grounded convenience outlets
Individual power	#6 or #8	30–60	220–240	6800–14400	Range, water heater, clothes dryer	Receptacle for plug with 3 heavy prongs or appliances may be attached

COLUMNS, CAPITALS, AND ENTABLATURES

Proportions



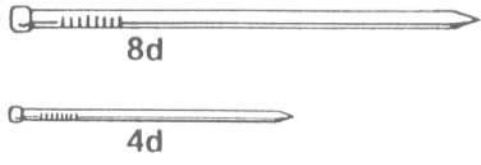
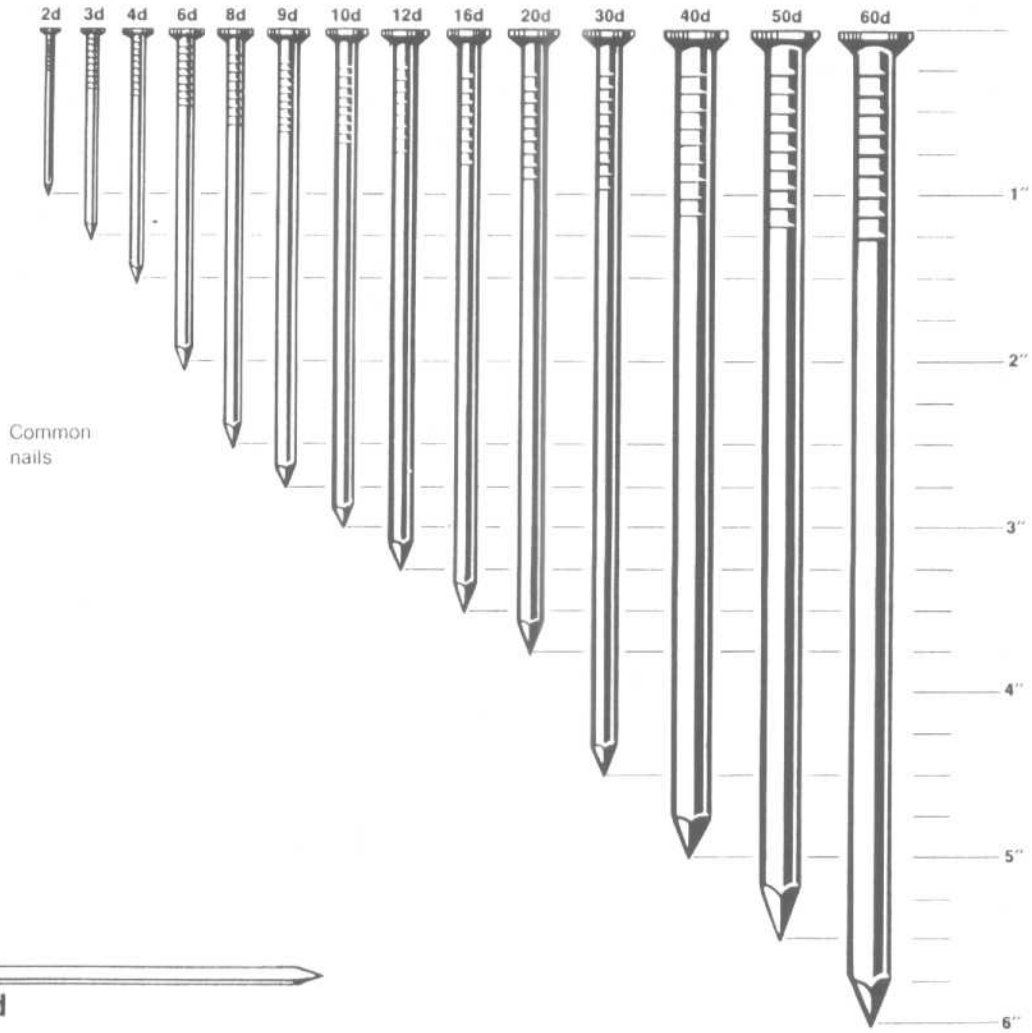
doric

ionic

corinthian

NAILS, SCREWS, AND BOLTS

Nails



Finishing nails

Nos.	1	1-1/2	2	2-1/2	3	4	6	8	10	12	14	16	18	20	22	24
Ins.	3/16"	7/32"	1/4"	5/16"	3/8"	7/16"	1/2"	9/16"	5/8"	11/16"	3/4"	13/16"	7/8"	15/16"	1"	1-1/8"

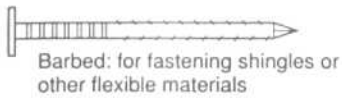


STANDARD TACK SIZES

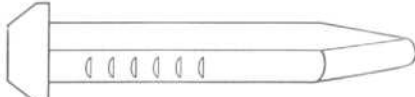
ESTABLISHED LENGTHS OF TACKS MEASURED UNDER THE HEAD

**NAILS, SCREWS, AND BOLTS**

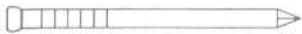
Nails



Barbed: for fastening shingles or other flexible materials



Boat spike: long spike used in timber construction



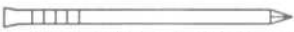
Brad: finishing nail less than 1 inch long



Box: for nailing thin dry wood close to edge



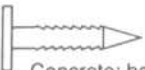
Cement-coated box: coated with resin that increases holding power



Casing: similar to finishing, but with dulled point to penetrate thin trim without splitting



Common: for rough and heavy construction



Concrete: hardened steel nail with diamond point



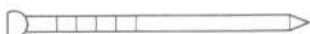
Fluted concrete: hardened steel nail with fluting to increase holding power



Escutcheon pin: small nail used to attach escutcheons



Fence: large-head nail for holding weathered boards



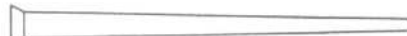
Finishing: slender nail that can be set below surface



Cut finishing: finishing nail used in historic restoration



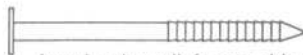
Blunt flooring: nail with blunt tip to prevent splitting hardwood flooring



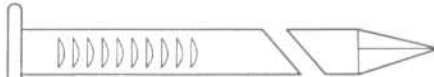
Cut flooring: for historic restoration



Drive-screw flooring: nail with screw-drive to increase holding power



Annular drywall: for attaching drywall to framing; rings increase holding power



Gutter spike: for attaching gutter to fascia



Hinge: for attaching large hinges such as for barn doors



Annular hinge: hinge with rings to increase holding power



Lath: small nail for installing wood lath



Offset head: for use with power nailer



Parquet flooring: thin nail to prevent splitting parquet



Pole barn: large spike for attaching framing to poles



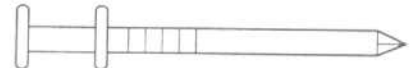
Roofing: for attaching asphalt roofing to underlayment



Built-up roofing: for attaching roofing felt



No-leak roofing: nail with rubber gasket to seal metal roofing



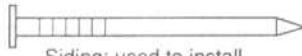
Scaffold: nail with double head to make nail easy to pull for temporary fastening



Shingle: for attaching cedar shingles



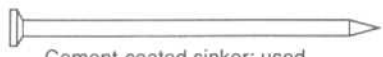
Cut shingle: used in historic restoration



Siding: used to install beveled wood siding



Screw-thread siding: nail with a screw thread to increase holding power



Cement-coated sinker: used to install underlayment



Slating: used to attach roofing slates



Ring shank underlayment: nail with rings to increase holding power



Spike: common nail 4-1/2 inches or longer

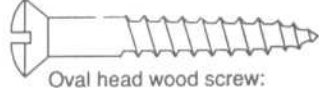
**NAILS, SCREWS, AND BOLTS**

**Screws and Bolts**

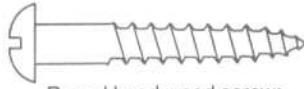
**SCREWS**



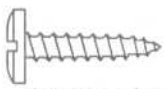
Flat head wood screw:  
for fastening wood to wood



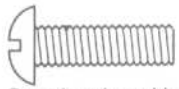
Oval head wood screw:  
decorative



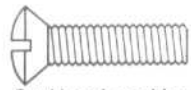
Round head wood screw:  
used with washer



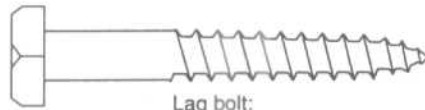
Sheet metal screw:  
for thin metal



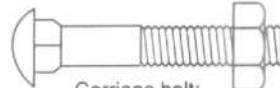
Oval head machine screw:  
older design



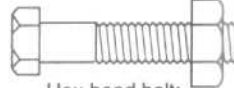
Oval head machine screw:  
attractive



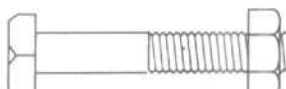
Lag bolt:  
for heavy loads in wood



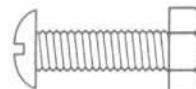
Carriage bolt:  
bolt will not turn



Hex head bolt:  
for heavy loads



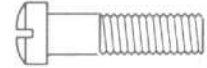
Square head bolt:  
replaced by hex head



Round head bolt:  
older design



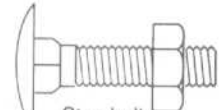
Stove bolt:  
finishes flush



Fillister head cap screw:  
small, strong-headed



Fillister head machine screw:  
small, strong-headed



Step bolt:  
bolt won't turn



Plow bolt:  
for steel to steel

**SCREW AND BOLT HEADS**



Slotted



Phillips



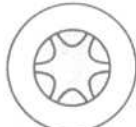
Combination  
Phillips/slotted



Square



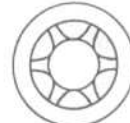
Frearson



Internal torx



Clutch



External torx



Tamper-proof



Tamper-proof

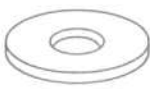


Tamper-proof  
hexagon

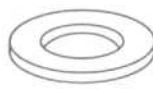


Tamper-proof  
torx

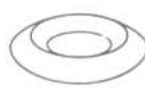
**WASHERS**



Flat USS



Flat SAE



Finish



Torque



Internal-  
tooth



External-  
tooth



Internal-external-  
tooth



Split-  
lock

**MATHEMATICAL DATA AND FORMULAS**

Units of Measurement

**LINEAR MEASURE**

Measures of Length		Nautical Units	
12 inches = 1 foot	6080.20 feet = 1 nautical mile	6 feet = 1 fathom	
3 feet = 1 yard	120 fathoms = 1 cable length	1 nautical mile per hr. = 1 knot	
5½ yards = 16½ feet			
40 poles = 220 yards	1 furlong		
8 furlongs = 1760 yards	1 mile		
= 5280 feet			
3 miles = 1 league			
4 inches = 1 hand			
9 inches = 1 span			

**Surveyor's or Gunter's Measure**

7.92 inches = 1 link
100 links = 66 ft. = 4 rods = 1 chain
80 chains = 1 mile
33½ inches = 1 vara (Texas)

**Length Equivalents**

Centi-meters	Inches	Feet	Yards	Meters	Chains	Kilo-meters	Miles
1	0.3937	0.03281	0.01094	0.01	0.04971	10 <sup>-5</sup>	0.0,6214
2.540	1	0.08333	0.02778	0.0254	0.001263	0.0,254	0.0,1578
30.48	12	1	0.3333	0.3048	0.01515	0.0,3048	0.0,1894
91.44	36	3	1	0.9144	0.04545	0.0,9144	0.0,5682
100	39.37	3.281	1.0936	1	0.04971	0.001	0.0,6214
2012	792	66	22	20.12	1	0.02012	0.0125
100000	39370	3281	1093.6	1000	49.71	1	0.6214
160935	63360	5280	1760	1609	80	1.609	1

Subscripts after any figure, 0, 9, etc., mean that that figure is to be repeated the indicated number of times.

**VOLUMETRIC MEASURE**

Measures of Volume		Dry Measure	
1728 cubic inches = 1 cubic foot		2 pints = 1 quart	
27 cubic feet = 1 cubic yard		8 quarts = 1 peck	
1 cord of wood = 128 cu. ft.		4 pecks = 1 bushel	
1 perch of masonry = 16½ to 25 cu. ft.			
		1 std. bbl. for fruits and vegetables = 7056 cu. in. or 105 dry quarts, struck measure	
Liquid or Fluid Measure		Board Measure	
4 gills = 1 pint		1 board foot = { 144 cu. in. = volume of board 1 ft. sq. and 1 in. thick.	
2 pints = 1 quart			
4 quarts = 1 gallon		No. of board feet in a log = 1¼(d-4)L, where d = diam. of log (usually taken inside the bark at small end), in., and L = length of log, ft. The 4 in. deducted are an allowance for slab. This rule is variously known as the Doyle, Conn. River, St. Croix, Thurber, Moore and Beeman, and the Scribner rule.	
7,4805 gallons = 1 cubic foot			

(There is no standard liquid barrel; by trade custom, 1 bbl. of petroleum oil, unrefined = 42 gal.)

**Volume and Capacity Equivalents**

Cubic inches	Cubic feet	Cubic yards	U. S. Apothecary liquid ounces	U. S. quarts		U. S. gallons		Bushels U. S.	Liters (l)
				Liquid	Dry	Liquid	Dry		
1	0.0,5787	0.0,2143	0.5541	0.01732	0.01488	0.0,4329	0.0,3720	0.0,4650	0.01639
1728	1	0.03704	957.5	29.92	25.71	7.481	6.429	0.8036	28.32
46656	27	1	25853	807.9	694.3	202.0	173.6	21.70	764.6
1.805	0.001044	0.0,3868	1	0.03125	0.02686	0.007813	0.006714	0.0,8392	0.02957
57.75	0.03342	0.001238	32	1	0.8594	0.25	0.2148	0.02686	0.9464
67.20	0.03889	0.001440	37.24	1.164	1	0.2909	0.25	0.03125	1.101
231	0.1337	0.004951	128	4	3.437	1	0.8594	0.1074	3.785
268.8	0.1556	0.005761	148.9	4.655	4	1.164	1	0.125	4.405
2150	1.244	0.04609	1192	37.24	32	9.309	8	1	35.24
61.02	0.03531	0.001308	33.81	1.057	0.9081	0.2642	0.2270	0.02838	1

Subscripts after any figure, 0, 9, etc., mean that that figure is to be repeated the indicated number of times.

**MEASURES OF AREA**

144 square inches = 1 square foot
9 square feet = 1 square yard
30¼ square yards = 1 square rod, pole or perch
160 square rods = 1 acre
= 10 square chains
= 43,560 sq. ft.
= 5645 sq. varas (Texas)
640 acres = 1 square mile = 1 "section" of U. S. Govt. surveyed land

**Area Equivalents**

Square Meters	Square Inches	Square Feet	Square Yards	Square Rods	Square Chains	Roods	Acres	Square Miles or Sections
1	1550	10.76	1.196	0.0395	0.002471	0.0,9884	0.0,2471	0.0,3861
0.0,6452	1	0.006944	0.0,7716	0.0,2551	0.0,1594	0.0,6377	0.0,1594	0.0,2491
0.09290	144	1	0.1111	0.003673	0.0,2296	0.0,9184	0.0,2296	0.0,3587
0.8361	1296	9	1	0.03306	0.002066	0.0,8264	0.0002066	0.0,3228
25.29	39204	272.25	30.25	1	0.0625	0.02500	0.00625	0.0,9766
404.7	627264	4356	484	16	1	0.4	0.1	0.0001562
1012	1568160	10890	1210	40	2.5	1	0.25	0.0,3906
4047	6272640	43560	4840	160	10	4	1	0.001562
2589998	.....	27878400	3097600	102400	6400	2560	640	1

(1 hectare = 100 ares = 10,000 centiares or square meters)

Subscripts after any figure 0, 9, etc., mean that that figure is to be repeated the indicated number of times.

**MEASURES OF WEIGHT**

Weights		Troy Weight	
(The grain is the same in all systems)		24 grains = 1 pennyweight (dwt.)	
		20 pennyweights = 480 grains = 1 ounce	
		12 ounces = 5760 grains = 1 pound	
Avoirdupois Weight		Apothecaries' Weight	
16 drams = 437.5 grains = 1 ounce		20 grains = 1 scruple	
16 ounces = 7000 grains = 1 pound		3 scruples = 60 grains = 1 dram	
100 pounds = 1 cental		8 drams = 1 ounce	
2000 pounds = 1 short ton		12 ounces = 5760 grains = 1 pound	
2240 pounds = 1 long ton			
1 std. lime bbl., small = 180 lb. net			
1 std. lime bbl., large = 280 lb. net			
Also (in Great Britain):			
14 pounds = 1 stone			
2 stone = 28 lb.			
4 quarters = 112 lb.			
20 hundredweight = 1 long ton			

**Mass Equivalents**

Kilograms	Grains	Ounces		Pounds		Tons		
		Troy and apoth.	Avoirdupois	Troy and apoth.	Avoirdupois	Short	Long	Metric
1	15432	32.15	35.27	2.6792	2.205	0.0,1102	0.0,9842	0.001
0.0,6480	1	0.0,2083	0.0,2286	0.0,1736	0.0,1429	0.0,7143	0.0,6378	0.0,6480
0.03110	480	1	1.09714	0.08333	0.06857	0.0,3429	0.0,3061	0.0,3110
0.02835	437.5	0.9115	1	0.07595	0.0625	0.0,3125	0.0,2790	0.0,2835
0.3732	5760	12	13.17	1	0.8229	0.0,4114	0.0,3673	0.0,3732
0.4536	7000	14.58	16	1.215	1	0.0005	0.0,4464	0.0,4536
907.2	140,000	29167	320,000	2431	2000	1	0.8929	0.9072
1016	15680,0	32667	35840	2722	2240	1.12	1	1.016
1000	15432356	32151	35274	2679	2205	1.102	0.9842	1

Subscripts after any figure, 0, 9, etc., mean that that figure is to be repeated the indicated number of times.

**MATHEMATICAL DATA AND FORMULAS**

**Metric Conversion Tables**

<p style="text-align: center;"><b>METRIC WEIGHT</b></p> <table border="0"> <thead> <tr> <th></th> <th></th> <th style="text-align: right;"><b>Avoirdupois</b></th> </tr> </thead> <tbody> <tr> <td>1 milligram (mg)</td> <td></td> <td style="text-align: right;">= 0.0154 gr.</td> </tr> <tr> <td>1 centigram (cg)</td> <td>= 10 mg</td> <td style="text-align: right;">= 0.1543 gr.</td> </tr> <tr> <td>1 decigram (dg)</td> <td>= 10 cg</td> <td style="text-align: right;">= 1.5432 gr.</td> </tr> <tr> <td>1 gram (g)</td> <td>= 10 dg</td> <td style="text-align: right;">= 15.4323 gr.</td> </tr> <tr> <td>1 dekagram (dag)</td> <td>= 10 g</td> <td style="text-align: right;">= 0.3527 oz.</td> </tr> <tr> <td>1 hectogram (hg)</td> <td>= 10 dag</td> <td style="text-align: right;">= 3.5274 oz.</td> </tr> <tr> <td>1 kilogram (kg)</td> <td>= 10 hg</td> <td style="text-align: right;">= 2.2046 lb.</td> </tr> <tr> <td>1 quintal (q)</td> <td>= 100 kg</td> <td style="text-align: right;">= 220.46 lb.</td> </tr> <tr> <td>1 metric ton (M.T.)</td> <td>= 10 q or 1,000 kg</td> <td style="text-align: right;">= 2,204.62 lb.</td> </tr> </tbody> </table>			<b>Avoirdupois</b>	1 milligram (mg)		= 0.0154 gr.	1 centigram (cg)	= 10 mg	= 0.1543 gr.	1 decigram (dg)	= 10 cg	= 1.5432 gr.	1 gram (g)	= 10 dg	= 15.4323 gr.	1 dekagram (dag)	= 10 g	= 0.3527 oz.	1 hectogram (hg)	= 10 dag	= 3.5274 oz.	1 kilogram (kg)	= 10 hg	= 2.2046 lb.	1 quintal (q)	= 100 kg	= 220.46 lb.	1 metric ton (M.T.)	= 10 q or 1,000 kg	= 2,204.62 lb.	<p style="text-align: center;"><b>METRIC LAND MEASUREMENTS</b></p> <table border="0"> <thead> <tr> <th></th> <th style="text-align: center;"><b>Metric</b></th> <th style="text-align: center;"><b>Customary</b></th> </tr> </thead> <tbody> <tr> <td>1 centiare (ca)</td> <td></td> <td style="text-align: right;">= 1.549 sq. in.</td> </tr> <tr> <td>1 are (a)</td> <td>= 100 ca</td> <td style="text-align: right;">= 119.6 sq. yd.</td> </tr> <tr> <td>1 hectare (ha)</td> <td>= 100 a</td> <td style="text-align: right;">= 2.4710 A.</td> </tr> <tr> <td>1 square kilometer (km<sup>2</sup>)</td> <td>= 100 ha or</td> <td style="text-align: right;">0.3861 sq. mi.</td> </tr> </tbody> </table>		<b>Metric</b>	<b>Customary</b>	1 centiare (ca)		= 1.549 sq. in.	1 are (a)	= 100 ca	= 119.6 sq. yd.	1 hectare (ha)	= 100 a	= 2.4710 A.	1 square kilometer (km <sup>2</sup> )	= 100 ha or	0.3861 sq. mi.																																	
		<b>Avoirdupois</b>																																																																													
1 milligram (mg)		= 0.0154 gr.																																																																													
1 centigram (cg)	= 10 mg	= 0.1543 gr.																																																																													
1 decigram (dg)	= 10 cg	= 1.5432 gr.																																																																													
1 gram (g)	= 10 dg	= 15.4323 gr.																																																																													
1 dekagram (dag)	= 10 g	= 0.3527 oz.																																																																													
1 hectogram (hg)	= 10 dag	= 3.5274 oz.																																																																													
1 kilogram (kg)	= 10 hg	= 2.2046 lb.																																																																													
1 quintal (q)	= 100 kg	= 220.46 lb.																																																																													
1 metric ton (M.T.)	= 10 q or 1,000 kg	= 2,204.62 lb.																																																																													
	<b>Metric</b>	<b>Customary</b>																																																																													
1 centiare (ca)		= 1.549 sq. in.																																																																													
1 are (a)	= 100 ca	= 119.6 sq. yd.																																																																													
1 hectare (ha)	= 100 a	= 2.4710 A.																																																																													
1 square kilometer (km <sup>2</sup> )	= 100 ha or	0.3861 sq. mi.																																																																													
<p style="text-align: center;"><b>AVOIRDUPOIS WEIGHT</b></p> <table border="0"> <thead> <tr> <th></th> <th></th> <th style="text-align: center;"><b>Metric</b></th> </tr> </thead> <tbody> <tr> <td>1 grain (gr.)</td> <td></td> <td style="text-align: right;">= 0.0648 g</td> </tr> <tr> <td>1 dram (dr.)</td> <td>= 27.34375 gr.</td> <td style="text-align: right;">= 1.7718 g</td> </tr> <tr> <td>1 ounce (oz.)</td> <td>= 16 dr.</td> <td style="text-align: right;">= 28.3495 g</td> </tr> <tr> <td>1 pound (lb.)</td> <td>= 16 oz.</td> <td style="text-align: right;">= 453.5924 g or 0.4536 kg</td> </tr> <tr> <td>1 hundredweight (cwt.)</td> <td>= 100 lb.</td> <td style="text-align: right;">= 45.3592 kg</td> </tr> <tr> <td>1 short ton (s.t.)</td> <td>= 2,000 lb.</td> <td style="text-align: right;">= 907.18 kg or 0.9072 M.T.</td> </tr> </tbody> </table>			<b>Metric</b>	1 grain (gr.)		= 0.0648 g	1 dram (dr.)	= 27.34375 gr.	= 1.7718 g	1 ounce (oz.)	= 16 dr.	= 28.3495 g	1 pound (lb.)	= 16 oz.	= 453.5924 g or 0.4536 kg	1 hundredweight (cwt.)	= 100 lb.	= 45.3592 kg	1 short ton (s.t.)	= 2,000 lb.	= 907.18 kg or 0.9072 M.T.	<p style="text-align: center;"><b>VOLUME MEASUREMENTS</b></p> <table border="0"> <thead> <tr> <th></th> <th style="text-align: center;"><b>Customary</b></th> <th style="text-align: center;"><b>Metric</b></th> </tr> </thead> <tbody> <tr> <td>1 cubic inch (cu. in.)</td> <td></td> <td style="text-align: right;">= 16.387 cm<sup>3</sup></td> </tr> <tr> <td>1 cubic foot (cu. ft.)</td> <td>= 1,728 cu. in.</td> <td style="text-align: right;">= 0.0283 m<sup>3</sup></td> </tr> <tr> <td>1 cubic yard (cu. yd.)</td> <td>= 27 cu. ft.</td> <td style="text-align: right;">= 0.7646 m<sup>3</sup></td> </tr> </tbody> </table> <table border="0"> <thead> <tr> <th></th> <th style="text-align: center;"><b>Metric</b></th> <th style="text-align: center;"><b>Customary</b></th> </tr> </thead> <tbody> <tr> <td>1 cubic millimeter (mm<sup>3</sup>)</td> <td></td> <td style="text-align: right;">= 0.00006 cu. in.</td> </tr> <tr> <td>1 cubic centimeter (cm<sup>3</sup>)</td> <td>= 1,000 mm<sup>3</sup></td> <td style="text-align: right;">= 0.0610 cu. in.</td> </tr> <tr> <td>1 cubic decimeter (dm<sup>3</sup>)</td> <td>= 1,000 cm<sup>3</sup></td> <td style="text-align: right;">= 0.0353 cu. ft.</td> </tr> <tr> <td>1 cubic meter (m<sup>3</sup>)</td> <td>= 1,000 dm<sup>3</sup></td> <td style="text-align: right;">= 1.3079 cu. yd.</td> </tr> <tr> <td>1 cubic dekameter (dam<sup>3</sup>)</td> <td>= 1,000 m<sup>3</sup></td> <td style="text-align: right;">= 1,307.9 cu. yd.</td> </tr> <tr> <td>1 cubic hectometer (hm<sup>3</sup>)</td> <td>= 1,000 dam<sup>3</sup></td> <td style="text-align: right;">= 1,307,900 cu. yd.</td> </tr> </tbody> </table>		<b>Customary</b>	<b>Metric</b>	1 cubic inch (cu. in.)		= 16.387 cm <sup>3</sup>	1 cubic foot (cu. ft.)	= 1,728 cu. in.	= 0.0283 m <sup>3</sup>	1 cubic yard (cu. yd.)	= 27 cu. ft.	= 0.7646 m <sup>3</sup>		<b>Metric</b>	<b>Customary</b>	1 cubic millimeter (mm <sup>3</sup> )		= 0.00006 cu. in.	1 cubic centimeter (cm <sup>3</sup> )	= 1,000 mm <sup>3</sup>	= 0.0610 cu. in.	1 cubic decimeter (dm <sup>3</sup> )	= 1,000 cm <sup>3</sup>	= 0.0353 cu. ft.	1 cubic meter (m <sup>3</sup> )	= 1,000 dm <sup>3</sup>	= 1.3079 cu. yd.	1 cubic dekameter (dam <sup>3</sup> )	= 1,000 m <sup>3</sup>	= 1,307.9 cu. yd.	1 cubic hectometer (hm <sup>3</sup> )	= 1,000 dam <sup>3</sup>	= 1,307,900 cu. yd.																								
		<b>Metric</b>																																																																													
1 grain (gr.)		= 0.0648 g																																																																													
1 dram (dr.)	= 27.34375 gr.	= 1.7718 g																																																																													
1 ounce (oz.)	= 16 dr.	= 28.3495 g																																																																													
1 pound (lb.)	= 16 oz.	= 453.5924 g or 0.4536 kg																																																																													
1 hundredweight (cwt.)	= 100 lb.	= 45.3592 kg																																																																													
1 short ton (s.t.)	= 2,000 lb.	= 907.18 kg or 0.9072 M.T.																																																																													
	<b>Customary</b>	<b>Metric</b>																																																																													
1 cubic inch (cu. in.)		= 16.387 cm <sup>3</sup>																																																																													
1 cubic foot (cu. ft.)	= 1,728 cu. in.	= 0.0283 m <sup>3</sup>																																																																													
1 cubic yard (cu. yd.)	= 27 cu. ft.	= 0.7646 m <sup>3</sup>																																																																													
	<b>Metric</b>	<b>Customary</b>																																																																													
1 cubic millimeter (mm <sup>3</sup> )		= 0.00006 cu. in.																																																																													
1 cubic centimeter (cm <sup>3</sup> )	= 1,000 mm <sup>3</sup>	= 0.0610 cu. in.																																																																													
1 cubic decimeter (dm <sup>3</sup> )	= 1,000 cm <sup>3</sup>	= 0.0353 cu. ft.																																																																													
1 cubic meter (m <sup>3</sup> )	= 1,000 dm <sup>3</sup>	= 1.3079 cu. yd.																																																																													
1 cubic dekameter (dam <sup>3</sup> )	= 1,000 m <sup>3</sup>	= 1,307.9 cu. yd.																																																																													
1 cubic hectometer (hm <sup>3</sup> )	= 1,000 dam <sup>3</sup>	= 1,307,900 cu. yd.																																																																													
<p style="text-align: center;"><b>WOOD MEASUREMENTS</b></p> <table border="0"> <thead> <tr> <th></th> <th style="text-align: center;"><b>Customary</b></th> <th style="text-align: center;"><b>Metric</b></th> </tr> </thead> <tbody> <tr> <td>1 board foot (bd. ft.)</td> <td>= 144 cu. in. (1 ft. x 1 ft. x 1 in.)</td> <td style="text-align: right;">= .00236 m<sup>3</sup></td> </tr> <tr> <td>1 cord foot (cd. ft.)</td> <td>= 16 cu. ft. (4 ft. x 4 ft. x 1 ft.)</td> <td style="text-align: right;">= .4528 m<sup>3</sup></td> </tr> <tr> <td>1 cord (cd.)</td> <td>= 8 cd. ft. (4 ft. x 4 ft. x 8 ft.)</td> <td style="text-align: right;">= 3.625 m<sup>3</sup></td> </tr> </tbody> </table> <table border="0"> <thead> <tr> <th></th> <th style="text-align: center;"><b>Metric</b></th> <th style="text-align: center;"><b>Customary</b></th> </tr> </thead> <tbody> <tr> <td>1 stere</td> <td>1 m<sup>3</sup></td> <td style="text-align: right;">1.3079 cu. yd. or 0.2759 cord</td> </tr> </tbody> </table>		<b>Customary</b>	<b>Metric</b>	1 board foot (bd. ft.)	= 144 cu. in. (1 ft. x 1 ft. x 1 in.)	= .00236 m <sup>3</sup>	1 cord foot (cd. ft.)	= 16 cu. ft. (4 ft. x 4 ft. x 1 ft.)	= .4528 m <sup>3</sup>	1 cord (cd.)	= 8 cd. ft. (4 ft. x 4 ft. x 8 ft.)	= 3.625 m <sup>3</sup>		<b>Metric</b>	<b>Customary</b>	1 stere	1 m <sup>3</sup>	1.3079 cu. yd. or 0.2759 cord	<p style="text-align: center;"><b>METRIC CAPACITY MEASUREMENTS</b></p> <table border="0"> <thead> <tr> <th></th> <th style="text-align: center;"><b>Metric</b></th> <th style="text-align: center;"><b>Customary</b></th> </tr> </thead> <tbody> <tr> <td>1 milliliter (ml)</td> <td></td> <td style="text-align: right;">= 0.0610 cu. in.</td> </tr> <tr> <td>1 centiliter (cl)</td> <td>= 10 ml</td> <td style="text-align: right;">= 0.6102 cu. in.</td> </tr> <tr> <td>1 deciliter (dl)</td> <td>= 10 cl</td> <td style="text-align: right;">= 6.1025 cu. in.</td> </tr> <tr> <td>1 liter (l)</td> <td>= 10 dl</td> <td style="text-align: right;">= 61.025 cu. in.</td> </tr> <tr> <td></td> <td></td> <td style="text-align: right;">or 1.057 liquid qt.</td> </tr> <tr> <td></td> <td></td> <td style="text-align: right;">or 0.908 dry</td> </tr> <tr> <td>1 dekaliter (dal)</td> <td>= 10 l</td> <td style="text-align: right;">= 610.25 cu. in.</td> </tr> <tr> <td>1 hectoliter (hl)</td> <td>= 10 dal</td> <td style="text-align: right;">= 6,102.50 cu. in.</td> </tr> <tr> <td>1 kiloliter (kl)</td> <td>= 10 hl</td> <td style="text-align: right;">= 35,315 cu. ft.</td> </tr> <tr> <td></td> <td></td> <td style="text-align: right;">or 264.178 gal.</td> </tr> <tr> <td></td> <td></td> <td style="text-align: right;">or 28.38 bu.</td> </tr> </tbody> </table>		<b>Metric</b>	<b>Customary</b>	1 milliliter (ml)		= 0.0610 cu. in.	1 centiliter (cl)	= 10 ml	= 0.6102 cu. in.	1 deciliter (dl)	= 10 cl	= 6.1025 cu. in.	1 liter (l)	= 10 dl	= 61.025 cu. in.			or 1.057 liquid qt.			or 0.908 dry	1 dekaliter (dal)	= 10 l	= 610.25 cu. in.	1 hectoliter (hl)	= 10 dal	= 6,102.50 cu. in.	1 kiloliter (kl)	= 10 hl	= 35,315 cu. ft.			or 264.178 gal.			or 28.38 bu.																								
	<b>Customary</b>	<b>Metric</b>																																																																													
1 board foot (bd. ft.)	= 144 cu. in. (1 ft. x 1 ft. x 1 in.)	= .00236 m <sup>3</sup>																																																																													
1 cord foot (cd. ft.)	= 16 cu. ft. (4 ft. x 4 ft. x 1 ft.)	= .4528 m <sup>3</sup>																																																																													
1 cord (cd.)	= 8 cd. ft. (4 ft. x 4 ft. x 8 ft.)	= 3.625 m <sup>3</sup>																																																																													
	<b>Metric</b>	<b>Customary</b>																																																																													
1 stere	1 m <sup>3</sup>	1.3079 cu. yd. or 0.2759 cord																																																																													
	<b>Metric</b>	<b>Customary</b>																																																																													
1 milliliter (ml)		= 0.0610 cu. in.																																																																													
1 centiliter (cl)	= 10 ml	= 0.6102 cu. in.																																																																													
1 deciliter (dl)	= 10 cl	= 6.1025 cu. in.																																																																													
1 liter (l)	= 10 dl	= 61.025 cu. in.																																																																													
		or 1.057 liquid qt.																																																																													
		or 0.908 dry																																																																													
1 dekaliter (dal)	= 10 l	= 610.25 cu. in.																																																																													
1 hectoliter (hl)	= 10 dal	= 6,102.50 cu. in.																																																																													
1 kiloliter (kl)	= 10 hl	= 35,315 cu. ft.																																																																													
		or 264.178 gal.																																																																													
		or 28.38 bu.																																																																													
<p style="text-align: center;"><b>LENGTH AND DISTANCE</b></p> <table border="0"> <thead> <tr> <th></th> <th style="text-align: center;"><b>Customary</b></th> <th style="text-align: center;"><b>Metric</b></th> </tr> </thead> <tbody> <tr> <td>1 inch (in.)</td> <td></td> <td style="text-align: right;">= 2.54 cm</td> </tr> <tr> <td>1 foot (ft.)</td> <td>= 12 in.</td> <td style="text-align: right;">= 30.48 cm</td> </tr> <tr> <td>1 yard (yd.)</td> <td>= 3 ft.</td> <td style="text-align: right;">= 0.9144 m</td> </tr> <tr> <td>1 rod (rd.)</td> <td>= 5½ yd.</td> <td style="text-align: right;">= 5.0292 m</td> </tr> <tr> <td>1 furlong (fur.)</td> <td>= 40 rd. or ¼ mi.</td> <td style="text-align: right;">= 201.168 m</td> </tr> <tr> <td>1 statute mile (mi.)</td> <td>= 5,280 ft.</td> <td style="text-align: right;">= 1,609.3 km</td> </tr> <tr> <td>1 league</td> <td>= 3 mi.</td> <td style="text-align: right;">= 4,828.0 km</td> </tr> </tbody> </table> <table border="0"> <thead> <tr> <th></th> <th style="text-align: center;"><b>Metric</b></th> <th style="text-align: center;"><b>Customary</b></th> </tr> </thead> <tbody> <tr> <td>1 millimeter (mm)</td> <td></td> <td style="text-align: right;">= 0.03937 in.</td> </tr> <tr> <td>1 centimeter (cm)</td> <td>= 10 mm</td> <td style="text-align: right;">= 0.3937 in.</td> </tr> <tr> <td>1 decimeter (dm)</td> <td>= 10 cm</td> <td style="text-align: right;">= 3.937 in.</td> </tr> <tr> <td>1 meter (m)</td> <td>= 10 dm</td> <td style="text-align: right;">= 39.37 in.</td> </tr> <tr> <td>1 dekameter (dam)</td> <td>= 10 m</td> <td style="text-align: right;">= 393.7 in.</td> </tr> <tr> <td>1 hectometer (hm)</td> <td>= 10 dam</td> <td style="text-align: right;">= 328.0833 ft.</td> </tr> <tr> <td>1 kilometer (km)</td> <td>= 10 hm</td> <td style="text-align: right;">= 0.62137 mi.</td> </tr> </tbody> </table>		<b>Customary</b>	<b>Metric</b>	1 inch (in.)		= 2.54 cm	1 foot (ft.)	= 12 in.	= 30.48 cm	1 yard (yd.)	= 3 ft.	= 0.9144 m	1 rod (rd.)	= 5½ yd.	= 5.0292 m	1 furlong (fur.)	= 40 rd. or ¼ mi.	= 201.168 m	1 statute mile (mi.)	= 5,280 ft.	= 1,609.3 km	1 league	= 3 mi.	= 4,828.0 km		<b>Metric</b>	<b>Customary</b>	1 millimeter (mm)		= 0.03937 in.	1 centimeter (cm)	= 10 mm	= 0.3937 in.	1 decimeter (dm)	= 10 cm	= 3.937 in.	1 meter (m)	= 10 dm	= 39.37 in.	1 dekameter (dam)	= 10 m	= 393.7 in.	1 hectometer (hm)	= 10 dam	= 328.0833 ft.	1 kilometer (km)	= 10 hm	= 0.62137 mi.	<p style="text-align: center;"><b>HOUSEHOLD CAPACITY MEASUREMENTS</b></p> <table border="0"> <thead> <tr> <th></th> <th style="text-align: center;"><b>Customary</b></th> <th style="text-align: center;"><b>Metric</b></th> </tr> </thead> <tbody> <tr> <td>1 teaspoon</td> <td></td> <td style="text-align: right;">= ¼ fl. oz. = 4.9 ml</td> </tr> <tr> <td>1 tablespoon</td> <td>= 3 teaspoons</td> <td style="text-align: right;">= ½ fl. oz. = 14.8 ml</td> </tr> <tr> <td>1 cup</td> <td>= 16 tablespoons</td> <td style="text-align: right;">= 8 fl. oz. = 236.6 ml</td> </tr> <tr> <td>1 pint</td> <td>= 2 cups</td> <td style="text-align: right;">= 16 fl. oz. = 473.2 ml</td> </tr> <tr> <td>1 quart</td> <td>= 2 pints</td> <td style="text-align: right;">= 32 fl. oz. = 946.4 ml</td> </tr> <tr> <td>1 gallon</td> <td>= 4 quarts</td> <td style="text-align: right;">= 128 fl. oz. = 3,785 l</td> </tr> </tbody> </table>		<b>Customary</b>	<b>Metric</b>	1 teaspoon		= ¼ fl. oz. = 4.9 ml	1 tablespoon	= 3 teaspoons	= ½ fl. oz. = 14.8 ml	1 cup	= 16 tablespoons	= 8 fl. oz. = 236.6 ml	1 pint	= 2 cups	= 16 fl. oz. = 473.2 ml	1 quart	= 2 pints	= 32 fl. oz. = 946.4 ml	1 gallon	= 4 quarts	= 128 fl. oz. = 3,785 l									
	<b>Customary</b>	<b>Metric</b>																																																																													
1 inch (in.)		= 2.54 cm																																																																													
1 foot (ft.)	= 12 in.	= 30.48 cm																																																																													
1 yard (yd.)	= 3 ft.	= 0.9144 m																																																																													
1 rod (rd.)	= 5½ yd.	= 5.0292 m																																																																													
1 furlong (fur.)	= 40 rd. or ¼ mi.	= 201.168 m																																																																													
1 statute mile (mi.)	= 5,280 ft.	= 1,609.3 km																																																																													
1 league	= 3 mi.	= 4,828.0 km																																																																													
	<b>Metric</b>	<b>Customary</b>																																																																													
1 millimeter (mm)		= 0.03937 in.																																																																													
1 centimeter (cm)	= 10 mm	= 0.3937 in.																																																																													
1 decimeter (dm)	= 10 cm	= 3.937 in.																																																																													
1 meter (m)	= 10 dm	= 39.37 in.																																																																													
1 dekameter (dam)	= 10 m	= 393.7 in.																																																																													
1 hectometer (hm)	= 10 dam	= 328.0833 ft.																																																																													
1 kilometer (km)	= 10 hm	= 0.62137 mi.																																																																													
	<b>Customary</b>	<b>Metric</b>																																																																													
1 teaspoon		= ¼ fl. oz. = 4.9 ml																																																																													
1 tablespoon	= 3 teaspoons	= ½ fl. oz. = 14.8 ml																																																																													
1 cup	= 16 tablespoons	= 8 fl. oz. = 236.6 ml																																																																													
1 pint	= 2 cups	= 16 fl. oz. = 473.2 ml																																																																													
1 quart	= 2 pints	= 32 fl. oz. = 946.4 ml																																																																													
1 gallon	= 4 quarts	= 128 fl. oz. = 3,785 l																																																																													
<p style="text-align: center;"><b>SURFACE OR AREA</b></p> <table border="0"> <thead> <tr> <th></th> <th style="text-align: center;"><b>Customary</b></th> <th style="text-align: center;"><b>Metric</b></th> </tr> </thead> <tbody> <tr> <td>1 square inch (sq. in.)</td> <td></td> <td style="text-align: right;">= 6.4516 cm<sup>2</sup></td> </tr> <tr> <td>1 square foot (sq. ft.)</td> <td>= 144 sq. in.</td> <td style="text-align: right;">= 0.0929 m<sup>2</sup></td> </tr> <tr> <td>1 square yard (sq. yd.)</td> <td>= 9 sq. ft.</td> <td style="text-align: right;">= 0.8361 m<sup>2</sup></td> </tr> <tr> <td>1 square rod (sq. rd.)</td> <td>= 30¼ sq. yd.</td> <td style="text-align: right;">= 25.293 m<sup>2</sup></td> </tr> <tr> <td>1 acre (A.)</td> <td>= 160 sq. rd.</td> <td style="text-align: right;">= 0.4047 ha</td> </tr> <tr> <td>1 square mile (sq. mi.)</td> <td>= 640 A.</td> <td style="text-align: right;">= 258.998 ha or 2.5899 km<sup>2</sup></td> </tr> </tbody> </table> <table border="0"> <thead> <tr> <th></th> <th style="text-align: center;"><b>Metric</b></th> <th style="text-align: center;"><b>Customary</b></th> </tr> </thead> <tbody> <tr> <td>1 square millimeter (mm<sup>2</sup>)</td> <td></td> <td style="text-align: right;">= 0.002 sq. in.</td> </tr> <tr> <td>1 square centimeter (cm<sup>2</sup>)</td> <td>= 100 mm<sup>2</sup></td> <td style="text-align: right;">= 0.1549 sq. in.</td> </tr> <tr> <td>1 square decimeter (dm<sup>2</sup>)</td> <td>= 100 cm<sup>2</sup></td> <td style="text-align: right;">= 15.499 sq. in.</td> </tr> <tr> <td>1 square meter (m<sup>2</sup>)</td> <td>= 100 dm<sup>2</sup></td> <td style="text-align: right;">= 1.549 sq. in.</td> </tr> <tr> <td>1 square dekameter (dam<sup>2</sup>)</td> <td>= 100 m<sup>2</sup></td> <td style="text-align: right;">= 119.6 sq. yd.</td> </tr> <tr> <td>1 square hectometer (hm<sup>2</sup>)</td> <td>= 100 dam<sup>2</sup></td> <td style="text-align: right;">= 2.4710 A.</td> </tr> <tr> <td>1 square kilometer (km<sup>2</sup>)</td> <td>= 100 hm<sup>2</sup></td> <td style="text-align: right;">= 247.104 A. or 0.3861 sq. mi.</td> </tr> </tbody> </table>		<b>Customary</b>	<b>Metric</b>	1 square inch (sq. in.)		= 6.4516 cm <sup>2</sup>	1 square foot (sq. ft.)	= 144 sq. in.	= 0.0929 m <sup>2</sup>	1 square yard (sq. yd.)	= 9 sq. ft.	= 0.8361 m <sup>2</sup>	1 square rod (sq. rd.)	= 30¼ sq. yd.	= 25.293 m <sup>2</sup>	1 acre (A.)	= 160 sq. rd.	= 0.4047 ha	1 square mile (sq. mi.)	= 640 A.	= 258.998 ha or 2.5899 km <sup>2</sup>		<b>Metric</b>	<b>Customary</b>	1 square millimeter (mm <sup>2</sup> )		= 0.002 sq. in.	1 square centimeter (cm <sup>2</sup> )	= 100 mm <sup>2</sup>	= 0.1549 sq. in.	1 square decimeter (dm <sup>2</sup> )	= 100 cm <sup>2</sup>	= 15.499 sq. in.	1 square meter (m <sup>2</sup> )	= 100 dm <sup>2</sup>	= 1.549 sq. in.	1 square dekameter (dam <sup>2</sup> )	= 100 m <sup>2</sup>	= 119.6 sq. yd.	1 square hectometer (hm <sup>2</sup> )	= 100 dam <sup>2</sup>	= 2.4710 A.	1 square kilometer (km <sup>2</sup> )	= 100 hm <sup>2</sup>	= 247.104 A. or 0.3861 sq. mi.	<p style="text-align: center;"><b>LIQUID CAPACITY MEASUREMENTS</b></p> <table border="0"> <thead> <tr> <th></th> <th style="text-align: center;"><b>Customary</b></th> <th style="text-align: center;"><b>Metric</b></th> </tr> </thead> <tbody> <tr> <td>1 gill (gi.)</td> <td></td> <td style="text-align: right;">= 7.219 cu. in. = 0.1183 l</td> </tr> <tr> <td>1 pint (pt.)</td> <td>= 4 gi.</td> <td style="text-align: right;">= 28.875 cu. in. = 0.4732 l</td> </tr> <tr> <td>1 quart (qt.)</td> <td>= 2 pt.</td> <td style="text-align: right;">= 57.75 cu. in. = 0.9463 l</td> </tr> <tr> <td>1 gallon (gal.)</td> <td>= 4 qt.</td> <td style="text-align: right;">= 231 cu. in. = 3.785 l</td> </tr> <tr> <td>1 barrel (liquids) (bbl.)</td> <td>= 31.5 gal.</td> <td style="text-align: right;">= 4.21 cu. ft. = 119.24 l</td> </tr> <tr> <td>1 barrel (petroleum) (bbl.)</td> <td>= 42 gal.</td> <td style="text-align: right;">= 5.61 cu. ft. = 158.98 l</td> </tr> </tbody> </table> <table border="0"> <thead> <tr> <th></th> <th style="text-align: center;"><b>Imperial</b></th> <th style="text-align: center;"><b>Customary</b></th> <th style="text-align: center;"><b>Metric</b></th> </tr> </thead> <tbody> <tr> <td>1 imperial quart</td> <td>= 1.2009 U.S. qt.</td> <td style="text-align: right;">= 69.355 cu. in.</td> <td style="text-align: right;">= 1.13649 l</td> </tr> <tr> <td>1 imperial gallon</td> <td>= 1.2009 U.S. gal.</td> <td style="text-align: right;">= 277.420 cu. in.</td> <td style="text-align: right;">= 4.54596 l</td> </tr> </tbody> </table>		<b>Customary</b>	<b>Metric</b>	1 gill (gi.)		= 7.219 cu. in. = 0.1183 l	1 pint (pt.)	= 4 gi.	= 28.875 cu. in. = 0.4732 l	1 quart (qt.)	= 2 pt.	= 57.75 cu. in. = 0.9463 l	1 gallon (gal.)	= 4 qt.	= 231 cu. in. = 3.785 l	1 barrel (liquids) (bbl.)	= 31.5 gal.	= 4.21 cu. ft. = 119.24 l	1 barrel (petroleum) (bbl.)	= 42 gal.	= 5.61 cu. ft. = 158.98 l		<b>Imperial</b>	<b>Customary</b>	<b>Metric</b>	1 imperial quart	= 1.2009 U.S. qt.	= 69.355 cu. in.	= 1.13649 l	1 imperial gallon	= 1.2009 U.S. gal.	= 277.420 cu. in.	= 4.54596 l
	<b>Customary</b>	<b>Metric</b>																																																																													
1 square inch (sq. in.)		= 6.4516 cm <sup>2</sup>																																																																													
1 square foot (sq. ft.)	= 144 sq. in.	= 0.0929 m <sup>2</sup>																																																																													
1 square yard (sq. yd.)	= 9 sq. ft.	= 0.8361 m <sup>2</sup>																																																																													
1 square rod (sq. rd.)	= 30¼ sq. yd.	= 25.293 m <sup>2</sup>																																																																													
1 acre (A.)	= 160 sq. rd.	= 0.4047 ha																																																																													
1 square mile (sq. mi.)	= 640 A.	= 258.998 ha or 2.5899 km <sup>2</sup>																																																																													
	<b>Metric</b>	<b>Customary</b>																																																																													
1 square millimeter (mm <sup>2</sup> )		= 0.002 sq. in.																																																																													
1 square centimeter (cm <sup>2</sup> )	= 100 mm <sup>2</sup>	= 0.1549 sq. in.																																																																													
1 square decimeter (dm <sup>2</sup> )	= 100 cm <sup>2</sup>	= 15.499 sq. in.																																																																													
1 square meter (m <sup>2</sup> )	= 100 dm <sup>2</sup>	= 1.549 sq. in.																																																																													
1 square dekameter (dam <sup>2</sup> )	= 100 m <sup>2</sup>	= 119.6 sq. yd.																																																																													
1 square hectometer (hm <sup>2</sup> )	= 100 dam <sup>2</sup>	= 2.4710 A.																																																																													
1 square kilometer (km <sup>2</sup> )	= 100 hm <sup>2</sup>	= 247.104 A. or 0.3861 sq. mi.																																																																													
	<b>Customary</b>	<b>Metric</b>																																																																													
1 gill (gi.)		= 7.219 cu. in. = 0.1183 l																																																																													
1 pint (pt.)	= 4 gi.	= 28.875 cu. in. = 0.4732 l																																																																													
1 quart (qt.)	= 2 pt.	= 57.75 cu. in. = 0.9463 l																																																																													
1 gallon (gal.)	= 4 qt.	= 231 cu. in. = 3.785 l																																																																													
1 barrel (liquids) (bbl.)	= 31.5 gal.	= 4.21 cu. ft. = 119.24 l																																																																													
1 barrel (petroleum) (bbl.)	= 42 gal.	= 5.61 cu. ft. = 158.98 l																																																																													
	<b>Imperial</b>	<b>Customary</b>	<b>Metric</b>																																																																												
1 imperial quart	= 1.2009 U.S. qt.	= 69.355 cu. in.	= 1.13649 l																																																																												
1 imperial gallon	= 1.2009 U.S. gal.	= 277.420 cu. in.	= 4.54596 l																																																																												
	<p style="text-align: center;"><b>DRY CAPACITY MEASUREMENTS</b></p> <table border="0"> <thead> <tr> <th></th> <th style="text-align: center;"><b>Customary</b></th> <th style="text-align: center;"><b>Metric</b></th> </tr> </thead> <tbody> <tr> <td>1 pint (pt.)</td> <td></td> <td style="text-align: right;">= 33.600 cu. in. = 550.60 cm<sup>3</sup></td> </tr> <tr> <td>1 quart (qt.)</td> <td>= 2 pt.</td> <td style="text-align: right;">= 67.20 cu. in. = 1,101.21 cm<sup>3</sup></td> </tr> <tr> <td>1 peck (pk.)</td> <td>= 8 qt.</td> <td style="text-align: right;">= 537.61 cu. in. = 8,809.85 cm<sup>3</sup></td> </tr> <tr> <td>1 bushel (bu.)</td> <td>= 4 pk.</td> <td style="text-align: right;">= 2,150.42 cu. in. = 0.035239 m<sup>3</sup></td> </tr> <tr> <td>1 barrel (bbl.)</td> <td></td> <td style="text-align: right;">= 4.08 cu. ft. = 0.115627 m<sup>3</sup></td> </tr> </tbody> </table> <table border="0"> <thead> <tr> <th></th> <th style="text-align: center;"><b>Imperial</b></th> <th style="text-align: center;"><b>Customary</b></th> <th style="text-align: center;"><b>Metric</b></th> </tr> </thead> <tbody> <tr> <td>1 imperial dry quart</td> <td>= 1.032 U.S. qt.</td> <td style="text-align: right;">= 69.354 cu. in.</td> <td style="text-align: right;">= 1,136.5 cm<sup>3</sup></td> </tr> <tr> <td>1 imperial bushel</td> <td>= 1.032 U.S. bu.</td> <td style="text-align: right;">= 1.284 cu. ft.</td> <td style="text-align: right;">= 0.03636 m<sup>3</sup></td> </tr> </tbody> </table>		<b>Customary</b>	<b>Metric</b>	1 pint (pt.)		= 33.600 cu. in. = 550.60 cm <sup>3</sup>	1 quart (qt.)	= 2 pt.	= 67.20 cu. in. = 1,101.21 cm <sup>3</sup>	1 peck (pk.)	= 8 qt.	= 537.61 cu. in. = 8,809.85 cm <sup>3</sup>	1 bushel (bu.)	= 4 pk.	= 2,150.42 cu. in. = 0.035239 m <sup>3</sup>	1 barrel (bbl.)		= 4.08 cu. ft. = 0.115627 m <sup>3</sup>		<b>Imperial</b>	<b>Customary</b>	<b>Metric</b>	1 imperial dry quart	= 1.032 U.S. qt.	= 69.354 cu. in.	= 1,136.5 cm <sup>3</sup>	1 imperial bushel	= 1.032 U.S. bu.	= 1.284 cu. ft.	= 0.03636 m <sup>3</sup>																																																
	<b>Customary</b>	<b>Metric</b>																																																																													
1 pint (pt.)		= 33.600 cu. in. = 550.60 cm <sup>3</sup>																																																																													
1 quart (qt.)	= 2 pt.	= 67.20 cu. in. = 1,101.21 cm <sup>3</sup>																																																																													
1 peck (pk.)	= 8 qt.	= 537.61 cu. in. = 8,809.85 cm <sup>3</sup>																																																																													
1 bushel (bu.)	= 4 pk.	= 2,150.42 cu. in. = 0.035239 m <sup>3</sup>																																																																													
1 barrel (bbl.)		= 4.08 cu. ft. = 0.115627 m <sup>3</sup>																																																																													
	<b>Imperial</b>	<b>Customary</b>	<b>Metric</b>																																																																												
1 imperial dry quart	= 1.032 U.S. qt.	= 69.354 cu. in.	= 1,136.5 cm <sup>3</sup>																																																																												
1 imperial bushel	= 1.032 U.S. bu.	= 1.284 cu. ft.	= 0.03636 m <sup>3</sup>																																																																												



**MATHEMATICAL DATA AND FORMULAS**

Fraction, Decimal, and Metric Conversion Tables

**DECIMAL OF AN INCH AND OF A FOOT**

**METRIC CONVERSION FACTORS**

Fractions of Inch or Foot	Inch Equivalents to Foot Fractions	Fractions of Inch or Foot	Inch Equivalents to Foot Fractions	Fractions of Inch or Foot	Inch Equivalents to Foot Fractions	Fractions of Inch or Foot	Inch Equivalents to Foot Fractions	
	.0052	$\frac{1}{16}$	.2552	$\frac{31}{64}$	.5052	$\frac{61}{64}$	.7552	$\frac{91}{64}$
	.0104	$\frac{1}{8}$	.2604	$\frac{31}{8}$	.5104	$\frac{61}{8}$	.7604	$\frac{91}{8}$
$\frac{1}{64}$	.015625	$\frac{3}{64}$	.265625	$\frac{33}{64}$	$\frac{33}{64}$	.515625	$\frac{63}{64}$	$\frac{49}{64}$
	.0208	$\frac{1}{4}$	.2708	$\frac{33}{4}$	.5208	$\frac{63}{4}$	.7708	$\frac{93}{4}$
	.0260	$\frac{5}{16}$	.2760	$\frac{35}{16}$	.5260	$\frac{65}{16}$	.7760	$\frac{95}{16}$
$\frac{1}{32}$	.03125	$\frac{3}{8}$	.28125	$\frac{33}{8}$	$\frac{17}{32}$	.53125	$\frac{63}{8}$	$\frac{25}{32}$
	.0365	$\frac{7}{16}$	.2865	$\frac{37}{16}$	.5365	$\frac{67}{16}$	.7865	$\frac{97}{16}$
	.0417	$\frac{7}{32}$	.2917	$\frac{37}{2}$	.5417	$\frac{67}{2}$	.7917	$\frac{97}{2}$
$\frac{3}{64}$	.046875	$\frac{9}{64}$	.296875	$\frac{39}{64}$	$\frac{35}{64}$	.546875	$\frac{69}{64}$	$\frac{51}{64}$
	.0521	$\frac{5}{8}$	.3021	$\frac{35}{8}$	.5521	$\frac{65}{8}$	.8021	$\frac{95}{8}$
	.0573	$\frac{11}{16}$	.3073	$\frac{311}{16}$	.5573	$\frac{611}{16}$	.8073	$\frac{911}{16}$
$\frac{1}{16}$	.0625	$\frac{3}{4}$	.3125	$\frac{33}{4}$	$\frac{9}{16}$	.5625	$\frac{63}{4}$	$\frac{13}{16}$
	.0677	$\frac{13}{64}$	.3177	$\frac{313}{64}$	.5677	$\frac{613}{64}$	.8177	$\frac{913}{64}$
	.0729	$\frac{7}{8}$	.3229	$\frac{37}{8}$	.5729	$\frac{67}{8}$	.8229	$\frac{97}{8}$
$\frac{5}{64}$	.078125	$\frac{15}{64}$	.328125	$\frac{315}{64}$	$\frac{37}{64}$	.578125	$\frac{615}{64}$	$\frac{53}{64}$
	.0833	1	.3333	4	.5833	7	.8333	10
	.0885	$\frac{11}{16}$	.3385	$\frac{41}{16}$	.5885	$\frac{71}{16}$	.8385	$\frac{101}{16}$
$\frac{3}{32}$	.09375	$\frac{11}{32}$	.34375	$\frac{41}{32}$	$\frac{19}{32}$	.59375	$\frac{71}{32}$	$\frac{27}{32}$
	.0990	$\frac{13}{16}$	.3490	$\frac{43}{16}$	.5990	$\frac{73}{16}$	.8490	$\frac{103}{16}$
	.1042	$\frac{13}{4}$	.3542	$\frac{43}{4}$	.6042	$\frac{73}{4}$	.8542	$\frac{103}{4}$
$\frac{7}{64}$	.109375	$\frac{13}{64}$	.359375	$\frac{45}{64}$	$\frac{39}{64}$	.609375	$\frac{75}{64}$	$\frac{55}{64}$
	.1146	$\frac{13}{8}$	.3646	$\frac{43}{8}$	.6146	$\frac{73}{8}$	.8646	$\frac{103}{8}$
	.1198	$\frac{17}{16}$	.3698	$\frac{47}{16}$	.6198	$\frac{77}{16}$	.8698	$\frac{107}{16}$
$\frac{1}{8}$	.1250	$\frac{11}{2}$	.3750	$\frac{41}{2}$	$\frac{5}{8}$	.6250	$\frac{71}{2}$	$\frac{7}{8}$
	.1302	$\frac{19}{16}$	.3802	$\frac{49}{16}$	.6302	$\frac{79}{16}$	.8802	$\frac{109}{16}$
	.1354	$\frac{15}{8}$	.3854	$\frac{45}{8}$	.6354	$\frac{75}{8}$	.8854	$\frac{105}{8}$
$\frac{9}{64}$	.140625	$\frac{111}{64}$	.390625	$\frac{411}{64}$	$\frac{41}{64}$	.640625	$\frac{711}{64}$	$\frac{57}{64}$
	.1458	$\frac{13}{4}$	.3958	$\frac{43}{4}$	.6458	$\frac{73}{4}$	.8958	$\frac{103}{4}$
	.1510	$\frac{113}{64}$	.4010	$\frac{413}{64}$	.6510	$\frac{713}{64}$	.9010	$\frac{1013}{64}$
$\frac{5}{32}$	.15625	$\frac{17}{32}$	.40625	$\frac{47}{32}$	$\frac{21}{32}$	.65625	$\frac{77}{32}$	$\frac{29}{32}$
	.1615	$\frac{113}{16}$	.4115	$\frac{413}{16}$	.6615	$\frac{713}{16}$	.9115	$\frac{1013}{16}$
	.1667	2	.4167	5	.6667	8	.9167	11
$\frac{11}{64}$	.171875	$\frac{21}{64}$	.421875	$\frac{51}{64}$	$\frac{43}{64}$	.671875	$\frac{81}{64}$	$\frac{59}{64}$
	.1771	$\frac{21}{8}$	.4271	$\frac{51}{8}$	.6771	$\frac{81}{8}$	.9271	$\frac{111}{8}$
	.1823	$\frac{21}{16}$	.4323	$\frac{53}{16}$	.6823	$\frac{83}{16}$	.9323	$\frac{113}{16}$
$\frac{3}{16}$	.1875	$\frac{21}{4}$	.4375	$\frac{51}{4}$	$\frac{11}{16}$	.6875	$\frac{81}{4}$	$\frac{15}{16}$
	.1927	$\frac{25}{16}$	.4427	$\frac{55}{16}$	.6927	$\frac{85}{16}$	.9427	$\frac{115}{16}$
	.1979	$\frac{23}{8}$	.4479	$\frac{53}{8}$	.6979	$\frac{83}{8}$	.9479	$\frac{113}{8}$
$\frac{13}{64}$	.203125	$\frac{27}{64}$	.453125	$\frac{57}{64}$	$\frac{45}{64}$	.703125	$\frac{87}{64}$	$\frac{61}{64}$
	.2083	$\frac{21}{4}$	.4583	$\frac{51}{4}$	.7083	$\frac{81}{4}$	.9583	$\frac{111}{4}$
	.2135	$\frac{29}{16}$	.4635	$\frac{59}{16}$	.7135	$\frac{89}{16}$	.9635	$\frac{119}{16}$
$\frac{7}{32}$	.21875	$\frac{13}{32}$	.46875	$\frac{55}{32}$	$\frac{23}{32}$	.71875	$\frac{85}{32}$	$\frac{31}{32}$
	.2240	$\frac{211}{64}$	.4740	$\frac{511}{64}$	.7240	$\frac{811}{64}$	.9740	$\frac{1111}{64}$
	.2292	$\frac{23}{4}$	.4792	$\frac{53}{4}$	.7292	$\frac{83}{4}$	.9792	$\frac{113}{4}$
$\frac{15}{64}$	.234375	$\frac{213}{64}$	.484375	$\frac{513}{64}$	$\frac{47}{64}$	.734375	$\frac{813}{64}$	$\frac{63}{64}$
	.2396	$\frac{27}{8}$	.4896	$\frac{57}{8}$	.7396	$\frac{87}{8}$	.9896	$\frac{117}{8}$
	.2448	$\frac{213}{16}$	.4948	$\frac{513}{16}$	.7448	$\frac{813}{16}$	.9948	$\frac{1113}{16}$
$\frac{1}{4}$	.2500	3	.5000	6	$\frac{3}{4}$	.7500	9	12

**METRIC TO AMERICAN**

- Millimeters ÷ 25.4 = inches
- Centimeters × 0.3937 = inches
- Meters × 39.27 = inches
- Millimeters × 0.003281 = feet
- Centimeters × 0.03281 = feet
- Meters × 3.281 = feet
- Meters × 1.094 = yards
- Kilometers × 0.621 = miles
- Kilometers × 3280.7 = feet
- Square millimeters ÷ 645.1 = square inches
- Square centimeters ÷ 6.451 = square inches
- Square meters × 10.764 = square feet
- Square kilometers × 247.1 = acres
- Hectares × 2.471 = acres
- Cubic centimeters ÷ 16.383 = cubic inches
- Cubic meters × 35.315 = cubic feet
- Cubic meters × 1.308 = cubic yards
- Cubic meters × 264.2 = gallons
- Liters × 61.022 = cubic inches
- Liters × 0.2642 = gallons
- Liters ÷ 28.316 = cubic feet
- Hectoliters × 3.531 = cubic feet
- Hectoliters × 2.84 = bushels
- Hectoliters × 0.131 = cubic yards
- Hectoliters × 26.42 = gallons
- Kilograms × 2.2046 = pounds
- Kilograms ÷ 1102.3 = tons

**AMERICAN TO METRIC**

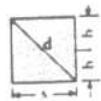
- Inches × 25.4 = millimeters
- Inches × 2.54 = centimeters
- Inches × 0.0254 = meters
- Feet × 304.8 = millimeters
- Feet × 30.48 = centimeters
- Feet × 0.3048 = meters
- Yards × 0.9143 = meters
- Miles × 1.6093 = kilometers
- Feet ÷ 3280.7 = kilometers
- Square inches × 645.1 = square millimeters
- Square inches × 6.451 = square centimeters
- Square feet ÷ 10.764 = square meters
- Acres ÷ 247.1 = square kilometers
- Acres ÷ 2.471 = hectares
- Cubic inches × 16.383 = cubic centimeters
- Cubic feet ÷ 35.315 = cubic meters
- Cubic yards ÷ 1.308 = cubic meters
- Gallons (231 cu. in.) ÷ 264.2 = cubic meters
- Cubic inches ÷ 61.022 = liters
- Gallons × 3.78 = liters
- Cubic feet × 28.316 = liters
- Cubic feet ÷ 3.531 = hectoliters
- Bushels ÷ 2.84 = hectoliters
- Cubic yards ÷ 0.131 = hectoliters
- Gallons ÷ 26.42 = hectoliters
- Pounds ÷ 2.2046 = kilograms
- Tons × 1102.3 = kilograms

**METRIC MEASURES**

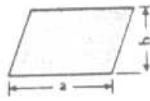
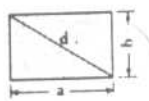
Linear	Liquid and Dry	Weights
10 millimeters = 1 centimeter	10 milliliters = 1 centiliter	10 milligrams = 1 centigram
10 centimeters = 1 decimeter	10 centiliters = 1 deciliter	10 centigrams = 1 decigram
10 decimeters = 1 METER (m)	10 deciliters = 1 LITER (l)	10 decigrams = 1 GRAM (g)
10 meters = 1 decameter	10 liters = 1 decaliter	10 grams = 1 decagram
10 decameters = 1 hectometer	10 decaliters = 1 hectoliter	10 decagrams = 1 hectogram
10 hectometers = 1 kilometer	10 hectoliters = 1 kiloliter	10 hectograms = 1 kilogram

**MATHEMATICAL DATA AND FORMULAS**

**Areas of Plane Figures**



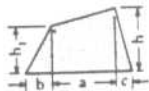
**Square**  
 Diagonal =  $d = s\sqrt{2}$ .  
 Area =  $s^2 = 4b^2 = 0.5d^2$ .  
 Example.  $s = 6$ ;  $b = 3$ . Area =  $(6)^2 = 36$  Ans.  
 $d = 6 \times 1.414 = 8.484$  Ans.



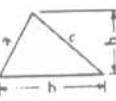
**Rectangle and Parallelogram**  
 Area =  $ab$  or  $b\sqrt{d^2 - b^2}$   
 Example.  $a = 6$ ;  $b = 3$ .  
 Area =  $3 \times 6 = 18$  Ans



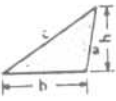
**Trapezoid**  
 Area =  $\frac{1}{2}h(a + b)$   
 Example.  $a = 2$ ;  $b = 4$ ;  $h = 3$ .  
 Area =  $\frac{1}{2} \times 3(2 + 4) = 9$  Ans.



**Trapezium**  
 Area =  $\frac{1}{2}h(a + b^1) + bh^1 + ch^1$   
 Example.  $a = 4$ ;  $b = 2$ ;  $c = 2$ ;  $h = 3$ ;  $h^1 = 2$ .  
 Area =  $\frac{1}{2}4(3 + 2) + (2 \times 2) + (2 \times 3) = 15$  Ans.



**Triangles**  
 Both formulas apply to both figures  
 Area =  $\frac{1}{2}bh$ .  
 Example.  $h = 3$ ;  $b = 5$ .  
 Area =  $\frac{1}{2}(3 \times 5) = 7\frac{1}{2}$  Ans.  
 Area =  $\frac{\sqrt{S(S-a)(S-b)(S-c)}}{2}$  when  $S = \frac{a+b+c}{2}$



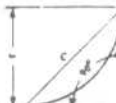
Example.  $a = 2$ ;  $b = 3$ ;  $c = 4$ .  
 $S = \frac{2+3+4}{2} = 4.5$   
 Area =  $\frac{\sqrt{4.5(4.5-2)(4.5-3)(4.5-4)}}{2} = 2.9$  Ans.



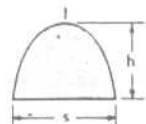
**Regular Polygons**

5 sides	= 1.720477 S <sup>2</sup>	= 3.63271 r <sup>2</sup>
6 "	= 2.598150 S <sup>2</sup>	= 5.46410 r <sup>2</sup>
7 "	= 3.633875 S <sup>2</sup>	= 8.37101 r <sup>2</sup>
8 "	= 4.828427 S <sup>2</sup>	= 13.1368 r <sup>2</sup>
9 "	= 6.181875 S <sup>2</sup>	= 19.27573 r <sup>2</sup>
10 "	= 7.694250 S <sup>2</sup>	= 27.4920 r <sup>2</sup>
11 "	= 9.365675 S <sup>2</sup>	= 38.2993 r <sup>2</sup>
12 "	= 11.198300 S <sup>2</sup>	= 52.1539 r <sup>2</sup>

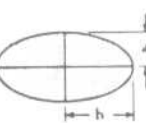
$n$  = number of sides;  $r$  = short radius;  
 $S$  = length of side;  $R$  = long radius.  
 Area =  $\frac{n}{4} S^2 \cot. \frac{180^\circ}{n} = \frac{n}{2} R^2 \sin. \frac{360^\circ}{n}$   
 $= nr^2 \tan \frac{180^\circ}{n}$



**Spandrel**  
 Area =  $0.2146r^2 = 0.1073c^2$   
 Example.  $r = 3$   
 Area =  $0.2146 \times 3^2 = 1.9314$  Ans



**Parabola**  
 $l$  = length of curved line = periphery -  $s$   
 $l = \frac{s^2}{8h} [\sqrt{c(1+c)} + 2.0326 \times \log(\sqrt{c+1} + c)]$   
 in which  $c = (\frac{4h}{s})^2$   
 Area =  $\frac{2}{3}sh$   
 Example.  $s = 3$ ;  $h = 4$   
 Area =  $\frac{2}{3} \times 3 \times 4 = 8$  Ans.

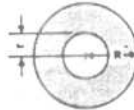


**Ellipse**  
 Area =  $\pi ab = 3.1416ab$   
 Circum. =  $2\pi \sqrt{\frac{a^2 + b^2}{2}}$  (close approximation)  
 Example.  $a = 3$ ;  $b = 4$ .  
 Area =  $3.1416 \times 3 \times 4 = 37.6992$ , Ans.  
 Circum. =  $2 \times 3.1416 \sqrt{\frac{(3)^2 + (4)^2}{2}}$   
 $= 6.2832 \times 3.5355 = 22.21$  Ans.



**Circle**  
 $\pi = 3.1416$ ;  $A$  = area;  $d$  = diameter;  $p$  = circumference or periphery;  $r$  = radius.  
 Area =  $0.7854d^2 = 3.1416d^2$ .  $p = 2\sqrt{\pi A} = 3.54\sqrt{A}$   
 $p = 2\pi r = 6.2832r$ .  $p = \frac{2A}{r} = \frac{4A}{d}$

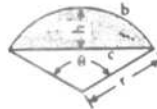
$d = \frac{p}{\pi} = \frac{p}{3.1416}$   $d = 2\sqrt{\frac{A}{\pi}} = 1.128\sqrt{A}$   
 $r = \frac{p}{2\pi} = \frac{p}{6.2832}$   $r = \sqrt{\frac{A}{\pi}} = 0.564\sqrt{A}$   
 $A = \frac{\pi d^2}{4} = 0.7854d^2$   $A = \frac{p^2}{4\pi} = \frac{p^2}{12.57}$   
 $A = \pi r^2 = 3.1416r^2$   $A = \frac{pr}{2} = \frac{pd}{4}$



**Circular Ring**  
 Area =  $\pi(R^2 - r^2) = 3.1416(R^2 - r^2)$   
 Area =  $0.7854(D^2 - d^2) = 0.7854(D - d)(D + d)$   
 Area = difference in areas between the inner and outer circles.  
 Example.  $R = 4$ ;  $r = 2$ .  
 Area =  $3.1416(4^2 - 2^2) = 37.6992$  Ans.



**Quadrant**  
 Area =  $\frac{\pi r^2}{4} = 0.7854r^2 = 0.3927c^2$ .  
 Example.  $r = 3$ .  $c$  = chord.  
 Area =  $.7854 \times 3^2 = 7.0686$  Ans.



**Segment**  
 $b$  = length of arc.  $\theta$  = angle in degrees  
 $c$  = chord =  $\sqrt{4(r^2 - h^2)}$   
 Area =  $\frac{1}{2}[br - c(r - h)]$   
 $= \pi r^2 \frac{\theta}{360} - \frac{c(r - h)}{2}$   
 When  $\theta$  is greater than  $180^\circ$  then  $\frac{c}{2} \times$  difference between  $r$  and  $h$  is added to the fraction  $\frac{\pi r^2 \theta}{360}$

Example.  $r = 3$ ;  $\theta = 120^\circ$ ;  $h = 1.5$   
 Area =  $3.1416 \times 3^2 \times \frac{120}{360} - \frac{5.196(3 - 1.5)}{2}$   
 $= 5.5278$  Ans.



**Sector**  
 Area =  $\frac{br}{2} = \pi r^2 \frac{\theta}{360}$   
 $\theta$  = angle in degrees;  $b$  = length of arc.  
 Example.  $r = 3$ ;  $\theta = 120^\circ$   
 Area =  $3.1416 \times 3^2 \times \frac{120}{360} = 9.4248$  Ans.

FORM	METHOD OF FINDING AREAS
TRIANGLE	Base $\times \frac{1}{2}$ perpendicular height. $\sqrt{s(s-a)(s-b)(s-c)}$ , $s = \frac{1}{2}$ sum of the three sides $a, b, c$
TRAPEZIUM	Sum of area of the two triangles
TRAPEZOID	$\frac{1}{2}$ sum of parallel sides $\times$ perpendicular height
PARALLELOGRAM	Base $\times$ perpendicular height
REG POLYGON	$\frac{1}{2}$ sum of sides $\times$ inside radius
CIRCLE	$\pi r^2 = 0.7854d^2$ or $\text{diam}^2 \times 0.7854$ or circumference $\times r$
SECTOR OF A CIRCLE	$\frac{\pi A}{360} = 0.0087266 r^2 A^\circ$ , $A^\circ$ = arc $\times 7$ radius
SEGMENT OF A CIRCLE	$\frac{1}{2} (r^2 A^\circ - cr(r-h))$
CIRCLE (of same dia. as square)	Diameter $\times$ side $\times 0.7854$
SQUARE (of same dia. as circle)	Side $\times$ diameter $\times 0.63662$
ELLIPSE	Long diameter $\times$ short diameter $\times 0.7854$
PARABOLA	Base $\times \frac{2}{3}$ perpendicular height

## MATHEMATICAL DATA AND FORMULAS

Functions of Numbers

TABLE 20 Functions of Numbers

NO.	SQUARE	CUBE	SQUARE ROOT	CUBE ROOT	LOGARITHM	1000 X RECIPROCAL	NO. - DIAMETER	
							CIRCUM.	AREA
1	1	1	1.0000	1.0000	0.00000	1000.000	3.142	0.7854
2	4	8	1.4142	1.2599	0.30103	500.000	6.283	3.1416
3	9	27	1.7321	1.4422	0.47712	333.333	9.425	7.0686
4	16	64	2.0000	1.5874	0.60206	250.000	12.566	12.5664
5	25	125	2.2361	1.7100	0.69897	200.000	15.708	19.6350
6	36	216	2.4495	1.8171	0.77815	166.667	18.850	28.2743
7	49	343	2.6458	1.9129	0.84510	142.857	21.991	38.4845
8	64	512	2.8284	2.0000	0.90309	125.000	25.133	50.2655
9	81	729	3.0000	2.0801	0.95424	111.111	28.274	63.6173
10	100	1000	3.1623	2.1544	1.00000	100.000	31.416	78.5398
11	121	1331	3.3166	2.2240	1.04139	90.9091	34.558	95.0332
12	144	1728	3.4641	2.2894	1.07918	83.3333	37.699	113.097
13	169	2197	3.6056	2.3513	1.11394	76.9231	40.841	132.732
14	196	2744	3.7417	2.4101	1.14613	71.4286	43.982	153.938
15	225	3375	3.8730	2.4662	1.17609	66.6667	47.124	176.715
16	256	4096	4.0000	2.5198	1.20412	62.5000	50.265	201.062
17	289	4913	4.1231	2.5713	1.23045	58.8235	53.407	226.980
18	324	5832	4.2426	2.6207	1.25527	55.5556	56.549	254.469
19	361	6859	4.3589	2.6684	1.27875	52.6316	59.690	283.529
20	400	8000	4.4721	2.7144	1.30103	50.0000	62.832	314.159
21	441	9261	4.5826	2.7589	1.32222	47.6190	65.973	346.361
22	484	10648	4.6904	2.8020	1.34242	45.4545	69.115	380.133
23	529	12167	4.7958	2.8439	1.36173	43.4783	72.257	415.476
24	576	13824	4.8990	2.8845	1.38021	41.6667	75.398	452.389
25	625	15625	5.0000	2.9240	1.39794	40.0000	78.540	490.874
26	676	17576	5.0990	2.9625	1.41497	38.4615	81.681	530.929
27	729	19683	5.1962	3.0000	1.43136	37.0370	84.823	572.555
28	784	21952	5.2915	3.0366	1.44716	35.7143	87.965	615.752
29	841	24389	5.3852	3.0723	1.46240	34.4828	91.106	660.520
30	900	27000	5.4772	3.1072	1.47712	33.3333	94.248	706.858
31	961	29791	5.5678	3.1414	1.49136	32.2581	97.389	754.768
32	1024	32768	5.6569	3.1748	1.50515	31.2500	100.531	804.248
33	1089	35937	5.7446	3.2075	1.51851	30.3030	103.673	855.299
34	1156	39304	5.8310	3.2396	1.53148	29.4118	106.814	907.920
35	1225	42875	5.9161	3.2711	1.54407	28.5714	109.956	962.113
36	1296	46656	6.0000	3.3019	1.55630	27.7778	113.097	1017.88
37	1369	50653	6.0828	3.3322	1.56820	27.0270	116.239	1075.21
38	1444	54872	6.1644	3.3620	1.57978	26.3158	119.381	1134.11
39	1521	59319	6.2450	3.3912	1.59106	25.6410	122.522	1194.59
40	1600	64000	6.3246	3.4200	1.60206	25.0000	125.66	1256.64
41	1681	68921	6.4031	3.4482	1.61278	24.3902	128.81	1320.25
42	1764	74088	6.4807	3.4760	1.62325	23.8095	131.95	1385.44
43	1849	79507	6.5574	3.5034	1.63347	23.2558	135.09	1452.20
44	1936	85184	6.6332	3.5303	1.64345	22.7273	138.23	1520.53
45	2025	91125	6.7082	3.5569	1.65321	22.2222	141.37	1590.43

## MATHEMATICAL DATA AND FORMULAS

## Functions of Numbers

TABLE 20 Functions of Numbers (Continued)

NO.	SQUARE	CUBE	SQUARE ROOT	CUBE ROOT	LOGARITHM	1000 x RECIPROCAL	NO. - DIAMETER	
							CIRCUM.	AREA
46	2116	97336	6.7823	3.5830	1.66276	21.7391	144.51	1661.90
47	2209	103823	6.8557	3.6088	1.67210	21.2766	147.65	1734.94
48	2304	110592	6.9282	3.6342	1.68124	20.8333	150.80	1809.56
49	2401	117649	7.0000	3.6593	1.69020	20.4082	153.94	1885.74
50	2500	125000	7.0711	3.6840	1.69897	20.0000	157.08	1963.50
51	2601	132651	7.1414	3.7084	1.70757	19.6078	160.22	2042.82
52	2704	140608	7.2111	3.7325	1.71600	19.2308	163.36	2123.72
53	2809	148877	7.2801	3.7563	1.72428	18.8679	166.50	2206.18
54	2916	157464	7.3485	3.7798	1.73239	18.5185	169.65	2290.22
55	3025	166375	7.4162	3.8030	1.74036	18.1818	172.79	2375.83
56	3136	175616	7.4833	3.8259	1.74819	17.8571	175.93	2463.01
57	3249	185193	7.5498	3.8485	1.75587	17.5439	179.07	2551.76
58	3364	195112	7.6158	3.8709	1.76343	17.2414	182.21	2642.08
59	3481	205379	7.6811	3.8930	1.77085	16.9492	185.35	2733.97
60	3600	216000	7.7460	3.9149	1.77815	16.6667	188.50	2827.43
61	3721	226981	7.8102	3.9365	1.78533	16.3934	191.64	2922.47
62	3844	238328	7.8740	3.9579	1.79239	16.1290	194.78	3019.07
63	3969	250047	7.9373	3.9791	1.79934	15.8730	197.92	3117.25
64	4096	262144	8.0000	4.0000	1.80618	15.6250	201.06	3216.99
65	4225	274625	8.0623	4.0207	1.81291	15.3846	204.20	3318.31
66	4356	287496	8.1240	4.0412	1.81954	15.1515	207.35	3421.19
67	4489	300763	8.1854	4.0615	1.82607	14.9254	210.49	3525.65
68	4624	314432	8.2462	4.0817	1.83251	14.7059	213.63	3631.68
69	4761	328509	8.3066	4.1016	1.83885	14.4928	216.77	3739.28
70	4900	343000	8.3666	4.1213	1.84510	14.2857	219.91	3848.45
71	5041	357911	8.4261	4.1408	1.85126	14.0845	223.05	3959.19
72	5184	373248	8.4853	4.1602	1.85733	13.8889	226.19	4071.50
73	5329	389017	8.5440	4.1793	1.86332	13.6986	229.34	4185.39
74	5476	405224	8.6023	4.1983	1.86923	13.5135	232.48	4300.84
75	5625	421875	8.6603	4.2172	1.87506	13.3333	235.62	4417.86
76	5776	438976	8.7178	4.2358	1.88081	13.1579	238.76	4536.46
77	5929	456533	8.7750	4.2543	1.88649	12.9870	241.90	4656.63
78	6084	474552	8.8318	4.2727	1.89209	12.8205	245.04	4778.36
79	6241	493039	8.8882	4.2908	1.89763	12.6582	248.19	4901.67
80	6400	512000	8.9443	4.3089	1.90309	12.5000	251.33	5026.55
81	6561	531441	9.0000	4.3267	1.90849	12.3457	254.47	5153.00
82	6724	551368	9.0554	4.3445	1.91381	12.1951	257.61	5281.02
83	6889	571787	9.1104	4.3621	1.91908	12.0482	260.75	5410.61
84	7056	592704	9.1652	4.3795	1.92428	11.9048	263.89	5541.77
85	7225	614125	9.2195	4.3968	1.92942	11.7647	267.04	5674.50
86	7396	636056	9.2736	4.4140	1.93450	11.6279	270.18	5808.80
87	7569	658503	9.3274	4.4310	1.93952	11.4943	273.32	5944.68
88	7744	681472	9.3808	4.4480	1.94448	11.3636	276.46	6082.12
89	7921	704969	9.4340	4.4647	1.94939	11.2360	279.60	6221.14
90	8100	729000	9.4868	4.4814	1.95424	11.1111	282.74	6361.73

# Credits

## 1. Planning and Design of Interior Spaces

### Residential Spaces

- Pages 5–28:** *House and Garden's Complete Guide to Interior Decoration*, edited by Richardson Wright, Simon and Schuster, New York, 1942 (copyright renewed 1970 by The Condé Nast Publications Inc.).
- Pages 29–42:** Gottshall, Franklin H., *How to Design and Construct Period Furniture*, Bonanza Books, New York, 1989.
- Page 43:** *The House and Home Book of Interior Design*, McGraw-Hill, New York, 1976.
- Page 49:** *New Spaces for Learning*, Educational Facilities Lab, New York, 1966.
- Pages 56–60:** Ramsey, Charles George, and Harold Reeve Sleeper, *Architectural Graphic Standards*, 2d Edition, Wiley, New York, 1936.
- Pages 62, 63, 81, 83, 84, 196, 197, 199:** *Architectural Forum*, October 1937.
- Pages 65–68, 71, 72, 96, 118–124, 164:** Thompson, Robinson, Toraby.
- Page 69:** Verna Cook Salomonsky, Architect.
- Page 70:** Ulrich Franzen, Architect; *Selected Architectural Details*, Reinhold, New York.
- Pages 73–76:** Parrish Hadley Associates.
- Page 80:** U.S. Department of Housing and Urban Development, Washington, D.C.
- Pages 82, 104, 105, 152:** *House Planning Handbook*, 2d Edition, MWPS-16, Midwest Plan Service, Ames, Iowa, 1988 (reproduced with permission).
- Pages 85, 86:** Lehigh Furniture Company.
- Pages 88, 89, 153, 154:** *Manual of Acceptable Practices*, U.S. Department of Housing and Urban Development, Washington, D.C.
- Pages 89, 201:** *Internal Spaces of the Dwelling*, Canada Mortgage and Housing Corporation, 1984.
- Pages 90–93, 125–127, 135, 166, 167:** Bromley/Jacobsen.
- Page 94:** Knobloch, Philip G., *Good Practice in Construction*, Pencil Points Press, New York, 1931.
- Page 95:** *Comparative Architectural Details*, Pencil Points Series (Francis Y. Joannes, Architect), 1935.
- Page 97:** Gensler Associates; ISD; Bromley/Jacobson.
- Pages 98, 99:** *American Architect and Architecture*, January 1937.
- Pages 100, 101, 149, 150, 206:** Panero, Julius, and Martin Zelnik, *Human Dimension & Interior Space*, Whitney Library of Design/Watson-Guption Publications, New York, 1979.
- Pages 102, 103, 202–204:** *Time-Saver Standards: A Manual of Essential Architectural Data*, F. W. Dodge Corporation, New York, 1946.
- Pages 106–108:** Kohler.
- Pages 109, 110, 114, 170 (bottom):** Eljer.
- Pages 111–113, 115, 116, 170 (top):** American Standard.
- Pages 117, 194, 198:** Hornbostel, Caleb, *Architectural Detailing Simplified*, Prentice-Hall, Englewood Cliffs, N.J., 1986.
- Pages 128, 156:** *A Design Guide for Home Safety*, U.S. Department of Housing and Urban Development, Washington, D.C., 1972.
- Page 129:** Space Design Group.
- Pages 130, 131:** Marble Institute of America.
- Pages 132–134, 136:** *Handbook for Ceramic Tile Installation*, Tile Council of America, Princeton, N.J., 1987.
- Pages 137–140, 181–186:** *Adaptable Housing*, Office of Policy Development and Research, U.S. Department of Housing and Urban Development, 1987.
- Pages 141, 142, 179, 180:** New York City Building Code.
- Pages 143, 146, 147, 178:** *Uniform Federal Accessibility Standards*, 1985-494-187, U.S. Government Printing Office, Washington, D.C., 1985.
- Pages 144, 187:** *Handbook for Design*, Veterans Administration, Washington, D.C.
- Pages 145, 148, 165, 168, 169, 188, 189, 191, 192:** Jerry Caldari, Architect.

**Page 151:** De Chiara, Joseph, and John Hancock Callender (eds.), *Time-Saver Standards for Building Types*, 2d Edition, McGraw-Hill, New York, 1980.  
**Page 155:** Formica Corporation.  
**Pages 157, 158, 172, 173:** Merillat.  
**Pages 159, 160:** St. Charles.  
**Pages 161–163:** Triangle Pacific Corporation.  
**Page 171:** Euroflair by Frigidaire.  
**Pages 174, 175:** *Manual of Millwork*, Woodworking Institute of California.  
**Page 193:** *Pencil Points*, April 1934.  
**Page 195:** Putnam Rolling Ladder Company.  
**Pages 196, 200, 205:** De Chiara, Joseph (ed.), *Time-Saver Standards for Residential Development*, McGraw-Hill, New York, 1984.  
**Page 199:** *Design Solutions*, Architectural Woodworking Institute, Summer 1989.  
**Page 207 (top):** *Council Notes*, University of Illinois.  
**Page 207 (bottom):** *Architectural Forum*, October 1938.  
**Page 208 (left):** General Services Administration.  
**Page 208 (right):** Illinois Agricultural Experiment Station.  
**Pages 209, 213, 214:** *Pencil Points*, 1935.  
**Pages 210 (top), 215:** Bertram Bassuk, FAIA.  
**Pages 210 (bottom), 211 (top), 212:** ISD.  
**Page 211 (bottom):** Charles D. Flayhan Associates.  
**Page 216:** Schulte.  
**Pages 217–220:** Closet Maid Systems.

## Office Spaces

**Pages 223, 224, 231, 232, 241, 249, 260:** Panero, Julius, and Martin Zelnik, *Human Dimension & Interior Space*, Whitney Library of Design/Watson-Guptill Publications, New York, 1979.  
**Pages 225, 226, 243–245:** Pulgram, William L., and Richard E. Stonis, *Designing the Automated Office*, Whitney Library of Design/Watson-Guptill Publications, New York, 1984.  
**Pages 236, 237, 240, 259, 266, 267, 271:** Gensler Associates.  
**Pages 238, 263, 268, 269, 274, 275, 298, 299, 303, 304 (top):** Charles D. Flayhan Associates.  
**Pages 239, 264, 277:** ISD.  
**Page 242:** Intergraph Corp., Interiors.  
**Pages 246–248:** *Interiors*, November 1985.  
**Pages 250, 251:** Lehigh Furniture Company.  
**Page 252:** Howe Furniture Corp.  
**Pages 256, 283–295:** Steelcase.  
**Page 256:** Panero Zelnik Associates.  
**Pages 257, 258, 270, 272:** *Design Solutions*, Architectural Woodworking Institute, Spring 1986.  
**Page 262:** Will Ching, Planning and Design.  
**Page 265:** Marble Institute of America.  
**Pages 273, 276:** Bertram Bassuk, FAIA.  
**Page 278:** De Chiara, Joseph, and John Hancock Callender (eds.), *Time-Saver Standards For Building Types*, 2d Edition, McGraw-Hill, New York, 1980.  
**Pages 279, 280, 281:** Herman Miller.  
**Page 282:** Vecta.

## Hospitality Spaces

**Pages 307, 308:** *Architectural Record*, 1943.  
**Page 312:** *Architectural Forum*; *Manual of Acceptable Practices*, U.S. Department of Housing and Urban Development, Washington, D.C.  
**Pages 316, 317, 330, 377–380:** Davies, Thomas D., Jr., and Kim A. Beasley, *Design For Hospitality: Planning for Accessible Hotels and Motels*, Nichols Publishing, New York, 1988.  
**Pages 318, 322, 346, 347:** Panero, Julius, and Martin Zelnik, *Human Dimension & Interior Space*, Whitney Library of Design/Watson-Guptill Publications, New York, 1979.  
**Pages 319, 325, 326, 328, 338, 359, 365, 368, 369:** Toni Chi and Associates.  
**Pages 319, 320:** Panero Zelnik Associates.  
**Pages 321, 329, 332, 363, 364, 366, 367, 369:** Jerry Caldari, Architect.  
**Pages 323, 324, 331:** Space Design Group.  
**Pages 327, 333, 334:** *Interiors*, October 1985.  
**Pages 335–337:** Gensler Associates.  
**Page 339:** Charles D. Flayhan Associates.  
**Pages 340–345:** ISD.

- Pages 357, 358, 362:** *Interiors*, July 1985.
- Page 360:** *Selected Architectural Details*, Reinhold, New York.
- Pages 361, 369, 370, 373, 381, 382:** *Design Solutions*, Architectural Woodworking Institute, Spring 1990.
- Pages 371, 372:** Hochheiser-Elias Design Group.
- Pages 374, 376:** De Chiara, Joseph, and John Hancock Callender (eds.), *Time-Saver Standards for Building Types*, 3d Edition, McGraw-Hill, New York, 1990.

## Retail Spaces

- Pages 387–389:** Panero, Julius, and Martin Zelnik, *Human Dimension & Interior Space*, Whitney Library of Design/Watson-Guptill Publications, New York, 1979.
- Pages 390, 394, 400:** *Selected Architectural Details*, Reinhold, New York.
- Pages 391, 392, 396–399:** *Design Solutions*, Architectural Woodworking Institute, Winter 1987, Summer 1988.
- Pages 393, 401–411:** Walker Group/CNI.
- Page 395:** Marble Institute of America.
- Pages 412–417:** Panero Zelnik Associates.
- Pages 418–422:** PAM International Co., Inc.

## Public Restrooms, Toilets, and Coatrooms

- Page 425:** New York City Building Code.
- Pages 427–430:** General Services Administration.
- Pages 431–438, 465:** Bertram Bassuk, FAIA.
- Page 439:** William Morgan, FAIA.
- Pages 440–445:** DeChiara, Joseph, *Handbook of Architectural Details for Commercial Buildings*, McGraw-Hill, New York, 1980.
- Page 446:** Toni Chi and Associates.
- Pages 447, 448:** American Sanitary Partition Corporation.
- Pages 449–451:** *Access America*, Architectural and Transportation Barriers Compliance Board, Washington, D.C., 1980.
- Page 452:** *Uniform Federal Accessibility Standards*, 1985-494-187, U.S. Government Printing Office, Washington, D.C., 1985.
- Page 453:** A & J Washroom Accessories.
- Pages 454–457:** Parker/Nutone.
- Pages 458, 459:** American Specialties, Inc.
- Pages 461–463:** Rallex.
- Page 464:** Jerry Caldari, Architect.

## 2. Construction Details and Finishes

- Pages 471, 472, 518, 542, 547, 660–664, 727:** *Time-Saver Standards: A Manual of Essential Architectural Data*, F. W. Dodge Corp., New York, 1946.
- Pages 470, 517:** McQuade, Walter (ed.), *Schoolhouse*, Simon and Schuster, New York, 1958.
- Pages 473, 475–477:** New York State Building Code.
- Pages 474, 478, 565:** Hornung, William J., *Reinhold Data Sheets*, Reinhold, New York, 1965.
- Pages 480, 487, 489, 491, 497, 500–502, 512–515, 522–526, 532, 540, 541 (top), 577–579, 581–588, 601, 606, 608, 609, 614, 617, 629, 630–632, 648, 657, 658, 692 (bottom), 698, 708, 714, 721, 722, 751 (bottom):** Bertram Bassuk, FAIA.
- Pages 481–483, 484 (bottom), 490 (bottom), 629, 649, 651 (top), 652, 754, 755 (top):** ISD.
- Pages 484 (top), 485, 488, 492, 493, 495, 496, 529, 530, 534, 564, 653, 654, 656, 751 (top), 752, 753:** Gensler Associates.
- Pages 486, 580, 605, 659, 669 (top):** William Morgan, FAIA.
- Pages 490 (top), 650, 651 (bottom):** Charles D. Flayhan Associates.
- Pages 491, 754 (top), 755 (bottom):** Michael Lynn Associates.
- Pages 494, 543, 548, 549, 627, 628, 634:** Anderson, L. O., *Wood-Frame House Construction*, Department of Agriculture Handbook No. 73, U.S. Government Printing Office, Washington, D.C., 1970.
- Pages 498, 550:** *Wood Frame Design*, Western Wood Products Association.
- Pages 499, 504, 758, 759:** Panero Zelnik Associates.
- Pages 503, 508, 510, 616, 633, 665, 704, 705, 738:** Knobloch, Philip G., *Good Practice in Construction*, Pencil Points Press, New York, 1931.
- Pages 505, 506, 561–563:** *Handbook for Ceramic Tile Installation*, Tile Council of America, Princeton, N.J., 1988.



Pages 507, 554–560: American Olean Tile.  
 Pages 509, 520, 715, 733–735: Marble Institute of America.  
 Page 519: Radford, William, *Architectural Details*, R. D. Radford, Chicago, 1938.  
 Pages 521, 749, 750: Callender, John Hancock (ed.), *Time-Saver Standards for Architectural Design Data*, 6th Edition, McGraw-Hill, New York, 1982.  
 Pages 527, 528 (top): Walker Group/CNI.  
 Pages 531, 551: Roppe Rubber Corp.  
 Page 533: *American Architect and Architecture*, May 1932.  
 Pages 535–539: National Terrazzo and Mosaic Association, Inc.  
 Page 541: Buckingham Virginia Slate Co.  
 Page 544: American Parquet Association.  
 Page 545: Hoboken Wood Flooring Co.  
 Page 546: Tarkett.  
 Page 553: Franciscan Tile Company.  
 Pages 566–571, 574–576, 589–599, 607: Hollow Metal Manufacturers Association.  
 Pages 572, 670, 671, 706: Jerry Caldari, Architect.  
 Page 573: *Methods and Materials of Commercial Construction*.  
 Page 600: *New York State Construction Handbook*.  
 Pages 602, 603, 678–684, 687, 689, 695, 696, 710, 711, 742: Baker, Earl P., and Harold S. Langland, *Architectural Metal Handbook*, National Association of Ornamental Metal Manufacturers, Washington, D.C., 1947.  
 Page 604: General Services Administration.  
 Page 610: Eggers Industries.  
 Pages 611, 675: Raymond, Antonin, *Architectural Details*, Architectural Book Publishing Co., Inc., 1947.  
 Pages 612, 666: Burbank, Nelson L., *House Construction Details*, 3d Edition, Simmons-Boardman Publishing Corp., New York, 1952.  
 Page 615: Thompson, Robinson, Toraby.  
 Page 618: *Progressive Architecture*, April 1971.  
 Pages 620–626: *Comparative Architectural Details*, Pencil Points Series (Frank J. Forster, Architect), 1935.  
 Pages 637–640: Schlage.  
 Pages 641–643: New York City Building Code.  
 Pages 644–647: Sweet's Catalog.  
 Pages 655, 707, 769, 771–773: Toni Chi and Associates.  
 Page 667: *Design Solutions*, Architectural Woodworking Institute.  
 Page 668: Simon B. Zelnik, FAIA.  
 Page 672: *Interiors*, April 1985.  
 Page 673: Feirer, John L., *Cabinet Making and Millwork*, Charles A. Bennet Co., Peoria, Ill.  
 Page 674: Ascente.  
 Page 676, 712: *Selected Architectural Details*, Reinhold, New York.  
 Pages 677, 685, 686, 688, 690, 691, 692 (top), 693, 694, 697, 699–703, 709: National Association of Architectural Manufacturers.  
 Page 713: New York City Housing Authority.  
 Page 716: Slate Institute.  
 Page 717: *Manual of School Planning*, New York City Board of Education.  
 Pages 718, 719, 723: *Uniform Federal Accessibility Standards*, 1985-494-187, U.S. Government Printing Office, Washington, D.C., 1985.  
 Page 720: Lapeyre Stair.  
 Page 726: *Farmers Bulletin #1889*, U.S. Department of Agriculture, Washington, D.C., 1971.  
 Pages 728, 729: *Handbook of Successful Fireplaces*, Dunley Bros. Co., Cleveland, Ohio, 1961.  
 Page 731: *Pencil Points* (Ely Jacques Kahn, Architect), October 1938.  
 Page 732: *Pencil Points* (Richard Neutra, Architect), 1938.  
 Page 736: *Pencil Points* (Frank Forster, Architect).  
 Page 737: *Pencil Points* (Walker & Gillette, Architects).  
 Pages 739–741: Architectural Paneling, Inc.  
 Pages 743, 744, 778: General Electric Company.  
 Pages 745–748: Nessen Lamp Company.  
 Pages 756, 757: Horton Lees Lighting Designs, Inc.  
 Pages 760–762: Space Design Group.  
 Pages 763, 764: Bromley/Jacobsen.  
 Page 765: *Architectural Lighting*, September 1987.  
 Pages 766, 768: Roberts Step Lite Systems, Inc.  
 Pages 767, 770, 774: National Cathode Corp.  
 Page 775: Philips Lighting Co.  
 Pages 776, 777: Just Bulbs Ltd.



### 3. Architectural Woodwork

- Pages 781, 785–787:** *Time-Saver Standards: A Manual of Essential Architectural Data*, F. W. Dodge Corp., New York, 1946.
- Pages 782–784, 788–797, 801–803:** Woodworking Institute of California.
- Pages 798–800, 872, 873, 877, 879, 881–883:** Architectural Woodwork Institute.
- Page 804:** Leroy P. Ward, Architect.
- Page 806:** *Comparative Architectural Details*, Pencil Points Series (Frank J. Forster, Architect), 1935.
- Page 807:** *Comparative Architectural Details*, Pencil Points Series (Evans, Moore, Peterson & Woodbridge, Architects), 1935.
- Pages 812, 813, 839 (right), 842, 845, 847, 848, 849 (bottom), 853–856, 859, 862–864:** *Design Solutions*.
- Pages 814, 815:** Space Design Group; ISD.
- Page 816:** *Selected Architectural Details*, Progressive Architecture (Perkins & Wills, Architects).
- Pages 808–810, 851:** Knobloch, Philip G., *Good Practice in Construction*, Pencil Points Press, New York, 1931.
- Page 818:** Thompson, Robinson, Cecil, Inc.
- Pages 819–823, 829, 831–835:** Bertram Bassuk, FAIA.
- Pages 824, 828, 836–838:** Charles D. Flayhan Associates.
- Page 825:** ISD.
- Page 826, 827, 830, 839 (left), 846:** Gensler Associates.
- Pages 840, 841:** Winebarger Church Furniture.
- Page 843:** Panero Zelnik Associates.
- Page 844:** Hochheiser-Elias.
- Pages 849 (top), 852:** General Services Administration.
- Page 850:** Roger H. Ballard, Architect.
- Page 857:** Hyde and Shepherd, Architects.
- Page 858:** Howard and Frenaye, Architects.
- Pages 860, 861:** *Comparative Architectural Details*, Pencil Points.
- Page 865:** *Manual of Millwork*, Woodworking Institute of California.
- Pages 866–870, 886:** Architectural Paneling, Inc.
- Pages 871, 873–878, 880–885:** Camden Window and Millwork.
- Pages 887–889:** Joyce, Ernest, *Encyclopedia of Furniture Making*, Sterling Publishing Co., Inc., New York, 1987.
- Pages 890–902:** Hafele.

### 4. Specialties

- Pages 906–915:** Everett Conklin and Susan Korner, in Alpern, Andrew (ed.), *Handbook of Specialty Elements in Architecture*, McGraw-Hill, New York, 1982.
- Pages 916–922, 923 (top):** *The Green Scene*, National Park Service, U.S. Department of the Interior, Washington, D.C., 1973.
- Pages 923 (bottom), 924–926, 929, 930:** Engel/GGP.
- Pages 927, 928:** Hornbostel, Caleb, *Architectural Detailing Simplified*, Prentice-Hall, Englewood Cliffs, N.J., 1986.
- Pages 931–935, 940, 941, 943, 945–948:** Fred T. Knowles, in Alpern, Andrew (ed.), *Handbook of Specialty Elements in Architecture*, McGraw-Hill, New York, 1982.
- Pages 936–939:** Designers Sign Company/Frank Rispoli.
- Pages 942–944:** U.S. Department of Transportation, Washington, D.C.
- Pages 949–957:** Jerome Menell, in Alpern, Andrew (ed.), *Handbook of Specialty Elements in Architecture*, McGraw-Hill, New York, 1982.
- Pages 961–964:** Hussey Seating Company.
- Pages 965, 966, 968–976:** J.G. Furniture Systems.
- Page 967:** *Design Guide for Music and Drama Centers*, Department of the Army, Washington, D.C., 1981.
- Pages 977–997:** *A Design Guide for Improving Residential Security*, U.S. Department of Housing and Urban Development, Washington, D.C., 1973.
- Pages 998, 1002, 1028:** *The House and Home Book of Interior Design*, McGraw-Hill, New York, 1979.
- Pages 999, 1013, 1014:** Halse, *The Use of Color in Interiors*, McGraw-Hill, New York, 1968.
- Pages 1000, 1001, 1003–1012:** Derieux, Mary, and Isabelle Stevenson, *The Complete Book of Interior Decorating*, Greystone Press, New York, 1950.
- Pages 1023–1026:** Anderson, L. O., *Wood-Frame House Construction*, Department of Agriculture Handbook No. 73, U.S. Government Printing Office, Washington, D.C., 1970.
- Page 1016:** McQuade, Walter (ed.), *Schoolhouse*, Simon and Schuster, New York, 1958.
- Pages 1017–1020:** Sweet's Catalog.
- Page 1021:** Marvin Windows.

**Pages 1056–1059:** Kirsch.  
**Page 1060:** Armor Elevator.  
**Pages 1061–1064:** Dover Elevator Co.  
**Pages 1065, 1066, 1102:** *Uniform Federal Accessibility Standards*, 1985-494-187, U.S. Government Printing Office, Washington, D.C., 1985.  
**Page 1067:** Panero Zelnik Associates.  
**Pages 1067–1074:** *Outdoor Sports Facilities*, Departments of the Army, Navy, and Air Force, Washington, D.C.  
**Page 1068 (top):** Mace, Ronald L., *An Illustrated Handbook of the Handicapped Section of the North Carolina State Building Code*, Raleigh, N.C., 1974.  
**Pages 1075–1078:** Cutler Manufacturing.  
**Page 1079:** Phillips and Brooks, Inc.  
**Pages 1080–1086:** Baker, Earl P., and Harold S. Langland, *Architectural Metal Handbook*, National Association of Ornamental Metal Manufacturers, Washington, D.C., 1947.  
**Pages 1087–1089:** Brown Manufacturing Co.  
**Page 1090:** Bertram Bassuk, FAIA.  
**Pages 1091–1096:** Pittcon Softforms.  
**Pages 1097–1099:** Alvarado Manufacturing Co.  
**Pages 1100–1101:** Haws.

## 5. General Reference Data

**Pages 1106–1109:** Ballast, David Kent, *Architect's Handbook of Formulas, Tables, and Mathematical Calculations*, Prentice-Hall, Englewood Cliffs, N.J., 1988.  
**Pages 1110, 1111:** Panero, Julius, and Martin Zelnik, *Human Dimension & Interior Space*, Whitney Library of Design/Watson-Guptill Publications, New York, 1979.  
**Pages 1112, 1113:** *Access America*, Washington, D.C.  
**Pages 1114 (top):** Sister Kenny Institute.  
**Pages 1114 (bottom), 1115–1118:** *Uniform Federal Accessibility Standards*, 1985-494-187, U.S. Government Printing Office, Washington, D.C., 1985.  
**Pages 1119, 1120:** Woodson, W. E., *Human Factors Design Handbook*, McGraw-Hill, New York, 1981.  
**Page 1121:** *Building for People*, U.S. Department of Commerce, Washington, D.C.  
**Pages 1123–1125:** Foster, Norman, *Practical Tables for Building Construction*, McGraw-Hill, New York, 1963.  
**Page 1128:** Halse, *The Use of Color in Interiors*, McGraw-Hill, New York, 1968.  
**Page 1129:** Hornbostel, Caleb, *Architectural Detailing Simplified*, Prentice-Hall, Englewood Cliffs, N.J., 1986.  
**Pages 1130, 1131:** Derieux, Mary, and Isabelle Stevenson, *The Complete Book of Interior Decorating*, Greystone Press, New York, 1950.  
**Pages 1132, 1134:** Steelcase.  
**Page 1133:** *National Electrical Code Book*, McGraw-Hill, New York, 1981.  
**Page 1135:** Indiana Limestone Institute.  
**Pages 1137, 1138:** Wing, Charles, *The Visual Handbook of Building and Remodeling*, Rodale Press, 1990.  
**Pages 1139–1142:** *Time-Saver Standards: A Manual of Essential Architectural Data*, F. W. Dodge Corp., New York, 1946.

# Index

- Accessible bathrooms, 143–148, 317, 380, 449–452
- Accessible design, 317, 330, 377–380, 449–452, 1065, 1066, 1068, 1102  
(*See also* Barrier-free design)
- Accessories, 1075–1102
  - chalkboards, 1090
  - column covers, 1091–1096
  - drinking fountains, 1100–1102
  - fireplaces, 742
  - grilles, 1080–1086
  - guards, protection, 1087–1088
  - handrails, 1089
  - key cabinets, 1078
  - letter boxes, 1075
  - lockers, parcel, 1078
  - mail chutes, 1078
  - mail collection boxes, 1076
  - mail drops, 1077
  - telephone booths, 1079
  - turnstile, 1097–1099
  - water coolers, 1100–1102
- Accessory heights, toilets, 117, 128
- Acoustical partitions, 494–498
- Adaptable bathrooms, 137–142
- Adaptable kitchens, 181–185
- Aisle types, center-cross, 961–976
- Altars, 840
- Anthropometric data:
  - bars, 346, 347
  - bathrooms, 100, 101
  - closets, 206
  - conference room, 249
  - electronic workstations, 241, 242
  - library, 190
  - reference data, 1110–1113
  - retail spaces, 387–389
- Architectural woodworking, 804–865
  - altars, 840
  - bar sinks, 818
  - bars, 346, 347, 358–362, 364–366, 368–373, 864
  - base cabinets, 837
  - benches, 849
  - book and prayer shawl cabinets, 832, 833
  - bookcases, 808–812
  - cabinet doors, 797
  - casework, 788–794
  - clothes storage, 835
  - coat closet, 835
  - corner cupboards, 806, 807
  - cornices, 856–861
  - counters:
    - teller's, 396–400, 855
  - Architectural woodworking, counters (*Cont.*):
    - work, 824–826
  - display cases, 819–823, 829, 862, 863
  - door finishes, 865
  - file countertop, 836
  - finishes, 865
  - hidden door, 853
  - lecterns, 843–846
  - lobby display, 829
  - mouldings, 856–861
  - overfile cabinets, 827, 828
  - paneling, 804, 805, 860, 861
  - pantry cabinet, 839
  - pass-through vision panel, 275, 276
  - pews, 841
  - planter/storage cabinets, 831
  - raised panel door, 794, 799, 801, 854
  - sanctuary door, 842
  - sash, 801
  - screen, 850
  - storage shelves, 834
  - storage walls, 816
  - tables, conference, 847, 848
  - trader's wall, 814, 815
  - wardrobes, 817
  - window seat, 851
  - windows, 802, 803
  - wood paneling, 804, 805
  - wood railing and gate, 852
  - wood stairs, 665–671, 673
- Area requirements, 1106–1109
- Areas of planes, 1142
- Astragals, 875
- Audio-visual systems, 950–960
  - equipment, 48, 953, 960
  - front projection, 952
  - optical design factors, 953
  - planning guidelines, 952–955
  - projection rooms, 951–960
  - rear screen, 952
  - remote control, 953
  - sound system, 953
- Auditorium seating, 961–976
  - arrangements, 966, 970–976
  - chair dimensions, 962, 964, 965
  - continental, 961
  - design considerations, 961, 966, 968, 969
  - dimensions, 962, 964, 965
  - layouts, 961–976
  - row length, 962
  - row spacing, 963
  - screen sightlines, 969
  - screen sizes, 952
  - seat widths, 962, 965
- Auditorium seating (*Cont.*):
  - sightlines, 950, 951, 961
  - terminology, 967
  - visibility, 969
- Awning windows, 1016, 1018
- Backbar, 347
- Badminton court, 1073
- Bank teller's counters, 396–400, 855
- Banquet seating, 252
- Banquette seating, 313–321
  - design criteria, 313–315, 318
  - details of, 319–321
- Bar configurations, 348–356
- Bar details, 346, 347, 358–373
- Bar sink cabinet, 818
- Bar stool spacing, 348–356
- Barrier-free design:
  - bathrooms, 143–145, 317, 380
  - drinking fountains, 1102
  - elevators, 1065
  - kitchens, 178–189
  - ramps, 723
  - restrooms, 449–452
  - stairs, 718, 719
  - toilets, 449–452
  - water coolers, 1102
  - wheelchairs, 1114(*See also* Accessible design)
- Bars, 346–373
  - anthropometric data, 346, 347
  - backbar, 347
  - bar cabinet, 361
  - bar shapes, planning criteria, 348–356
  - bar stool spacing, 348–356
  - bottle steps, 363, 368, 369
  - clearances, public side, 347
  - cocktail tables, 347
  - customer activity zone, 347
  - dimensions of, 348–356
  - elevations of, 357, 362, 367
  - front- and backbar, 348–356, 358, 359, 364, 366–369
  - glass racks over, 365, 370
  - leaning, 347
  - planning criteria, 346, 347, 358–362, 364–366, 368–373
  - plans, elevations, and sections, 358–373
  - sections through, 346, 347, 356–362, 364–366, 368–373
  - standing, 347
  - working drawings of, 358–373
- Base cabinets, 789, 792, 794, 837
- Base cap mouldings, 877

- Base details, 532, 533, 538
- Base mouldings, 532, 533, 786
- Base types, 532, 533, 538
  - carpet, 532
  - ceramic, 532
  - marble, 533
  - quarry tile, 532
  - resilient, 532, 551
  - stone, 533
  - terrazzo, 538
  - vinyl, 532
  - wood, 533
- Baseboards, 532, 533, 786
- Basketball court, 1069, 1071
- Bathrooms, 100–148
  - accessible design of, 143–148, 380, 449–452
  - accessories, 117, 128
  - adaptable design of, 137–142
  - anthropometric considerations, 100, 101
  - barrier-free, 143–148, 380, 449–452
  - bathtub and shower details, 132–134
  - bathtub types, 113, 114
  - bathtub walls, tile, 132, 133, 136
  - bidet, 116
  - compartmented plans, 103, 105
  - controls, 128
  - countertops, 125–127, 130, 131
  - custom designs, 106–108
  - five-fixture plans, 103
  - four-fixture plans, 103, 119, 120
  - half, 102, 121
  - heights, 117, 128
  - lavatory types and dimensions, 109–112
  - planning data and fixture arrangement, 100, 101
  - plans, elevations, and details, 118–124
  - powder room, 102, 121
  - three-fixture plan, 102, 118
  - tile tubs, 132–134
  - two-fixture plan, 102
  - typical plans and fixture arrangements, 102–105
  - vanities, 125–127, 129–131
  - watercloset types and dimensions, 115, 116
  - wheelchair accessible, 144–148, 380, 449–452
  - whirlpool bath details, 113, 135  
(See also Restrooms and toilets)
- Bathtubs:
  - grab bars
  - sizes, 113, 114
  - tile, 132, 133, 136
  - types, 113, 114
  - walls, 132, 133, 136
  - wheelchair accessible, 143–148, 317, 380, 449–452
  - whirlpool, 113, 135
- Bedroom closets, 96–99, 220
- Bedrooms, 87–99
  - built-in furniture, 90–95, 97
  - clearances and arrangements, 87–89
  - closets, 96–99
  - furniture, 56
  - planning data, 87–89
  - walk-in closets, 96
- Beds and mattresses, 46
- Benches, 841, 849–851, 929, 930
- Bi-fold doors, 513
- Bidet types and dimensions, 116
- Billiard tables, 197
- Blinds, woven wood, 1054
- Bolts, 898, 1138
- Bookcases, 808–812
- Booth seating, restaurant, 316
- Brackets, curtain, 1047
- Bricks:
  - bonds, 478
  - floors, 540
  - joints, 478
  - partitions and walls, 473–478
  - types, 478
- Bulbs, light, 775–777
- Butt hinges, 887, 890
- Cabinet doors, 797
- Cabinet hardware, 887–901
  - castors and glides, 901
  - coat and hat hooks, 901
  - drawer runners, 897
  - flap stays, 895
  - latches, 898
  - lid stays, 896
  - locks, 899
  - magnetic and spring catches, 898
  - shelf supports, 900
  - wardrobe rails and supports, 901
- Cabinet types:
  - base, 837
  - book and prayer shawl storage, 832, 833
  - coat closets, 835
  - corner cupboard, 806, 807
  - display, lobby, 829
  - file, 285–289
  - kitchen, 154–169
  - overfile, 827, 828
  - pantry, 839
  - storage, 290
- Cabinets, kitchen, 149–169
  - clearances above work surface, 149, 150, 153–156
  - dimensions for, 156–164
  - styles of, 159, 160
- Cafeteria counters, 329, 333–338, 340–345
- Carousel coat storage, 461, 462
- Carpet:
  - area conversion, 1122
  - construction, 1128
  - edgings, 531
  - stair finishings, 714
  - transitions, 522, 523, 525–527, 529, 530
- Casement/hopper windows, 1017
- Casement windows, 803
- Casework, 788–794
  - custom, 789–791, 797
  - definitions, 788
  - drawer details, 791
  - economy, 789–791, 797
  - flush overlay, 792–794
  - premium, 789–791, 797
- Cashier counter, 825
- Casings, 878–880
- Ceilings, 641–659
  - acoustical, 641–643, 647–650, 654–659
- Ceilings (Cont.):
  - concealed spline, 647
  - curved, 651, 652
  - exposed T grid, 642
  - exposed Z bar, 643
  - gypsum board, 644
  - lay-in tile, 642, 643, 646, 654, 658, 659
  - plaster, 645, 648, 652, 657
  - plywood finish, 648
  - reflected ceiling plan, 659
  - suspended, 641–653
  - suspended, concealed spline, 642
  - vaulted, 651, 652
- Ceramic floors, 552–563
- Ceramic tile:
  - ceilings, 561
  - concrete slabs, 562, 563
  - expansion joints, 563
  - floors, 540, 561–563
  - installation details, 561–563
  - shapes, 507
  - soffits, 561
  - stairs, 561
  - wall finishes, 505–507
  - wood subfloors, 561
- Chair dimensions, 278–281
- Chair rails:
  - marble, 508
  - wood, 870, 883
- Chairs, office, 59, 278–281
- Chairs, residential, 5–45, 51–55, 59
  - 20th century classic, 51–55
- Chalkboard, 1090
- Checkroom systems, 460–463
- Children's furniture, 44
- Closers, door, 591, 593, 594
- Closets:
  - bedroom, 206–209, 213, 214, 218
  - children's, 218
  - foyer/front entry, 219
  - housekeeping/utility room, 217
  - linen, 216
  - master bedroom, 206–209, 213, 214, 218
  - narrow and deep, 207
  - pantry, 217
  - reach-in, 207
  - shallow and wide, 207
  - split, 206, 207
  - standard, 207, 208
  - U-shaped walk-in, 206, 207
  - walk-in, 206, 207
  - wardrobe, 817
- Closets/storage areas, 206–220
  - anthropometric considerations, 206
  - details, 835
  - female, 206
  - garment dimensions, 208
  - male, 206
  - rod lengths and heights, 207
  - shelf heights, 206, 208
  - shelf space and lighting, 207
  - walk-in, 206, 207
  - wire shelving systems, 216–220
- Clothes dimensions, hanging, 208
- Coat shelf details, 210–212, 463, 835
  - carousel, 461, 462

- Coat shelf details (*Cont.*):
  - electric, 461, 462
  - fixed/stationary capacities, 461, 463
  - rotating reels, 461, 462
- Coatroom systems, 461–463
- Coatrooms, 460–465
  - coat capacity, 462
  - floor area requirements, 460
  - plans, elevations and sections, 464
  - public, 460–465
  - shelves for, 465
- Cocktail tables, 347
- Cold cathode, 774
- Collection boxes, 1076
- Color, 999–1013
  - areas and samples, 1001
  - effects of lighting on, 1014
  - hues, 998–1002
  - intensities, 998–1002
  - Munsell system of color, 1002
  - reflective values, 1013
  - values, 998–1002
- Color combinations, 1000, 1001
  - charts, 1000
- Color families:
  - blue, 1010, 1011
  - green, 1008, 1009
  - orange, 1005
  - red, 1003, 1004
  - violet/purple, 1012
  - yellow, 1006, 1007
- Color reflectivity, 1013
  - values, 1013
- Color schemes, 1000, 1001
  - planning, 998
- Color terms, 1001
- Color theory, 998–1014
- Color wheel, 1002
- Colors:
  - accented, 998
  - analog or related, 998, 1000
  - color wheel, 999
  - combinations, 1001
  - complementary or contrasting, 998
  - cool, 1000
  - monochromatic, 998
  - neutral, 1000
  - primary, 998
  - safety color guide, 1013
  - secondary, 998
  - tertiary, 998
  - value scale, 999
  - warm, 1000
- Columns:
  - capitals and entablatures, 1135
  - covers, 1091–1096
  - fireproofing of, 514, 515
- Computer floors, 564, 565
- Computer workstations, 241–248
- Concealed hinges, 892
- Conference rooms, 248–259
  - anthropometric data, 249
  - clearances for, 249
  - credenzas, 259
  - heating unit, enclosures in, 259
  - layouts, 254, 255
- Conference rooms (*Cont.*):
  - planning data, 249–255
  - seating capacities, 249–255, 283, 284
  - table sizes, 249–255, 283, 284
- Conference tables, 283, 284
  - bases, 256
  - boat-shaped, 251–254
  - circular, 249, 250, 253, 254
  - clearances around, 249
  - details of, 256–258
  - edge details of, 256
  - race track, 252
  - rectangular, 251, 252
  - room sizes for, 254, 255
  - round, 249, 250, 253, 254
  - shapes of, 250–253, 283, 284
  - sizes, 249–255, 283, 284
  - wood edge treatments, 256
- Containers, plant, 831, 912
- Continental seating, 961
- Corner cupboards, 806, 807
- Corner guards, 1087, 1088
- Cornices, 856–858, 861
  - (*See also* Mouldings)
- Couches, 5, 9, 13, 17, 21, 25, 26, 45, 57, 77–79
- Counters:
  - cafeteria, 329, 333–338, 340–345
  - cashier, 335, 337, 825
  - condiment, 339, 341, 342
  - file, 298, 299, 303
  - file countertop, 824–828
  - kitchen, 154–169, 792, 794
  - lavatory, 125–127, 130, 131
  - lunch, 322
  - pick-up, tray, 337, 341
  - plastic laminated, 174
  - retail, 387–389, 391, 392, 394–402
  - salad bar, 334, 340, 343, 344
  - self-service, 329
  - server, 343, 345
  - service, 338
  - serving, 340–344
  - sink, 175
  - telephone, 825
  - teller's, 396–400, 855
  - walkup, 825
  - word processing, 825
  - work, 824–826
- Courts:
  - badminton, 1073
  - basketball, 1069, 1071
  - handball, 1070
  - paddle tennis, 1072
  - shuffleboard, 1074
  - tennis, 1070, 1072
  - volleyball, 1073
- Cove lighting, 413–417, 751–759
  - cold cathode, 752, 774
  - merchandise display, 407–409, 412–417
  - retail stores, 407–409, 412–417
- Cove mouldings, 881
- Covering capacities and quantities:
  - carpet, 1122
  - floor tile, 1123
  - paint, 1123
  - panel, 1126
- Covering capacities and quantities (*Cont.*):
  - wood flooring, 1127
- Credenzas, 826, 830, 855
- Crown mouldings, 866–868, 871, 872
- Cupboard, corner, 806, 807
- Curtains, 5, 6, 9, 10, 13, 14, 17, 18, 20–22, 24–26, 28, 1027–1041
  - café, 1033, 1036
  - colonial style, 1029
  - Federal style, 1029
  - headings, 1043
  - pocket, 1027
  - rods, 1048–1051
  - ruffled, 1033, 1034, 1036
  - shirred, 1034
  - (*See also* Draperies)
- Decibel scale for sounds, 1121
- Decimal conversion tables, 1141
- Desks, 7, 8, 12, 16, 20, 24, 27, 30, 58
  - lamps, 744, 747
  - reception, 260, 262–272, 855
  - registration, 381–383
  - workstations, 223–235
- Dining room/period furniture, 6, 7, 10, 11, 13, 15, 18, 19, 22, 23, 26–29, 31, 36–38, 40–41
- Dining room seating, 316
- Dining room sizes, 83, 85
- Dining rooms, 80–86
  - furniture arrangements, 80
  - furniture clearances, 80–84
  - furniture dimensions, 50, 56
  - seating, 85, 86
  - tables, 80–86
- Display cases, 387–393, 402–404, 408, 409, 819–823, 829, 862, 863
  - cosmetic, 391, 402–404
  - feature walls, 412–417
  - island, 392
  - jewelry, 391
  - refrigerated, 392
  - shelving, 407–409, 412–414, 422
  - shirt, 391
  - television, 405, 406
- Display systems:
  - binning, 419
  - rack, 419–421
  - wall, 418, 419, 422
- Door frames, 571–587, 607–609
- Door hardware, 568, 569, 589–598, 634–643, 1129
  - installation of, 569, 1129
  - location of, 1129
- Door jambs:
  - hollow metal, 571, 573–582, 585, 586
  - marble, 629
  - wood, 581–586, 608
- Door schedules, 570–572
- Door trim, 854
- Doors, 566–641, 842, 853, 854
  - acoustical, 610
  - bank vault, 605
  - bi-fold, 513
  - casement, 612
  - closers, 591, 593, 594
  - construction details, 610

Doors (Cont.):

- edges, 599
  - entrance, 618–628
  - exterior, 613, 617–628
  - fire-protected, 600
  - flush, 795, 796
  - frames, 571–587, 607–609
    - hollow metal, 571, 573–582, 585, 586
  - French, 612
  - hardware, 568, 569, 589–598, 634–664, 1129
  - hidden, 853
  - hinges, 568, 598
  - hollow metal, 566–599
  - laminated, 566
  - lead-lined, 610
  - lightproofing, 576, 606
  - paneled, 612, 613, 615, 616
  - particle board, 610
  - raised panel, 842, 853, 854
  - saddles, 522–528
  - sanctuary, 842
  - sash, 801
  - schedules, 570–572
  - screen, 611
  - secret, 616, 808
  - shoji, 611
  - sizes, 568
  - sliding, 601, 611
  - sound proofing, 576, 606
  - stave, 610
  - stile and rail, 610
  - thresholds, 602–604
  - wood, 573, 587, 588, 600, 610–628, 632–634
  - wood-clad, 582, 584, 608
- Double hung windows, 802
- Down lighting, 749, 750
- Draperies, 5, 6, 9, 10, 13, 14, 17, 18, 20–22, 24–26, 28, 1027–1042
- bishop sleeve, 1035
  - cascade, 1037
  - colonial, 1029
  - colors, 1028
  - design, 1028
  - Directoire, 1030
  - fabric, 1028
  - Federal, 1029
  - finials, 1048
  - full-length, 1029–1032, 1034, 1035
  - Georgian, 1030
  - hardware, 1046–1051
  - headings, 1043, 1044
  - historical styles, 5, 6, 9, 10, 13, 14, 17, 18, 20–22, 24–26, 28
  - holdbacks, 1034
  - hooks, 1048
  - late Georgian, 1030
  - late Victorian, 1031
  - mid-19th-century Victorian, 1031
  - mounts, 1047
  - neo-Greek, 1031
  - panel widths, 1051
  - period styles, 1028–1032
  - rings, 1048
  - rods, 1049, 1050
  - single pleated, 1036
  - stackback requirements, 1058

Draperies (Cont.):

- swags, 1029–1031, 1038–1040, 1042
- upholstery, 1028

Drawers:

- capacities of, 286–291
- card file, 291
- details, 785, 789–791, 797
- glossary, 292, 293
- insert, 286
- lateral file, 287, 287
- legal file, 285
- letter file, 285
- linear capacities of, 286–291
- with shelves and add-on cabinets, 289
- vertical file, 285, 286

Dresser, 97

Drinking fountains, 1100–1102

Drywall partitions, 481–496

Electrical:

- amperage ratings, 1132, 1134
- appliance loads, 1134
- circuits, 1134
- receptacle location, 1133
- requirements, 1132–1134

Electronic media storage, 294, 295

Electronic workstations, 241–248

- administrative, 244, 245
- analyst/programmer, 245
- anthropometrics, 241, 242
- area requirements, 243–245
- computer requirements, 241, 242
- data retrieval, 243
- managerial, 245
- planning data, 241–248
- secretarial, 243
- shared tasks, 243
- square footage for, 243, 245
- task profiles, 243–245
- trading desk details, 246–248
- word processing, 244

Elevators:

- barrier-free considerations, 1065, 1066, 1068
- doors, 1064
- geared traction, 1060
- gearless traction, 1061
- hydraulic, 1061
- low and mid rise, 1061
- passenger, 1060–1066
- planning guidelines, 1060
- security of, 978, 989–991
- selection of, 1060
- traction high rise, 1062, 1063
- wheelchair lifts, 1068

Escalators, 1067

Exit doors, security of, 989

Fabrics:

- characteristics and suitability of, 1130, 1131
  - types, 1130, 1131
- Face out display systems, 413, 414, 418
- Family/recreation rooms, 196–199
- arrangement and clearances, 196, 197
  - recreational activities, 196, 197
- File cabinets, 285–289
- card file drawers, 281

File cabinets (Cont.):

- dimensions of, 285–287
  - drawer types in, 285–289
  - insert drawers, 286
  - lateral, 287, 288
  - legal file drawers, 285
  - letter file drawers, 285
  - linear capacities in, 286
  - overfile, 286
  - roll-away, 286
  - vertical, 285
  - weights of, load, 287
- File storage, details of, 298, 299
- Fire doors, 600
- Fireplaces, 68–71, 724–742
- accessories for, 742
  - construction details of, 725, 729
  - dimensions of, 725–729, 804
  - flue sizes of, 726–729
  - mantels, 68–71, 520, 521, 730–741, 804, 859
  - planning data, 724–729
- Fireproofing, 514, 515
- Fixture heights plumbing, 117
- Flagstone, 520
- Floor:
- raised, 564, 565
  - sound rated, 548–550
- Floor construction:
- details, 516–565
    - computer floors, 564, 565
    - marble, 521
    - slate, 541
    - terrazzo, 535–541
    - wood, 542–550
    - wood on concrete slab, 547
    - wood strip flooring, 543
  - sound insulation, 548–550
- Floor finishes:
- bases, 532, 533, 786
  - brick, 540
  - ceramic tile, 519, 540, 541, 552–568
  - characteristics of, 517
  - edgings, 531
  - marble, 541
  - parquet, 544–546
  - quarry tile, 541
  - resilient tile, 541, 551
  - saddles, 522–526
  - slate, 541
  - terrazzo, 535–541
  - transitions, 527–530
  - wood, 541, 544, 547
- Floor lamps, 743, 745
- Floor patterns:
- ceramic tile, 519, 552–563,
  - marble, 520, 521
  - stone, 534
  - tile, 519
- Flushbolts, 596
- Folding table hinges, 891
- French doors, 801
- French paneling, 805
- Functions of numbers, 1144
- Furniture arrangements, living room, 61
- Furniture clearances:
- dining rooms, 50, 56, 80–84

Furniture clearances (*Cont.*):

living room, 50, 57, 63

Furniture dimensions:

audio-visual equipment, 48

bedroom, 56

beds and mattresses, 46

bookcases, 808–812

chairs, 45, 51–55, 59

chaise lounges, 45

chests, 58

children's furniture and tables, 44

convertible sofas, 47

couches, 5, 9, 13, 17, 21, 25, 26, 45, 57,  
77–79

desks, 58

dining room, 50, 56

highboys, 58

love seats, 45

lowboy, 58

mattresses and beds, 46

pianos, types and sizes, 199

secretary, 58

settees, 57

sofa beds, 47

sofas, 5, 9, 13, 17, 21, 25, 26, 45, 57, 77–79

tables, 44, 45, 50, 60,

television sets, 50

20th century classic chairs, 51–55

wall beds, 47

waterbeds, 47

Furniture, furnishings, and equipment,  
278–304

chair dimensions, 278–281

chair types, 278–281

conference tables, 282–284

counter tops with base cabinets, 303

desks, 7, 8, 12, 16, 20, 24, 27, 30, 58

file cabinets, 285–289

file counter tops, 298, 304

kitchen, compact, 304

lounge seating, 282

office pantry details, 300–303

overfile cabinet, 299

reception seating, 282

storage cabinets, 290

Furniture glides, 902

Furniture hardware, 890–901

Furniture types/styles, 5–43

American, 17th century colonial, 5–8, 29, 30

American, 18th century colonial, 9–12, 29, 30

American, 18th century Federal, 13–16

American, late 18th–early 19th century

Federal, 13–16

Brothers Adam, 39, 40, 17–24

Chippendale, 36

colonial, 5–16, 24, 30

Directoire and Empire, 25–28

Duncan Phyfe, 31

English 16th century Jacobean, 32

English, 17th century Jacobean, 33

English 17th century William and Mary, 34

English 18th century Georgian, 17–20, 36

English 18th century late Georgian, 21–24,  
37, 38

English 18th century Queen Anne, 35

Federal, 13–16

Furniture types/styles (*Cont.*):

French, 17th and 18th century Louis XIV,  
XV, and XVI, 41

Georgian, 17–24, 36–38

Hepplewhite, 37

Jacobean, 32, 33

late Georgian, 39, 40

Louis XIV, XV, and XVI, 41

Queen Anne, 35

Sheraton, 38

Spanish, 42

table of, 43

William and Mary, 34

Furring of:

columns, 488, 491

walls, 483, 484, 498, 499

wood, 497

Garage doors, 992–995

Gardens:

drainage, 911

interior, 910

large, 910

planting procedures, 910–913

small, 910

(*See also* Plants; Plantscaping)

General offices, 223–230

area allocations, 225, 226

basic workstations, 223–226

groupings, 224

minimum square footage, 225, 226

multiple workstations, 227–230

open workstations, 225, 226

screened workstations, 225, 226

square footage for, 225, 226

task profiles, 225, 226

U-shaped workstation, 224

Glass door cabinet hinges, 894

Glass partitions, 492

Glass shelving details, 402–404, 407, 408, 409,  
413, 414

Gliding windows, 1019

Grab bars, 458, 459

Grilles, 1080–1086

Guards, wall protection, 1087, 1088

Guestroom plans, 374–380

accessible, 377–380

Gymnasium, 1071

Gypsum board partitions, 481–496

Handball courts, 1070

Handrail details, 665–669, 671, 672, 681, 682,  
692, 707, 718, 719

Hardware:

bolts, 898, 1138

cabinet, 887–902

catches, 898

closet, 901

coordinators, 595

door, 568, 569, 589–598, 634–640

door closers, 593–594

door holders, 593–594

door stop, emergency

fire exit, 595

flush bolts, 596

furniture, 887

Hardware (*Cont.*):

hand of lock, 635

hinge locations, 568

hinges, 589–591, 634, 887–894

hospital door latch, 597

installation in wood door, 534

locations of, 634, 1129

lock functions, 635

lockset types and descriptions, 592, 636–640  
panic, 595

wood door, 534, 592, 636–640

Headings, drapery, 1043, 1044

Hearths, 726–729

Highboy, 58

Hinge types:

anchor, 589

butt, 887, 890

concealed, 892

flap, 891, 895

folding table, 891,

full mortise butt, 589, 590

full surface butt, 589, 590

full surface-swing clear, 590

glass door, 894

half mortise, 589, 590

half mortise butt, 589, 590

half surface butt, 589, 590

hospital “swing” clear, 590

invisible, 590

mitred, 892

pivot, 888, 889, 893

Hinges, 887–894

Holdbacks, 1045, 1046

Hollow metal door frames, 571–582, 585,  
586

anchorage of, 575, 577

details, 571, 573, 577–586

light and soundproofing of, 576

profiles, 574, 575, 576, 599

typical jamb installations, 571, 573, 577–586

schedules, 570–572

wood and metal, 582, 584

Hollow metal door hardware, 569, 589–598

Hollow metal doors, 566–599

construction types, 567

designs of, 568, 571

dimensions of, 568

edge treatments, 599

hardware, 569, 589–598

hinge locations, 568, 598

laminated construction, 566

sizes of, 568

steel stiffened, 566

Hospitality spaces, 307–383

bars, 346–373

guestroom plans, 374–380

hotel room plans, 374–380

hotels, 374–383

restaurants, 307–345

Hotel room plans, 374

accessible, 377–380

Hotels, 374–383

accessible bathrooms, 143–148, 317, 380,  
449–452

accessible guestroom plans, 377–380

guestroom plans, 374–380



Hotels (Cont.):

- reception desk, 384
- registration desks, 381–383
- room layouts, 374–380

Indoor recreation, 1069–1073

Indoor trees, 907

Interior plants, 906–930

Jalousie window, 1018

Jambs:

- hollow metal, 571, 573–582, 585, 586
- marble, 629
- wood, 581–586, 608

Joinery details, 781–803

Joinery types, 781–803

- stile and rail, 503, 610, 798, 799, 805, 813

Joint, 781–784

- butted, 781, 782
- cabinet, 785–793
- characteristics, 781
- furniture, 781–784
- mitered, 781, 782
- shiplapped, 781, 782
- terminology, 783
- tongue and groove, 781–786
- typical, 781–784

Kitchen layouts:

- adaptable, 178–189
- broken U, 151–153
- corridor, 151–153
- L-shaped, 151–153
- U-shaped, 151–153

Kitchens:

- accessible, 178–189
- adaptable, 181–185
- anthropometric data, 149, 150
- appliances, 171–173
- barrier free design, 178–189
- cabinet details, 154–169
- cabinet types and dimension, 156–164
- clearances, 149, 150, 153–156
- compact, details of, 304
- countertops, 174, 175
- heights and equipment, 153
- layouts of, 151–153
- microwave cabinets, 163
- minimum counter frontage, 153
- planning information, 149, 150–155
- plans, elevations and details, 176, 177
- sink types and dimensions, 170
- space criteria, 153
- storage and cabinets, 154, 155
- storage requirements, 154, 155
- typical layouts, 151, 152
- wheelchair accessible designs, 178–189

Ladders, 720, 721

Lamp (bulb) types, 774–778

Lamps (portable), 743–748

- desk, 744, 747
- floor, 743, 745
- minimum shade dimensions, 743–748
- personal, 743, 744
- table, 744–746

Lamps (portable) (Cont.):

- wall-mounted task, 748

Laundry room locations, 202, 203

Laundry/bathroom combinations, 202

Laundry/kitchen combinations, 204

Laundry/sewing combinations, 200–205

Laundry/sewing rooms, 200–205

- sewing center clearances, 205
- washer/dryer arrangements, 200, 201

Lavatory clearances, 100–103

Lavatory counter details, 441–446

Lavatory countertops, 441–446

Lavatory heights, 100, 101, 450

- wheelchair accessible, 450

Lavatory types and dimensions, 109–112

Lectern, 843–846

Letterboxes, 1075

Lettering typestyle, 947, 948

Libraries/studies, 190–196

- anthropometric data, 190
- bookcases, 808–812
- capacities of, 190
- details of, 192–195
- heights of, 190
- plans, elevations, and details, 191–194
- rolling ladders for, 195
- volumes per linear foot, 190

Lid stays, 895

Light cove details, 413–417

Lighting, 743–778, 1014

- cold cathode ceiling mounted, 774, 752
- cove, 413–417, 751–759
- feature walls, 412–417
- handrail lighting, 765
- lighted column, 771–773
- merchandise, 407–409, 412–417
- miscellaneous, 760–764
- nosings and treads, 766–769
- planning data, 743, 744, 749, 750, 774–778
- retail stores, 407–409, 415–417
- skylite lighting, 770
- stair lighting, 766–769

Lighting levels, 750

- industrial, 778
- office, 778
- plants, 915
- residential, 750
- store, 778

Lighting plan, 659

Lighting types:

- cornice, 749
- downlighting, 749, 750
- valence, 415–417, 749

Living rooms, 61–79

- bars in, 72
- circulation, 62
- conversation area, 62–64
- fireplaces, 69–71
- floor plan of, 67, 68, 73–76
- furniture arrangements, 61
- furniture clearances, 63
- furniture dimensions, 50
- media cabinet details, 65, 66
- planning considerations, 61–63
- plans, elevations, and details of, 67, 76
- sofas, 77–79

Living rooms (Cont.):

- television viewing areas, 64

Locks, 592

- bored, 592
- bored cylindrical deadlock, 592
- functions of, 631–640
- furniture, 899
- mortise, 592
- mortise deadlock, 592
- unit, 592

Locks, latches, and deadlocks, 592, 636–640

Lockset functions, 636–640

Lockset types and descriptions, 592, 636–640

Lounge seating, 261, 281, 282

Lowboy, 58

Lunch counters, 322

Mail chutes, 1078

Mail drops, 1077

Mailboxes, 1076

Mantels, 68–71, 520, 521, 733, 735, 736, 738–741

- marble, 733–735
- wood, 736–741, 804

Marble:

- ceilings, 509
- details, 68–71, 520–521, 733, 735, 736, 738–741
- patterns, 520, 521
- walls, 508–510

Marble flooring, 519, 520, 521

Marble jambs, 629

Marble stairs, 715

Masonry partitions and walls, 473–480

Mathematical data and formulas, 1139–1144

Mattress types and sizes, 46

Mattresses and beds, 46

Measurement conversion tables, 1139–1144

Media rooms, 65, 66

Medical symbols, 940

Men's toilet room, 427, 433, 436, 437, 440

Metal stud and gypsum board, 481–496

Metric conversion tables, 1140

Mirrors, triple, 410

Modular panel conversion chart, 1126

Mortar beds, 132, 541, 561–563

Mouldings, 856–858, 861, 866–886

- backbands, 873
- baluster, 884
- base, 876, 877
- base cap, 877
- base shoe, 876
- brackets, wood, 886
- brick, 874
- casings, 878, 879, 880
- chair rail, 870, 883
- clam shell, 885
- colonial, 885
- corner guards, 875
- cove, 881
- crown, 866, 867, 868, 871, 872
- deep sculpt, 866, 867
- door trim, 869, 870
- floor, 876
- half round, 884
- handrail, 884



Mouldings (Cont.):

- lattice, 885
- mirror, 870
- miscellaneous, 873–875
- panel, 870, 882
- picture, 870, 873
- pilaster, 874
- round, 824
- sanitary, 875, 885
- sash, 875, 885
- step, 873
- stop, 885
- trim, 870

(See also Cornices)

Mounting heights, telephone, 1079

Mounts, curtain rods, 1047

Munsell color system, 1002

Nail types and sizes, 1136, 1137

Newels and railings, 665, 666, 673, 692, 693, 694, 699, 703, 705

Nosings, stair lighting in, 766–769

Nosings and treads, abrasive, 687, 688, 691, 715, 722

Office spaces, 223–304

- conference rooms, 248–259
- electronic workstations, 241–248
- furniture, furnishings, and equipment, 278–304
- general offices and multiple workstations, 223–230
- pass-through windows, 512
- private, 231–240
- room arrangements, 233–235
- reception areas, 260–277
- workstation types, 223–232

Open workstations, 225, 226

Overfile cabinet, 827, 828

Paddle tennis court, 1072

Panel conversion chart, 1126

Panel mouldings, 503

Paneled door:

- details of, 784, 799, 801, 854
- frame parts of, 784

Paneled wainscot, 503, 799

Paneled walls, 798, 799, 800, 801, 804, 805, 813, 814, 842, 856–861, 860, 861

Paneling, 500–504, 804, 805, 860, 861

French, 804, 805

raised, 503, 800

wood, 500–504, 736, 737

Panic hardware, 595, 596

Pantry cabinets, 839

Parquet flooring, 544–546

Partitions and wall finishes, 469–515

Partition types:

- metal stud and gypsum board, 481–496
- toilet, 447, 448

Partitions, 470–499

acoustical, 494–498

brick, 473–478

concrete block, 480, 483

drywall, 481–496

fire-rated, 495

Partitions (Cont.):

- glass, 492
- gypsum board, 481–496
- interior, 470–499
- marble, 508–510
- masonry, 473–478, 480, 483
- miscellaneous types, 493
- piers, 473
- plaster, 470–473, 475–477, 508–511
- slate, 511
- sound transmission, 494–498
- stone, 479, 508–511
- wood stud, 472, 473, 494, 498

Pass-through windows, 275, 276

People, distance relationships, 1119, 1120

Period furniture:

- American, 17th century Colonial, 5–8, 29, 30
- American, 18th century Colonial, 9–12, 29, 30

American, 18th century Federal, 13–16

American, late 18th century–early 19th century Federal, 13–16

Brothers Adam, 39, 40

Chippendale, 36

Colonial, 5–16, 29, 30

Directoire and Empire, 25–28

Duncan Phyfe, 31

English 16th century Jacobean, 32

English 17th century Jacobean, 33

English 17th century William and Mary, 34

English 18th century Georgian, 17–20, 36

English 18th century, late Georgian, 21–24, 37, 38

English 18th century Queen Anne, 35

Federal, 13–16

French, 17th and 18th century Louis XIV, XV, and XVI, 41

French, late 18th century–early 19th century, 25–28, 41

Georgian, 17–24

Hepplewhite, 37

Jacobean, 32, 33

late Georgian, 39, 40

Louis XIV, XV, and XVI, 41

Queen Anne, 35

Sheraton, 38

Spanish 16th and 17th century, 42

table of, 43

William and Mary, 34

Pews, 841

Pianos, 199

photometrics, 766

Picture mouldings, 870, 873

Pivot hinges, 888, 889, 893

Pivot windows, 1019, 1022

Plant containers, 831, 912

Planters, 831

diameters, 906–909, 912

window, 927, 928

Planting, 911, 912, 916–928

bed material, 411, 912, 916–923

details, 923–928

medium, 911, 912, 916–923

standards, 906–915

Plants, 906–930

design guidelines for, 906–915

Plants (Cont.):

- diameters of, 906–909
- floor, 907
- heights of, 906–909
- high light level, 915
- light and sun requirements, 916–923
- low light level, 915
- medium light level, 915
- procedures for planting, 910–913
- requirements, 906–915
- soil requirements, 911, 912, 916–923
- spacing, 906–909
- species, 907
- specifications, 910
- temperature requirements of, 913–916
- texture, 906
- trees, indoor, 907
- typical, 916–923
- water and humidity requirements, 916–923
- water requirements, 915

Plantscaping, 906–930

- design guidelines, 906–915
- specifications, 910

Plaques, 936–939

Pleated shades, 1053

measurements, 1058

Pleats, 1051, 1043, 1044

Plumbing fixtures, 107, 109–116

Pools, 912

Pot sizes, 906–909, 912

Projection, 950–960

distances, 953

front, 952

rear, 952

Projection room layouts, 950–960

Projection screens, 949–960

Quarry tile, 541

Railings, 665–669, 671, 672, 681, 682, 692, 707, 718

Raised floors, 564–565

Raised paneling, 503

Raised wood panels, 503

Ramps, 723

barrier-free, 718, 719, 723

Rear projection, 952

Receptacles, electrical, 1133

Reception areas:

- planning data, 260, 261
- receptionists' workstation in, 262–276
- seating arrangements, 261

Reception desks, 260, 262–272, 855

hotel, 381–384

Reception rooms: 260–277

seating, 261

Reception window detail, 273–276, 512

Recreation, indoor, 196, 197

Reference data, general, 1105–1144

Reflected ceiling plans, 760

Reflective values, color, 1013

Registration desks, 381–383

Residential spaces, 5–219

bathrooms, 100–148

bedrooms, 87–99

closet/storage areas, 206–220

- Residential spaces (*Cont.*):
- dining rooms, 80–86
  - family/recreation rooms, 196–199
  - kitchens, 149–189
  - laundry/sewing rooms, 200–205
  - libraries/studies, 190–195
  - living rooms, 61–79
  - period furniture, 5–43
- Resilient floors, 541, 551
- Restaurants, 307–345
- accessible design, 317, 330
  - banquette seating, 313–316, 318–321
  - booth seating, 316
  - cafeteria/servery, 333–345
  - condiment cabinet, 339, 341, 342
    - counter details, 333–337
  - counter details, 323–327, 329, 331, 333–338, 340, 343–345
  - counters, 323–327
  - dining room seating, 316
  - host cabinet, 338
  - lunch counters, 322
    - design criteria, 322
  - maitre d' station, 338
  - salad bar serving counter, 840, 844
  - seating, 313–316, 318–321
  - self-service counter, 329
  - servery counter, 843, 845
  - service counter, 338
  - table spacing, 308–316
  - trash counter, 338
  - tray pickup, 341
- Restrooms and toilets, 425–465
- accessible design, 317, 430, 449–452
  - accessories, 453–457
  - accessory heights, 426–429, 431, 433, 435–441, 450, 452
  - clearances for wheelchair access, 317, 449–452
    - (see Bathrooms; Hotels)
  - fixture requirements, fixture count, 425
  - grab bar configurations, 458, 459
  - lavatory counter details, 442–446
  - lavatory heights, wheelchair accessible, 450
  - plans and elevations, 430–441
  - plumbing data, 425
  - plumbing fixture heights, 426–429, 431, 433, 435–441
  - public, 425–465
  - show facility for accessibility, 147
    - toilet accessories, 453–459
    - toilet stall details, 447, 448
    - toilet stalls, accessible, 449–452
    - vanity details, 441–446
    - wheelchair accessible, 317, 430, 449–452
    - women's toilet/powder room, 430, 434–437
- Retail spaces, 387–422
- anthropometric considerations, 387–389
  - back island details, 401
  - banks, 396–400
  - binning, 419
  - counter heights, 387–389, 391, 392, 394–402
  - department stores, 401–423
  - display cases, 387–393, 402–404, 408, 409, 862, 863
  - faceouts, 413, 414, 418
- Retail spaces (*Cont.*):
- feature walls, 412–417
  - garment capacities, 418
  - lighting, 407–409, 412–417, 759
  - planning data, 387–389
  - rack display systems, 420–421
  - refrigerated case, 392
  - sales counters, 387–389, 391, 392, 394–402
  - shelving, 407–409, 412–414, 422
  - shops, 387–395
  - showcases, 387–393, 402–404, 408, 409
  - storefronts, 390
  - triplicate mirror, 410
  - valance and cove lighting, 415–417
  - wall display systems, 418, 419
- Risers, 671, 686–688, 708, 713–716, 719
- Rock formations, 912
- Rod display system, 421
- Rods:
- drapery-curtain, 1048–1050
  - traverse, 1050
- Roll-in showers, 140
- Rolling ladders, 195
- Row length and spacing, 961–969, 970–976
- Saddles, 522–528
- under doors, 522–528
- Salad bar counter, 340
- Sales counters, 387–389, 391, 392, 394–402
- Sash, profiles of, 801
- Screens:
- projection, 952
  - shoji, 611
- Screw types, 1138
- Seat widths, 968
- Seating arrangements, 966, 970–976
- auditorium, 961–976
  - standard, 961
- Seating:
- continental, 961
  - multiple, 966
- Secondary entries, security of, 989
- Security, 977–997
- alarms, exit, 995
  - bars, grills, and gates, 988
  - closers, 980
  - control of grounds, 977, 978
  - cylinders, 981, 983, 984
  - doors, 977–986
  - electronic systems, 994, 996, 997
  - elevators, 978, 989–991
  - exit doors, secondary, 989
  - fire doors and fire stairs, 977
  - garage doors, 992–985
  - general control guidelines, 977, 978
  - hardware, 979–986
  - hinges, 980
  - lighting, 993
  - lobby spaces, 977
  - locks, 981, 986, 987
  - mailbox rooms, 992, 993
  - multifamily dwelling, 977
  - public spaces of multiple dwelling, 977
  - secondary entries, 989
  - skylights, 988
- Security (*Cont.*):
- sliding doors, 984
  - window and hardware, 978, 986–988
- Security alarms, 994–997
- Serving counter, 329, 333–338, 340–345
- Settees, 5, 9, 17, 25, 33, 57
- Sewing equipment, arrangement of, 205
- Sewing machines, heights and clearances, 205
- Sewing rooms, 205
- planning of, 205
- Shades, window, 1052–1054
- lamp, 743–746
- Shelf and hanging pole, 835
- Shelf edge, 826, 830, 834, 835
- Shelf heights:
- closets, 835
  - storage, 826, 834
- Shelf light details, 298
- overhead file storage details, 827, 828
- Shelf supports, 900
- Shelf types:
- coat, 277
  - coatrooms, 465
  - phone, 277
  - wall, 277
  - wire basket and shelving system, 216–220, 419
- Showcase types:
- cosmetic display, 391, 402–404
  - island display, 392
  - jewelry, 391, 401
  - refrigerated, 392
  - shirt display, 391
- Shower floor details, 132, 133
- Shower seat design, 132
- Shower wall details, 132
- Showers:
- grab bars for, 140, 142, 144, 147
  - roll-in, 140, 144, 147
  - wheelchair accessibility, 140
- Shuffleboard court, 1074
- Shutter details, 1057
- Shutters, 1055–1057
- Sign types, 931–948
- area designation-wall mounted plaques, 937
  - ceiling hung, 937
  - code, 936
  - counter top, 939
  - cut letters, 939
  - design criteria, 931–935
  - desk top, 939
  - directional, overhead, 937
  - directional, wall mounted, 937
  - framed wall-mounted plaques, 938
  - room identifier, 938
- Signage:
- ceiling hung, 937
  - checklist for, 934, 935
  - counter top, 939
  - desk bar, 939
  - desk top, 939
  - directional, 937
  - flag mount, 939
  - framed wall-mounted plaques, 938
  - room identifier, wall mounted, 938
  - symbols, 940–946

- Signage (*Cont.*):  
 type and mounting heights, 936–939
- Signage and graphics, 931–948
- Signage system design criteria, 931–936, 949  
 graphic symbols, 940–946  
 mounting heights, 936  
 mounting materials, 937  
 standard sizes, 936–939  
 types, 936–939
- Sinks, kitchen, 170
- Skylights, lighting, 770
- Slate flooring, 541
- Slate stairs, 716
- Sliding windows, 1019
- Sofa beds, 47
- Sofa dimensions, 45
- Sofas, 77–79
- Sofas, chairs, tables, and stools, 45
- Soffits (*see* Ceilings)
- Sound control partitions, 494–498
- Sound insulation, floor construction, 548–550
- Sound insulation and transmission details, 494–498, 548–550
- Sound levels, 1121
- Sound transmission, partitions, 494–498, 1121  
 floor construction, 548–550
- Space planning area requirements, 1106–1109
- Specialties, 903–1102  
 audio-visual systems, 949–960  
 auditorium seating, 961–976  
 chalkboards, 1090  
 color theory, 998–1014  
 column covers, 1091–1096  
 drinking fountains, 1100–1102  
 elevators, 1060–1068  
 fireplaces, 742  
 guards, protection, 1087–1088  
 grilles, 1080–1086  
 handrails, 1089  
 indoor recreation, 1069–1074  
 key cabinets, 1078  
 letter boxes, 1075  
 lockers, parcel, 1078  
 mail chutes, 1078  
 mail collection boxes, 1076  
 mail drops, 1077  
 landscaping, 906–930  
 security, 977–997  
 signage and graphics, 931–948  
 telephone booths, 1079  
 turnstiles, 1097–1099  
 watercoolers, 1100–1102  
 window treatments, 1015–1059
- Spiral stairs, 674, 676, 709, 710
- Sports, indoor, 1069–1074
- Stair finishes:  
 carpeting, 714  
 ceramic tile, 561  
 concrete, 713, 714, 722  
 marble, 715  
 slate, 716  
 terrazzo, 539, 708, 712, 714  
 wood, 665–671
- Stair lighting, 766–769
- Stairs:  
 barrier-free design data, 718, 719
- Stairs (*Cont.*):  
 circular, 675, 711  
 classes of, 677  
 clearances, 660–664, 686  
 critical dimensions, 660–664, 686  
 details of, 665–672, 678–784, 687–699,  
 703–708, 712–716, 721, 722  
 floor to floor heights, 660  
 handrail heights, 664  
 handrails, 664–673, 692–702, 717, 718, 765  
 headroom, 660, 664  
 layout of, 664  
 length of, 686, 661–663  
 lighting of, 766–769  
 minimum width of, 661  
 nosings and treads, 664, 687, 688, 691, 708,  
 713–716, 722, 766–769  
 number of risers, 660, 662, 663  
 oval, 674, 676, 709, 710  
 pitch of, 664  
 planning data, 660–664, 677, 717  
 platform, 683  
 riser calculations, 660  
 spiral, 674, 676, 709, 710  
 steel, 670, 671  
 stringers, 689, 690  
 treads, 687–688, 719  
 types, 682, 683  
 circular, 674–676, 709–711  
 concrete, 672, 712–714  
 double L, 662  
 L-shaped, 662, 663  
 ladders, 720, 721  
 oval, 675  
 scissor, 713  
 spiral, 674–676, 709–711  
 steel, 678–683, 722  
 straight run, 662  
 U-shaped, 663, 717  
 width, 661–663, 685  
 wood, details of, 665–671, 673
- Stairway layouts (*see* Stairs)
- Standards and brackets, 422
- STC (sound transmission classifications), 494–498  
 floor construction, 548–550
- Steel stairs, 670, 671  
 details of, 670, 671
- Storage:  
 closet, 826, 834, 835  
 coatroom, 461–463  
 electronic media, 294, 295  
 overhead file, 827, 828  
 registration desks, 381–384  
 residential, 206–220
- Storage cabinets, 290  
 dimensions of, 816  
 glossary of, 292, 293  
 wardrobe, 817
- Storage components, 292, 293
- Storage shelves, 834
- Storage walls, 816
- Stores:  
 department, 401–422  
 shops, 387–395
- Straight run stairs, 662
- Stringers, steel, 666, 667, 671, 678, 680–686,  
 692–694, 703–708
- Strip flooring, 1127  
 estimating of wood, 1127
- Study, 190–194
- Suspended ceiling types, 641–659  
 concealed spline, 647  
 miscellaneous details, 653–655  
 perimeters and drops, 656
- Suspension system types, 641–643
- Swags, 1029–1031, 1038–1040, 1042
- Symbols:  
 commercial, 941, 942  
 medical, 940  
 recreation/sports, 445  
 travel, 943, 944  
 universal, 946
- Tables, 44, 50, 60  
 banquet, 252  
 boardroom, 847, 848  
 conference, 283, 284  
 design criteria for restaurants, 312  
 dining room, 80–86  
 restaurant, 307–316
- Table arrangements, restaurants, 307–311
- Table lamps, 744
- Table sizes:  
 billiards, 197  
 conference room, 249–255, 283, 284  
 ping pong, 197  
 pool, 197  
 spacing in
- Tack sizes, 1136
- Task lights, wall-mounted, 748
- Telephone stations, 277, 1079
- Telephone:  
 clearances, 1079, 1118  
 mounting heights, 1079
- Television viewing areas, 49
- Teller's counters, 855
- Tennis court, 1070, 1072
- Terrazzo, 536–540  
 base, 538  
 flooring, 536, 537, 540  
 stairs, 539
- Theater seating, 961–976
- Thresholds, 522–528
- Tiebacks, 1045, 1046
- Tile walls, 132–134, 505–507
- Toilet accessories, 143–148, 317, 380, 449–459
- Toilet partitions, 447, 448
- Toilet stalls:  
 accessible, 449  
 grab bars, 143–148, 449, 452, 458, 459
- Trader's wall, 814, 815
- Trading desk details, 246–248
- Treads, 671, 686–688, 708, 713–716  
 barrier-free, 719  
 cement, 713, 714, 722  
 concrete, 683, 686–688  
 marble, 687, 715  
 metal, 687  
 slate, 716  
 terrazzo, 708, 714  
 wood, 671, 687

- Trees, indoor, 907
- Trim (*see* Mouldings)
- Turnstiles, 1097–1099
- Typeface styles, 947, 948
  
- Units of measurement, 1139, 1140
  
- Valance and cove lighting, 749
- Vanities, 125–127, 129–131
  - countertop details, 125–127, 130, 131
- Veneer:
  - marble, 508, 509
  - slate, 511
- Vertical blinds, 1059
- Vertical circulation (*see* Elevators)
- Vinyl cove base, 532, 551
- Volleyball court, 1073
  
- Wainscot:
  - flat paneled, 798–800
  - marble, 508–510
  - slate, 511
  - wood, 500–502, 805
- Waiter station, 328
- Wall areas of rooms, 1124, 1125
- Wall beds, 47
  - wall board partitions, 481–496
- Wall finishes, 500–511
  - ceramic tile, 505–507
  - marble, 508–510
  - paneling, 500–504
  - slate, 511
  - wood, 500–504
- Wall-mounted task lights, 748
- Wall paneling:
  - stile and rail, 503
  - wallpaper area conversion, 1123
- Wall protection guards, 1087, 1088
- Wall types (*see* Partitions)
- Wall unit details, private offices, 236–239
- Wallpaper covering, 1123–1125
- Walls:
  - marble, 508–510
  - slate, 511
  - terrazzo, 539
- Washer/dryer arrangements, 200, 201
- Waterbeds, 47
- Waterclosets, 115, 116
  - wheelchair access, 143–148, 317, 380, 444–452
  - grab bars for, 143–148, 458, 459
- Wheelchair:
  - accessible bathrooms, 143–145, 317, 380, 449–452
  - adaptable kitchens, 181–185
  - clearances for, 1114–1118
  - elevators, 1065
  - lifts, 1068
  - restaurants, 317, 330
- Wheelchair (*Cont.*):
  - terminology, 1114
- Whirlpool baths, 113, 135
- Window bars, grilles and gates, 1080–1086
- Window treatments, 1015–1059
  - brackets, 1047
  - curtains, 1027–1041
  - draperies, 1027–1041
  - guidelines, 1058, 1059
  - mounts, 1047
  - shades, 1052–1054
  - shutters, 1055, 1056
- Window types, 1015–1026
  - austral, 1020
  - awning, 1016, 1018
  - bottom hinged, 1017
  - casement, 1015, 1024, 1025
  - casement hopper, 1017
  - custom shapes, 1021
  - double hung, 1015, 1016, 1019, 1022, 1024, 1025
  - dual vent, 1019
  - gliding, 1019
  - Gothic, 1021
  - hopper, 1017, 1018
  - jalousie, 1018
  - metal, 1018, 1020
  - oval, 1021
  - pivot, 1019, 1020
  - projected, 1018
  - reversible, 1020
  - round top, 1021
  - side hinged, 1017
  - sliding, 1019
  - special, 1020
  - stationary, 1023
  - top hinged, 1018
  - two-light, 1022
  - wood, 1017–1026
- Windows, 1015–1026
  - pass-through, 275, 276
  - reception, 273–276, 512
  - security of, 978, 986–988
- Windows and hardware, 1015–1026
- Wire shelving systems, 216–220
- Women's toilets, 430, 434–437
- Wood:
  - board feet of, 1127
  - door frames, 608, 609
  - floor construction, 542–550
  - flooring types, 544–547
  - joinery details, 781–787
  - paneling, 661, 804, 805, 860
  - parquet, 544–546
  - railing and gate, 852
  - railings, 665–671
  - stairs, 665–671, 673
  - strip flooring, 543
  - windows, 802, 803
- Woodwork details, 804–865
  - altars, 840
  - bar sinks, 818
  - bars, 346, 347, 358–362, 364–366, 368–373, 864
  - base cabinets, 837
  - benches, 849
  - book and prayer shawl cabinets, 832, 833
  - bookcases, 808–812
  - cabinet doors, 797
  - casework, 788–794
  - clothes storage, 835
  - coat closet, 835
  - corner cupboards, 806, 807
  - cornices, 856–861
  - counters, teller's, 855
  - counters, work, 824–826, 836, 855
  - display cases, 819–823, 829, 862, 863
  - door finishes, 865
  - drawers, 791
  - file countertop, 836
  - finishes, 865
  - hidden door, 853
  - lecterns, 843–846
  - lobby display, 829
  - overfile cabinets, 827, 828
  - moulding, 856–861
  - paneling, 804, 805, 860, 861
  - pantry cabinet, 839
  - pass-through vision panel, 275, 276
  - pews, 841
  - planter/storage cabinets, 831
  - raised panel door, 794, 799, 801, 854
  - sanctuary door, 842
  - sash, 801
  - screen, 850
  - storage shelves, 834
  - storage walls, 816
  - tables, conference, 847, 848
  - teller's counters, 855
  - trader's wall, 814, 815
  - wardrobes, 817
  - window seat, 851
  - windows, 802, 803
  - wood paneling, 804, 805
  - wood railing and gate, 852
  - wood stairs, 665–671, 673
  - work counters, 824–826
- Workstation types, 223–232
  - basic, 223–226
  - electronic, 241–248
    - anthropometrics of, 241, 242
  - executive, 231, 232
  - general, 223–230
  - multiple, 227–229
  - receptionist, 260
  - trading desks, 246, 247
  - trading tables, 248
  - wood stud partitions, 472, 473, 494, 498

### About the Editors

JOSEPH DE CHIARA is a practicing architect and city planner in New York City. He has taught at Columbia University, Pratt Institute, Cooper Union, the New York Institute of Technology, and the State University of New York at Farmingdale. He is coauthor of *Time-Saver Standards for Site Planning* and the author of *Handbook of Architectural Details for Commercial Buildings* and *Time-Saver Standards for Building Types*, all published by McGraw-Hill. De Chiara received a Bachelor of Architecture degree from Pratt Institute and a Master's degree in Urban Planning from Columbia University.

JULIUS PANERO, AIA, ASID, is a practicing architect, interior designer, and Professor of Interior Design at the Fashion Institute of Technology in New York City. He has taught interior design for the past 32 years and was a former chairperson of the interior design department at FIT. A graduate of Pratt Institute, where he received a Bachelor of Architecture, and Columbia University, where he received a Master of Science in Urban Planning, Panero is a member of the American Institute of Architects and the American Society of Interior Designers.

Licensed to practice architecture in New York, Panero is a principal in the architectural and consulting firm of Panero Zelnik Associates, Architects/Interior Designers. He is coauthor of *Human Dimension & Interior Space*, a sourcebook of design reference standards. In 1986, he was awarded the prestigious ASID Joel Polsky Prize for this book. He is also the author of *Anatomy for Interior Designers* and a contributing author to the *Time-Saver Standards* series.

MARTIN ZELNIK, AIA, ASID, IDEC, is a practicing architect, interior designer, and Professor of Interior Design at the Fashion Institute of Technology in New York City, where he has taught interior design for the past 23 years. He served as chairperson of the interior design department from 1983 to 1986. He is a graduate of Brandeis University, where he received a Bachelor of Fine Arts degree, and

Columbia University, where he earned a Master of Architecture degree. Zelnik is a member of the Interior Design Educators Council, the American Society of Interior Designers, and the American Institute of Architects; has served as a special consultant to the National Council of Interior Design Qualifications; and holds certification with the National Council of Architectural Registration Boards.

He has been a principal in the New York City-based architectural and consulting firm of Panero Zelnik Associates, Architects/Interior Designers, for over 18 years. The firm specializes in institutional, religious, and transportation facilities, and corporate interiors. Zelnik is coauthor of *Human Dimension & Interior Space*, a sourcebook of design reference standards. In 1986, he was awarded the prestigious ASID Joel Polsky Prize for this book.



Architecture

# TIME-SAVER STANDARDS FOR INTERIOR DESIGN AND SPACE PLANNING

JOSEPH De CHIARA JULIUS PANERO MARTIN ZELNIK

**A comprehensive one-volume graphics and text reference  
on interior design and space planning**

Interior designers, architects, and other design professionals can now locate, in a comprehensive single-source reference, a wealth of information related to the design and planning of residential and commercial interiors.

From standard furniture dimensions to architectural woodwork details, this important volume in McGraw-Hill's acclaimed *Time-Saver Standards* series provides a vast array of time-saving data and details for designers and draftspersons. Featuring contributions from well-known architectural and interior design firms, this authoritative reference includes details derived from actual designs and working drawings showing various solutions for typical design problems encountered in interior architecture. It includes a wide range of typical layouts of residential spaces, offices, conference rooms, and reception areas, in addition to details of bars, restaurants, and public toilets. Two outstanding sections cover historic styles and woodworking. Architects and designers across a broad spectrum of experience and interest will find this book to be one of their most treasured references.

Cover Design: Ron Lane

ISBN 0-07-016299-9



McGraw-Hill, Inc.  
Serving the Need for Knowledge  
1221 Avenue of the Americas  
New York, NY 10020